

ROYAL AIR FORCE  
BEDFORD



MINISTRY OF AVIATION

AERONAUTICAL RESEARCH COUNCIL

CURRENT PAPERS

# Some Examples of the Use of a Conical Shadowgraph Technique

*by*

D. Pierce and D. Treadgold

LONDON: HER MAJESTY'S STATIONERY OFFICE

1964

PRICE 3s 6d NET



U.D.C. No. 533.6.071.3 : 533.693.3 : 533.6.011.5

C.P. No. 763

March 1964

SOME EXAMPLES OF THE USE OF A CONICAL  
SHADOWGRAPH TECHNIQUE

by

D. Pierce  
and  
D. Treadgold

---

SUMMARY

A conical shadowgraph technique has been applied to study the flow in the vicinity of the leading edges of slender wings at supersonic speeds. In addition an investigation was made of the shock wave shape occurring on a triangular expansion surface with near-sonic leading edges.

---

CONTENTS

	<u>Page</u>
1 INTRODUCTION	3
2 DETAILS OF THE OPTICAL SYSTEM EMPLOYED	3
3 DISCUSSION OF SOME EXPERIMENTAL RESULTS OBTAINED	4
3.1 Study of the flow over a conical plane expansion surface	4
3.2 Flow in the vicinity of the leading edge of a thin delta wing	5
3.3 Study of the flow field of a rhombic cone	5
4 FURTHER DEVELOPMENT	6
5 CONCLUSIONS	6
REFERENCES	6
ILLUSTRATIONS - Figs.1-7	-
DETACHABLE ABSTRACT CARDS	-

ILLUSTRATIONS

	<u>Fig.</u>
Conical shadowgraph system	1
Typical example of shadowgraph images	2
Model and arrangement for tests of flow over an expansion surface	3
Results from an expansion surface at $M = 1.50$	4
Subsonic leading edges, $\frac{\beta_s}{\ell} = 0.70$	5
Supersonic leading edges with attached shock wave, $\frac{\beta_s}{\ell} = 1.7$	6
Results from a rhombic cone	7

## 1 INTRODUCTION

Supersonic spatial flows which are conical, in the sense first introduced by Busemann<sup>1</sup>, have attracted the interest of many theoreticians in their quest for exact solutions of the inviscid equations of motion. In such flows the velocity and the properties of state, pressure, temperature and density, are constant along rays through one singular point. Taylor and Maccoll<sup>2</sup> produced the well known exact solution for the flow about a circular cone at zero incidence. However, attempts to solve more general problems have not been so successful.

In particular the flow over the expansion surface of a plane delta wing with supersonic leading edges has been studied by Maslen<sup>3</sup>, Fowell<sup>4</sup>, Reyn<sup>5</sup>, Bulakh<sup>6,7</sup>, and more recently by Babaev<sup>8</sup>. In this problem doubts arise about the existence of a continuous solution, but no calculations have yet been made of the form of shock wave that it may be necessary to introduce into the mathematical model of the flow field.

There is a limited amount of experimental<sup>4,9</sup> evidence to indicate the presence of a shock wave in flow fields related to this example. However, there is a need for more direct experimental observations. The conical shadowgraph, as first introduced by Love<sup>10</sup>, offers an attractive technique for observing conical shock systems.

This Note presents results obtained by use of an adaptation of Love's technique to the examination of flow fields about conical bodies where shock waves are present. The technique has also been applied to the detailed examination of the flow in the vicinity of the separation occurring at the leading edge of a rhombic cone at incidence. Surface oil flow studies were also made to assist in the interpretation of the shadowgraph photographs.

The experiments were made in the R.A.E. No.8 (9 in. x 9 in.) supersonic wind tunnel during the latter part of 1962.

## 2 DETAILS OF THE OPTICAL SYSTEM EMPLOYED

Love<sup>9</sup> first demonstrated experimentally that the conventional shadowgraph system, which uses a parallel light beam, could be adapted to examine conical flow fields if a conical light beam was used. This conical light beam must have its source or focal point at the singular point of the conical flow. In his experiments on full span models this light beam was provided by a small bulb at the apex of the model. However, in our present experiments the disturbance produced by such an installation could not be tolerated. Fortunately the windows of the No.8 (9 in. x 9 in.) supersonic tunnel extend upstream of the working section for a considerable distance; it was therefore possible to project a light into the tunnel from outside.

This light was provided by a 90 watt compact source mercury vapour lamp (Philips Electrical Ltd type CS90W). A lens was used to form an image of the arc on a pin hole 1/16 in. diameter. A further lens was used to focus an image of the pin hole at the apex of the model producing a conical beam of about 6° solid angle. The divergent conical beam beyond this focal point was reflected

by a plane mirror within the tunnel onto a viewing screen or photographic plate placed just outside the tunnel window. The mirror was back silvered since abrasion due to dust particles in the tunnel airstream prohibited the use of the otherwise more desirable front silvered type. The mirror was mounted on the traverse gear fitted to the tunnel so that its position and inclination could be adjusted. The direction and position of the conical light beam could also be varied so that it was possible to cover a considerable area of the flow field. A sketch showing the arrangement of the system is given in Fig.1.

By analogy with the conventional shadowgraph system it is readily apparent that changes in intensity of illumination will be produced by variations in density of the air in the light path. These changes will be proportional to both the length of path traversed and the second derivative of the density in a direction normal to the divergent light rays. A conical shock, with its origin at the focal point of the light beam, is a region having high curvature in the density field normal to the light rays and is therefore readily visible on the viewing screen. It appears as a dark band followed by a light one.

Conical vortex sheets or shear layers, are similarly made visible by this method since, in general, they correspond to regions of high curvature in the density field. The image on the screen may take many forms since the density changes across such layers are quite complex, arising, as they often do, from the confluence of two boundary layers of quite different energy levels.

In order to assist in the interpretation of the shadowgraph photographs, Fig.2 has been included. This gives typical examples of density variations encountered and the images they produce on the shadowgraph.

In the experimental set up care had to be exercised to eliminate spurious images produced by trailing edge shock systems and the model wake. These images could readily be suppressed by suitably inclining the mirror so that the light rays did not coincide with these regions of high curvature in density for any considerable distance.

### 3 DISCUSSION OF SOME EXPERIMENTAL RESULTS OBTAINED

#### 3.1 Study of the flow over a conical plane expansion surface

A small scale version of the model used in Ref.9 was used for this investigation. Fig.3 gives a sketch of the model and the arrangement of the conical light beam used, the beam being focussed almost\* at the apex of the rear facing triangular surface.

At a free stream Mach number of 1.51 and with the model at zero incidence i.e. with surfaces  $s_1$  and  $s_2$  streamwise, the ridges formed by the junction of these surfaces with deflected surface  $s_3$  are at the Mach angle to the free stream.

A surface oil flow pattern obtained under these conditions is shown in Fig.4. The oil flow clearly indicates a line along which the flow separates;

---

\*The oil flow pattern shows the separation line to be curved and it was found necessary to focus the light beam slightly ahead and to one side of the apex of the triangular surface to obtain a more clearly defined picture.

and a study was made with the conical shadowgraph of the flow field in this vicinity. A mosaic of the photographs obtained is included in Fig.4. A shock wave is clearly seen which appears to be bifurcated a little way above the surface. The absence of detail in the flow near the surface is probably a consequence of the curvature of the separation line. However, the photographs obtained appear to conform the assumed flow model given in Fig.4 which has been reproduced from Ref.9.

### 3.2 Flow in the vicinity of the leading edge of a thin delta wing

Figs.5 and 6 give examples of the oil flow and shadowgraph photographs obtained for thin delta wings at incidence.

Fig.5 is an example obtained using a model with a subsonic component of Mach number normal to the leading edge and an incidence of  $8^\circ$ . The free stream Mach number was 1.5 and the wing slenderness ratio, i.e.

$\frac{\text{tangent of wing semi-apex angle}}{\text{tangent of Mach angle}} \left( \frac{\beta_s}{\ell} \right)$  was 0.70. The shear layer bounding the

leading edge separation is clearly seen in the shadowgraph picture. The definition deteriorates as the distance from the leading edge decreases, and no clear indication of the reattachment point is visible. The loss in definition is probably a result of instability of the initially laminar shear layer which has degenerated into a thicker turbulent mixing layer.

Fig.6 gives an example of the flow over the upper wing surface, where the component of Mach number normal to the leading edge is supersonic. The free stream Mach number in this case was 2.47 and the incidence was  $3^\circ$ . The shock wave angle on the lower surface appeared to agree well with that calculated from simple sweepback theory. On the upper surface, however, which should be approximately streamwise, a relatively strong curved shock wave was visible. The oil flow indicated that flow separation occurred on the upper surface, but it was too far inboard to be within the range of the conical light beam.

### 3.3 Study of the flow field of a rhombic cone

Fig.7 gives the results of the study of a rhombic cone at a Mach number of 2.47 and an incidence of  $14^\circ$ . The model was derived from a series tested by Squire<sup>11</sup>. At this Mach number the flow is conically subsonic at the leading edge and the bow wave from the model apex was therefore detached<sup>2</sup>.

Fig.7 shows a section of the model on which has been superposed conical shadowgraphs. Also shown is a photograph of the surface oil flow pattern. The conical shadowgraphs show in detail the complex flow structure occurring on the upper surface. A leading edge separation occurs and the vortex sheet is seen to remain close to the surface. The free edge of the sheet appears, from the oil flow, to be near the half span station. A secondary separation is clearly seen in the shadowgraph. Two shock waves are also visible in the photograph. Included in Fig.7 is a sketch giving a possible interpretation of the flow, this being derived from the combined information provided by the shadowgraph and the oil flow.

---

<sup>2</sup>The detached shock wave could be observed using the present conical shadowgraph technique, but it is not certain in the field of view covered by the photograph in Fig.7.

#### 4 FURTHER DEVELOPMENT

In many wind tunnels the position and size of the observation windows may be such that the light beam cannot be directed on to the model, while in others the coverage of the wing surface may be restricted. To eliminate this difficulty, a few experiments have been made using a spark light source, the spark being made between two electrodes embedded on the surface of a model as near to the apex as possible. The main problem with this light source appears to be that when the spark fires in the low density air above the surface of the wing a volume of luminous gas is formed and this is larger than desirable for the very small models used in the experiments. It is considered, however, that the method shows sufficient promise to warrant further experiments with larger models, especially in cases where it is not possible to direct a light beam on to the model in the way described in this paper.

#### 5 CONCLUSIONS

The conical shadowgraph, supplemented by oil flow studies, provides a valuable tool in the detailed investigation of flow fields at supersonic speeds.

The method has been applied to the study of flows over expansion surfaces where theory leads us to suspect the existence of shock waves. In the example investigated the form of the shock wave present was clearly visible on the shadowgraph.

The flow in the vicinity of the leading edge of a slender wing was examined, and with the present technique the complex structure of shock waves and the form of secondary separations could readily be seen.

---

#### REFERENCES

<u>No.</u>	<u>Author</u>	<u>Title, etc</u>
1	Busemann, A.	Drücke auf kegelförmige Spitzen bei Bewegung mit Überschallgeschwindigkeit, z. angew. Math. Mech. 9, 496-498, 1929.
2	Taylor, G.I. Maccoll, J.W.	The air pressure on a cone moving at high speeds. Proc. Roy. Soc., A, 139, 278, 1933.
3	Maslen, S.H.	Supersonic conical flow. NACA T.N. 2651. March 1952.
4	Fowell, L.R.	An exact theory of flow around a delta wing. UTIA Rep. No. 30. March 1955.
5	Reyn, J.W.	Differential-geometric considerations on the hodograph transformation for irrotational conical flow. Third International Congress in the Aeronautical Sciences, Stockholm, Sweden, August 1962.



REFERENCES (CONTD)

<u>No.</u>	<u>Author</u>	<u>Title etc</u>
6	Bulakh, B.M.	Some questions concerning the theory of conical flow. P.M.M. Vol.25, No.2, 229-241. Translated by Pergamon Press, 1961.
7	Bulakh, B.M.	Remarks on the paper by L.R. Fowell "Exact and approximate solutions for the supersonic delta wing". P.M.M. Vol.22 No.3, 404-407, 1958.
8	Babaev, D.A.	Numerical solution of the problem of supersonic flow past the upper surface of a delta wing. Zhur Vychislitel noi Matematiki i Matematicheskoi Fiziki. (J. Computational Math and Mathemat. Phys.) 2, No.2, 278-289, 1962.
9	Treadgold, D.A.	Experimental study of the flow over a particular after-body shape having a near sonic ridge line. ARC C.P. 546. October 1960.
10	Love, E.S. Grigsby, C.E.	A new shadowgraph technique for observation of conical flow phenomena in supersonic flow and preliminary results obtained for a triangular wing. NACA TN 2950, May 1953.
11	Squire, L.C.	Pressure distributions and flow patterns on some conical shapes with sharp edges and symmetrical cross-sections at $M = 4.0$ . ARC R & M 3340. June 1962.



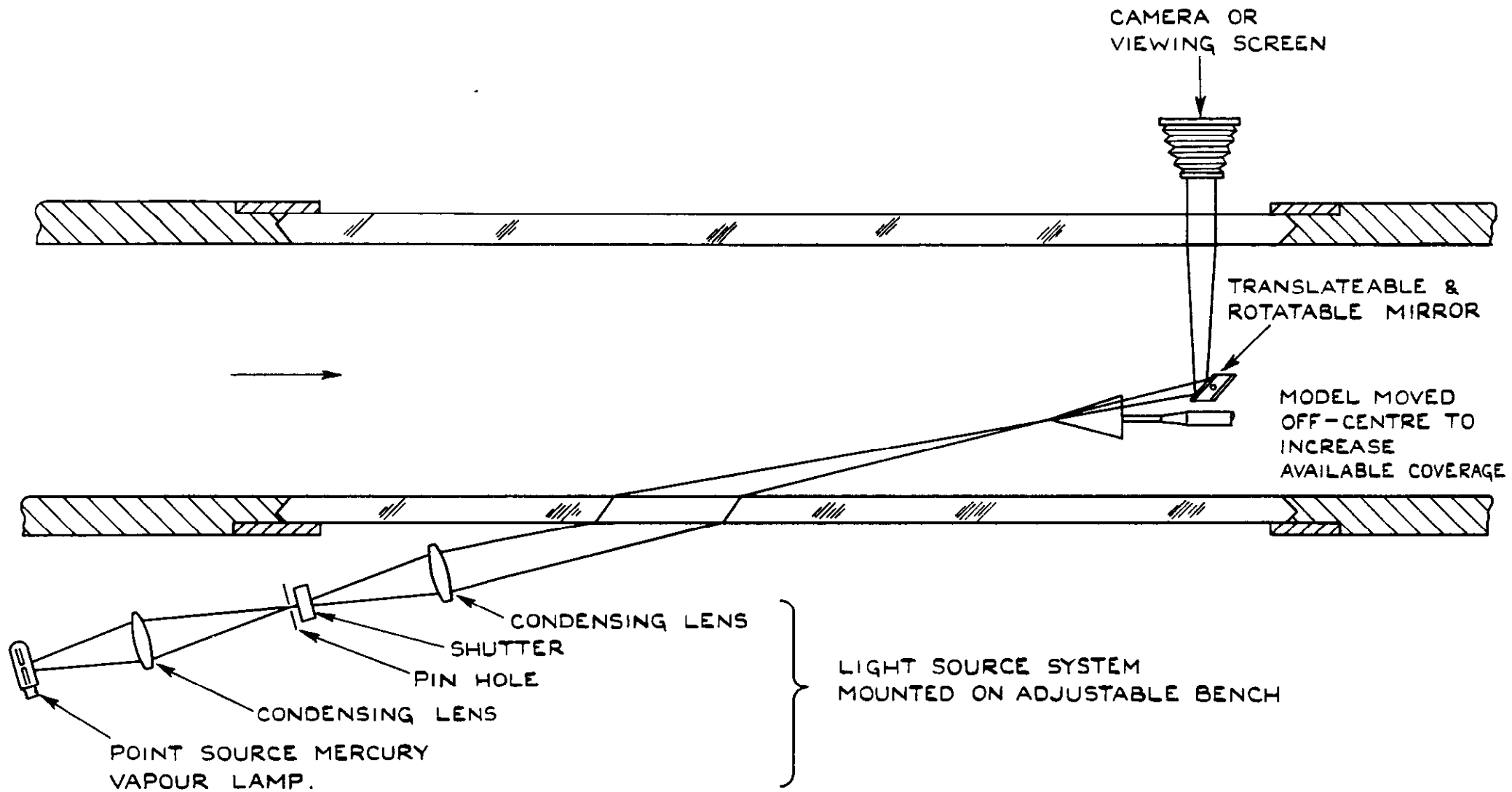

FIG. 1. CONICAL SHADOWGRAPH SYSTEM.

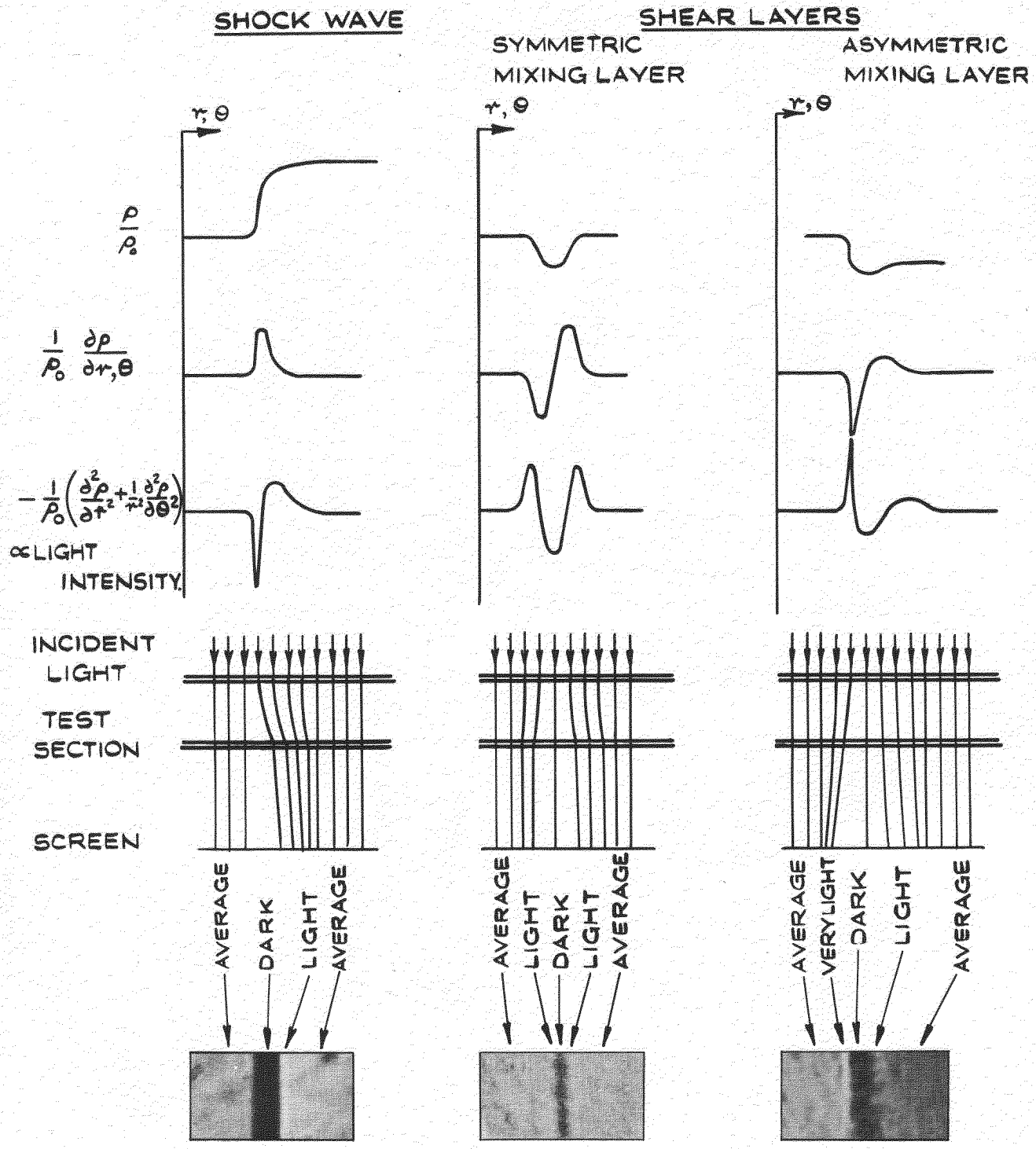
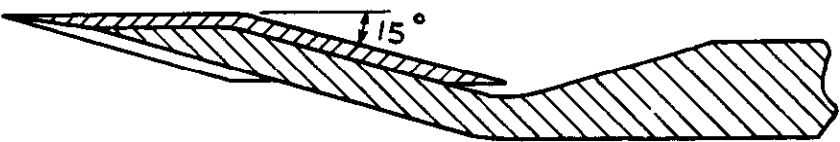
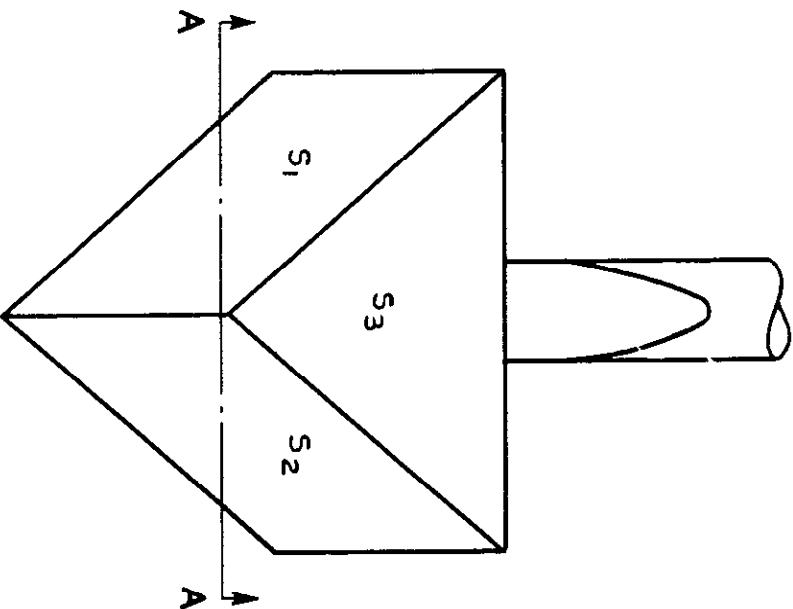
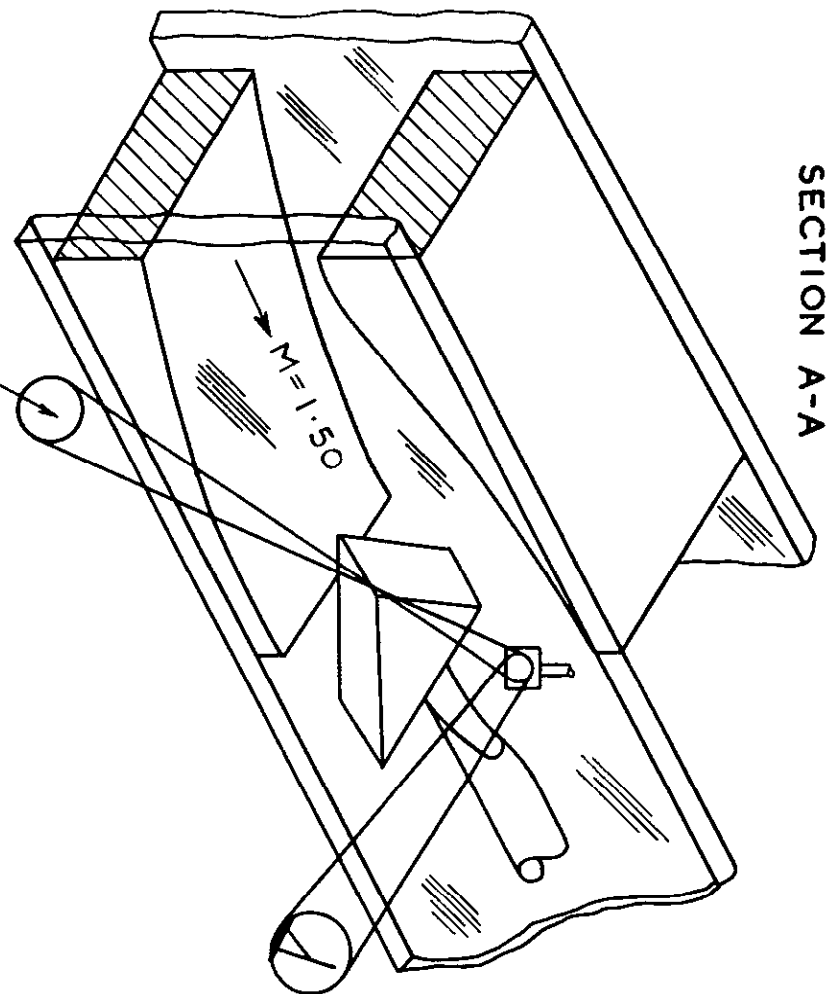

FIG.2. TYPICAL EXAMPLE OF SHADOWGRAPH IMAGES

FIG. 3 MODEL & ARRANGEMENT FOR TESTS OF FLOW  
OVER AN EXPANSION SURFACE.



SECTION THROUGH  $\phi$

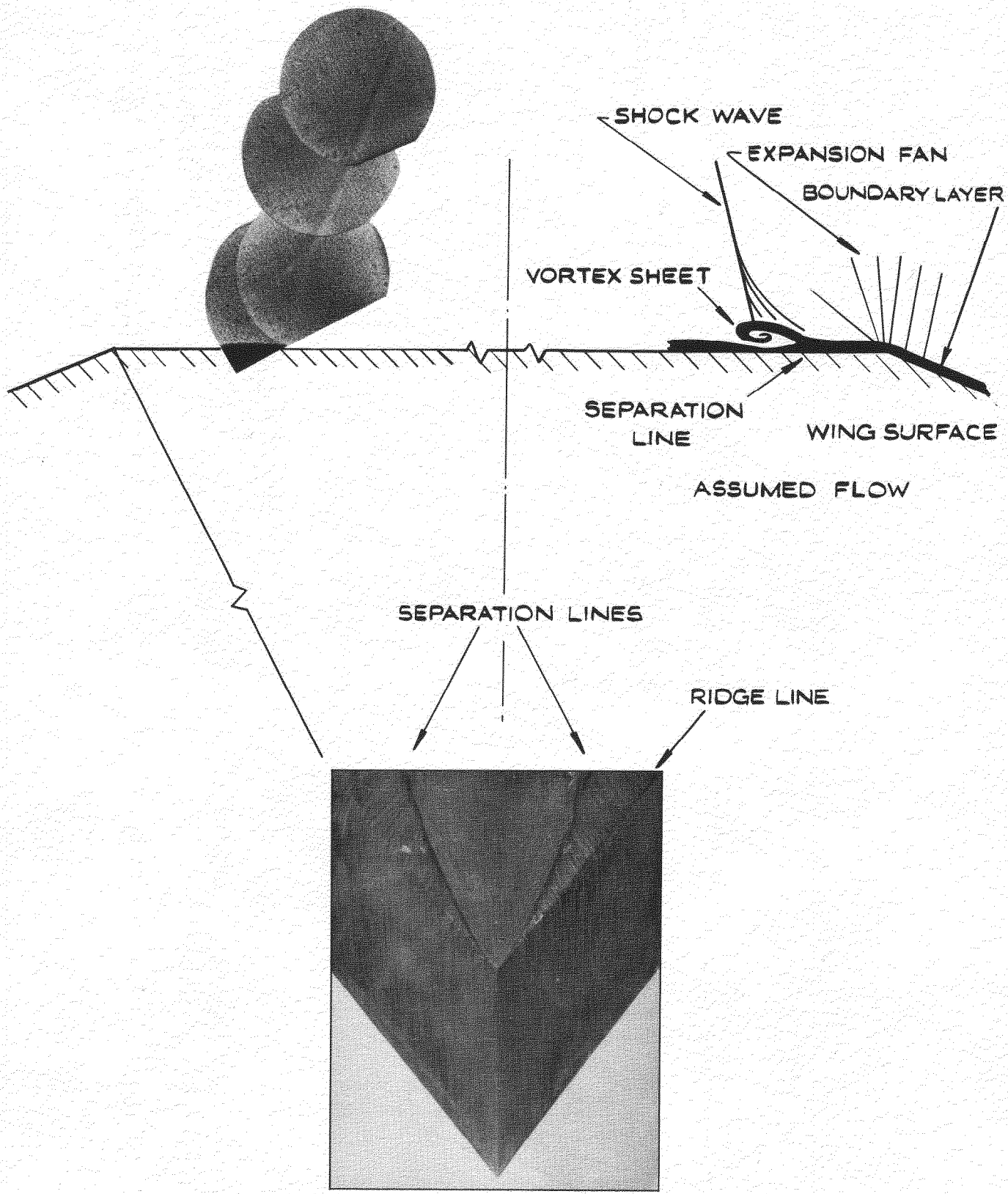
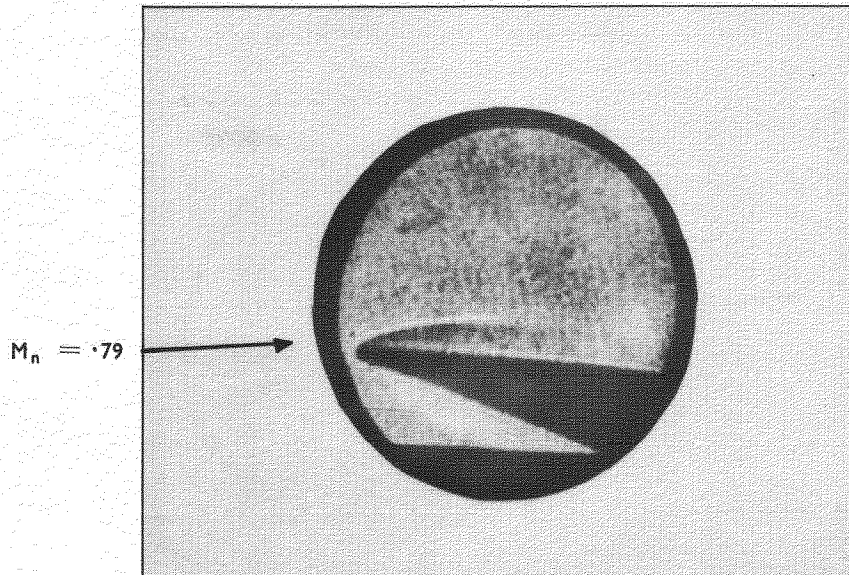
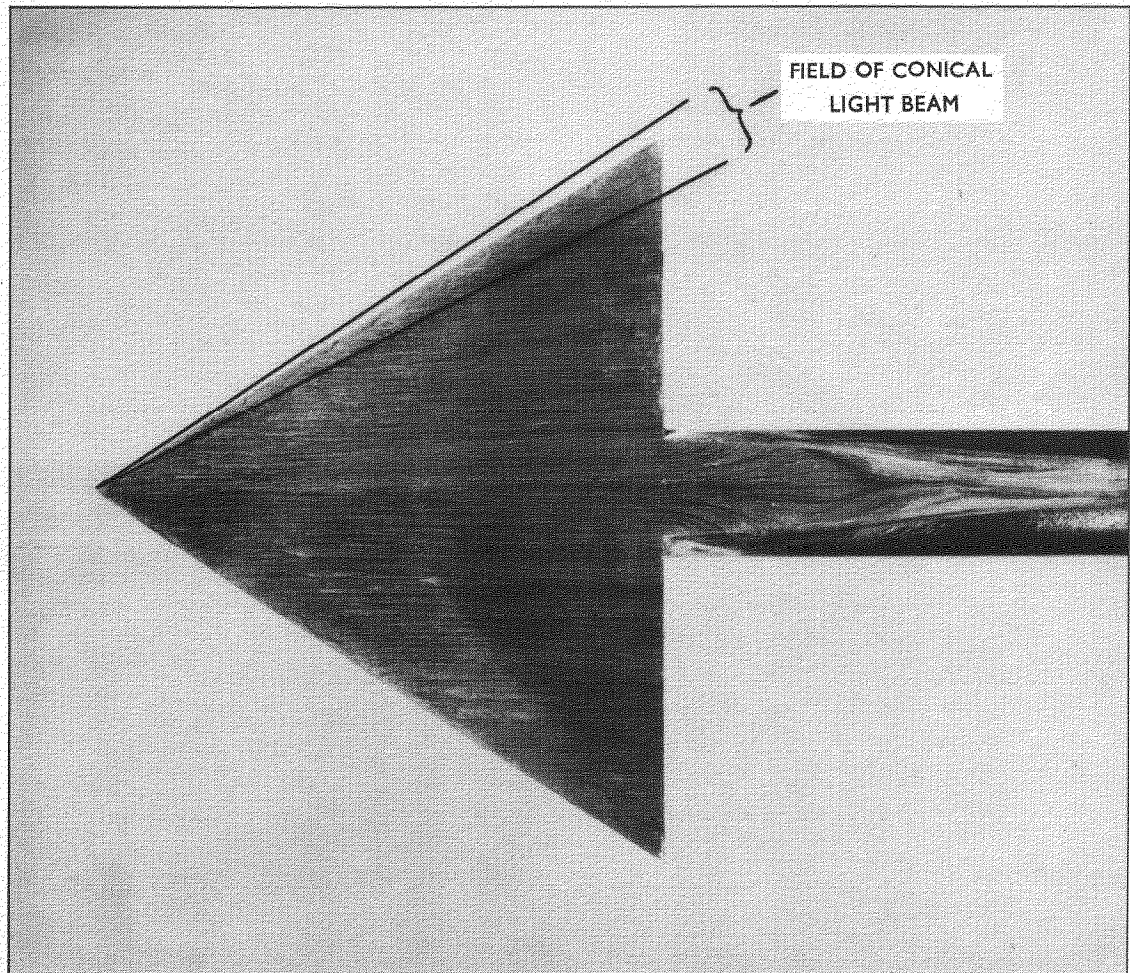

FIG.4. RESULTS FROM AN EXPANSION SURFACE AT  $M = 1.50$



a. CONICAL SHADOWGRAPH SHOWING L/E SEPARATION



b. OIL FLOW PATTERN ON THE EXPANSION SURFACE

FIG.5. SUBSONIC LEADING EDGES,  $\frac{\beta \Delta}{\ell} = 0.70$

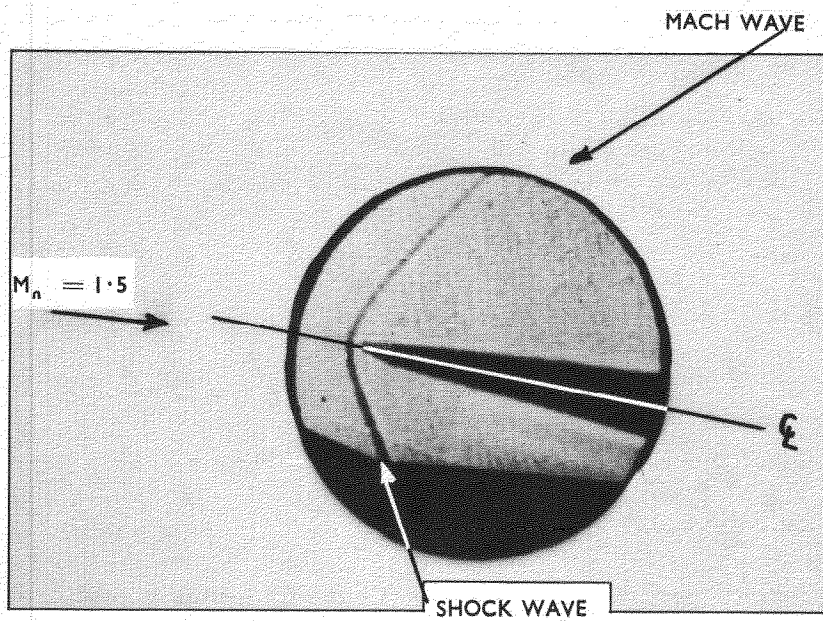

a. ATTACHED SHOCK WAVE

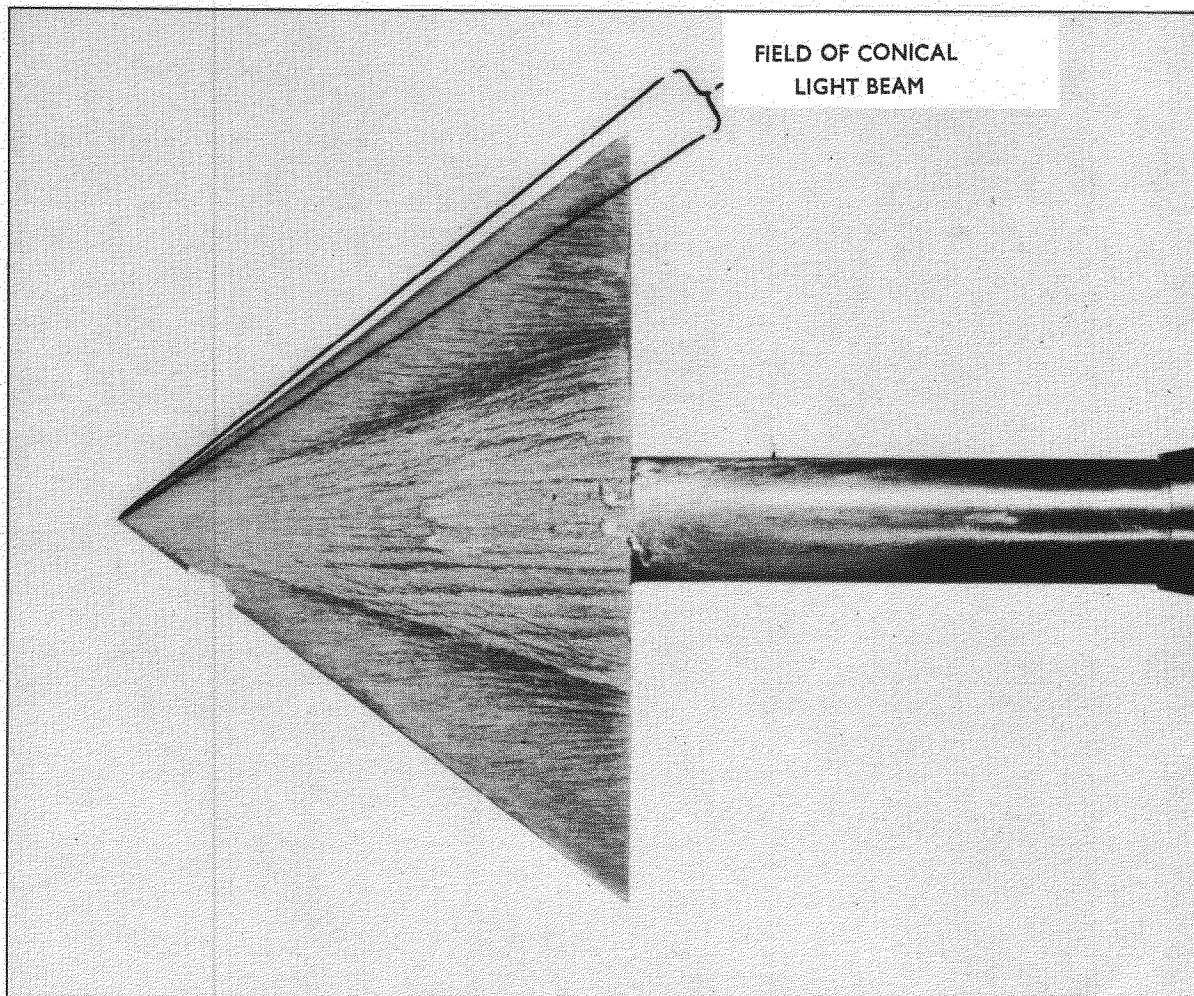

b. FLOW PATTERN

FIG.6. SUPERSONIC LEADING EDGES WITH ATTACHED SHOCKWAVE,  $\frac{R_0}{c} = 1.7$



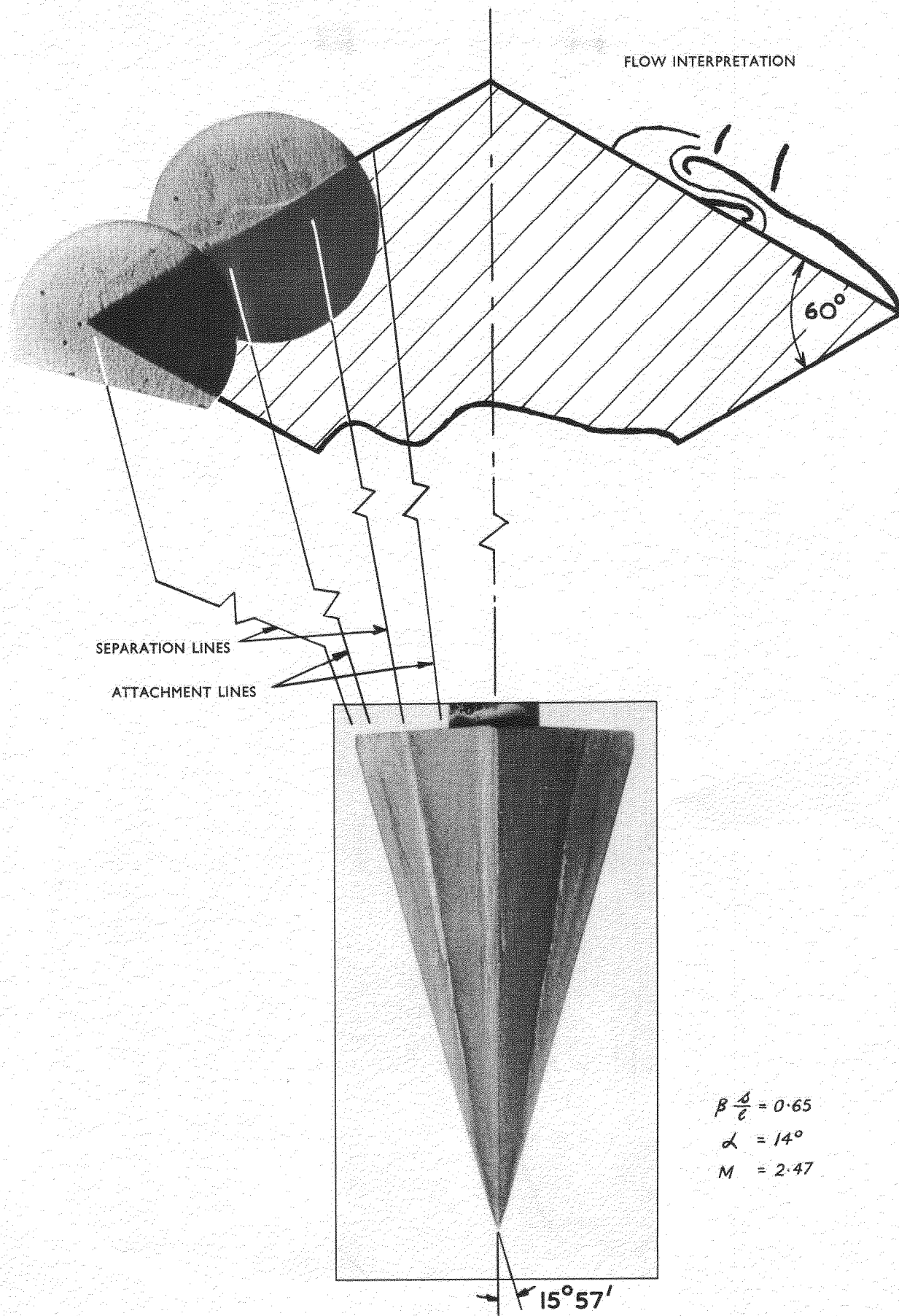

FIG.7. RESULTS FROM A RHOMBIC CONE



A.R.C. C.P. No. 763

533.6.071.3:  
533.693.3:  
533.6.011.5

SOME EXAMPLES OF THE USE OF A CONICAL SHADOWGRAPH TECHNIQUE.  
Pierce, D. and Treadgold, D. March 1964.

A conical shadowgraph technique has been applied to study the flow in the vicinity of the leading edges of slender wings at supersonic speeds. In addition an investigation was made of the shock wave shape occurring on a triangular expansion surface with near-sonic leading edges.

A.R.C. C.P. No. 763

533.6.071.3:  
533.693.3:  
533.6.011.5

SOME EXAMPLES OF THE USE OF A CONICAL SHADOWGRAPH TECHNIQUE.  
Pierce, D. and Treadgold, D. March 1964.

A conical shadowgraph technique has been applied to study the flow in the vicinity of the leading edges of slender wings at supersonic speeds. In addition an investigation was made of the shock wave shape occurring on a triangular expansion surface with near-sonic leading edges.

A.R.C. C.P. No. 763

533.6.071.3:  
533.693.3:  
533.6.011.5

SOME EXAMPLES OF THE USE OF A CONICAL SHADOWGRAPH TECHNIQUE.  
Pierce, D. and Treadgold, D. March 1964.

A conical shadowgraph technique has been applied to study the flow in the vicinity of the leading edges of slender wings at supersonic speeds. In addition an investigation was made of the shock wave shape occurring on a triangular expansion surface with near-sonic leading edges.





C.P. No. 763

© *Crown Copyright 1964*

Published by  
**HER MAJESTY'S STATIONERY OFFICE**

To be purchased from  
York House, Kingsway, London w c 2  
423 Oxford Street, London w.1  
13A Castle Street, Edinburgh 2  
109 St Mary Street, Cardiff  
39 King Street, Manchester 2  
50 Fairfax Street, Bristol 1  
35 Smallbrook, Ringway, Birmingham 5  
80 Chichester Street, Belfast 1  
or through any bookseller

C.P. No. 763

S.O. CODE No. 23-9015-63