



MINISTRY OF SUPPLY

AERONAUTICAL RESEARCH COUNCIL
REPORTS AND MEMORANDA

An Air-injection Method of fixing Transition from Laminar to Turbulent Flow in a Boundary Layer

By

A. FAGE, F.R.S., AND R. F. SARGENT,
of the Aerodynamics Division, N.P.L.

Crown Copyright Reserved

LONDON: HIS MAJESTY'S STATIONERY OFFICE

Price 2s. od. net

An Air-injection Method of fixing Transition from Laminar to Turbulent Flow in a Boundary Layer

By

A. FAGE, F.R.S., AND R. F. SARGENT,
of the Aerodynamics Division, N.P.L.

Reports and Memoranda No. 2106

June, 1944

Summary.—The paper deals with a simple method of fixing transition by the injection of small air jets into a boundary layer from a row of surface holes, and describes experiments which establish the effectiveness of the method. A merit of the method is that the rate of air injection can be adjusted to give, at each speed of test, a minimum disturbance of flow necessary to fix transition at the position selected. The minimum rate of air injection for transition is small, about 0.015 times the rate of mass-flow in the boundary layer. The method is especially suitable for high-speed tests since it does not give a local shock wave, which is sometimes present when a surface wire is used to fix transition. The experiments show that a large increase in drag may be caused by a very small leakage of air into the laminar boundary layer of a low-drag wing.

1. *Introduction.*—A standard method of fixing the position of transition from laminar to turbulent flow in the boundary layer of an aerofoil is either by a fine spanwise wire or by a roughness caused by a narrow band of fine particles on the surface. The criterion that transition occurs close behind a wire is $u_h h / \nu \approx 400$, where h is the diameter of the wire and u_h is the velocity in the boundary layer, without the wire, at a distance h from the surface^{1, 2}.

When the velocity increases linearly with the distance from the surface $u_h = h U_\tau^2 / \nu$, where U_τ is the frictional velocity $\sqrt{(\tau_0 / \rho)}$ and τ_0 is the shearing stress at the surface; an alternative form for the criterion is then $U_\tau h / \nu = 20$. The criterion for the condition that transition is established just behind a narrow rough strip can also be written in the form $U_\tau h / \nu = K$, where h is now the average height of the excrescences forming the roughness and K is a constant for an assigned form of roughness. The value of K can only be determined by direct measurement, but for a roughness of the kind caused by sand or carborundum particles, it will be greater than 5.5, the value for which the roughness just begins to increase the resistance to flow³. Both methods have proved adequate, under suitable conditions, to fix transition at low Mach numbers, for the drag obtained by direct measurement is, in general, in reasonably close agreement with that estimated by the Squire-Young method on the assumption of an abrupt transition.

2. For a laminar boundary layer we have $U_\tau x / \nu \propto (u_1 x / \nu)^{3/4}$, according to the Pohlhausen theory, where x is the distance from the leading edge of the aerofoil and u_1 is the velocity just outside the boundary layer. The transition criterion $U_\tau h / \nu = K$ can therefore be written in the form $h/x \propto (u_1 x / \nu)^{-3/4}$.

If then the wire or the roughness selected is just adequate to cause transition at the lowest speed of test, the value of h , and so the disturbance created at a higher speed, is greater than the optimum. The diameter of the wire or the height of the excrescences should therefore be progressively decreased with an increase in speed to obtain the optimum disturbance needed for transition.

A more serious shortcoming arises if a wire is used to fix transition on a small model at a high speed of test, for even if the optimum diameter is selected, the increase of velocity associated with the boundary-layer separation at the wire may cause a shock wave near the wire, as shown by Pearcey in R. & M. 2252⁴. The critical Mach number is then lower, and the rise in drag coefficient with Mach number beyond the critical occurs earlier, than for the model without a wire. Such shortcomings are obviated by the present method of fixing transition by the injection of minute air jets into the boundary layer from a row of small surface holes. The method has, of course, the shortcoming common to any method of artificially fixing transition, that the flow within the transition region differs from that for a natural transition on a smooth surface, whether caused by a laminar boundary-layer separation due to an adverse velocity gradient or by turbulence in the free stream. The method has however the merit that the rate of air injection can be adjusted to give, at each speed of test, a minimum disturbance of flow necessary to fix transition at the position desired. Further, as will be seen later, the minimum rate of air injection for transition happens to be so small that it does not give a local shock wave at high speeds of test.

It should here be noted that, owing to the local speeding-up of flow, the formation of wavelets just outside a transition region is inevitable at a sufficiently high speed, even when transition occurs naturally.

3. *Tentative Experiments in a Low-speed Tunnel.*—General information on the practicability of the air injection method of fixing transition was first obtained from tentative observations made in a low-speed wind tunnel. The scheme of the experiments was to compare the flow behind the holes, for rates of injection near the optimum value, with that behind a circular rod immersed in the boundary layer at the Reynolds number, $u_r h / \nu \approx 400$, for which transition occurs close behind.

The length of the tunnel was 34 in., (see Fig. 1). The air was injected into the boundary layer on the floor of the tunnel at a distance of 21 in. from the inlet. The thickness, δ , of the boundary layer at this section, hereinafter called the standard section, was 0.41 in., and the velocity just outside, u_1 , was 2.48 ft./sec.

The rod was mounted on the floor at the standard section. The diameter of the rod was 0.35 in. The value of $u_r h / \nu$ was 445. Further details of the tunnel and of the method of experiment are given in the Appendix.

4. Fig. 2 gives velocity measurements taken in the laminar boundary on the floor of the empty tunnel at the standard section and at a section 9 in. beyond, by the hot-wire technique described in R. & M. 2127⁵. The measurements are plotted in the form u/u_1 against y/δ , where u is the velocity at a distance y from the floor. They are closely represented by a single curve. The value of Λ , i.e. $(\delta^2/\nu) (du_1/dx)$, for these velocity profiles is about 1.5. The dotted curve gives the Blasius velocity profile for $\Lambda = 0$.

Observation of the flow behind the 0.35-in. diameter rod, made by the smoke-filament technique developed by Preston and Sweeting⁶, indicated that fully-developed turbulence was established in the boundary layer at a distance 9 in., that is 22δ , behind the rod. This indication was confirmed by a direct hot-wire measurement of the velocity profile. The velocity measurements taken are plotted, as points, in Fig. 3. With the exception of those taken near the surface $y < 0.13\delta$, they lie closely on the curve, shown dotted, representing a turbulent velocity profile $u/u_1 = (y/\delta)^{1/2}$. The value of u_1 measured just outside the boundary layer at the rod position was about 10 per cent. greater than that without the rod in position. The increase in u_1 at a section $5h$ behind the rod was 20 per cent.

5. The observations on the air injection method of fixing transition were made at first for a row of 0.25δ diameter holes, drilled normal to the surface and spaced 1.23δ apart. Smoke filaments indicated that the flow in the boundary layer beyond the jets remained laminar when $m < 0.02m_b$, and that fully-developed turbulence was established at the section 22δ behind the holes when $m \approx 0.04m_b$, where m is the mass of air injected into the boundary layer per unit

span per sec. and m_b is the mass of air flowing in the boundary layer per unit span per second. Velocity measurements taken at this section for $m = 0.04m_b$ are plotted in Fig. 3. Those for $y > 0.13\delta$ are closely represented by the curve $u/u_1 = (y/\delta)^{1/7}$, so that the velocity profile is almost identical with that measured behind the rod.

6. Observations were also made for a row of 0.50δ -diameter holes spaced 1.23δ apart. The flow at the section 22δ behind the holes, as revealed by smoke filaments, tended to be laminar for $m < 0.06m_b$ and to become turbulent for $m \approx 0.085m_b$. Velocity measurements taken for $m = 0.085m_b$, plotted as crosses in Fig. 3, indicate that the flow is turbulent and that the section chosen is not sufficiently far behind the holes for the turbulence to be fully developed.

The experiments for the two sizes of hole show that the optimum value of the fractional air input, m/m_b , needed for transition increases with the diameter of the holes for the same spacing.

7. It was observed that filaments introduced into the stream upstream of the holes and just outside the boundary layer rose slowly after flowing over a jet issuing from a hole, whilst those between the jet positions fell slowly. The air flowing within the layer and between the jets had a double spiral motion after flowing between the jets, the direction of motion in the median plane between two adjacent jets being downwards. Eventually, these spiral motions broke down into fully-developed turbulence.

8. Smoke filaments were used to observe the flow when air from the boundary layer was sucked into the holes. The flow behind the holes remained laminar for all rates of suction up to $0.1m_b$, the highest rate possible with the pump used. A measurement of the velocity profile at the section 22δ behind the holes for a $0.07m_b$ rate of suction confirmed this visual observation that the flow was laminar.

9. *Experiments on aerofoil EC 1250.*—In view of the promising character of the results obtained from the tentative experiments made in the low-speed tunnel it was decided to make a practical test of the air-injection method in the 20 in. \times 8 in. High Speed Tunnel. This test was made on the 12-in. chord brass model of symmetrical aerofoil EC 1250 used for earlier experiments in this tunnel⁴. The model has a far-back transition position, and its construction, with a hollow interior, facilitated the preparation for test. A row of holes, extending over the middle 4 in. of the model span, was drilled into each surface at a distance $0.15c$ from the leading edge. The diameter of the holes was 0.0135 in. and their spacing was 0.075 in. There were 53 holes in each row. The model surface was polished to remove burrs at the edges of the holes. The central chamber within the model was connected through a control valve and a plate orifice to the atmosphere. The pressure within the tunnel was sufficiently far below atmospheric to suck directly into the boundary layer the small amount of air needed to cause transition.

10. Pitot-traverse measurements of the profile drag of the aerofoil at 0 deg. incidence were made, with and without air injection into the boundary layer, for a range of Mach number, M , from 0.575 to 0.784. The model was cleaned before each measurement.

The results obtained are given in Fig. 4, where values of the profile drag coefficient, C_{D0} , are plotted against m/m_b for constant values of M . The method of estimation of the value of m_b is described in the Appendix.

Notable features shown by the curves in Fig. 4 are the steep rising gradient in C_{D0} at very low values of m/m_b and the low value of m/m_b , about 0.015, above which C_{D0} can be taken to be constant. It can be inferred from the curves that transition from laminar to turbulent flow in the boundary layer is fully established near the holes at $m \approx 0.015m_b$.

Fig. 5 gives curves of C_{D0} plotted against M and R for $m = 0$ and $m = 0.015m_b$. The dotted curves give the variation of C_{D0} with R for incompressible flow, calculated for selected transition positions by the Squire-Young method and plotted from data given in Figs. 6 and 7 of R. & M. 2165⁷. The effect of compressibility is likely to be small for $M < 0.6$, and if this is so, the position of transition for $m = 0.015m_b$ is about $0.15c$, that is, close to the surface holes. The transition

position for $m = 0$ is about $0.45c$. The measurements of C_{D0} taken below the critical Mach number for $m = 0$ are in close agreement with the first measurements taken for this model by Pearcey, but they are about 0.0015 higher than his later measurements⁴. The stabilising velocity gradient for section EC 1250 is small so that it is probable that this difference in C_{D0} arises, as suggested by Pearcey, from changes in the conditions of the wind-tunnel flow and of the model surface. It is therefore not unlikely that the value of m/m_0 to fix transition on a section with a more stable gradient would be greater than 0.015 . The value should however not be appreciably greater, since the value obtained from the experiments made in the low-speed tunnel, §5, for which $A \approx 1.5$, was only 0.04 . The value of A for section EC 1250 is about 0.3 .

11. Fig. 7 gives patterns formed by very fine particles of soot and dust deposited from the turbulent boundary layer on the surface behind the holes. These patterns were so faint that they could only just be seen by oblique lighting. Hand sketches are given because the patterns were almost invisible when viewed normal to the surface so that it was not possible to take photographic records. No deposits were visible for $m = 0$. The pattern for $m = 0.005m_0$, Fig. 7a, indicates that the flow is turbulent at about 0.4 in. behind the holes: but the turbulence behind is probably not fully developed because C_{D0} has not reached its maximum value, Fig. 4. A somewhat similar pattern, not shown, was obtained for $m \approx 0.01m_0$, but the turbulence began about 0.1 in. nearer the holes. For $m = 0.04m_0$, transition is complete and occurs at about 0.2 in., *i.e.* $0.017c$, behind the holes. The V-shaped transition region for $m = 0.04m_0$ resembles the patterns obtained by Charters⁸, from surveys of the lateral spread of turbulence behind small obstacles immersed in a laminar boundary layer. The rate of lateral spread given by the semi-angle at the apex of a V shape is 9.5 deg.

Direct observation, made by the shadow method, for $M > 0.725$, showed that the flow just outside the boundary layer near the holes was undisturbed provided that m was less than $0.04m_0$. At this value a weak shock wave extending about 0.2 in. from the surface appeared.

Measurements of total-head losses in the wake at $0.017c$ behind the trailing edge of the model, $M = 0.762$, made for $m = 0$ and $0.017m_0$ are given in Fig. 6. The curve for $m = 0.017m_0$ runs smoothly, at the outer parts of the wake, into that for $m = 0$, and does not give any indication of the presence of a local shock wave near the holes due to the air jets. The mean velocity of flow through a hole was about $0.1u_1$ for $m = 0.017m_0$.

12. Fig. 4 clearly shows the large increase in drag due to a small leakage of air into the laminar boundary layer of a low-drag aerofoil. Leakage of air from the boundary layer into an aerofoil has, in general, a beneficial effect on drag. When, therefore, operational requirements are such that leaks cannot be avoided provision should be made, by a suitable system of venting, to arrange that the pressure within the aeroplane wing is lower than that outside, so that the leakage is from the boundary layer into the wing.

13. In conclusion, it would appear that the experiments establish the effectiveness of the air-injection method of fixing transition. In application, the method is simple and the rate of air injection can be adjusted to give, at each speed of test, a minimum disturbance of flow necessary to fix transition at the selected position. The minimum rate of air injection for transition is only about 0.015 times the rate of mass-flow in the boundary layer. The method is especially suitable for high-speed tests since it does not give a local shock wave, which may be present when a surface wire is used to fix transition.

REFERENCES

No.	Author	Title, etc.
1	Fage and Preston	On Transition from Laminar to Turbulent Flow in the Boundary Layer. <i>Proc. Roy. Soc., A.</i> , Vol. 178, pp. 201-227, 1941.
2	Fage	The Smallest Size of a Spanwise Surface Corrugation which affects Boundary-layer Transition on an Aerofoil. <i>R. & M.</i> 2120. January, 1943.
3	Goldstein	Modern Developments in Fluid Dynamics. Vol. 1, p. 319. Clarendon Press, Oxford. 1938.
4	Pearcey and Beavan	Profile Drag Measurements at Compressibility Speeds on Aerofoils with and without Spanwise Wires or Grooves. Note on Reynolds and Mach Number Effects on the Pressure Distribution on the Tail of EC1250. <i>R. & M.</i> 2252. August, 1943.
5	Fage and Sargent	Design of Suction Slots. <i>R. & M.</i> 2127. February, 1944.
6	Preston and Sweeting	An Improved Smoke Generator for Use in the Visualisation of Airflow, particularly Boundary-layer Flow at High Reynolds Numbers. <i>R. & M.</i> 2023. October, 1943.
7	Fage and Walker	Experiments on Laminar-flow Aerofoil EQH 1260 in the William Froude National Tank and the 13 ft. x 9 ft. and the 9 ft. x 7 ft. Wind Tunnels at the National Physical Laboratory. <i>R. & M.</i> 2165. January, 1942.
8	Charters	Transition between Laminar and Turbulent Flow by Transverse Contamination. N.A.C.A. Technical Note No. 891.
9	Johansen	Flow through Pipe Orifices at Low Reynolds Numbers. <i>R. & M.</i> 1252. June, 1929.

APPENDIX

(i) *Low-speed Wind Tunnel*.—The tunnel had a constant width of 8 in. and its height changed linearly from 3 in. at the inlet to 2.8 in. at the outlet, Fig. 1. Muslin gauzes were stretched over the inlet and outlet to steady the flow. Observation by the smoke-filament technique developed by Preston and Sweeting⁶, showed that the flow was steady, apart from a casual waviness. Air was drawn through the tunnel by a suction pump connected to the outlet chamber. The value of the boundary-layer Reynolds number $u_1\delta/\nu$, for laminar flow at the standard section was 523.

It was not possible to estimate with good accuracy the value of δ for a laminar boundary layer from the experimental u, y curves. A representative value of δ_1/δ , where δ_1 is the displacement thickness given by $\int_0^\delta [1 - (u/u_1)]dy$, could however be obtained by plotting u/u_1 against y/δ_1 . The values of δ taken were obtained from this representative value of δ_1/δ and calculated values of δ_1 .

The value of δ for a turbulent boundary layer could be estimated with reasonably good accuracy from a curve of u against y .

The holes in the floor were connected by separate tubes to a chamber under the tunnel. Air was supplied to this chamber by a small centrifugal blower. The rate of air injection into the boundary layer was measured with a 0.1-in. diameter plate orifice in a 1-in. pipe. The Reynolds numbers of the orifice ranged from about 800 to 2,000. The discharge coefficients for these low numbers were obtained from *R. & M.* 1252⁹.

(ii) *Aerofoil EC 1250*.—The rate of air injection was measured with a 0.175-in. plate orifice in a 1-in. pipe, open at the inlet end to the atmosphere. The control valve was between the outlet end of the orifice pipe and the aerofoil.

The experiments were made for the aerofoil at 0 deg. incidence. The momentum thickness, θ , of a laminar boundary layer at $x = 0.15c$, estimated for incompressible flow by the Squire-Young method, is given by $\theta/c = 0.238/\sqrt{R}$, where R is the Reynolds number U_0c/ν . For the Blasius velocity profile, $\Lambda = 0$ we have $\theta/\delta = 0.099$, and $\delta_1/\delta = 0.254$. At $x/c = 0.15$, $u_1/U_0 = 1.115$, so that $(\delta/c)\sqrt{R} = 2.4$ and $m_b = [1 - (\delta_1/\delta)]\rho_0\delta u_1 = 2\rho_0U_0c/\sqrt{R}$.

Both δ/c and m_b/ρ_0cU_0 are greater for compressible flow than for incompressible flow, but for the present work sufficiently close approximations to the values of δ and m_b are given by the above relations on substitution of the values of R, ρ_0 and U_0 for compressible flow.

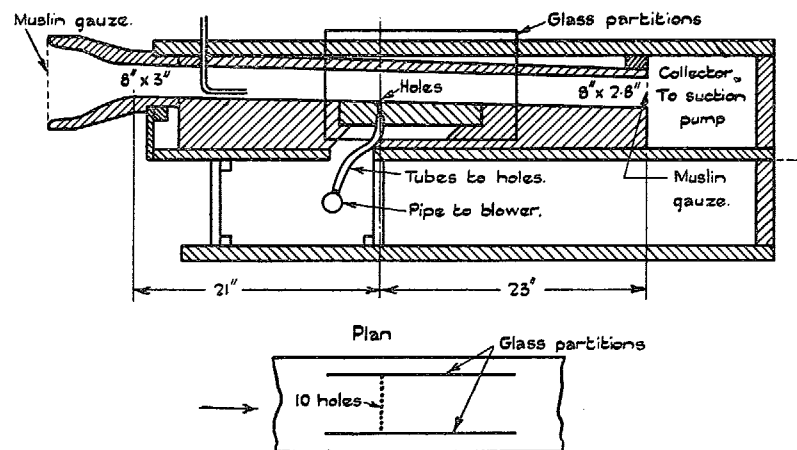

FIG. 1. Elevation View of Smoke Tunnel.

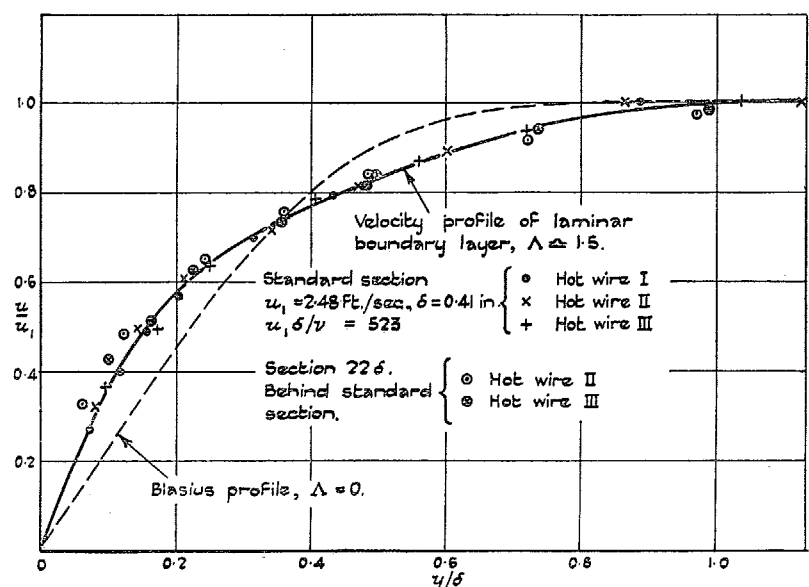

FIG. 2. Velocity Distribution in Boundary Layer on Floor.

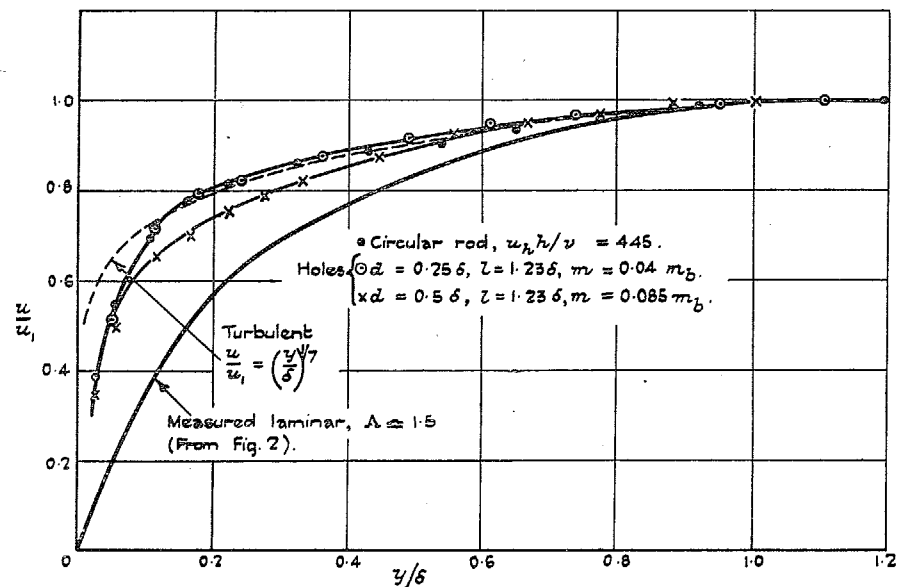

FIG. 3. Velocity Distribution at Section 22δ behind Standard Section.

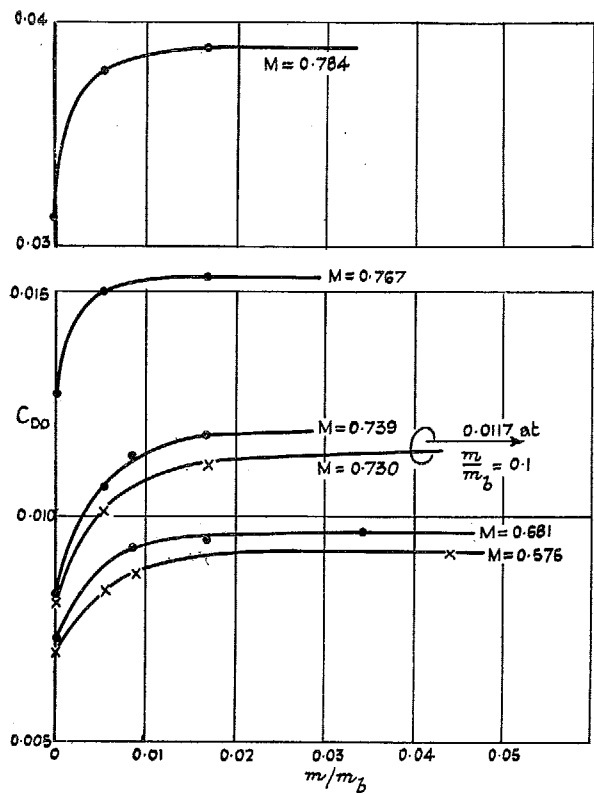

FIG. 4.

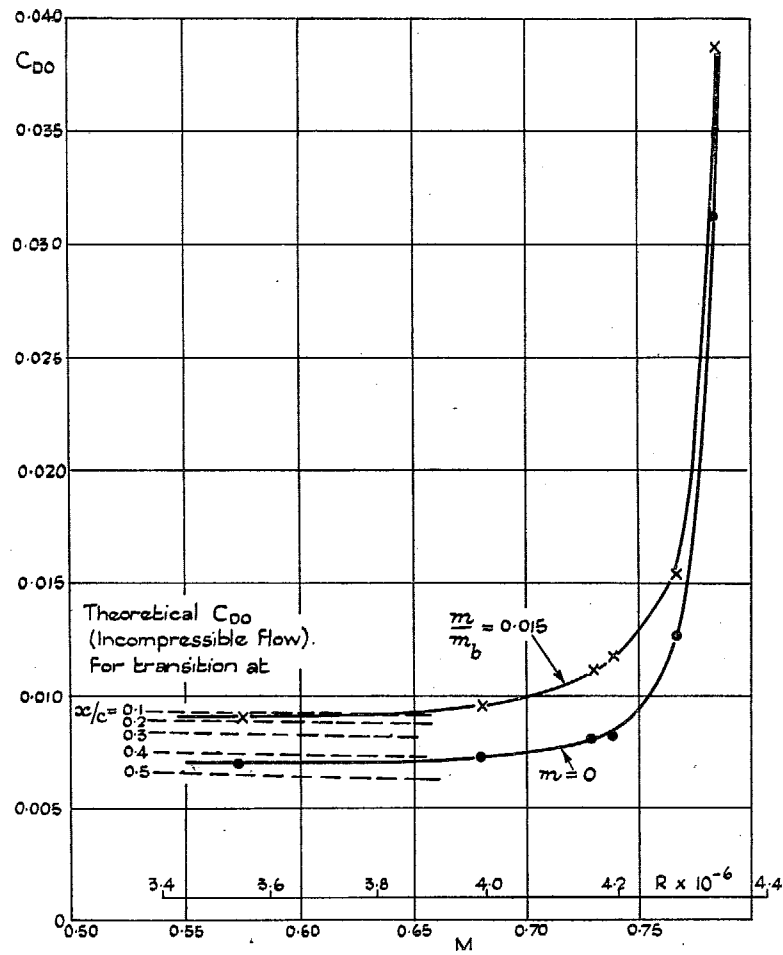

FIG. 5. Aerofoil EC 1250. 0 deg. Incidence.

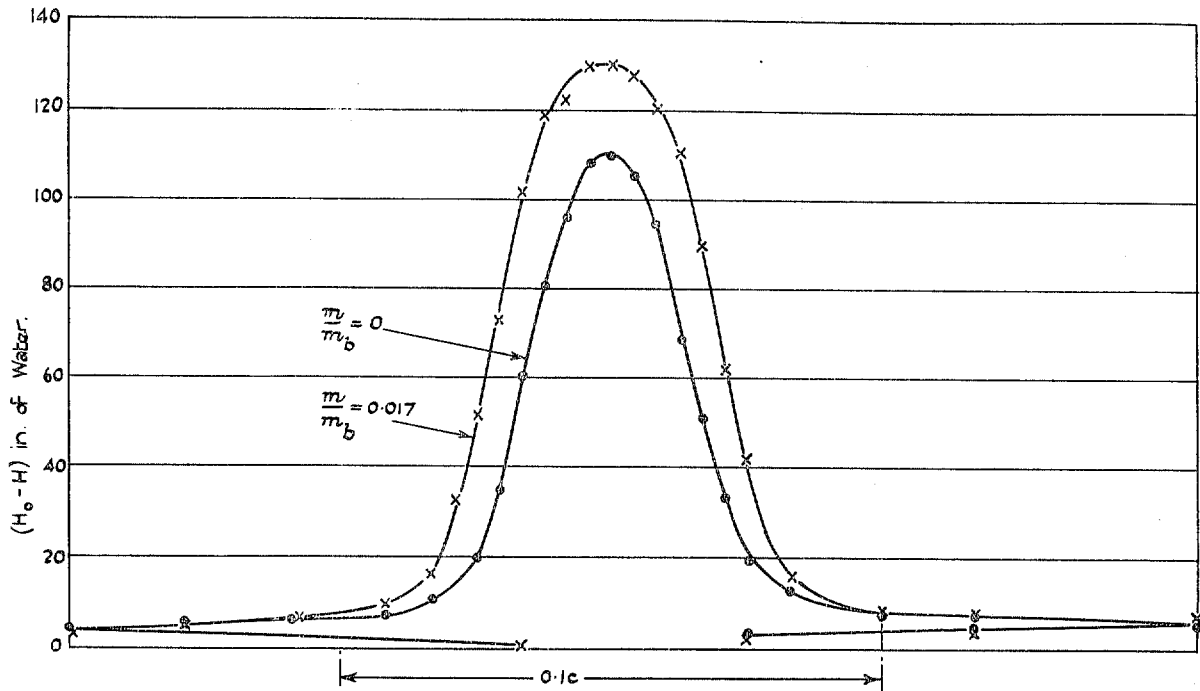

FIG. 6. Aerofoil EC 1250. 0 deg. Incidence. $M = 0.762$. Total-head Loss in Wake at $0.017c$ behind Trailing Edge.

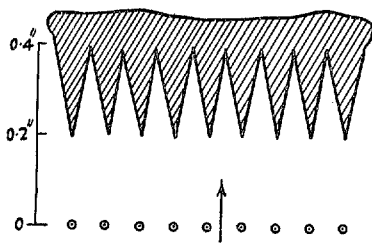

FIG. 7a. $m = 0.005 m_b$.

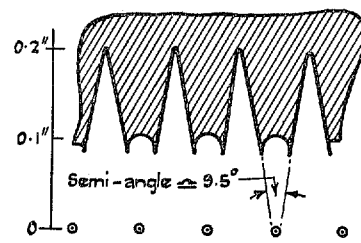

FIG. 7b. $m = 0.04 m_b$.

Surface Patterns given by very Small Dust Particles.

Publications of the Aeronautical Research Committee

TECHNICAL REPORTS OF THE AERONAUTICAL RESEARCH COMMITTEE—

- 1934-35 Vol. I. Aerodynamics. 40s. (40s. 8d.)
Vol. II. Seaplanes, Structures, Engines, Materials, etc.
40s. (40s. 8d.)
- 1935-36 Vol. I. Aerodynamics. 30s. (30s. 7d.)
Vol. II. Structures, Flutter, Engines, Seaplanes, etc.
30s. (30s. 7d.)
- 1936 Vol. I. Aerodynamics General, Performance,
Airscrews, Flutter and Spinning.
40s. (40s. 9d.)
Vol. II. Stability and Control, Structures, Seaplanes,
Engines, etc. 50s. (50s. 10d.)
- 1937 Vol. I. Aerodynamics General, Performance,
Airscrews, Flutter and Spinning.
40s. (40s. 9d.)
Vol. II. Stability and Control, Structures, Seaplanes,
Engines, etc. 60s. (61s.)

ANNUAL REPORTS OF THE AERONAUTICAL RESEARCH COMMITTEE—

- 1933-34 1s. 6d. (1s. 8d.)
1934-35 1s. 6d. (1s. 8d.)
April 1, 1935 to December 31, 1936. 4s. (4s. 4d.)
1937 2s. (2s. 2d.)
1938 1s. 6d. (1s. 8d.)

INDEXES TO THE TECHNICAL REPORTS OF THE ADVISORY COMMITTEE ON AERONAUTICS—

December 1, 1936 — June 30, 1939
Reports & Memoranda No. 1850. 1s. 3d. (1s. 5d.)

July 1, 1939 — June 30, 1945
Reports & Memoranda No. 1950. 1s. (1s. 2d.)

Prices in brackets include postage.

Obtainable from

His Majesty's Stationery Office

London W.C.2 : York House, Kingsway
[Post Orders—P.O. Box No. 569, London, S.E.1.]

Edinburgh 2: 13A Castle Street

Manchester 2: 39-41 King Street

Cardiff: 1 St. Andrew's Crescent

Bristol 1: Tower Lane

Belfast: 80 Chichester Street

or through any bookseller.