

R. & M. No. 2751  
(12,838, 13,499)  
A.R.C. Technical Report



MINISTRY OF SUPPLY

AERONAUTICAL RESEARCH COUNCIL  
REPORTS AND MEMORANDA

# Experiments on Conical Diffusers

*By*

H. B. SQUIRE, M.A.

*Crown Copyright Reserved*

LONDON: HER MAJESTY'S STATIONERY OFFICE

1953

FIVE SHILLINGS NET

# Experiments on Conical Diffusers

By

H. B. SQUIRE, M.A.

COMMUNICATED BY THE PRINCIPAL DIRECTOR OF SCIENTIFIC RESEARCH (AIR),  
 MINISTRY OF SUPPLY

*Reports and Memoranda No. 2751\**  
*November, 1950*

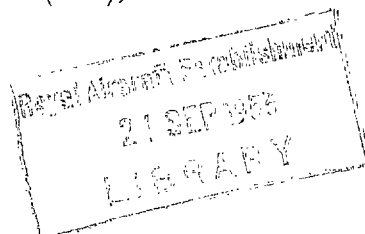

*Summary.*—Measurements of the characteristics of conical diffusers of area ratio 4 between entry and exit and of total cone angle 4, 5, 6, 8 and 10 deg were made to determine the effect of Reynolds number on efficiency for uniform entry flow. A range of entry Reynolds number between  $5 \times 10^4$  and  $10^6$  was covered. The results are given in terms of a loss coefficient  $\mu = 1 - \eta$ , where  $\eta$  is the efficiency of pressure recovery in the diffuser. The values of  $\mu$  obtained are as follows:—

Cone angle (total) (deg)	4	5	6	8	10	Remarks
$R_1 = 10^5$	0.11	0.11	0.11	0.11	—	Suction tests
$R_1 = 10^6$	0.09	0.09	0.08	0.10	—	
$R_1 = 10^5$	—	—	0.12	0.12	0.115	Blowing tests
$R_1 = 10^6$	—	—	0.09	0.10	0.115	

There is thus little variation in efficiency with cone angle for the range tested, but a reduction in loss coefficient is obtained with increase of Reynolds number for cone angles less than 10 deg.

The pressure distributions along the walls and the velocity distributions at the end of the conical sections were measured. These showed that there was no boundary-layer separation for any of the cones.

Further measurements of velocity distribution were made with conical diffusers of area ratio 16 between entry and exit and with pipe flow at the entry, to determine the velocity distributions which finally develop. These also gave no indication of boundary-layer separation for cone angles up to 10 deg.

1. *Introduction.*—No systematic measurements of the efficiency of conical diffusers have been made since Gibson's tests in 1910<sup>1</sup>. The present investigation was made to check this early work, and to study the variation of efficiency with Reynolds number and the changes in flow with change of cone angle.

The experiments of Part I were made with cones of angles between 4 and 10 deg, of area ratio 4 between entry and exit, and with uniform flow at the entry. These showed no striking effect due to variation in cone angle and gave no sign of flow separation.

The experiments of Part II were made with diffusers of area ratio 16 between entry and exit and with pipe flow at the entry, and consisted of measurements of the velocity distribution at a number of stations. The object of these later tests was to find out whether, under these different conditions from Part I, flow separation occurred at the larger cone angles, thereby giving a practical limit to the cone angle which could be used in the return circuits of wind tunnels and in other ducts.

\* A.R.C. 12,838. R.A.E. Report Aero. 2216. Received 3rd January, 1950.  
 A.R.C. 13,499. N.P.L. Aerodynamics Division.

2. *Notation.*

$d_1$	Entry diameter
$d_2$	Exit diameter
$d$	Diameter at any station
$x$	Distance along the pipe from the beginning of the conical part
$l$	Length of the conical part of the pipe
$u$	Velocity at any point
$u_1$	Velocity in entry section
$u_m$	Mean velocity across a section
$p$	Pressure at any point measured relative to entry total head
$p_1$	Pressure at entry plane of measurement
$p_2$	" " exit " " "
$p_{2i}$	Ideal pressure at exit
$\eta$	Efficiency defined by equation (1)
$\eta'$	" " " " (2)
$\mu = 1 - \eta$	Loss coefficient
$R_1$	Reynolds number for entry flow.

PART I.

*Efficiency and Flow in Conical Diffusers of Area Ratio 4*

3. *Details of Apparatus and Tests.*—The experiments of Part I were made with plain conical diffusers of angle 4, 5, 6, 8 and 10 deg\*, of entry diameter 3.5 in. and exit diameter 7 in.; so that the area ratio in each case was 4 to 1. The entry section consisted of a bell-mouth followed by a cylindrical section of length 3.5 in. A cylindrical exit section of length 14 in. was fitted to the downstream end of the cone. The arrangement is shown in Fig. 1. The straight conical diffusers were fitted in turn between the standard entry and exit lengths†.

The tests were made with a blower plant and were done (a) using suction for which the bell-mouth entry was open to the atmosphere and the exit was connected to the suction side of the plant, and (b) using ejection for which the entry was connected to the blower and the exit to the atmosphere‡, as shown in Fig. 1. The maximum velocity obtainable in the entry length was about 500 ft/sec, and the minimum velocity for which it was possible to make observations was about 30 ft/sec. This gave a range of entry Reynolds number of  $5 \times 10^4$  to  $10^6$ .

The entry velocity distribution consisted of a uniform velocity core with a thin-wall boundary layer for all the cones, both for blowing and for suction. No attempt was made to study the effect of deliberate variation of the entry conditions, as was done by Peters<sup>4</sup>.

Pressure-plotting tubes were provided at the stations marked A to N in Fig. 1, pairs of tubes at opposite ends of a diameter being installed at each station.

The main tests consisted of measurements of entry total head§, and of wall pressure at stations AB in the entry length and LM in the exit length; the diffuser efficiency was calculated from these data. In addition measurements of the pressure distribution along the tubes and of the velocity distribution at the beginning of the parallel exit section (plane JK in Fig. 1) were made at one speed.

---

\* Cone angle always means total angle.

† It was found to be important to obtain a good fit at the joints at the small end of the cones.

‡ It had been intended originally to do all the tests with suction but blowing gave steadier flow.

§ For the suction tests the entry total head was equal to the atmospheric pressure.

4. *Definition of Diffuser Efficiency.*—We adopt the definition of diffuser efficiency used in Ref. 2. If a fluid flows along a passage from station 1 at which the pressure is  $p_1$  to station 2 where the pressure is  $p_2$  the diffuser efficiency  $\eta$  is defined as

$$\eta = \frac{p_2 - p_1}{p_{2i} - p_1} \quad \dots \quad \dots \quad \dots \quad \dots \quad \dots \quad (1)$$

where  $p_{2i}$  is the ideal pressure which would be attained at station 2 if there were no frictional losses and if the velocity and pressure were uniform at this station.

The definition in (1) is more convenient than the definition used by Patterson<sup>3</sup>, which is

$$\eta' = \frac{\int_2 p u dS - \int_1 p u dS}{\int_1 \frac{1}{2} \rho u^3 dS - \int_2 \frac{1}{2} \rho u^3 dS}, \quad \dots \quad \dots \quad \dots \quad \dots \quad \dots \quad (2)$$

where the integrations are over planes at stations 1 and 2,  $\rho$  is the density, and  $u$  is the stream velocity which is assumed to be normal to the plane of integration.

In place of  $\eta$  it is convenient to present the results in terms of a loss coefficient  $\mu$  defined by

$$\mu = 1 - \eta = \frac{p_{2i} - p_2}{p_{2i} - p_1} \quad \dots \quad \dots \quad \dots \quad \dots \quad \dots \quad (3)$$

Station 1 is taken to be the plane AB of Fig. 1, which is halfway along the parallel section at the entry, and the pressure  $p_1$  is taken to be the mean value of the pressures measured at the four orifices at A and B (Fig. 1). Station 2 is taken to be one diameter downstream of the large end of the cones (plane LM in Fig. 1) and the pressure  $p_2$  is taken to be the mean value of the pressures at the four orifices at L and M (Fig. 1). The pressures were all measured relative to the inlet total head.

Since the area of cross-section at station 2 is four times the area at station 1 we have the result that, for an incompressible fluid,

$$p_{2i} = \frac{1}{16} p_1,$$

if the velocity is uniform at station 1. Hence, from (3),

$$\mu = 1.067(p_2/p_1) - 0.067,$$

if friction in the entry length is ignored.

A correction to allow for the surface friction in the whole entry length up to the beginning of the conical section was applied; it is shown in the Appendix that this leads to a correction to  $\mu$  of  $6/R_1^{1/2}$  so that finally

$$\mu = 1.067(p_2/p_1) - 0.067 - 6R_1^{-1/2}$$

where  $R_1$  is the entry Reynolds number.

No correction for compressibility was necessary in the speed range covered.

5. *Results of Tests.*—5.1. *Diffuser Efficiency.*—The results of the measurements of diffuser efficiency are given in Figs. 2 to 5 in terms of diffuser loss coefficient  $\mu$ , as defined above, plotted

against  $\log_{10} R$ . The 4 and 5 deg cones were only tested under suction. The 6, 8 and 10 deg cones were tested both with blowing and suction and the results obtained are shown separately. Average values of the loss coefficient are as follows:—

Cone angle (total) (deg)	4	5	6	8	10	Remarks
$R_1 = 10^5$	0.11	0.11	0.11	0.11	*	Suction tests
$R_1 = 10^6$	0.09	0.09	0.08	0.10	*	
$R_1 = 10^5$	—	—	0.12	0.12	0.115	Blowing tests
$R_1 = 10^6$	—	—	0.09	0.10	0.115	

\* Scatter large for 10 deg cone: see Fig. 5.

5.2. *Pressure Distribution along the Walls.*—The pressure distributions along the walls of the pipes for  $R_1 = 5 \times 10^5$  (approximately) are given in Fig. 8 in the form of curves of  $p/p_1$  plotted against  $x/l$ , where  $p$  is the wall pressure at a station distant  $x$  from the beginning of the conical part of the pipes, and  $l$  is the length of the conical part.

5.3. *Velocity Distribution at the End of the Cones.*—The velocity distributions for  $R_1 = 5 \times 10^5$  (approximately) measured at the downstream end of the conical part of the pipes, determined from pitot-traverse and wall pressure measurements, are given in Fig. 9. Traverses were made across two diameters at right-angles in order to show any asymmetry. The results are given in the form of curves of  $u/u_m$  plotted against  $r/d_2$ , where  $u_m$  is the mean velocity determined from the mass flow,  $r$  is the radial distance, and  $d_2$  is the pipe diameter at the exit.

6. *Discussion.*—6.1. *Diffuser Efficiency.*—The measured values of the loss coefficient given in Figs. 2 to 5 show an increasing scatter with increase of cone angle. Further the scatter is greater for suction than for blowing; this is probably due to the greater unsteadiness in the former condition†. In addition there is a tendency for the loss coefficient in the suction tests to rise at the higher values of  $R_1$  in the suction tests; this is probably caused by transition to turbulent flow in the entry length.

The mean values of the results are plotted against cone angle for  $R_1 = 10^5$  and  $R_1 = 10^6$  in Figs. 6 and 7, excluding the results of the suction tests for the 10 deg cone due to the large scatter. There is little variation of loss coefficient with cone angle for  $R_1 = 10^5$  but for  $R_1 = 10^6$  the losses are less for the smaller cone angles. Gibson's results are also shown in Fig. 6 and fair agreement is obtained.

It is not possible to deduce any law of variation of diffuser efficiency with Reynolds number to give reliable values at higher Reynolds numbers, but inspection of Fig. 2 suggests that the loss coefficient for 4 deg and 5 deg cones will be about 0.07 for  $R_1 = 10^7$  and about 0.06 for  $R_1 = 10^8$ . Extrapolation for the larger cone angles is uncertain. It must be emphasised that the results apply only for smooth conical diffusers with nearly uniform entry flow. The efficiency is liable to be seriously affected by leaks and surface irregularities.

The confirmation of Gibson's result that the diffuser efficiency varies only slowly with cone angle leads in turn to the conclusion that only small gains are possible by variation of the diffuser shape if the local cone angle always lies between 4 deg and 10 deg. Also it follows that it is very unlikely that diffusers of appreciably higher efficiency than plain conical diffusers can be devised.

† The unsteadiness was only noticed when an attempt to measure the velocity distribution at the end of the cones was made in the suction condition. This unsteadiness was associated with disturbances such as convection currents affecting the flow at the entry.

The calculated results at  $R_1 = 10^6$  given in Ref. 2 are also shown in Fig. 7, and are seen to be a poor guide to the variation of diffuser efficiency with cone angle. The lack of agreement is probably due to the difficulty of predicting the development of a turbulent boundary layer in an adverse pressure gradient.

6.2. *Pressure Distribution.*—The measured pressure distributions along the walls, which are given in Fig. 8, are similar for all the pipes and the differences between them are due to minor errors in construction, except in so far as the pressure at the exit is related to the diffuser efficiency.

If there were no frictional losses the pressure distribution along all the pipes would be determined from the relations

$$u_m d^2 = \text{constant},$$

$$p + \frac{1}{2} \rho u_m^2 = \text{constant},$$

where  $d$  is the diameter and  $u_m$  is the mean velocity at any station. Since

$$d = d_1 \left(1 - \frac{x}{l}\right) + d_2 \left(\frac{x}{l}\right),$$

these equations give

$$\frac{p_1}{p} = \left[1 + \frac{x}{l} \left(\frac{d_2}{d_1} - 1\right)\right]^4,$$

if  $p_1$  is the pressure at the entry, so that  $p = p_1$  for  $x = 0$ , and if pressures are measured relative to the inlet total head so that  $p \rightarrow 0$  for  $x \rightarrow \infty$ . For the present tests  $d_2 = 2d_1$ , so that

$$\frac{p_1}{p} = \left(1 + \frac{x}{l}\right)^4.$$

This ideal pressure distribution is shown in Fig. 8. Since the total losses are much the same for all the pipes the actual pressure distributions are very similar to one another and differ by much the same amount from the ideal distribution.

It will be seen that there is a small increase in pressure along the parallel exit length, which therefore gives a small increase in efficiency as compared with the plain cone. The efficiency measurements given here are all referred to a station one diameter downstream of the end of the cone (plane LM of Fig. 1) and the mean value of the pressure at four orifices was used in order to eliminate casual errors as far as possible. With the area ratio of 4 used the parallel exit length does not produce more than 0.01 reduction in loss coefficient, but with smaller area ratios the parallel exit length may be more important (see Ref. 4).

6.3. *Velocity Distribution at the End of the Cones.*—Fig. 9 shows a progressive variation of the velocity distribution at the end of the cones with variation of cone angle. For the 4, 5 and 6 deg cones a loss of head was present at the centre of the pipe due to the boundary layer having reached the centre, but for the 8 and 10 deg cones the boundary layer has not reached the centre of the pipe. The larger the cone angle the smaller is the velocity close to the walls, but there is no boundary-layer separation for any of the pipes.

These velocity distributions enable an estimate to be made of the difference in diffuser efficiency given by the formulae (1) and (2). Equation (2) allows for the increase in kinetic energy passing the end of the cone compared with the kinetic energy which would be passing, at the same mass



flow, if the velocity were uniform over the exit. This kinetic energy ratio is equal to

$$\int_0^1 \left(\frac{u}{u_m}\right)^3 d \left[ \left(\frac{2r}{d_2}\right)^2 \right]$$

and the values of this quantity were found by integration to be as follows:—

Cone angle	4	5	6	8	10
K.E. ratio	1.28	1.43	1.51	1.68	1.80

A value of 1.4 for this ratio would give an increase in efficiency of 2.5 per cent over the efficiency as defined by (1), for the particular area ratio used. The effect is therefore appreciable and the use of equation (2) would give relatively higher efficiencies for the larger cone angles. But the definition adopted is likely to be a better guide to the real efficiency, since the extra kinetic energy at the outlet due to the non-uniformity of the velocity cannot be fully utilised.

## PART II.

### *Flow in Conical Diffusers of Area Ratio 16*

7. *Experiments.*—The experimental arrangement for the tests of Part II is shown in Fig. 10 and the main dimensions and conditions of test are given in Table 1. Air from a blower was supplied to a pipe of diameter 1.75 in. and length 3 ft, at the end of which the conical diffusers of entry diameter 1.75 in. and exit diameter 7 in. and of cone angles 4, 5, 6, 8 and 10 deg were fitted. The velocity distribution at the downstream end of the parallel pipe (entry to cones) is shown in Fig. 11. The velocity distributions were measured at a number of cross-sections of the diffusers, at a mean entry velocity of about 500 ft/sec. No correction has been applied for the effect of turbulence on the pitot-tube readings; this may explain why the volume flow as given by the distributions measured in the diffusers is apparently higher than the value determined at the entry. (*cf.* Fig. 8).

8. *Results and Discussion.*—The results of the measurements are given in Figs. 12 to 16 in which  $u/u_m$  is plotted against  $r/d$ , where  $u$  is the velocity at point at a distance  $r$  from the axis at a station where the diameter is  $d$  and the mean velocity is  $u_m$ . Figs. 12 to 16 also show the stations at which the measurements were made. Traverses were not made over the upstream part of the cones as the main object was to determine the final velocity distributions. These were attained for the 4, 5 and 6 deg cones and are shown together for comparison in Fig. 17, in which the distribution in a long parallel pipe at the same Reynolds number is also shown. The final distributions were not attained for the 8 and 10 deg cones in the length available. No flow separation occurred in any of the cones over the lengths investigated.

It will be seen from Figs. 12 to 17 that the final distributions of velocity are much flatter than the intermediate distributions and in fact are not very different from the distribution in a long parallel pipe. Presumably the ratio of the turbulent velocities to the mean velocity increases along the diffuser due to the reduction in the mean velocity and this may explain the trend

towards a more uniform velocity along the cones. The velocity distributions for cone angles of 1 deg and 2 deg given in Ref. 5 are more pointed than those given in Fig. 17; this is probably because they had not attained their final form due to insufficient length of pipe, and they have not been included for this reason.

It is concluded that unsatisfactory flow in conical diffusers (for cone angles up to 10 deg) is due to poor entry flow. It is probable however, that the sensitivity of the flow to entry disturbances will be less for the smaller cone angles.

---

*Acknowledgement.*—P. H. Carter and P. Sibbald assisted in the experiments.

### REFERENCES

<i>No.</i>	<i>Author</i>	<i>Title, etc.</i>
1	A. H. Gibson .. .. .	<i>Proc. Roy. Soc.</i> , Vol. A83, p. 366. (1910).
2	A. D. Young and W. S. Emerson	Note on the Theoretical Incompressible Flow Losses in Smooth Conical Diffusers. R.A.E. Tech. Note No. Aero. 1814. A.R.C. 9960. July, 1946. (Unpublished.)
3	G. N. Patterson .. .. .	Modern Diffuser Design. <i>Aircraft Engineering</i> . September, 1938.
4	Peters .. .. .	<i>Ingenieur-Archiv</i> , pp. 92-107. 1931.
5	G. A. Gourzhienko .. .. .	The Turbulent Flow in Diffusers of Small Divergence Angle. Report No. 462 of the C.A.H.I. (Moscow, 1939). Translated as N.A.C.A. Tech. Memo. No. 1137. 1947.

---

### APPENDIX

#### *Correction to Loss Coefficient Due to Entry Length*

It is difficult to correct the measurement of Part I for the effect of the entry length because the velocity distribution in the entry affects the diffuser efficiency. We adopt the crude approximation that the pressure drop required to overcome the frictional resistance in the entry length is wholly lost. This assumption would be a valid one if there were pipe flow in the entry with a constant shape of velocity distribution, but it is only correct as to order of magnitude in the present case.

Let  $\Delta p$  be this 'frictional pressure drop' and  $C_f$  the skin-friction coefficient. Thus

$$\Delta p \times \frac{\pi d_1^2}{4} = C_f \times \frac{1}{2} \rho u_1^2 \times \pi d_1 \times l$$



where  $l$  is the length of the entry. Hence

$$\frac{\Delta p}{\frac{1}{2}\rho u_1^2} = C_f \times \frac{4l}{d_1}$$

The actual entry length is equal to  $d_1$  and making an allowance for friction in the bell-mouth we take  $l = 1.3d_1$ . Also for laminar flow on a flat plate of this length we have

$$C_f = \frac{1.33}{(u_1 l / \nu)^{1/2}} = \frac{1.16}{R_1^{1/2}}$$

where  $R_1 = \frac{u_1 d_1}{\nu}$  is the Reynolds number of the entry.

Hence

$$\frac{\Delta p}{\frac{1}{2}\rho u_1^2} = \frac{6}{R_1^{1/2}}$$

The correction was applied by reducing the measured loss coefficients by this amount in each test.

The correction was also calculated by an energy method and a result similar in order of magnitude was obtained.

---

TABLE 1

*Dimensions and Conditions of Tests of Part II*

Entry diameter	1.75 in.				
Entry length	3 ft				
Exit diameter	7 in.				
Area ratio	16				
<hr/>					
Cone angle (deg)	4	5	6	8	10
Length of cone	6 ft	5 ft	4.17 ft	3.12 ft	2.5 ft
<hr/>					
Entry velocity	500 ft/sec (approx.)				
Exit velocity	30 ft/sec (approx.)				
Entry Reynolds number	$4.5 \times 10^5$				
Exit Reynolds number	$1.1 \times 10^5$				

---

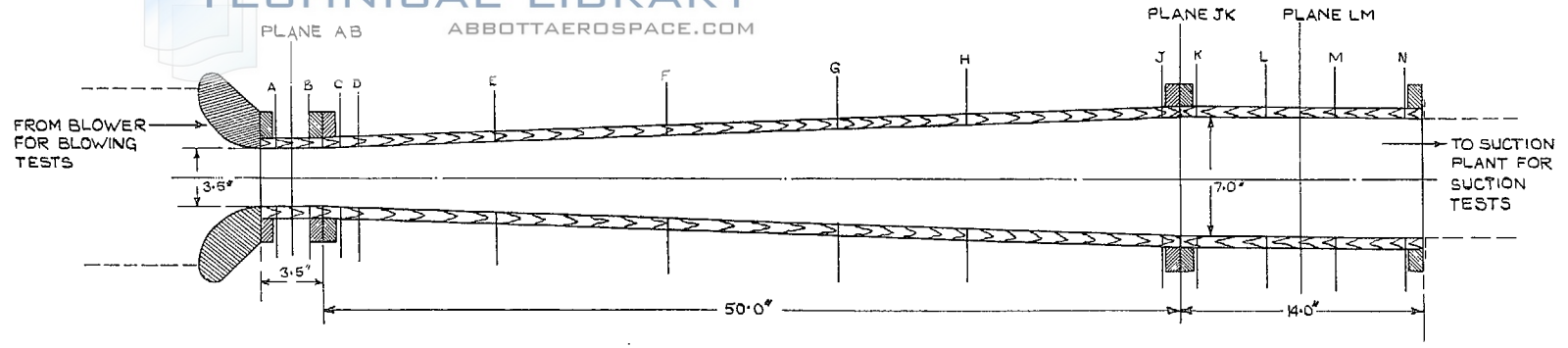

TEST ARRANGEMENT WITH 4° CONE

6

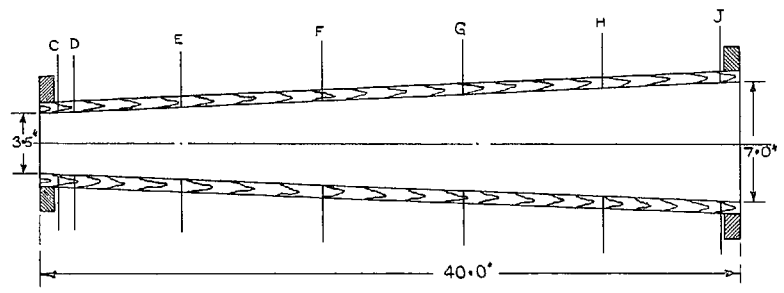

5° CONE

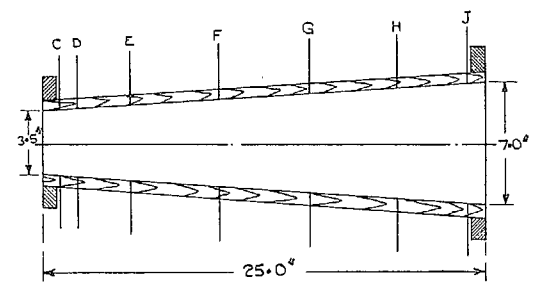

8° CONE

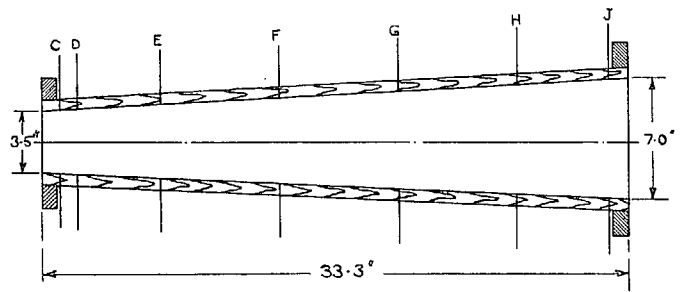

6° CONE

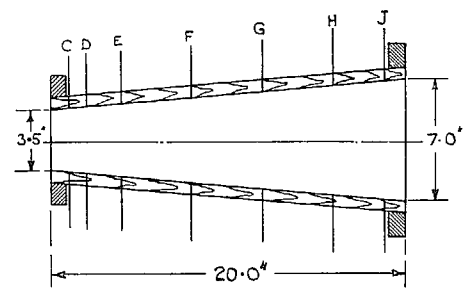

10° CONE

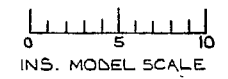

FIG. 1.

10

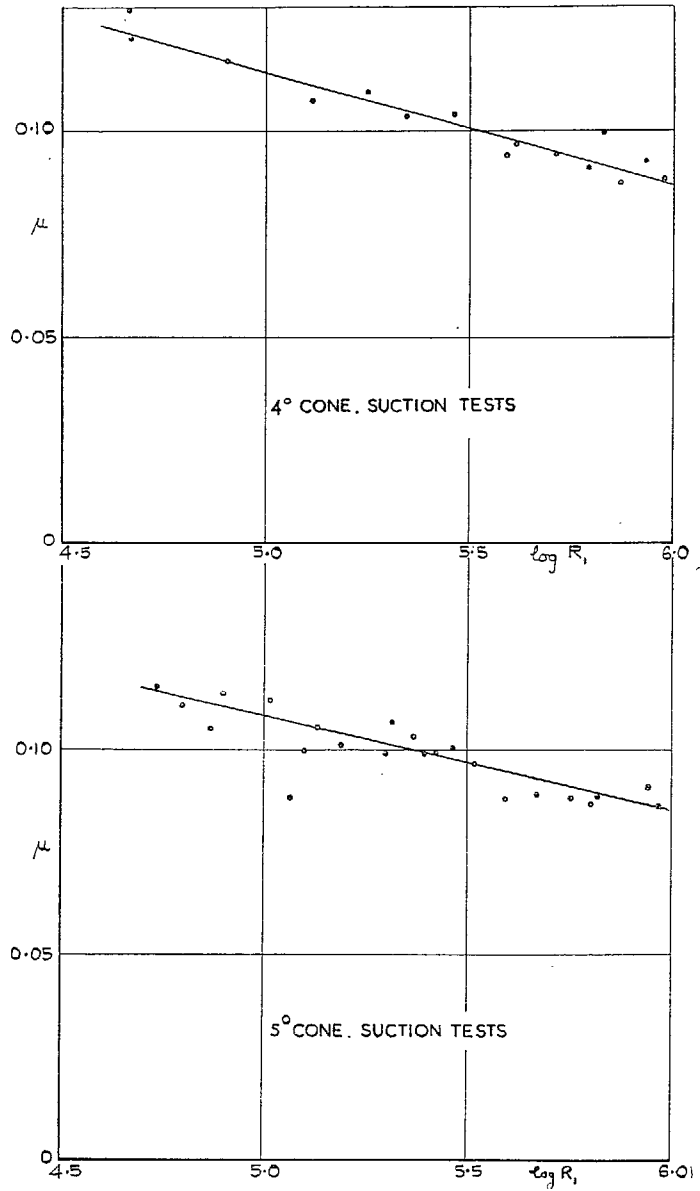

FIG. 2. Loss coefficient for conical diffusers.

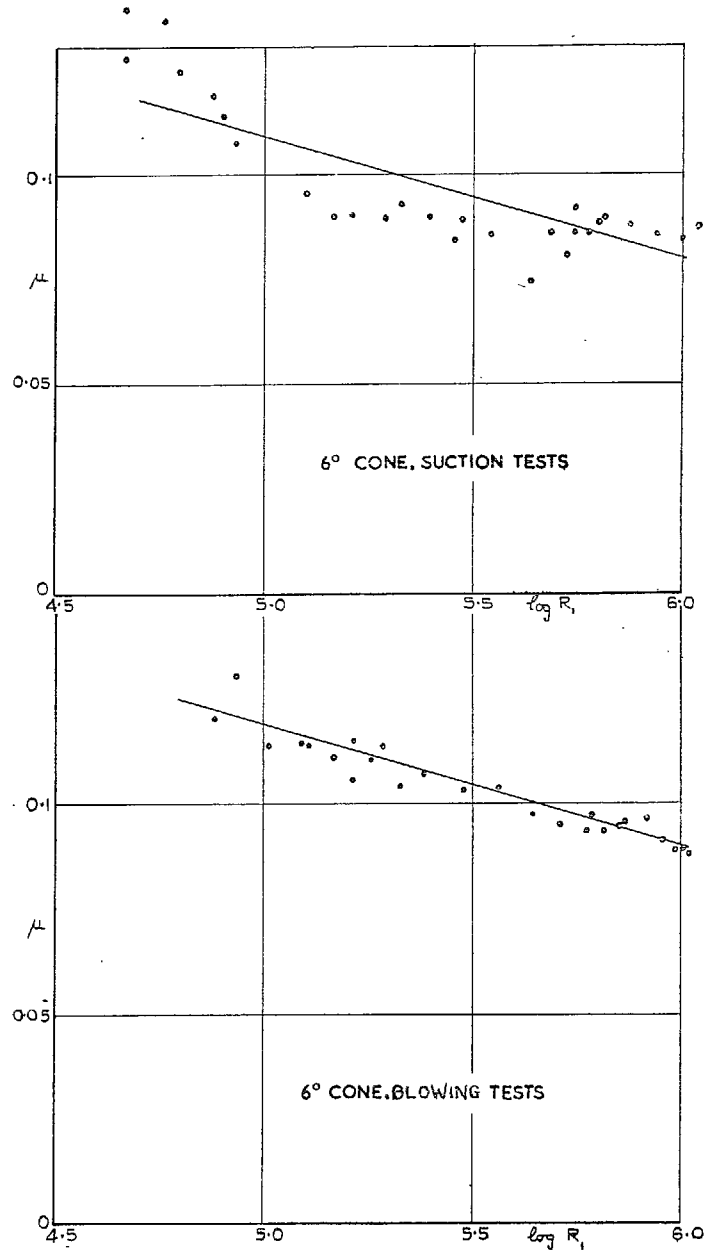

FIG. 3. Loss coefficient for conical diffusers.

11

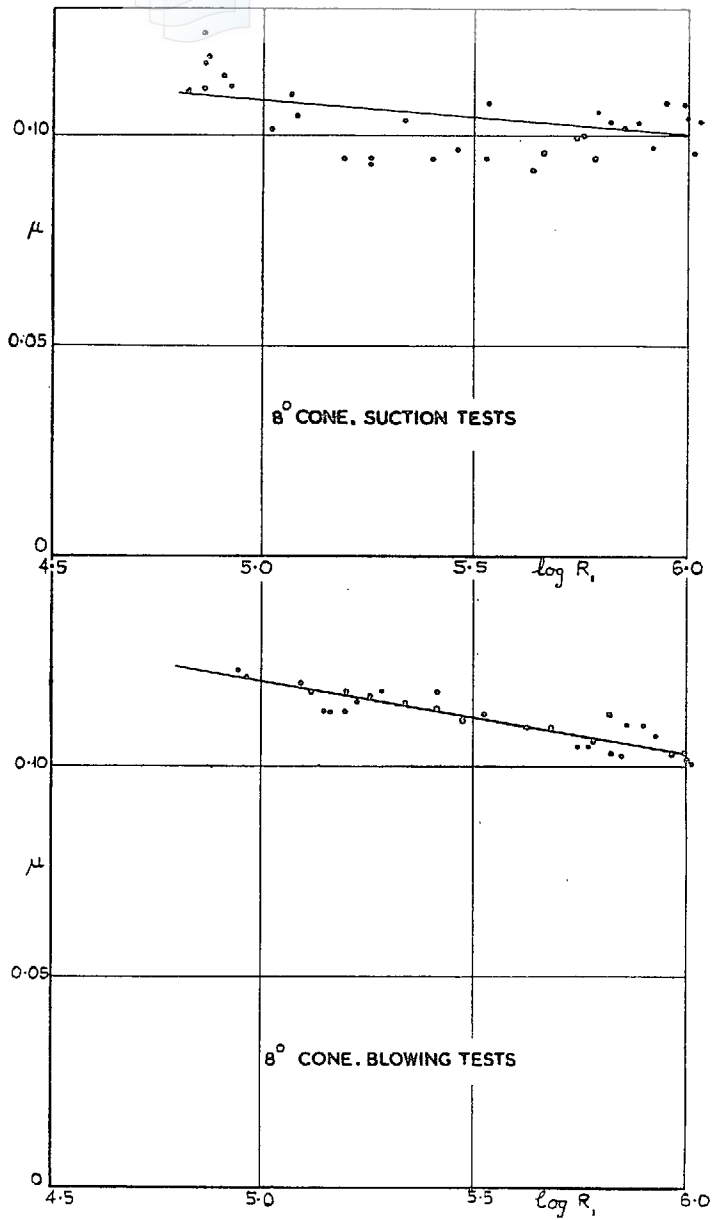

FIG. 4. Loss coefficient for conical diffusers.

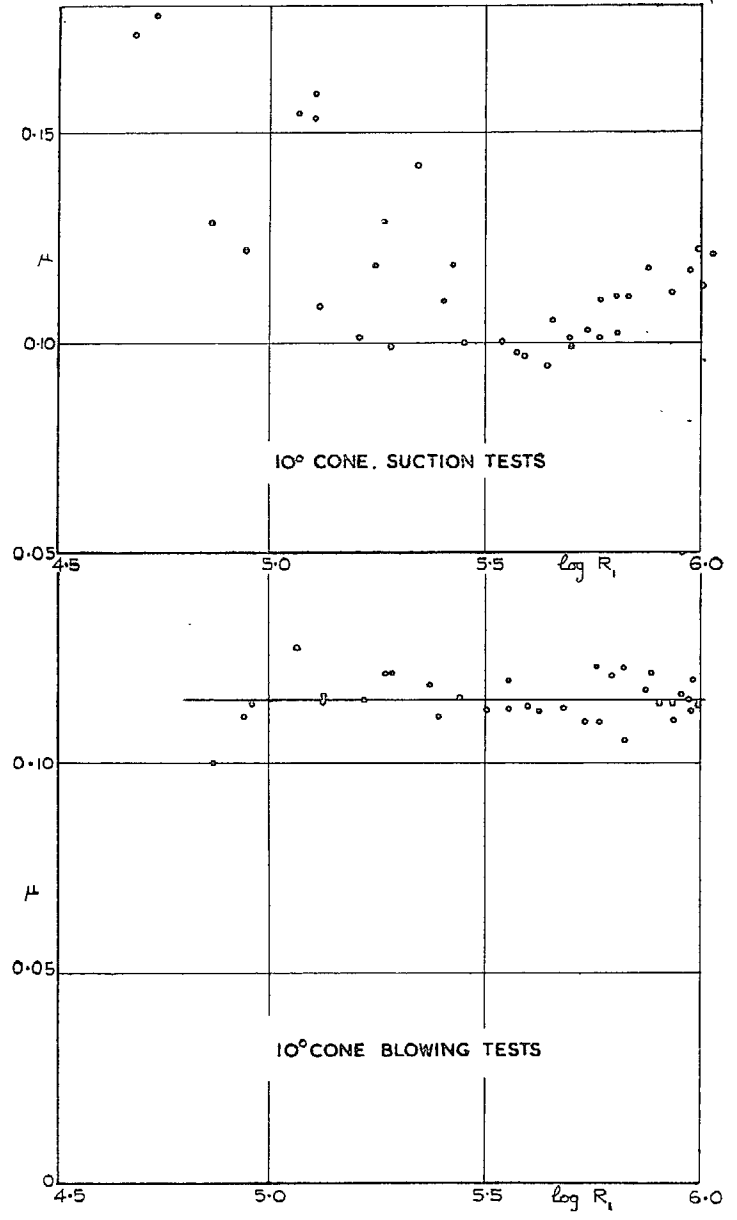

FIG. 5. Loss coefficient for conical diffusers.

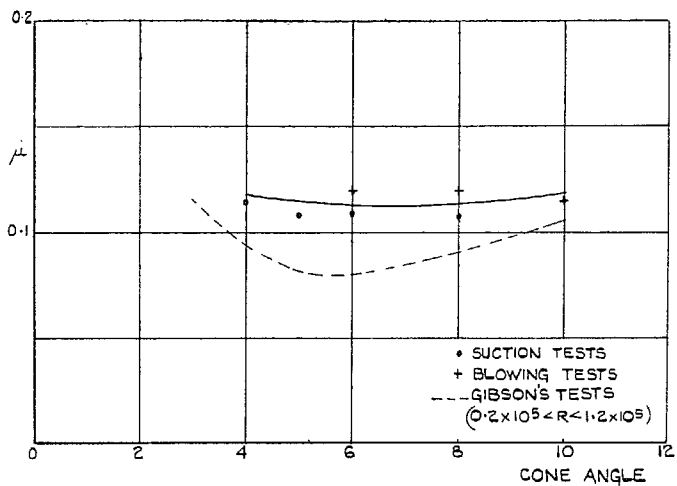

FIG. 6. Loss coefficient for conical diffusers. Area ratio 4. Results for  $R_1 = 10^5$  and comparison with Gibson's tests.

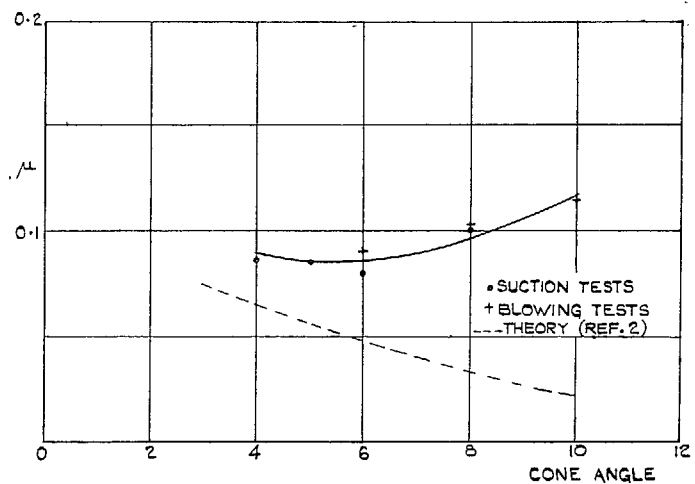

FIG. 7. Loss coefficient for conical diffusers. Area ratio 4. Results for  $R_1 = 10^6$  and comparison with theory.

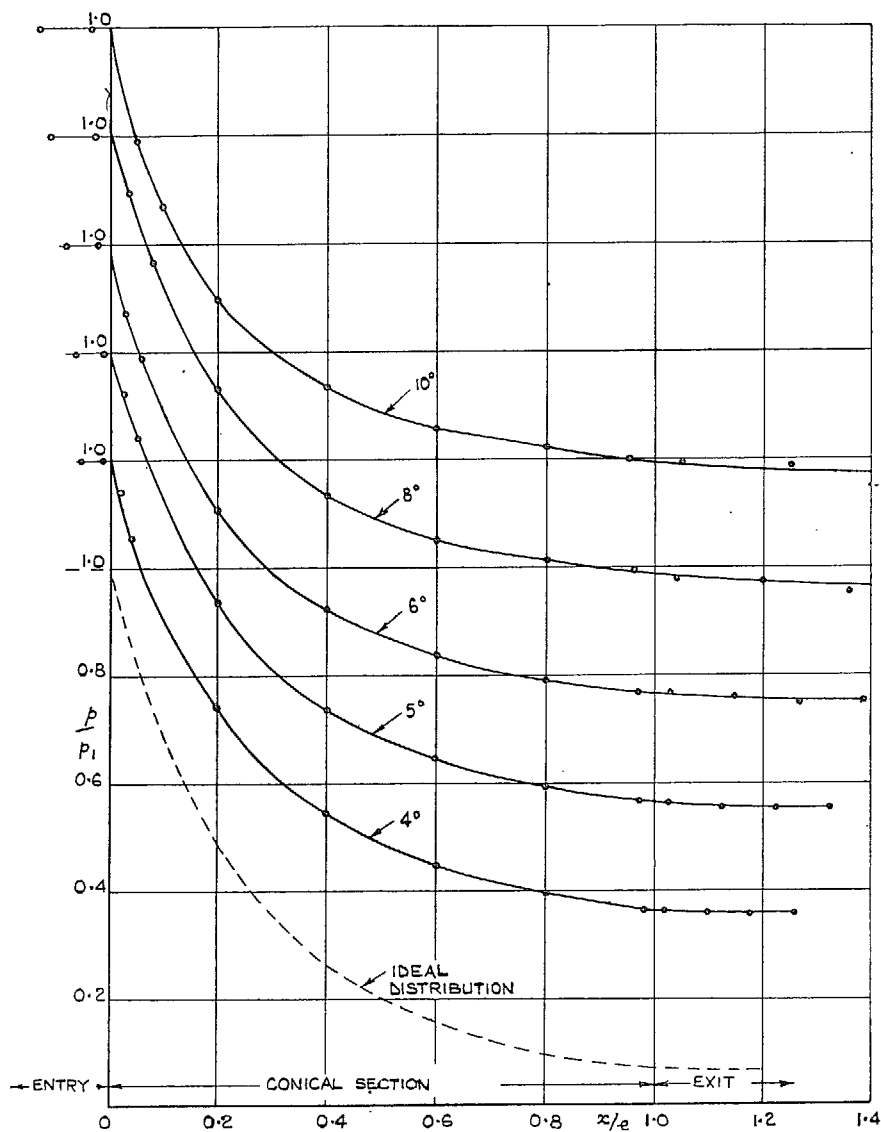

FIG. 8. Pressure distribution along conical diffusers. Entry Reynolds number =  $5 \times 10^6$  (Suction tests). Note that curves are displaced vertically.

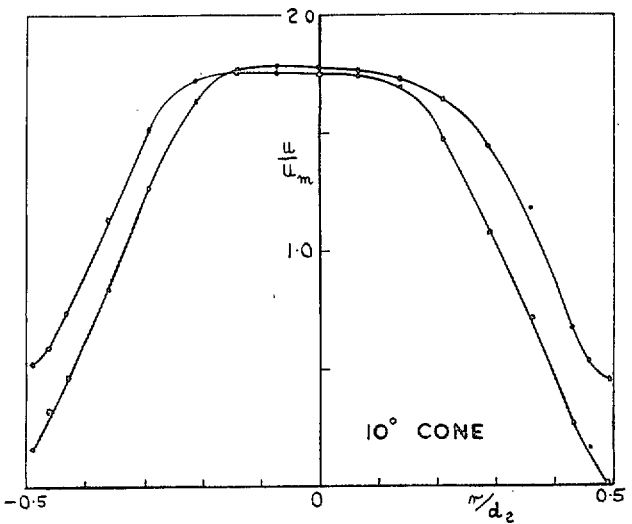
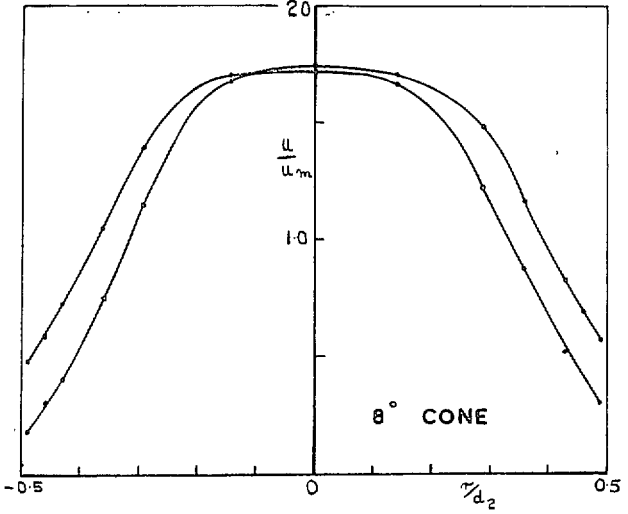
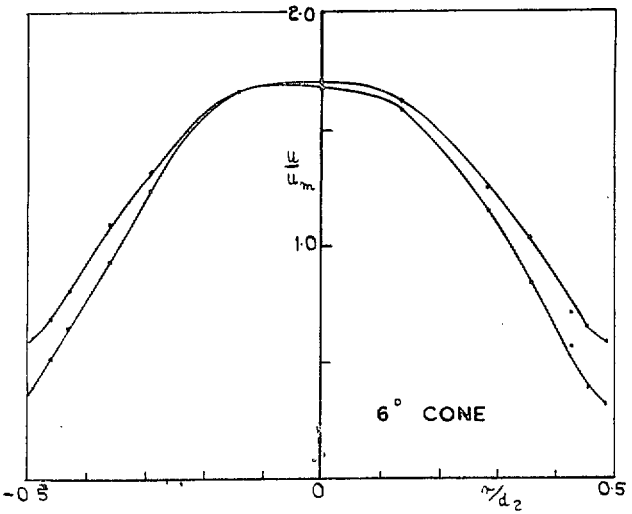
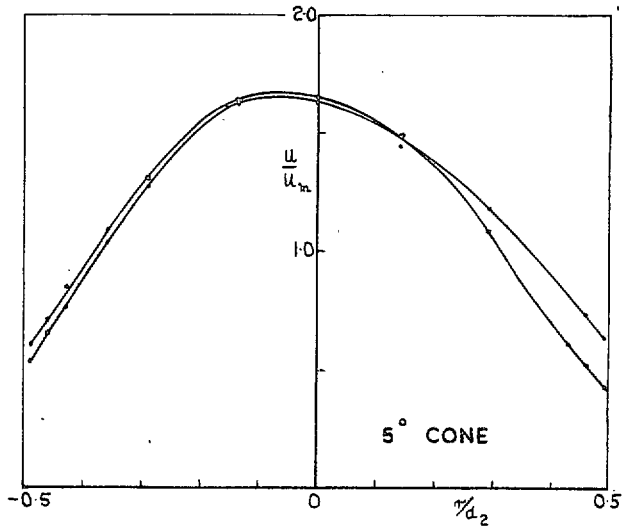
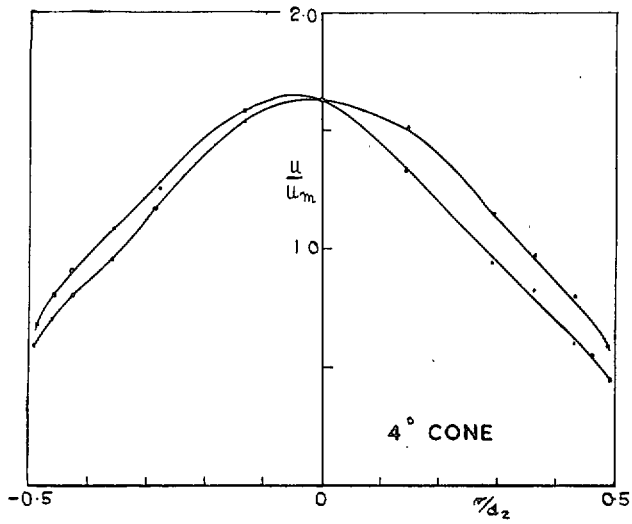

FIG. 9. Velocity distribution at end of conical section. (Plane JK in Fig. 1.)  $R_1 = 5 \times 10^5$ . Blowing tests.



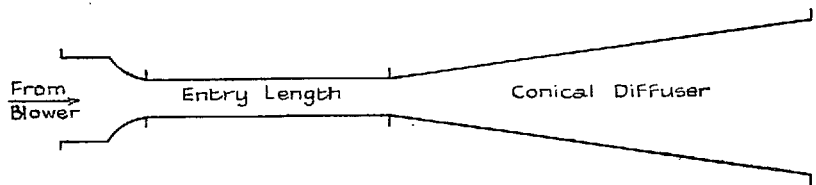

FIG. 10. Test arrangement. (Part II). (Not to scale.)

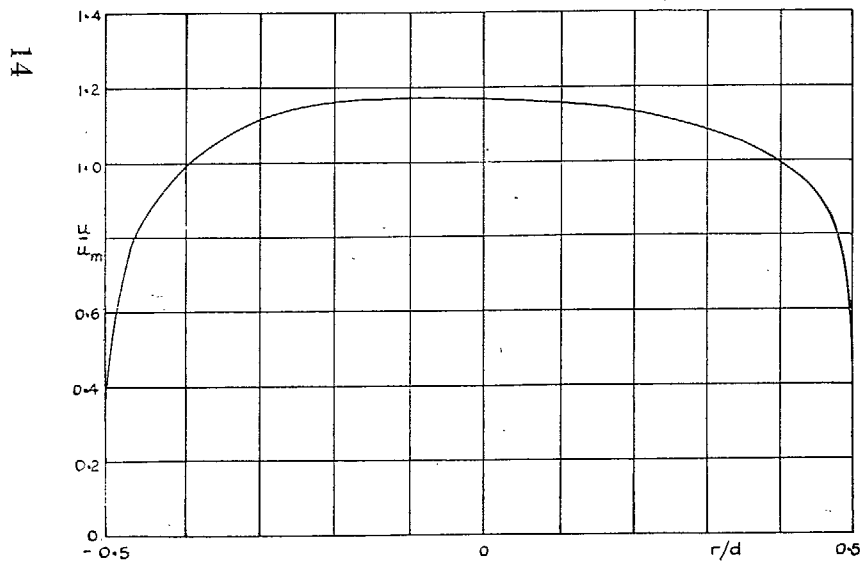

FIG. 11. Velocity distribution at entry to cones.

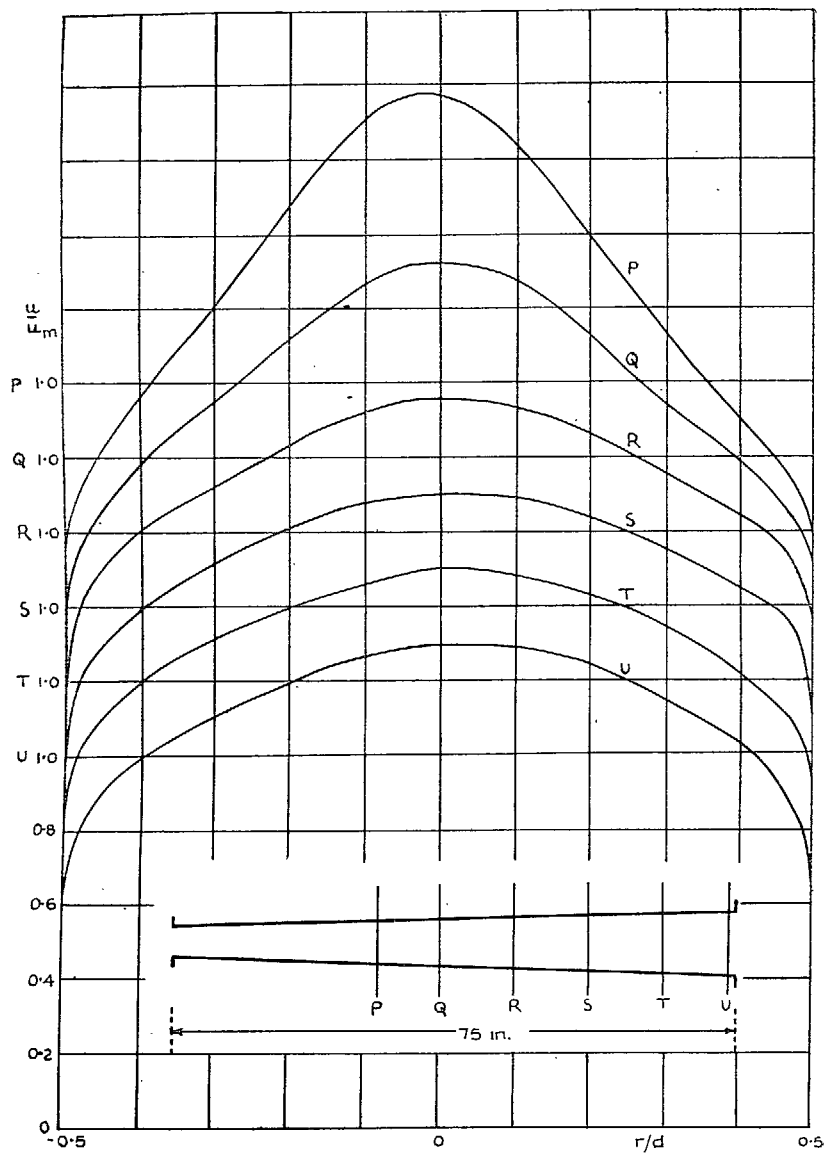

FIG. 12. 4 deg cone. Velocity distributions.

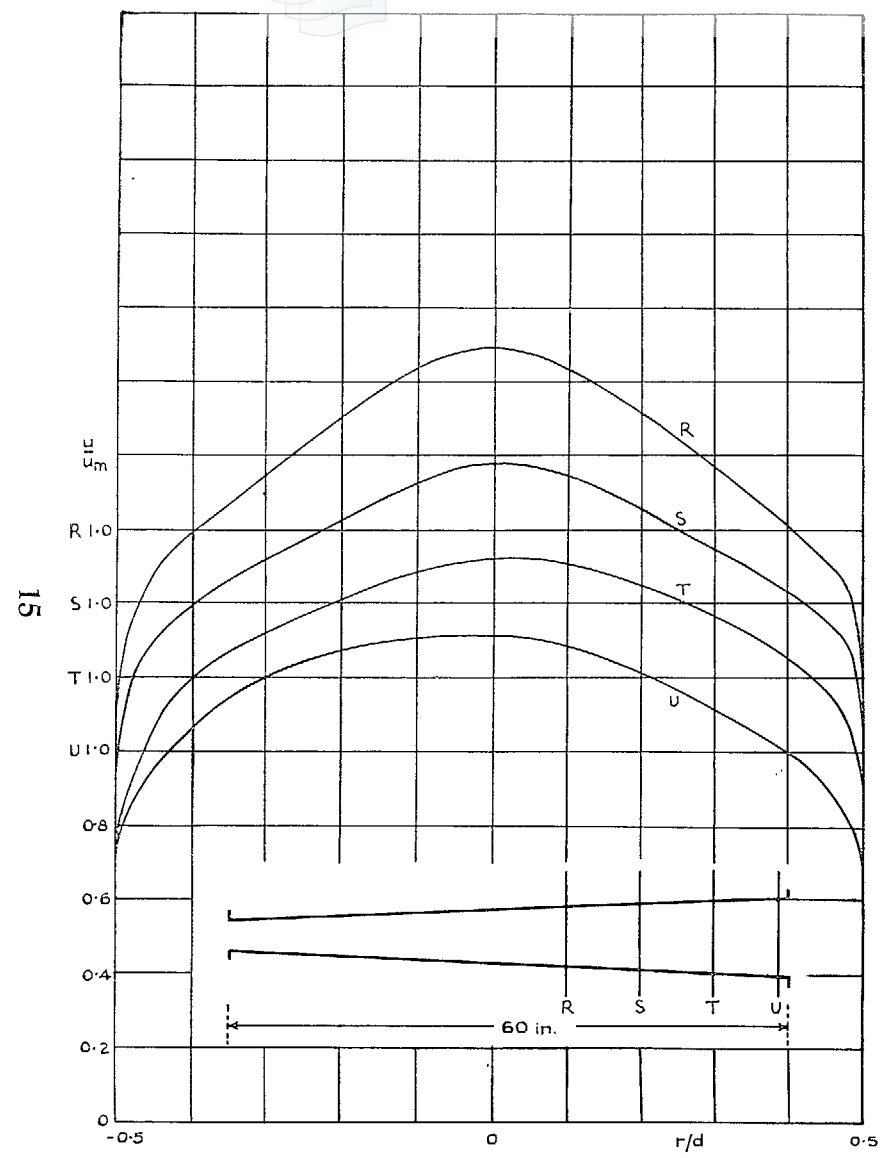

FIG. 13. 5 deg cone. Velocity distributions.

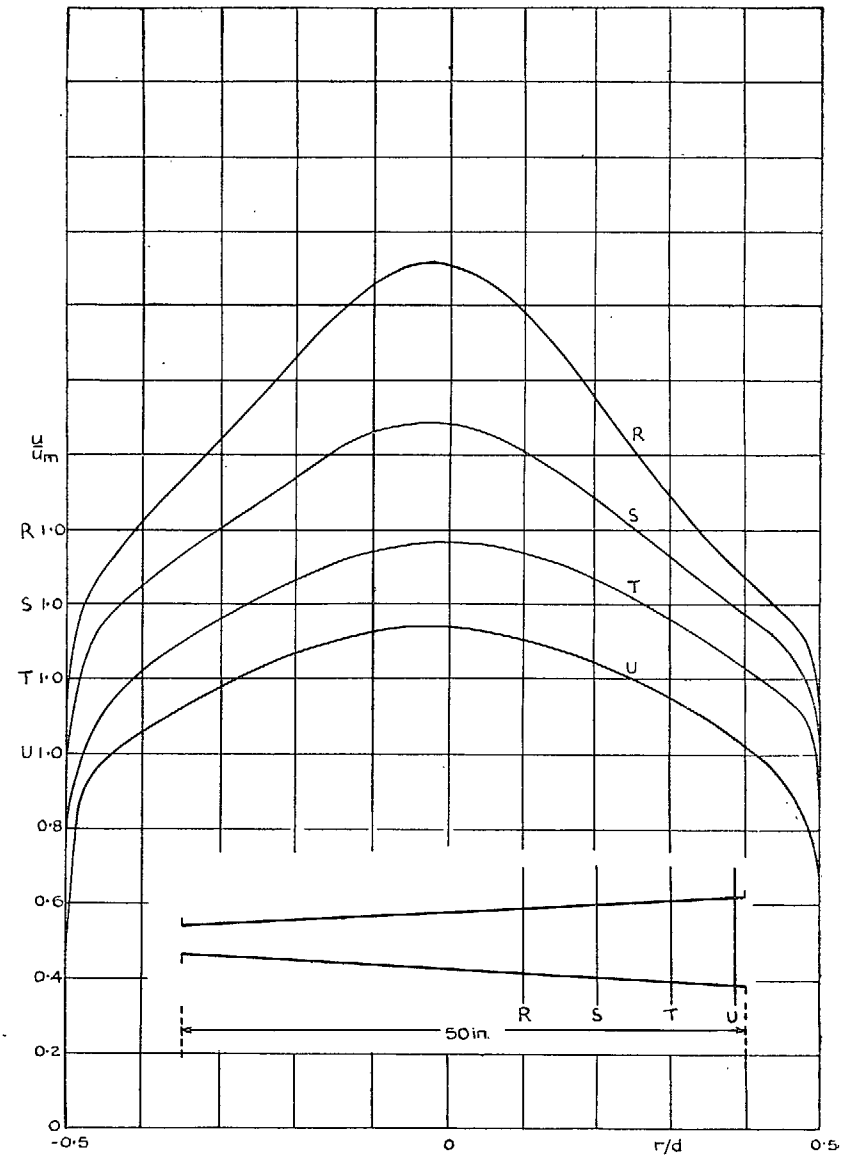

FIG. 14. 6 deg cone. Velocity distributions.

16

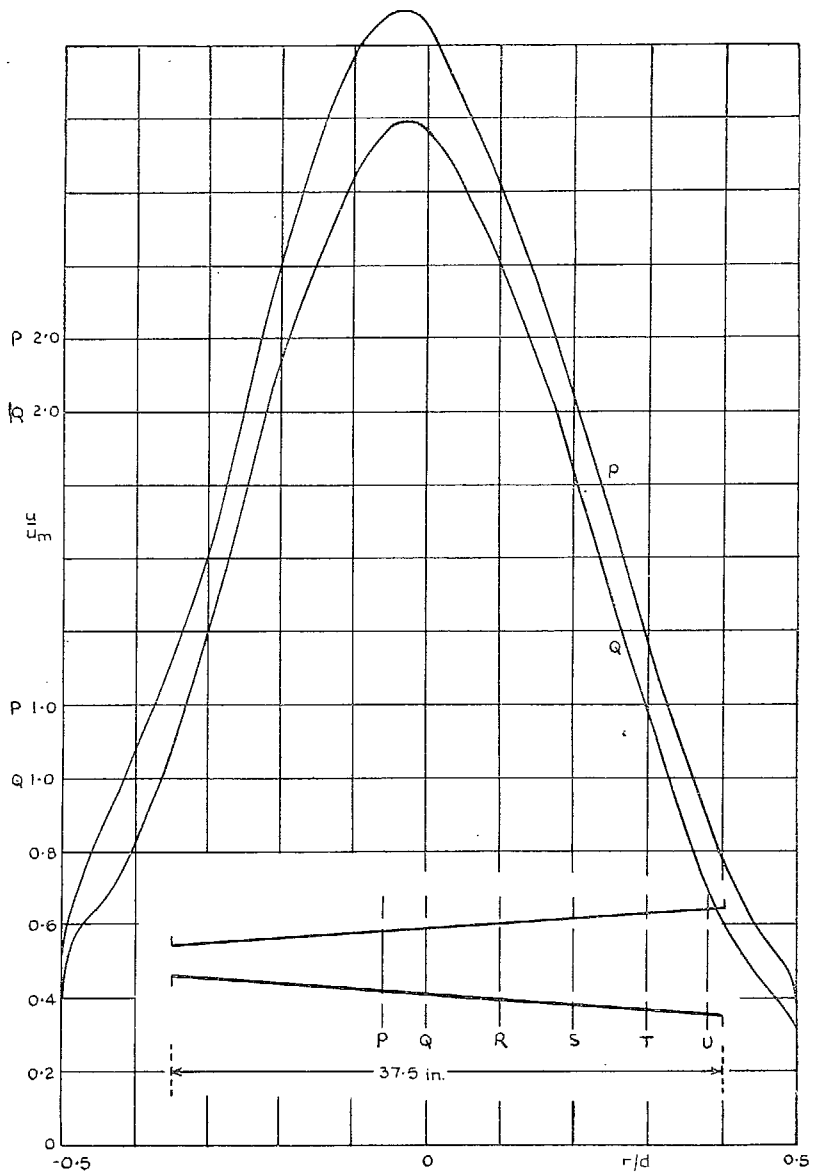

FIG. 15a. 8 deg cone. Velocity distributions.

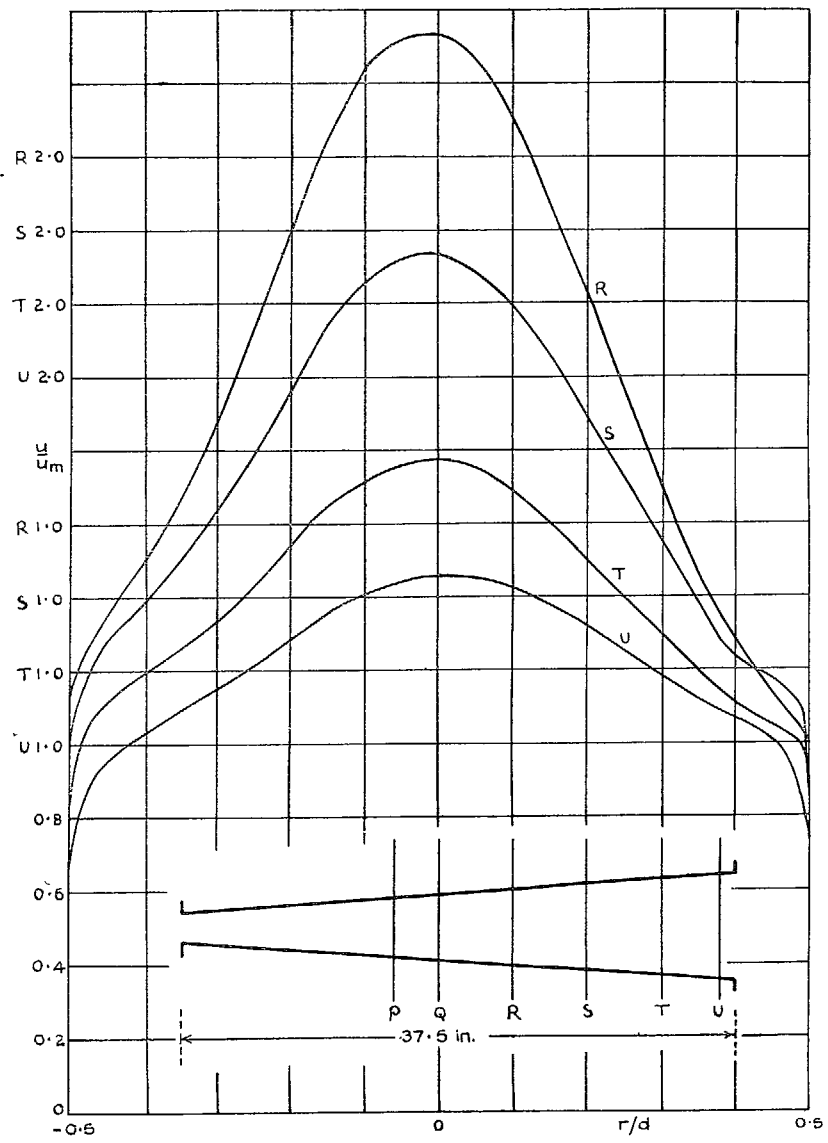

FIG. 15b. 8 deg cone. Velocity distributions.

(23147)

17

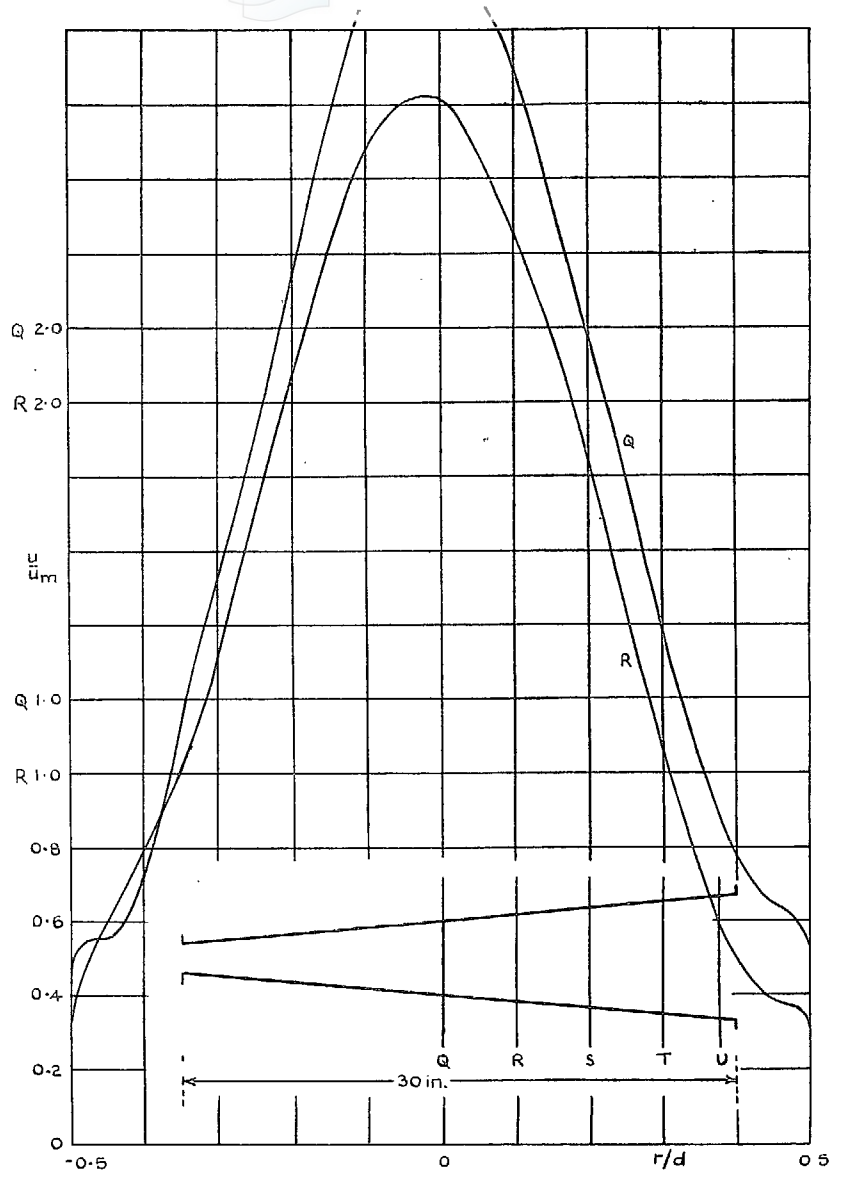

FIG. 16a. 10 deg cone. Velocity distributions.

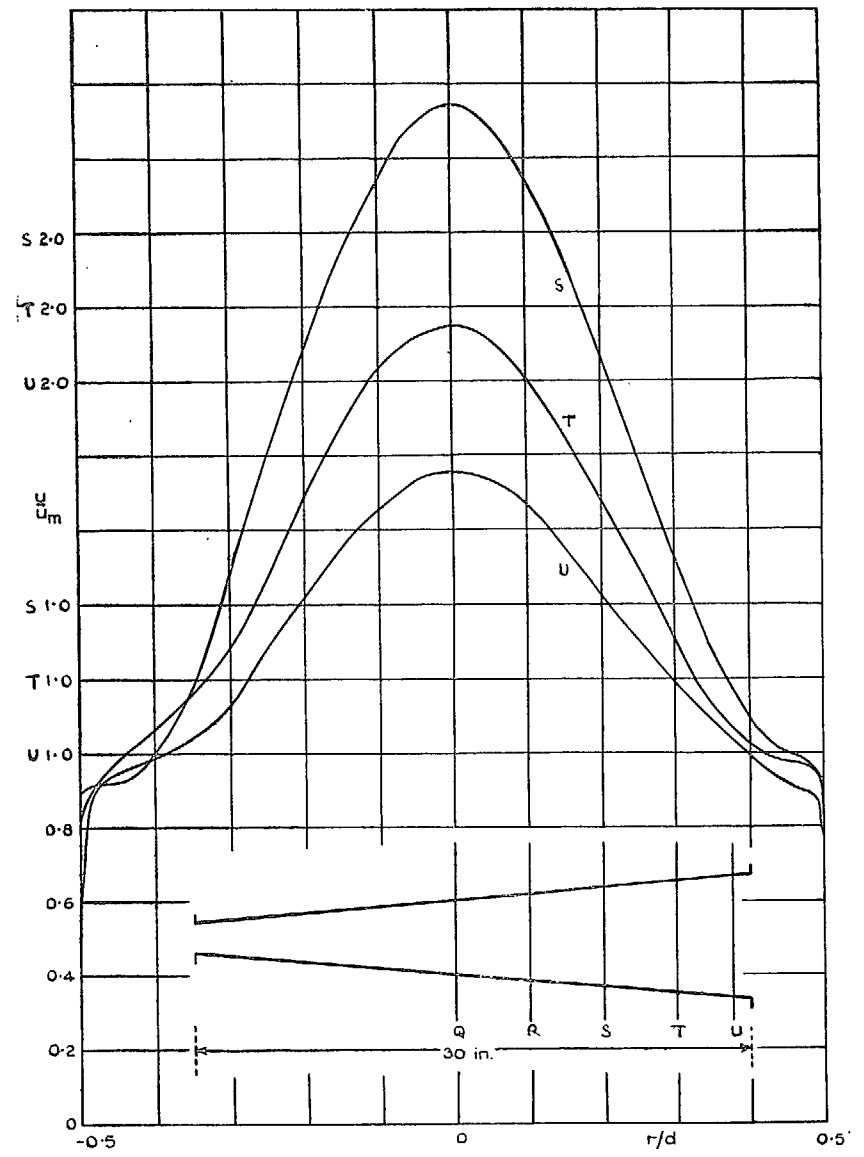

FIG. 16b. 10 deg cone. Velocity distributions.

B

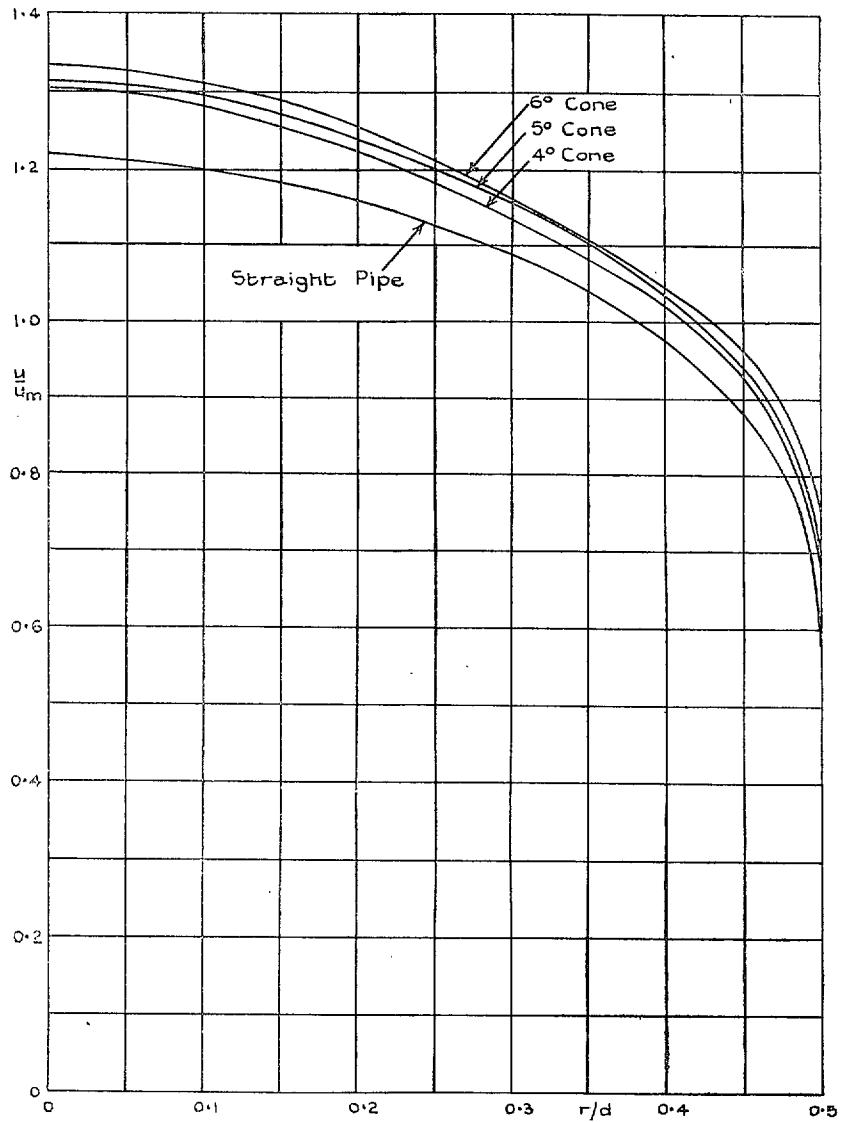

FIG. 17. Final velocity distributions.  $R = 1.1 \times 10^5$ .

## Publications of the Aeronautical Research Council

### ANNUAL TECHNICAL REPORTS OF THE AERONAUTICAL RESEARCH COUNCIL (BOUND VOLUMES)

- 1936 Vol. I. Aerodynamics General, Performance, Airscrews, Flutter and Spinning. 40s. (40s. 9d.)  
Vol. II. Stability and Control, Structures, Seaplanes, Engines, etc. 50s. (50s. 10d.)
- 1937 Vol. I. Aerodynamics General, Performance, Airscrews, Flutter and Spinning. 40s. (40s. 10d.)  
Vol. II. Stability and Control, Structures, Seaplanes, Engines, etc. 60s. (61s.)
- 1938 Vol. I. Aerodynamics General, Performance, Airscrews. 50s. (51s.)  
Vol. II. Stability and Control, Flutter, Structures, Seaplanes, Wind Tunnels, Materials. 30s. (30s. 9d.)
- 1939 Vol. I. Aerodynamics General, Performance, Airscrews, Engines. 50s. (50s. 11d.)  
Vol. II. Stability and Control, Flutter and Vibration, Instruments, Structures, Seaplanes, etc.  
63s. (64s. 2d.)
- 1940 Aero and Hydrodynamics, Aerofoils, Airscrews, Engines, Flutter, Icing, Stability and Control,  
Structures, and a miscellaneous section. 50s. (51s.)
- 1941 Aero and Hydrodynamics, Aerofoils, Airscrews, Engines, Flutter, Stability and Control, Structures.  
63s. (64s. 2d.)
- 1942 Vol. I. Aero and Hydrodynamics, Aerofoils, Airscrews, Engines. 75s. (76s. 3d.)  
Vol. II. Noise, Parachutes, Stability and Control, Structures, Vibration, Wind Tunnels.  
47s. 6d. (48s. 5d.)
- 1943 Vol. I. (In the press.)  
Vol. II. (In the press.)

### ANNUAL REPORTS OF THE AERONAUTICAL RESEARCH COUNCIL—

1933-34	1s. 6d. (1s. 8d.)	1937	2s. (2s. 2d.)
1934-35	1s. 6d. (1s. 8d.)	1938	1s. 6d. (1s. 8d.)
April 1, 1935 to Dec. 31, 1936.	4s. (4s. 4d.)	1939-48	3s. (3s. 2d.)

### INDEX TO ALL REPORTS AND MEMORANDA PUBLISHED IN THE ANNUAL TECHNICAL REPORTS AND SEPARATELY—

April, 1950 - - - - - R. & M. No. 2600. 2s. 6d. (2s. 7½d.)

### AUTHOR INDEX TO ALL REPORTS AND MEMORANDA OF THE AERONAUTICAL RESEARCH COUNCIL—

1909-1949 - - - - - R. & M. No. 2570. 15s. (15s. 3d.)

### INDEXES TO THE TECHNICAL REPORTS OF THE AERONAUTICAL RESEARCH COUNCIL—

December 1, 1936—June 30, 1939.	R. & M. No. 1850.	1s. 3d. (1s. 4½d.)
July 1, 1939—June 30, 1945.	R. & M. No. 1950.	1s. (1s. 1½d.)
July 1, 1945—June 30, 1946.	R. & M. No. 2050.	1s. (1s. 1½d.)
July 1, 1946—December 31, 1946.	R. & M. No. 2150.	1s. 3d. (1s. 4½d.)
January 1, 1947—June 30, 1947.	R. & M. No. 2250.	1s. 3d. (1s. 4½d.)
July, 1951. - - - - -	R. & M. No. 2350.	1s. 9d. (1s. 10½d.)

*Prices in brackets include postage.*

Obtainable from

## HER MAJESTY'S STATIONERY OFFICE

York House, Kingsway, London, W.C.2; 423 Oxford Street, London, W.1 (Post  
Orders: P.O. Box 569, London, S.E.1); 13a Castle Street, Edinburgh 2; 39 King Street,  
Manchester 2; 2 Edmund Street, Birmingham 3; 1 St. Andrew's Crescent, Cardiff;  
Tower Lane, Bristol 1; 80 Chichester Street, Belfast or through any bookseller.