



MINISTRY OF SUPPLY

AERONAUTICAL RESEARCH COUNCIL
REPORTS AND MEMORANDA

Royal Aircraft Establishment
4-DEC 1954
LIBRARY

Flight Trials of a Rocket-propelled Transonic Research Model: The R.A.E.-Vickers Rocket Model

Parts I to IV

By

The Staff of the Supersonics Division, Flight Section,
Royal Aircraft Establishment

Crown Copyright Reserved

LONDON: HER MAJESTY'S STATIONERY OFFICE

1954

PRICE 17s 6d NET

Flight Trials of a Rocket-propelled Transonic Research Model : The R.A.E.-Vickers Rocket Model

Parts I to IV

By

The Staff of the Supersonics Division, Flight Section,
Royal Aircraft Establishment

COMMUNICATED BY THE PRINCIPAL DIRECTOR OF SCIENTIFIC RESEARCH (AIR),
MINISTRY OF SUPPLY

*Reports and Memoranda No. 2835**

March, 1950

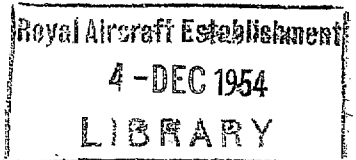

Summary.—The development of the gas turbine which provided large thrusts from comparatively small frontal areas, and at the same time retained its thrust efficiency at high speeds, introduced the possibility of building a supersonic aeroplane. Existing aeroplanes displayed marked longitudinal trim changes at high subsonic speeds, and to pursue these problems into the transonic field, problems which must be solved before the supersonic aeroplane can fly, the Royal Aircraft Establishment in 1945 embarked upon a programme of research using air-launched rocket-propelled models.

From the first conception of a simple model the research vehicle grew to a complex model aeroplane complete with auto-pilot, liquid-fuel rocket motor and radio telemetering equipment, air-launched at 36,000 ft over a ground radar station. The first model, complete with prototype equipment was lost in turbulent air. On the second model launched the rocket motor failed to ignite. There was a period of 12 months further development of the rocket motor and ignition system, followed by the launch in October, 1948 of the third complete model. This model flew satisfactorily and the flight is analysed in this report.

The model reached a maximum speed of $M = 1.38$. The static-pressure variations on the nose pitot-static-tube agree with available information, when allowance is made for the altitude change during flight. There is substantial agreement between measured thrust, longitudinal acceleration and drag, and the latter is in reasonable agreement with that predicted from wind-tunnel tests. The recorded tailplane angle agrees with that calculated from the instructions given to the auto-pilot, and with the predictions from wind-tunnel tests.

The main body of the report contains a historical review of the project, brief descriptions of the test vehicle and experimental techniques, and the detailed analysis of the final successful flight trial. In a concluding section the project is discussed critically; it is considered that the work done has shown the experimental method to be an exceedingly difficult one, and that the results it gives do not justify the effort it demands. No further developments are proposed, as alternative transonic research techniques have in the meantime been developed.

In a series of appendices are given detailed descriptions of the test vehicle and its ancillary equipment, of the development work leading up to the final trial and of the experimental equipment and techniques. These detailed appendices will be of interest only to the specialist.

* R.A.E. Report Aero. 2357, received 6th January, 1951.

PART I

Historical

By

J. SWAN

In the early part of the present decade, the absence of an engine capable of producing the necessary power from a sufficiently small bulk and weight, relegated thoughts of flight at supersonic speeds into the field of speculation.

When in 1943, however, information gleaned from German sources suggested that active consideration was being given to schemes for 1,000 m.p.h. aircraft, such reports, if somewhat alarming, were not regarded as fantastic, since they were coupled with reports of new fuels and methods of propulsion. At about the same time in Britain interest in supersonic flight with a somewhat less exalted target was so stimulated by the advent of the gas turbine that the Miles Company put forward a scheme for a supersonic aircraft, Ref. 1 (later known by Specification No. E.24/43). But the existence of such a proposal merely drew attention to our ignorance regarding flight conditions at and near the speed of sound, and to the need for research. Suggested research methods were the attachment of aerofoil surfaces to the tail of existing rocket missiles, the construction of a very high-speed rail track, and the dropping of heavy bodies from very high altitudes. With the gradual accumulation of knowledge it became clear that the E.24/43 was unlikely to reach sonic speed and when wind-tunnel model tests indicated the same serious loss of longitudinal stability at high subsonic speeds as was then characteristic of all existing aircraft (Ref. 6), the wisdom of continuing with this design was questioned. The decision was reached to acquire preliminary experience of flight under transonic conditions using rocket-driven pilotless scale models.

A contract was placed in 1945 with Messrs. Vickers Armstrong Limited for the design and construction of several such test vehicles. The first simple conception was to employ existing solid-fuel rockets, but to attain the desired speed the small size of the rocket available necessitated a multiplicity of units connected to a single venturi by an elaborate system of pipework. It was soon evident that such an arrangement required considerable development and several months were spent in a fruitless endeavour to obtain the necessary total impulse from two rockets only. With the default of the solid-fuel rocket, attention was directed towards the bifuel liquid type on which information was then coming to hand from investigation of German activities. The design was accordingly modified on the basis of an alcohol-hydrogen peroxide propulsion system. Provision was also made for an auto-pilot and a radio telemetering unit since the duration of flight was now such as to necessitate 2-axis control and the length of the flight path such that no other means of data recording was feasible. In this decision to use a liquid-fuel rocket lies the basic cause of the final abandonment of the project as a method of transonic research, for what had started as a simple test vehicle with a constructional time scale of weeks grew into a complicated aeroplane in miniature requiring months for manufacture, entailing corresponding complexity in preparation for a test flight and depending for test on the simultaneous serviceability of at least two aircraft, the model and the parent aircraft, a requirement which is known to cause serious delays and to absorb much effort. Responsibility for the development of the rocket motor, auto-pilot and telemetering gear devolved upon Ministry of Supply Establishments. Progress on the rocket motor was rather slow as experience with such motors had been acquired by only a limited number of personnel but detail work on the fuselage was even slower as the internal layout was dependent on various motor and auto-pilot details as yet unsettled.

Early in 1946 the contract for the E.24/43 was cancelled, since in addition to the adverse feature already mentioned there was now added a further unsolved difficulty—the impossibility of safe escape for the pilot in the event of an emergency bale-out at high speed (Ref. 7). The difficulties attending flight at sonic speeds appeared to be increasing with increasing knowledge. In these circumstances consideration of an improved version of the E.24/43 was discarded in favour of the pilotless models which for the initial try-out were to be 3/10-scale versions of the early full-scale design (Refs. 3 and 9). For drag and stressing reasons the operational altitude had to be in the stratosphere to which altitude the test vehicles would be carried by a parent aircraft.

The year of 1947 was one of delays and disappointments. During cold-chamber tests of the auto-pilot and control systems the wing was seriously damaged. A successful ground test of motor and fuel system was followed by a need for modification to the wing-aerial system to improve telemetering transmission. On the last check flight of the modified aerial the parent aircraft (a *Mosquito*) inadvertently descended into a storm cloud at 22,000 ft and was immediately thrown out of control. When smooth conditions were regained at about 8,000 ft altitude the test vehicle A1 carrying all the prototype examples of instruments and equipment was found, alas, to have parted from the aircraft and to have disappeared beneath the waters of the Bristol Channel.

In due course model A2 was ready at St. Eval aerodrome from which the parent aircraft was to fly to the nearby Scilly Isles launching area. In preparation for a launch on the morning of October 8th, 1947, the vehicle was fuelled overnight and slung under the *Mosquito* at an early hour. The discovery of a peroxide leak into the combustion chamber was followed by a hazardous but successful operation in which the P.V.C. (polyvinyl chloride) rupture discs in the oxidant lines were replaced while the vehicle was fully fuelled. Take-off was only slightly behind schedule but when released the test vehicle rolled on its back without any signs of control, the telemetering was deranged by a small explosion when the motor should have started and the model was destroyed shortly after by a major explosion. Later experience showed that failure of the two fuels to ignite spontaneously is characteristic of their behaviour at low temperatures and low pressures (Ref. 15). Laboratory tests hinting at such a feature were confirmed by releasing wingless versions of the test vehicle at various heights. Ignition at 35,000 ft was finally attained only by the use of an igniter torch which, by providing in the combustion chamber an intense flame on which the fuels impinged, enabled the all-important initial chemical combination to take place.

Finally on October 9th, 1948, model A3 was successfully launched, and this report is concerned primarily with this model and the analysis of its flight.

PART II

Test Vehicle and Experimental Technique

By

J. SWAN

1. *Test Vehicle.*—1.1. *Structure.*—The test vehicle (Fig. 1) as developed around a liquid-fuel rocket motor, 2-axis automatic control unit and radio telemetering equipment is shown in completed form in Fig. 2. (No external finish had been applied to the unit illustrated.) Fig. 4 is a view in partly assembled state in which motor ancillary parts, the auto-pilot and the 6-channel telemetering gear together with some of the instruments can be seen. This view also illustrates the type of construction—a central section of stressed skin on cylindrical Z- and U-shaped formers, to the front of which is attached a machined ogival nose forming the fuel tank and to the rear a similar shaped shell structure housing the tail unit and combustion chamber.

The centre-section is split on the centre-line to permit the insertion of the full-span mahogany wing above and below which are disposed the various units which have to be contained within the shell.

The test vehicle was a 3/10-scale model of the Miles E.24/43 design (except for the omission of the distinctive annular air intake of the full-scale aircraft). To maintain the c.g. in the correct relation it was necessary to include a large balance weight (almost 1/10th of total all-up weight) in the foremost section of the ogival nose. The layout was still further restricted by the need to maintain a constant c.g. position during the consumption of the fuels. This was achieved by disposing ahead of the wing a small tank holding approximately one-third of the total oxidant (as well as the fuel in the shaped nose tank) and locating the main oxidant tank aft of the wing. Other weighty components *e.g.*, high-pressure air vessels, were disposed two and two fore-and-aft of the wing as can be seen in Fig. 4.

In the space below and above the wing centre section (Fig. 5) were accommodated air, fuel, oxidant and warm-air pipes, telemetering transmitter with oscillators, instruments and batteries motor-starting air release, rupture disc and air-reducing valves (the latter for tank pressurisation), the auto-pilot with its air-reducing valves for gyro spin and servos, timing clock, wiring terminal-board fuses, aircraft detachable plug and lanyard change-over switch and the retracting lug by which the test vehicle was carried on the parent aircraft. As will be appreciated from assembly photographs (Fig. 5) a descriptive verb is squeezed.

The tapering rear section (Fig. 6) also of stressed-skin construction, housed the combustion chamber, radar transponder, smoke-producing fluid, instruments and oscillators for combustion-chamber pressure and tailplane angle, servos and dive mechanism for the tailplane which together with the fixed directional fin were assembled to the lower half-shell prior to adding the detachable formers and skin of the upper half.

Projecting from the nose was a standard pitot-static-tube suitably modified to permit a static hole position 6 diameters back.

The single-piece wing (Table 1) extending the whole span was of mahogany with Dural inserts at leading and trailing edges; it was of biconvex section and of tapered plan form with an unswept half-chord line. The Dural inserts formed a convenient dipole-aerial system for the telemetering unit. (A similar arrangement on the tailplane served the radar transponder.) Thirty per cent span ailerons were actuated from a single servo, mounted on the wing centre-section, through bellcranks and straight push-pull rods working in tunnels in the wing. These tunnels weakened the wing but this difficulty was circumvented by fitting stiffening plates to both the upper and lower surfaces for the whole of the span so affected.

The all-moving swept-back wooden tailplane with metal edge inserts similar to the wing was carried by two bearings bolted to the shell structure. Tailplane actuation was by two linked servos—one responsive to attitude and the other to height changes only. An interposed linkage included a timed cordite charge and a mechanism to dive the test vehicle into the sea at the end of the test by deflecting the tailplane to a predetermined positive incidence.

The various constructional features are described in detail in Appendix I.

1.2. *Rocket Motor*.—When the design of the rocket motor was undertaken practical experience of the working of such units and the handling of their fuels was almost non-existent in Britain. In these circumstances development of the motor was bound to be slow (Ref. 12) while various design simplifications from the basic Walter 109 design added their quota of new problems to be overcome, *viz.*,

- (a) replacement of the liquid-cooled combustion chamber by an uncooled refractory-lined unit resulted in persistent chamber failures—experience had to be gained in the fabrication of such units (Ref. 11);
- (b) deletion of all throttle gear and controlling the initial flow of fuels only by rupture discs was also responsible for failures of combustion chambers since these were subjected to very arduous conditions when starting under full fuel flows. To circumvent this starting difficulty, the flow of oxidant was temporarily restricted by soluble chokes immediately ahead of the burners (Ref. 16);
- (c) delivery of fuels by tank pressurisation instead of by centrifugal pumps created design difficulties. In the original design it was intended to contain the fuels in P.V.C. bags within the tanks and expel the fuel therefrom by the gases from a slow-burning cordite charge. This aim was not attained however due to manufacturing difficulties on the bags and an insufficiently developed cordite unit. The alternative finally adopted was to employ pressure air acting on the fuel contained directly within the metal tanks but this system proved heavy and extravagant of the limited space available even in spite of the adoption of a very high storage pressure.

Appendix I contains more precise details of the rocket motor and fuel systems while separate reports—dealing with difficulties in the development of the combustion chamber, the use of soluble chokes in fuel lines and the development of rocket motor generally—are referred to above.

1.3. *Auto-Pilot*.—The unexpected encroachment on the available space created a problem in the stowage of the auto-pilot. The only existing unit of suitable size was that employed in the German V1 missile but even this had to be tailored to suit by rearrangement of its components (*see* Appendix I for details). This was an air-driven instrument designed for low altitudes but the present application required it to function at 35,000 ft. Correct adjustment of the interconnected air jets for gyro drive and signal intelligence pick-offs was very critical and could be attained only by the operator carrying out the adjustments in a low-pressure chamber at the pressure corresponding to this altitude—a process exceedingly trying, both to patience and powers of endurance!

2. *Experimental Technique*.—2.1. *General*.—This experiment was characterised by a geographical dispersal of the centres of activity and a wide diversity of types of service required for its fulfilment. The former arose from the potential danger-area created on the ground by misbehaviour of the controls of a vehicle some six miles overhead, pushing the testing area away from centres of population to the vicinity of the sea-girt Isles of Scilly without however removing the necessity for a flying base on the mainland (*see* Appendix III). On the logistics side operation of aircraft away from home base involved a multitude of servicing and minor repair facilities: preparatory work on the test vehicle covered the use of wind tunnels (large open-jet, medium high-speed (Ref. 14) and small supersonic (Ref. 18)), a refrigeration chamber,

a low-pressure test chamber, a makeshift rocket test site with attendant safety precautions, and other diversions, *e.g.*, suspension of a model well clear of ground and metal reflecting surfaces to determine the polar diagram of a transmitting radio aerial. The island site bristled with radio gear (communications, telemetering and radar variations), much of which supported recording cameras in profusion. The test vehicle consumed large quantities of air which had to be transported at high pressure, released, dried, then pressed to a still higher pressure; was very fastidious regarding fuels which, being bad neighbours, had to be transported separately in special road tankers, be tended daily during storage and be handled only in the presence of ample quantities of protecting water (also transported); and required attendants equipped with a selection of contortionist spanners, long round-the-corner fingers and an unlimited supply of patience to surmount the assembly difficulties arising from the congested nature of its construction.

On the recording side, in addition to the diverse types of airborne and ground cameras, arrangements had to be made to cover the appropriate sections of a documentary film of the entire project made by the Crown Film Unit. In a project of this kind many of the shots could be taken only when the centrepiece, *i.e.*, test vehicle, was available, but usually this was then also in almost continuous demand for assembly or flight tests so that takes and retakes had to be fitted in whenever possible.

Quite apart from the special requirements of the test vehicle, the physical well-being of small test teams on remote sites constituted a not insignificant preoccupation.

2.2. *Test Sites.*—The Scilly Isles fulfilled almost all the test-site requirements and afforded an additional attraction in the form of a small wartime radar station containing serviceable G.C.I.* search gear. To supplement this there was added a short-range tracking radar of S.C.R. 584 type together with standard V.H.F. radio telephony for communication with the parent aircraft and also with the flight base at R.A.F. aerodrome at St. Eval (Cornwall) (*see* Appendix III and Fig. 34). This additional site on the mainland was needed because the island airfield was too small to accommodate aircraft of the *Mosquito* type. The Scilly Isles was also the location for the telemetering recording gear which, set up at a distance from the radar units to minimise interference, comprised receivers, decoding filters, amplifiers and display panel (Fig. 32). The meters on this panel, photographed by two cameras, indicated the average short-interval quantitative measure of the frequencies transmitted from the test vehicle: instantaneous variations were recorded on parallel equipment in which the spot deflections of six small cathode-ray tubes were focused on to a moving photographic strip thus producing a single continuous record of the six transmitted frequencies.

2.2.1. *Tracking.*—A record of the flight path of the test vehicle was obtained by photographing a range tube mounted adjacent to scales of azimuth and elevation attached to the 584 radar aerial. As the range of this radar unit could not cover the whole path the general heading and range of the vehicle during the latter part of its flight were recorded by cameras viewing the P.P.I.† and range tubes of the G.C.I. unit.

2.2.2. *Time history.*—For the purpose of data analysis it was essential to be able to correlate to a high time accuracy the events recorded by these cameras. This was done by arranging an additional camera to photograph on a continuously moving film the flashes of small gas discharge lamps triggered individually by the action of the shutter of each of the recording cameras (and also by a crystal-controlled timing unit producing accurate time intervals of 1/10 and 1 sec). From this timing unit also 5-sec 'pips' were superimposed on the wire recording of the aircraft crews' broadcast description of the behaviour of the vehicle immediately after launch.

* Ground Controlled Interception.

† Plan Position Indicator.

2.3. *Range Safety Precautions.*—One shortcoming of the Scilly Isles site was its proximity to important shipping lanes and fishing activities. Objection from these sources to the establishment of this test area were finally allayed by arrangements to issue warnings of impending trials—to the appropriate fishery authorities direct and to shipping generally by Admiralty Notice to Mariners. In addition, to ensure that on the day of a trial no ship was in the neighbourhood at the critical hour, the specified area was patrolled immediately prior to take off by a *Lancaster* aircraft from St. Eval. Thereafter this aircraft stood by during the test to provide emergency sea rescue facilities in the event of the *Mosquito* crew having to abandon their aircraft. The correct heading of the test vehicle at launch was assured by a controller at the radar site directing the approach path of the *Mosquito* in accordance with tracking information displayed on his plotting table. On this table the plan position of the *Mosquito* was indicated continuously by a spot of light derived via selsyn motor drives from instantaneous tracking values of range azimuth and elevation on the 584 radar.

2.4. *Ancillary Equipment and Tests.*—2.4.1. *Parent aircraft.*—The preparation of the *Mosquito* parent aircraft proceeded concurrent with the development of the rocket motor and manufacture of the first test vehicle (Appendix IV). The carriage of the vehicle was arranged to be external to the aeroplane with the exception of the tail fin which was buried within the bomb bay through a large slot cut in the bomb doors (Fig. 35). A cradle structure, slung from the existing strong points on the bomb-bay arch, steadied the vehicle in the correct position and provided an anchorage for the 12-pin electrical services plug, the starting switch pull-out lanyard, the gyro pre-spin air connection and the warm air ducts all of which had to 'break' cleanly without imparting to the vehicle any deviating load at release. The angle at which the vehicle was crutched on the aeroplane was the subject of tests in the 24-ft Open-Jet Wind Tunnel employing scale models of *Mosquito* and test vehicle. These tests showed that unless a nose-down attitude was adopted the test vehicle tended to float under the parent after release—a serious contingency with the caged-in disposition of the tail fin. Emergency jettison of this dangerous store was catered for by supporting the normal release unit from the unit existing in the bomb bay. Release could thus be effected by any one of four separate circuits—2 electrical and 2 mechanical. The release controls and other services for the test vehicle, while still on the *Mosquito*, were arranged on a panel mounted in front of the observer (see Fig. 36). As the aeroplane was very dependent on radio communication the V.H.F. installation was duplicated in its entirety.

2.4.2. *Rocket motor.*—The period of development of the rocket motor was protracted (Ref. 12) and when the first vehicle installation was finally completed a ground run was essential to check that the minor deviations from the test-bed set up had not impaired the rather 'touchy' starting characteristics of the motor (Ref. 12). This test was entirely satisfactory but illustrates the live-and-learn character of the technique since under trials conditions a longer interval after fuelling was unavoidable; this was not realized at this stage, nor its consequences appreciated. This ground test also provided an opportunity to examine the possible adverse effect on the telemetered signal of interposed hot gases from the rocket motor. No such effect was detected.

After this promising debut the completed shell was mounted in the 11-ft Wind Tunnel for stability tests at subsonic speeds (Ref. 14). As a result the directional fin area was augmented by the small dorsal addition illustrated in Fig. 2.

2.4.3. *Telemetering gear.*—At the time this experiment was initiated telemetering gear employing a V.H.F. carrier modulated by audio frequencies, related to physical quantities, was under active development (Ref. 4). Six audio oscillator units were employed (Appendix II), the tuned circuit of each including an inductance unit which, on being distorted mechanically, altered the frequency of the oscillator. These separate units (Fig. 3), housed where convenient in the test vehicle, were connected to the transmitter unit which radiated the six frequencies on a common 90 Mc/sec carrier through a dipole aerial formed by metal inserts embodied in the wooden wings of the vehicle. Fig. 3 depicts the transmitter unit, six oscillator units and associated instruments within which are the inductance units.

The receiving part of the equipment was located on the Scilly Isles site as mentioned in section 2.2 (see also Fig. 32). Both equipments are described in fuller detail in Appendix II and Ref. 4.

2.4.4. *Loss of vehicle A1.*—A cold-chamber test of control-surface freedom under representative altitude temperature conditions was organised by Messrs. Vickers. This test included also the functioning of the auto-pilot and servos since the latter were adaptations of a design intended primarily for low altitudes. The test was satisfactory but collapse of part of the test rig during dismantling of the test chamber damaged the wing beyond repair. Subsequent flight checks of the telemetering system necessitated alterations to the wing aerals to improve transmission efficiency. During clearance checks of these modifications the parent aircraft descended into a cumulo-nimbus cloud in an unexpected storm and test vehicle A1 was lost into the sea through failure of the suspension lug while the aeroplane was out of control. In keeping with the low factors on the rest of the vehicle this lug had been intentionally designed to fail at $4\frac{1}{2}g$ to ensure separation in such an emergency rather than risk danger to the parent aircraft through parts of the test vehicle becoming detached during an internal break-up. Delay ensued while the redesigned lug and the distribution of load to the structure were checked on a complete vehicle.

2.4.5. *Preparation for flight of vehicle A2.*—In due course vehicle A2 was delivered to St. Eval for handling by the trials team preparatory to flight. This period of activity included the establishment of the radio communications system with the Scilly Isles site (the range was greater than theoretically possible with the frequency employed), accumulation of experience of the functioning of the instrumentation in conjunction with the telemetering unit (a mobile calibrating van served also as the local telemetering checking station), and the development by the flight and Scilly Isles crews of the best flight routine.

Here a major difficulty arose in connection with the *Meteor* observation aircraft. The take-off time of *Mosquito* and *Meteor* had to differ by some 20 minutes because the rate of climb of the former was low near operational height and the fuel duration of the latter was strictly limited. It was found extremely difficult quickly to bring the two aircraft within sight of each other at 35,000 ft (even with radar assistance) unless atmospheric conditions were conducive to the formation of vapour trails. Means of producing artificial trails (standard smoke containers) were fitted to the *Mosquito*. After affiliation of the aircraft on the correct course was established a fresh difficulty was experienced. Whenever both aircraft came into the 584 radar beam at equal ranges the automatic tracking gear tended to follow the subsequent movements of the stronger echo, *i.e.*, from the *Meteor*, with the result that the all-important separation of the test vehicle from the *Mosquito* could occur unobserved. The solution adopted was for the *Meteor* to formate at such a distance that it was outside the radar beam when locked on to the *Mosquito*. This arrangement however prevented a sufficiently close view of the launching sequence being obtained and for later tests the use of the *Meteor* was discontinued and additional cameras installed in the parent *Mosquito* to cover the initial glide and motor starting.

2.5. *Launch of Vehicle A2.*—When the flight routine and ground assembly sequence had been rehearsed (except for fuelling) warning notices were issued for a trial on 8th October, 1947. For photographic reasons the operation was timed for the forenoon, and in order to provide some reserve time to meet unexpected emergencies the assembled vehicle was fuelled, weighed, c.g. position determined, etc., by the evening of 7th. A uniform temperature was maintained around the vehicle overnight and on the morning of 8th after filling the high-pressure air vessels it was hoisted on the *Mosquito*. During this operation it was discovered that peroxide was flooding the combustion chamber through a ruptured P.V.C. blanking disc situated in the peroxide lines immediately ahead of the burners. Prudence suggests such an occurrence should have caused a cancellation of the trial but it was decided that the need to gain experience in air launching and operation of the vehicle justified the replacement of the discs as an emergency operation. This hazardous proceeding was undertaken with the fuelled vehicle nose down to keep the peroxide

from flooding the scene of operations. The combustion chamber and head (a hydrazine annulus to which peroxide might have permeated back through the burners) were washed out with water and dried by an air blast. After replacement of the P.V.C. discs the assembled vehicle was ready for take-off about one hour behind original schedule.

Flight routine proceeded to plan, telemetering checks at 20,000, 25,000 and 30,000 ft were made simultaneously in the *Mosquito* and at the Scilly Isles on instructions from the controller, the *Meteor* took off and at 35,000 ft made correct contact west of Land's End after which both aircraft in formation were directed on course by the Scilly Isles controller. Except for a few hectic moments when the *Meteor* had to be sidetracked to check that the radar was tracking the *Mosquito* no untoward incident occurred. With motor ignition timed for 15 seconds after release test vehicle A2 was launched correctly but almost immediately rolled slowly on to its back, while the 15-second interval expired without any sign of the motor coming to life. At 19½ seconds however the *Meteor* pilot reported an explosion and the disappearance of the vehicle in the accompanying cloud. The path as determined by the radar corresponded roughly to a bomb trajectory and it became evident that the efforts of the previous months had ended in failure.

A reconstruction of events from telemetered signals, photographs and visual records suggested that the air pressure had not been applied to the servos, that the ignition sequence had occurred correctly but that delayed ignition had caused an explosion which deranged the telemetering gear and also the fuel system, resulting shortly afterwards in a major explosion which completely wrecked the vehicle.

2.6. Motor Starting Tests and Launch of Vehicle A3.—The feature of most interest in this unsuccessful trial was the failure of the motor to ignite, especially as concurrent laboratory tests (Ref. 15) had indicated an increasing delay in self-ignition of hydrazine and peroxide with decreasing ambient pressure, *i.e.*, increasing altitude.

This evidence was at variance with the results of a test during development of the motor when satisfactory ignition had been obtained in a combustion chamber, sealed by a thin disc, evacuated to 35,000 ft. A test of motor starting under actual flight conditions was therefore conducted by launching from the *Mosquito* a wingless fuselage complete with motor, the combustion chamber of which was sealed at ground-level pressure. This motor and a repeat unit failed to ignite. In these and all later tests the necessary delay in supplying the oxidant at starting was achieved by including in the supply lines chokes soluble in peroxide (Ref. 16). These choke units were arranged to house also the P.V.C. rupture discs, thus forming convenient units which could be checked for leakage, etc., immediately before assembly.

Further laboratory investigations indicated that lowering the temperature of the fuels also gave rise to increased ignition delay (Ref. 19). Check flight tests showed that after about 80 minutes flying, *i.e.*, towards the end of the manoeuvre period, the freezing temperature of peroxide (−22 deg C) was being approached at various stations in the peroxide lines (*see* Fig. 28). By modification of the warm air supply, by re-run of fuel lines and better positioning of existing heater (transponder dropper resistance) more satisfactory temperatures were achieved (Fig. 29). The functioning of the supply system was then checked by expelling from the fuel and oxidant tanks the carbon tetrachloride used for these tests.

With these modifications and an open combustion chamber satisfactory ignition and correct functioning of the motor was achieved on a starting test at 25,000 ft but when a repeat test was attempted at 35,000 ft an explosion occurred of sufficient violence to detach a large part of the rear of the fuselage.

It seemed clear that the spontaneous ignition characteristic of these two fuels was impaired at altitude and that the assistance of an igniter torch was desirable. After ground tests an existing electrically fired unit producing a flame some 18 in. long for a period of 3 seconds was mounted over the outlet of the combustion chamber on a spider necked to assist jettison. Using such a unit a satisfactory motor start was obtained at 35,000 ft first on a wingless fuselage and afterwards on instrumented test vehicle A3. The subsequent flight of this vehicle is analysed in Part III hereunder.

PART III

Analysis of the Flight of Vehicle A3

By

C. H. E. WARREN and C. KELL

1. *General Description.*—The general behaviour of the test vehicle was satisfactory. The *Mosquito* was flying at a Mach number of just less than 0.5 and at an altitude of 35,500 ft at the moment of release. At release the test vehicle fell away cleanly. After six seconds the rocket motor started; and at the same time the altitude servo of the auto-pilot was brought into operation. The test vehicle then accelerated smoothly on a straight, and more or less level, course, there being no indication of any appreciable rolling, yawing or pitching. The rocket burned for about a minute, the maximum speed attained corresponding to a Mach number of about 1.4, after which the test vehicle decelerated, but continued on course. There was evidence that the dive actuator came into operation after two minutes from release, but the amount of positive tailplane angle that was applied (about $\frac{1}{4}$ deg) was insufficient to dive the test vehicle, which continued on a westerly course out to sea. The test vehicle ceased to give a distinguishable echo on the G.C.I. after seven minutes when it was at a range of about sixty miles, but telemetered signals, interrupted by more and more noise, continued until about eight minutes after release when they ceased abruptly. There is no definite evidence of how far the test vehicle travelled, or where it finally hit the sea.

The S.C.R. 584 radar failed to track the test vehicle. After release the slant range of the test vehicle from the radar parabola decreased compared with the range of the *Mosquito*. To the radar operator this showed on the range tube as a weak echo emerging from the rear of the strong echo representing the *Mosquito*. When the rocket started and the test vehicle accelerated the difference in slant range between it and the *Mosquito* decreased, and soon the two echoes joined up again. At this moment there was not a sufficient difference between the elevations of the test vehicle and the *Mosquito* for the radar to be able to discriminate between them, and the radar subsequently locked on to the stronger echo of the *Mosquito*. There are therefore no radar tracking results of the flight of the test vehicle, although there are radar results of the track of the *Mosquito*, with the test vehicle aboard, up to the moment of release. A rough track of the flight of the test vehicle, however, was obtained from the G.C.I. record.

Information was obtained on all six telemetering channels, interrupted by occasional noise, and from these records the main analysis of the flight of the test vehicle was obtained. However, there is an uncertainty about the telemetered results, owing to the possibility of 'drift', which shows itself as a more or less constant error in the audio frequency corresponding to the quantity being telemetered—a zero error, in fact. In some cases it is possible to assess the amount of this error at some point, and, assuming that the error in cycles is constant over the whole band width, a fairly reliable record can be obtained. In other cases where no such check can be made, there is a doubt in the absolute value of the results, but the relative values enable qualitative results to be obtained. The quantitative and qualitative accuracy of the various results will be discussed as they occur in the sections which follow.

2. *Speed Attained.*—The variation of the speed of the test vehicle during the flight is shown in Fig. 7, and was obtained in two different ways which give good agreement.

The release speed itself was first determined in two ways—the true air speed (482 ft/sec) being deduced from the readings given by the *Mosquito's* air-speed indicator, altimeter and air thermometer; and the ground speed (445 ft/sec) coming from a differentiation of the radar track of the flight path of the *Mosquito*. When an allowance is made for a head wind of 25 ft/sec as given by meteorological observations at about the time of release, the agreement is seen to be reasonable.

To obtain the subsequent variation in speed after release, the computed increments of speed, obtained from integration of the telemetered longitudinal acceleration, were added to the release speed. The speed history so obtained was subject to error owing to possible drift in the telemetered longitudinal acceleration. The effect on speed would be to give an error that would progressively increase during the flight, being zero at release. Such an error was allowed for by making the horizontal distance travelled, as given by integration of the computed speed, agree with the horizontal distance travelled as given by the G.C.I. record. Such correction should make the drift error small during the initial stages of the flight, and it should become appreciable only as the time from release increased.

A check on the subsequent variation in speed after release was also obtained from the telemetered pitot and static pressures. Here again there was the possibility of errors owing to drift in the telemetered quantities, but they were allowed for by making the values just after release agree with the values derived from the known speed and altitude of the *Mosquito* at the moment of release. One further piece of knowledge was required, however, and that concerned the position error on the static pressure, the deduction of which will be considered in section 4.

The speed histories obtained in the two ways are in very good agreement except at the end of burning and just after, when the speed as computed from the pitot and static pressures is about 4 per cent greater than that computed from the longitudinal acceleration. The discrepancies which exist are probably explained largely by the fact that no correction was applied to the longitudinal accelerometer record to allow for the effect of the component of gravity when the test vehicle was not at zero attitude. Naturally, at the time of the first computation of the velocity the variation of the attitude during the flight was not known, and as subsequent computation showed that there was some doubt about the accuracy with which the attitude could be obtained (*see* section 7) no retrospective computation of the speed from the longitudinal accelerometer record was made. The evidence suggests that the corrections, if applied, would tend only to increase the speed by a small amount at one instance and reduce it at another, without affecting the general variation with time. The maximum correction to the longitudinal acceleration would be of the order of $0.1g$, and corrections of this order should strictly be applied from 80 seconds after release onwards, when there is evidence (*see* Fig. 18) that the test vehicle was pitching appreciably. This pitching probably explains the kicks in the longitudinal acceleration record from 80 seconds onwards shown in Fig. 8. However, any corrections would not alter the speed by more than 2 per cent, and as the effects on the aerodynamic quantities of a speed error of this order are very much less than the possible errors in the quantities which are considered below, it is considered that the agreement shown by Fig. 7 is sufficient.

It will be observed that the maximum speed of the test vehicle occurred about 62 seconds after release, and was about 1,350 ft/sec, corresponding to a Mach number of about 1.4.

3. *Flight Path*.—The probable flight path of the test vehicle is shown in Fig. 9. Photographic and visual observations and the G.C.I. trace had indicated that the test vehicle had flown on a straight course, confirming that the flight could be considered as occurring in one vertical plane. The flight path was obtained from double integrations of the telemetered longitudinal and normal accelerations.

The double integration of the corrected horizontal acceleration can be accepted as fairly accurate, because, when corrected as mentioned in section 2, the first integration gives good agreement on speed with that from the telemetered pitot and static pressures.

The double integration of the normal acceleration, however, is of appreciably less accuracy. In the first place there were considerable oscillations in normal acceleration, both regular and abrupt, as shown in Fig. 18. For the purposes of integration a mean curve was drawn through the more regular short period oscillations. In addition there existed the possibility of errors owing to drift in the telemetering equipment. Here again, owing to the additive nature of integration, the effect on the flight path would be to give an error that would progressively increase during the

flight. The assumption that was made in order to allow for this possible error was that, when the test vehicle was flying at not too low supersonic speeds, the position error on the static pressure was zero. The argument for this is discussed in section 4, but this assumption did enable the altitude of the test vehicle between, say, 40 and 70 seconds after release, to be determined from a knowledge of the static pressure. This in turn was sufficient to enable the error due to drift in the telemetered normal acceleration to be determined, and hence the complete flight path was obtained.

The disturbing feature, however, was that the amount of drift that was implied was considerably more than one would expect from purely electrical causes, even although the frequency channel used for telemetering normal acceleration was the one most subject to drift. There may have been some other cause of error that was showing itself as 'drift', but naturally the matter cannot be investigated, and one can but accept the result obtained as the most probable record of the flight path. There are, however, two points which suggest that the probable flight path, as shown in Fig. 9, may not be far from the truth.

In the first place there is fairly good qualitative agreement, between the flight path as shown in Fig. 9 and the observations given in the table below, which are from the observer's commentary on the flight of the test vehicle as he saw it from the parent *Mosquito*.

Extracts from the Commentary by the Observer in the Mosquito during the Flight of the Test Vehicle

Time after release (sec)	Remarks
10	It's going away nicely, straight and level
15	It's gone away dead level
30	She is probably climbing a bit, I don't know
75	It's climbing up now, definitely climbing
80	Going up like a rocket
85	Yes, its climbing
90	Must have got back to our height now, or above

The second point is that, assuming that the altitude as shown in Fig. 9 is correct, it is possible to determine the variation of local static pressure during the flight, and hence, by comparing it with the measured static pressure, to obtain the position error. This is done in section 4, and the result it leads to is that the position error at a certain Mach number obtained whilst the test vehicle is accelerating, agrees fairly well with the position error at the same Mach number during deceleration, and the variation with Mach number is in qualitative agreement with theory.

Neither of the two points mentioned above can be said to confirm the curve of Fig. 9, but at least they do not conflict with it, and the flight path as shown in Fig. 9 has therefore been used in later calculations.

4. *Static Pressure*.—The variation of the static pressure as measured during the flight is shown in Fig. 11. The most striking features of the curve are the sudden drop in static pressure at about 33 seconds after release, and the sudden increase at about 76 seconds after release. At these times the test vehicle was flying at a Mach number of about 1.10, and the sudden changes in pressure are explained by the passage past the static holes of the bow-wave which forms at infinity ahead of the body at a Mach number of unity, and which gradually moves nearer to the body at higher Mach numbers, until at a Mach number of about 1.6 it would attach itself to the nose of the body. The pressure ratio across the sudden changes (about 1.25 to 1) agrees with the theoretical pressure ratio across a normal shock at a Mach number of 1.10, and the distance of the static holes ahead of the body (about 0.19 body diameters) agrees with the estimated position of the bow-wave ahead of such a body at that Mach number.

Between the times given above (33 and 76 seconds after release) we can assume that the body bow-wave is behind the position of the static holes, and that the static holes are therefore in an air stream undisturbed by the presence of the test vehicle. The air stream is however disturbed by the presence of the pitot-static head itself, but it will be assumed that at the distance that the static holes are behind the nose of the head (six diameters) the static pressure can be considered as equal to that of the air stream. Between 33 and 76 seconds after release we can therefore assume that the measured static pressure gives the true static pressure—*i.e.*, that the position error is zero. From a knowledge of the true static pressure we can deduce the altitude of the test vehicle, and this was done in section 3 to provide a check on the altitude as computed from the normal accelerometer readings.

Up to 33 seconds after release, and from 76 seconds onwards, the probable true static pressure was deduced from the altitude, as mentioned in section 3, and is shown by the broken line in Fig. 11. It is therefore possible to calculate the position error, or difference between true and measured static pressures, over the speed range. The result is shown in Fig. 12, where the static pressure, expressed as a coefficient, is plotted against Mach number. As the static-pressure coefficient is obtained from the difference between two quantities of roughly the same order of magnitude, it is subject to a probable error of about 0.02, and to this order of accuracy there was no difference between the static-pressure coefficient at a certain Mach number obtained whilst the test vehicle was accelerating and the value obtained at the same Mach number during deceleration.

As always occurs in flight, curves showing the variation of a quantity with Mach number involve in addition a change in the lift coefficient, owing simply to the change in lift coefficient with forward speed (*see* Fig. 16). In order to separate the effects due to changes in Mach number and in lift coefficient, Fig. 12 shows in addition a curve giving the static-pressure coefficient, deduced from low-speed wind-tunnel tests (Ref. 14) at the lift coefficient corresponding to each Mach number. In other words, the low-speed wind-tunnel curve of static-pressure coefficient against lift coefficient, C_L , is here shown plotted against Mach number, M , by correlating C_L with M by the formula

$$C_L = \frac{nW}{\frac{1}{2}\gamma\phi M^2 S}$$

where

- W is Weight of the test vehicle
- n Normal acceleration
- S Wing gross area
- ϕ Ambient pressure
- γ Ratio of the specific heats for air.

At a Mach number of about 0.5, when compressibility effects are small, the curves are in fair agreement, and the difference between the curves at higher Mach numbers illustrates the large effects due to compressibility. The general shape of the curve is the same as that obtained by other experimenters for pitot-static heads extending forward of bodies.

5. *Thrust*.—The variation of combustion-chamber pressure as measured during the flight is shown in Fig. 13, and the general fall-off in pressure with time agrees fairly well with the fall-off measured during a ground run (Refs. 12 and 13). The thrust during the flight was estimated from the calibration made during the ground run, an allowance being made for the difference in combustion-chamber pressure and back pressure between flight and the ground run, as shown in Fig. 14. It will be observed in Fig. 13 that there were two appreciable kicks in the record of combustion chamber pressure at about 26 and 54 seconds after release respectively, and the fact that Fig. 8 shows corresponding kicks in the record of longitudinal acceleration, suggests that for some reason there were corresponding transient increases in thrust at these times. An estimate of these transient increases was made from the magnitude of the kicks in combustion-chamber pressure, and the result is shown in Fig. 14.

6. *Drag*.—From a knowledge of the thrust of the rocket, shown in Fig. 14, the weight of the test vehicle, which decreased linearly from 937 lb at the start of burning to 663 lb at the end, and the longitudinal acceleration, shown in Fig. 8, the drag of the test vehicle during the flight was determined. It is shown in Fig. 15 as a curve of drag coefficient against Mach number. A curve of lift coefficient against Mach number is shown in Fig. 16.

The agreement in the values of drag coefficient obtained during acceleration and deceleration is fair only, and this is probably due to the lower accuracy of the results during the deceleration period owing to the uncertainty regarding when, exactly, the rocket ceased burning.

Also shown in Fig. 15 is a curve deduced from low-speed wind-tunnel tests (Ref. 14), and drawn, as in the manner described in section 4, to show how much of the drag is due to compressibility. Up to a Mach number of about 0.7 the drag coefficient is relatively high, due to the large induced-drag component (*see* Fig. 16 for lift coefficient), but there is good agreement between flight and wind-tunnel tests. Above a Mach number of about 0.8 the drag coefficient measured in flight is appreciably greater than the low-speed value, increasing to as much as five times the incompressible value at supersonic speeds.

The curve of lift shown in Fig. 16 is intended only to give a rough indication of the average lift variation. It was deduced from the normal acceleration, shown in Fig. 18, by drawing a mean curve through the more regular short-period oscillations, so that the actual lift at any instant fluctuated about this mean curve quite considerably.

7. *Longitudinal Trim*.—The variations of tailplane angle* and normal acceleration during the flight are shown in Figs. 17 and 18 respectively. The tailplane angle shown in Fig. 17 is as recorded, but the normal acceleration shown in Fig. 18 has been corrected for telemetering drift as explained in section 3. The measured values of tailplane angle during the first six seconds after release must, however, be incorrect. The record showed the angle to be steady at $\frac{3}{4}$ deg until six seconds after release and then in less than a second the angle to have changed to about -2 deg. Such a sudden change would certainly have caused a change in trim, and hence one would have expected some kick in the normal acceleration at this time, but, as Fig. 18 shows, no such kick occurred, and one can but conclude that the sudden change in tailplane angle is therefore spurious. The explanation is probably that the push-rod, which indicated the angle of the tailplane (Appendix I section 1.3) had stuck in a position not in contact with the tailplane, and then came unstuck. This explanation is supported by the fact that the tailplane angle record was rock steady until six seconds after release, whereas one would have expected that the tailplane was oscillating during this period, particularly before release when there was no air pressure in the servos. The reason why the push-rod eventually came unstuck is probably associated with the starting of the rocket motor, which would no doubt cause a sudden kick, etc., sufficient to free the push-rod.

Superimposed upon the general variations in tailplane angle and normal acceleration were many oscillations and kicks. The most striking feature of the two curves shown in Figs. 17 and 18 are the regular oscillations which occurred on both curves from 35 seconds to 75 seconds after release, the frequency of these oscillations being shown in Fig. 19. The oscillations, which commenced when the Mach number was about 1.14 and finished when the Mach number was about 1.11 (*see* Fig. 20) are attributed to the normal short-period oscillation, which was calculated to be of about this frequency at supersonic speeds, and which it had been feared that the auto-pilot might tend to augment.

It will be noticed also that a particularly severe kick occurred in the record of normal acceleration at about 83 seconds after release (Fig. 18), and was due to a sudden decrease in tailplane angle of about half a degree causing a change in attitude. In the absence of a reliable knowledge of the variation of attitude during the flight, however, it is not possible to explain fully the reasons for this and other kicks in the record.

* The tailplane angle was measured relative to the body centre-line.

From the instructions given by the auto-pilot to the tailplane it is possible to obtain a check on the tailplane angle record. The auto-pilot alters the tailplane angle according to the following law (see Appendix I, section 3.1).

$$\eta = 0.22\theta + 0.033\dot{\theta} + \Delta h - 1$$

where

η is Tailplane angle, in degrees, relative to the fuselage datum

θ Attitude of the fuselage, in degrees, relative to the attitude at the moment of uncaging the gyros

$$\dot{\theta} = \frac{\partial \theta}{\partial t}$$

Δh Increase in altitude of the test vehicle, in thousands of feet, over the altitude at the moment that the altitude servo came into operation (6 seconds after release).

The term $\dot{\theta}$ is small and is ignored in the following calculation.

The flight-path angle and change in altitude can be estimated from the flight path shown in Fig. 9. The incidence of the test vehicle, and hence the attitude, can be estimated roughly from a knowledge of the variation in lift coefficient during the flight, shown in Fig. 10. It will be remembered that the curves of Figs. 9 and 10 were based on a mean curve through the fluctuating normal acceleration record of Fig. 18, and so estimates from these curves are only rough. The presence of the factor 0.22 and the fact that Δh is in thousands of feet do, however, tend to reduce the possible errors. One may not be correct, however, in equating the estimated values of θ and Δh with the values as understood by the auto-pilot. θ was measured by the pitch gyro, the horizontal datum being the attitude of the body at the moment of uncaging the gyros, when, according to the flight calculations, the attitude of the body should have been zero. From the speed and flight path of the *Mosquito* at the moment of uncaging (two seconds before release) it is estimated that the body may have been 1 or 2 deg nose-up. Δh , on the other hand, was obtained from an altimeter, which recorded the air pressure within the body. Naturally this was a far from precise method of measuring altitude, because the pressure inside a body in flight is usually appreciably less than the ambient air pressure owing to leaks, etc. This point must, therefore, be borne in mind.

The comparison of the tailplane angle computed from the formula of auto-pilot instructions, given above, with a mean curve through the fluctuations of Fig. 17 is shown in Fig. 21. Two computed curves are shown for comparison with the measured curve. One curve is based on the assumption that the pressure in the body is equal to the ambient air pressure, and that the altitude as understood by the auto-pilot is, therefore, correct. The agreement is seen to be poor, and it is suggested that it is due mainly to the pressure in the body being less than ambient, as mentioned above. Naturally, it is not possible to estimate, in retrospect, the pressure in the body in the vicinity of the height servo inlet nor how this pressure would vary with speed through the transonic range. All that one can do at this stage is to make the simplest possible assumption as to the variation of the internal air pressure with forward speed, and then to see whether a reasonable pressure difference is sufficient to explain the discrepancy. The other computed curve in Fig. 21, therefore, is based on the assumption that the pressure in the body is less than the ambient air pressure by $0.07 \times \frac{1}{2}\rho V^2$, and that the auto-pilot accordingly imagines that the test vehicle is at a greater altitude than it really is. It will be seen that this crude assumption of $0.07 \times \frac{1}{2}\rho V^2$ brings the computed and measured curves into much better agreement, bearing in mind that the order of accuracy of measuring or computing tailplane angle is about 0.2 degrees. The good agreement has been obtained, admittedly, by the arbitrary assumption that the air pressure in the body is less than ambient by $0.07 \times \frac{1}{2}\rho V^2$, but a pressure difference of this order is considered to have been a possible one. The purpose of the comparison of the computed and measured tailplane angles can, therefore, be considered as having been achieved namely, that the measured values are not inconsistent with the instructions that the auto-pilot gave, bearing in mind the order of accuracy (± 0.2 degrees) and the unknown difference between the true

altitude and the apparent altitude as understood by the auto-pilot. A curve of this apparent altitude (based on the $0.07 \times \frac{1}{2}\rho V^2$ assumption) is shown for comparison with the assumed true altitude in Fig. 9. This agreement between measured and computed tailplane angles lends support to the assumption already made namely, that the measured values as recorded are correct, *i.e.*, that there was no frequency drift on the channel used for telemetering tailplane angle. This channel was known to be the least subject to drift, and it will be shown below that further evidence is provided by the fact that the measured angle agrees well with wind-tunnel results.

Fig. 22 shows the mean measured tailplane angle, given in Fig. 21, plotted against Mach number. Fair agreement is obtained between the curves for the test vehicle accelerating and decelerating. As always occurs in flight, curves showing the variation of a quantity with Mach number involve in addition a change in the lift coefficient, owing simply to the change in lift coefficient with forward speed (*see* Fig. 16). In order to separate the effects due to changes in Mach number and in lift coefficient, Fig. 22 shows in addition a curve giving the tailplane angle to trim, deduced from low-speed wind-tunnel tests (Ref. 14) at the lift coefficients corresponding to each Mach number, as in the manner described in section 4. The flight curve agrees well with the wind-tunnel curve up to a Mach number of about 0.9. Between Mach numbers of 0.9 and 1.15 the flight curve shows a more positive tailplane angle than would be deduced from the low-speed wind-tunnel tests, which were made, effectively, at incompressible speeds. Above a Mach number of 1.15 the flight curve shows a more negative tailplane angle than would be deduced from the low-speed wind-tunnel tests, and this is probably due to the more rearward position of the aerodynamic centre of the wing at supersonic speeds. It will be noticed that the flight curve gives good agreement with tailplane angle to trim deduced from a supersonic wind-tunnel test at a Mach number of 1.4 (Ref. 18).

PART IV

Discussion of the Experiment

By

J. SWAN and C. H. E. WARREN

1. *General.*—Type A test vehicle dealt with in Parts I to III was intended as the first of a number of types having different wing plan-forms, etc. (Refs. 8, 9, 10). This programme was not continued beyond the flight of vehicle A3 and it is pertinent here to indicate the reasons for the abandonment of the programme, to assess the acquired experience and to review the results obtained.

2. *Abandonment of Programme.*—As originally conceived the experiment was intended as an investigation into problems of flight at transonic speeds—firstly to explore the possibility of flying through the speed of sound in level flight and secondly to obtain aerodynamic information not obtainable by other means. Due to the complex nature of the test vehicle progress in its construction was much slower than anticipated and by the time the technique had been established a piloted aeroplane in U.S.A. had flown at sonic speed and thus achieved the primary aim. While the difficulty of the pilotless model technique was becoming increasingly evident other work making use of solid-fuel rockets similar to those of the original proposal was demonstrating that the desired information could be obtained for much less effort, at a greater rate and with better accuracy. This latter work was conducted from ground level whereas the pilotless vehicle needed an aircraft to transport it to operating height. The difficulties inherent in the latter technique were demonstrated by the 12 months' interval between vehicles A2 and A3 during which time the aerodynamic aspect of the work was at a complete standstill while a functional difficulty with the test gear was being overcome. By the time A3 was ready for its flight a decision had been made to wind up the experiment in favour of other work.

3. *Experience.*—A considerable amount of experience and 'know how' in the flying of pilotless vehicles was accumulated during the period but this was largely thrown away with the cessation of this type of work. As already indicated the test vehicle was too complex a tool for repetition tests and the trials up to that date had been only exploratory ones in which experience was being gained with components such as rocket motor, telemetering gear and auto-pilot functioning under conditions for which a pre-test was not possible. In addition the employment of aircraft in an essential but ancillary role and the conduct of the whole operation away from the home base added greatly to the difficulties. That these difficulties had been surmounted for the most part was demonstrated by the completely successful flight of vehicle A3 which, while an appropriate swan song, also accentuated the cumbersome and uneconomic nature of the technique in which months of effort were required for an active vehicle life of only 100 seconds.

The experiment afforded first-hand experience in the handling of hydrogen peroxide under field conditions and drew attention to an otherwise unknown shortcoming in the use of peroxide at altitude. Previous German experience was not relevant since ignition was established at ground level and the time of flight was not long enough for low temperatures to be attained in the fuel system.

High concentration hydrogen peroxide has great incompatibility with all metals except pure aluminium and to a lesser extent stainless steel. Fuel-system pipes in aluminium were satisfactory on first assembly but the soft metal suffered local deformation on nipples and union threads with the result that liquid-tight joints could not be assured on subsequent repeat assembly.

Operating experience with telemetering gear confirmed previous conclusions that a lengthy period of flight under cold conditions caused a drift in audio-oscillator frequency. The enclosure of oscillators in felt-lined containers mitigated the effect, but later work showed that the inductance units also contributed and required doctoring individually to overcome this deficiency.

4. *Summary of Results obtained from the Flight of Vehicle A3.*—As only one successful flight test was made there is little aerodynamic information of note. Satisfactory agreement was obtained with wind-tunnel tests on drag coefficient (Fig. 15), tailplane angle to trim (Fig. 22) and on static pressure at the position of the static of the pitot-static head (Fig. 12).

The drag results in themselves are of little interest because no breakdown is possible. Interest in these results would have arisen when wings of other plan forms, etc., were tested. Likewise the results on tailplane angle to trim would have been much more valuable had a further test vehicle been flown with a different position of the centre of gravity, as then it would have been possible to determine the static margin. As it is the results do no more than show the drag rise and the nose-down change of trim which occur at transonic speeds.

The static-pressure results (Fig. 12), however, repeat a warning that should be taken in future transonic flight experiments. Owing to the short length of the pitot-static head the static pressure measured at the static holes was greater than the free-stream static pressure by about 0.3 times the free-stream dynamic pressure at transonic speeds. In order to keep the pressure variations to less than, say, 0.05 of the free-stream dynamic pressure a position for the static holes some two or three body diameters ahead of the nose is indicated.

5. *Acknowledgements.*—The authors gratefully acknowledge the contributions to the project of Messrs. Vickers Armstrong who designed and built the structure of the test vehicle.

REFERENCES

<i>No.</i>	<i>Author</i>	<i>Title, etc.</i>
1	C. M. Fougere and R. Smelt	Notes on the Miles supersonic aircraft (preliminary version). R.A.E. Tech. Note Aero. 1347. December, 1943.
2	K. G. Winter and M. E. Morgan	Wind-tunnel tests on the Miles E.24/43. Part I. R.A.E. Report Aero. 1959. July, 1944.
3	C. M. Fougere	Further note on the Miles supersonic aircraft (E.24/43). R.A.E. Tech. Note Aero. 1470. July, 1944.
4	B. A. Sharpe	Programme of development on radio telemetering at R.A.E. R.A.E. Report Radio S.5984. January, 1945.
5	I. Levacic, W. S. D. Marshall and A. D. Young	No. 2 11½-ft Wind-tunnel tests on a quarter-scale model wing of the Miles E.24/43 aircraft. R. & M. 2404. July, 1945.
6	S. P. Hutton and H. E. Gamble	High-speed wind-tunnel tests on an aircraft designed for supersonic speeds (Miles E.24/43). R. & M. 2404. July, 1945.
7	W. S. D. Marshall	Model tests on the Blower tunnel on the emergency escape of a pilot from a high-speed aircraft (Miles E.24/43) and hood jettisoning tests. R.A.E. Tech. Note Aero. 1727. November, 1945.
8	Staff of Gas Dynamics Department, R.A.E.	The use of rocket-propelled flying models for experiments at transonic speed. A.R.C. 9697. June, 1946. (Unpublished.)
9	F. Smith	Programme of aerodynamic tests on free flight models (Vickers rocket-propelled models and dropped bodies). A.R.C. 10,032. August, 1946. (Unpublished.)
10	Staff of Supersonics Division	Note on future rocket-propelled supersonic models. A.R.C. 10,577. March, 1947. (Unpublished.)
11	L. W. Broughton, R. J. Newton and A. Dick	Development of combustion chamber for the Alpha rocket motor. A.R.C. 10,697. March, 1947. (Unpublished.)
12	Barker	Development of Alpha rocket motor propellant system for the Vickers transonic model aircraft. R.A.E. Report Aero. 2215, S.D.22. July, 1947.
13	F. W. David	Analysis of a test run of the Alpha rocket motor. A.R.C. 10,984. July, 1947. (Unpublished.)
14	J. G. Ross and F. W. Kirkby	Wind-tunnel tests on the Vickers transonic rocket-propelled Model (No. 1). A.R.C. 11,413. December, 1947. (Unpublished.)
15	A. R. Hall and R. C. Murray	Ignition delay of bifuel mixtures at sub-atmospheric pressure. A.R.C. 11,247. December, 1947. (Unpublished.)
16	A. Dick and R. C. Murray	Tests on soluble chokes suitable for regulating hydrogen peroxide flow to a rocket motor. A.R.C. 11,535. March, 1948. (Unpublished.)
17	A. G. Mazurkiewicz and R. C. Murray ..	Ignition delay of some hydrazine hydrate/hydrogen peroxide propellants. A.R.C. 11,572. March, 1948. (Unpublished.)
18	J. R. Anderson, P. J. Herbert and H. Eggink	Wind-tunnel tests at a Mach number of 1.4 of a rocket-propelled transonic pilotless aircraft. A.R.C. 11,597. April, 1948. (Unpublished.)
19	A. R. Hall and R. C. Murray	Further experiments on behaviour of self-igniting bi-propellants at sub-atmospheric pressures. A.R.C. 12,174. October, 1948. (Unpublished.)

APPENDIX I

Description and Development of the Test Vehicle

By

E. SIMPSON and J. SWAN

1. *Description of the Test Vehicle.*—1.1. *Fuselage.*—The fuselage of the test vehicle is shown diagrammatically in Fig. 23. It was circular in section, 18-in. diameter and consisted of a Dural shell bolted to light alloy formers. The ogival nose carried a modified Mark VIII pitot-static head and was formed of a balance weight and a cast magnesium fuel tank. Mounted on the rear of the fuel tank was a magnesium alloy ring which partially enclosed the spherical forward oxidant tank and by providing the anchorage for the front of the parallel Dural shell, formed the junction between this and the ogival nose. The forward oxidant tank, having a central duct for wiring, etc., was supported from the magnesium nose ring by brackets welded to the tank. Other brackets welded to the rear of the tank carried two of the three toroidal air bottles for the rocket motor.

To the rear of the toroidal air bottles the wing was carried between two cast shoes which were bolted to specially strengthened double formers. These double formers also carried the retracting suspension lug which was positioned on the fore-and-aft centre of gravity of the test vehicle.

Mounted on the upper surfaces of the wing was the auto-pilot and control mechanism, while in the fuselage beneath the wing were the telemetering transmitter and oscillators, accumulators, pitot and static pick-offs, starting valve and other rocket-motor components.

To the rear of the wing, the second magnesium oxidant tank was mounted by means of welded brackets bolted to specially strengthened fuselage formers. Other brackets welded to the front and rear of the tank carried the remaining toroidal air bottles. Like the forward tank, the rear one was provided with a central duct for the passage of wires and pipes.

The tail section was bolted to the strengthened formers which carried the rear oxidant tank and consisted basically of a riveted tail cone carrying the combustion chamber, and three sets of formers, the centre set being double to provide anchorage for the elevator hinges. The head of the combustion chamber was positioned by a welded ring, linked by means of flanges to the tail cone.

The elevator hinges carried two projections which were bolted to plates fitted on the aforementioned double formers. Extensions of these hinges carried the upper structure, the top halves of the double formers providing a base for a series of longerons which in turn gave anchorage for the upper surface, the skin, and the fin.

The fin was fitted between the two top longerons and clamped internally by a screwed rod passing across the test vehicle above the axis of the tailplane. Adjustment of the fin was provided by means of shims in the longerons and locknuts on the screwed rod.

A central rib was fitted in the bottom of the tail cone. This was formed of two triangular plates riveted to the longerons and provided a pivot for the dive actuator lever and mountings for the tailplane servo-motors.

1.2. *Wing.*—The wing was of biconvex section 97·5-in. span and 18·94-in. mean chord. It was constructed in mahogany, and formed a single-piece unit which passed right through the body. Ailerons of mahogany were fitted to the trailing edges, and were operated by push-pull rods running in tunnels formed in the thickest part of the wing. These rods were actuated by a single bell-crank lever in the centre section of the wing and similar levers transferred their motion through 90 deg to the ailerons. The fit of the pins at all pivot points was made tight purposely, to avoid backlash; for the aileron a distorting plate-type hinge was adopted. These shakeless

pivots made the ailerons feel stiff but in practice with the servo power available they appear to have worked with entire satisfaction. As the push-rods were unjointed a large operating tunnel was necessary for freedom of angular movement, and to compensate for the lack of stiffness thus introduced metal strengthening plates were fitted to the upper and lower surfaces. These covered the centre-section to a width of approximately half-chord and extended to the inboard ends of the ailerons.

To maintain the desired sharply profiled leading and trailing edges, dural inserts 2-in. wide were bonded to the upper surface of the leading edge and the under surface of the trailing edge. The trailing-edge inserts were isolated from the remainder of the metal wing structure and the fuselage, and were used as aerials for the telemetering transmitter, being fed through a channel drilled in the wing root.

1.3. *Tailplane.*—The swept-back, all-moving tailplane was of birch. The hinges were mounted within the tailplane thickness and the operating lever was bolted to the leading centre-section. On the upper starboard side, near the leading edge was a small steel plate which provided a base for the angle indicator actuating rod. As on the wing the sharply profiled leading and trailing edges were formed in Dural inserts which were used as the aerial for the radar transponder unit.

2. *The Alpha Rocket Motor.*—2.1. *General.*—The development of the Alpha motor, which is shown diagrammatically in Fig. 24 has been described in Ref. 12. Only a brief description is therefore given here.

The motor was a bi-liquid fuel rocket, the fuel being 57 per cent methyl alcohol, 30 per cent hydrazine hydrate, 13 per cent water and the oxidant 80 per cent hydrogen peroxide, 20 per cent water. The estimated performance of the motor is discussed in detail in Ref. 13. In flight it produced a thrust of about 900 lb for about 58 seconds (see Fig. 14) during which time it consumed 67 lb fuel and 194 lb oxidant. A combustion chamber pressure of 270 lb/sq in. falling to 120 lb/sq in. due to throat erosion was recorded (Fig. 13), the specific impulse of the motor being about 200 lb/lb/sec. In order to promote satisfactory chemical reaction, a catalyst consisting of 13 cc/litre of a 17 per cent solution of potassium cupro-cyanide was added to the fuel.

2.2. *Fuel and Oxidant Supply.*—2,080 cu in. (7.5 gal = 67 lb) of fuel were carried in the ogival nose tank which formed the fuselage nose. Of the two spherical aluminium alloy oxidant tanks, the forward one carried 1,310 cu in. (4.7 gal = 64 lb) of oxidant and the rear one double this amount. They were so situated in the fuselage that a minimum change of c.g. position was experienced from the combustion of the liquids.

2.3. *Air Supply.*—Air was carried in three toroidal vessels, each containing 40 cu ft of free air stored under a pressure of 4,000 lb/sq in., from which it was delivered to the starting valve shown in Figs. 14 and 16 of Ref. 12. The air in this valve was contained by a brass disc, which in the starting operation was punctured by a plunger energised by the gas from the electrical firing of two dinghy-type cartridges. The air was then reduced to a working pressure of 512 lb/sq in., at which pressure it was fed into the tanks, and so ejected the liquids.

Incorporated in the pressure system was a distribution and vent valve (Fig. 19 of Ref. 12) whose function was to vent the oxidant tanks to atmosphere in the absence of large pressures from the air system, but was automatically closed by the fuel ejection pressure on starting. A non-return valve prevented any oxidant which might collect in this valve from finding its way down the distribution pipe to the fuel tank and thus causing an explosion.

2.4. *Starting Delay Chokes and Diaphragms.*—In order to obtain a smooth start, the entry of the liquids to the combustion chamber had to be timed to close limits and only a very restricted flow of oxidant was required. The feed pipes to the combustion chamber therefore contained P.V.C. diaphragms fitted in special unions. The liquids were 'bled' through the feed pipes until all air was extracted and the diaphragms, the development of which is described in Ref. 12

prevented any premature 'seep' of liquid into the combustion chamber. On starting the motor, the diaphragms ruptured at approximately 60 lb/sq in. and permitted the passage of the liquids. On being released by the ruptured P.V.C. diaphragms, the oxidant was allowed to impinge on chemical chokes soluble in oxidant. These were formed of a 100 H₂O/90 di-sodium phosphate mixture (Ref. 16) and were installed in special unions between the P.V.C. bursting diaphragms and the burners in the combustion head. The chokes were of $\frac{3}{8}$ -in. diameter, $\frac{3}{4}$ -in. long and contained a hole $\frac{3}{16}$ -in. diameter down the centre. An average delay of 0.12 seconds in the commencement of delivery of oxidant, and an estimated delay of 0.80 seconds in full delivery was obtained. Thus only a 'trickle' of oxidant from all three burners was available for starting, full flow being established when the reaction had been successfully initiated. The delivery of fuel before oxidant and consequent 'smooth' starting was thus ensured. No choke was fitted in the fuel line.

2.5. *Combustion Head.*—The oxidant passed from the soluble choke to the burners in the combustion head. The head contained three burners one of which was fed from the forward oxidant tank while the other two were fed from the rear tank. The assembly of burners is shown in Fig. 24 of Ref. 12 and in diagrammatic form in Fig. 24 of this report. The pressure of the oxidant supply operated a small pintle valve which permitted the oxidant to be discharged in the form of a fine conical divergent spray. The fuel was fed to all burners by one pipe which connected with an annular space in the combustion head. From this space the fuel passed through a filter gauze to the burners, from which it emerged as an almost parallel circular spray, co-axial with the oxidant spray. The two liquids therefore met a short distance from the combustion head, inside the chamber.

2.6. *Combustion Chamber.*—The development of the combustion chamber has been dealt with in Ref. 11. It consisted of a steel shell enclosing a $\frac{1}{4}$ -in. thick carbon lining and terminating in a cone which carried a carbon venturi 1.625-in. diameter throat and 4.5-in. diameter mouth. The head was formed of cast steel and was tapped to accommodate three burners, one fuel inlet connection and two pressure points.

2.7. *Production of Smoke.*—In order to simplify visual tracking of the test vehicle, arrangements were made to feed into the combustion chamber a mixture of benzene and toluene which produced ample volume of greyish smoke without adversely affecting the performance. The mixture was carried in a cylindrical tank in the tail section (Fig. 24) which was pressurised *via* a non-return valve from the main rocket fuel expulsion air line. The mixture was introduced *via* one of the pressure tappings, a non-return valve guarding against any blowback of pressure from the combustion chamber.

2.8. *External Igniter.*—As the smooth initiation of the reaction can be assisted by heat, and danger of freezing minimised thereby, an igniter was fitted in the exit cone of the combustion chamber venturi. This was a standard R.T.V. 1 igniter and consisted of a circular cap containing a small quantity of ammonium picrate + sodium nitrate and a binder. Ignition was initiated by a small electrically fired charge of gunpowder. The assembly screwed into a socket some 3-in. diameter, in the centre of which was a small orifice through which were run the igniter wires. The unit was mounted on a brass spider, suitably 'necked' to assist jettisoning when the main motor had started. The unit was operated in parallel with the rocket starting valve and produced a very hot flame some 18-in. long which was arranged to play inside the chamber. Thus the liquids on arrival met this flame and the desired chemical reaction occurred.

3. *The Control System.*—3.1. *Fundamental Considerations.*—The auto-pilot (Fig. 25) was built around the German V1 auto-pilot design. The unit consisted basically of one air-driven displacement gyroscope, detecting displacements in roll, pitch, and yaw together with two air-driven rate gyroscopes measuring rate of pitch in one case, and rates of roll and yaw in equal proportions in the other case.

Control in yaw was achieved by inclining the axes of the displacement gyro and the roll-rate gyro at the 45 deg and using the Mark VIII auto-pilot aileron steering technique. This provides for correction of yaw by putting on bank in a sense to turn again on to course.

In addition to the above the tailplane was moved differentially by two independent servos, one of which was actuated by the gyroscope signals and the other by a height-sensitive capsule.

The control laws may be written as

$$\eta = 0.22\theta + 0.033\dot{\theta} + \Delta h - 1$$

and

$$\xi = 0.22(\phi + \psi) + 0.025(\dot{\phi} + \dot{\psi}),$$

where

- η and ξ are elevator and aileron displacements—degrees from fuselage datum
- θ , ϕ and ψ are respectively angles of pitch, roll and yaw of the fuselage datum—degrees from attitude at gyro uncaging
- Δh is increase of altitude—thousands of feet from height at which servo came into operation

and

$$\dot{\theta} = \partial\theta/\partial t.$$

3.2. Damping.—The purpose of the rate gyros was to supply artificial damping. This was necessary because the displacement system alone was subject to considerable phase lag, and at the frequency expected (3 per sec) the motion of the test vehicle would certainly be unstable without a fair measure of phase advance added to the signal output. As the result of laboratory tests it was considered that at Mach numbers greater than unity the damping would be just adequate, but a small undamped periodic motion amounting to $\pm \frac{1}{4}$ deg in pitch would persist. This did, in fact occur as can be seen from the telemetered readings of tailplane movement (Fig. 17).

3.3. Signal System.—The 'signal' system comprised air-jet pick-offs operated by displacement gyroscopes which applied differential pressure to diaphragms built into the servo-motor valve chests. The individual displacement and rate signals were added by the simple expedient of paralleling the pipes, an arrangement which gives an apparent algebraic addition only; but surprisingly enough an effective answer when pressure level and pressure variations are of a low order.

3.4. Servo-Motors and Feedback System.—The diaphragm in the servo-motor valve chest (Fig. 26) was arranged to supply a force to a small pivoted crank to which was attached the valve piston. Flow of air to the servo-motor was thus controlled by displacement of the valve piston in response to diaphragm pressure. Feedback to produce proportional control was arranged by attaching one end of a spring to the valve crank and the other end to the servo piston-rod. The follow-up system was therefore arranged by balancing forces and not displacements.

3.5. Tailplane Height-Control System.—As stated above, the tailplane was operated by two differentially coupled servo-motors one of which responded to signals from the gyro unit and the other to a height-sensitive diaphragm. This latter was arranged by leaving one side of the existing servo-diaphragm permanently open to local static pressure and blanking off the other at the required altitude by a solenoid operated valve actuated in parallel with the rocket motor starting valve. A stroke of 1 in. of either servo-motor gave 3.6-deg change in angle of the tailplane, the total range of movement being 7.2 deg.

3.6. Air Supply.—The air supply for the control system was carried in the rear toroidal air bottle. This contained 'dry' air at 3,000 lb/sq in. which was retained by a plunger-type valve mounted integrally with a Vickers miniature bomb-slip. On release of the valve, the air was

filtered and reduced in pressure to 120 lb/sq in., at which pressure it operated the servo-motors. Part of the supply was further reduced to 35 lb/sq in. at which pressure it was used to spin the gyroscopes and operate the signal air pick-offs. Provision for an external supply at this pressure from the parent aircraft *via* a non-return valve was made. This was used to pre-spin the gyroscopes before release, thus ensuring that the auto-pilot was fully operational on release.

3.7. *Time-Switch*.—The clockwork time-switch in the auto-pilot carried two sets of contacts. These, as explained in Appendix IV operated (a) the rocket motor and altitude servo, and (b) the final dive actuator. The clock was started by a solenoid, operated by withdrawal of a lanyard on release of the test vehicle from the parent aircraft. This not only released the brake but also supplied the balance wheel with a slight push to set it going.

3.8. *Dive Actuator*.—As the test vehicle might, on conclusion of its flight, continue to glide for approximately 100 miles across some of the main shipping lanes, provision was made for ditching it at the conclusion of its effective life. A lever, powered by elastic cords (Fig. 25) was retained in the off position by a pin which, on conclusion of the flight, was ejected by a dinghy-type cartridge. The lever, under the pull of the elastic, pushed home a stop in a V-notch on the tailplane operating arm, designed to lock the tailplane in a position of -1 deg, which, it was calculated would be sufficient to dive the test vehicle into the sea. Simultaneously a knife attached to the lower end of the lever sheared through the control air pressure pipe so releasing the air pressure and rendering the servos inactive.

4. *Electrical System*.—The electrical system installed in the test vehicle is shown diagrammatically in Fig. 27. The installation was complicated by the requirement of control of radio gear and safety switches from the parent aircraft during the initial climb, allied to a complete transference of control to the auto-pilot on the release of the test vehicle from the parent aircraft.

4.1. *Supply*.—The basis of the system was a set of thirteen 2-volt, 7-ampere-hour accumulators carried in the lower centre-section (Fig. 5a). These were trickle charged from the aircraft generator during the climb to operating altitude and were isolated from the internal installation by a set of contacts, maintained in the open position by a wire lanyard, anchored to the lower carrier on the parent aircraft (Appendix IV).

The radio gear, comprising the telemetering transmitter, and the G.C.I. transponder, was connected to the parent aircraft supply *via* a double Jones plug, which broke contact on the release of the test vehicle, the simultaneous withdrawal of the wire lanyard connecting the internal accumulators to the installation.

4.2. *Safety Devices*.—Connection through the Jones plug was also made to those services operated only from the parent aircraft. These were the pitot heater, and the rocket motor and auto-pilot safety and control devices. As the bi-fuel motor used in the test vehicle was an unknown quantity two safeguards against the accidental initiation of combustion by any reasonable combination of circumstances were considered essential for the safety of the parent aircraft. One, operating directly on the rocket motor, consisted of a set of solenoid-operated contacts fitted with a latch to retain them in the closed position. The contacts were operated from the control panel in the parent aircraft *via* a special jack which was retained in the observer's possession, so that their inadvertent closure was avoided. The second safeguard was a set of contacts fitted in the timing circuit of the auto-pilot to avoid inadvertent starting of the clock and the loss of the 6-second safety period between release and starting of the rocket motor. Further to the above, the wire lanyard previously mentioned operated an additional set of contacts in the auto-pilot timing circuit, the closure of which started the time switch. The initiation of the various functions were thus entrained by the actual 'normal' release of the test vehicle from the parent aircraft. To guard against the premature initiation of the sequence of

operations in the event of the lanyard-operated switch being shorted by moisture an additional pair of contacts provided a duplicated warning light on the observer's panel indicating the need for appropriate action (see section 4.2(5), Appendix IV).

4.3. *Auto-Pilot Initiation Controls.*—As mentioned earlier the displacement gyroscope was caged during the initial climb, to avoid damage due to uncontrolled movement and to ensure its release in a correct datum position. On being pre-spun from the parent aircraft's air supply the gyro was then uncaged by the action of a solenoid controlled from the parent aircraft control panel, the released cage closing a set of contacts in the circuit to the electrically operated air valve, controlling the air supply to the auto-pilot and servo system. The completion of this sequence of operations was indicated to the observer by two indicator lamps on the control panel, which were fed *via* a set of contacts operated by control air pressure.

4.4. *Time-Switch Controlled Circuits.*—The internal circuits in the test vehicle, controlled by the time-switch on the auto-pilot were two in number. The time-switch was started by withdrawal of the lanyard on the release of the model, and on the expiry of the safety period a set of contacts completing the circuit to the rocket motor starting valve was closed. This resulted in the electrical ignition of two small cartridges which operated the starting valve together with the igniter mentioned in section 2.8 and the consequent initiation of combustion. On completion of the flight, closure by the time-switch of a second set of contacts resulted in the ejection, by a third cartridge, of the dive-actuator retaining pin, allowing the elastic cords to force the elevator into the pre-determined final dive position. Included in the cartridge firing circuits were limiting resistances, to prevent draining of the accumulators by a short arising from a possible bridging of the cartridge electrode stubs.

5. *Telemetering Equipment and Radar Transponder.*—The arrangement of instruments and telemetering transmitter used to supply information to the ground station on the Scilly Isles is covered in detail in Appendix II and no description is therefore given here.

The course of the test vehicle in flight was watched by G.C.I. and to facilitate tracking a transponder was fitted in the tail section. This pulse transmitter was triggered off by the G.C.I. beam, and thereupon transmitted a signal on a frequency of 204 Mc, which was received on the normal G.C.I. 208 Mc receiver. Thus a positive indication of the position of the test vehicle was available on the G.C.I. installation on the Scilly Isles.

6. *Heating Arrangements.*—Provision was made for the supply of heat to the internal apparatus and particularly the oxidant in the test vehicle. This heat was supplied (a) in the form of warm air, and (b) in the form of electrical energy, the supply available from any single source being inadequate.

6.1. *Warm Air Supply.*—Warm air, normally used to heat the rear fuselage of the parent aircraft, was collected by a scoop behind the starboard radiator, and fed into the test vehicle at two points. The forward position was just aft of the forward oxidant tank, and an internal duct directed the air on to the forward oxidant pipe. Warm air was also fed in forward of the tailplane, another internal duct carrying the supply to the lower half of the fuselage and directing it on to the rear portion of the three oxidant pipes.

6.2. *Electrical Heating.*—As the necessary electrical energy for large-scale heating was not available, advantage was taken of the heat produced by the internal equipment, particularly the telemetering transmitter and radar transponder. The former was arranged in the centre-section so as to heat the centre of the forward oxidant pipe and the rear oxidant tank. Some 168 watts of heat was supplied by this equipment.

The transponder equipment operated off 6 volts and therefore required a 'dropper' resistance. By placing this in close proximity to the oxidant pipe unions some 72 watts of heat was utilised. This system was found to be quite satisfactory.

7. *System Development Tests.*—In the earlier descriptive sections references have been given to relevant reports dealing with the development of the various systems of the final model. In this section are described certain modifications found necessary after the first abortive flight release. They are concerned mainly with the rocket motor, and are described chronologically under each system.

7.1. *Rocket-Motor Trials.*—Some doubts existed as to whether the rocket motor would ignite at altitude ; it was thought there would be both temperature and pressure effects. Flight tests were made on a fuelled fuselage, temperatures of the fuel and oxidant in the tanks, of the delivery pipes both fore and aft, and of the air in the fuselage being recorded. Due to an electrical fault in the aircraft the fuselage was prematurely released before completion of the test, but extrapolation of the results obtained suggested that so long as the liquids were warmed before take-off, no difficulty should arise. The pressure effect was investigated on the test-beds by sealing the combustion chamber outlet with a light diaphragm. The chamber was then evacuated and it and the fuels cooled to a low temperature using solid CO_2 . Normal starting sequence was then followed and a normal start ensured. It was therefore concluded that the rocket motor would start at altitude.

As described below, the rocket motor on the first test vehicle failed to ignite. There was evidence that although the starting sequence took place at 15 seconds after release as planned (later decreased to 6 seconds), ignition did not occur at this time, but that at about $19\frac{1}{2}$ seconds an explosion occurred that wrecked the rear end of the body. There were many possible explanations based on the assumption that the arrival of the fuels at the burner was other than as planned (*see below*) for it was known that starting was critical in this respect. The repeated failure of P.V.C. bursting diaphragms suggested that pressure was being built up in the system ; that in practice the air delay valve fitted to the rear oxidant tank (section 2.3) prevented its proper venting. It was therefore decided to obtain the required delay in the delivery of oxidant by the use of a soluble choke in the delivery line. The development of the choke is dealt with in Ref. 16 ; it was fitted in a housing with the bursting diaphragm to make a complete unit for ease of assembly and testing.

Laboratory tests (Ref. 15) also indicated that at low pressure ignition of the rocket might be difficult, and two fuselages (Nos. A9 and A8, Table 2) were therefore dropped from 35,000 ft with a light sealing diaphragm over the mouth of the combustion chamber. This would reproduce the ground starting test, in which it was suggested that boiling of the oxidant in the enclosed space of the combustion chamber had in fact raised the pressure, thus assisting ignition. In the first drop there was some inconclusive evidence that ignition occurred and the rocket operated for about 10 seconds, but in the second drop there was no evidence of any ignition whatever.

Further laboratory tests were undertaken (Refs. 17 and 19) and concurrent flight trials made to improve the heating of the body and in particular the delivery pipes. Temperature measurements were made carrying carbon tetrachloride in the fuel and oxidant tanks (this having about the same specific gravity and specific heat as the fuel and oxidant, and being safer) and to ensure that freezing was not taking place at some point at which temperatures were not measured, the carbon tetrachloride was expelled in flight, by operation of the automatic rocket ignition sequence, after a simulated pre-release flight. Typical temperature measurements before and after the modified heating arrangements are given in Figs. 28 and 29 ; the liquid expelled satisfactorily and it was concluded that the best that could be done on the heating side had been achieved.

Fuselage A12 was released from 25,000 ft and the rocket motor ignited satisfactorily. Fuselage A11 was then released from 35,000 ft, and an explosion at the instant when the starting sequence should have been completed wrecked the rear of the model.

At this stage the opinion was formed that spontaneous ignition at 35,000 ft without some form of torch igniter, was impossible. There was available such an igniter which had been used in R.T.V.1 experiments. It consisted of a small disc-covered cup containing plastic propellant

which on ignition produced a flame 18-in. long for 3 seconds from a nozzle in the disc. As previously described this was supported across the mouth of the combustion chamber by a weak spider and was electrically fired. Ground tests proved the certainty of its operation at 35,000 ft, and of its igniting the rocket motor.

Fuselage A10 was released from 35,000 ft with the igniter fitted, and the rocket motor started and operated successfully. The final test vehicle A3 was then successfully launched using this ignition principle.

Two other minor modifications were made to the rocket-motor system during the developments just described. Experience on the first model (A2) with many assemblings and dismantlings of the pipework showed the unsuitability of aluminium pipes for this purpose; it became impossible to get good liquid-tight joints. The difficulty was overcome in A9 and all later bodies by using stainless steel pipelines. Also after the first release of A2, shrouds were fitted to the combustion-chamber burners to improve the mixing angle of the fuel and oxidant. During trials using fuselages only (bodies A8 to A12 inclusive) the fuel and peroxide delivery pipes were run to the centre of the tanks to ensure supply even when the model rolled. This was unnecessary in the final model A3 which was maintained on an even keel by the auto-pilot.

7.2. Control-System Trials.—To ensure satisfactory operation of the auto-pilot and control servos at low temperatures a test was done in the F.V.D.E. Cold Chamber at Chobham. The test vehicle was mounted on a stand giving freedom of rotation about 3 axes, and placed in a portable insulated container inside the cold chamber. The fuel tank was filled, the oxidant tank filled with a 50-50 mixture of glycol and water, a reserve external air supply connected to the auto-pilot air bottle and the gyro pre-spin line, and a control panel connected through the normal Jones plug connection. The warm-air system was supplied with the correct volume and temperature of air. The chamber temperature was then reduced to about -55 deg C, and the temperature inside the insulated container kept at about ground-level conditions using electric fires.

When conditions had stabilised the insulating screens and fires were removed, and the hot air supply turned on. After some 45 minutes, simulating climb to altitude and a further period of 30 minutes to allow of positioning the aircraft prior to release, the pre-release sequence was started. The gyro pre-spin air was turned on, and after 5 minutes this and the warm air were disconnected simulating release from the parent aircraft. Simultaneously the gyro was uncaged and the internal air supply and accumulators made operative. The test vehicle was then rolled and pitched to simulate flight and the operation of the auto-pilot and control system checked. No major modifications were necessary.

As described below, the first model failed to stabilise, and rolled on to its back. The available evidence suggested that this was due to failure of the air supply to the control servos. The test vehicle air supply on this model was controlled in parallel with the gyro uncaging release, these two being in series with the test vehicle release slip. This was later modified and the two former controls connected in series with a tell-tale lamp on the observer's panel in the parent aircraft. The release unit was operated by the observer. No further troubles were experienced.

Further flight trials were undertaken, in which all auto-pilot sequences were followed with the test vehicle still on the parent aircraft, which was then pitched and rolled on a straight course. The behaviour of the test vehicle gyros was followed *via* the telemetering transmitter, and the behaviour of the tailplane *via* temporary selsyn indicators displaying on the observer's panel.

As explained in the body of the report, the auto-pilot operated satisfactorily on model A3, within the limitations imposed upon it.

7.3. Suspension Lug.—It is described in Appendix IV how model A1 was lost in flight when the parent aircraft was inadvertently flown through a cumulo-nimbus cloud in a storm. The model was stressed to $4\frac{1}{2}g$, and the first suspension lug designed to fail at this load, and checked

by proof loading tests. Loss of A1 was caused by failure of the suspension lug. The entire suspension was therefore restressed to 7g, and more rigorous flight limitations imposed on the parent aircraft, with no recurrence of the trouble.

8. *First Test Vehicle Release—A2.*—To achieve optimum weather conditions, and to have the best light for photographic purposes, the first release was scheduled for 1100 hours on 8th October, 1947. A succession of assemblies had caused deterioration of the fuel pipes and a decision was made to fuel some hours early so that time would be available for minor replacements.

The toluene tank in the tail was first filled, and then the fuel put in the nose tank, the fuel delivery pipes bled, the auto-pilot settings adjusted and the covers screwed down. The outside of the test vehicle was then hosed down gently, and with an adequate water supply available the oxidant tanks filled and the oxidant delivery lines bled. The air bottles were charged, weight and c.g. position determined, and the air pressure released. The test vehicle was stored overnight in an artificially warmed building, with the vent pipes discharging over buckets of water.

Early on the morning of 8th October, 1947, as the test vehicle was being loaded on to the parent aircraft, it was observed that oxidant was dripping from the burner. Inspection showed this was due to a ruptured P.V.C. bursting diaphragm, the cause being a build-up of pressure in the rear oxidant tank, permitted by failure of the venting system. Working under most arduous and hazardous conditions, with the test vehicle standing on its nose to drain liquid away from the burner, the bursting diaphragm was replaced. The combustion chamber and burner were then washed as carefully as possible with water, and dried with an air blast.

The test vehicle was slung on the parent aircraft, telemetering equipment and radar transponder check-operated from aircraft supplies, anti-freeze grease applied to the bomb slip, and the aircraft became airborne at 1220 hours.

Affiliation with the observation aircraft was effected at operational height (*see* Appendices III and IV) and a normal release effected above 8/8 cloud at 1328 hours.

From visual observation the test vehicle dropped the starboard wing and rolled over, diving steeply. At 12 seconds it entered cloud, but the pilot of the observation aircraft who was following reported that at 15 seconds, when the timing clock was set to ignite the rocket motor, no visible change occurred. At about 19½ seconds however an explosion occurred (which was heard from the Scilly Isles ground station) and the vehicle was lost in the cloud of smoke that accompanied it. The spotter at the ground station saw the splash as the vehicle entered the sea, but salvage attempts were unsuccessful.

Analysis of the radar tracking records indicated that the vehicle had roughly followed a bomb trajectory for 31 seconds, and then there was a large change in course, the speed dropping from about 600 ft/sec to 280 ft/sec in one second. Thereafter the radar tracked something that descended slowly in a random manner, drifting downwind to the entry point seen by the spotter.

Considering the telemetering signals, no intelligible result was obtained from tailplane angle throughout the flight. Combustion chamber pressure showed approximately atmospheric until about 19½ seconds, and then failed completely. Accelerometer and pitot-static pressure signals were strong until 19½ seconds, with a slight disturbance at 15 seconds. After a violent disturbance at 19½ seconds the signals were intermittent and unintelligible until about 108 seconds, which time agreed roughly with entry.

The interpretation put upon these results was as follows:

- (a) Control air was not switched on at release, due to recurrence of an intermittent electrical fault that had not been entirely eliminated. The remedy to this was a change in the circuit previously described in section 7.2.

(b) Delay in ignition from 15 seconds and the explosion at $19\frac{1}{2}$ seconds were due either to the altitude effect previously described, or to some irregularity in the delivery of the fuel and oxidant to the burner. As described in Ref. 15, the start was critical in this respect, an explosion occurring if the oxidant was delivered before full fuel flow was established. A delay in fuel delivery could be caused by freezing of fuel in the delivery pipes, or of water in the annular space surrounding the combustion head, the water having been introduced during the washing process that accompanied changing the ruptured P.V.C. diaphragm already described. An explosion might also occur if oxidant were introduced into the annular fuel space around the burner, or if the oxidant delivery had been interrupted by freezing in the delivery pipes. The action taken to overcome these difficulties and to develop a satisfactory rocket motor start has already been described.

9. *Second Test Vehicle Release—A3.*—This model was prepared in substantially the manner described for A2, and with the experience gained in the preparation of the 5 fuselage rocket-motor test bodies (Models A8 to A12) as a background, no major difficulties were encountered.

Release at 35,500 ft was effected at 1325 hours on 9th October, 1948. The use of an observation aircraft having been abandoned, due to radar tracking difficulties described in Appendix III, it was decided to set the ignition sequence to operate at 6 seconds after release, so that photographs of the start and initial flight of the model could be obtained from fixed cameras in the parent aircraft. The risk of confusing the radar tracking by being unable to discriminate between the parent aircraft and test vehicle was accepted.

From the functional aspect, the only defect that appeared was in the dive actuation mechanism. There is evidence that this operated at the prescribed time but that the planned dive did not ensue, probably due to incorrect adjustment of the mechanism, so that the tailplane angle was changed by an insignificantly small amount from that required for trim. The S.C.R. 584 failed to track the test vehicle, but as shown in the body of the report this was not a major obstacle to satisfactory analysis of the results. Good photographic records of the initial flight path were obtained.

APPENDIX II

Telemetry Equipment

By

F. H. IRVINE

1. *Introduction.*—It was intended initially to obtain the desired information on the flight path of the test vehicle by radar tracking. However, as the test vehicle developed and a liquid-fuel rocket motor and auto-pilot were incorporated, it was realised that radar tracking alone was unable to provide all the information needed. Data on the combustion chamber pressure and the tailplane angle under operating conditions, for instance, would be required, and for this reason it was decided to incorporate a telemetry system. The system employed was developed by the R.A.E. and is known as 6-channel V.H.F. Telemetry (Ref. 4). It bears the experimental number X.157.

2. *General Description.*—The principle of operation of this form of telemetry consists of changing the frequency of six audio-oscillators by varying by mechanical means the inductance branch of their tuned circuits. A V.H.F. carrier wave is amplitude-modulated by the audio frequencies, and the transmitted signal received at a ground station that has facilities for demodulating the signal and transforming the varying modulation frequencies back into the form of mechanical movement.

3. *Airborne Equipment.*—This consisted of a combined 4-watt 90 Mc/sec radio-frequency transmitter, modulator and motor-generator type power pack, and a set of six miniature audio oscillators with their associated instruments, the inductance part of the oscillator being housed in the instrument container (Fig. 3).

3.1. *Transmitter.*—The transmitter operated in the frequency band of 90 to 95 Mc/sec. It consisted of a Tritet crystal oscillator, with facilities for changing the fundamental oscillator frequency by means of plug-in crystals, followed by two stages of frequency trebling and a final stage of power amplification working as a straight amplifier. The same valve, a CV309, was used in all four stages, greatly facilitating servicing, and tuning was accomplished by means of an external milliammeter that could be switched into the cathode circuit of each stage. The modulator was a conventional three-stage resistance-coupled amplifier with negative feedback, the modulator valve being a 6V6 GT. Choke modulation was used and the modulation depth kept below 45 per cent to ensure linearity and a distortionless output waveform. The output of each oscillator was fed to the control grid of the first audio amplifier, a CV138, through the same screened cables that carried the oscillator supply leads. These cables plugged into the front panel of the transmitter case and the circuit was so arranged that the transmitter could not function until all six oscillators were plugged in.

The motor-generator was located at the rear of the chassis and with its associated smoothing and voltage-regulating circuits supplied 300 volts at 175 mA for the transmitter and modulator, 95 volts, stabilised, for the audio-oscillators, and 120 volts negative grid bias for the final radio-frequency Class C amplifier.

3.2. *Audio-Oscillators.*—The basic circuit of the oscillator is shown in Fig. 30. It was essentially a multi-vibrator using a 6SN7 GT double-triode valve with an LC tuned circuit connected between the two control grids. This locks the multi-vibrator to the frequency of the tuned circuit and by operating the oscillator at a low output level, generally about 50 mV R.M.S., a sine wave is generated with quite a small percentage of 2nd harmonic distortion, 2 per cent being the usual figure, with negligible higher harmonic distortion. It was very necessary to keep this harmonic distortion low, and to ensure the linearity of subsequent amplification, because the production of beat notes and large second harmonic voltages would have seriously impaired the reliability and accuracy of the system.

The frequency of the oscillator was varied by arranging that a small section of the laminations of the inductor could be moved in relation to the fixed laminations, so altering the size of the air gap and, therefore, the inductance. The movement of these laminations was adjusted in such a way as to cause the frequency of the oscillator to change ± 10 per cent about a centre frequency, the actual movement to obtain this being about 0.05 in. The six oscillators between them, covered a band of frequencies from 550 c.p.s. to 6,500 c.p.s., the position of each frequency band, or channel, being so related that the 2nd harmonic of any frequency used did not fall into any of the other bands (*see* Fig. 31). The same type and value of variable inductor was used for each oscillator, the value of the tuning condenser being changed to obtain the required operating frequency. Miniature potentiometers with screwdriver adjustment were provided for correctly setting the output level.

3.3. Mechanical Design.—The transmitter (Fig. 3), which measured $17\frac{1}{2}$ in. \times 5 in. \times $4\frac{1}{2}$ in., was located on a shock-proof mounting in the centre compartment of the test vehicle, directly underneath the centre-section of the mainplane (Fig. 5a). Each oscillator was built in the form of a cylinder $6\frac{1}{4}$ -in. long \times $1\frac{1}{2}$ -in. diameter, the supply lead being brought into one end and the instrument lead into the other through screened cables. By this method of assembly an oscillator could be housed remotely from the transmitter and clipped into any convenient position in the confined space within the fuselage. Attached to the shaft of the motor-generator was a fan which drew in cool air from the louvres at the front of the transmitter case, the air passing over all the valves on the chassis before being ejected at the back. Special attention was paid to this cooling system during the initial design of the equipment, as without cooling the temperature rise was large, due to the small dimensions of the transmitter case and the large heat dissipation of the valves. The total weight of the equipment, including instruments, was approximately 30 lb.

The envisaged flight path of the model was mainly away from the point of reception on the Scilly Isles, and for this reason a high back-to-front ratio of the polar diagram of the aeri-als was desirable. For this reason they were located in the trailing edge of the wing and fed from the transmitter by screened leads, matching being effected by adjustment of the link coupling to the final tank circuit of the transmitter.

With this arrangement an air-to-ground radio range of over 100 miles was obtained during test flights. To ensure that the rocket blast had no adverse effect on the transmitted signal, the telemetering equipment was operated during the ground test of the rocket motor in the test vehicle at R.A.E. Readings of the combustion-chamber pressure were received and no interference from the rocket motor was observed.

3.4. Calibration of Instruments.—The six channels were allocated to the measurement of the following quantities :—

- Tailplane angle
- Combustion-chamber pressure
- Static pressure
- Pitot pressure
- Normal acceleration
- Longitudinal acceleration

The equipment necessary for calibrating the various instruments was installed in a vehicle which formed a part of the ground installation at St. Eval airfield.

Tailplane angle.—A vertical steel rod was spring-loaded against the upper surface of the tailplane leading edge in such a way that the rod moved axially in sympathy with the tailplane setting. The other end of the rod was tapered, and a steel wiper arm was spring-loaded against the taper. Attached to the wiper were the free laminations of the inductor which then moved in and out of the air gap. The oscillator was calibrated with the instrument in place in the test vehicle, the tailplane angle with the datum line being measured by a clinometer.

Combustion chamber pressure.—The instrument was a Bourdon tube enclosed in a standard aircraft altimeter case, the free laminations being attached to the moving part of the tube. The inductance leads were brought out to terminals on the face of the case. It was capable of a working range of 100 to 350 lb/sq in. and was calibrated by air pressure from a suitable system, the pressure being read on an accurately calibrated Budenberg gauge.

Static Pressure.—The static-pressure instrument was an evacuated capsule housed in a case similar to that of the combustion-chamber pressure instrument. The laminations were mounted in the centre of the capsule face. The instrument had a range of $2\frac{1}{2}$ to 9 lb/sq in. and was calibrated by reducing the air pressure inside the case, the pressure being measured on a mercury column.

Pitot Pressure.—This was similar in construction to the static-pressure instrument, but had a pressure range from 2 to 18 lb/sq in. The method of calibration was the same, except that a small amount of positive pressure had to be applied.

Normal Acceleration.—This instrument was of the cantilever type, the free laminations being attached to a weight mounted on the moving end of a flat spring. It covered a range of $-1g$ to $+2g$ and for readings up to $1g$ was calibrated by tilting in the earth's gravitational field. For the higher g readings, it was calibrated on an air-driven whirling table, the inductor leads being taken through slip rings on the table shaft. This system proved very successful in practice, as the two curves obtained, one from tilting and one from whirling, matched perfectly when plotted.

Longitudinal Acceleration.—The longitudinal accelerometer was located in the same container as the normal accelerometer and differed only in its range, $-1g$ to $+1\frac{1}{2}g$, and orientation. It was calibrated in the same manner as the normal accelerometer.

4. *Ground Equipment.*—4.1. *Reception.*—The ground receiving equipment on St. Mary's Island in the Scillies was housed in a small brick building about 500 yards from the main operations block at Newford. Power was supplied from a mobile diesel-engined generator and the site was linked with Newford by Post Office lines and a V.H.F. Radio Telephone system. The building contained all the apparatus necessary to decode and record the telemetering signals received from the test vehicle in flight.

The receiving aerial was a fixed horizontal dipole mounted on top of a 60-ft high mast, and fed by an 80-ohm concentric line to either of two available receivers, a Hallicrafters S.27 communications receiver or an R.A.F. 1132A V.H.F. ground station receiver modified for use in the 90 to 95-Mc/sec band. The 1132 was used for the actual test.

4.2. *Display.*—The output of the receiver was fed to six band-pass filters. These filters separated the six modulating frequencies into their respective bands and had cut-off frequencies very near to the actual band edges. The six separated modulating frequencies were then fed to a group of audio amplifiers, the purpose of which was to raise or lower the signal to the correct level for injection into the frequency counters. The counters, one for each channel, were adjusted so that full-scale deflection on their associated output meters corresponded to the band width in cycles/sec of the channel. Thus, any change in the six transmitted audio-frequencies was shown as a change of meter reading. By reference to suitable calibration charts this could be transformed back into frequency.

4.3. *Recording.*—The six counter meters were grouped together on a vertical panel mounted on a standard rack (Fig. 32a). The panel also contained six a.c. voltmeters showing the relative input levels to each counter. These were filmed by means of an F.24 camera taking one frame every 1.2 seconds and an A.4 cine-camera operating at 10 frames per second. A permanent record of meter reading against time was thus obtained. Mounted on the same panel was an electric clock with a sweep second hand, the 50-cycle input being obtained from frequency-dividing a crystal-controlled 200-cycle source. This appeared on the film and was used to give a further check on time with frequency.

This method of display was useful only when the audio-frequency was changing at a relatively slow rate, because the meter pointers could not follow vibrations of more than three or four a second. For the higher rates of change of audio-frequency, cathode-ray recording was used. This consisted of six 3-in. cathode-ray tubes, one for each channel, grouped on a display panel and enclosed in a light-proof console-type cabinet (Fig. 32b). The d.c. voltage from the output stage of the counters was amplified and used to provide the vertical deflection of the sharply focussed electron beam of the tubes, the gain of the amplifiers being adjusted so that the band-width of each channel covered the full available deflection. These tubes were photographed on recording paper, the paper being wound through at constant speed by a small electric motor. To assess the period of vibrations, pulses at 10 a second were used to flash a krypton tube in the recorder. Operation of the F.24 camera shutter on a period of 1.2 seconds also flashed a krypton tube, and the markers from this on the constant-trace record were used to correlate the latter with the photographs of the meters previously mentioned.

A general view of the cathode-ray recorder with top cover removed and the two cameras for filming the meters is shown in Fig. 32b.

4.4. *Calibration.*—The dials of the frequency counter meters were marked from 0 to 100, and each was calibrated in terms of frequency, using a Muirhead decade audio oscillator. The frequency of this oscillator was first checked against a crystal source and its output fed at the correct level to the input of the counters. A graph of frequency against meter reading was made by this method, but, as a quick check immediately before or after a release, it was arranged to inject into the counters six spot frequencies (one in each band), derived from a crystal source. Any drift in the readings could thus be quickly ascertained and remedied. This calibration technique was identical with that used for calibrating the oscillators in the airborne equipment, and to ensure accuracy of results, the two Muirhead oscillators and crystal sources were periodically compared by relaying spot frequencies over landline.

APPENDIX III

Scilly Isles Ground Station

By

C. KELL and P. R. WYKE

1. *Introduction.*—The rocket test vehicle described in this report was designed to be launched at a height of 35,000 ft and was expected to travel at least ten miles under power; it was then to be dived to earth. During this flight, information on its position in space together with data transmitted by its telemetering equipment was to be collected and recorded by a ground station. For a number of reasons, mainly associated with the limited range of telemetering transmissions and accuracy of radar tracking, the ground station had to be sited as close as possible to the point of release. The distance the test vehicle would travel and the possibility of a failure to maintain its set course, limited the choice of sites to one close to the sea, over which the test vehicle could be flown and into which it could finally be dived with safety. Sites near densely populated areas and shipping concentrations had to be avoided, but a suitable aerodrome from which to operate the parent aircraft had to be reasonably close.

Most of these requirements were fulfilled by choosing a site on St. Mary's Island in the Isles of Scilly. This group of islands is sited 28 miles off the Cornish coast and within 70 miles of St. Eval aerodrome, from which the parent aircraft, a *Mosquito*, was operated. A small aerodrome on St. Mary's Island although unsuitable for the *Mosquito* was satisfactory for the operation of *Dominie* transport aircraft and this, together with a telephone and radio link with the mainland, provided adequate communications. The mainland was also connected by a boat service operating three times weekly in winter and more frequently during summer. Even more important, there already existed, on the island, a G.C.I. radar installation with self-contained power supply and a number of buildings suitable for a station such as was envisaged.

2. *Radar and Control.*—2.1. *S.C.R. 584 Radar Equipment.*—To provide information on the position of the test vehicle in space during its flight, S.C.R. 584 radar tracking equipment was installed at the ground station. This equipment tracked automatically in azimuth and elevation but was manually operated in range, the operator following, with a cursor, the target 'echo' appearing on the cathode-ray range tube. The technique adopted was to track the parent aircraft up to the moment of release when a separate echo from the test vehicle broke away from the main aircraft echo on the cathode-ray range tube. The operator then moved his range cursor on to the second echo causing the automatic tracking in azimuth and elevation to be locked on to the new target.

Except in a position almost directly above the aerial the difference in range of the aircraft and test vehicle, immediately after release, was very small compared with the difference in elevation and the operator was unable to discriminate between the two targets. This made it essential to release the test vehicle almost directly over the ground station. Now, when a target passed directly over the S.C.R. 584 aerial the azimuth error signals, tending to rotate the aerial system in a clockwise or anticlockwise direction, were of equal strength and the net instruction received by the azimuth tracking motor was zero. This meant the target would be lost at the most critical moment. To ensure flying close enough to the aerial, without passing directly over it, at such great altitudes, called for excellent conditions of visibility and additional navigation aircrew and equipment in the parent aircraft. The problem was solved by providing a method of ground-to-air control which, while completely solving the navigational problem, added no further personnel or equipment to the parent aircraft.

2.2. *Controller's Plotting Table.*—While the aircraft was being tracked by the S.C.R. 584 radar equipment the azimuth and elevation angles of the aircraft relative to the ground station and its slant range were always available. This information was fed by means of selsyn motors to a

mirror system fitted below the ground glass surface of a plotting table, Fig. 33. Rotation of the S.C.R. 584 aerial in azimuth rotated the mirror in the same sense while a change in elevation angle altered the angle of tilt of the mirror. A variation in slant range altered the distance between the mirror system and the surface of the table. A collimated beam of light was directed onto this mirror which reflected it to form a spot of light on the ground glass surface of the table. The relationship between the information provided by the S.C.R. 584 radar equipment and the movement of the plotting-table mirror system was such that the position of the spot of light on the table surface represented the plan position of the aircraft to scale.

By making use of this plan position indicator and V.H.F. radio telephony the ground controller was able to instruct the pilot of the aircraft on what courses to steer in order to bring the aircraft into the ideal position for release of the test vehicle. With this method it was not necessary that the pilot should be able to see the ground and he was left free to concentrate on the task of flying at the best conditions for release. In practice the method worked very well and it was quite usual to keep the aircraft within 100 yards of the desired track during the final part of the run up prior to release.

2.3. *G.C.I. Radar Equipment.*—Experience showed that because of the narrow beam of the S.C.R. 584 radar equipment considerable difficulty was experienced and time lost in trying to locate an aircraft when it first came within range. This could be done more quickly by visually directing the aerial but with the aircraft at very great altitudes and the sky often obscured by cloud this method was, in general, not practicable.

The difficulty was overcome by using the G.C.I. radar equipment already on the site, which was capable of operating over much greater ranges than the S.C.R. 584 as well as being less limited in the width of its beam in the vertical plane. With this equipment the range of the aircraft and its azimuth could be determined quickly while a knowledge of the aircraft altitude obtained from the pilot allowed for speedy computation of the elevation angle. This technique of locating the aircraft on the S.C.R. 584 was practised during training operations and proved to be most successful.

2.4. *Observation Aircraft.*—To observe the behaviour of the test vehicle for as long as possible following its release a fast observation aircraft was to follow it and, if possible, photograph its behaviour. The only available aircraft considered suitable for this purpose was a *Meteor*.

Because of its limited endurance and high rate of climb it was necessary for the *Meteor* to take off much later than the parent aircraft. In practice it was found to be extremely difficult for these two aircraft to locate one another at the operational height without assistance. An 'affiliation' technique was therefore developed and practised in which the pilots of both aircraft followed instructions given by the ground controller, who, working with the aid of the G.C.I. plan position indicator directed the aircraft until with the assistance of smoke bombs on the *Mosquito* (Appendix IV, section 4.1) they were close enough to sight one another and formate.

Further experience showed that the presence of the *Meteor* close to the parent aircraft presented other serious difficulties. If the range of both aircraft from the ground station became the same at any point prior to release then both echoes on the S.C.R. 584 range tube coincided and after they separated the operator could not be certain that he was tracking the aircraft carrying the test vehicle. The *Meteor* also seriously embarrassed the S.C.R. 584 operator at the moment of release, because the echoes from the parent aircraft, the *Meteor* and the test vehicle tended to become superimposed long enough for the test vehicle to pass out of the beam of the radar aerial and be lost. Avoidance of these difficulties so restricted the activities of the *Meteor* that its value as an observation aircraft became severely limited and it was finally decided to dispense with it, and to rely on the observations from the parent aircraft.

3. *Telemetering Equipment.*—The test vehicle was fitted with six-channel telemetering equipment which, during the flight, transmitted information from six instruments within the test vehicle. Receivers and recording apparatus were set up at the ground station to collect

and record this information. In order to avoid interference from the radar equipment at the main control centre the telemetering receivers were set up at a station 500 yards away from the main radar station. Initially, duplicate equipment installed in two mobile vans was used but later, when the reliability of the equipment was proved, one set was dispensed with and the other installed in more permanent quarters. A crew of two operated the equipment which is described in detail in Appendix II.

4. *Recording*.—The information obtained from the radar and telemetering equipment and other details of the performance of the test vehicle during its brief flight were recorded for later analysis.

The readings of the elevation, azimuth and slant range scales of the S.C.R. 584 radar equipment were recorded by means of a Vinten Type K ciné camera running at 16 frames per second. A second camera, an F.58, operating at 6 frames per second photographed a set of slave indicators recording the same quantities. This provided a duplicate record in case of failure of the first camera.

A. G.C.I. plan position indicator was photographed by an F.58 camera that, with a continuously open shutter, wound on the film by one frame every second; a range tube was photographed by an F.58 camera operating in the normal manner at one frame per second. These cameras provided records of the track and range of the test vehicle after release, and were of particular value when the model passed out of range of the S.C.R. 584 equipment.

The telemetered results were displayed on a set of six clock-face indicators which were photographed by an F.24, taking exposures at intervals of 1.2 seconds and a Bell and Howell A.4 ciné camera operating at 10 frames per second. The latter recorded any rapid changes in indicator reading, in addition to providing a second record in case of failure of the F.24. As well as operating the six indicators the telemetered signal was fed to constant-trace recording equipment. This latter record although of only limited quantitative use was invaluable qualitatively.

Arrangements were made for the observer in the parent aircraft, following release of the test vehicle, to give a running commentary on its behaviour for as long as he was able to see it. This commentary was transmitted by V.H.F. radio telephony from the aircraft to the ground station and was recorded on an electromagnetic wire recorder.

Quite clearly, for the purpose of analysis, the records, obtained from the many pieces of equipment at the ground station, had to be linked together in time. Experience had shown that insufficient accuracy was obtained by fitting clocks in front of each camera. As a suitable time standard a crystal-controlled oscillator was built and a dividing circuit included to allow relays to be operated at 0.1 and 1.0 second intervals. These relays were connected so as to flash small mercury vapour lamps in an automatic observer at corresponding times, the flashes being recorded on film moving past a camera lens at constant speed. To all the other cameras at the ground station relays were fitted and arranged to flash similar lamps in the automatic observer whenever the appropriate camera shutter operated. In this way the time of operation of each camera was recorded and related to a common accurate timing system. The crystal-controlled oscillator was also used to provide timing marks on the telemetering constant trace recording and provide 5 second 'pips' on the wire recording. This latter provision was necessary because of the difficulty of ensuring that the recording and play-back speeds were the same.

5. *Communications*.—In an operation of the type outlined in this appendix communications play a vital part and success or failure depends largely on the efficiency with which messages can be passed between those taking part in the operation.

Between the aircraft and controller communication was by means of standard V.H.F. radio telephony. Duplicate transmitters and receivers were available in the aircraft and at the ground station. This duplication reduced the chance of controller and aircrew losing contact.

Each member of the ground operations crew was supplied with a standard intercommunication head-set keeping him in constant touch with the other operators and controller. The V.H.F. receivers fed into this intercommunication system allowing all operators to hear messages from the aircraft and controller but only the controller was able to transmit to the aircraft.

Between the Scilly Isles ground station and St. Eval aerodrome a direct telephone tie-line was available while an additional Post Office line through the Scillonia exchange formed an additional link with the mainland. The communications between the two stations were further strengthened by setting up a direct V.H.F. radio link. In Fig. 34 a block diagram shows how the personnel engaged in the operations were linked up.

6. *Safety Precautions.*—The aircraft involved in the experiment operated at distances well away from the mainland and precautions were taken to ensure speedy air-sea rescue action in the event of a forced landing at sea. Care had also to be taken to minimise the danger to shipping in the area. Notices, quoting the danger area, were issued to the appropriate shipping authorities some days beforehand and as an additional precaution a *Lancaster* aircraft made a search of the area before the operation commenced. From the information of shipping movements, obtained by radio from the *Lancaster*, the controller at the ground station was able to decide whether to delay or modify the programme to allow the danger area to be clear. In addition an observer at the ground station, equipped with binoculars, kept the controller informed of the movement of the smaller fishing vessels nearer the point of release.

After completing its shipping search the *Lancaster* patrolled set courses near the scene of operations. In the event of the parent aircraft being forced to land in the sea, the *Lancaster*, which was equipped with air-sea rescue equipment, could be ordered to the rescue immediately, while full air-sea rescue operations from the mainland were on call.

7. *Training Operations.*—The limited endurance of the parent *Mosquito* and the risk which would be involved in having to land with the test vehicle fully charged with rocket fuel, made it essential that from the moment of take-off the whole operation should go as smoothly as possible. For this reason numerous training operations were undertaken both to develop a technique and to ensure that flying crew and ground operators were skilled in their individual tasks. Up to the date of release of the first test vehicle of the type described in this report a total of 34 operations had been carried out at the station; this included both training flights and operations of a similar nature with heavy bodies. These operations proved invaluable in raising the efficiency of the personnel and determining the limitations of the methods and apparatus used.

8. *Operational Procedure.*—The controller, in addition to his task of directing the aircraft, was responsible for the running of the ground station and for the co-ordination of effort of the ground crew during the operation. The authors here wish to pay acknowledgement to all the members of this crew whose enthusiasm and hard work contributed so much to the success of the operations and to the simplification of the controller's task.

After the decision to carry out an operation had been made the ground equipment was switched on and allowed to warm up; in the case of the telemetering equipment about 4 hours warm-up period was found necessary in order to reduce 'drift'. After this period the six telemetering indicators and the S.C.R. 584 scales were calibrated, the former against a crystal frequency and the latter with the aerial locked on to a fixed known target (Bishop Rock lighthouse). All cameras were loaded and checked and intercommunication and V.H.F. equipment tested.

The *Lancaster* aircraft then made its shipping search and the controller, if satisfied, gave the 'all clear' to the waiting aircrew at St. Eval. As early as possible, after take-off, radio communication was established between the aircraft and controller who, with the aid of G.C.I., directed the aircraft sufficiently close to the area to be located by the S.C.R. 584 radar equipment. The parent aircraft then circled the area, at the operational height, on courses prescribed by the controller, allowing him to determine wind drift while the telemetering equipment operators

satisfied themselves that reception was satisfactory. The controller informed the aircrew when they were about to commence their final circuit, thus allowing them time to prepare for release of the test vehicle. As the controller directed the aircraft on to and along the final release line he called out the distances to run to release, finally counting seconds from ten to zero, the latter being the instruction to release. At prearranged times during this counting period the time and sound recording equipment and cameras were switched on at a central switchboard. During the period of free flight of the test vehicle an intercommunication silence was maintained in order to allow the running commentary from the aircraft observer to be recorded without interference. When the test vehicle struck the sea or passed out of telemetering and radar range, all cameras and recorders were stopped and the parent aircraft and patrolling *Lancaster* given courses to steer for their base aerodrome.

Immediately after the flight a second series of calibrations was made of the telemetering indicators and S.C.R. 584 scales. The controller contacted the local coast-guard station to determine atmospheric details for the time of release. All cameras were unloaded and the films packed preparatory to transport to R.A.E. for processing.

The number of personnel involved at the ground station during these operations was as follows :—

- 1 Controller
- 2 S.C.R. 584 operators
- 1 G.C.I. operator
- 1 Ship spotter
- 1 Camera operator
- 2 Telemetering equipment operators.

APPENDIX IV

Parent Aircraft and Release Procedure

By

G. B. LOCHÉE-BAYNE

1. *General Considerations.*—The rocket motor which powered the test vehicle produced the necessary high thrust required to achieve supersonic flight, but owing to a high fuel consumption, inherent in this type of power unit, the duration of flight was short. To offset this limitation it was clearly advantageous to launch the test vehicle at a great altitude and at as high a speed as possible. Calculations showed that if a speed of $M = 1.3$ was to be attained (and it was thought such a speed was necessary if the full transonic speed range of effects was to be covered) then the vehicle should be launched at a true air speed of about 400 m.p.h. and at an altitude of about 36,000 ft.

In addition it was necessary to carry an observer in the parent aircraft since the launching procedure was fairly complex and the pilot would be fully occupied in flying the aircraft straight and level at the time of release.

With these requirements in mind the choice of a suitable aeroplane from which to launch the test vehicle was narrowed to a *Mosquito* XVIB.

2. *Parent Aircraft.*—The *Mosquito* XVIB, a mid-wing fighter-bomber of 20,000-lb all-up weight, had been adapted, during the war, to carry one 4,000-lb bomb and this store necessitated a ventral bulge and special bomb doors. The associated speed loss was objectionable in the present tests and the bulge was removed and standard bomb doors were fitted (Fig. 35). A special cradle was designed to pick up the existing strong points in the aircraft bomb-bay and the bomb-bay doors were so cut as to allow them to be opened and closed with the test vehicle crutched in position; this greatly facilitated the loading operation.

The fully instrumentated and fuelled test vehicle was a potential source of danger, and in addition to this its crutched position under the parent aircraft provided a hazard to the aircrew should they have to abandon the aircraft in an emergency. It was therefore imperative that the means of releasing the test vehicle should be multiple. To meet this the test vehicle was suspended from a standard electro-mechanical N-type release unit and this, in turn, was hung from a K-type release unit above it, independent release switches being fitted. This arrangement provided four means of releasing the vehicle, since each unit had one electrical and one mechanical switch. The top release unit however was for emergency use only as its operation jettisoned the lower release unit with the vehicle, thereby assuring that the lanyard-operated safety switch did not operate (Appendix I, section 3.7) and hence that the rocket motor did not function.

The suspension lug was spring-loaded so that on release it retracted to a flush-fitting position in the skin of the test vehicle; the original lugs were designed to fail, under tension, at $4\frac{1}{2}g$. During early development flights, while the parent aircraft was carrying test vehicle A1, an inadvertent entry was made into cumulo-nimbus cloud and the aircraft was thrown out of control. Preparations were made to abandon the aircraft, and the emergency escape hatch was jettisoned. Shortly after, however, the pilot regained control as the aircraft fell out of the bottom of the storm and it was flown back to base. Mounted on the escape hatch was a specially positioned mirror which enabled the observer to see the test vehicle in its crutched position; on jettisoning the escape hatch the mirror was lost too, and it was not until the aircraft returned to base that the loss of the test vehicle was ascertained.

The eye of the suspension lug and part of the shank was still held by the release unit, and examination showed the break to be a normal tensile fracture. These original lugs were designed as a weak link between parent aircraft and test vehicle, the former being stressed to $8g$ and the

latter to $4\frac{1}{2}g$, in the normal plane; thus should the test vehicle break up under severe loading stresses it would do so only after the weak link had failed and the risk of damage to the parent aircraft would be lessened.

After this mishap the weak link was dispensed with and more rigid restrictions imposed on flights in overcast weather when carrying the test vehicle. No further difficulties from this source were experienced.

3. *Parent Aircraft Equipment.*—3.1. *Automatic Observer.*—This unit, housed in the camera-bay at the rear of the fuselage contained the following instruments which were photographed by a Robot camera remotely operated from the cockpit by the observer:—A.S.I., altimeter, air thermometer, normal and longitudinal accelerometers and a clock.

At prearranged heights during the climb to operational altitude, and with the telemetering set switched on, camera exposures were made of the automatic observer panel. Down at the telemetering reception hut, on the Scilly Isles; camera records were made at identical moments and a comparison of the actual and the telemetered quantities was thus obtained.

3.2. *Air-to-Air Cameras.*—Initially there were four cameras installed to record the flight path of the test vehicle from the moment of release and until it passed out of view ahead of the parent aircraft.

A Vinten 35-mm ciné camera operating at 24 frames per second was mounted in the rearmost portion of the port engine nacelle and gave a three-quarter rear view of the vehicle during release. Its record helped to establish whether the test vehicle made a clean release; an optimum crutching angle had been worked out to promote this. After the first launch had been effected and the test vehicle was seen to leave its cradle satisfactorily the camera was withdrawn as having served its purpose.

Having passed through the limited field of vision of the Vinten camera the test vehicle was then picked up by an F.24 camera mounted vertically in the camera-bay at the aft end of the fuselage. This camera, operating at 1.2 seconds per frame, gave an excellent plan view of the initial glide and the start of the rocket motor.

For the next stage of the test vehicle's flight two further Vinten 35-mm ciné cameras, operating at 48 frames per second, one with a 2-in. and one with a 6-in. focal length lens were mounted at an angle of 45 deg and facing forward through the bomb aimer's window.

For the launching of the final vehicle, A3, and at the request of the Crown Film Unit who were charged with making a documentary film of the whole project, a final Vinten was mounted alongside the vertical F.24 in the normal camera-bay; running at 40 frames per second this camera secured a very effective record of the initial glide and early part of the powered flight.

The robot camera was separately operated for the auto-observer, but all other cameras were controlled by a single switch on the observer's control panel (Fig. 36) and a green indicator light gave warning of their operation.

As will be shown later, this switch was put on about 4 seconds before the release of the test vehicle to ensure that all cameras were working steadily at the crucial moment. A final exposure was made in the automatic observer at approximately the same instant as the other cameras were started.

3.3. *Battery Charging.*—To ensure that the accumulators in the test vehicle were at maximum charge when brought into operation they were trickle-charged from the parent aircraft; a switch on the observer's control panel provided this service and charging of the batteries was initiated soon after take-off and continued until about one minute before the release. A secondary aim of the charging was to keep the batteries warm at the very low temperatures encountered. The various electrical services provided from parent aircraft to test vehicle, prior to release, were carried *via* a pair of six-pin Jones type plugs; these pulled out at release leaving the flush fitting female portion in the test vehicle.

3.4. *Heating*.—The oxidant for the rocket motor was adversely affected by low temperature and it was necessary, therefore, to feed heat to the supply pipes which led it from the storage tanks to the motor. Warm air was tapped off the camera-bay supply in the parent aircraft, piped down through the bomb-bay and fed, *via* a T-piece, into the test vehicle at two points and there directed on to the vulnerable pipes. At release, the rubber supply pipes which were lashed to the cradle in the parent aircraft, pulled out of the test vehicle.

3.5. *Gyro Pre-spin Air*.—It was essential to have the automatic pilot in full control of the test vehicle immediately upon release, and to achieve this it was necessary to have the auto-pilot gyroscopes running at their full working speed before release.

To meet this requirement a supply of dry air, from storage bottles in the parent aircraft, was turned on to the gyroscopes about five minutes prior to the release. The supply of dry air was limited and in the event of a baulked bombing-run the observer could shut off the air until such time as the aircraft was deemed to be, again, within five minutes of the release point.

The dry air at a storage pressure of 1,800 lb/sq in. was dropped to 35 lb/sq in. by two reducing valves and fed to the test vehicle through a simple spring-loaded butt connection.

3.6. *Uncaging of Gyros*.—In launching the first test vehicle, A2, the uncaging of the gyros was initiated in parallel with starting the timing clock by a lanyard wire which, being attached to the parent aircraft, pulled out of the test model as it dropped away and thus closed a set of contacts. As this method failed in operation it was agreed that the vital operation of uncaging should be done before the release. Accordingly one electrical and one mechanical switch was provided and a warning light wired in series. If both switches failed to uncage the gyros there was to be no release of the test vehicle.

The lanyard switch referred to above, though no longer used for the uncaging operation, still served in its original role of starting the timing clock; *see* Appendix I.

3.7. *Intercommunication*.—Good communication between the parent aircraft and the ground station was of the first importance and as a safety precaution a second 4-channel V.H.F. set with its own aerial was fitted in the aircraft, as an entirely separate installation.

Considerable flight testing was done in an endeavour to perfect the link-up between aircraft and ground station, and one outcome of this was the erection of a high-angle aerial on the Scilly Isles ground station to improve the quality of the reception and transmission during the vital period when the parent aircraft was directly overhead. With the aircraft aerials mounted in the dorsal region, transmission and reception tended to be masked by the fuselage when overhead.

4. *Release Procedure*.—4.1. *Training*.—During flight testing of Telemetry and V.H.F. radio apparatus an opportunity was presented for ground and aircrews to rehearse their drill for the operational circuit, the bombing-run and the release.

Though the parent aircraft was well provided with cameras for recording the early stages of the test vehicle flight it was not thought likely that any of the later stages would be thus covered. Accordingly a much faster aircraft, the *Meteor IV*, was detailed to formate with the parent aircraft until the release and then to attempt to follow and photograph the test vehicle for as long as possible. The *Meteor* was equipped with five forward-facing G.S.A.P. 9-mm cameras housed in the gun positions.

This jet aircraft with its superior rate of climb would take off twenty minutes later than the parent aircraft and the two would then rendezvous in the Land's End area at operational height. On occasions, for a variety of reasons, the rendezvous was not easily achieved and this proved a serious time-waster especially to the *Meteor* with its limited flight duration.

If atmospheric conditions were suitable both aircraft would be producing a vapour trail and a rendezvous was easily effected, but failing this natural phenomenon and despite the vigilance of the aircrews, through iced-up canopies, the meeting was, on occasions, a protracted business. To alleviate this the parent aircraft was fitted with a small rack under each wing, utilising the normal drop-tank mountings, and each rack carried four smoke bombs which could be ignited electrically by a switch in the cockpit. On the ground the volume of smoke produced by one bomb was very considerable, but in flight it was necessary to fire all four bombs in both racks before even a modest trail could be produced.

During the training period it also became evident that the *Meteor*, a metal aircraft in formation with the parent aircraft, largely of wooden construction, was a better reflector for the radar beam and it could and did happen that the radar operator would in error lock-on to the echo from the observation aircraft.

Finally, station-keeping at this high altitude with two inherently different aircraft was a difficult feat, and so it was that after the release of test vehicle A2, the *Meteor* was not again used.

A table of operations headed 'Cockpit Drill' is here submitted and in reading this, reference may be made to Fig. 36 which shows the observer's control panel with the relevant switches.

4.2. Cockpit Drill.

<i>Action</i>	<i>Result</i>
(1) After take-off and at commencement of climb, adjust aircraft radiator shutters	Optimum supply of warm air to test vehicle
(2) Switch on:— Control-panel master switch Telemetrying Transponder Pitot heater Battery charging Auto-observer lights	Control panel made 'live' Six-channel telemetrying set transmitting Pulse device working, to assist tracking Heat to pitot-static head of test vehicle Test-vehicle accumulators on charge Lights switched on in auto observer
(3) At 20,000 ft, 25,000 ft and 30,000 ft call controller and arrange to do a telemetrying check	Controller counted 5-4-3-2-1-CHECK, and on 'CHECK' observer pressed button for camera in auto-observer. Radar base made a camera exposure, at same instant, of telemetered quantities
(4) In circuit, at 36,000 ft, and at estimated 5 minutes from release point, turn on gyro pre-spin air	Dry air fed to gyros in test vehicle auto-pilot to ensure full working r.p.m. at release
(5) On bombing-run, at 15,000 yards to go, check that RED warning lights are out	If these lights came on at any time they indicated that the lanyard switch was closed or shorted; accordingly the operation 'arm clock' was not performed until immediately before release as no safety interval now existed

<i>Action</i>	<i>Result</i>
(6) With no red lights on :— Plug in arming jack Arm rocket Arm clock Switch off battery charging	A detachable safety link, carried by the observer, to isolate the danger circuits until these were needed This closed the latching relay in the rocket-motor starting circuit and it now remained for the timing clock to close the remaining relay Current fed up to one side of the lanyard switch. Removal of lanyard switch at release completed clock circuit Test-vehicle batteries ' off charge '
(7) At 1,000 yards to go the Controller started counting in seconds thus :— 10-9-8-7-6-5-4-3-2-1-ZERO At -4- switch on cameras At -2- operate uncage switch	All air-to-air cameras operated White indicator lights indicated that gyro was uncaged. If no lights appeared use manual device for uncaging. If lights still did not appear no release of test vehicle was to be made
(8) At -ZERO- press release button	Release of test vehicle

At release the pilot pressed the ' transmit ' button on the V.H.F. set and the observer began a commentary on the behaviour of the test vehicle from the moment it left the parent aircraft ; this commentary was recorded by a wire recorder at the Scilly Isles ground station.

The pilot continued to fly the aircraft straight and level so that the air-to-air cameras could fulfil their designed role.

TABLE 1

Leading Particulars of Test Vehicle

Wing

Span (overall)	8.07 ft
Gross area (straight across the body)	12.75 ft ²
Net area	9.75 ft ²
Root chord	2.00 ft
Mean chord (based on gross area)	1.58 ft
Aspect ratio (based on gross area)	5.11
Thickness/chord ratio at root	7½ per cent
Thickness/chord ratio at tip	4 per cent
Section	biconvex
Dihedral	2 deg
Setting to body centre-line	0.55 deg
Sweepback of half-chord line	0 deg
Distance of mean quarter-chord point behind leading-edge root	0.57 ft.
Distance of wing half-chord line behind body nose	4.89 ft
Aileron area, each	0.44 ft ²

Tail

Span (overall)	4.74 ft
Gross area (straight across the body)	4.85 ft ²
Net area	3.24 ft ²
Mean chord (based on gross area)	1.02 ft
Aspect ratio (based on gross area)	4.63
Thickness/chord ratio at root	7.07 per cent
Thickness/chord ratio at tip	4.75 per cent
Section	biconvex
Dihedral	0 deg
Sweepback of quarter-chord line	25 deg
Sweepback of half-chord line	20 deg
Distance of hinge-line behind body nose	8.37 ft

Fin

Height (to body centre-line)	2.17 ft
Net area, including dorsal portion	1.82 ft ²
Thickness/chord ratio at root	7½ per cent
Thickness/chord ratio at tip	4½ per cent
Section	biconvex
Sweepback of half-chord line	7 deg

Body

Length, excluding pitot-tube	10.99 ft
Length, including pitot-tube	11.74 ft
Diameter	1.50 ft
Frontal area	1.77 ft ²
Length of nose	2.99 ft
External diameter at exit	0.41 ft
Internal diameter at exit	0.38 ft

TABLE 1—*continued*

<i>Weight</i>											
At start of burning	937 lb
At end of burning	663 lb
<i>Moments of inertia at mean weight</i>											
In pitch	5,400 lb ft ²
In roll	340 lb ft ²
<i>C.G.</i>											
Distance behind body nose (constant during burning)	4.58 ft

TABLE 2

List of Test Vehicles in Chronological Order

Ref.	Type	Details
A1	Complete	Lost in cloud during early flight trials—30.5.47
A2	Complete	First release—rocket motor failed to ignite—8.10.47
A9	Fuselage	Rocket motor starting tests. Release from 35,000 ft—evidence of ignition—29.2.48
A8	Fuselage	Rocket motor starting tests. Release from 35,000 ft—no evidence of ignition—5.3.48
A12	Fuselage	Rocket motor starting tests. Release from 25,000 ft—ignition successful—7.6.48
A11	Fuselage	Rocket motor starting tests. Release from 35,000 ft—explosion in tail—9.6.48
A10	Fuselage	Rocket motor starting tests. Release from 35,000 ft with igniter—ignition successful—2.10.48
A3	Complete	Second release—results reported here—9.10.48

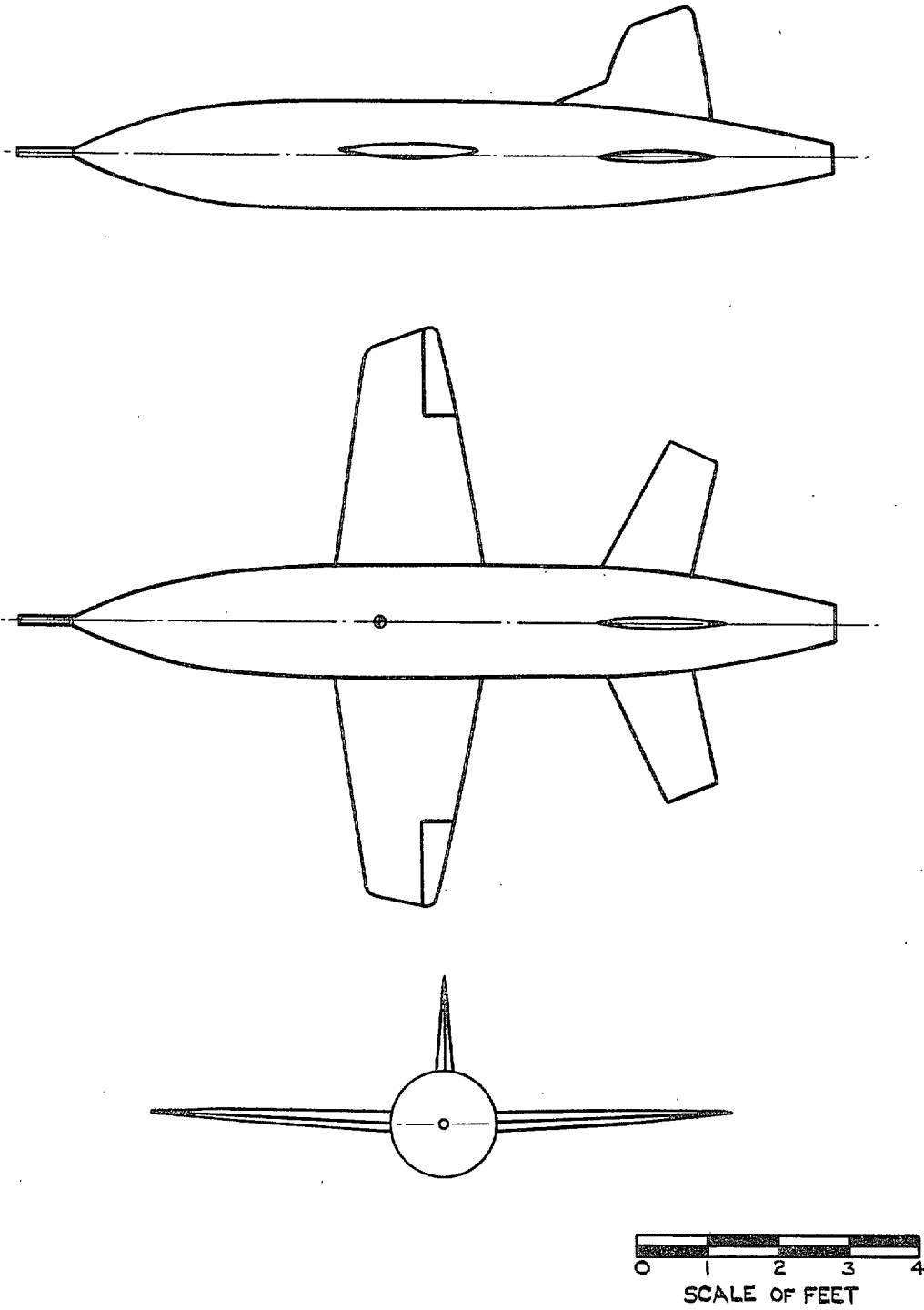

FIG. 1. General arrangement of test vehicle. R.A.E.-Vickers rocket model.

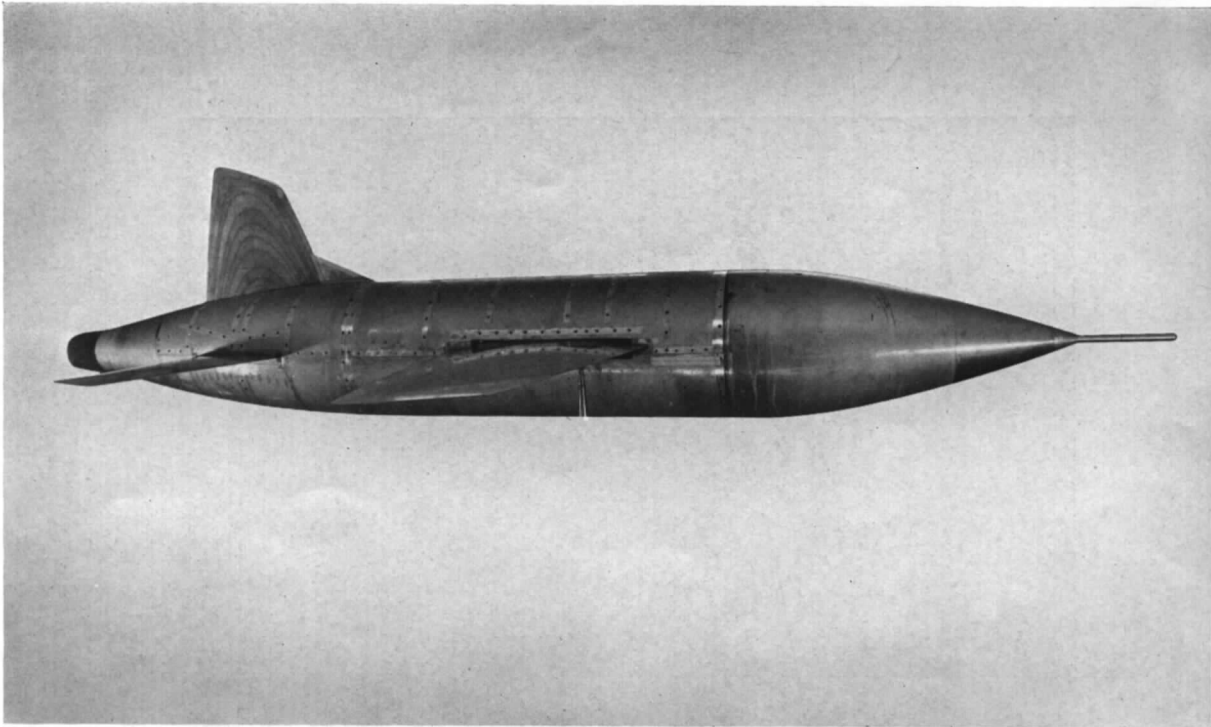

FIG. 2. R.A.E.-Vickers rocket model. Note : No external finish in this photograph.

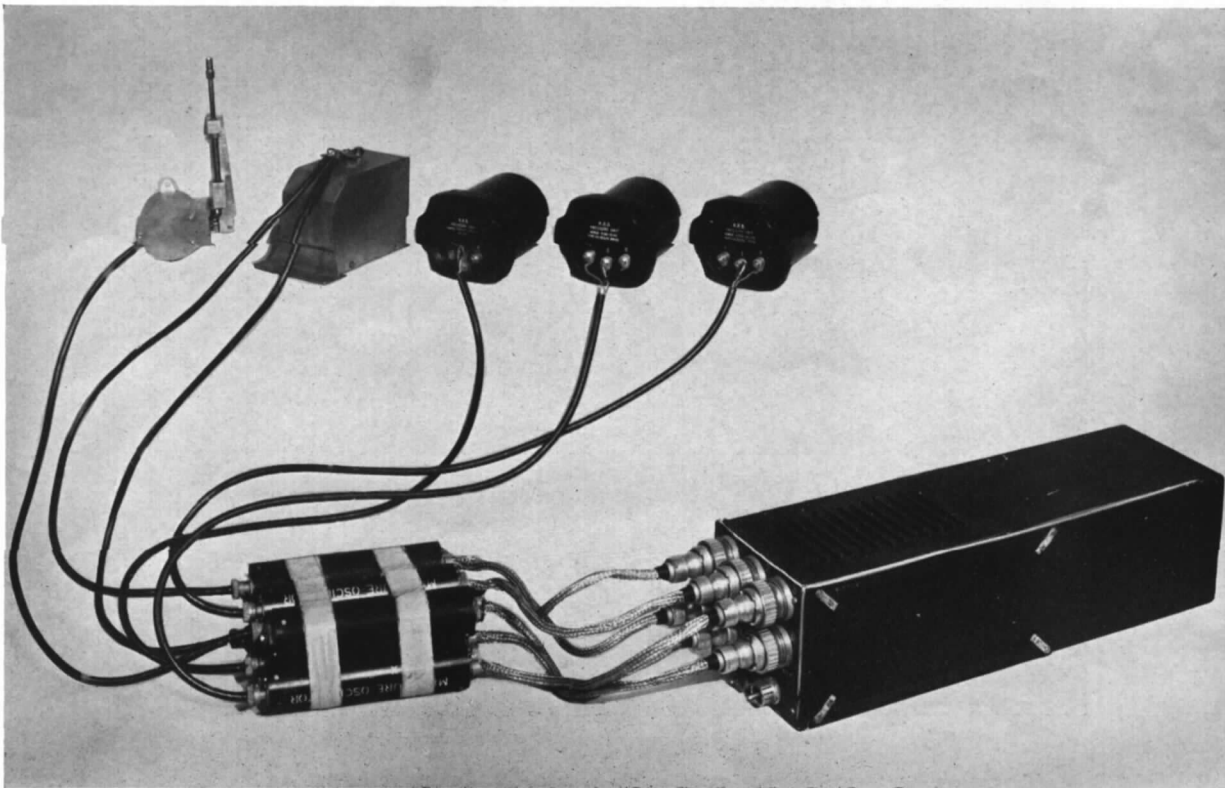

FIG. 3. Telemetry pick-ups, oscillators and transmitter.

48

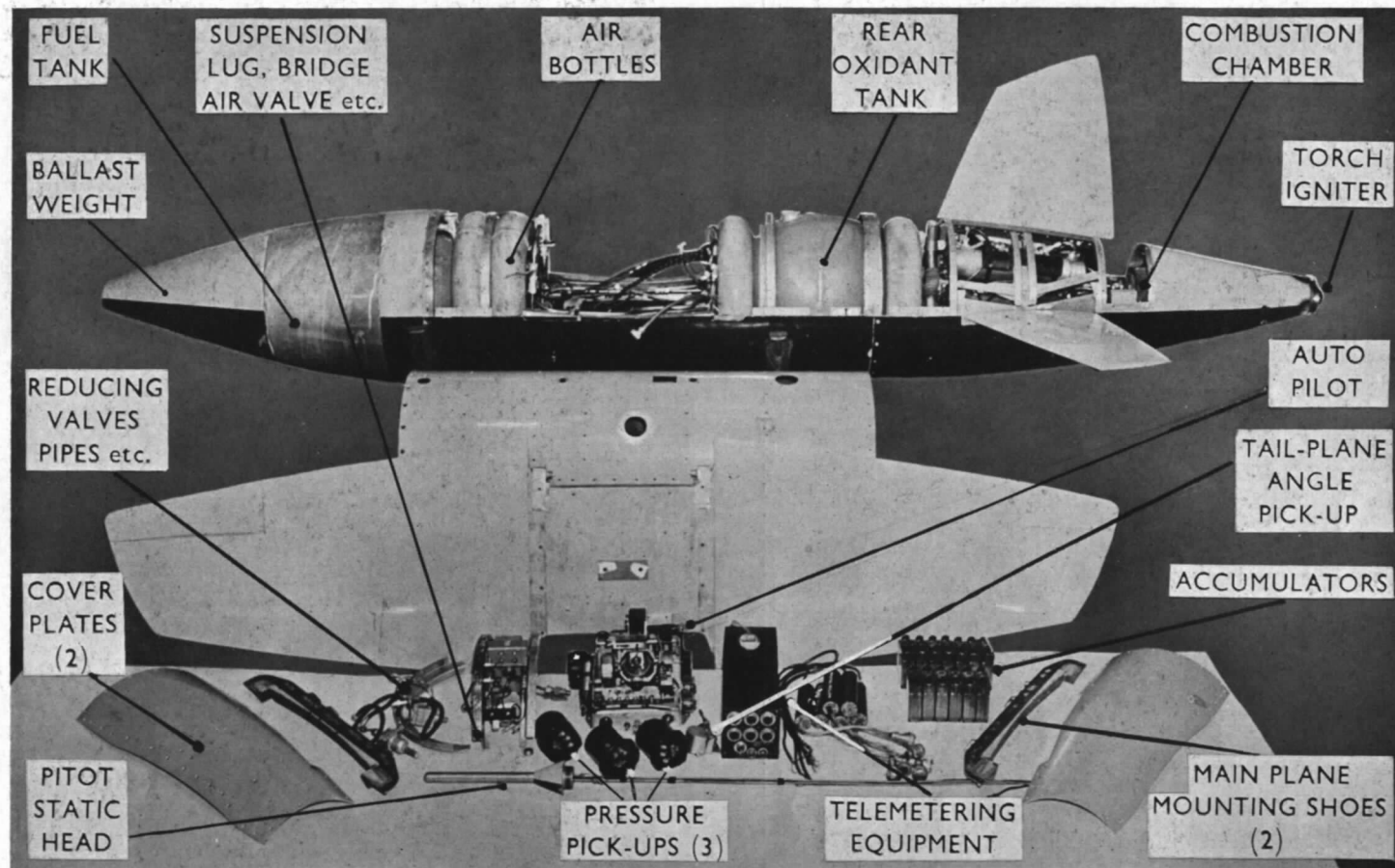
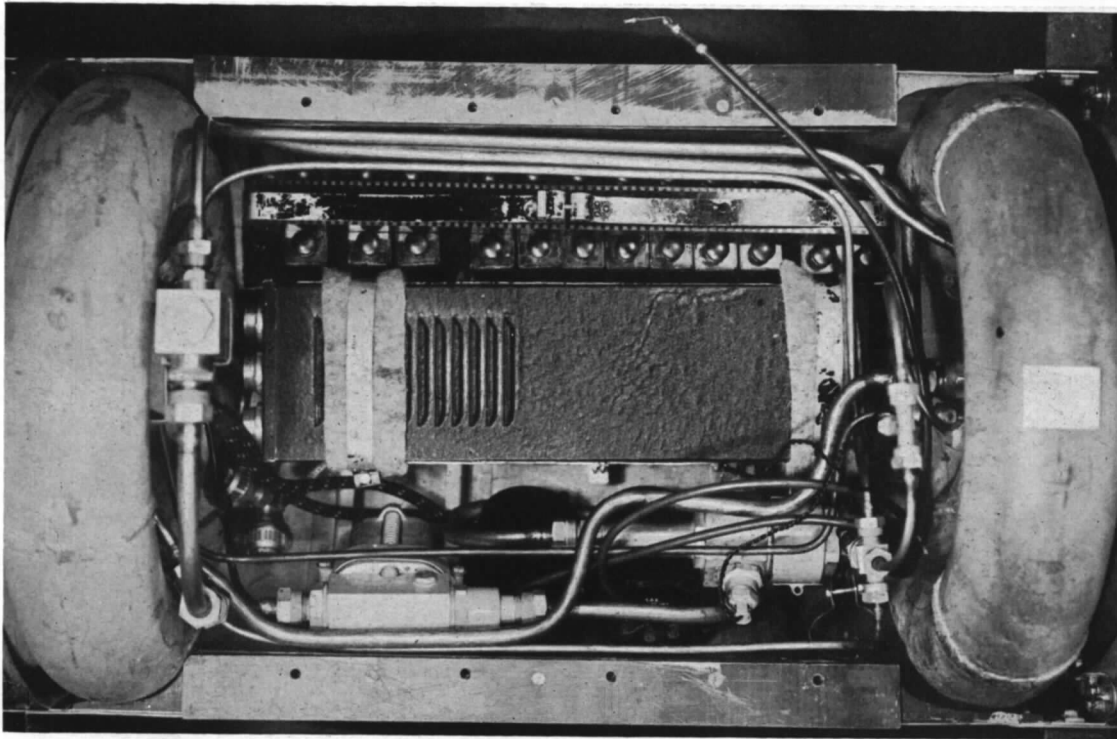
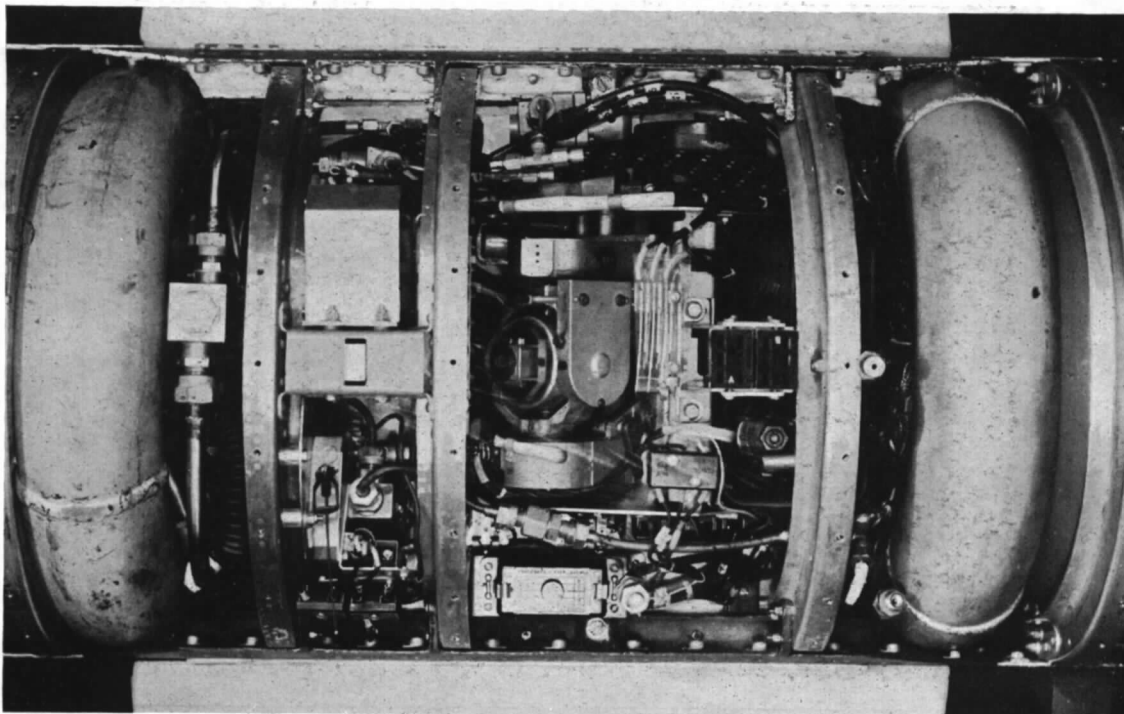

FIG. 4. Test vehicle partly assembled.



a. Equipment below wing.



b. Equipment above wing.

FIGS. 5a and 5b. Assembly of equipment in centre-section.

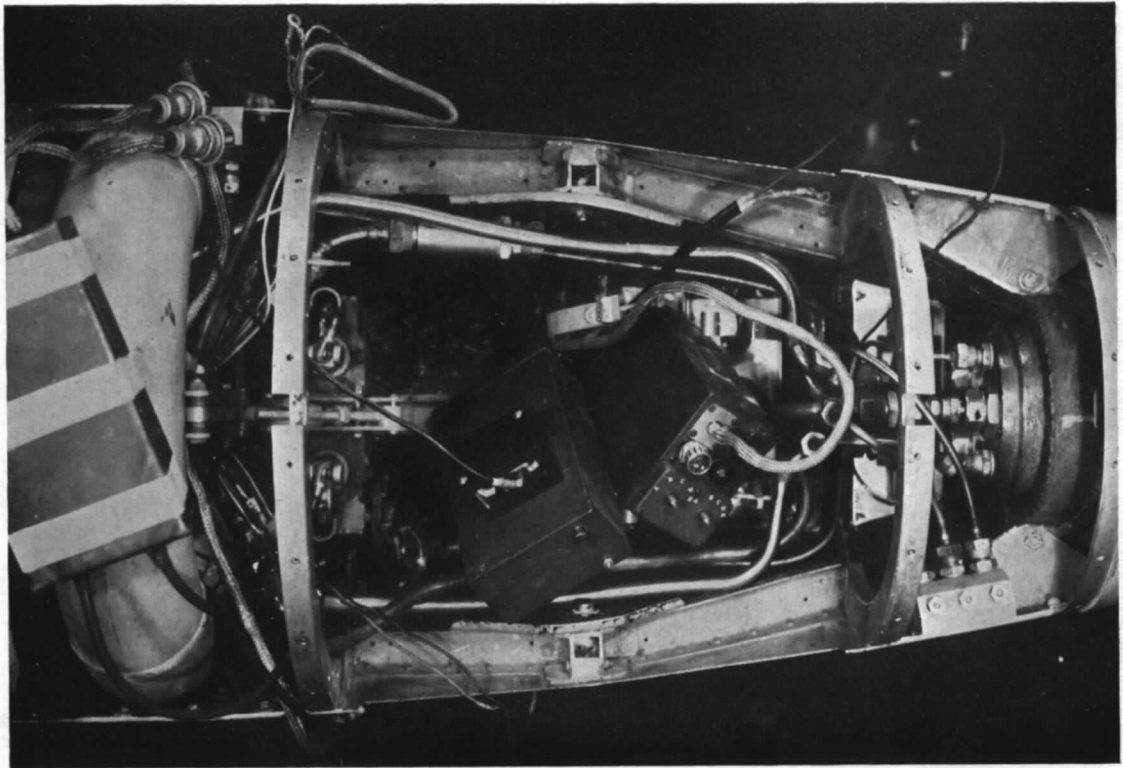

a. Equipment below tailplane.

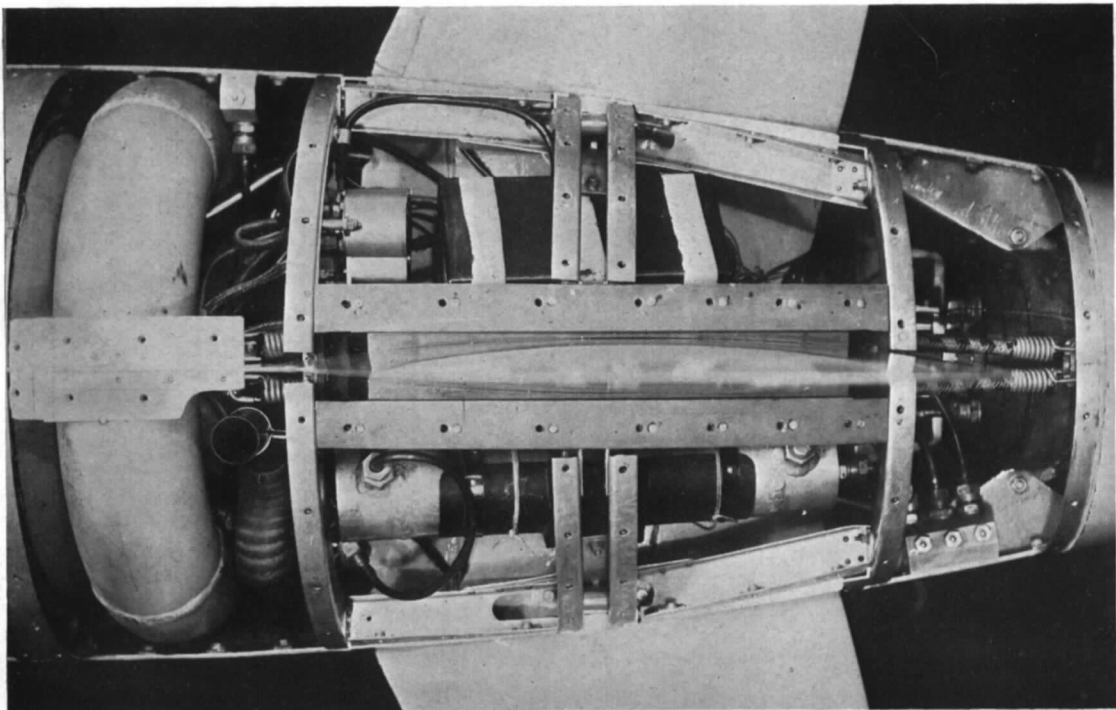

b. Equipment above tailplane.

FIGS. 6a and 6b. Assembly of equipment in rear section.

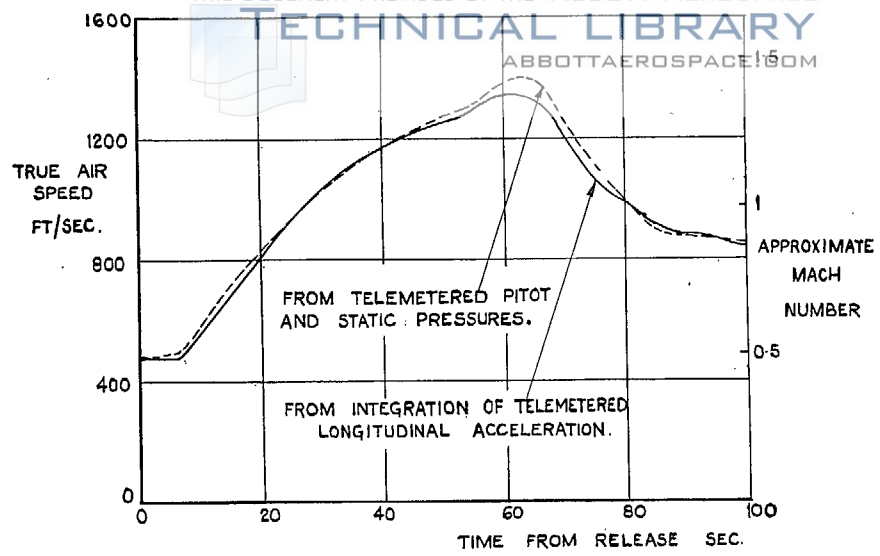

FIG. 7. Variation of speed during flight.

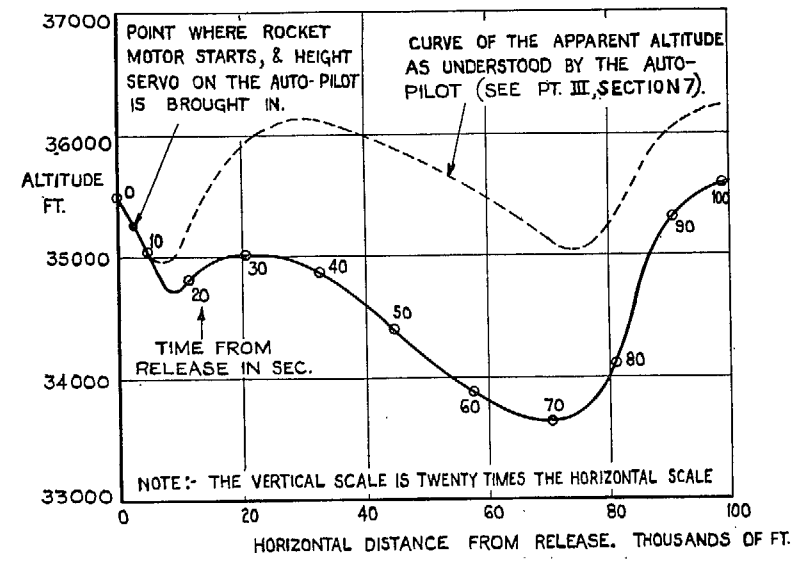

FIG. 9. Variation of altitude during flight.

51

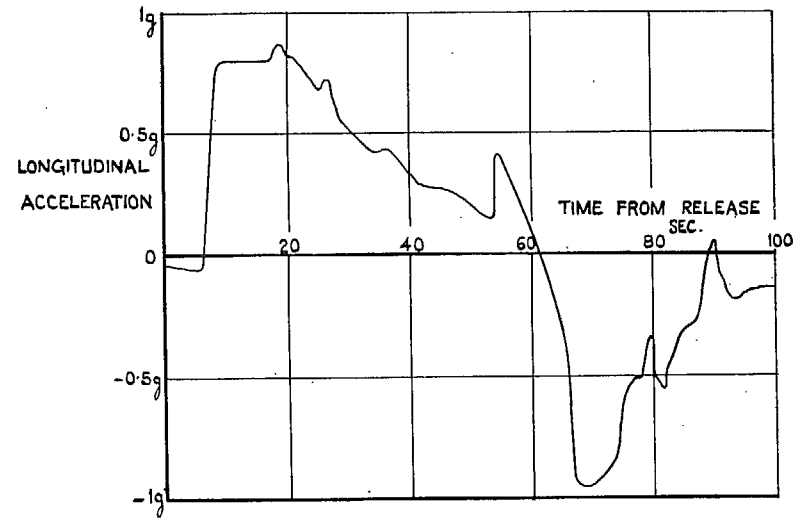

FIG. 8. Variation of longitudinal acceleration during flight.

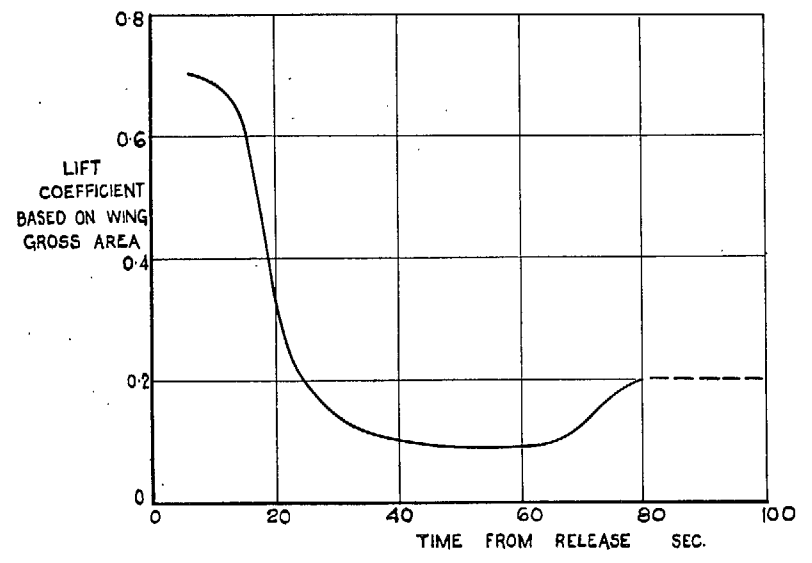

FIG. 10. Variation of lift coefficient during flight.

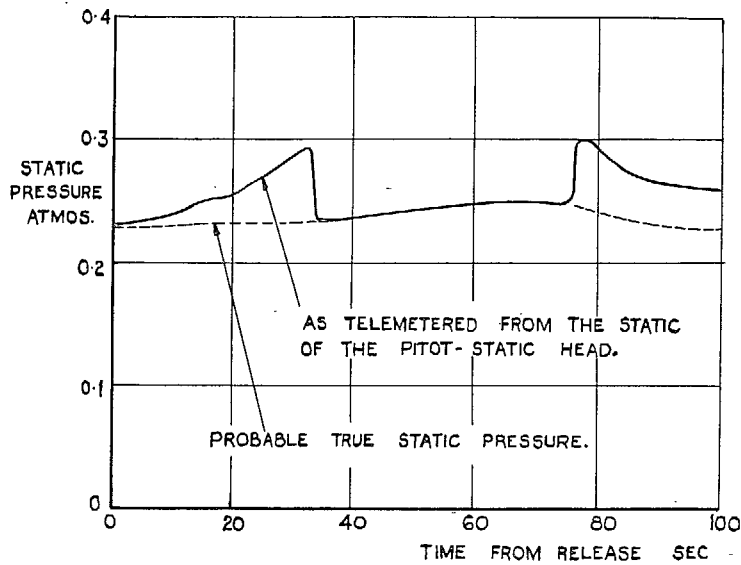

FIG. 11. Variation of static pressure during flight.

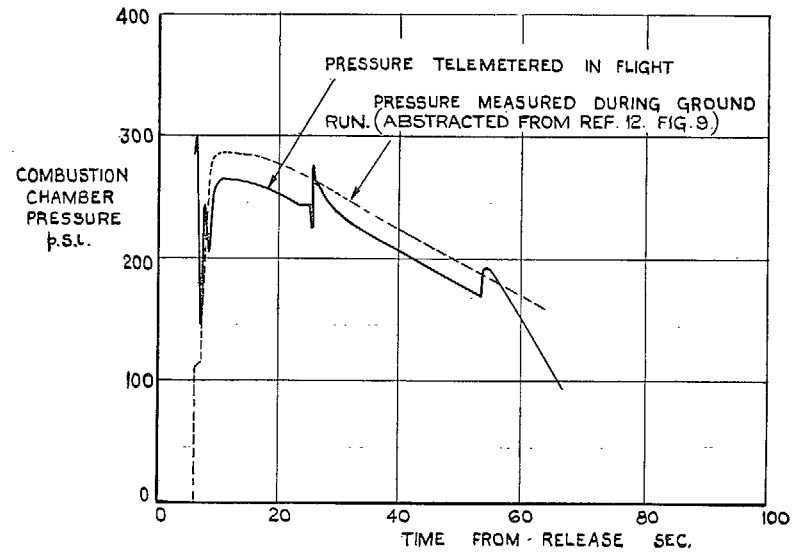

FIG. 13. Variation of combustion-chamber pressure during flight.

52

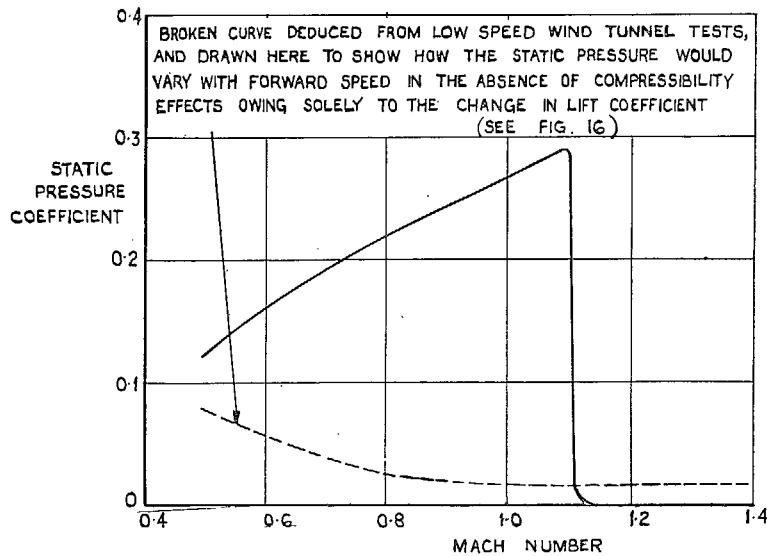

FIG. 12. Variation of static pressure at the position of the static of the pitot-static head with Mach number.

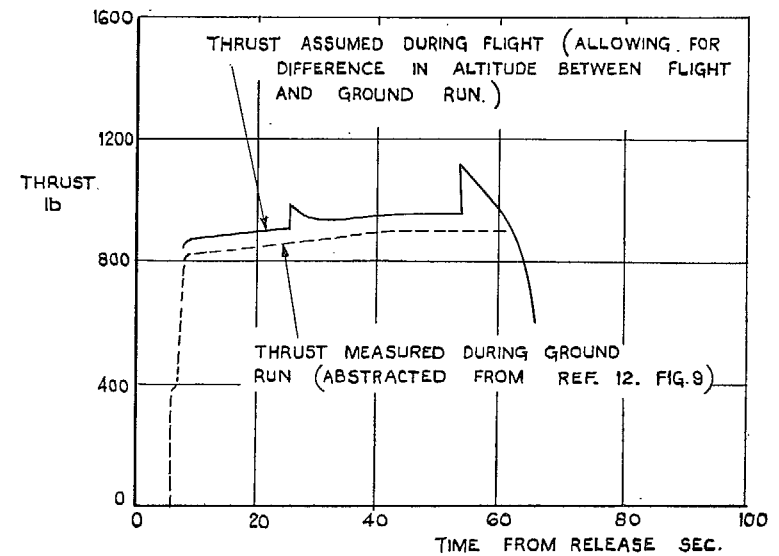

FIG. 14. Variation of thrust during flight.

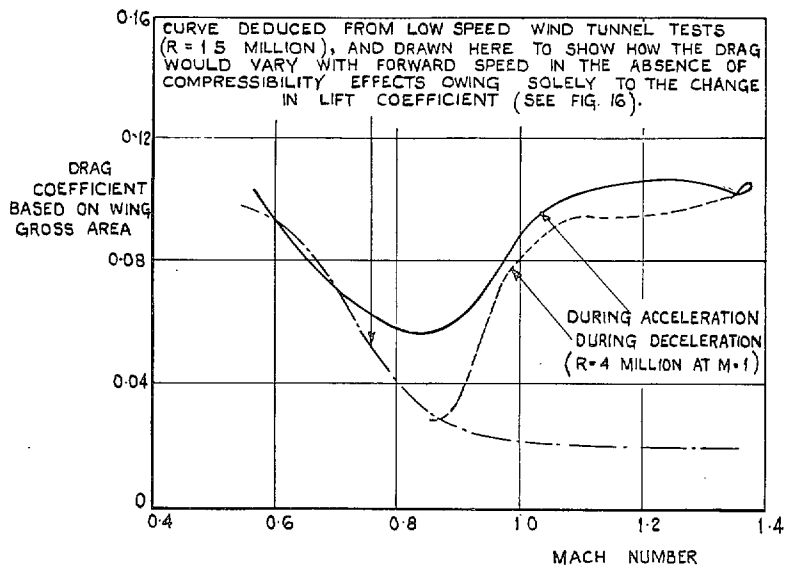

FIG. 15. Variation of drag with Mach number.

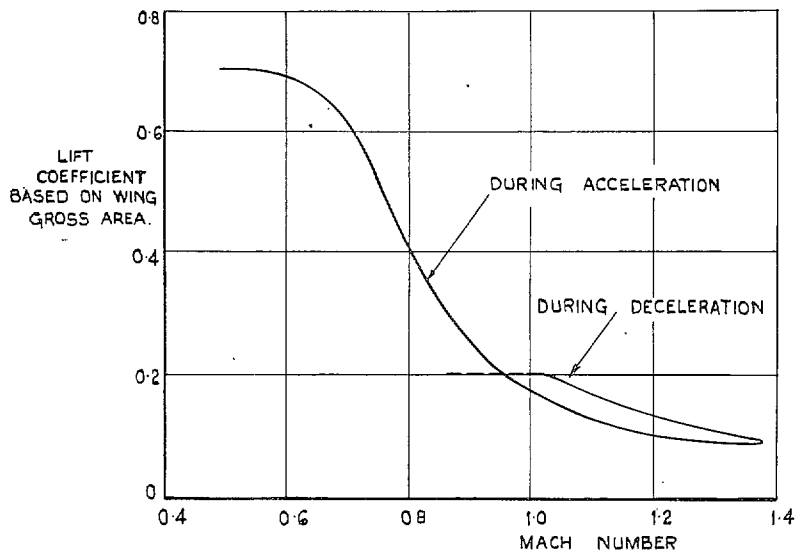

FIG. 16. Variation of lift with Mach number.

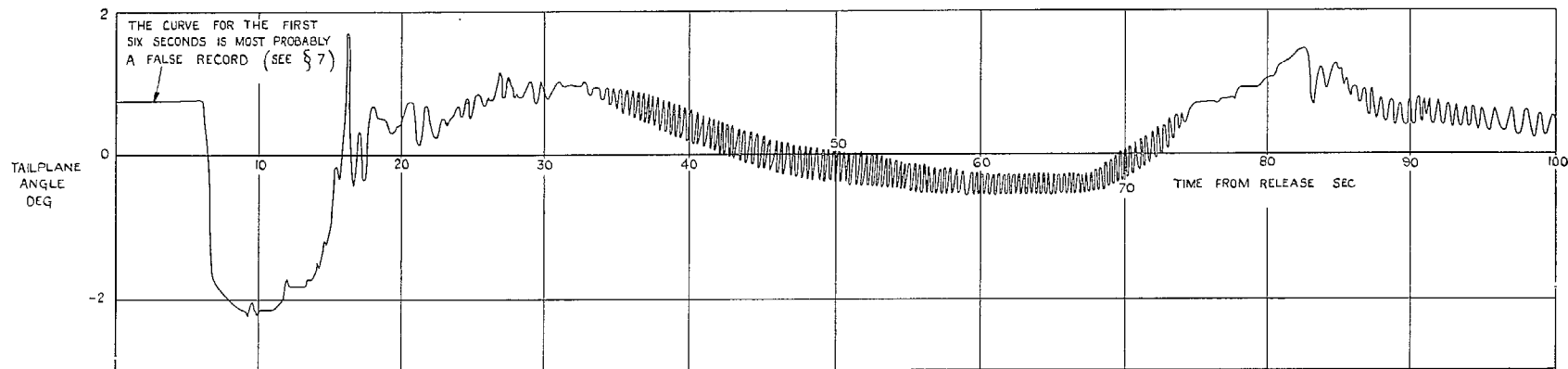

FIG. 17. Variation of tailplane angle during flight.

54

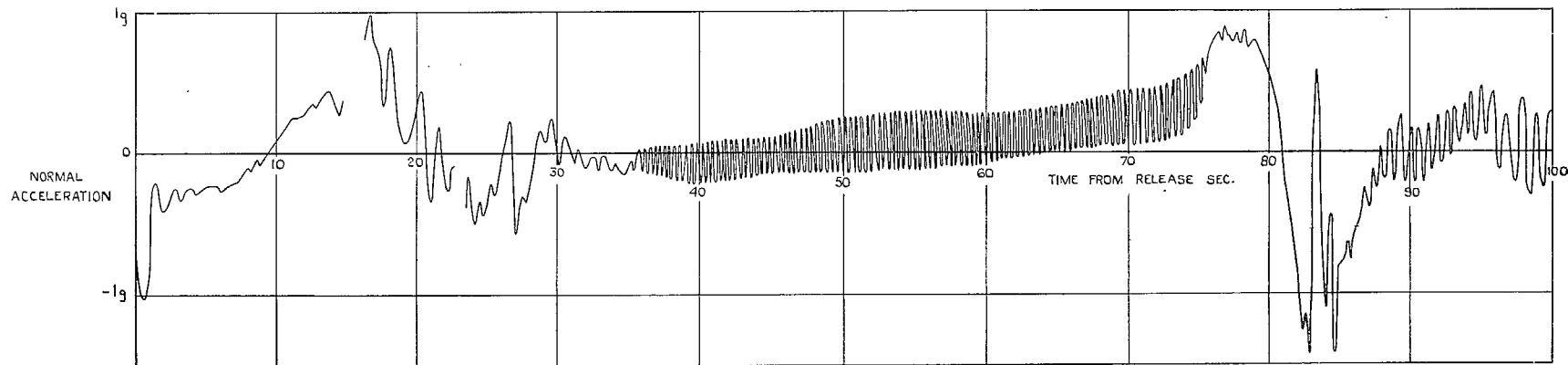

FIG. 18. Variation of normal acceleration during flight.

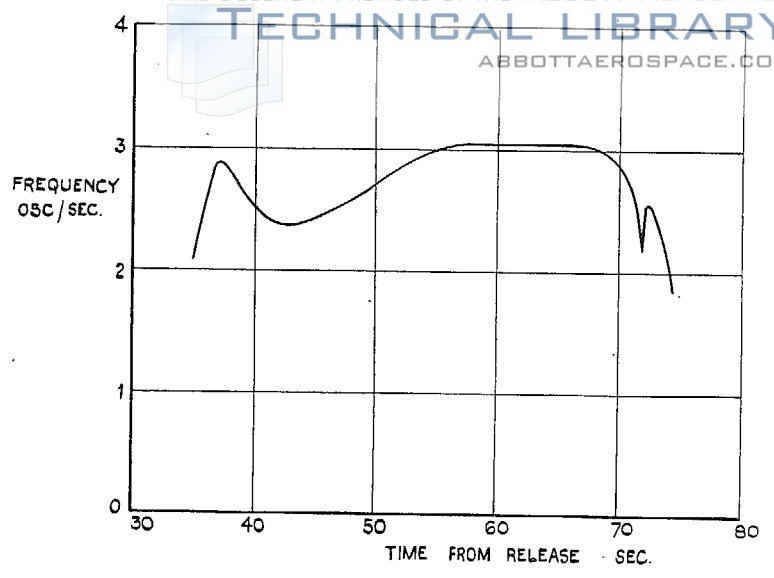

FIG. 19. Variation of frequency of oscillations in tailplane angle and normal acceleration during flight.

55

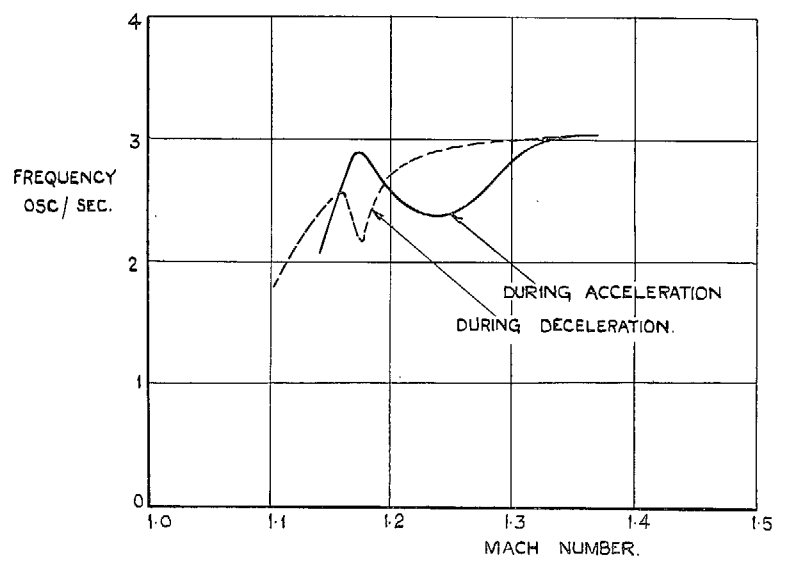

FIG. 20. Variation of frequency of oscillations in tailplane angle and normal acceleration with Mach number.

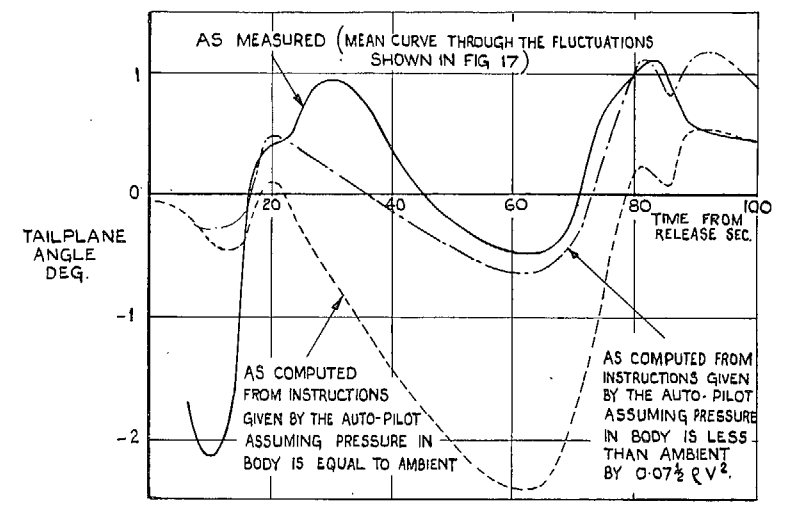

FIG. 21. Comparison of tailplane angle as measured direct with angle as computed from instructions given by the auto-pilot.

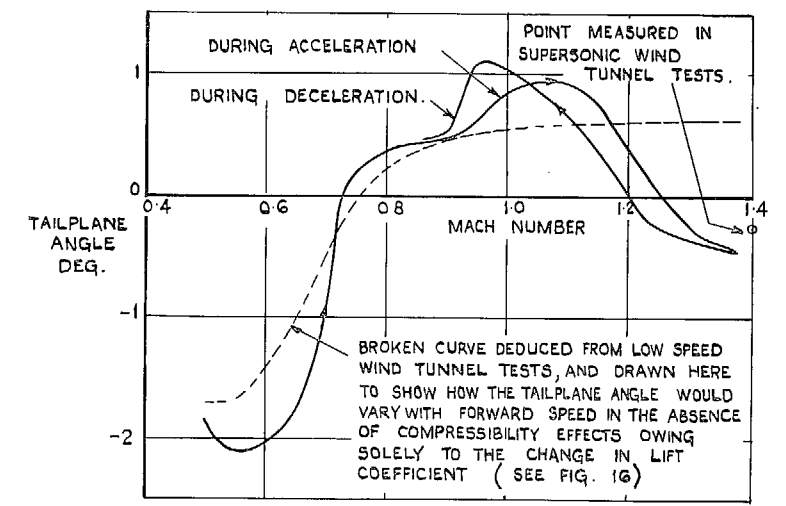
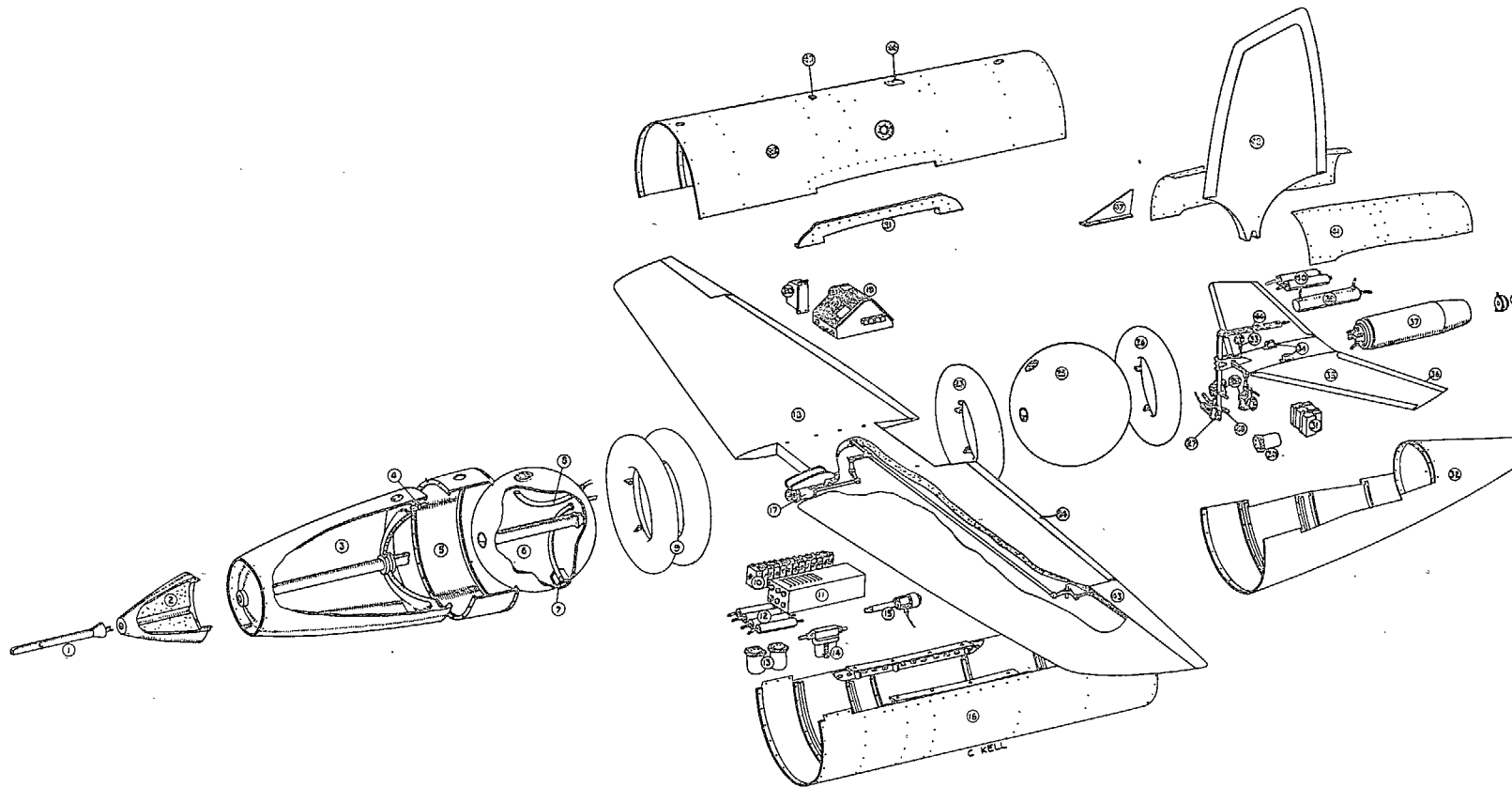

FIG. 22. Variation of tailplane angle with Mach number.

56



- 1 PITOT-STATIC TUBE
- 2 BALLAST COMPARTMENT
- 3 FUEL TANK
- 4 AIR SUPPLY NON-RETURN VALVE
- 5 CAST FUSELAGE SECTION
- 6 FRONT PEROXIDE TANK
- 7 ANTI-SWIRL VANES ON OUTLET PIPE
- 8 TANK PRESSURISING AIR PIPE
- 9 AIR BOTTLES SUPPLYING EXPULSION AIR
- 10 ACCUMULATORS SUPPLYING ELECTRICAL SERVICES
- 11 TELEMETERING TRANSMITTER
- 12 TELEMETERING OSCILLATORS
- 13 PITOT & STATIC PRESSURE INSTRUMENTS

- 14 AIR PRESSURE REDUCING VALVE
- 15 CARTRIDGE OPERATED AIR STARTING VALVE
- 16 BOTTOM CENTRE SECTION COWLING
- 17 AILERON SERVO
- 18 MAIN PLANE
- 19 AUTOMATIC PILOT
- 20 NORMAL & LONGITUDINAL ACCELEROMETERS
- 21 WING CLAMPING SHOE
- 22 TOP CENTRE SECTION COWLING
- 23 AIR BOTTLE SUPPLYING EXPULSION AIR
- 24 TRAILING EDGE INSERTS FORMING TELEMETERING AERIALS

- 25 REAR PEROXIDE TANK
- 26 AIR BOTTLE SUPPLYING AUXILIARY SERVICES
- 27 CARTRIDGE EJECTED RETAINING PIN
- 28 RUBBER PIPE SUPPLYING AIR TO TAIL PLANE SERVOS
- 29 TAIL PLANE ATTITUDE & ALTITUDE SERVOS
- 30 COMBUSTION CHAMBER PRESSURE INSTRUMENT
- 31 RADAR TRANSPONDER
- 32 REAR COWLING
- 33 TAIL PLANE INCIDENCE INSTRUMENT
- 34 TAIL PLANE HINGE SUPPORT LUGS
- 35 TAIL PLANE

- 36 TRAILING EDGE INSERTS FORMING TRANSPONDER AERIALS
- 37 COMBUSTION CHAMBER
- 38 COMBUSTION CHAMBER IGNITER
- 39 TOLUENE TANK FOR SMOKE PRODUCTION
- 40 TELEMETERING OSCILLATORS
- 41 REAR TOP COWLING
- 42 FIN
- 43 AILERON
- 44 ELASTIC CORD
- 45 POSITION OF RETRACTING LIFTING HOOK
- 46 POSITION OF ELECTRIC SUPPLY PLUG FROM PARENT AIRCRAFT
- 47 DORSAL FIN

FIG. 23. The R.A.E.-Vickers transonic rocket model.

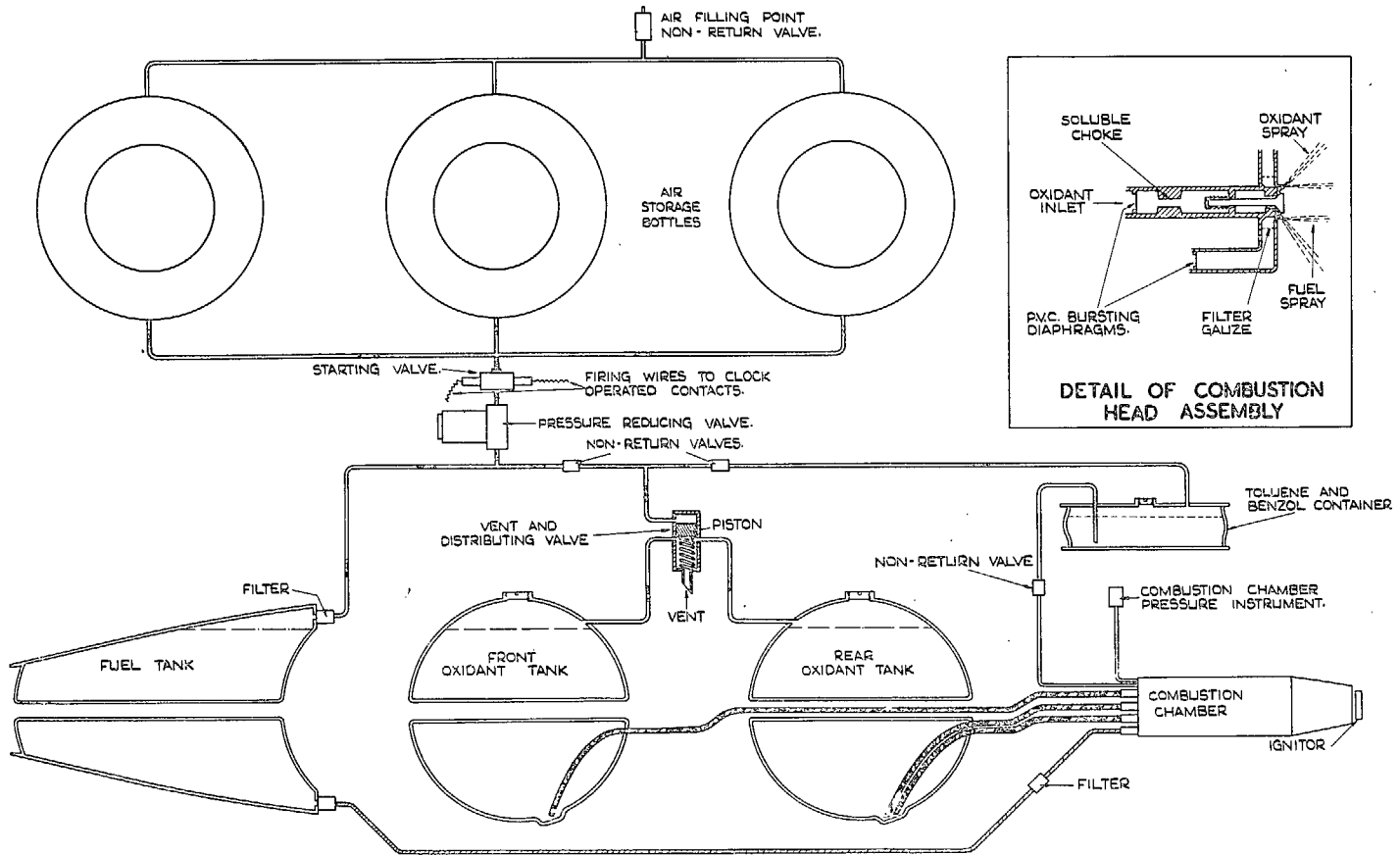

57

FIG. 24. Diagrammatic layout of fuel and oxidant system.

58

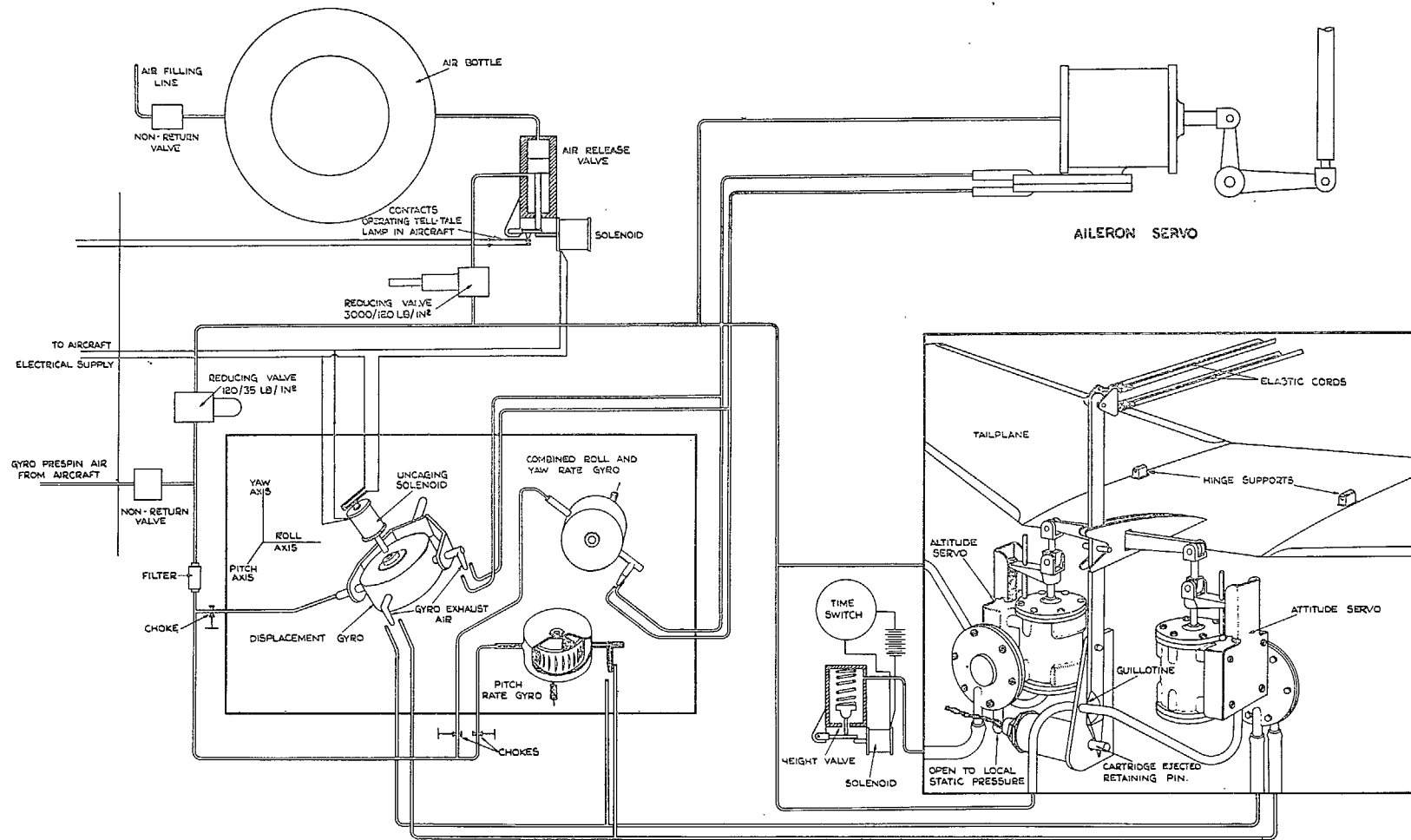

FIG. 25. Diagram of test vehicle control system.

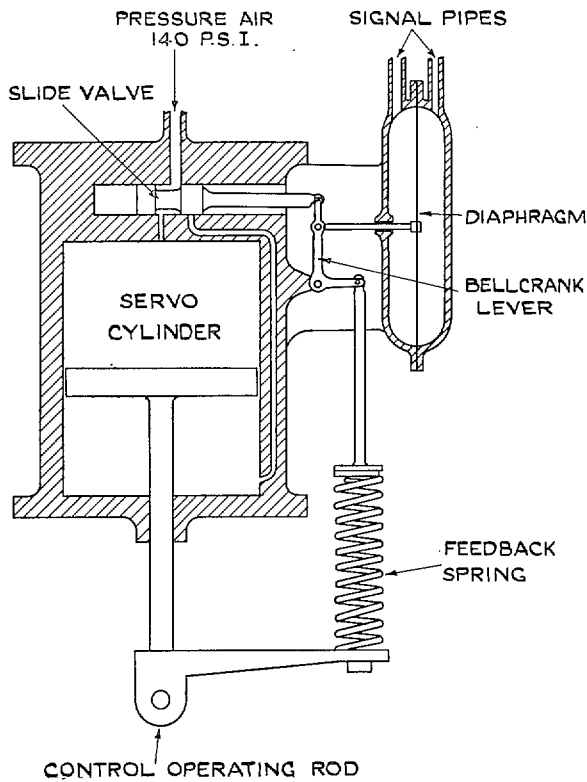

FIG. 26. Feedback mechanism for aileron servo.

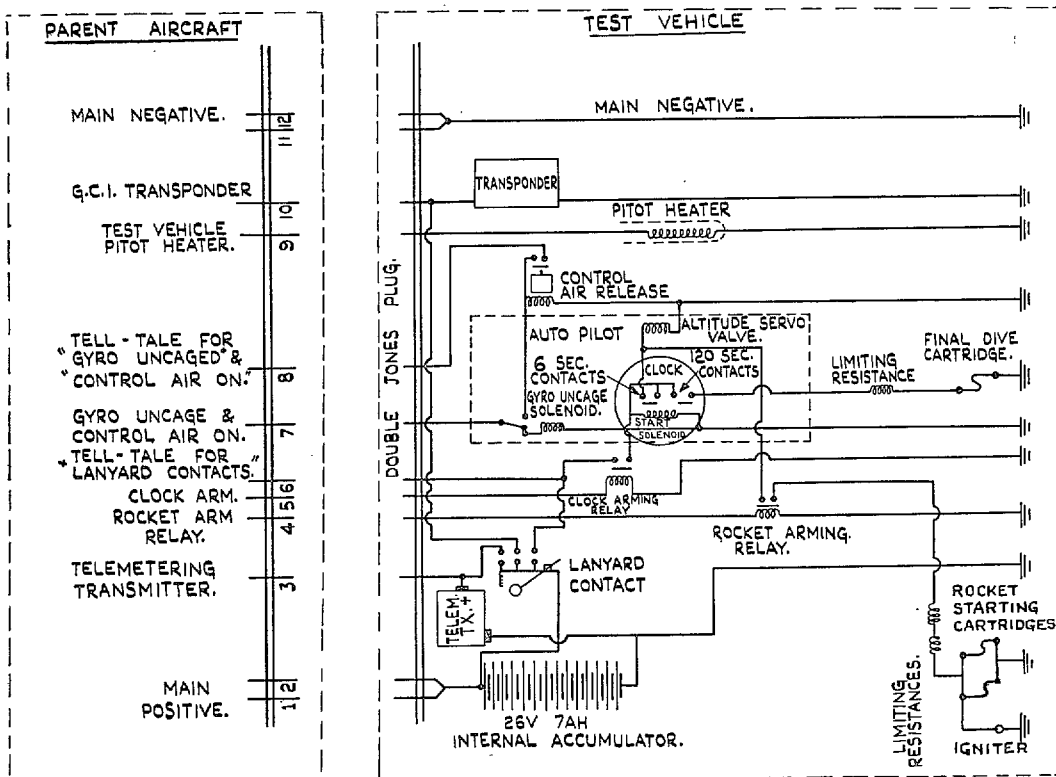

FIG. 27. Diagram of electrical circuits.

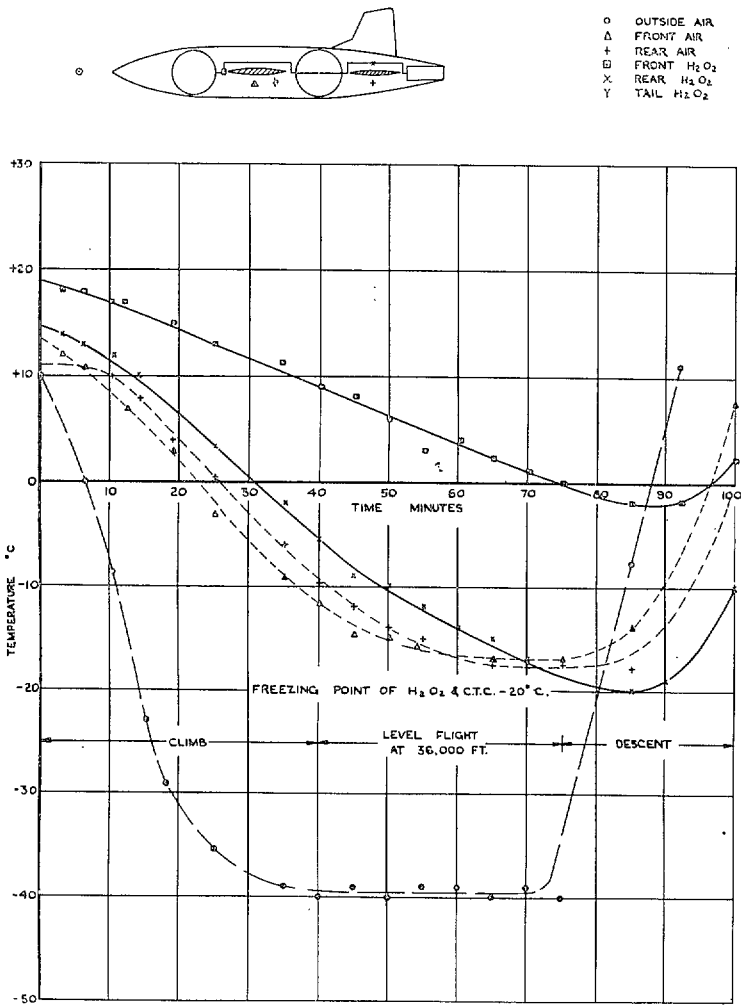

FIG. 28. Air and hydrogen peroxide temperatures on vehicle A10. Flight 1—6.4.48.

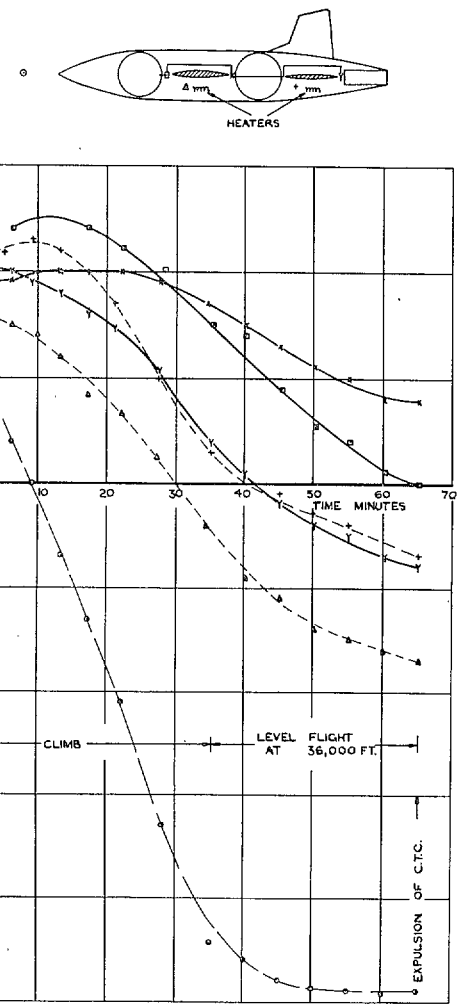

FIG. 29. Air and carbon tetrachloride temperatures on vehicle A10. Carbon tetrachloride expelled at altitude. Flight 10—5.6.48.

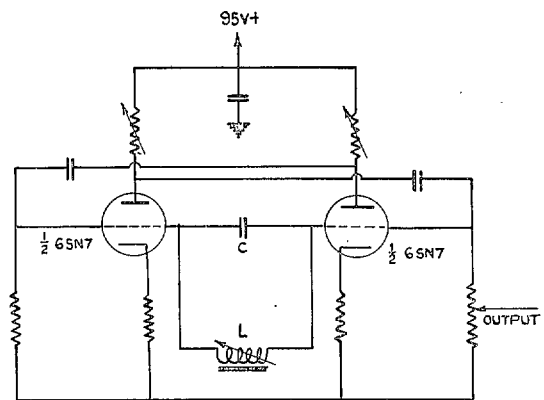

FIG. 30. Basic circuit of telemetering equipment audio oscillator.

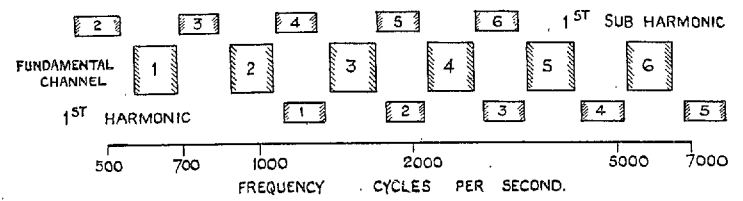
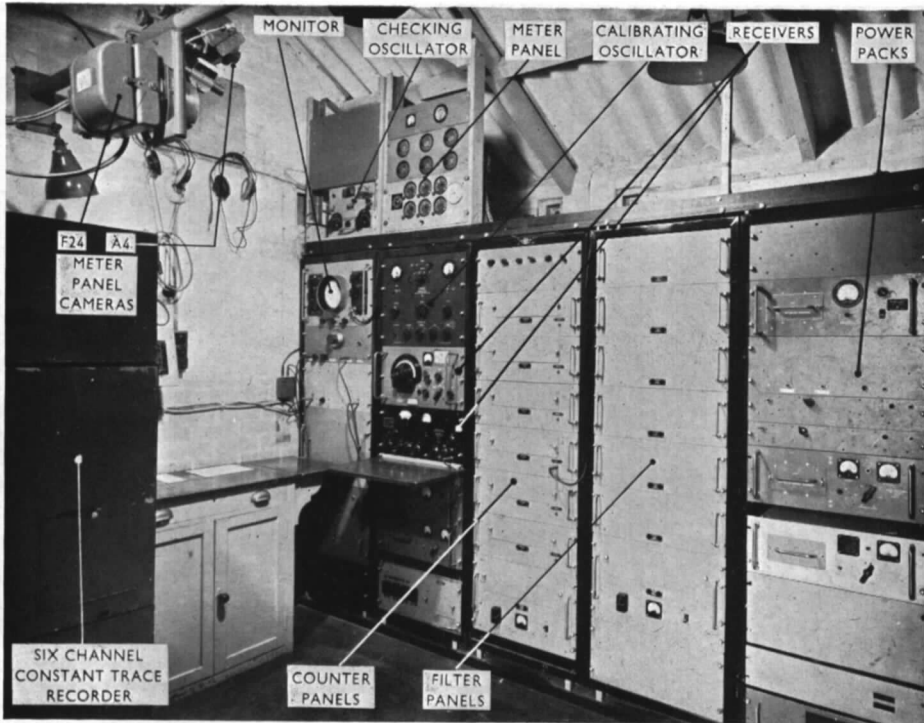

FIG. 31. Telemetering system audio-frequency spectrum.



a. Filters, power packs, counter panels.



b. Constant trace recorder.

FIGS. 32a and 32b. Telemetry reception equipment at Scilly Isles.

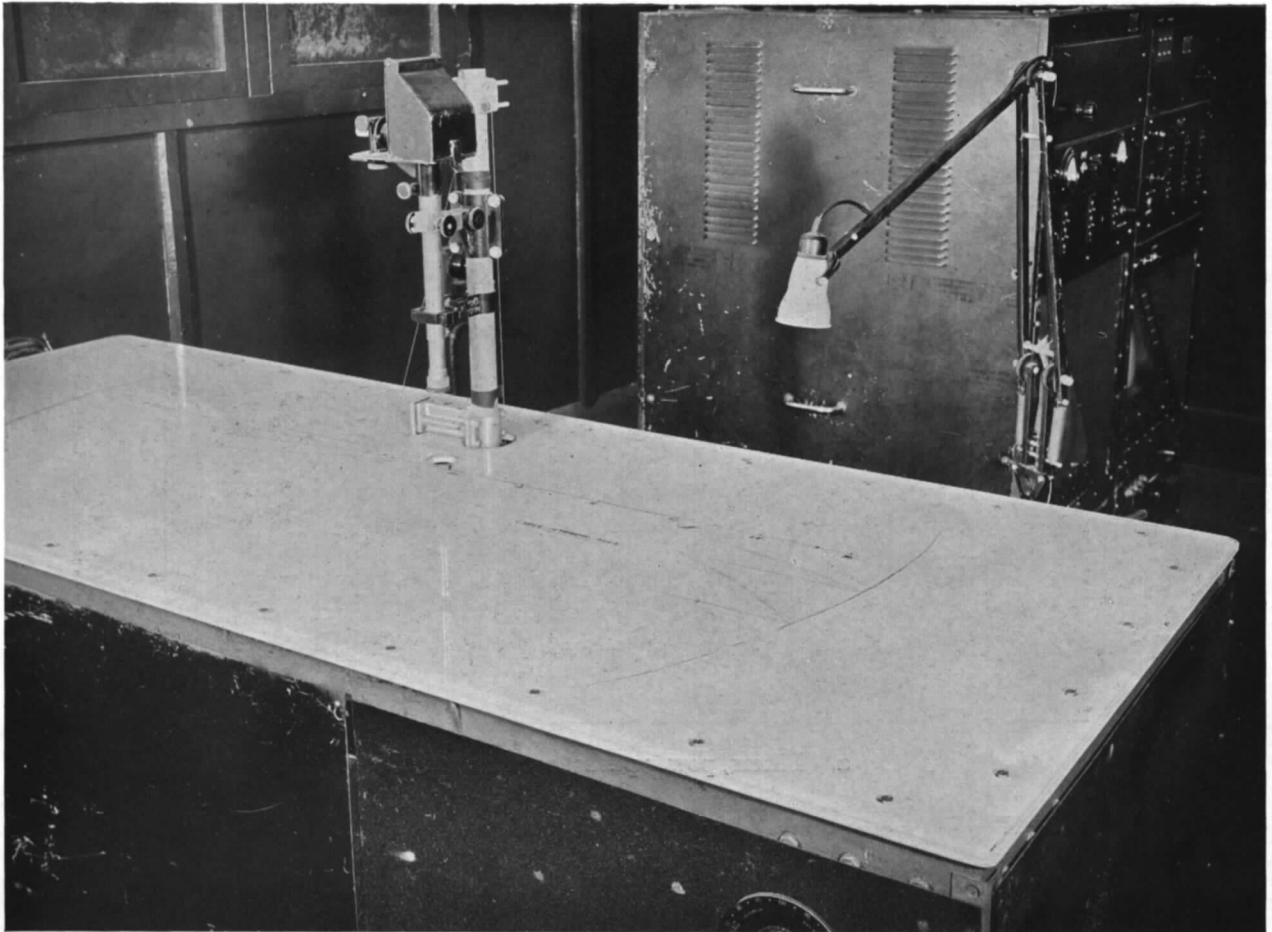

FIG. 33. Controller's plotting table. Scilly Isles ground station.

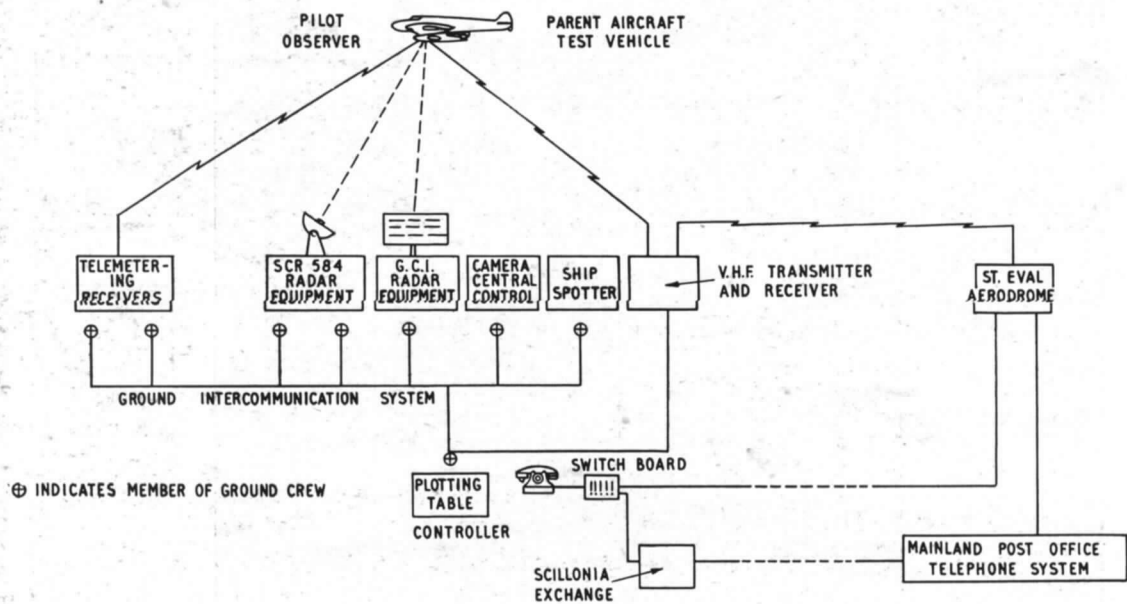

FIG. 34. Arrangement of communications at Scilly Isles ground station.



FIG. 35. *Mosquito* with test vehicle in place.

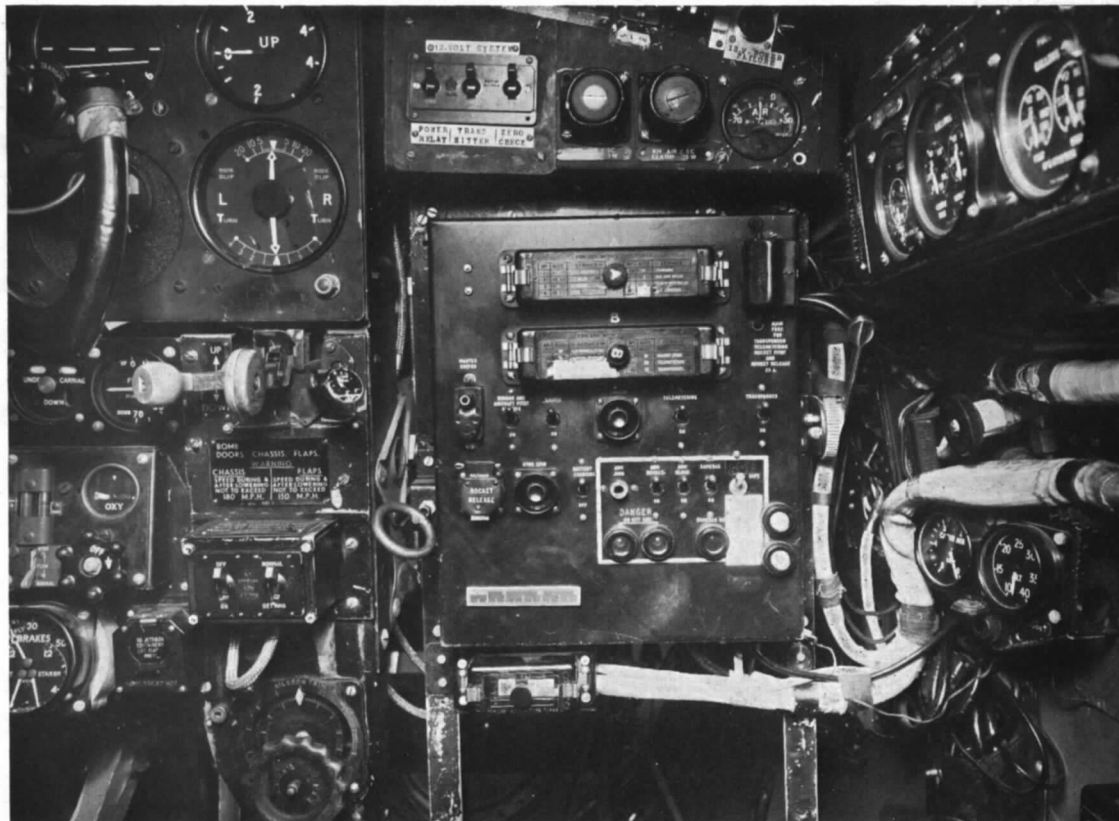

FIG. 36. Observer's panel in *Mosquito*.

Publications of the Aeronautical Research Council

ANNUAL TECHNICAL REPORTS OF THE AERONAUTICAL RESEARCH COUNCIL (BOUND VOLUMES)

- 1936 Vol. I. Aerodynamics General, Performance, Airscrews, Flutter and Spinning. 40s. (41s. 1d.)
 Vol. II. Stability and Control, Structures, Seaplanes, Engines, etc. 50s. (51s. 1d.)
- 1937 Vol. I. Aerodynamics General, Performance, Airscrews, Flutter and Spinning. 40s. (41s. 1d.)
 Vol. II. Stability and Control, Structures, Seaplanes, Engines, etc. 60s. (61s. 1d.)
- 1938 Vol. I. Aerodynamics General, Performance, Airscrews. 50s. (51s. 1d.)
 Vol. II. Stability and Control, Flutter, Structures, Seaplanes, Wind Tunnels, Materials. 30s. (31s. 1d.)
- 1939 Vol. I. Aerodynamics General, Performance, Airscrews, Engines. 50s. (51s. 1d.)
 Vol. II. Stability and Control, Flutter and Vibration, Instruments, Structures, Seaplanes, etc. 63s. (64s. 2d.)
- 1940 Aero and Hydrodynamics, Aerofoils, Airscrews, Engines, Flutter, Icing, Stability and Control, Structures, and a miscellaneous section. 50s. (51s. 1d.)
- 1941 Aero and Hydrodynamics, Aerofoils, Airscrews, Engines, Flutter, Stability and Control, Structures. 63s. (64s. 2d.)
- 1942 Vol. I. Aero and Hydrodynamics, Aerofoils, Airscrews, Engines. 75s. (76s. 3d.)
 Vol. II. Noise, Parachutes, Stability and Control, Structures, Vibration, Wind Tunnels. 47s. 6d. (48s. 7d.)
- 1943 Vol. I. Aerodynamics, Aerofoils, Airscrews. 80s. (81s. 4d.)
 Vol. II. Engines, Flutter, Materials, Parachutes, Performance, Stability and Control, Structures. 90s. (91s. 6d.)
- 1944 Vol. I. Aero and Hydrodynamics, Aerofoils, Aircraft, Airscrews, Controls. 84s. (85s. 8d.)
 Vol. II. Flutter and Vibration, Materials, Miscellaneous, Navigation, Parachutes, Performance, Plates and Panels, Stability, Structures, Test Equipment, Wind Tunnels. 84s. (85s. 8d.)

Annual Reports of the Aeronautical Research Council—

1933-34	1s. 6d. (1s. 8d.)	1937	2s. (2s. 2d.)
1934-35	1s. 6d. (1s. 8d.)	1938	1s. 6d. (1s. 8d.)
April 1, 1935 to Dec. 31, 1936	4s. (4s. 4d.)	1939-48	3s. (3s. 2d.)

Index to all Reports and Memoranda published in the Annual Technical Reports, and separately—

April, 1950 R. & M. No. 2600. 2s. 6d. (2s. 7½d.)

Author Index to all Reports and Memoranda of the Aeronautical Research Council—

1909-1949. R. & M. No. 2570. 15s. (15s. 3d.)

Indexes to the Technical Reports of the Aeronautical Research Council—

December 1, 1936 — June 30, 1939.	R. & M. No. 1850.	1s. 3d. (1s. 4½d.)
July 1, 1939 — June 30, 1945.	R. & M. No. 1950.	1s. (1s. 1½d.)
July 1, 1945 — June 30, 1946.	R. & M. No. 2050.	1s. (1s. 1½d.)
July 1, 1946 — December 31, 1946.	R. & M. No. 2150.	1s. 3d. (1s. 4½d.)
January 1, 1947 — June 30, 1947.	R. & M. No. 2250.	1s. 3d. (1s. 4½d.)
July, 1951.	R. & M. No. 2350.	1s. 9d. (1s. 10½d.)

Prices in brackets include postage.

Obtainable from

HER MAJESTY'S STATIONERY OFFICE

York House, Kingsway, London, W.C.2; 423 Oxford Street, London, W.1 (Post Orders: P.O. Box 569, London, S.E.1);
 13a Castle Street, Edinburgh 2; 39, King Street, Manchester 2; 2 Edmund Street, Birmingham 3; 1 St. Andrew's
 Crescent, Cardiff; Tower Lane, Bristol 1; 80 Chichester Street, Belfast, or through any bookseller

S.O. Code No. 23-2835