



PROCUREMENT EXECUTIVE MINISTRY OF DEFENCE

AERONAUTICAL RESEARCH COUNCIL

REPORTS AND MEMORANDA

Head and Neck Mobility of Pilots
Measured at the Eye

BY SQUADRON LEADER M. C. CHAMPION and W. G. A. PORT

Engineering Physics Department, R.A.E., Farnborough, Hants

RECEIVED
ROYAL AIR FORCE RESEARCH ESTABLISHMENT
FARNBOROUGH

LONDON: HER MAJESTY'S STATIONERY OFFICE

1977

PRICE £4.25 NET

Head and Neck Mobility of Pilots Measured at the Eye

BY SQUADRON LEADER M. C. CHAMPION and W. G. A. PORT

Engineering Physics Department, R.A.E., Farnborough, Hants.

*Reports and Memoranda No. 3803**
December, 1974

Summary

A study of the head and neck mobility of nine selected pilot subjects has been made by measuring the movement envelope of the pilot's eye position as he cranes his head and neck up, down and from side to side. During these movements the subjects looked forward at a target board through a sight aperture. The subjects were strapped into an ejection seat instrumented to monitor harness tension, and were clothed in standard RAF summer and winter aircrew equipment assemblies. The effects of wearing a standard RAF Mark 2/3 flying helmet, and differences between movement with summer and winter flying clothing have been assessed.

* Replaces R.A.E. Technical Report 74158—A.R.C. 36 353

LIST OF CONTENTS

1. Introduction
 2. Experimental Equipment
 3. Experimental Methods
 - 3.1. Preparation
 - 3.2. Harness Tension and Seat Heights
 - 3.3. Ranges of Movement in the Longitudinal Plane
 - 3.4. Lateral Ranges of Movement
 4. Results
 - 4.1. Anthropometry of Subjects
 - 4.2. Seat Height Adjustment and Eye Positions
 - 4.3. Longitudinal Ranges of Movement of Eye
 - 4.4. Lateral Range of Movement of the Left Eye
 - 4.5. Plan Plot of Range of Movement
 - 4.6. Combined Lateral and Longitudinal Range of Movement
 - 4.7. Harness Tensions
 5. Conclusions
- References
- Appendix A Head movement study—brief for subjects
- Appendix B Aircrew equipment assemblies worn by subjects
- Table 1 Anthropometric details of subjects
- Table 2 Subject sitting height and ejection seat height adjustment
- Table 3 Ejection seat harness tensions with pilot at eye datum
- Illustrations—Figs. 1 to 18
- Detachable Abstract Cards

1. Introduction

Very few measurements of the range of mobility of the human head and neck have been carried out in the past. A search of the literature revealed two related studies. In 1946 Randall, Damon *et al.* measured the locus of movement of the eye and ear-hole as subjects nodded their head up and down. This information was used in the design of wartime aircraft gun turrets¹. In 1959 Buck, Dameron *et al.* carried out a study of the normal range of motion in the neck using a bubble goniometer, measuring the degree of flexion, rotation and extension for medical purposes.²

Aircraft designers need information on the range of movement of the eye socket that pilots can achieve by craning their head and neck up and down and from side to side. The information is required for the design and positioning of fixed head-up displays, gunsights and helmet mounted sights, and may also be used in the assessments of the external vision envelopes of cockpits. The limits of vision for a typical fighter type cockpit are shown in Fig. 1. This figure also illustrates the type of downward head movement required when using the gunsight and the effect of craning the head up on forward vision over the nose of the aircraft. The experiment recorded here also provides information on the ejection seat harness tightness used by the subjects.

RAE Tech Memo EP 535³ describes a preliminary study in which the vertical movement of eye level was measured using 20 non-pilot subjects. Following this work the ejection seat rig and measurement techniques have been modified and the scope of the experiment enlarged. For the work reported here nine RAF pilots were selected with neck lengths varying from the 7th–99th percentile (referred to the survey of 2000 RAF aircrew)⁴. The extreme ranges of longitudinal and lateral movement of the subject's left eye socket were directly plotted. All subjects were then asked to move their head and neck to the limits that they would consider comfortable in an aircraft under 'combat' and 'approach to land' conditions.

2. Experimental Equipment

A Martin Baker Mark 8 (front) ejection seat (designed for TSR2) was mounted on a metal and wood frame as shown in Fig. 2. A simple sighting tube 'C' was attached to the measuring arm of an anthropometric head measurement box. Using a pencil on the pivot end of the measuring arm and locating the eye with the sighting tube a direct plot could be made of the movement of the left eye in the longitudinal plane (Fig. 3). A 3 inch sight aperture was mounted on the seat centre line, and a vertical graduated target board was placed 60 cm forward of the sight aperture (Fig. 4). The basic geometry of the rig is shown in Fig. 5.

A control column and throttle handle were provided to ensure that the subject remained in a typical flying posture. The distance of the sight below eye datum, its fore and aft position relative to eye datum and the aperture of the sight were the same as those used in the earlier work reported in Ref. 3 and are representative of the sight in a particular type of aircraft. The relationship of seat reference point to eye datum is also the same as that in this particular aircraft type and is not as required in AvP 970 (see Section 4.2). Harness tension was monitored by fitting instrumented buckles on the shoulder and leg straps. There was insufficient space to instrument the 'negative g' strap. The harness tension was sensed by strain gauges, whose output was fed through an amplifier to a previously calibrated digital voltmeter.

3. Experimental Methods

3.1. Preparation

Each subject was given a written brief (Appendix A) outlining the aims of the experiment and the recording methods. Subjects were asked to comment whenever they felt their movements were restricted by equipment or clothing. The relevant anthropometric measurements were taken using the methods of Ref. 4. Where subjects had been measured in this survey those figures were used. None of the subjects had suffered any previous back or neck injury nor had any ever ejected from aircraft. Their flying experience was noted.

Two sets of tracings were taken, one with the subject dressed in a current RAF fighter aircraft summer aircrew equipment assembly and another with him dressed in a winter aircrew equipment assembly. Details of these equipment assemblies are given in Appendix B.

3.2. Harness Tension and Seat Heights

Subjects were asked to strap themselves into the ejection seat using the tension that they would normally use for low flying. Readings of harness tension were taken with the subject relaxed, hands on the control column and throttle and his head in a 'relaxed' flying position. The seat was then adjusted so that the subject's left eye was at eye datum height and the seat datum position noted. The subject was then asked to tighten his shoulder

straps until no appreciable movement of his seventh cervical vertebrae was noticed when he craned his head and neck fully forward. Harness tension readings were again taken with the subject's eye at datum level whilst still relaxed and any change in seat height required was noted. The eye position was recorded with the subject in a 'relaxed' flying posture and in an 'alert' flying posture.

3.3. Ranges of Movement in the Longitudinal Plane

Subjects were asked to compress their neck fully and then to move their head and neck slowly down and forward with the neck still compressed until they reached their limit of downward movement. At this point they were asked to read the vertical scale figures on the target board which aligned with the horizontal wire of the sight aperture cross. They held this position while harness tension readings were made. They were then asked to extend the neck fully and bring their eye up and back with the neck extended until they reached their limit of upward movement. At this point they again read off the figure on the target board and remained for about 30 seconds while harness tension figures were recorded. From this position they were asked to bring the eye down and forward to eye datum. The movement of the left eye socket was tracked throughout this procedure and a continuous trace of eye movement produced. The trace was then repeated by the subject moving his eye in the opposite direction, i.e. head moving backward and upward to the highest position with the neck extended, forward and down to the lowest position with the neck compressed and finally backward and upward to eye datum.

A third trace was then made of the movement of the trignon point (just forward of the ear lobe). The whole experiment was then repeated with the subject wearing a Mark 2A or 3B flying helmet. Any visual cut off caused by the helmet was noted. No trignon point measurements can be made with the helmet on since it is covered by the helmet. Finally the measurements were repeated with the subjects moving their heads to the limits which they considered would be practical and 'comfortable' whilst flying an air to air attack pulling up to 6 g and wearing an anti-g suit.

3.4. Lateral Ranges of Movement

Harness tightness was adjusted to ensure no appreciable back and shoulder movement and was recorded with the subject relaxed at eye datum height. An eye patch was placed over the subject's right eye. The subjects were then asked to move their head out to the right along the eye datum level to the limit of their ability. From this point they were asked to move head and neck down and forward, across to the left with the head in a 'fully down' position, then upwards and across to the right with the head back, and finally back down to the initial 'head right' position. The positions of the sight aperture cross seen by the subject on the target board were plotted at approximately 3 cm intervals, producing a clockwise range of movement trace. This trace represents a vertical section through the irregular cone produced by the pilot's left eye view through the centre of the sight, taken 60 cm from the sight aperture cross. The axis of this solid angle was taken as a horizontal line in the plane of symmetry of the rig through the sight cross. As in the measurements of the longitudinal range, the longitudinal position of the left eye was observed through the sight tube and plotted for each position around the lateral trace.

The procedure was repeated with the helmet on but this time the head was moved so as to produce an anti-clockwise trace on the board. Any restrictions due to helmet fouling on the life preserver or seat were noted. Finally, as before, the subjects were asked to repeat the original procedure to the limits they considered comfortable; this time as though they were attempting to peer round an obstacle in their forward view when flying a landing approach.

4. Results

4.1. Anthropometry of Subjects

Six of the subjects had been measured in the survey of 2000 RAF aircrew and the remaining three were measured using the same technique as in the survey. The results are tabulated in Table 1; the subjects are classified and listed throughout the report in order of percentile neck length. Neck length is obtained by subtracting the sum of cervical height and trignon to vertex from stature. This measurement was thought to be the one most likely to affect neck mobility although in fact, total mobility depends on a combination of body measurements and physiological factors.

4.2. Seat Height Adjustment and Eye Positions

The seat height was adjusted by an electric actuator after each subject had strapped in so that his left eye was at datum level when in a 'relaxed' position. Table 2 records the seat adjustment for each subject against his

sitting height. Subjects 1 and 7 required a readjustment of seat height after the initial head movement runs as their relaxed sitting posture had altered. Fig. 6 shows the 'relaxed' and 'alert' eye positions taken up by each subject when he was asked to sit in the respective posture. The results may be summarised as follows:

Left Eye Positions Relative to Rig Eye Datum Position

| Posture | Relaxed | | | | Alert | | | | | |
|----------------------|------------|------|------------|-----|------------|-----|-----|------------|-----|------|
| | Summer AEA | | Winter AEA | | Summer AEA | | | Winter AEA | | |
| Clothing | Fwd | Aft | Fwd | Aft | Up | Fwd | Aft | Up | Fwd | Aft |
| Direction from datum | | | | | 7 | | | 10 | | |
| Total range mm | 28 | 64 | 12 | 40 | to 40 | 17 | 66 | to 40 | 2 | 54 |
| Mean position mm | — | 23.4 | — | 7.9 | 22.7 | | 40 | 27.2 | — | 27.4 |

Subjects with short sitting eye height measurements tend to have relaxed positions aft of datum, and this is aggravated if the seat back angle is higher than normal. The seat angle of the rig was 21 degrees, which although within the specification of AvP 970, is greater than average. The bulkiness of winter clothing brought the subjects' relaxed positions further forward relative to eye datum.

The present AvP 970 requirement for fighter type aircraft gives an eye datum position 3.2 cm up and 3.2 cm forward of the rig datum position referred to seat reference point. This is clearly further forward than ideal for this seat angle. The vertical difference can be compensated for by seat height adjustment. It should be noted that for this experiment the subject's seat position was adjusted to bring his left eye to eye datum whilst sitting in a 'relaxed' position. The AvP 970 requirement is based on an eye datum in an 'alert' position. This difference in approach is illustrated in Fig. 6 where the eye datums in both positions are shown and it may be seen that the mean 'alert' eye positions lie fairly close to the AvP 970 datum in vertical plane.

Whilst the datum for the 'relaxed' position may be adjusted to give consistency, a problem remains in the subject's attitude towards the degree of discomfort that he will accept when performing the task at the extreme limits of movement. This is particularly so with the neck compressed. The 'comfortable' limits of movement are entirely subjective and hence are very difficult to repeat accurately. Thus the extreme limits of movement as measured are liable to variations of about ± 10 mm due to the inaccuracies in the simple recording methods used in the experiment but for individual subjects there is no means of assessing how much variation is produced by the degree of discomfort he accepts.

4.3. Longitudinal Ranges of Movement of Eye

Fig. 7 shows the range of movement for one subject as he compressed and stretched his neck whilst craning it up and down in the longitudinal (sagittal) plane. Four traces for each subject are obtained with the changes in clothing and with the helmet on and off. These are all approximately the same shape and the differences caused by clothing changes are quite small. The summer AEA with helmet off should cause the least restriction on movement, however, in some cases the subject has a greater range of movement with the more restrictive clothing. This is thought to be due to the order in which the experiment was made. The helmet off, summer AEA test was made first and since the limit of movement is subjective it appears that more discomfort may have been acceptable to the subject in the later tests.

The median values for the four clothing conditions are shown in Fig. 9 together with the median for the subject moving to the 'comfortable' limits which he considered he would use in an air-to-air attack situation. This latter was completed only in the summer AEA with helmet on and in this case it will be noted that there is a fairly substantial reduction in the limits of movement; about 3 cm less down movement and 2 cm less up movement. There are no significant differences however the subjects are dressed and the limits of movement are about 11 cm forward, 11 cm down, 5 cm up and 7 cm back from the eye datum.

The limits of movement for each subject both up and down and backwards and forwards have been plotted against the percentile neck length (Section 4.2) in Fig. 10. There is no apparent correlation, with the limited number of subjects used. A similar plot using 'comfortable' limits rather than extremes in Fig. 11 also gives no apparent correlation.

Fig. 12 gives the median value of the movement of the tragion point for all the subjects (in summer AEA, without helmet). The tragion point is considered to be the approximate 'nodding' pivot point of the head

viewed from the side. Thus the difference between the eye movement and tragon point movement is the difference between total movement of the head/eye and movement mostly of the vertebrae. The depth of the tragon point trace is some indication of the compression and extension in the vertebrae and its length some indication of the combined bending and sliding motion of the vertebrae. The movement of the eye is shown for comparison.

Thus, in summary, these figures indicate that the side view of the longitudinal range of head and neck movement measured at the eye is a 'sausage' shape tilted about 40 degrees forward. Compression and extension of the neck results in about 6 cm movement of the eye along the neck axis when the head is slightly flexed forward. Flexure and translation of the neck vertebrae, coupled with nodding of the head, produce an average movement of the eye of about 26 cm along the major axis of this elliptic shape. This value varies with subject between about 20–33 cm. The minor axis of the ellipse varies between 4 and 10 cm. When the subject moves within the 'comfortable' limits as defined in Section 3.3 the average value of the major axis of the ellipse becomes about 17 cm.

4.4. Lateral Range of Movement of the Left Eye

The lateral traces produced on the target board by one subject are shown in Fig. 13. The clothing assemblies are the same as those used for the longitudinal measurements and the four are shown for this subject. Each trace is in effect a section through the irregular cone subtended from the sight aperture cross by the pilot's left eye movements (Section 3.4 and Fig. 4). The circular lines drawn on these figures show the angles subtended to the axis (Section 3.4) at various points around the trace. Each trace was produced from a number of points spaced at 3 cm intervals around it. Subjects were able to hold their eye at each point for up to 30 seconds.

In interpreting the results it should be remembered that movements of the head and eye to the right produce a movement to the left on the lateral traces and *vice versa*. Moving the head up results in a downward movement on the trace. The majority of the lateral traces are displaced slightly right of the rig/seat centre line. The reason is that the traces are monocular and the subject's left eye is already displaced half his interpupillary distance left of centre line when his head is erect at eye datum.

As in the case of the longitudinal movement there is little sign of consistent variation with the type of clothing. Seven of the subjects considered that with the winter AEA full down movement was prevented by the extra bulkiness of the clothing causing a foul between chin or helmet and the life preserver. The 'comfortable' limits show a similar reduction from the extreme limits as in the longitudinal measures but it must be emphasised that this limit is purely subjective and nearly all the subjects agreed that this type of estimation is very difficult and not very consistent.

The median values (Fig. 15) show that a downward vision angle of about 13 to 14 degrees is achieved which is reduced to about 12 in the 'comfortable' case. The upward vision angle is about 1 degree upward in the extreme case but this is reduced to about 2 to 3 degrees downward in the 'comfortable' situation. It may be noted that one subject failed to reach the 0 degrees line when trying to attain his extreme limit in a winter AEA. The sideways vision angles from Fig. 15 show a movement from the sight axis of approximately 13 degrees with the head to the right and 15 degrees with the head to the left.

The lateral traces, therefore, show that the section through the solid angle enclosed by lateral movement of the left eye (subtended at the sight aperture cross) is an ellipse flattened at the top. As the distance from the target board to the sight and the distance of the pilot's eye position to the sight are of the same order (60 cm), the lateral traces approximate to a front elevation, full scale view of the elliptical disc of movement described by the eye, where 1 cm represents 1 degree angular movement. Although for experimental reasons the measurements were taken with the pilots looking forward through the sight, the lateral movements that subjects were asked to make are virtually the same as the total head and neck movements they could achieve when gazing in any direction; in fact, they used neck rotation, flexion and extension to reach the positions plotted.

4.5. Plan Plot of Range of Movement

The plan plots (Figs. 16 and 17) were not obtained by direct measurement but were derived from the lateral and longitudinal traces. It will be noted that these plan plots are offset to the left of the centre line. This is caused, as in the case of the lateral traces in Section 4.5, by plotting the movement of the left eye which is, obviously, not in the fore-and-aft plane of symmetry of the seat.

Fig. 18 shows the plot for the medians of all four clothing conditions together with that for the 'comfortable' limits of movement. There is little variation with the clothing worn but a fairly marked reduction to the

'comfortable' limits. This reduction is approximately 5 cm to the right and to the left and 4 cm in the forward and in the rearward directions.

It was observed that subjects vary considerably in their range of movement relative to eye datum point, i.e. although two subjects may have a very similar total range of fore and aft movement the movements relative to eye datum either fore or aft may be very different. This is also true when the same subject wears different clothing. Thus the common area of movement for all subjects based on a common eye datum is very small although the envelopes of movement for each subject when compared without reference to the position of the eye datum will give a considerably larger area of movement common to all subjects.

4.6. Combined Lateral and Longitudinal Range of Movement

The total three-dimensional limits of movement of a man's eye as he cranes his head and neck up, down and from side to side may be described as a distorted elliptical disc with its major axis parallel to the shoulders and laterally across the seat. The thickness of the disc is greatest when the man is in a normal upright posture and reduces towards the circumference of the disc. The disc thickness (shown on the longitudinal traces) represents the degree of compression and extension of the neck vertebrae available to the man at any head position. The longitudinal range of movement of the eye is shown by a vertical section through the disc along the minor axis. This section resembles an irregular ellipse inclined at about 40 degrees downwards from the horizontal.

The lateral traces show the angles subtended by the eye at the sight aperture cross by movement of the head and neck giving eye movement along the edges of the elliptical disc. The section through this irregular cone resembles a flattened ellipse, the flattened side being obtained by forward and downward movement of the head.

Thus from all the plots the approximate values for the median displacements of the eye may be summarised as follows:

| | | |
|-----------------------|------------------------|--------------------|
| Total movement of eye | Fore and aft direction | 18 cm |
| | Right and left | 27 cm |
| | Up and down | 16 cm |
| Angle of vision | Right and left | 13° right 15° left |
| | Up and down | +1° to -13° |

4.7. Harness Tensions

The harness tensions in the leg and shoulder straps were recorded before each run with the subject in the eye datum position and at the extreme head down and up positions during the longitudinal movement tests. Variations in tension of 0.75 to 2 lb were caused by subjects breathing in and out. The figures given in Table 3 are the mean values of each 'breath in' and 'breath out' readings taken over four breathing cycles. Table 3 gives the initial strap-in tensions with the subject's eye at datum, the tensions after the straps had been readjusted and the mean values of tension with the subject at eye datum before each run.

These figures represent tensions which were sufficient to restrain the man's back and shoulders and restrict movement to the head and neck as far as possible without causing discomfort to the subjects. It was noticed that tensions at eye datum tended to reduce during the measurements and further readjustments to restrict back movements were made where necessary. The tensions chosen for the initial strap in were in most cases greater when wearing winter AEA than summer AEA.

5. Conclusions

(1) The eye is moved within a distorted elliptical disc by movement of the head and neck whilst trying to look through a sight. The limits of this disc, for the median subject, are given by total movement of the eye:

| | |
|----------------|-------|
| Right and left | 27 cm |
| Fore and aft | 18 cm |
| Up and down | 16 cm |

(2) The average 'comfortable' ranges of movement for use in aircraft under air to air combat and approach to land conditions are about $\frac{2}{3}$ to $\frac{3}{4}$ of the comparable extreme ranges of movement. However, it must be noted that individual pilots held widely differing views on the amount of reduction and that only nine pilots were involved in the trial.

Considering the small number of pilots taking part in the trial it is not felt appropriate to give, for design purposes, the maximum range of head/eye movement, neither is it considered that sufficient information is

available to give a recommended working range. It must be left to the designer to decide the amount of pilot's head/eye movement that he considers an acceptable value for operation of the aircraft whilst also considering the other factors involved in the cockpit design.

(3) The extreme limits of the head and neck movement are not significantly affected by the Mark 2 or 3B flying helmet or, except at one or two exceptional points, by change from summer AEA to winter AEA. The slight reductions of movement in these cases are caused by the helmet rim fouling the life preserver stole when the bulkier winter AEA is being worn.

(4) The mean harness tensions chosen by pilots on initial strap-in were in most cases greater with winter than summer AEA.

| | | | | |
|-----------------------|-----------------|--------|---|------------|
| Mean initial tensions | Leg straps | 5.2 lb | } | Summer AEA |
| | Shoulder straps | 5.7 lb | | |
| | Leg straps | 7.6 lb | } | Winter AEA |
| | Shoulder straps | 8.3 lb | | |

During a run the mean tensions required to restrain the subject's back and shoulder movement were increased by $1\frac{1}{2}$ to 2 lb more than the initial tensions.

(5) The nine subjects taking part in this experiment were chosen with neck lengths covering the range as found in the 2000 aircrew survey as this was thought to be the most likely anthropometric measurement that could be correlated with head and neck movement. However, with this small number of subjects no correlation between neck length and head movement was found.

REFERENCES

- | <i>No.</i> | <i>Author(s)</i> | <i>Title, etc.</i> |
|------------|---|---|
| 1 | F. E. Randall, A. Damon, R. S. Benton and D. I. Patt | <i>Human body size in Military aircraft and personal equipment. Ch. VII—Movement of head and eye in sighting.</i> |
| 2 | Catherine A. Buck, Frances B. Dameron, Margot J. Dow and Helen W. Skolund | Study of normal range of motion in the neck utilizing a bubble goniometer. <i>Archives of Physical Medicine and Rehabilitation</i> , Vol. 40, pp. 390-392 (1959) |
| 3 | Flt. Lt. M. C. Champion | Measurement of vertical movement of eye level by restrained sitting subjects. RAE Technical Memorandum EP 535 (1973) |
| 4 | C. E. Bolton, M. Kenward, R. E. Simpson and G. M. Turner | An anthropometric survey of 2000 Royal Air Force Aircrew 1970/71. A.R.C. R. & M. No. 3772 (1975) |

APPENDIX A

Head Movement Study—Brief for Subjects

A.1. Introduction

Very few studies of head and neck movement have been carried out in the past, although other limb movements have been extensively recorded. Aircraft designers need to know the ranges of extreme and comfortable head movement that can be achieved by pilots to look around obstacles and through fixed head-up displays.

A.2. Aims

The aims of this experiment are:

- (a) to trace the total envelope of movement of your left eye as you crane your head and neck forward and down, up and back, while focussing on a target through a simulated gunsight aperture;
- (b) to determine the highest and lowest elevation angles visible through the gunsight aperture at the extreme head up and down positions;
- (c) to determine the amount of lateral movement of your left eye that you can achieve to look around an obstacle in your forward vision;
- (d) to determine whether present aircrew equipment assemblies restrict this movement in any way;
- (e) to determine the typical values of harness tension that you would use in an aircraft flying 'low level'.

A.3. Method

There are two parts of this experiment. First, objective measurement of the maximum ranges of movement you can physically achieve in all directions, second, subjective assessment by you of the degree of head movement that you would consider practical while flying and tracking an air-to-air target through the gunsight aperture, bearing in mind the likely g forces (-2 to $+6$ G), and that you would be wearing a fully serviceable anti-g suit. During the first measurements please move your head as far as you physically can without losing focus on the target board. If you feel restricted in movement because of your helmet or clothing please tell me.

A.4. Strap tension

There are strain gauges fitted to extra buckles on your leg and shoulder straps. Please strap in to a comfortable tight tension as you would for low flying. For the movement recordings your straps will be tightened if necessary so as to restrain your back and shoulders.

APPENDIX B

Aircrew Equipment Assemblies Worn by Subjects

B.1. The following is a list of clothing worn by subjects simulating summer RAF flying clothing:

- Flying helmet Mark 2A or 3B
- Drawers cellular (long)
- Vests cellular (long)
- Air ventilated suit
- Trousers anti-g Mark 6C
- Lightweight flying suit Mark 7A
- Life preserver Mark 17

B.2. The following is a list of clothing worn by subjects simulating winter RAF flying clothing:

- Flying helmet Mark 2A or 3B
- Drawers cellular (long)
- Vests cellular (long)
- Air ventilated suit
- Trousers anti-g Mark 6C
- Drawers acrilan pile (long)
- Vests acrilan pile (long)
- Immersion suit Mark 10
- Life preserver Mark 17

TABLE 1

Anthropometric Details of Subjects

| | 2000 survey No. | Stature | Cervical height | Tragion to vertex | Tragion to back of head | External canthus to vertex | External canthus to back of head | Cervical point to back of head (1) | Sitting height | Neck circumference | Inter pupillary distance | Neck length | Neck length percentile (2) | Age | Past experience |
|-------------|-----------------|---------|-----------------|-------------------|-------------------------|----------------------------|----------------------------------|------------------------------------|----------------|--------------------|--------------------------|---------------|----------------------------|-------|----------------------|
| Subject | a | b | c | d | e | f | g | h | i | j | k | l= b-(c+d) | m | n | o |
| | | mm | mm | mm | mm | mm | mm | mm | mm | mm | mm | mm | % | Years | |
| 1 | — | 1812 | 1540 | 156 | — | — | — | — | 926 | — | — | 106 | 7 | 43 | Transport |
| 2 | 1771 | 1720 | 1486 | 125 | 88 | 115 | 163 | 46 | 910 | 369 | 60 | 109 | 10 | 23 | Transport |
| 3 | — | 1718 | 1468 | 130 | 109 | 107 | 182 | 32 | 898 | 368 | 58 | 120 | 32 | 32 | Fighter |
| 4 | 1351 | 1795 | 1545 | 124 | 107 | 110 | 181 | 54 | 913 | 345 | 63 | 125 | 49 | 41 | Fighter |
| 5 | 186 | 1825 | 1569 | 130 | 109 | 104 | 170 | 60 | 965 | 396 | 60 | 126 | 50 | 39 | Transport/ Bomber |
| 6 | 1491 | 1794 | 1519 | 145 | 106 | 126 | 193 | 32 | 940 | 355 | 66 | 130 | 62 | 29 | Light Bomber |
| 7 | 2008 | 1734 | 1465 | 126 | 122 | 110 | 184 | 70 | 913 | 370 | 58 | 143 | 89 | 35 | Fighter |
| 8 | — | 1874 | 1596 | 135 | 95 | 122 | 177 | 44 | 929 | 344 | 61 | 143 | 89 | 36 | Light Bomber |
| 9 | 1979 | 1758 | 1495 | 134 | 94 | 115 | 161 | 47 | 881 | 382 | 59 | 171 | 99.5 | 43 | Fighter Trainer |
| Mean Values | — | 1781 | 1520 | 133 | 91 | 114 | 176 | 48 | 919 | 366 | 61 | 130 | — | 36 | |

Notes: 1 The distance from the 7th cervical vertebrae to the wall was taken with the subject standing, head erect against the wall. This measurement is accurate to ± 5 mm.

2 Percentile measurements were obtained from the RAE/IAM 1970-71 survey of 2000 RAF aircrew. Subjects who were measured in the '2000' survey have their serial numbers shown in column 'a' above.

TABLE 2

Subject Sitting Height and Ejection Seat Height Adjustment

| Subject | Sitting height of subject mm | Seat datum adjustment above (+ve) or below (-ve) neutral seat datum point mm | | | Clothing | Remarks |
|---------|------------------------------|--|-------------------|-----|----------|-----------------------|
| | | Initial | Straps readjusted | | | |
| 1 | 926 | +9 | +20 | +32 | Summer | (+32)—2nd run onwards |
| | | +6 | +6 | | Winter | |
| 2 | 910 | +28 | +32 | | Summer | |
| | | +41 | +41 | | Winter | |
| 3 | 898 | +51 | +68 | | Summer | |
| | | +73 | +3 | | Winter | |
| 4 | 913 | +72 | +54 | | Summer | |
| | | +50 | +50 | | Winter | |
| 5 | 965 | -19 | -44 | | Summer | |
| | | -57 | -57 | | Winter | |
| 6 | 940 | +33 | +33 | | Summer | |
| | | +11 | +11 | | Winter | |
| 7 | 913 | +12 | -1 | +6 | Summer | (+6)—6th run onwards |
| | | +11 | +5 | | Winter | |
| 8 | 929 | -17 | +4 | | Summer | |
| | | +8 | +18 | | Winter | |
| 9 | 881 | +53 | +53 | | Summer | |
| | | +58 | +58 | | Winter | |

TABLE 3

Ejection Seat Harness Tensions with Pilot at Eye datum

| Subject | Tensions on initial strap-in (lb) | | | | Tensions with straps readjusted (lb) | | | | Mean tensions at start of each run (lb) | | | | Clothing |
|---------|-----------------------------------|-----------|---------------|----------------|--------------------------------------|-----------|---------------|----------------|---|-----------|---------------|----------------|----------|
| | Left leg | Right leg | Left shoulder | Right shoulder | Left leg | Right leg | Left shoulder | Right shoulder | Left leg | Right leg | Left shoulder | Right shoulder | |
| 1 | 6.3 | — | 5.3 | 4.2 | 6.2 | 4.7 | 3.6 | 5.9 | 5.1 | 5.8 | 5.0 | 6.1 | } Summer |
| 2 | 1.8 | 3.3 | 2.8 | 6.3 | 3.5 | 5.5 | 5.4 | 11.8 | 2.6 | 3.5 | 4.4 | 9.9 | |
| 3 | 8.0 | 6.0 | 14.0 | 9.0 | 4.5 | 7.0 | 16.0 | 10.5 | 8.3 | 5.7 | 14.3 | 10.0 | |
| 4 | 1.8 | 2.9 | 4.9 | 18.9 | 3.0 | 1.2 | 5.9 | 16.4 | 4.0 | 2.9 | 4.0 | 13.2 | |
| 5 | 10.1 | 10.2 | 4.1 | 3.7 | 11.3 | 7.5 | 6.1 | 4.5 | 8.8 | 7.2 | 6.9 | 6.4 | |
| 6 | 0.9 | 4.4 | 3.5 | 3.7 | 10.0 | 7.8 | 2.3 | 2.3 | 7.5 | 5.6 | 2.4 | 5.4 | |
| 7 | 3.7 | 6.1 | 1.6 | 2.1 | 7.4 | 12.6 | 2.3 | 1.8 | 4.4 | 8.8 | 3.6 | 2.9 | |
| 8 | 8.0 | 7.0 | 12.5 | 13.0 | 8.5 | 10.5 | 16.5 | 23.0 | 7.9 | 8.6 | 15.1 | 19.8 | |
| 9 | 4.8 | 4.2 | 2.8 | 12.5 | 12.2 | 21.3 | 5.2 | 22.8 | 9.5 | 16.8 | 6.6 | 25.9 | |
| Mean | 5.0 | 5.5 | 5.7 | 8.1 | 7.4 | 8.7 | 7.1 | 10.9 | 6.5 | 7.2 | 6.9 | 11.1 | |
| 1 | 6.4 | 6.3 | 6.1 | 6.3 | 10.3 | 7.3 | 5.7 | 6.4 | 8.2 | 7.1 | 4.8 | 5.7 | } Winter |
| 2 | 5.5 | 2.8 | 6.6 | 13.5 | 6.5 | 3.4 | 4.4 | 9.9 | 4.8 | 2.5 | 5.4 | 10.4 | |
| 3 | 7.2 | 3.5 | 14.2 | 11.7 | — | — | — | — | 8.5 | 6.2 | 13.4 | 9.6 | |
| 4 | 4.6 | 6.5 | 2.4 | 11.5 | 6.3 | 12.7 | 2.3 | 10.4 | 3.9 | 9.6 | 2.9 | 9.8 | |
| 5 | 9.7 | 14.3 | 8.2 | 13.4 | 13.9 | 18.9 | 12.4 | 9.3 | 10.7 | 14.6 | 6.7 | 8.7 | |
| 6 | 10.2 | 12.8 | 4.1 | 6.1 | — | — | — | — | 10.1 | 11.1 | 3.1 | 4.9 | |
| 7 | 8.9 | 9.1 | 4.2 | 1.1 | 11.1 | 11.3 | 8.0 | 4.1 | 8.0 | 8.7 | 5.5 | 2.3 | |
| 8 | 4.0 | 3.5 | 11.0 | 9.5 | 4.0 | 3.5 | 10.5 | 24.5 | 6.5 | 5.5 | 12.5 | 17.1 | |
| 9 | 13.4 | 16.0 | 5.0 | 14.6 | 15.3 | 22.5 | 9.1 | 21.2 | 12.8 | 20.7 | 7.4 | 23.1 | |
| Mean | 7.7 | 8.3 | 6.8 | 9.7 | 9.6 | 11.4 | 7.5 | 13.8 | 8.2 | 9.5 | 6.9 | 10.2 | |

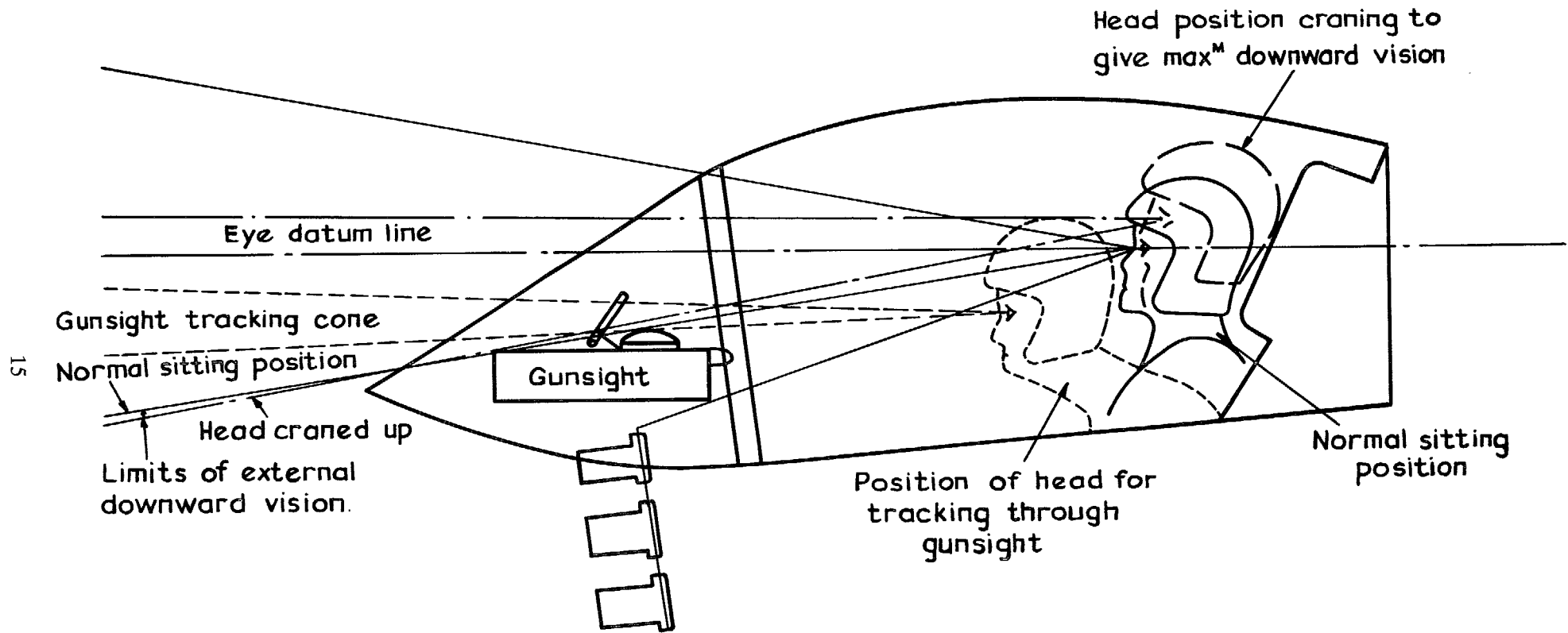
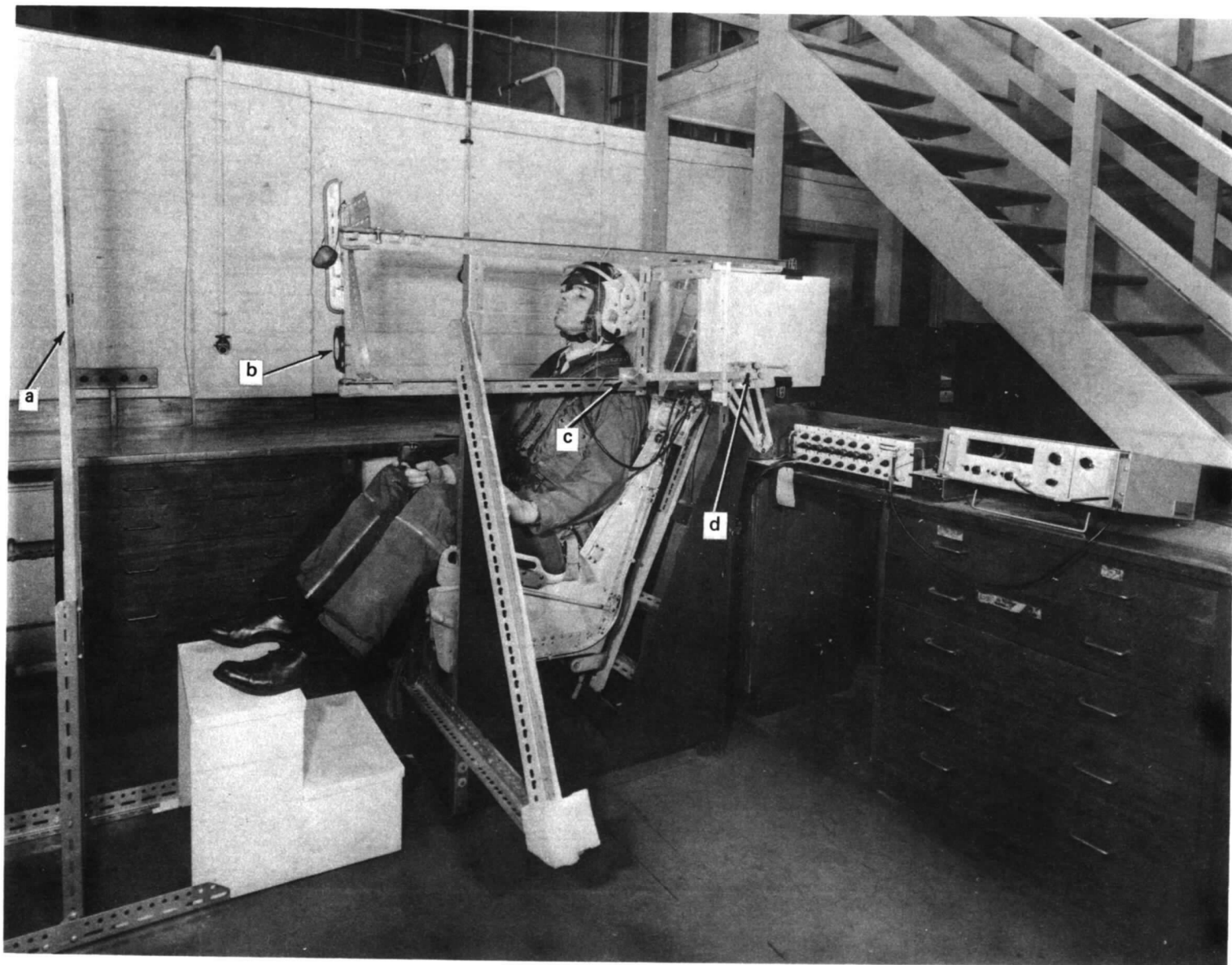
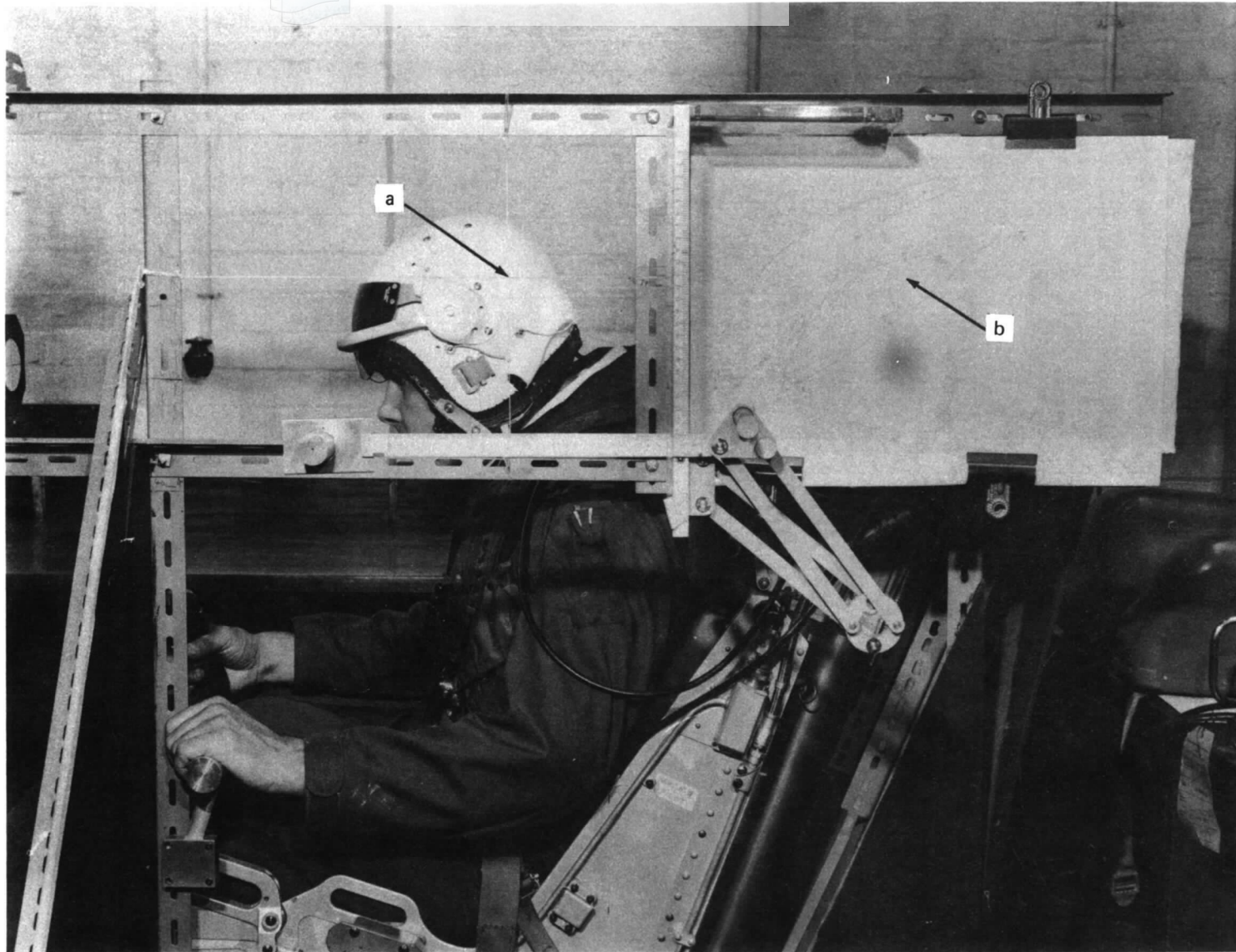

FIG. 1. Typical fighter cockpit vision limits.



- Key
- a = Graduated target board
 - b = Crosswire sight aperture
 - c = Sighting tube
 - d = Head measurement box

FIG. 2. General view of ejection seat rig.



17

Key

- a = Crosswires at eye datum position
- b = Longitudinal movement traces

FIG. 3. View of subject craning forward and head measurement box.

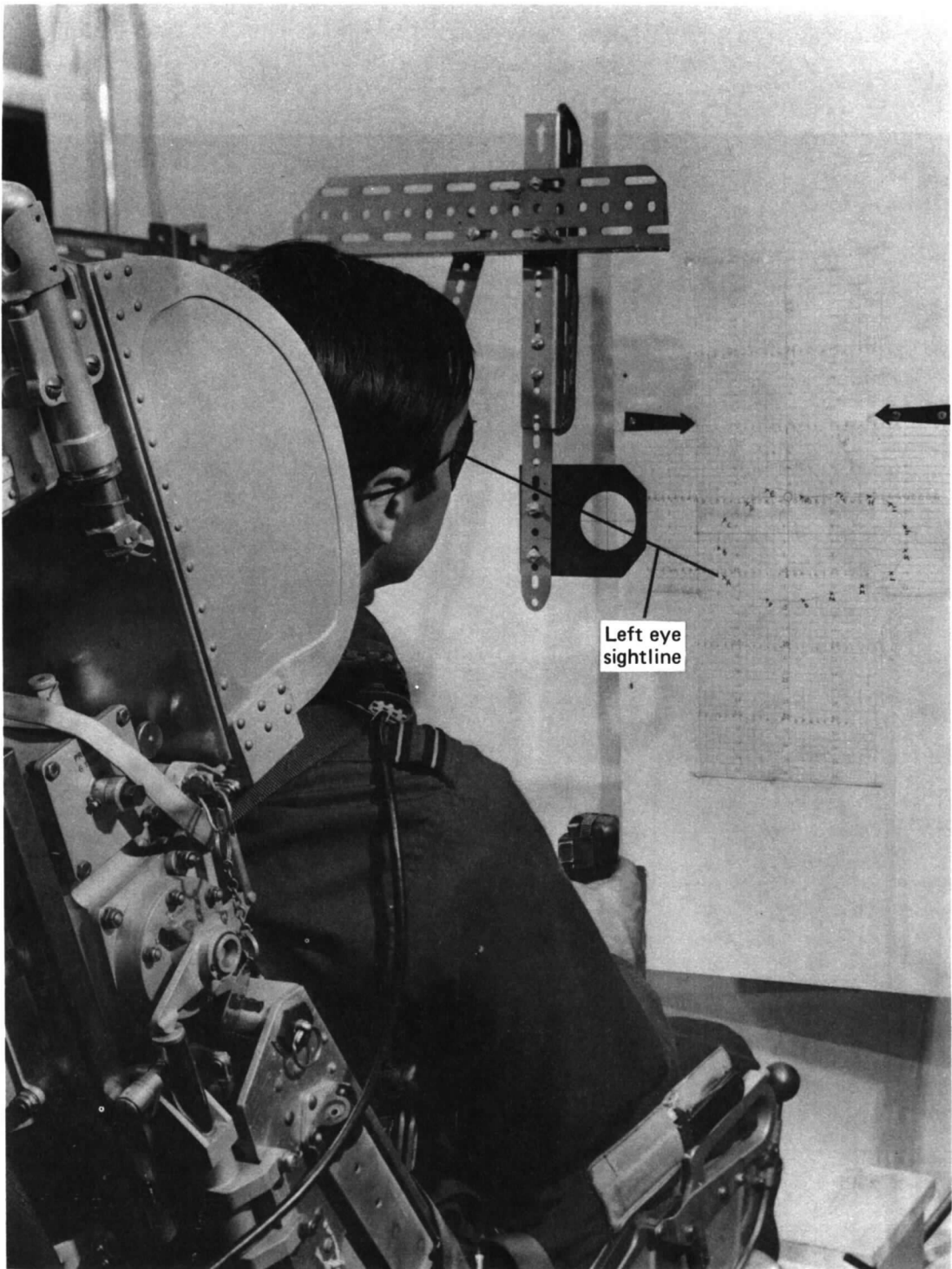

FIG. 4. View of subject producing lateral eye movement-plot on target board.

19

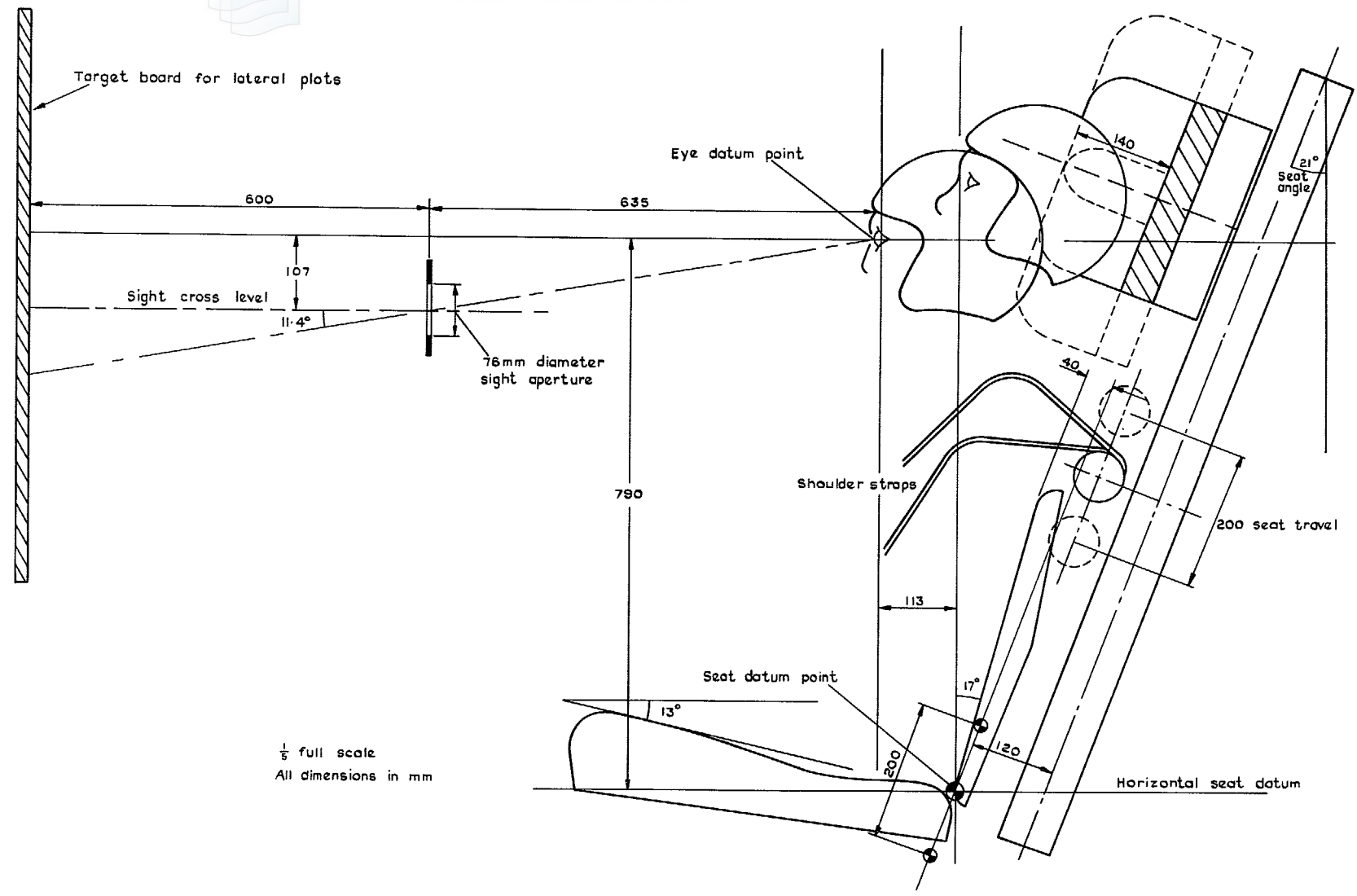

FIG. 5. Rig geometry.

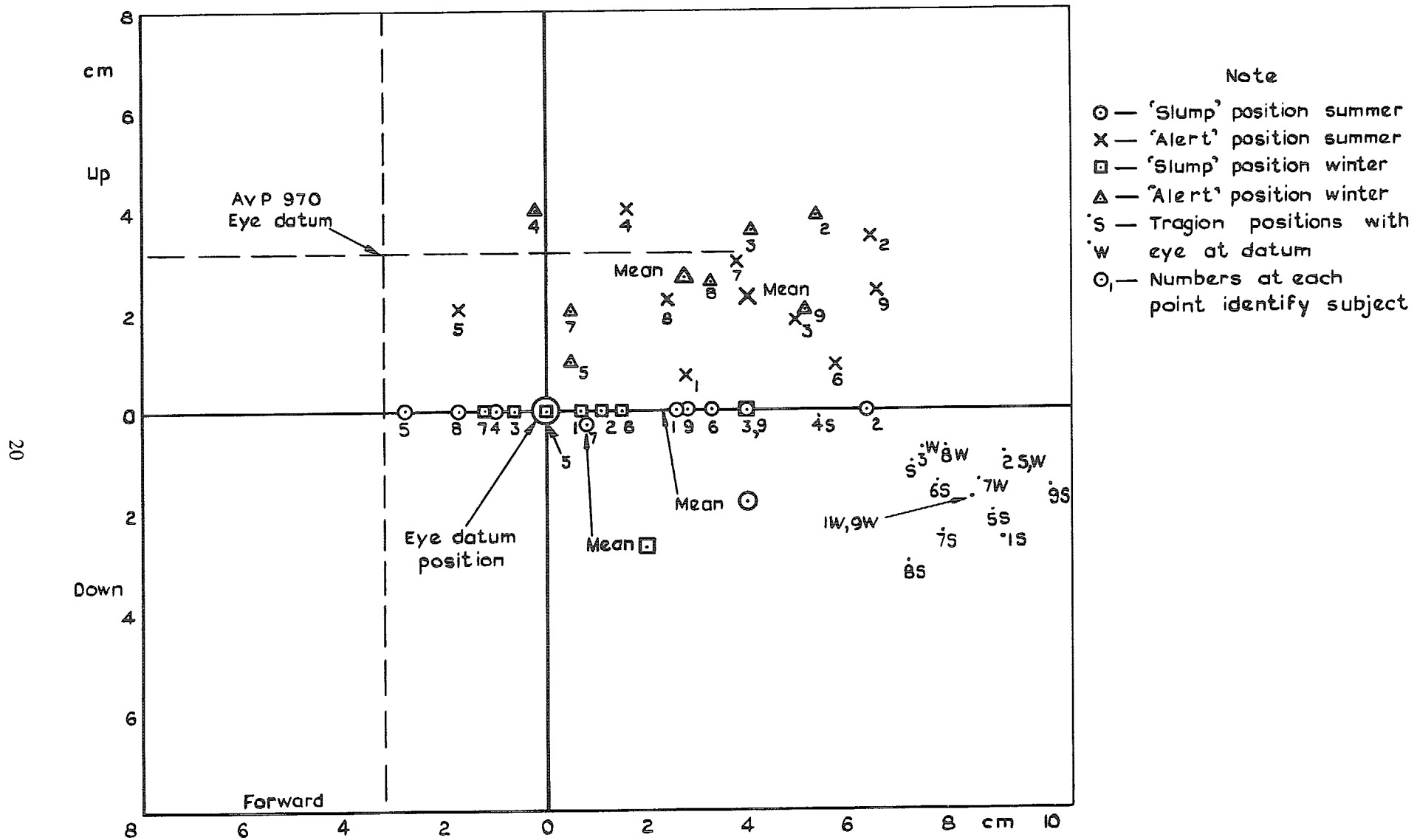

FIG. 6. 'Alert' and 'slumped' eye positions and trignon points positions at 'eye datum'.

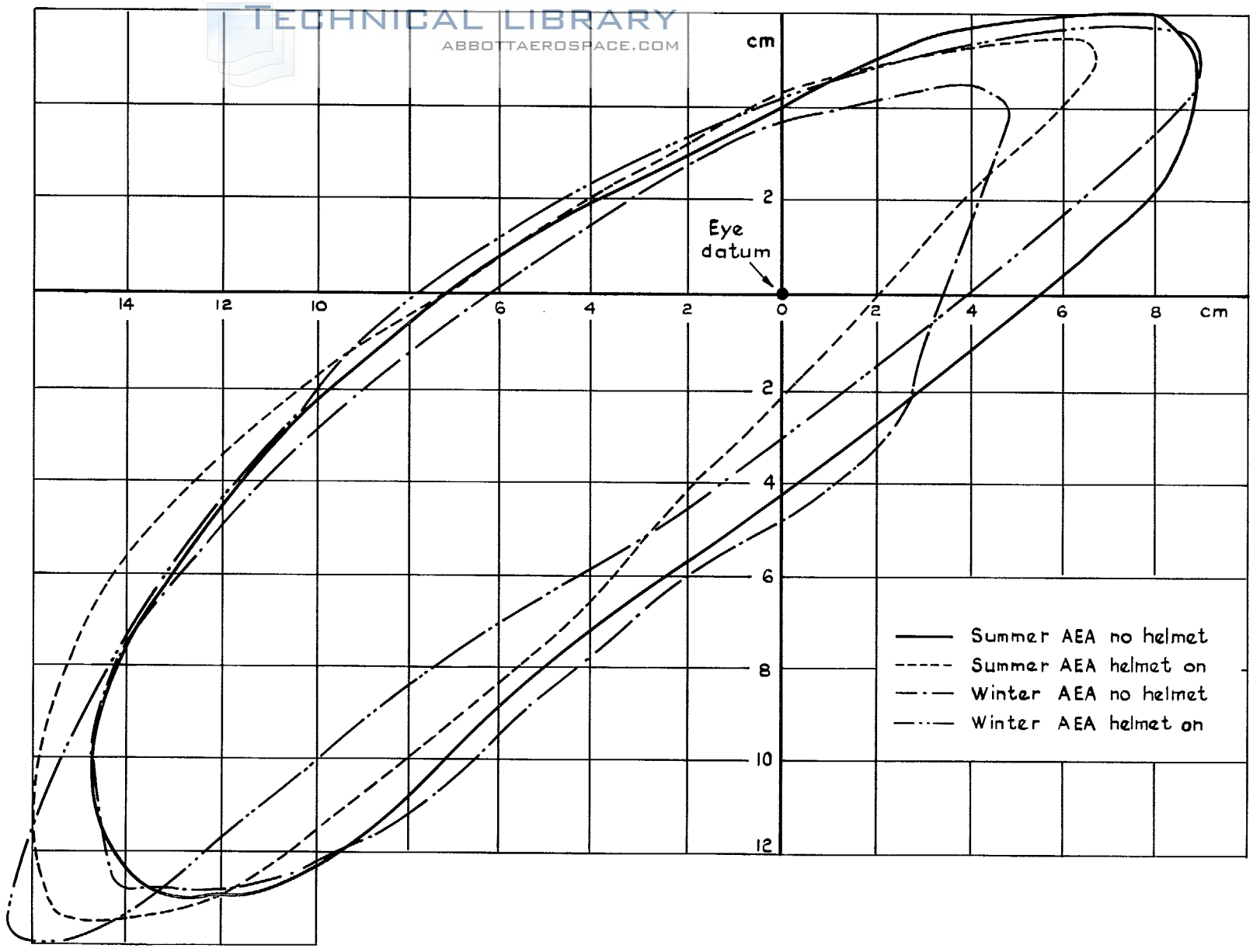

FIG. 7. Effect of clothing on longitudinal movement of eye for one subject.

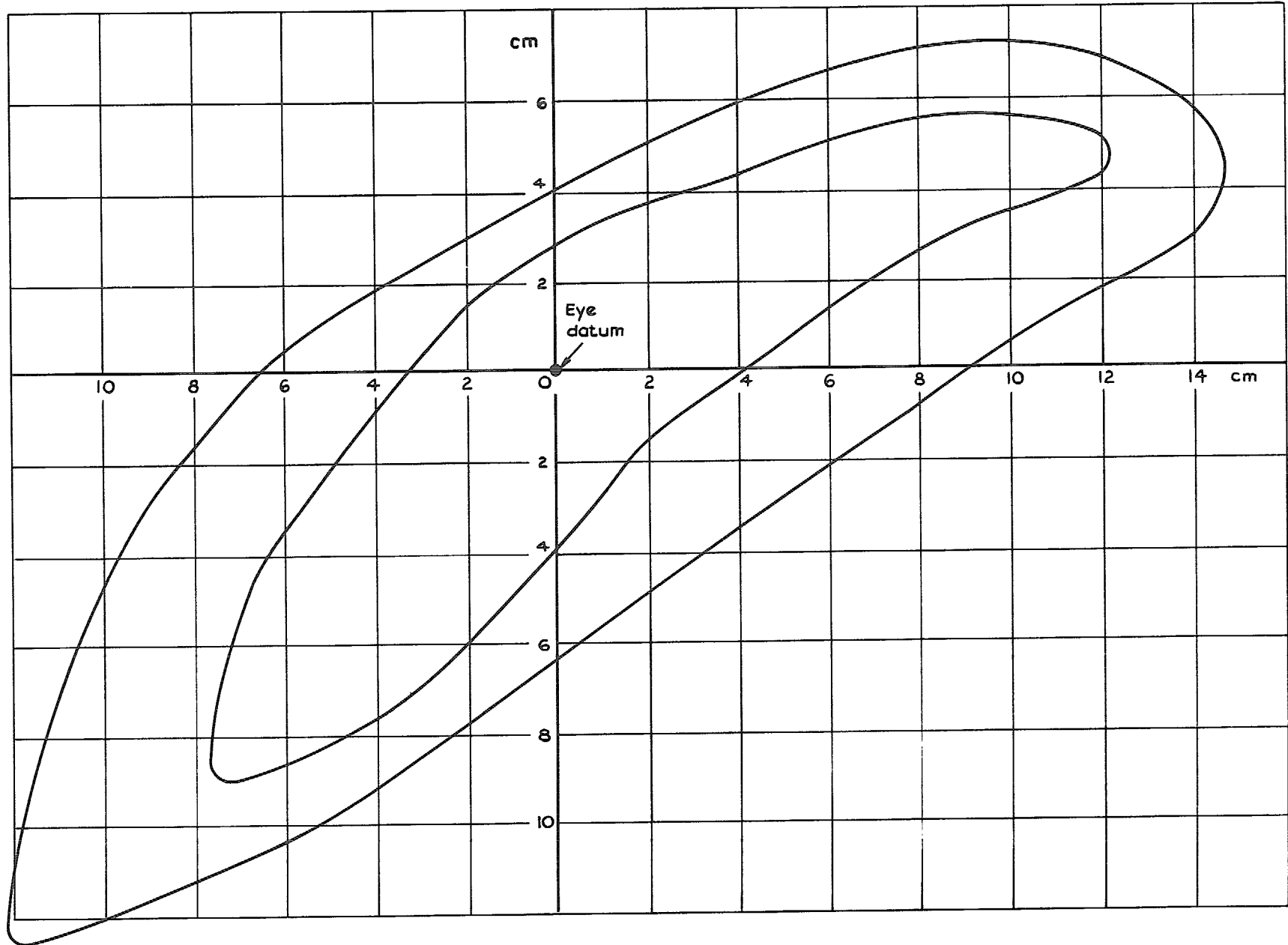

FIG. 8. Typical traces showing a large and small longitudinal eye movement.

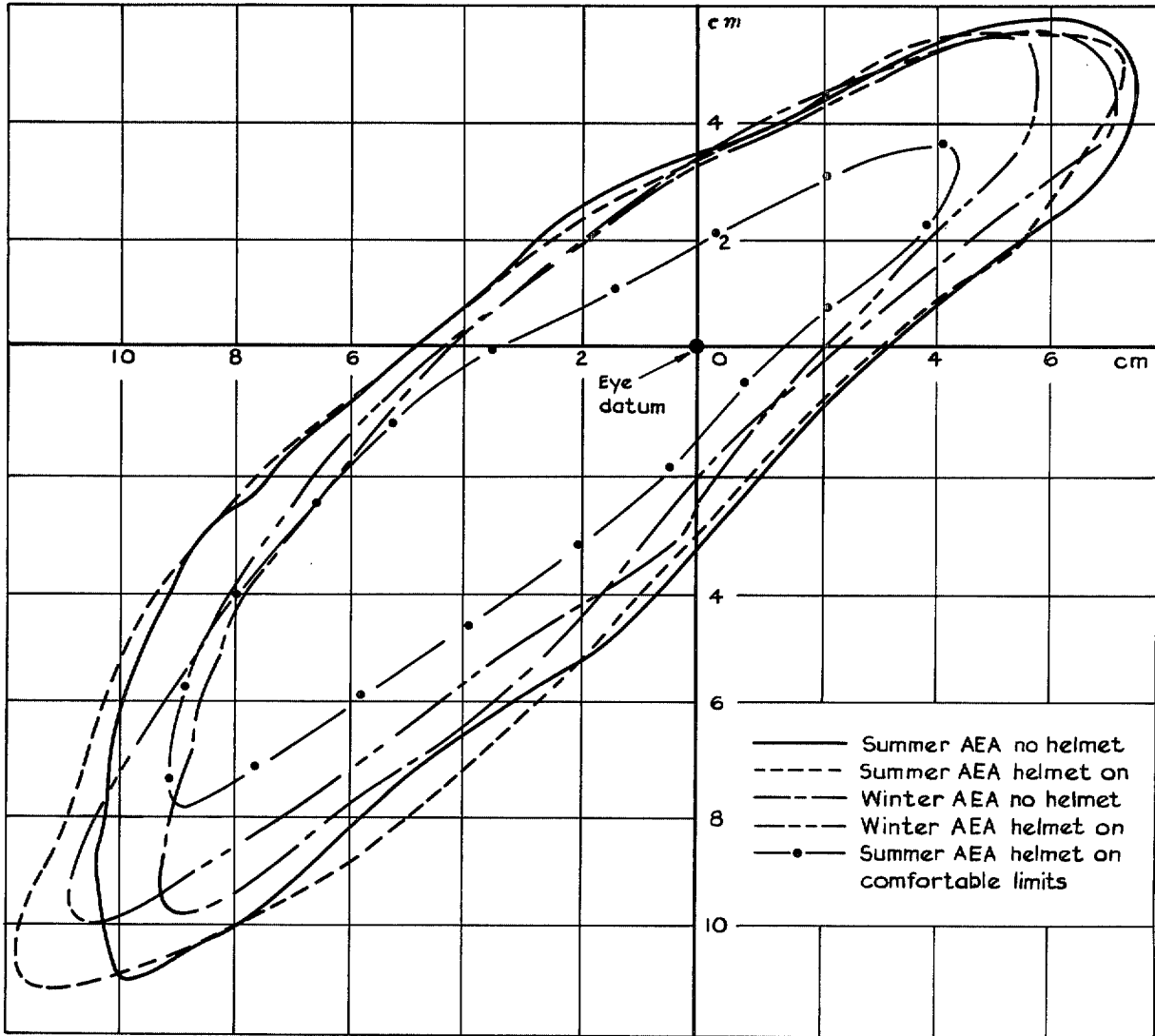

FIG. 9. Median values of longitudinal movement of eye for 9 subjects.

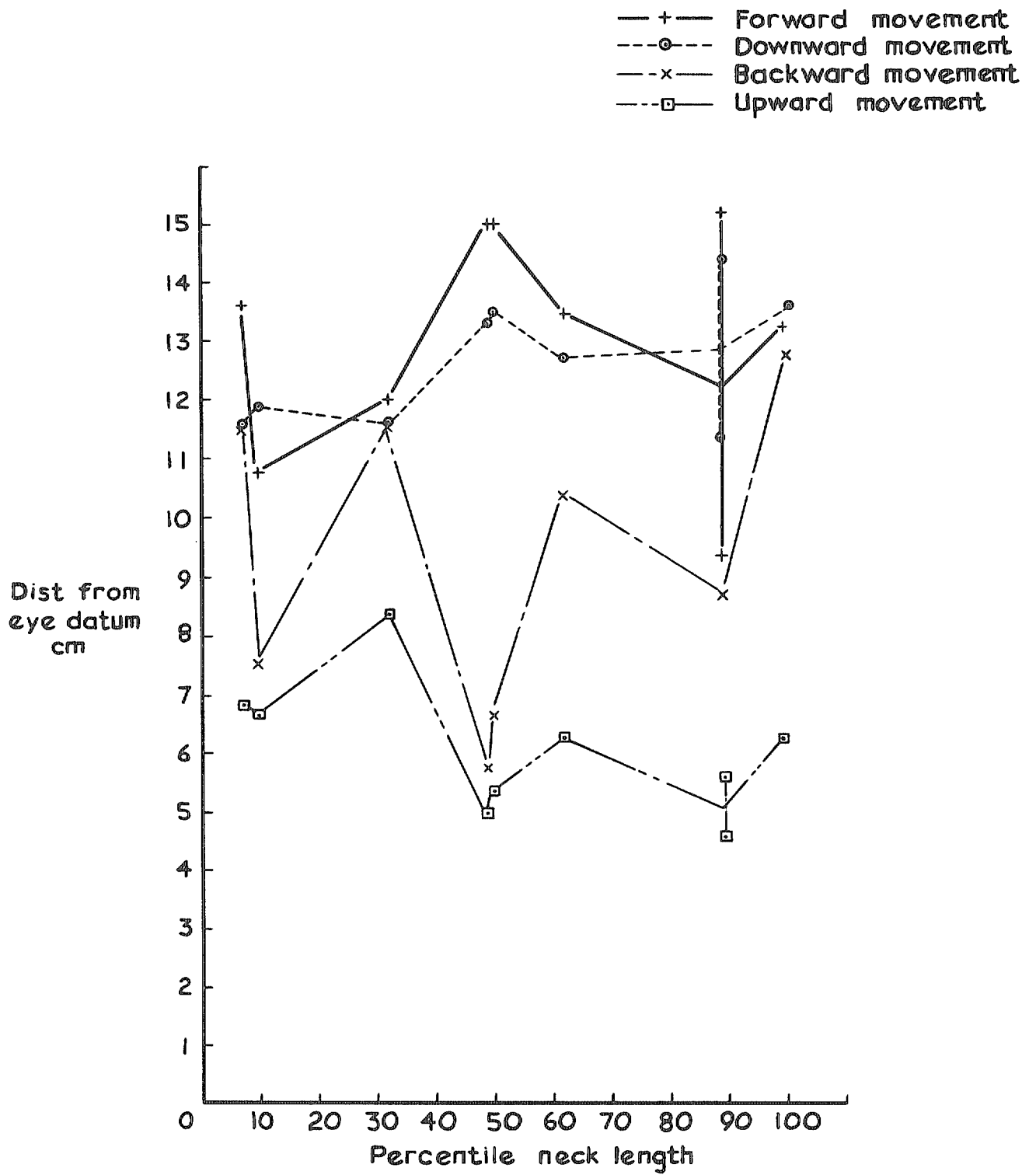

FIG. 10. Extreme limits summer AEA helmet on longitudinal eye movement.

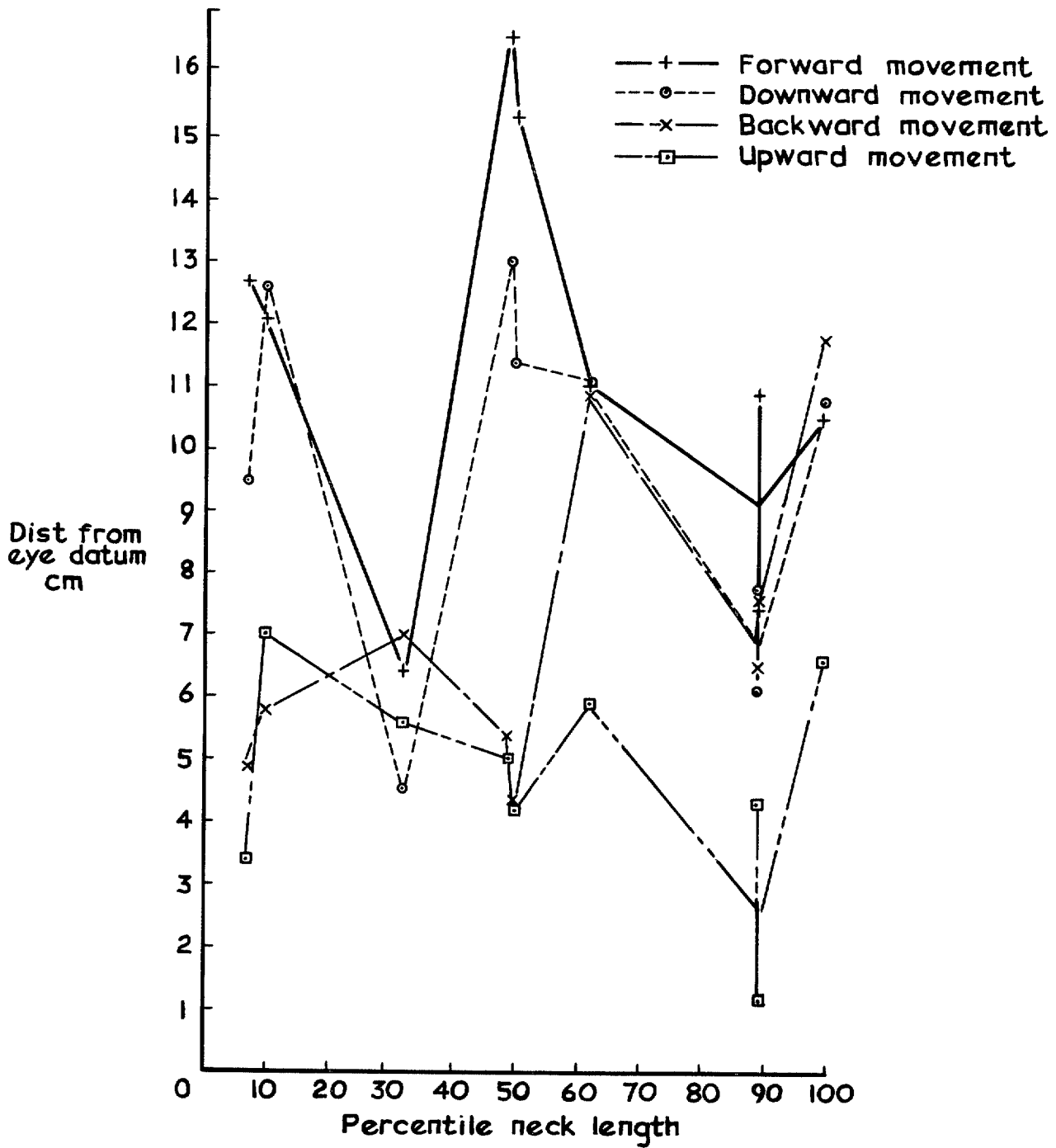

FIG. 11. Comfortable limits summer AEA helmet on longitudinal eye movement.

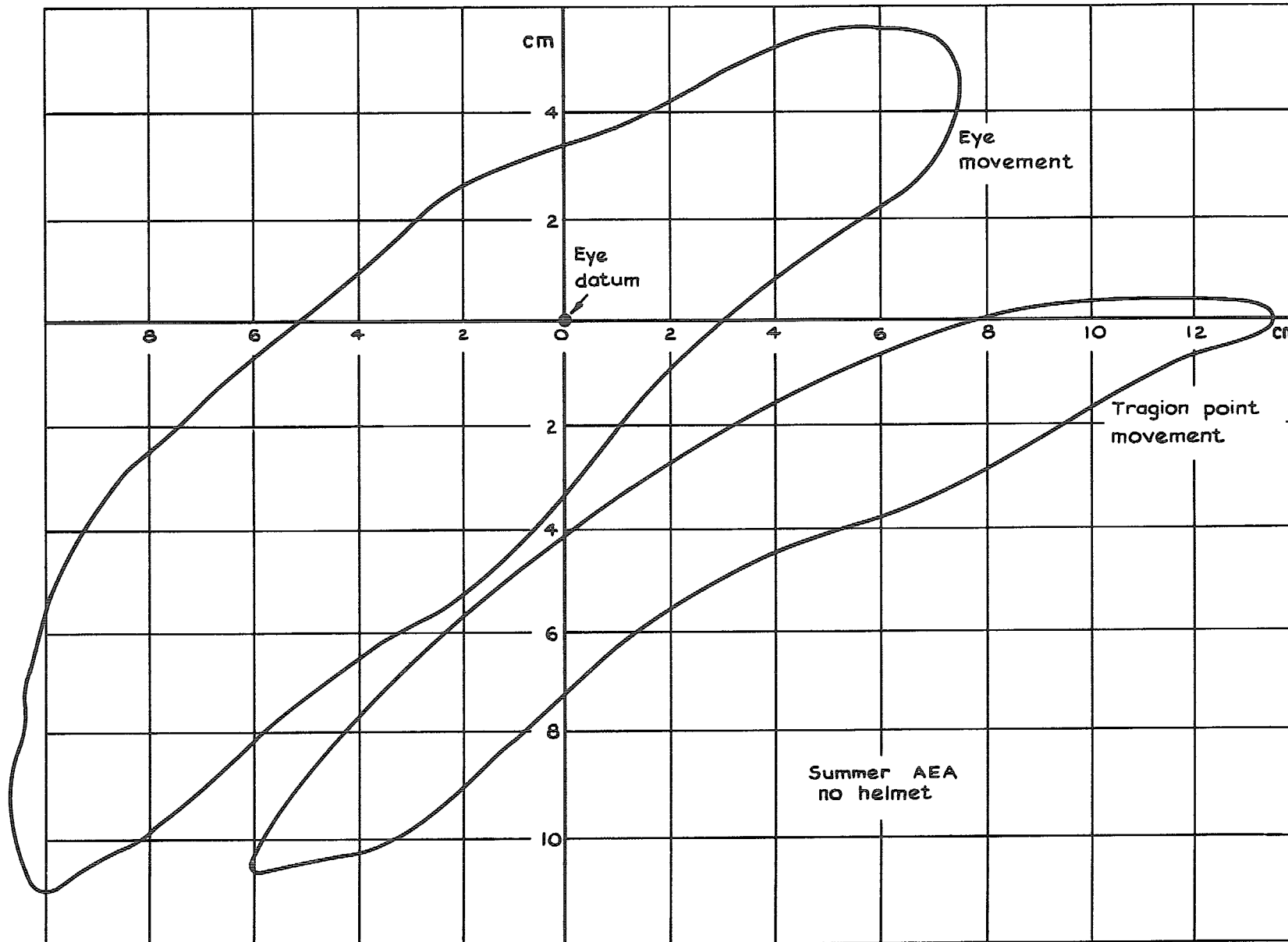
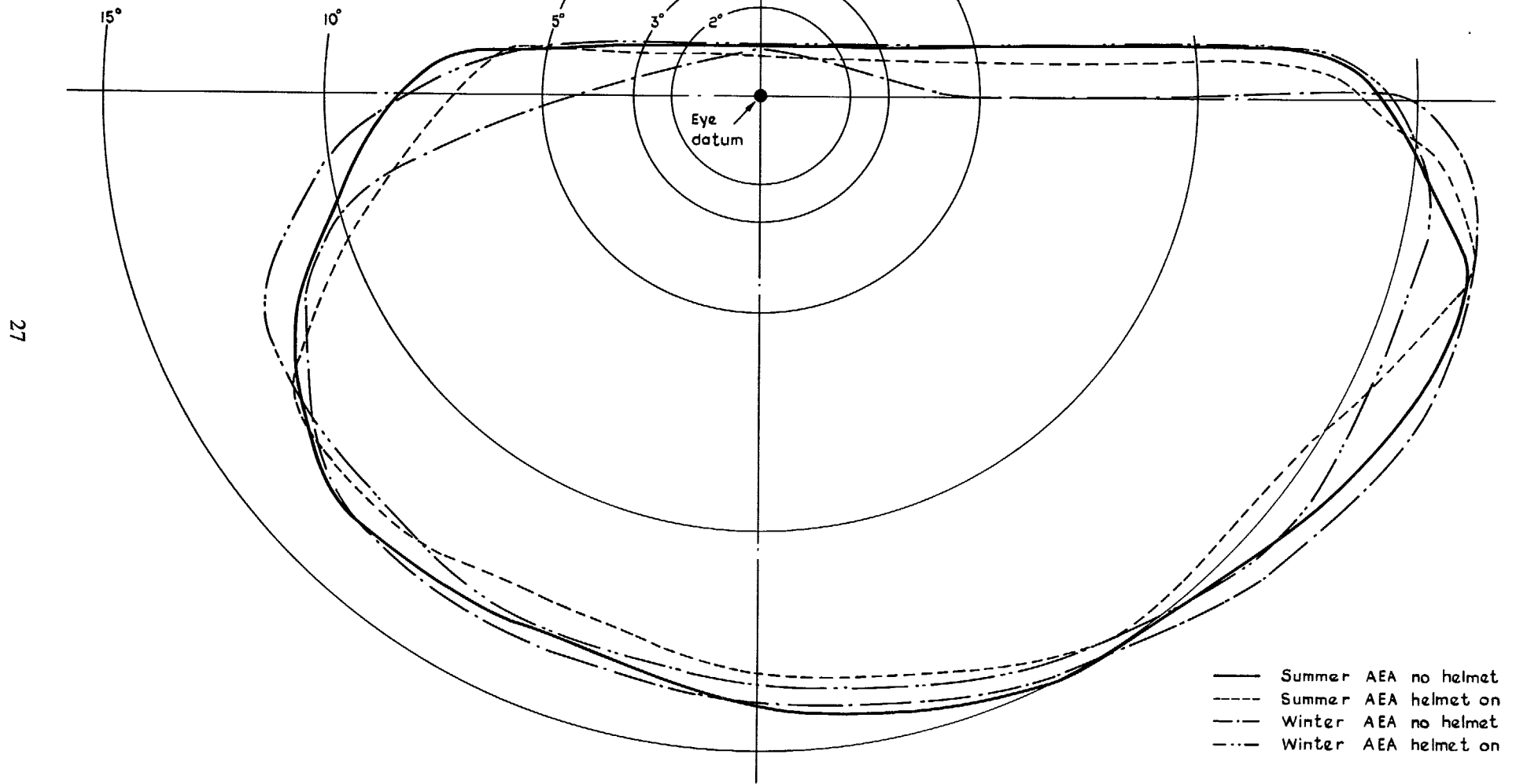

FIG. 12. Median values of eye and tracion point movement.



27

FIG. 13. Effect of clothing on lateral movement of eye for one subject.

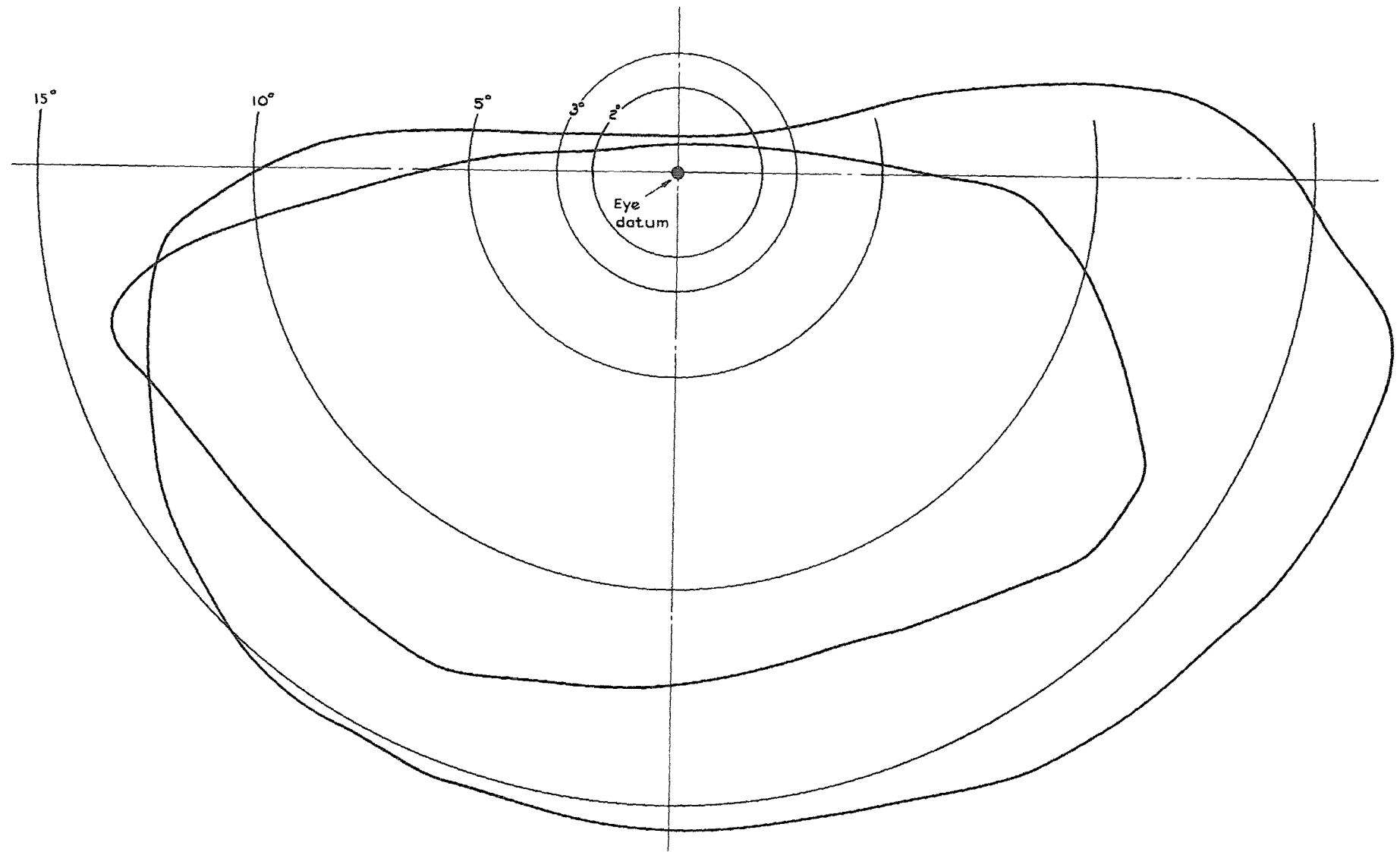

FIG. 14. Typical traces for two subjects showing a large and small lateral movement of left eye.

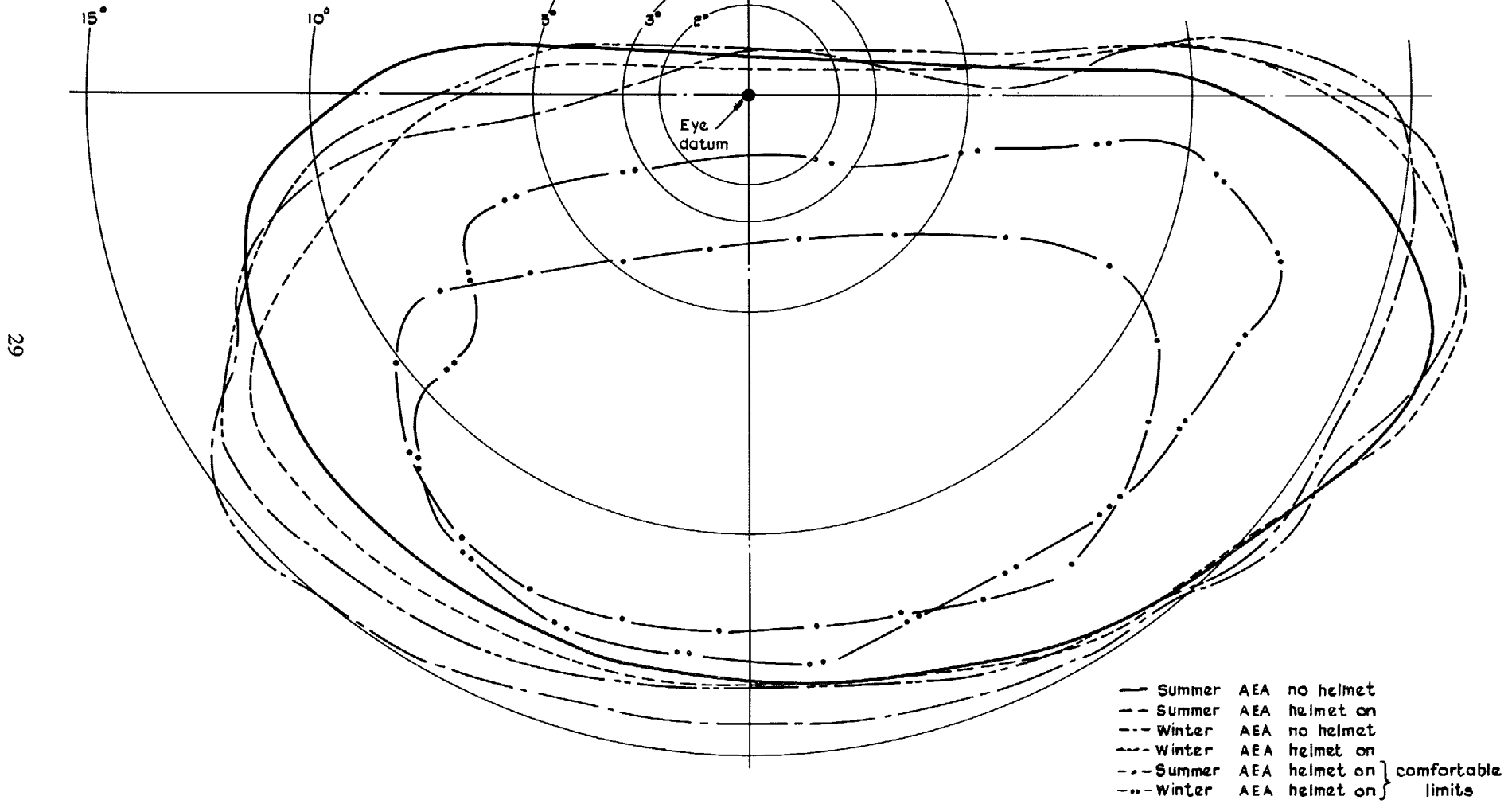

FIG. 15. Median values of lateral movement of left eye for 9 subjects.

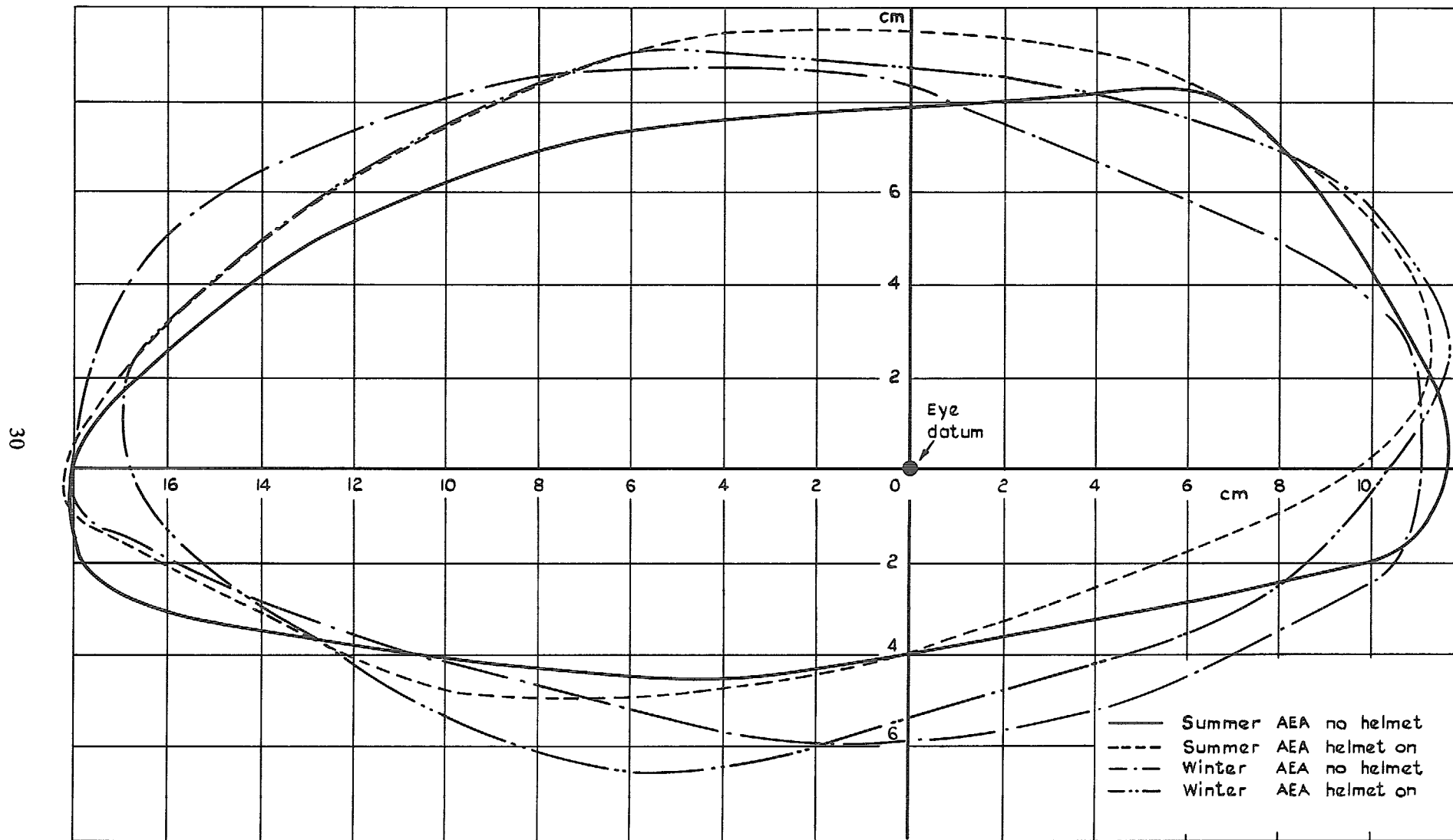

FIG. 16. Plan plot of movement of eye. Effects of clothing—one subject.

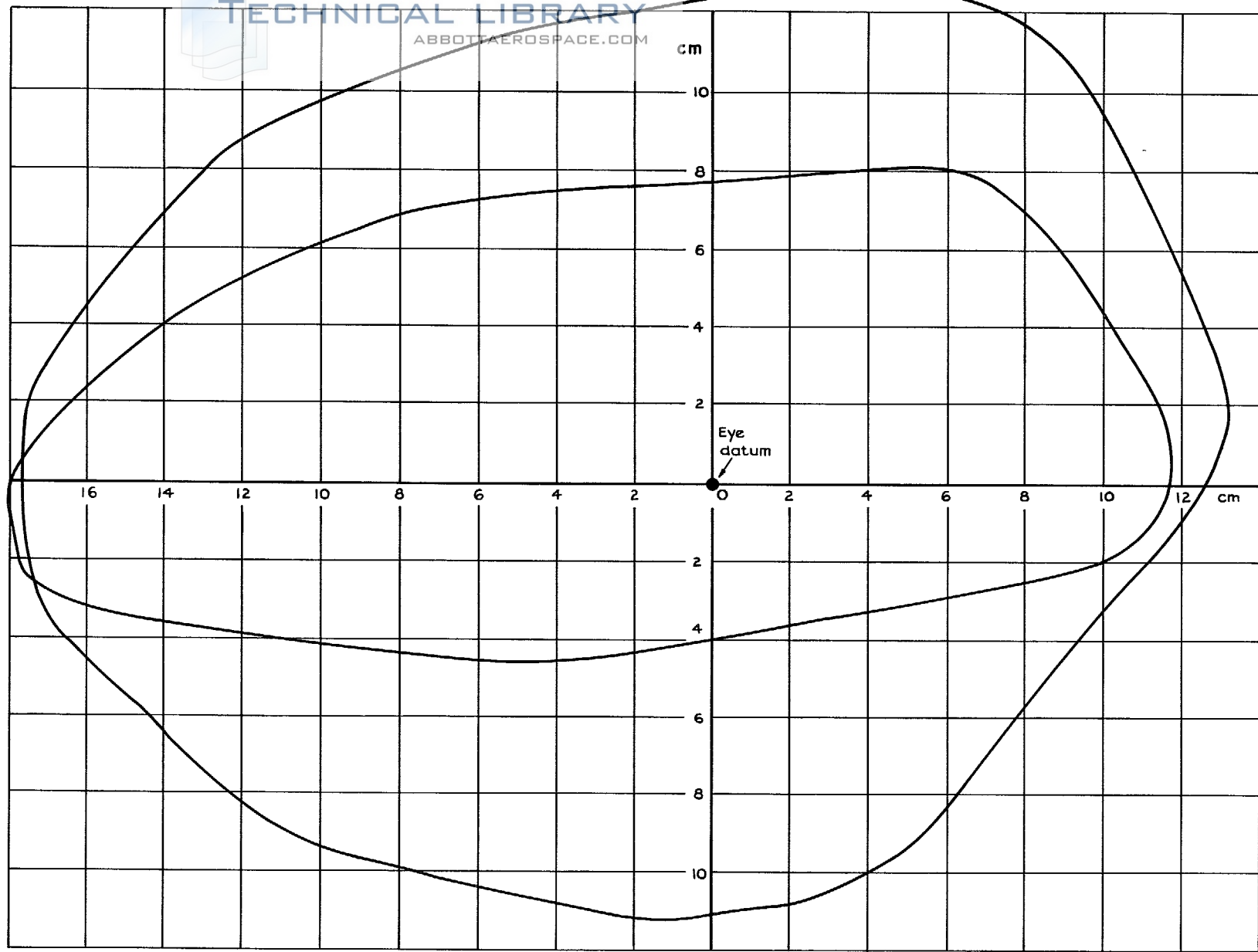

FIG. 17. Plan plots of lateral eye movements showing large and small movements.

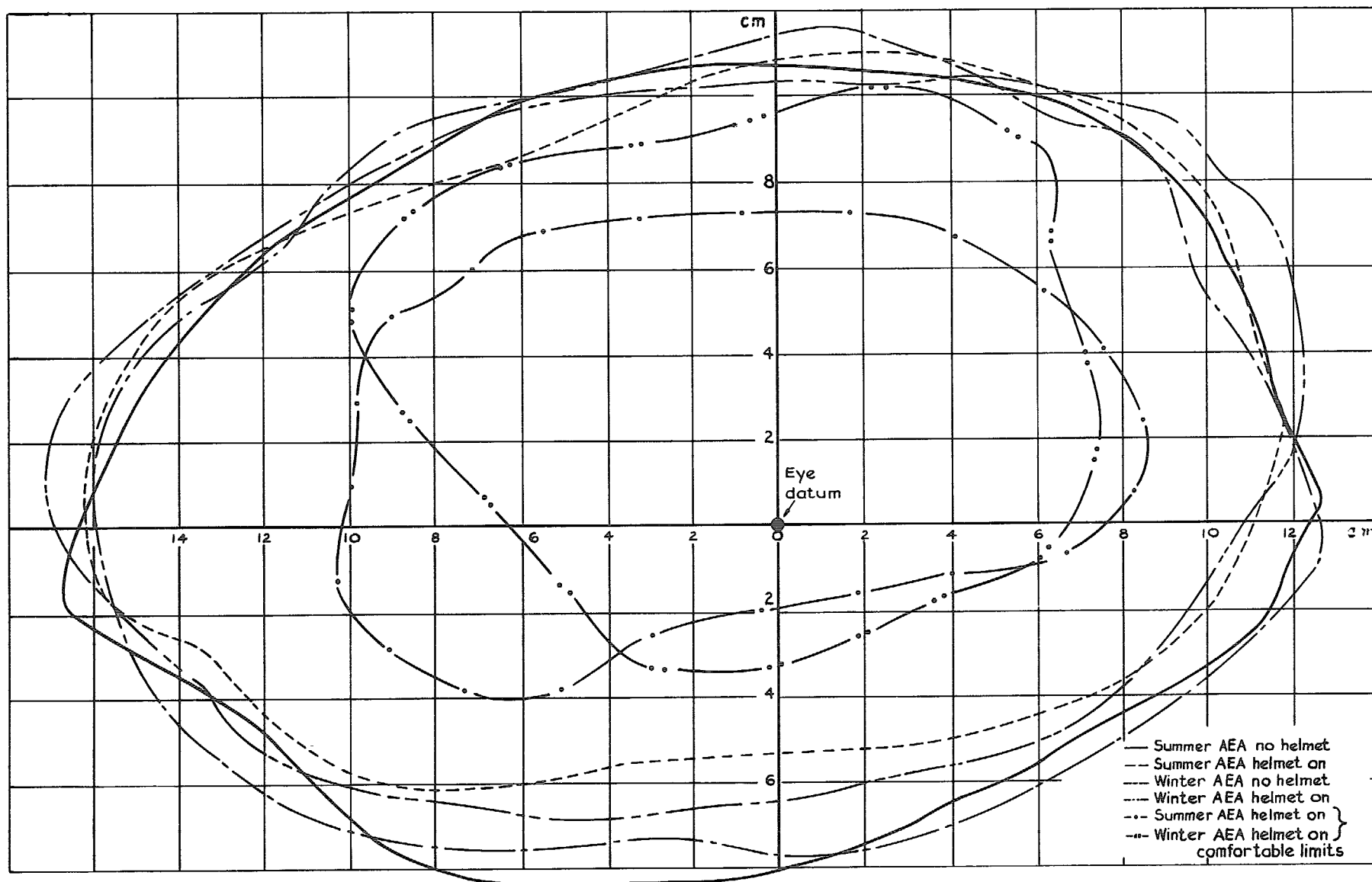

FIG. 18. Median values of plan plots of lateral eye movements for 9 subjects.

Printed in England for Her Majesty's Stationery Office by J. W. Arrowsmith Ltd., Bristol BS3 2NT
 Dd. 587484 K.S. 7/77

R. & M. No. 3803

© Crown copyright 1977

HER MAJESTY'S STATIONERY OFFICE

Government Bookshops

49 High Holborn, London WC1V 6HB
13a Castle Street, Edinburgh EH2 3AR
41 The Hayes, Cardiff CF1 1JW
Brazennose Street, Manchester M60 8AS
Southey House, Wine Street, Bristol BS1 2BQ
258 Broad Street, Birmingham B1 2HE
80 Chichester Street, Belfast BT1 4JY

*Government Publications are also available
through booksellers*

R. & M. No. 3803

ISBN 0 11 470974 2