

AD A 038849

12
NW

AD

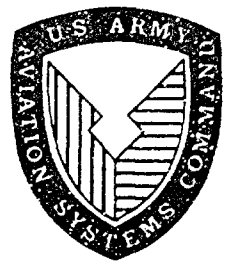

This Document Contains Pages
Reproduced From
Best Available Copy

AVSCOM Report No. 76-22

PRODUCTION ENGINEERING MEASURES PROGRAM
MANUFACTURING METHODS AND TECHNOLOGY

EVALUATION OF SCRATCH- AND SPALL-RESISTANT WINDSHIELDS

JOHN R. PLUMER and WILSON C. McDONALD
Army Materials and Mechanics Research Center
Watertown, Massachusetts 02172

AMMRC TR 76-39

December 1976

Final Report

Approved for public release; distribution unlimited.

Prepared for

U.S. ARMY AVIATION SYSTEMS COMMAND
St. Louis, Missouri 63166

DDC
RECEIVED
MAY 2 1977
B

AD NO. _____
DDC FILE COPY

The findings in this report are not to be construed as an official Department of the Army position, unless so designated by other authorized documents.

Mention of any trade names or manufacturers in this report shall not be construed as advertising nor as an official indorsement or approval of such products or companies by the United States Government.

DISPOSITION INSTRUCTIONS

Destroy this report when it is no longer needed.
Do not return it to the originator.

UNCLASSIFIED

SECURITY CLASSIFICATION OF THIS PAGE (When Data Entered)

REPORT DOCUMENTATION PAGE		READ INSTRUCTIONS BEFORE COMPLETING FORM
1. REPORT NUMBER 18 AVSCOM Report No. 76-22 ✓	2. GOVT ACCESSION NO.	3. RECIPIENT'S CATALOG NUMBER
4. TITLE (and Subtitle) 6 EVALUATION OF SCRATCH- AND SPALL-RESISTANT WINDSHIELDS.	5. TYPE OF REPORT & PERIOD COVERED 9 Final Report.	
7. AUTHOR(s) 10 John R. Plumer Wilson C. McDonald*	6. AVSCOM REPORT NUMBER 14 AMMRC-TR-76-39 ✓	
8. PERFORMING ORGANIZATION NAME AND ADDRESS Army Materials and Mechanics Research Center Watertown, Massachusetts 02172 DRXMR-R	9. CONTRACT OR ORDER NUMBER(s) DAAG46-78-C-0005 ✓	
11. CONTROLLING OFFICE NAME AND ADDRESS U.S. Army Aviation Systems Command ATTN: DRSAV-EXT P.O. Box 209, St. Louis, Missouri 63166	10. PROGRAM ELEMENT, PROJECT, TASK AREA & WORK UNIT NUMBERS D/A Project: 1728005 AMCMS Code: 1496 94.3 P8005 (XD3)	
14. MONITORING AGENCY NAME & ADDRESS (if different from Controlling Office)	12. REPORT DATE 11 Dec 1976 1976	
	13. NUMBER OF PAGES 26 123 p.	
	15. SECURITY CLASS. (of this report) Unclassified	
16. DISTRIBUTION STATEMENT (of this Report) Approved for public release; distribution unlimited.		
17. DISTRIBUTION STATEMENT (of the abstract entered in Block 20, if different from Report)		
18. SUPPLEMENTARY NOTES *Goodyear Aerospace Corporation, Arizona Division, ✓ Litchfield Park, Arizona 85340 Presented at the Conference on Aerospace Transparent Materials and Enclosures, Atlanta, Georgia, on November 18 to 21, 1975.		
19. KEY WORDS (Continue on reverse side if necessary and identify by block number) Bird impact Abrasion coating Composites As-cast acrylic Polycarbonate Chemically-strengthened glass Ballistic spall Acrylics		
20. ABSTRACT (Continue on reverse side if necessary and identify by block number) (SEE REVERSE SIDE)		

403105 *James*

DDC
 RECORDED
 MAY 2 1977
 REGISTRY

UNCLASSIFIED

SECURITY CLASSIFICATION OF THIS PAGE (When Data Entered)

Block No. 20

ABSTRACT

↙ A program was conducted to develop and assess materials configurations offering a potential improvement to the scratching and spalling problems present in existing Army helicopter windshields.

Two prototype designs were fabricated for the UH-1 helicopter, flight tested at Ft. Rucker, Alabama, and subjected to ballistic and bird impact tests while under flight-simulated conditions. The designs tested included an acrylic windshield (used as the standard), a monolithic polycarbonate windshield with an abrasion-resistant coating on both surfaces, and a glass-plastic composite using Chemcor and polycarbonate materials. ↘

Flight test results demonstrated that the coated polycarbonate design can provide approximately 1200 service flight hours, or four times the average service life span of a typical acrylic windshield. Ballistic impact testing of the polycarbonate designs produced the best spall resistance (essentially no spall), while the other configurations produced many dangerous fragments. Bird impact results graphically demonstrated that the polycarbonate prototype provided the superior resistance, i.e., resistance to bird strikes at speeds up to 120 knots while the standard acrylic windshield was incapable of defeating a bird strike at the UH-1 cruising speed of 90 knots.

In general, the superior mechanical properties and the flight worthiness of the coated polycarbonate configuration have been demonstrated.

CONTENTS

	Page
FOREWORD.	iii
INTRODUCTION.	1
DEVELOPMENT OF PROTOTYPE GLAZINGS	1
FLIGHT TEST STUDY	
Program Scope and Objectives	2
Description of Prototype Parts	3
Test Procedure	4
Test Results	4
Discussion	5
BALLISTIC AND BIRD IMPACT STUDY	
Program Scope and Objectives	8
BALLISTIC TESTING	8
Test Procedure	8
Test Results	11
Analysis of Spall Characteristics.	11
BIRD IMPACT TESTING	
General.	16
Test Results	17
CONCLUSIONS	19
RECOMMENDATIONS	22

ACCESSION 1 of

NTIS	White Section <input checked="" type="checkbox"/>
DDC	Buff Section <input type="checkbox"/>
UNANNOUNCED	<input type="checkbox"/>

JUSTIFICATION.....

BY.....

DISTRIBUTION/AVAILABILITY CODES

DIAL	SERIAL	SPECIAL
A		

FOREWORD

This project was accomplished as part of the US Army Aviation Systems Command Manufacturing Technology program. The primary objective of this program is to develop, on a timely basis, manufacturing processes, techniques, and equipment for use in production of Army materiel. Comments are solicited on the potential utilization of the information contained herein as applied to present and/or future production programs. Such comments should be sent to: US Army Aviation Systems Command, ATTN: DRSAV-EXT, P.O. Box 209, St. Louis, MO 63166.

PRECEDING PAGE UNCLASSIFIED

INTRODUCTION

Recent combat experience has demonstrated that the frequent replacement of Army helicopter glazings is mainly necessitated by loss of transparency due to surface scratching, primarily caused by wiper blade action and prop-wash blown dust.

The acrylic glazing currently used in most Army aircraft is insufficiently hard for the abrasive conditions encountered in the field, and produces potentially dangerous spall on foreign object impact, e.g., blown rocks or small arms fire.

Previous work in this development program resulted in the design and contract fabrication of prototype windshields for UH-1 Army helicopter in two basic configurations, each of which incorporates fabrication concepts to increase serviceability, provide for increased crew safety, and utilize readily available commercial materials.¹

The object of this effort is two-fold: (1) to determine the flight worthiness and the serviceability (resistance to abrasion) of the two prototype windshield concepts through actual flight testing of full-size windshield parts; and (2) to assess the relative improvement in spallation characteristics of these concepts through bird impact and ballistic impact of full-size parts in a simulated flight regime.

This report summarizes the initial laboratory work contributing to the design and subsequent fabrication of the prototype parts. The flight testing of these prototype windshields has been evaluated to verify the considered improvements in the serviceability offered by both design concepts. Bird and ballistic impact studies were performed utilizing full-size windshield parts and a simulated flight regime. This experience was examined to verify the results from laboratory impact studies conducted on subsized materials specimens. Recommendations of an optimal prototype windshield configuration, suitable for retrofit on existing aircraft, are made on the basis of the flight test performance and the bird and ballistic impact study damage.

DEVELOPMENT OF PROTOTYPE GLAZINGS

The problems of scratching and spalling encountered with acrylic plastic glazings were addressed by incorporation of coated polycarbonate as either a rear ply in a composite configuration, or as a monolithic sheet. One prototype glazing concept utilized a thin glass cladding for abrasion resistance, coupled with a polycarbonate backup ply to provide the required strength and spall resistance. A second prototype concept utilized a hard surface coating applied to inner and outer surfaces of a monolithic polycarbonate glazing to achieve improvements in abrasion resistance.

The laboratory ballistics studies were carried out¹ on test samples to determine improvements in spallation characteristics of these configurations as compared

1. PLUMER, J. R. *Development of Scratch- and Spall-Resistant Windshields*. Army Materials and Mechanics Research Center, AMMRC TR 74-19, August 1974.

to the currently used acrylic plastic. The results showed monolithic polycarbonate produced thirteen times less spall by weight than an acrylic UH-1 windshield.

A variety of commercially available protective coatings were evaluated by utilizing two test apparatuses designed to simulate aircraft conditions. Abcite, a hard surface coating, provided the best coated scratch protection for the plastic component. Resistance to abrasion over current acrylic material was increased by a factor of 130. Cladding the plastic surface with glass provided abrasion resistance over 1000 times that of acrylic plastic.

In-house laboratory ballistic and abrasion testing of sample materials and configurations indicated that two windshield designs, glass-clad polycarbonate and Abcite-coated polycarbonate, should provide an effective increase in serviceability (abrasion resistance) and virtually eliminate the problems of spallation encountered with acrylic plastics. Laboratory data was insufficient (i.e., not representative of all parameters of actual flight conditions) to permit a selection of one configuration over another. Consequently, both designs were fabricated into full-size, flightworthy prototype windshield parts for the UH-1 helicopter.

Evaluation of flight testing and tests simulating service impact conditions (bird and ballistic test study) carried out on these prototype windshields provided verification of the laboratory studies and permitted assessment of the potential of both designs.

Prototype parts of both designs were fabricated for AMMRC by Goodyear Aerospace Corporation, Contract DAAG46-73-C-0079. The structural requirements for the UH-1 helicopter windshields were analyzed by the contractor. Design requirements for the scratch and spall concepts were integrated with the structural requirements for the windshield parts, thus producing flightworthy, full-size prototype windshield glazings suitable for field and flight test evaluation. Configurations of the prototype windshield parts are shown in Figure 1. Typical properties of the windshield are shown in Table 1. These configurations, including edge attachment, conformed to Bell Helicopter drawing P/N 204-030-666-44, i.e., right-hand (pilot) glazings. Three prototype parts in each configuration were fabricated during this phase of the program; work was begun in the spring of 1973.

FLIGHT TEST STUDY

Program Scope and Objectives

The purpose of the flight test program was to verify anticipated improvements in abrasion-resistant properties and consequently enhanced maintainability offered by both design concepts.

The specific objectives of the testing were as follows:

- a. To determine if any deficiencies occur in the test windshields during flight testing.
- b. To determine if any increase or decrease in wear and abrasion is evident when compared to standard windshields.

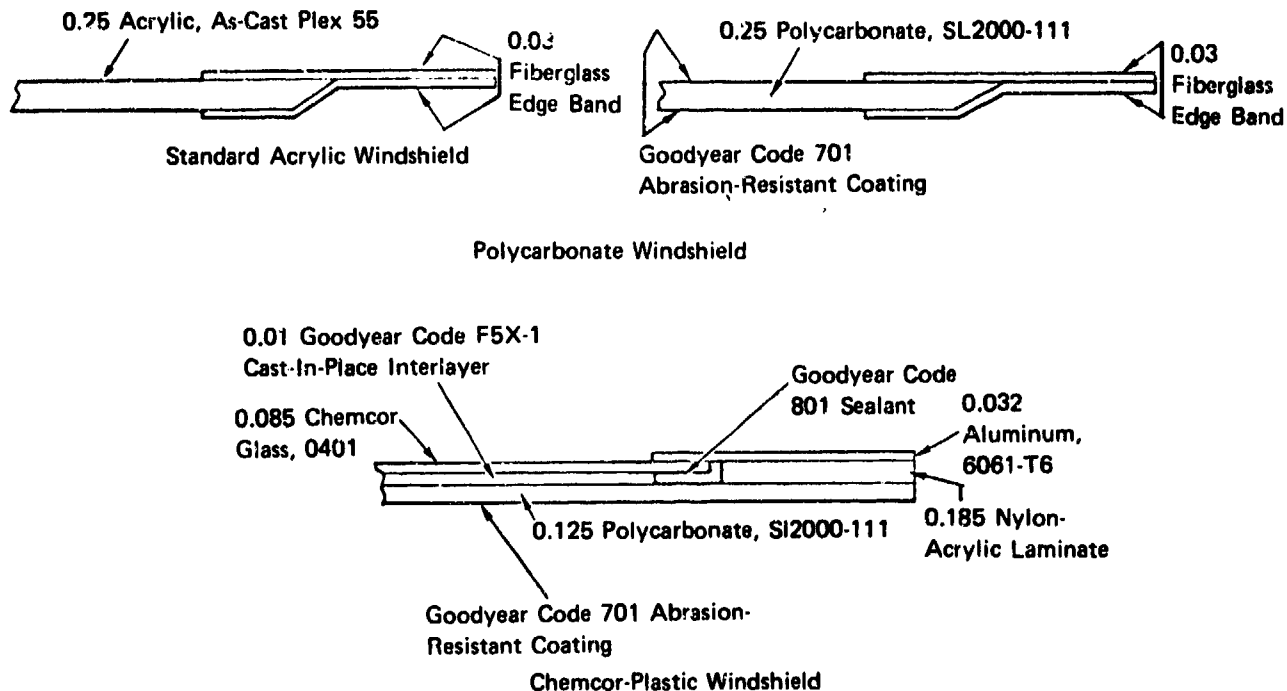

Figure 1. UH-1 windshield test configurations.

Table 1. WINDSHIELD TEST DATA

Windshield Material	Total Weight (lb)	Luminous Transmittance (percent)	Haze (percent)
Standard acrylic	12.7	91.5	1.0
Polycarbonate	13.8	89.0	1.0
Chemcor* plastic	24.2	90.0	0.5

*TM, Corning Glass Works, Corning, N. Y. 14830

Test pilots and maintenance personnel were instructed to be especially critical of optical characteristics in flight and the surface condition of the glazings after each flight.

Description of Prototype Parts

UH-1 windshield parts submitted for flight testing and evaluation included the following:

- a. Monolithic polycarbonate-Abcite* coated, serial numbers SN-1, SN-2, and SN-3 (control windshield not tested).
- b. Glass-polycarbonate composite type, serial numbers SN-4 (control windshield not tested), SN-5, and SN-6.
- c. As-cast acrylic parts (two each), copilot configuration.

Test Procedure

A two-year (maximum) flight test program was established with the U. S. Army Test and Evaluation Command (TECOM Project A1-171-001-001) through coordination by the Army Aviation Systems Command. Under TECOM direction the U. S. Army Aviation Test Board conducted this product improvement test in the vicinity of Fort Rucker, Alabama, and Apalachicola, Florida, during the period 27 July 1973 through February 1975. Four test windshields for the pilot position and two standard windshields for the copilot position were tested as follows.

(a) The test and standard windshields were installed using standard maintenance procedures outlined in Reference 2. The windshields were inspected for scratches and distortion as outlined in References 3 and 4. The windshield wiper system was modified so that one switch controlled both wipers. Cleaning procedures utilizing water only were specified, instructions were stenciled on test and control parts.

(b) Test windshield SN-1 was installed in the pilot position and a new standard windshield in the copilot position on JUH-1H helicopter SN 68-15380 on 27 July 1973. Both windshields were removed on 23 August 1974.

(c) Test windshield SN-2 was installed in the pilot position with a new standard windshield in the copilot position in JUH-1H helicopter SN 66-499 on 8 September 1973. On 23 August 1974, at 735.9 flight hours, these windshields were transferred into JUH-1H helicopter SN 68-15380 and remained in test through 1 February 1975.

(d) Test windshield SN-5 was installed in the pilot position in JUH-1H helicopter SN 68-16361 on 17 January 1974 and tested until 25 April 1974. Test windshield SN-6 was installed in the pilot position in JUH-1H helicopter SN 68-16361 on 25 April 1974 and tested until 1 May 1974. The installation of test windshields SN-5 and SN-6 was witnessed by representatives from the manufacturer and AMMRC.

Test Results

Flight hours logged by the four prototype parts are shown in Table 2. Both Abcite-coated polycarbonate parts (SN-1 and SN-2) showed a moderate loss of Abcite coating on the outer surfaces after approximately 900 flight hours; however, visual properties were not severely affected. Deep scratches developed throughout the test period in both the SN-1 and SN-2 prototypes and the standard acrylic control parts. This is due to sand-size particles being carried across the surface of the glazing during wiper blade action. Control and test parts both appeared to develop this type of scratching with equal ease. Shallow scratching (i.e., wear) within the wiper blade path developed more rapidly and to a greater extent on the acrylic parts. The coated polycarbonate parts maintained overall superior optics

2. Technical Manual 55-1520-210-34, Direct Support and General Support Maintenance Manual, 10 September, revised 16 August 1974.
3. Technical Manual 55-1520-210-20, Organizational Maintenance Manual, 10 September 1971, revised 9 October 1974.
4. U. S. Army Aviation Systems Command, DRSAV-EFT, Letter dated 20 November 1972, Request for UH-1D/H Product Improvement Windshield Tests.

Table 2. TEST DATA

Prototype Parts	Flight Hours	Time in Months	Termination
SN-1 (Abcrite-coated polycarbonate)	1199.2	13	Loss of Coating
SN-2 (Abcrite-coated polycarbonate)	967.0	11.5	Request by AMMRC
SN-5 (Glass/polycarbonate)	389.7	3	Minor Distortion
SN-6 (Glass/polycarbonate)	73.3	1/4	Severe Distortion

for a longer time throughout the test. This is demonstrated by the photograph in Figure 2 which shows the superior optics of windshield (SN-2) midway through the testing.

Flight testing of prototype windshield (SN-1) was terminated at 1190.2 hours due to partial loss of the coating. Without this coating it was obvious that wear would rapidly develop, Figure 3. The SN-2 windshield was removed at the request of AMMRC at approximately 1000 hours. It was determined that recoating of this part with Abcrite would not be practical. At the conclusion of flight testing, both coated polycarbonate parts, aside from the scratching and partial loss of coating, appeared free of defects, (e.g., cracking, excessive haze, or microcrazing). Both control parts were also free of these defects. The SN-2 prototype and acrylic windshields at the conclusion of flight testing are shown by photographs in Figure 4. The glass-clad polycarbonate prototypes (SN-5 and SN-6) exhibited virtually no scratching or surface wear, nor were other deficiencies revealed. The primary objection voiced on the flight characteristics of the glass-clad prototype was the slight distortion present in each of the parts. This distortion may be detected in the photographs shown in Figures 5 and 6.

General comments made by the flight test pilots of each of these windshields stated although the distortion was small and in a usually noncritical portion of the windshield (see Figure 5), it caused some eye strain and some orientation difficulties. Other pilots' comments noted the parallax error (due to differences in right-hand and left-hand windshield thicknesses) as a visual annoyance. This could not be resolved within the scope of the program as it would require glass/plastic windshields in both left- and right-hand configurations but would not be a problem in production windshields.

Discussion

The flight test results of both configurations of prototypes verified the concepts for improving abrasion resistance. The polycarbonate coating did provide improved wear characteristics over plain acrylic; the superior resistance was maintained up until a time when an appreciable amount of a surface coating was lifted off (approximately 900 hours) as a result of environmental effects, primarily absorption of water within the polycarbonate material causing a debonding of the Abcrite coating. Previous studies (Reference 5) and observations made

5. JAMES, H., and INGELSE, A. O. *Design Test and Acceptance Criteria for Army Helicopter Transparent Structures*. USAAMRDL, TR 73-19, May 1973.

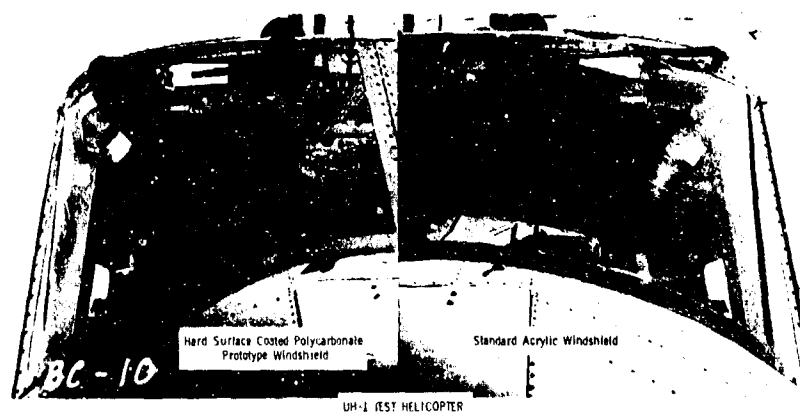

Figure 2. Windshields during flight testing - 385 flight hours.
19-066-141/AMC-74



Figure 3. SN-1 prototype windshield at 1190.2 flight hours.

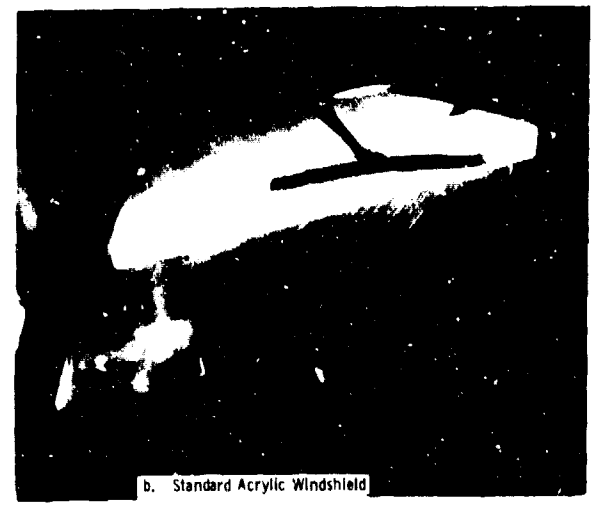
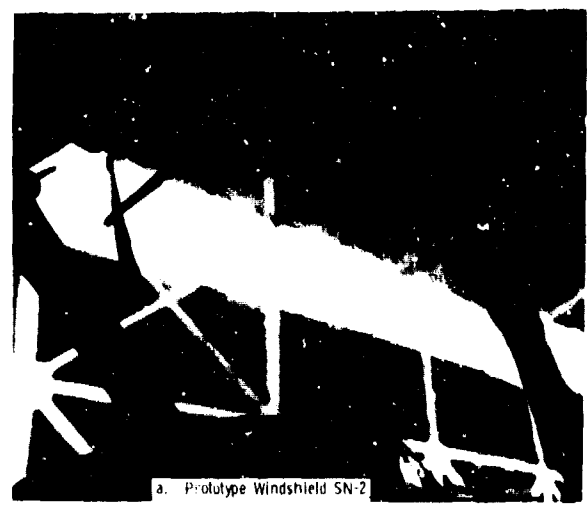

Figure 4. Prototype windshield SN-2 (a) and acrylic windshield (b) at 967 flight hours.

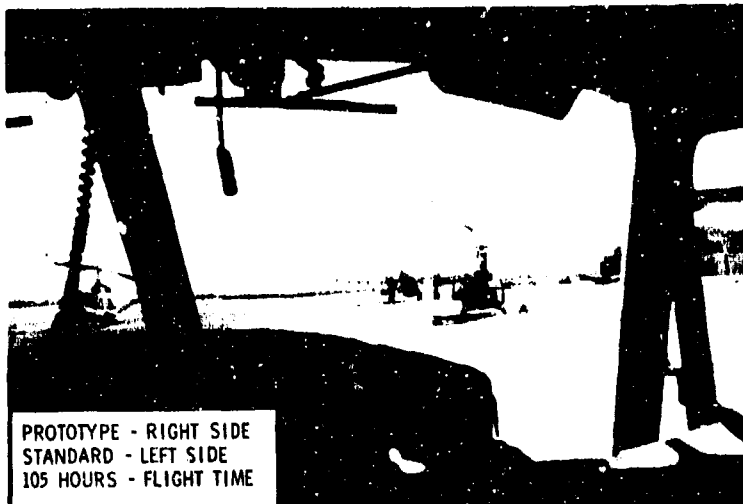

Figure 5. Prototype windshield SN-5, 105 flight hours.
 19-066-1728/AMC-75



Figure 6. Glass/polycarbonate prototype.

during the flight test phase of this program indicate that severe scratching and an appreciable amount of surface wear (haze) develops on acrylic UH-1 windshields by approximately 350 flight hours; in many cases this warrants replacement of the windshields. The glass-faced prototype provided excellent abrasion resistance, exhibiting virtually no scratching or abrasion at the conclusion of the flight testing. The distortion present in the glass-faced polycarbonate parts primarily resulted from the difficulties of obtaining reproducible glass contours during limited production of the glass components used in this configuration. It was felt by the contractor that distortion could be greatly reduced by further development work with the glass suppliers.

BALLISTIC AND BIRD IMPACT STUDY

Program Scope and Objectives

Contract DAAG46-75-C-0005 was issued with Goodyear Aerospace Corp. as a continuing effort to determine how these improved abrasion-resistant helicopter windshields would react under ballistic and bird impact. Good data have been lacking in these areas, and this contract was initiated to fill in some of the information gaps that existed on helicopter windshields.

The work effort was conducted at the Litchfield Park, Arizona, plant where both fabrication and test facilities are located. The program was broken down into the following efforts:

1. Monolithic polycarbonate windshields. Two 1/4-inch monolithic polycarbonate windshields were fabricated with abrasion-resistant coating (Abcite) on both the inner and outer surfaces. The windshield configurations, including edge attachment, conformed to Bell Helicopter drawing P/N 204-030-666-44. A third windshield previously fabricated by Goodyear Aerospace was supplied by the Army to provide the remaining part needed for the test program. The parts were fabricated using SL 2000-111 grade press-polished polycarbonate.
2. Glass-plastic windshields. Two composite glass-plastic windshields were fabricated to the standard UH-1 shape. The third unit previously built by Goodyear Aerospace was furnished by the Army for inclusion in the test program.
3. Standard acrylic windshields. The Army furnished three standard as-cast acrylic UH-1 windshields (P/N 204-030-666-44) from inventory. Details of the construction of these test articles are shown in Figure 1.

BALLISTIC TESTING

Ballistic testing was conducted on one each of the three windshield types being evaluated. Each windshield was subjected to three ballistic strikes using caliber .30 ball M2 projectiles at a velocity approximating that of a 100-yard range. The strikes were well above the defeat threshold velocity for any of the windshield constructions tested.

The tests were designed to measure the quantity and nature of back-side spalling resulting from such penetrations. An assessment of post-hit structural integrity and visibility for each windshield construction was also sought.

Test Procedure

Each windshield tested was mounted in the UH-1 structure in a manner approximating a normal installation for this article. A transparent plastic box was mounted directly behind the windshield. This box was utilized to apply a vacuum to the aft side of the windshield during test to simulate aerodynamic loading imposed at the aircraft redline speed of 120 knots (see Figure 7). The calculated loading for the windshield at 120 knots was 0.328 psi.



Figure 7. UH-1 windshield ballistic test structure with pressure box.

The quantity and nature of ballistic spall generated by the penetration of each windshield were recorded in two ways. A witness sheet of 0.020-inch-thick 2024 T3 aluminum alloy was used to record the dispersion pattern and relative lethality of the spall particles. Two high-speed cameras were used to record the overall windshield response and characteristics of any spall generated.

The witness sheet was positioned within the pressure box as a vertically oriented, peripherally supported diaphragm located at the pilot's nominal eye position (aircraft station 53.0). A spall particle having sufficient remaining energy to pierce the witness sheet material placed parallel to and six inches behind the target is normally expected to produce lethal damage or its equivalent from a variety of mass-velocity combinations (Reference 6).

The witness sheet positioned at station 53.0 was approximately 28 inches behind the impact area of each windshield. This location was selected since it approximated the pilot's position and provided visual access to the back side of the windshield for the high-speed cameras which provided the second source of spall documentation.

One high-speed camera operating at 3,000 frames per second was used to view the front side of the windshield. The back side of the windshield was monitored with an 11,000-frame-per-second camera during each test firing. One additional camera operating at a standard framing rate was used to document the test setup and individual firing sequences. A schematic of the ballistic test setup used in this evaluation is shown in Figure 8a and the actual test setup in Figure 8b.

6. MASCIANICA, F. S. *Ballistic Concepts Employed in Testing Lightweight Armor*. Watertown Arsenal Laboratories, WAL MS-12, 5 October 1959.

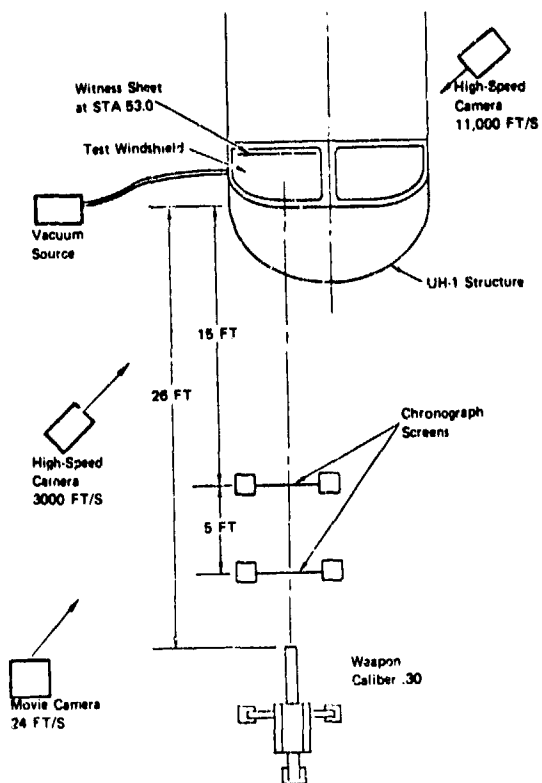

a. Schematic plan view.

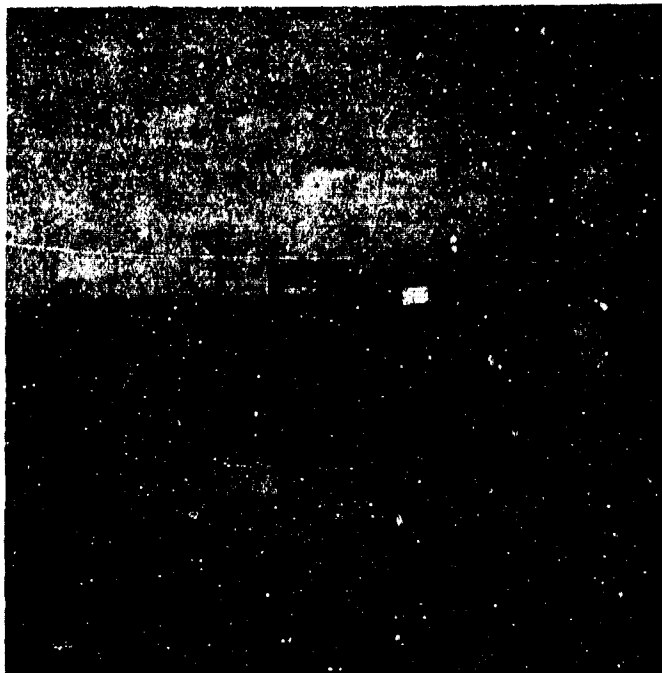

b. Actual test setup.

Figure 8. Ballistic test setup.

Table 3. WINDSHIELD BACK SIDE SPALLING BALLISTIC TEST DATA

Test Article	Round	Test Temperature (deg F)	Velocity (fps)	Witness Sheet Perforations	Witness Sheet Marks	Maximum Dispersion of Spall (in.)
UH-1 standard acrylic windshield P/N 204-030-665-44	1	70	2579	0	6*	14.50
	2	70	2526	0	2*	8.75
	3	75	2540	0	2*	12.75
UH-1 prototype windshield Chemcor-plastic composite	1	65	2566	6	36	10.75
	2	65	2540	10	65	18.00
	3	65	2540	10	32	13.75
UH-1 prototype windshield Monolithic polycarbonate	1	65	2632	0	0	-
	2	75	2500	0	0	-
	3	75	2500	0	0	-

*Spall particles were very widely dispersed, and many did not strike the witness sheet.

Each windshield was impacted with a total of three caliber .30 ball M2 projectiles which had been reloaded to simulate the remaining velocity for this round at 100-yard range (2500 fps). A centrally located equilateral triangle shot placement pattern was used for all three windshields tested. Measurement of the post-test articles showed that the actual center-to-center shot spacings ranged from 6.75 to 9.00 inches.

Test Results

The back-side spalling characteristics of each type of windshield tested are summarized in Table 3. Photographs of the expended test articles, Figure 9, illustrates the extent of overall damage resulting from the ballistic penetrations. Much of the overall glass fracture in the Chemcor-plastic windshield was incurred during post-test removal from the aircraft structure and subsequent handling. More accurate display of the post-hit visibility through this article is shown in the motion picture documentation. The extent of post-hit crack propagation which would occur in flight as a result of aircraft vibration and flight loads imposed is unknown.

Additional details of the comparative material behavior are shown in the front and back-side closeup photographs, Figure 10. The witness sheets from each test are shown in Figure 11. Spall data reported for each test excluded the single perforation of the witness sheet caused by the bulk of the projectile.

Analysis of Spall Characteristics

Typical back-side spall particles collected following one ballistic penetration of each type of windshield are illustrated in Figure 12. After both the physical evidence and photographic data collected were reviewed, the following summary of performance was prepared.

1. Chemcor-plastic composite windshield. The ballistic penetration of this windshield generated many spall particles, a number of which had potentially lethal penetrating characteristics. These penetrating particles are probably both glass and bullet fragments.

This Document Contains Page/s
Reproduced From
Best Available Copy

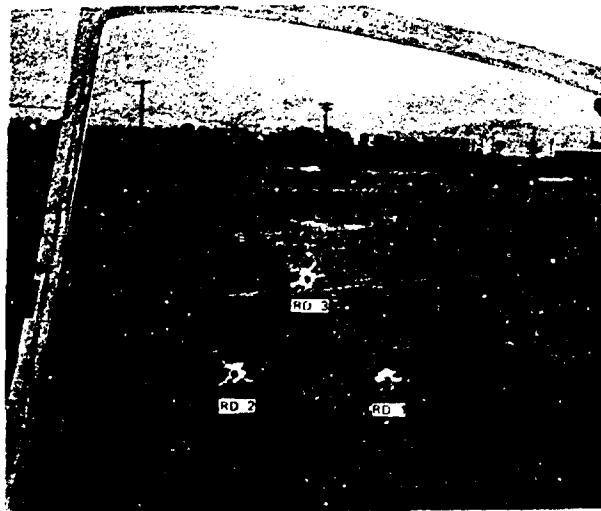

a. UH-1 standard acrylic windshield.

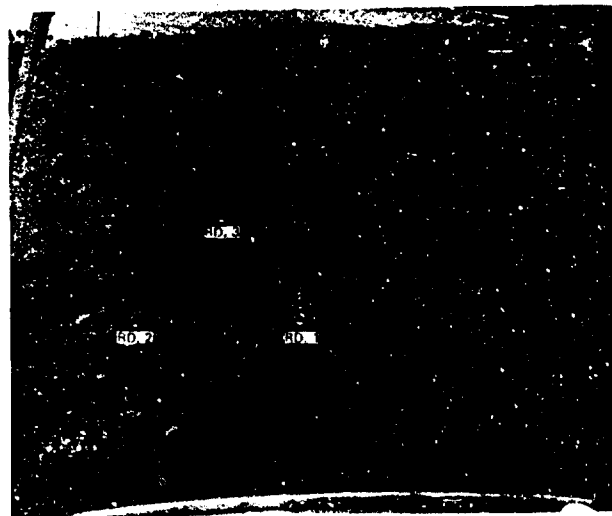

b. UH-1 polycarbonate windshield.



c. UH-1 Chemcor-plastic windshield.

Figure 9. Ballistic test article, post-test display.

The glass outer layer acts to partially break up the projectile. The glass particles and bullet fragments, both having relatively high density, comprise the most hazardous spall. The ductility of the plastic backing ply restricts the dispersion of the spall. The higher-density glass and bullet spall strike the witness sheet at nearly the same instant as the bullet.

This is followed by a cloud of slower, extremely fine particles consisting mostly of glass. The post-hit structural integrity and vision qualities of the windshield appear adequate.

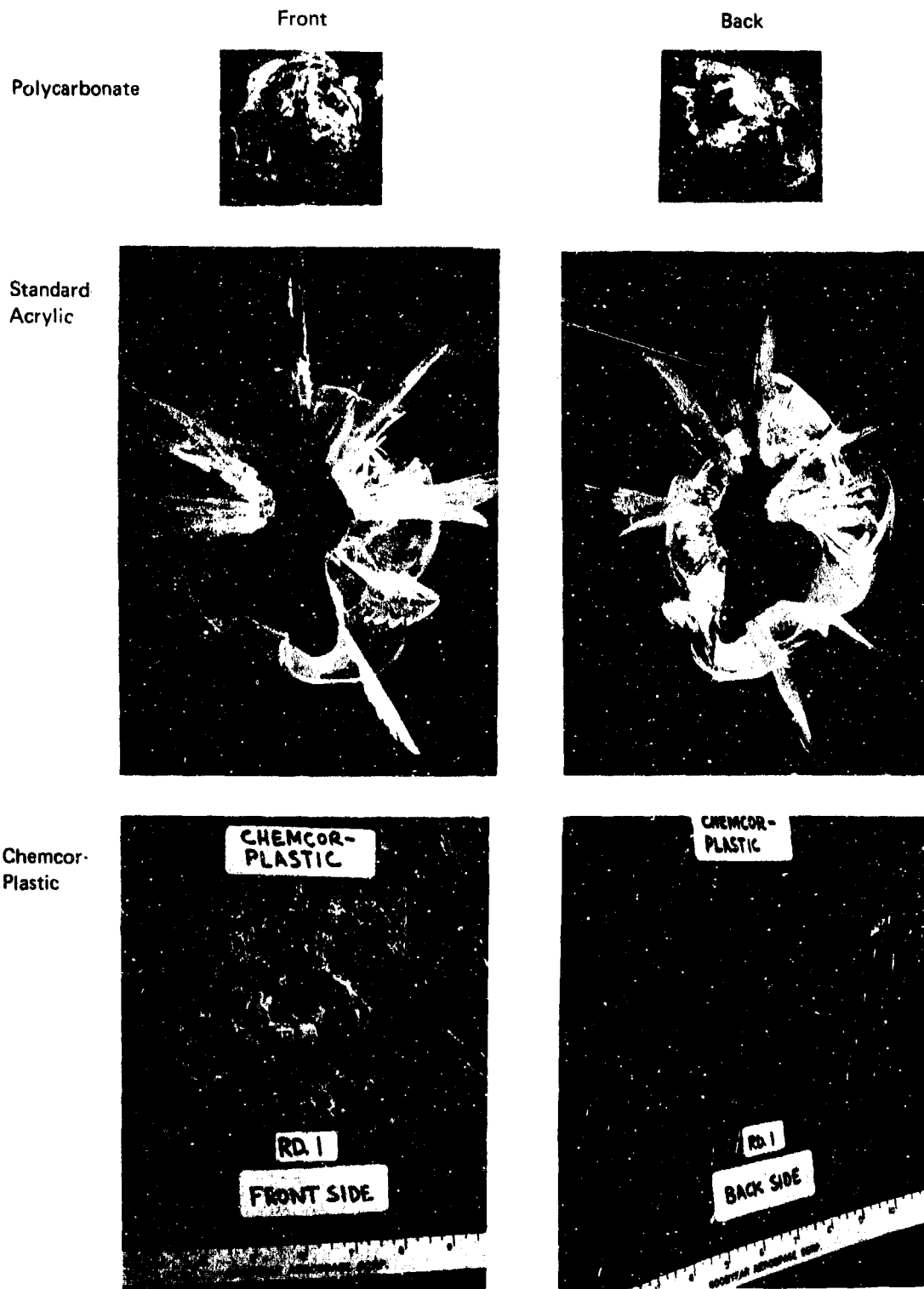
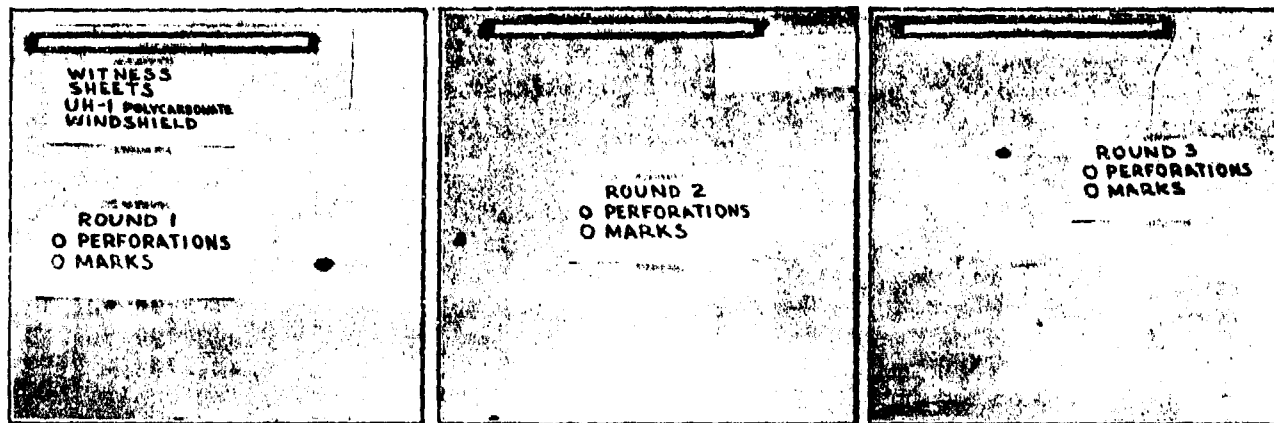
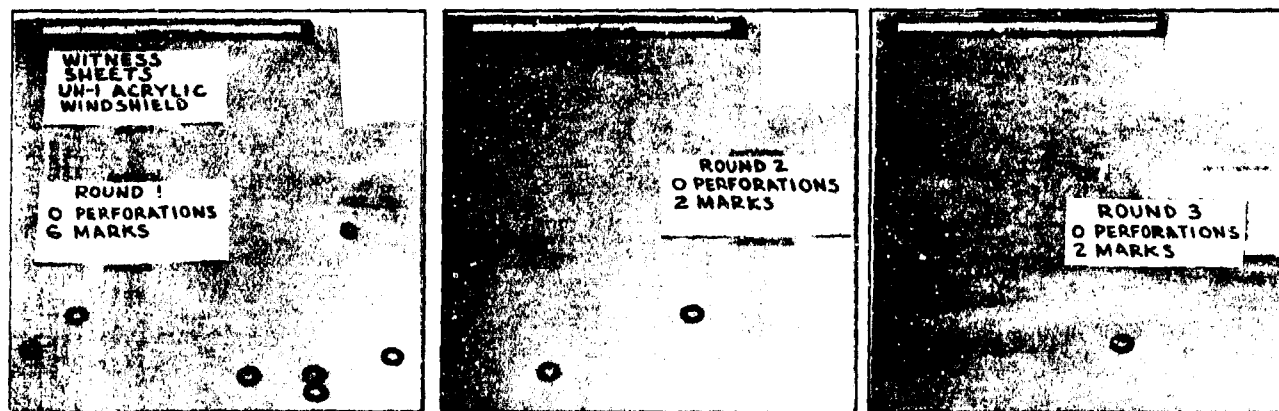

Figure 10. Ballistic penetration of UH-1 windshields, front- and back-side details.



UH-1 polycarbonate windshield.



UH-1 standard acrylic windshield.

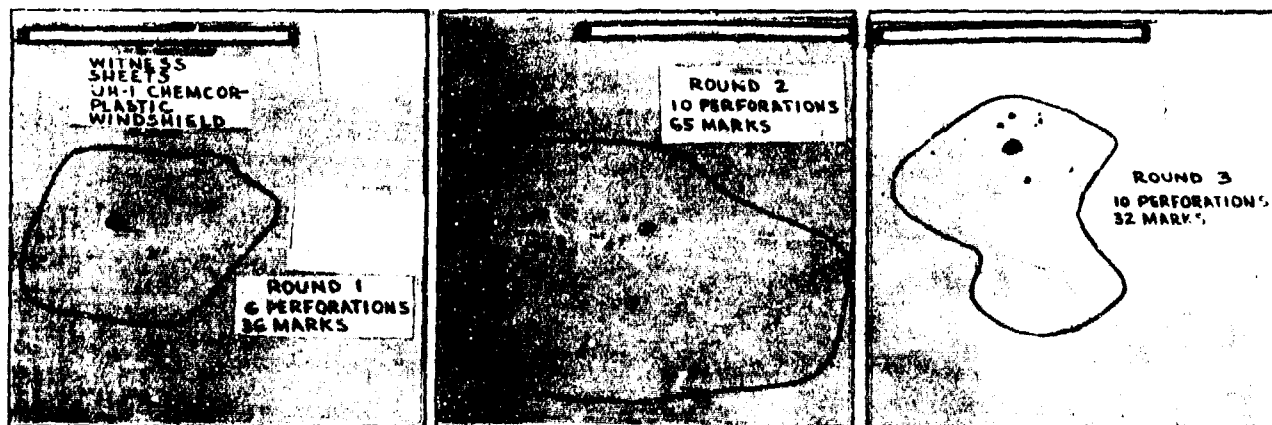

UH-1 chemcor-plastic windshield.

Figure 11. Ballistic spall witness sheets, post-test display.



UH-1 prototype windshield 0.25 polycarbonate.



P/N 204-030-666-44 UH-1 standard windshield 0.25 as-cast plex 55 acrylic.

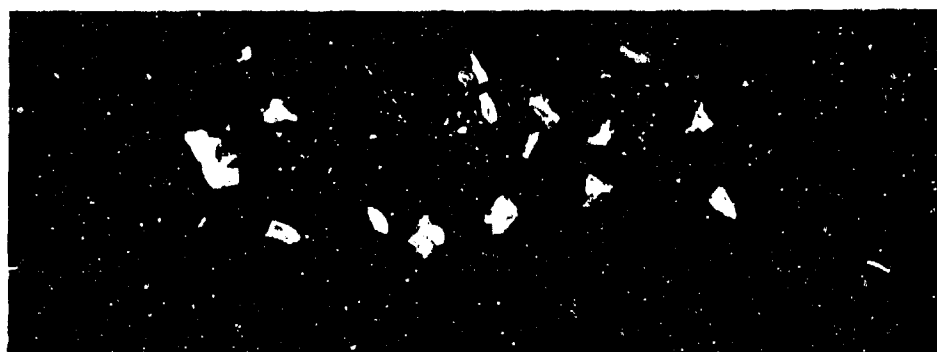

UH-1 prototype windshield Chemcor-plastic composite.

Figure 12. Typical ballistic spall particles, single penetration.

2. Standard acrylic windshield. The acrylic windshield fractures locally at the impact site. A wide variety of particle sizes is removed and widely dispersed. The acrylic particles are sharp edged and potentially dangerous. The extreme dispersion of the particles caused some of them to miss the witness sheet. None of the particles which struck the witness sheet resulted in a potentially lethal perforation.

The combined factors of quantity, dispersion, and cutting nature of the spall from the acrylic windshield are very unfavorable. The use of helmet visors by the aircrew would add significant eye protection against this type of spall. The

disruptive effect on the aircrew flight control created by the spall would be considerable. The post-hit structural integrity and vision qualities for the standard acrylic windshield appear adequate.

3. Monolithic polycarbonate windshield. The polycarbonate windshield withstood the three ballistic penetrations with a minimum amount of damage and spall.

Ductile penetration without cracking, and wound closure to approximately a 1/8-inch-diameter hole were typical. The back side spalling was limited to a very few small polycarbonate particles. None of these particles marked the witness sheets.

BIRD IMPACT TESTING

General

The Goodyear Aerospace bird impact test facility was used to conduct all testing.

The compressed air gun used has a 60-foot-long launch tube with a 6-inch inside diameter barrel. A pressure tank assembly is attached to one end of the launch tube and has a working pressure of 250 psi. The pressure used can be controlled to obtain the bird velocity desired. The four-pound birds (purchased frozen for these tests) were thawed and then were loaded in an aluminum sabot which carried them through the barrel. The aluminum container was stopped by a ring at the end of the barrel, while the bird continued to the target.

The velocity of the bird was measured by using counters to measure the time interval between breaking of "start" and "stop" wires. The stop wire is approximately six feet in front of the target window. A UH-1B fuselage was cut in two behind the front door bulkhead so as to maintain the same structural integrity as an unaltered aircraft. This fuselage section was then positioned and anchored in front of the gun where all tests were conducted (see Figure 13).

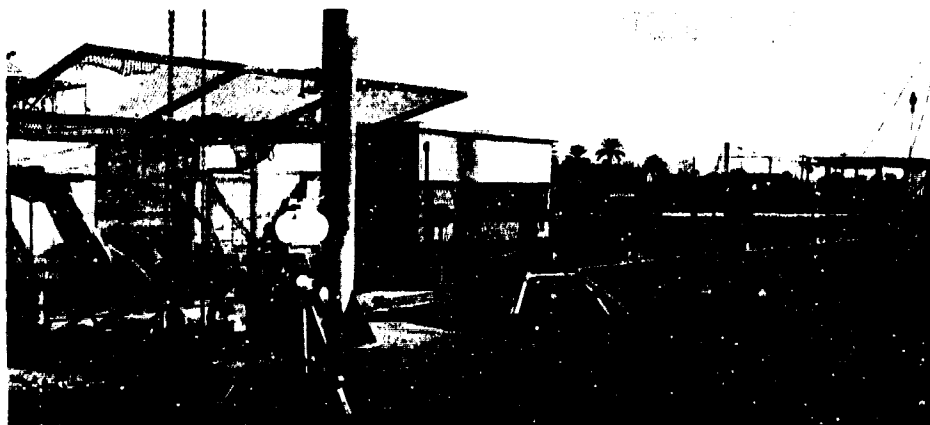

Figure 13. Bird-impact test facility.

The same transparent pressure box employed in ballistic testing was used during each bird shot to simulate aerodynamic loading (see Figure 14).

High-speed motion pictures were used to provide the coverage of each test. Cameras operating at 3000 frames per second were used to view the front and side of each windshield during test. The cameras were activated automatically as a part of the firing sequence. Timed relays were used in the firing circuit to activate the cameras prior to actuation of the gun.

Test Results

The monolithic polycarbonate windshields were selected as the first test items.

Windshield No. 1 was impacted at 114.5 knots with a four-pound bird. This impact resulted in a diagonal crack running from the upper right-hand corner to the lower left-hand edge of the windshield when viewed from the front (see Figure 15a). The bird bounced into the air, and there was no debris in back of the windshield.

Upon close examination of the part, it was noticed that the aircraft structure had bent directly above the spot where the crack terminated. The movies taken confirm the crack initiated in the center of the windshield. The fuselage was bent out into the proper position and readied for the next test.

Monolithic polycarbonate windshield No. 2 was then installed and impacted in the same manner. The impact velocity was 120.8 knots. This impact resulted in several cracks forming and the loss of two pieces of polycarbonate, one in



Figure 14. Bird-impact test structural and pressure box detail.

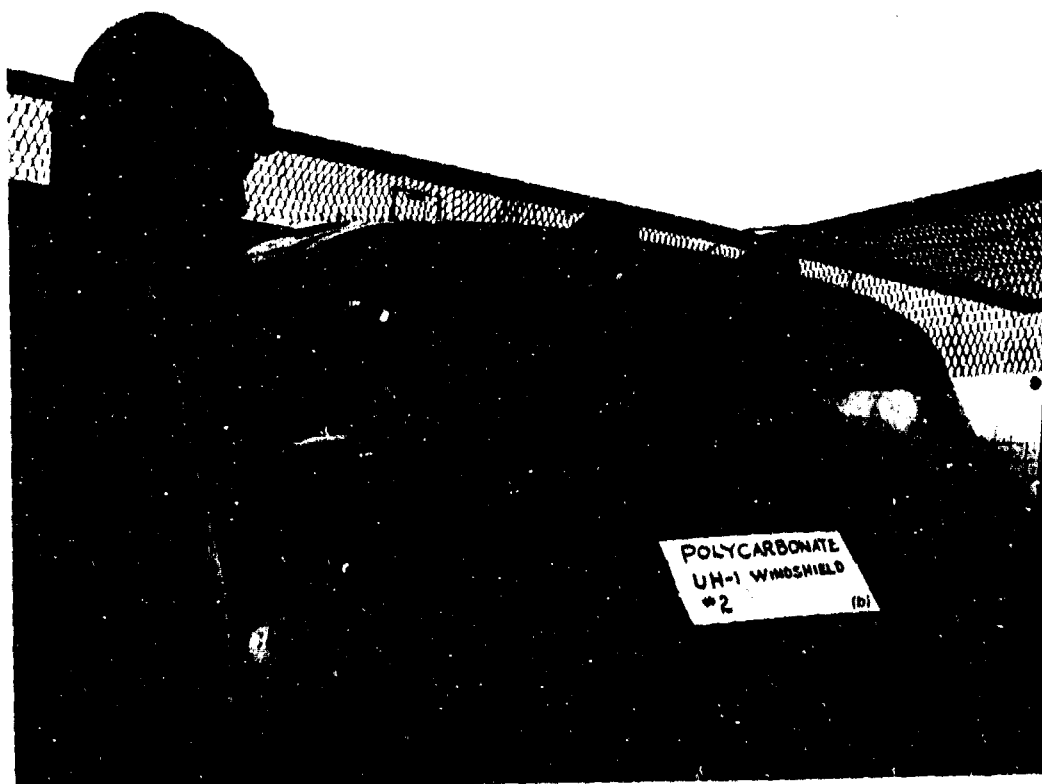

Figure 15. Bird-impacted UH-1 polycarbonate windshields.

each upper corner of the windshield. The two pieces fell outboard away from the fuselage. A break in the polycarbonate occurred along the upper edge attachment. This edge break permitted the remaining polycarbonate to flex inboard and allowed the bird to deflect upward into the pilot's compartment. The bird hit the top of the pressure box before falling to the floor. The center polycarbonate flexed back into position and was firmly held in place by the lower edge attachment (see Figure 15b). The fuselage again bent inward in the same upper inboard area, and the windshield cracks seemed to initiate from this area.

Standard acrylic windshield No. 1 was then mounted in the fuselage and was impacted with the four-pound bird traveling at 121.9 knots. The bird penetrated the windshield and hit the back of the vacuum chamber. The Plexiglas broke out of the frame with only a few jagged fragments remaining along the edge (see Figure 16a). The fuselage was not damaged by the impact.

Because of the catastrophic failure mode of the first standard acrylic windshield, the second standard windshield was fired at 85.6 knots, which is nearer the cruising speed of the UH-1 aircraft. The bird also penetrated this windshield, breaking out nearly 80 percent of the acrylic (see Figure 16b).

The fifth windshield tested was the No. 1 Chemcor-plastic composite. The bird was fired at 115 knots and failed to penetrate the structure. The glass and plastic broke on the lower inboard corner at the edge attachment and bent inward sufficiently to permit small glass particles to enter the lower part of the vacuum chamber (see Figure 17a). The bird bounced upward and fell about ten feet from the aircraft.

The second Chemcor-plastic windshield failed in a similar manner at 92.2 knots. No penetration of the bird occurred, but when the composite broke along the lower inboard edging, small spall particles entered the lower part of the vacuum box (see Figure 17b). The bird bounced and fell approximately ten feet from the windshield.

CONCLUSIONS

Major conclusions from the test program are as follows:

1. Fabrication

All three types of composites fabricated for this program can be manufactured with currently available materials and state-of-the-art fabrication procedures.

2. Abrasion Resistance

Flight testing of the Abcite-coated polycarbonate windshields demonstrated the feasibility of using a protective coating for enhancement of abrasion resistance and increase of serviceability.

Glass cladding demonstrated superior abrasion resistance over either plain acrylic or Abcite-coated polycarbonate.

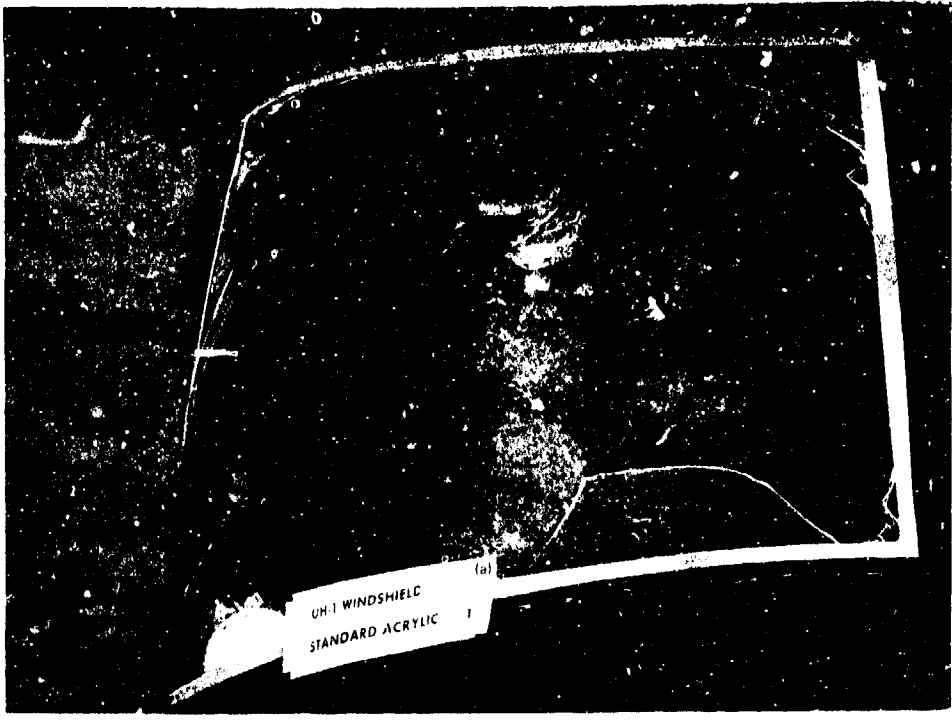

Figure 16. Bird-impacted UH-1 standard acrylic windshields.

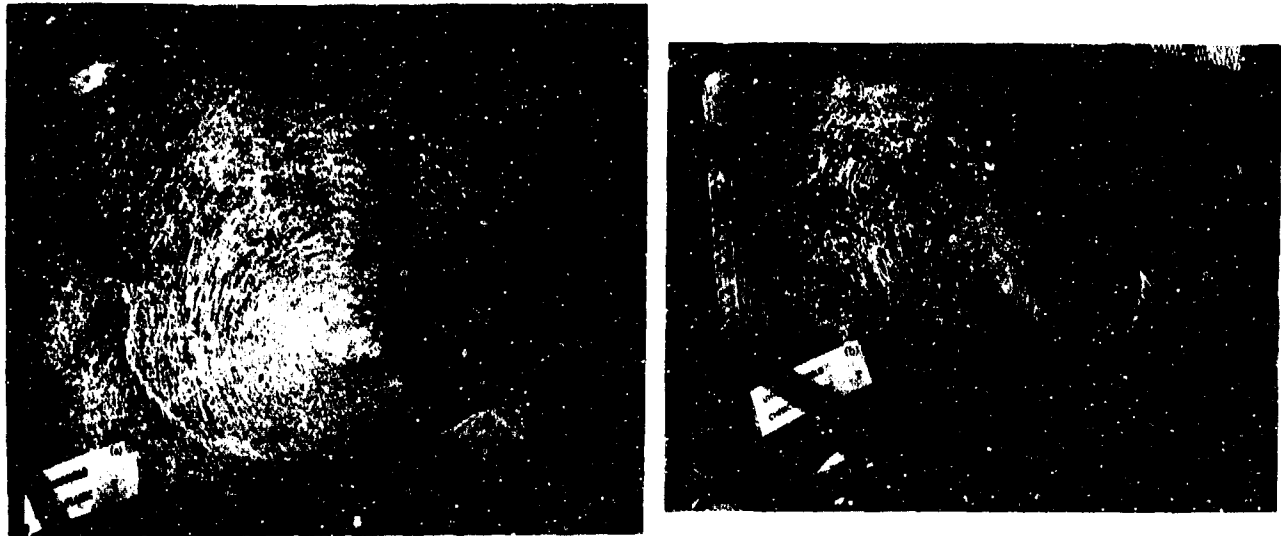

Figure 17. Bird-impacted UH-1 Chemcor-plastic windshields.

3. Ballistic performance

a. Ballistic impact of the monolithic polycarbonate windshields shows that very little spall is released and that partial closure of the wound takes place. This construction proved superior in this respect to the other two types tested.

b. Spall from ballistic impact of the standard acrylic windshield results in many widely dispersed, sharp-edged fragments of considerably varying sizes. The spall particles generated did not appear to have potentially lethal penetrating capability.

The ballistic characteristics of this windshield rank second to those of the monolithic polycarbonate type.

c. The Chemcor-plastic windshields were the only articles tested which generated spall particles having potentially lethal penetrating characteristics. The plastic backing ply acts to restrict the dispersion of the spall, only the heavier particles passed through. Many very fine glass particles follow the heavier particles in a more widely dispersed cloud. The overall spalling characteristics of the Chemcor-plastic windshields were the least acceptable of all windshields tested in this program.

4. Bird Impact Study

a. Both the monolithic polycarbonate with abrasion coating and the Chemcor-plastic composite construction offer far greater bird strike protection to UH-1 aircrews than the standard acrylic windshield.

b. The standard acrylic windshield at both the cruising speed (90 knots) and the maximum speed of the UH-1 is incapable of defeating a bird strike. The as-cast Plexiglas breaks into large, sharp-edged fragments which could cause serious injury to the aircrew.

c. The two monolithic polycarbonate windshields tested indicated they would provide considerable protection against bird strikes even at redline speed (120 knots) of the UH-1 aircraft. Improved restraint by the edgeband appears necessary to improve bird strike performance.

d. Chemcor-plastic composite offers bird protection from cruising speed (90 knots) to maximum redline speed (120 knots) of the UH-1 aircraft. Some breakage occurred along the edgeband transition of both windshields in the lower inboard corner. The breakage allowed spall to enter the cabin area. A redesign of the edge attachment is needed to withstand the bird strike loading.

RECOMMENDATIONS

The favorable abrasion resistance and excellent impact-resistant properties demonstrated by the Abcite-coated polycarbonate prototype design results in the recommendation that this configuration would be feasible and desirable as a retrofit item on aircraft operating in severe field or combat situations.

Based on this program the following recommendations are also made:

1. The bird strike information provided during this study offers designers of helicopter transparencies data which will be useful when bird defeat and spall resistance are factors which must be considered. However, since the bird strike data obtained on this program are based on very limited testing, it is recommended that additional tests be made to define more exactly the threshold velocity of each of the monolithic polycarbonate and the Chemcor-plastic windshield designs.

2. It appears that the bird resistance of both the monolithic polycarbonate and the Chemcor-plastic windshield can be improved by a redesign of the edge attachments. The results of the testing to date have emphasized the importance of edge restraint materials and design in withstanding such loads. Additional bird strike tests should be employed during any redesign effort.

3. Additional bird strike tests should be conducted on the redesigned windshields to document the effect of the following parameters on performance:

- a. Temperature
- b. Outdoor weathering (accelerated exposure)
- c. Bird weight
- d. Effect of strike proximity to edgeband.

4. Test articles of the redesigned windshields should be installed on aircraft for flight testing. This will allow evaluation of the performance and maintainability of the articles in the service environment.

DISTRIBUTION LIST

No. of Copies	To	No. of Copies	To
10	Commander, US Army Aviation Systems Command, P.O. Box 209, St. Louis, Missouri 63166		Commander, US Army Troop Support Command, 4300 Goodfellow Blvd., St. Louis, Missouri 63120
1	ATTN: DRSAV-EXT	1	ATTN: DRSTS-PLC
1	DRSAV-FE (Cliff Sims, Maint Engr)		Commander, US Army Armament Command, Rock Island, Illinois 61201
1	DRSAV-EQ (C. Crawford, Sys Dev & Qual)	1	ATTN: DRSAV-PPR-1W
1	DRSAV-FES (H. Bull, Corpus Christi)	2	Technical Library
2	DRSAV-ZDR (Ref Library)		Commander, US Army Tank-Automotive Research and Development Command, Warren, Michigan 48090
	Project Manager, Advanced Attack Helicopter, P.O. Box 209, St. Louis, Missouri 63166	1	ATTN: DRDTA-RCM.1
1	ATTN: DRCPM-AAH, TM	2	DRDTA, Research Library Branch
	Project Manager, Utility Tactical Transport Aircraft System, P.O. Box 209, St. Louis, Missouri 63166	12	Commander, Defense Documentation Center, Cameron Station, Building 5, 5010 Duke Street, Alexandria, Virginia 22314
1	ATTN: DRCPM-UA-T		Hughes Helicopter, Division of Summa Corporation, M/S Y-419, Centinella Avenue and Teale Street, Culver City, California 90230
	Project Manager, CH-47 Modernization, P.O. Box 209, St. Louis, Missouri 63166	2	ATTN: Mr. R. E. Moore, Bldg. 314
1	ATTN: DRCPM-CH47M		Sikorsky Aircraft Division, United Aircraft Corporation, Stratford, Connecticut 06497
	Project Manager, Advanced Scout Helicopter, P.O. Box 209, St. Louis, Missouri 63166	2	ATTN: Mr. Stan Silverstein, Section Supv., Manufacturing Technology
1	ATTN: DRSAV-SIA		Bell Helicopter Company, P.O. Box 482, Ft. Worth, Texas 76101
	Project Manager, Aircraft Survivability Equipment, P.O. Box 209, St. Louis, Missouri 63166	2	ATTN: Mr. P. Baumgartner, Chief, Manufacturing Technology
1	ATTN: DRCPM-ASE-TM		Kaman Aerospace Corporation, Bloomfield, Connecticut 06002
	Project Manager, Cobra, P.O. Box 209, St. Louis, Missouri 63166	2	ATTN: Mr. A. S. Falcone, Chief of Materials Engineering
1	ATTN: DRCPM-CO-T		Boeing Vertol Company, Box 16858, Philadelphia, Pennsylvania 19142
	Project Manager, Iranian Aircraft Program, P.O. Box 209, St. Louis, Missouri 63166	2	ATTN: R. Pinckney, Manufacturing Technology
1	ATTN: DRCPM-IAP-T		Detroit Diesel Allison Division, General Motors Corporation, P.O. Box 894, Indianapolis, Indiana 46206
4	Commander, US Army Materiel Development and Readiness Command, 5001 Eisenhower Avenue, Alexandria, Virginia 22333	2	ATTN: James E. Knott, General Manager
1	ATTN: DRCRD-TE		General Electric Company, 10449 St. Charles Rock Road, St. Ann, Missouri 63074
1	DRCDE-TC	2	ATTN: Mr. H. Franzen
	Director, Eustis Directorate, US Army Air Mobility R&D Lab, Ft. Eustis, Virginia 23604		AVCO-Lycoming Corporation, 550 South Main Street, Stratford, Connecticut 06497
1	ATTN: SAVDL-EU-TAS	2	ATTN: Mr. V. Strautman, Manager, Process Technology Laboratory
1	Mr. J. Robinson, SAVDL-EU-SS		United Technologies Corporation, Pratt & Whitney Aircraft Division, Manufacturing Research and Development, East Hartford, Connecticut 06108
	Director, Ames Directorate, US Army Air Mobility R&D Lab, Ames Research Center, Moffett Field, California 94035	2	ATTN: Mr. Ray Traynor
1	ATTN: SAVDL-AM		Office of the Director, Defense Research and Engineering, The Pentagon, Washington, D. C. 20301
	Director, Langley Directorate, US Army Air Mobility R&D Lab, Mail Stop 266, Hampton, Virginia 23365	1	Metals and Ceramics Information Center, Battelle Columbus Laboratories, 505 King Avenue, Columbus, Ohio 43201
1	ATTN: SAVDL-LA		Chief of Research and Development, Department of the Army, Washington, D. C. 20310
	Director, Lewis Directorate, US Army Air Mobility R&D Lab, 21000 Brook Park Rd, Cleveland, Ohio 44135	2	ATTN: Physical and Engineering Sciences Division
1	ATTN: SAVDL-LE		Commander, Army Research Office, P. O. Box 12211, Research Triangle Park, North Carolina 27709
	Director, Production Equipment Agency, Rock Island Arsenal, Rock Island, Illinois 61201	1	ATTN: Information Processing Office
1	ATTN: AMXPE-MT		Commander, U. S. Army Natick Research and Development Command, Natick, Massachusetts 01760
	Air Force Materials Laboratory, Manufacturing Technology Division, Wright-Patterson Air Force Base, Ohio 45433	1	ATTN: Technical Library
1	ATTN: AFML/LTM		Commander, U. S. Army Satellite Communications Agency, Fort Monmouth, New Jersey 07703
1	AFML/LTN	1	ATTN: Technical Document Center
1	AFML/LTE		Commander, White Sands Missile Range, New Mexico 88002
1	AFML/MXE/E. Morrissey	1	ATTN: STEWS-WS-VT
1	AFML/LC		
1	AFML/LLP/D. M. Forney, Jr.		
1	AFML/MBC/Mr. Stanley Schuman		
	Commander, US Army Electronics Command, Ft. Monmouth, New Jersey 07703		
1	ATTN: DRSEL-RD-P		
1	DRSEL-GG-DD		
	Commander, US Army Missile Command, Redstone Arsenal, Alabama 35809		
1	ATTN: DRSMI-IEE		
1	Technical Library		
1	DRSMI-RSM, Mr. E. J. Wheelahan		

Reproduced From
 Best Available Copy

No. of Copies	To	No. of Copies	To
1	Commander, Aberdeen Proving Ground, Maryland 21005 ATTN: STEAF-TL, Bldg. 305	1	Commander, U. S. Army Environmental Hygiene Agency, Edgewood Arsenal, Maryland 21010 ATTN: Chief, Library Branch
1	President, Airborne, Electronics and Special Warfare Board, Fort Bragg, North Carolina 28307 ATTN: Library	1	Technical Director, Human Engineering Laboratories, Aberdeen Proving Ground, Maryland 21005 ATTN: Technical Reports Office
1	Commander, Dugway Proving Ground, Dugway, Utah 84022 ATTN: Technical Library, Technical Information Division	1	Commandant, U. S. Army Quartermaster School, Fort Lee, Virginia 23801 ATTN: Quartermaster School Library
1	Commander, Frankford Arsenal, Philadelphia, Pennsylvania 19137 ATTN: Library, H1300, B1. 51-2 SARFA-L300, Mr. J. Corrie	1	Commander, U. S. Army Radio Propagation Agency, Fort Bragg, North Carolina 28307 ATTN: SCCR-2
1	Commander, Harry Diamond Laboratories, 2800 Powder Mill Road, Adelphi, Maryland 20783 ATTN: Technical Information Office	1	Naval Research Laboratory, Washington, D. C. 20375 ATTN: Dr. J. M. Krafft - Code 8430
1	Commander, Picatinny Arsenal, Dover, New Jersey 07801 ATTN: SARPA-RT-S	1	Chief of Naval Research, Arlington, Virginia 22217 ATTN: Code 471
4	Commander, Redstone Scientific Information Center, U. S. Army Missile Command, Redstone Arsenal, Alabama 35809 ATTN: ORSMI-RBLD, Document Section	1	National Aeronautics and Space Administration, Washington, D. C. 20546 ATTN: Mr. B. G. Achhammer Mr. G. C. Deutsch - Code RR-1
1	Commander, Watervliet Arsenal, Watervliet, New York 12189 ATTN: SARWV-RDT, Technical Information Services Office	1	National Aeronautics and Space Administration, Marshall Space Flight Center, Huntsville, Alabama 35812 ATTN: R-P&VE-M, R. J. Schwinghamer S&E-ME-MM, Mr. W. A. Wilson, Building 4720
1	Commander, U. S. Army Foreign Science and Technology Center, 220 7th Street, N. E., Charlottesville, Virginia 22901 ATTN: ORXST-SD2	1	Ship Research Committee, Maritime Transportation Research Board, National Research Council, 2101 Constitution Ave., N. W., Washington, D. C. 20418
1	Commander, U. S. Army Aeromedical Research Unit, P. O. Box 577, Fort Rucker, Alabama 36460 ATTN: Technical Library	1	Materials Sciences Corporation, Blue Bell Campus, Merion Towle Building, Blue Bell, Pennsylvania 19422
1	Librarian, U. S. Army Aviation School Library, Fort Rucker, Alabama 36360 ATTN: Building 5907	1	The Charles Stark Draper Laboratory, 68 Albany Street, Cambridge, Massachusetts 02139
1	Commander, U. S. Army Board for Aviation Accident Research, Fort Rucker, Alabama 36360 ATTN: Library, Building 5505	1	Wyman-Gordon Company, Worcester, Massachusetts 01601 ATTN: Technical Library
1	Commander, USACDC Air Defense Agency, Fort Bliss, Texas 79916 ATTN: Technical Library	2	Director, Army Materials and Mechanics Research Center, Watertown, Massachusetts 02172 ATTN: DRXMR-PL DRXMR-AG Authors
1	Commander, U. S. Army Engineer School, Fort Belvoir, Virginia 22060 ATTN: Library		
1	Commander, U. S. Army Engineer Waterways Experiment Station, Vicksburg, Mississippi 39180 ATTN: Research Center Library		