

UNCLASSIFIED

Defense Technical Information Center  
Compilation Part Notice

ADP011157

TITLE: A Gas Turbine Compressor Simulation Model for Inclusion of Active Control Strategies

DISTRIBUTION: Approved for public release, distribution unlimited

This paper is part of the following report:

TITLE: Active Control Technology for Enhanced Performance Operational Capabilities of Military Aircraft, Land Vehicles and Sea Vehicles  
[Technologies des systemes a commandes actives pour l'amelioration des performances operationnelles des aeronefs militaires, des vehicules terrestres et des vehicules maritimes]

To order the complete compilation report, use: ADA395700

The component part is provided here to allow users access to individually authored sections of proceedings, annals, symposia, etc. However, the component should be considered within the context of the overall compilation report and not as a stand-alone technical report.

The following component part numbers comprise the compilation report:

ADP011101 thru ADP011178

UNCLASSIFIED

## A Gas Turbine Compressor Simulation Model for Inclusion of Active Control Strategies

**Carlo Cravero, Aristide Massardo**  
 DIMSET - Università di Genova  
 via Montallegro n.1 - 16145 Genova  
 ITALIA

### ABSTRACT

A one dimensional time-marching model to solve the dynamic behavior of a compression system is presented. The computational method is described in some details and it is applied to a three-stage axial compressor with different plenum configurations. This computational model for the simulation of a multistage axial compressor is used to investigate the insertion of an active control system.

### NOMENCLATURE

$\Lambda, a$	duct section, sound speed
$e$	internal energy
$F$	mass, momentum and energy flux vector
$F_{\text{blades}}, F_{\text{friction}}$	blade force, external force due to friction
$h, h_{\text{bleed}}$	enthalpy, enthalpy of $m_{\text{bleed}}$
$k$	specific heat ratio $c_p/c_v$
$L, L_c$	duct length, compressor length
$NX$	number of computational sections
$m_{\text{bleed}}$	mass flow bleed
$p$	static pressure
$Q$	conservative flow variables vector
$R$	gas constant
$t, T$	time, static temperature
$u, U$	velocity, peripheral speed
$x, y$	Cartesian co-ordinates
$V_p$	plenum volume
$W$	work exchange
Greek	
$\Delta_+, \Delta_-$	forward and backward finite differences
$\Phi, \Phi_{\text{ext}}$	flow coefficient, external heat flux
$\Psi$	pressure coefficient
$\mu$	valve coefficient
$\rho$	density
Subscript	
$t$	total quantity
1,2	inlet, outlet sections

### INTRODUCTION

The need for a wider operability range of modern compressors for gas turbine applications is the "prime mover" for a large research effort that is nowadays undertaken in many international laboratories, organisations, companies and universities. This effort is both experimental and computational. The overall behaviour of a gas turbine compressor outside its stability range has been understood and can be modelled using a simplified lumped parameters approach (Greitzer, 1976, Baghdadi et al., 1982). Many detailed experimental analysis are nowadays focused on stall inception (Day et al, 1999, Camp-Day 1998, Spakovsky et al., 1999) to understand the fluid-dynamic mechanism of formation and to be able to improve its computational modelling. On the other hand the computational models for the analysis of a multistage compressor in steady flow (through-flow or 3D Navier-Stokes) are not directly applicable to unsteady (transient or dynamic) flows because they are either inappropriate (standard through-flow) or they require an excessive computational effort (3D Navier-Stokes). The most simplified approach is the zero dimensional lumped parameter technique that considers each component of the compression system as a node and by writing the balance for mass flow, momentum and energy it results in a set of differential equations to be solved with respect to time (Greitzer, 1976, Massardo et al. 1989, Botros, 1994).

The one dimensional model for the analysis of the unsteady flow in a compression system can be a good compromise between the accuracy in capturing the main system performances and the computational effort. This approach introduces the conservation equations (continuity, momentum and energy) for a continuum and, after a domain discretization, are integrated using a time-marching technique; the effect of blades, mass bleeds, friction etc.... are introduced as external body forces. This technique has been considered and a time-marching technique, previously developed for 2D/3D turbomachinery flows (Cravero, 1995), has been converted in 1D form with the insertion of the appropriate external forces to model the dynamic of the compression system. The 1D time-marching approach is preferred over the lumped parameter technique, because it allows the analysis

inside the compressor (interstage analysis) and this is an important feature when an active control strategy must be defined. In fact the control devices and the transducers should be placed in the most efficient way (Escuret-Elder, 1993, Gysling-Greitzer, 1994, Montazeri et al., 1996, Sun-Elder, 1998) and this can be done if a reliable technique for the compression system analysis is implemented. Active control of compressor instabilities (surge) has received attention recently (Epstein et al., 1989); it aims to allow the compressor to operate beyond the surge line suppressing the flow instabilities by means of a feedback control system. The design of active control systems for multistage axial compressors is still a challenging topic; it requires a good representation of the compression system under unsteady flows in order to detect the instability and to help the optimisation of the control system (transducer and actuator positioning).

### COMPUTATIONAL MODEL

The geometrical domain is divided into a number of sections where the thermal-fluid-dynamic variables (pressure, velocity, Mach number, temperature etc....) are computed according to the 1D flow hypothesis. In Fig. 1 a sketch of a reference domain divided into 1D sections is presented.

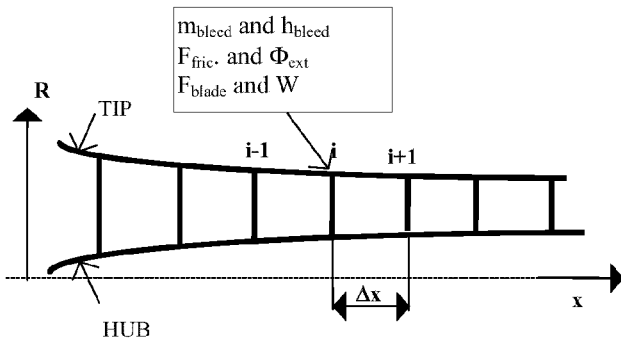

Fig.1: Computational model

### Governing equations

The system of mass, momentum and energy 1D equations, for each control volume (sections i-1, i, i+1 in Fig.1), are written in the following conservative form:

$$\frac{\partial Q}{\partial t} + \frac{\partial F}{\partial x} = B \quad (1)$$

with

$$e_i = c_v T + 0.5u^2 \quad B = \left( m_{bleed} p \frac{\partial A}{\partial x} + F_{blade} + F_{friction} W + \Phi_{ext} + h_{bleed} \right)^T$$

$$B = \left( m_{bleed} p \frac{\partial A}{\partial x} + F_{blade} + F_{friction} W + \Phi_{ext} + h_{bleed} \right)^T \quad (2)$$

the total energy  $e_i$  is defined as  $e_i = c_v T + 0.5u^2$ . Using the perfect gas equation of state:

$$e_i = \frac{R}{k-1} T + 0.5u^2 \quad p = (k-1) [\rho e_i - 0.5\rho u^2] \quad (3)$$

### Time-marching technique

In order to integrate the nonlinear hyperbolic differential system of eq.1, a time marching technique, previously developed for 2D and 3D steady/unsteady-inviscid/viscous turbomachinery flows (Cravero 1995, Cravero-Satta 1995, Cravero-Satta 2000), has been set up for the 1D case. After the integration in space the system of eq.1 can be written as:

$$\frac{dQ_i}{dt} + (C_i + D_i - B_i) = 0 \quad (4)$$

where the suffix  $i$  refers to the actual grid node. The term in parenthesis is defined as the residual  $R_i$  and will be driven to zero in steady flow calculations. The convective fluxes are integrated with central differences:

$$C_i = \frac{F_{i+1} - F_{i-1}}{2\Delta x_i} \quad (5)$$

In order to prevent odd-even points decoupling and, in general, to solve transonic flows with shock waves, an artificial dissipative term is added: this is a blend of second and fourth order dissipative terms:

$$D_i = \frac{1}{\Delta t_i} \left[ \delta_i \Delta_+ \Delta_- - \epsilon_i (\Delta_+ \Delta_-)^2 \right] Q_i \quad (6)$$

where

$$\delta_i = \theta_2 \max(v_{i+1}, v_i, v_{i-1}) \quad (7)$$

$$\epsilon_i = \max(0, \theta_4 - \delta_i) \quad (8)$$

$$v_i = \frac{|p_{i-1} - 2p_i + p_{i+1}|}{|p_{i-1} + 2p_i + p_{i+1}|} \quad (9)$$

The coefficient  $\theta_2$  (eq.7) and  $\theta_4$  (eq.8) are fixed and their typical values are 1/4 and 1/32. The integration in time of eq.4 is performed with the following explicit multistep Runge-Kutta scheme with  $N$  steps:

$$Q_i^0 = Q_i(t)$$

$$Q_i^1 = Q_i^0 - \alpha_1 \Delta t_i R(Q_i^0)$$

$$Q_i^m = Q_i^0 - \alpha_m \Delta t_i R(Q_i^{m-1})$$

$$Q_i(t + \Delta t) = Q_i^N \quad (10)$$

The dissipation term in the residual  $R$  is computed only at the first step. A four step scheme with standard coefficients (1/4, 1/3, 1/2, 1) has been used. For steady flow analysis the local time step is computed according to:

$$\Delta t_i = CFL \frac{\Delta x_i}{(u+a)_i} \quad (11)$$

where the Courant-Friedricks-Levy has its limit of 2.8 with a four steps scheme. When unsteady flows are computed the minimum time step over the domain is considered.

### Source term evaluation

The source term  $B$  in eq.1 contains the effects of a mass flow bleed ( $m_{bleed}$  and  $h_{bleed}$ ) or injection, of heat addition/removal ( $\Phi_{ext}$ ), of

channel section variation ( $p \frac{\partial A}{\partial x}$ ), of friction at the walls due to viscous effects ( $F_{friction}$ ) and of a turbomachinery stage ( $F_{blade}$  and  $W$ ). Introducing this last contribution allows the unsteady flow in a multistage turbomachinery (compressor or turbine) to be computed with many information of the flow inside the machine compared to a lumped parameter approach. In the following the attention will be focused on the stage force and work exchange evaluation. Each computational station is identified with a label that defines its kind (i.e. 0-duct, 1-stator, 2-rotor). At present a computational model for axial compressor stages is implemented. When a compressor stage is detected, the axial blade force and the work exchange are computed either by the stage characteristics (read from an external data file) or by a routine implemented into the code that returns the stage performances in the actual working point. The blade force is equally distributed for each station defining a blade (rotor+stator) in the stage while the work exchange is "spread over" the stations in the rotor. If the internal routine is called to compute the compressor stage characteristics, the pre-stall part of the stage characteristics is computed with a standard 1D approach with correlations while the post-stall and reverse flow parts are evaluated using the model proposed by Moses et al. (1986) and by O'Brian (1992). A time-lag equation for the blade force is introduced to compute the actual blade force in unsteady calculations, following:

$$\tau \frac{dF_{blade}}{dt} + F_{blade} = F_{blade\_steady} \quad (12)$$

**Inlet and Outlet boundary conditions**

At the inlet section, in the most frequent case of subsonic flow, total pressure and temperature are fixed as boundary conditions. The conservative variables (vector Q of eq.1) are updated extrapolating the Riemann invariant (Cravero, 1995) from the interior points. At the outlet section static pressure is fixed as boundary condition; when a steady state solution is required the conservative variables are obtained from the interior points by extrapolating the Riemann invariant together with the assumption of isentropic flow in the last two sections. When a time dependent boundary condition is required, a model of an isentropic expansion through a variable section control valve is modeled. The "reduced mass flow" trough the valve is used to compute the Mach number, and therefore all the required quantities:

$$\bar{m}_{valve} = \frac{p_t A_{NX}}{\sqrt{T_t}} \mu = (\rho u A)_{NX} \quad (13)$$

The total quantities  $T_t$  and  $p_t$  are extrapolated from the station NX-1. The valve characteristic coefficient  $\mu$  is computed with a steady flow run and it is, in general, function of time during the unsteady flow calculation.

**APPLICATIONS**

To test the model previously described, the available geometrical and experimental data of the compressor of Gamache (1985) have been utilized. The three-stage, low-speed compressor consists of three non-repeating stages with a constant cross-sectional annulus area (hub to tip ratio 0.88). From the cited work and from the work of Eastland (1982), a complete set of steady stage pressure characteristics and corresponding overall steady system performances are available.

For each stage, the energy input to the overall system is given in terms of torque coefficient. Here the stage temperature rise characteristics are obtained based upon the overall torque data and two isolated flow points in rotating stall (all the stage temperature characteristics were considered to be identical).

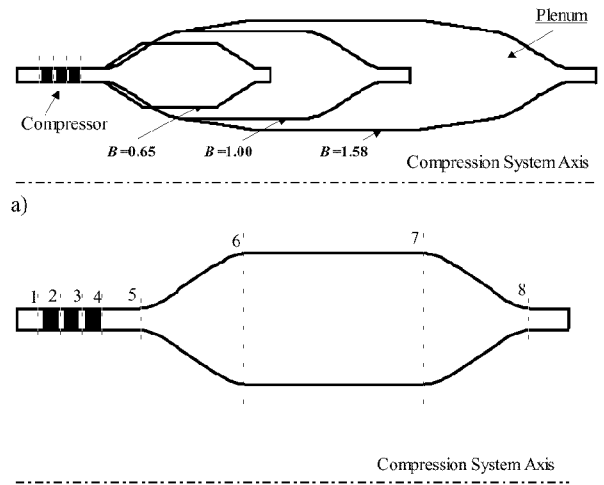

Fig.2: Compression system geometry - a) Different plenum geometry; b) section numbering

As already observed by O'Brien (1992), the referenced three-stage compression system provides excellent stage characteristic data, but, unfortunately, overall system behavior during surge and rotating stall was not available. However, the rig was similar to one used in a previous experimental investigation of surge and rotating stall by Greitzer (1976). Taking into account this aspect, the compression system here analyzed has been configured to the geometry specified for the plenum rig of Greitzer's tests, but using the computed stage characteristics for the Gamache's compressor. The theoretical stage performance curves have been used for the following calculations.

For the analysis of compression systems Greitzer's B parameter was used as a reference variable for the experimental compressor. The parameter B is defined as:

$$B = \frac{U}{2a} \cdot \sqrt{\frac{V_p}{I_C \cdot A_{in}}} \quad (14)$$

The B value can be modified by changing the plenum volume  $V_p$ , as shown in Fig.2; three cases were computed: rotating stall ( $B=0.65$ ); classical surge ( $B=1.00$ ); deep surge ( $B=1.58$ ).

In Fig.3 the dynamic responses of the compression system with  $B=0.65-1.0-1.58$  are shown. The compressor rig throttle was slowly closed to the point of instability and then held constant. In case of  $B=0.65$  the system became unstable at the uniform flow stall point, and then traversed to rotating stall. A second calculation has been done with the compressor rig reconfigured to operate at  $B=1.00$  (see Fig.2a). In this condition the system exhibited surge cycles. In Fig.3 the time-dependent distributions of static pressure in different stations along the machine clearly show the different wave amplitude and the need for a distributed model to simulate the system. Another test has been considered with the compressor rig reconfigured to operate at

$B=1.58$  (see Fig.2a). In this configuration the system exhibited deep surge cycles.

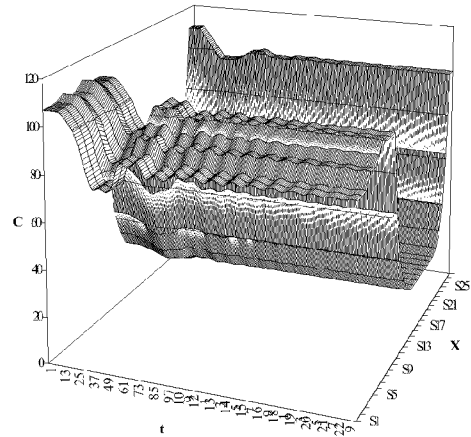
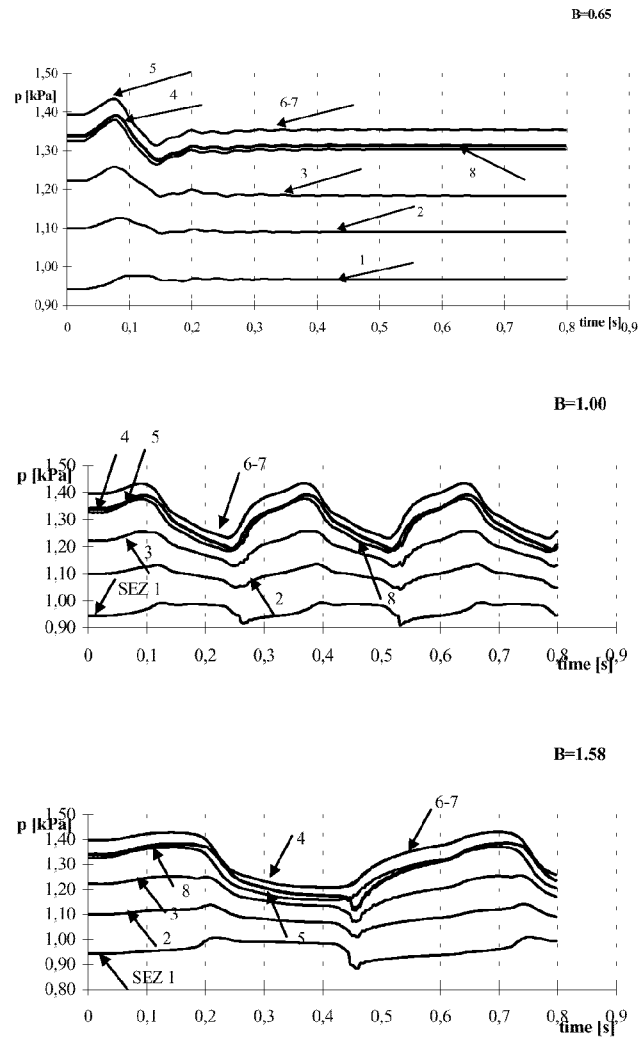

a)

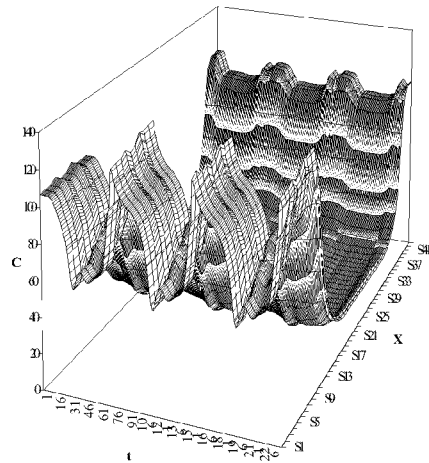

b)

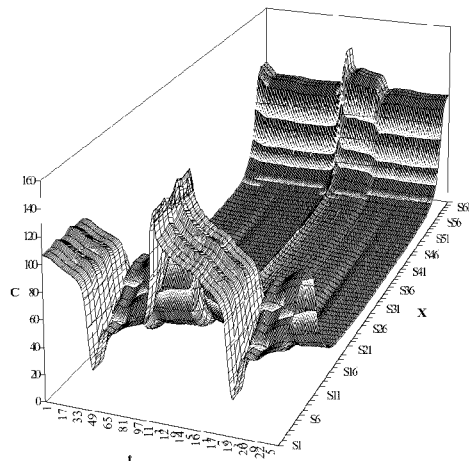

c)

Fig.3: Pressure and velocity variations in different sections in case of  $B=0.65 - B=1.0 - B=1.58$

The large amplitude variations of static pressure inside the compressor can be detected by the 1D code as shown in Fig.3. It is clear from the examples that the present 1D model, compared to a lumped model approach, can give detailed information about the flow behavior inside the compressor (i.e. interstage fluid dynamic data) and inside the plenum. This is an important feature of the model that allows the influence of different active control strategies (interstage bleed, cooling mass flow rate, valves ...) to be analyzed and discussed. In Fig.4 the time dependent velocity distributions within the system, obtained with different configurations ( $B=0.65-1.0-1.58$ ), are shown in a 3D plot to highlight the strong variations inside the compression system. This kind of inspections can be used to understand the optimum placing of transducers and active control devices.

Fig.4: 3D views of velocity distributions with respect to time and space- a)  $B=0.65$  - b)  $B=1.0$  - c)  $B=1.58$



**ACTIVE CONTROL STRATEGY**

Compression systems have their operating range limited at high flow rate by choking and at low flow rates by occurrence of aerodynamic instabilities, namely rotating stall and/or surge. If we concentrate our attention on a cascade: as flow rate decreases, the incidence angle grows up until flow separates so that the cascade pressure rise and efficiency fall out. Depending on the compressor and plant characteristics there will be stall or surge. The former is a non-axisymmetric perturbations with one or more cells with lower meridional velocity and “clean” flow zones, but stationary circumferentially averaged flow rate; virtually it might be not dangerous. On the contrary, the latter involves strong perturbations in flow rate, sometimes exhibiting reverse flow periods, and it can seriously damage both compressor and plant. Compressor map and expander line (if it is a throttle valve) or map (if it is a turbine), but also volumes (tubes, burner and plenum) between them play a role to lead to stall or surge. Greitzer (1976) pointed out that it is not only a “local” matter, so that surge instability can arise even if the slopes of the characteristics seem “good”. Despite of this, most researchers utilize linear models (Ffowcs Williams and Huang, 1989; Gysling et al., 1991; Pinsley et al., 1991; Simon et al., 1993; Jungowsky et al., 1994). However, to avoid surge, traditional devices keep the compression systems away to work close to low incidence angles, i.e., low flow rates. By the way, such zones would exhibit very good pressure rise and efficiency.

In the last decade new techniques have been searched, which are more effective than purely inhibiting dangerous zones. Formerly Greitzer found that instability was related to a rate of energy, so that many researchers thought that, if this energy could be dissipated, instability had to disappear.

Two families of techniques were suggested: passive and active control. The former is based on the aeroelastic coupling of the compression system with a mass-spring-damper device (Gysling et al., 1991) or a hydraulic oscillator (Arnulfi et al., 2000), able to catch and dissipate the instability energy. Unfortunately, this approach involves serious practical problems and actually no industrial plant has been equipped with such a device. The latter family is based on a classic feedback control system, i.e., a sensor/actuator pair and a suitable control law. Ffowcs Williams and Huang (1989) stabilized the unstable flow in a small compression system by using a pressure sensor located in the plenum and a movable wall as an actuator (a sort of loudspeaker diaphragm). One hardly can think of an industrial size compression unit with a device like this. Pinsley et al. (1991) suggested a more promising control system, where the plenum pressure signal modulates the compressor exit area by a throttle valve, located downstream of the plenum. Although they experimentally validated their idea with a small centrifugal compressor for automotive turbo-charging, it seems to be suitable to large industrial units too. Many other researchers concentrate their study on active stabilization of surge in small units (for example, Jungowsky et al., 1994, Komatsubara and Mizuki, 1995).

As far as axial compressors, and particularly aero-engine units, there is a lack of experimental work. Cargill and Freeman (1991) describe an active control scheme. The control effectiveness needs two requirements: very fast response to frequency and a large number of sensors and actuators. The former conflicts with the use of analogic or digital filters: they have to be utilized in order to remove both noise and DC component of the experimental signals, but cause some phase shift. The latter makes the plant complex and hardly manageable. However Montazeri et al. (1996) wrote a theoretical paper on an

active control device using one actuator only. It deals with an air bleeding strategy and the location of the bleeder was optimized.

Several control strategies can be considered for the active stabilization of a compressor system under transient operations that can cause the compressor instability. With the computational model described above the effect of different interventions (distributed mass flow bleed, variable geometry devices, control valves etc...) made to stabilize the compressor system can be evaluated and the most efficient active control strategy can be outlined.

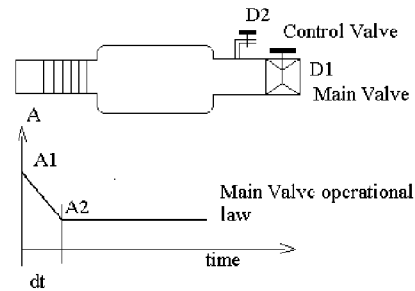

Fig.5: Compression system with control valve and main valve with its operational law

In this paper a preliminary application of a simple active control strategy has been considered in order to verify the stability properties of the iterative solution method and to estimate the potential application of the code to more complex control devices. The compression system operation point is set by the main valve (device D1 of Fig.5) whose operational law is defined by the initial (A1) and final (A2) values of the channel section (related to the coefficient  $\mu$  of eq.13) and by the time step  $dt$  of the operation.

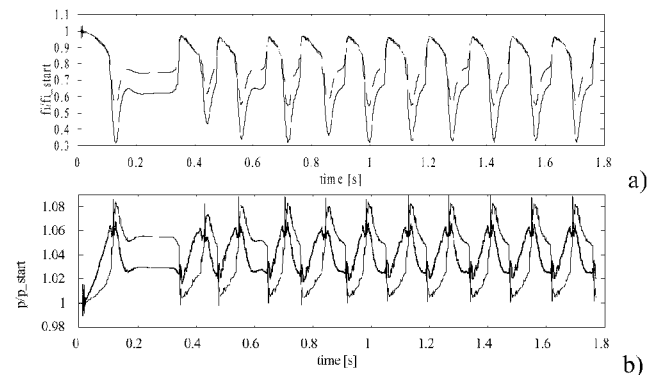

Fig.6: Compression system instability. a) flow coefficient, b) static pressure

A control valve (device D2 in Fig.5) is introduced in the exit duct in order to stabilize, with a defined control law, the system. The following simple control law for the valve B has been introduced:

$$\Delta A = Kdp/dt \tag{14}$$

where  $\Delta A$  is the section variation and the pressure gradient is taken at the compressor exit.

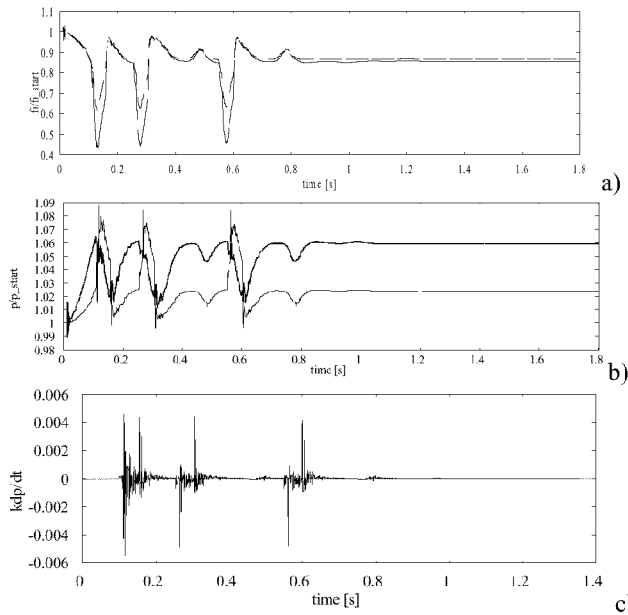

Fig.7: Compressor system stabilization. a) flow coefficient, b) static pressure, c) control valve operation

If, starting from the nominal operating condition, a reduction of about 25% in the exit duct section is operated in 0.1 s by the main valve D1, the compression system goes into a surge behavior. This is shown in Fig.6 where the flow coefficient and the static pressure (referred to the starting values) transient behavior are plotted for the inlet (solid line) and outlet (dashed line) compressor stations. With the same transient operation set by the main valve D1 the compression system is stabilized by acting on the control valve D2 with the law set by eq.14. In Fig.7a-7b the flow coefficient and the static pressure are plotted against the time for the inlet (solid line) and outlet (dashed line) compressor stations. The initial instability is damped after a short time by the active intervention of the control valve D2. The control valve is activated after the transient operation as shown in Fig.7c where the unsteady section variation is plotted. As predicted by the model very small variations are required, but with very high gradients.

This is a preliminary simulation for an active control strategy using the distributed computational model and the calculation has been performed mainly to verify the stability of the explicit scheme when introducing variable sections. Actually no attention has been devoted to the practical aspects for the implementation of the above control strategy in a real system. In future work the effect of different control strategies on the active stabilization of the compression system will be assessed with respect to their practical implementation.

## CONCLUSIONS

A time-marching one dimensional simulation model has been set up for the unsteady aerodynamic analysis of a gas turbine compressor. The model considers the system with its real geometrical configuration and it is therefore suitable to the computational analysis of the effect of different active control devices on the compressor performances. After the verification of the ability of the code to give reliable solutions for a multistage axial compressor, even with an unstable operating mode, a preliminary active control strategy has been implemented in order to check for the stability of the numerical

scheme. The code has demonstrated good stability properties and it will be therefore used in future works to understand the effectiveness of different active control strategies. The fluid-dynamic solver has been written as a general solution tool for one dimensional problems in order to be able to extend the analysis to a complete gas turbine engine with minor modifications to the code. This approach will be used to simulate the effect of different fluid-dynamic instabilities (compressor surge, burner humming etc...) on the whole system with allowance of active control strategies.

## ACKNOWLEDGMENTS

The present work is part of a research activity funded by the Italian National Research Council (CNR) - grant 99.02048.

The authors wish to thank Ing. G.L.Arnulfi, from the University of Udine, for his help and for the interesting discussions concerning the active control strategy.

## REFERENCES

- Arnulfi, G.L., Giannattasio, P., Micheli, D., Pinamonti, 2000, "An Innovative Device for Passive Control of Surge in Industrial Compression Systems", ASME paper 2000-GT-0352.
- Baghdadi S., Lueke J.E., 1982, "Compressor stability analysis", ASME J. of Fluids Eng., vol.104, pp.242-249;
- Botros K.K.; 1994, "Transient phenomena in compressor stations during surge", ASME J. for Gas Turbine and Power, vol. 116;
- Camp, T.R., Day, I.J., 1998, "A study of spike and modal stall phenomena in a low-speed axial compressor", ASME, Journal of Turbomachinery, vol.120 n.3, pp. 393-401;
- Cargill A.M., Freeman, C., 1991, "High Speed Compressor Surge With Application to Active Control", ASME Journal of Turbomachinery, Vol. 113, pp. 303-311.
- Cravero C, 1995, "Three-dimensional compressible flow calculation in a turbomachinery stage by means of a finite volume solver" (in italian), Ph.D Thesis, Università di Genova, Genova, Italy;
- Cravero C., Satta A., 1995, "Three-dimensional numerical solutions of turbomachinery annular cascade flow", ASME Cogen Turbo Power, Vienna, Austria, August;
- Cravero C., Satta A., 2000, "A CFD model for real gas flows", ASME paper 2000-GT-0518, Turbo Expo, Munich (Germany), 8-11 May;
- Day I.J., Breuer T., Escuret J., Cherrett M., Wilson A., 1999, "Stall inception and the prospects for active control in four high-speed compressors", ASME J. for Turbomachinery, vol.121, pp.18-27;
- Eastland, A. H. J., 1982, "Investigation of Compressor Performance in Rotating Stall: I - Facility Design and Construction and Initial Steady State Measurements", Massachusetts Institute of Technology, *Gas Turbine and Plasma Dynamics Laboratory Report N° 164*;
- Escuret J.F., Elder R.L., 1993, "Active control of surge in multi-stage axial-flow compressors", ASME Paper 93-GT-39, Cincinnati (OH);
- Epstein A.H., Ffowcs Williams J.E., Greitzer E.M., 1989, "Active suppression of compressor instabilities", AIAA J. Of Propulsion and Power, vol.5, pp.204-211;
- Feulner M.R., Hendricks G.J., Paduano J.D., 1994, "Modeling for control of rotating stall in high-speed multi-stage axial compressors", ASME Paper 94-GT-200, The Hague (NL);
- Ffowcs Williams, J.E., Huang, X.Y., 1989, "Active Stabilization of Compressor Surge", Journal of Fluid Mechanics, Vol. 204, pp. 245-262.

Gamache, R. M., 1985, "Axial Compressor Reversed Flow Performance", *Ph. D. Dissertation*, Massachusetts Institute of Technology

Garrard D., Davis M., Wehofer S., Cole G., 1997, "A one dimensional, time dependent inlet/engine numerical simulation for aircraft propulsion systems", ASME Paper 97-GT-333, Orlando (FL);

Giannattasio, P., 1999, "Analisi di stabilità di un sistema di compressione industriale con controllo attivo del pompaggio", LIV Congresso Nazionale Associazione Termotecnica Italiana, L'Aquila, Italy, p. 1437.

Gysling, D.L., Dugundji, J., Greitzer, E.M., Epstein, A.H., 1991, "Dynamic Control of Centrifugal Compressor Surge Using Tailored Structures", ASME Journal of Turbomachinery, Vol. 113, pp. 710-722.

Gysling D.L., Greitzer E.M., 1994, "Dynamic control of rotating stall in axial flow compressors using aeromechanical feedback", ASME Paper 94-GT-292, The Hague (NL);

Greitzer, E. M., 1976, "Surge and Rotating Stall in Axial Flow Compressors", ASME Transactions, *Journal of Engineering for Power*, vol. 98, N° 2, pp. 190-217.

Ishii H, Kashiwabara Y, 1996, "Study on surge and rotating stall in axial compressors (A numerical model and parametric study for multiblade-row compressors)", JSME Int. Journal, series B, vol.39 n.3;

Jungowsky, W.M., Weiss, M.H., Price, G.R., 1994, "Pressure Oscillations Occurring in a Centrifugal Compressor System With and Without Passive and Active Surge Control" ASME paper 94-GT-133.

Komatsubara, Y., Mizuki, S., 1995, "Active Control of a Centrifugal Compressor", II International Conference on Pumps and Fans, Beijing, China, pp. 387-398.

Massardo, A. F., Cinquetti, P., Satta, A., 1989, "Modelli non Lineari nello Studio del Comportamento Dinamico degli Impianti Motori e dei loro Componenti", *Convegno dinamica e regolazione delle centrali termoelettriche*, Genova;

Montazeri-Gh M., Allerton D.J., Elder R.L., 1996, "Actuator placement for active surge control in a multi-stage axial compressor", ASME Paper 96-GT-241, Birmingham (UK);

Moses H.L., Thomason S.B., 1986, "An approximation for fully stalled cascades", AIAA J. of Propulsion, pp.188-189;

O'Brian W.F., 1992, "Dynamic simulation of compressor and gas turbine performance", AGARD LS183, 27-28 May, Cambridge (MA);

Pinsley, J.E., Guenette, G.R., Epstein, A.H., Greitzer, E.M., 1991, "Active Stabilization of Centrifugal Compressor Surge", ASME Journal of Turbomachinery, Vol. 113, pp. 723-732.

Simon, J.S., Valavani, L., Epstein, A.H., Greitzer, E.M., 1993, "Evaluation of Approaches to Active Compressor Surge Stabilization", ASME Journal of Turbomachinery, Vol. 115, pp. 57-67.

Spakovsky Z.S., Weigl H.J., Paduano J.D., C.M: Van Schalkwyk, Suder K.L., Bright M.M., 1999, "Rotating stall control in a high-speed stage with inlet distortion: Part I - Radial distortion", ASME J. of Turbomachinery, vol.121, pp.510-516;

Spakovsky Z.S., Weigl H.J., Paduano J.D., C.M: Van Schalkwyk, Suder K.L., Bright M.M., 1999, "Rotating stall control in a high-speed stage with inlet distortion: Part II - Circumferential distortion", ASME J. of Turbomachinery, vol.121, pp.517-524;

Sun J., Elder R.L., 1998, "Numerical optimization of a stator vane setting in multistage axial-flow compressors", IMechE J. of Power and Energy, vol.212 part A;



**This page has been deliberately left blank**



**Page intentionnellement blanche**