

NASA AERONAUTICS BOOK SERIES

Sweeping Forward

Developing & Flight Testing
the Grumman X-29A
Forward Swept Wing
Research Aircraft



Frederick A. Johnsen

NASA AERONAUTICS BOOK SERIES

Sweeping Forward

Developing & Flight Testing
the Grumman X-29A
Forward Swept Wing
Research Aircraft

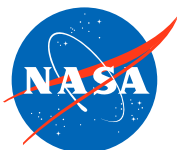

Frederick A. Johnsen

Library of Congress Cataloging-in-Publication Data

Johnsen, Frederick A.

Sweeping forward : developing and flight testing the Grumman X-29A forward swept wing research aircraft / Frederick A. Johnsen.

pages cm

Includes bibliographical references.

1. Grumman X-29A (Jet plane)--Design and construction. I. Title.

TL686.G78J65 2013

629.133'349--dc23

2013008254

Copyright © 2013 by the National Aeronautics and Space Administration. The opinions expressed in this volume are those of the authors and do not necessarily reflect the official positions of the United States Government or of the National Aeronautics and Space Administration.



This publication is available as a free download at
<http://www.nasa.gov/ebooks>.

Table of Contents

<i>Foreword by Rogers E. Smith</i>	v
Chapter 1: The Background of the X-29.....	1
Chapter 2: From Concept to Flightline.....	41
Chapter 3: Initial Flight Testing	77
Chapter 4: Program Expansion.....	105
Chapter 5: The X-29 Follow-On Program	143
Chapter 6: Program Management and Direction	187
Chapter 7: Lessons Learned and Research Dissemination	199
<i>Appendix 1: X-29 Flight Chronology, 1984–1992</i>	227
<i>Appendix 2: X-29 Three-View</i>	270
<i>Appendix 3: Detailed Description of the Grumman X-29</i>	271
<i>Appendix 4: Milestones in Forward Swept Wing Design and X-29 Flight Test</i>	280
<i>Appendix 5: X-29 Acronyms and Abbreviations</i>	283
<i>Acknowledgments</i>	288
<i>Selected Bibliography</i>	290
<i>About the Author</i>	297
<i>Index</i>	299



Rogers E. Smith, X-29 NASA research pilot. (NASA)

Foreword

by Rogers E. Smith

The X-29 was certainly an unusual aircraft with a truly unique silhouette. It combined many features that challenged the technologies of its day and represented special problems for the developers and the team of testers responsible for documenting its features and design goals. In 1982, I joined the National Aeronautics and Space Administration's (NASA) Dryden Flight Research Center, located at the famous United States Air Force Test Center on the shore of Rogers Dry Lake, at Edwards, CA, as a research test pilot. As a result, I was in the right place at the time and became an early member of the special team charged with testing this amazing aircraft.

This assignment to the X-29 test program was in many ways my final step along the path to achieving my personal dream—to be a test pilot. My journey was fueled by my passion to be a pilot and an aeronautical engineer: the foundation, in my view, of being a test pilot. When I arrived at NASA Dryden, I had learned my trade working as a pilot-engineer at the National Research Council of Canada and, most importantly, at Cornell Aeronautical Laboratory (later Calspan) in Buffalo, NY. To be assigned to the amazing and challenging X-29 program was truly a dream come true. Flight testing in any program is a team game. The X-29 program involved contributions from many extremely talented individuals in both industry and Government. It was a privilege to be a member of the team for nearly a decade and to fly nearly 100 (actually 97) test flights during this exciting program.

It is impossible in this short introduction, let alone in a complete book, to mention all the contributors to the X-29 program. However, the designers and builders of this unique technology demonstrator, from the Grumman Aircraft Corporation, deserve special credit. Without their vision and drive, this special program in our aviation history would not have been possible. My own organization at NASA Dryden must also be noted for its excellent stewardship of the test program in its role as Responsible Test Organization.

It is a difficult challenge to write a book about this program, which lasted about a decade and involved testing an aircraft that incorporated many

Sweeping Forward

technologies designed to work together to achieve very efficient maneuvering flight. All the incumbent technologies that are described in some detail in this book were designed to minimize the penalty of increased drag during maneuvering flight. Gathering the necessary flight data to evaluate the extent of the achievement of this design goal—efficiently and safely—required innovation and creativity on the part of the test team at every step along the test-program path. As described in this book, the X-29 team was up to the task and created many new and essential flight-test techniques along the previously unexplored path created by this design.

It is a pleasure and a privilege to write the foreword to a book that tells the technical story about the very special X-29 test program. I would ask the readers to appreciate that the program was flown almost 30 years ago, and the problems noted must be appreciated in that context. For example, when I joined the program in 1982, I read several letters from technical experts who cautioned us not to attempt to fly this aircraft because it was too unstable. For reference, the basic X-29 aircraft was considerably more unstable in pitch than the Wright Flyer.

Finally, please remember that it is not possible to give proper credit to all the organizations and individuals involved in making this test program successful in the context of history. I am convinced that every reasonable effort was made to do this task right. As I mentioned previously, flight testing remains a team game.

Now, I invite you to look at the “big picture” of what this team accomplished in a relatively fast-paced test program involving the truly unique X-29.

Rogers E. Smith
Mammoth Lakes, CA
March 5, 2012



Rockwell concept for an FSW canard-equipped technology demonstrator. (USAF)

CHAPTER 1

The Background of the X-29

Aircraft design, more than many other disciplines, exemplifies the phrase “form follows function.” The laws of physics demand it. Aeronautical designers have always reached forward, stretching capabilities as far as the constraints of gravity and the limits of materials would allow their genius to probe. The emerging computer flight control and composite structures revolutions of the 1970s promised designers access to a hitherto impossible dream: a forward swept wing (FSW) fighter with enhanced maneuverability and efficiency.

The benefits of forward swept wings have long been understood. Both forward and aft swept wings yield significant drag reduction in the transonic speed range. Since air flows inboard on forward swept wings, unlike the outboard flow on traditionally swept wings, the forward swept wings’ tips remain unstalled at higher angles of attack, retaining maneuverability and controllability.

Several designs made forays into FSW technology. The sculpted, minimalist contours of the unflown Bugatti R-100 of 1937 included a modestly forward swept wing planform created by veteran Belgian designer Louis de Monge. His earlier designs had claimed three sanctioned speed records, and in the late 1930s, it is said de Monge wanted to best the speed claims of the emerging Messerschmitt fighter team. The tandem-engine R-100 did not fly in France before occupation by Germany caused the aircraft to drop out of sight until after the war, when it was no longer a speed contender in the jet age.¹

Forward Sweep Before the X-29: An Introduction to an Idea

A startlingly prescient encapsulation of the advantages of FSW technology informed the design of the experimental Junkers Ju 287 jet bomber. Starting in 1943 with a rearward swept wing design intended to exceed Mach 0.8, thereby outrunning Allied fighters, the Ju 287 design team quickly forecast that the wing sweep would yield unacceptable slow-speed flight characteristics. The Junkers

Sweeping Forward

team, led by Hans Wocke, interpreted available German data on wing sweep and concluded a forward sweep would give the Ju 287 manageable low-speed characteristics. Any adverse traits would be shifted to the high-speed end of the bomber's FSW envelope, where it was believed these issues would be easier to tame.²

Key to the advantage of forward wing sweep is the airflow migration inboard as it passes over the wing. With sweptback wings, airflow moves outboard and to the rear. The inboard flow of a forward swept wing has the aerodynamic effect of retaining attached airflow at the outboard sections of the wing even after the wing root has stalled, yielding greater aileron controllability at slower speeds.

German wind tunnel tests confirmed the Junkers team's radical ideas while also revealing a major hurdle of early high-speed-FSW designs: the wing structure was prone to potentially disastrous twisting loads lifting the leading edge of the tips at higher speeds. For a bomber design, the FSW geometry allowed for an unobstructed, large bomb bay ahead of the wing's forward spar in an area that experienced little center of gravity (c.g.) shift with bomb release. The Ju 287 concept was so promising that a full-scale forward swept wing was quickly mated to the modified fuselage of a Heinkel He 177A bomber to permit low-speed flight exploration. A Ju 388 tail assembly was fitted, and in a quirky move to get the test bed flying, the prototype was said to have used dual nosewheels cannibalized by the Germans from a pair of downed American Consolidated-Vultee B-24 Liberator bombers. The landing gear was not retractable, to save the time and engineering necessary to adapt swinging gear to the patchwork test bed. The mainwheels came from the Junkers Ju 352 as another off-the-shelf expedient. Four Junkers Jumo 004 turbojets powered the Ju 287, with two slung under the forward swept wing and another pair riding the lower cheeks of the forward fuselage near the nose. First flight was on August 16, 1944. To get the Ju 287 airborne, auxiliary jettisonable rocket packs clung to each jet nacelle during takeoff. The Ju 287 was an early employer of a drag chute in the tail.³

The FSW Junkers completed 17 flights from the Brandis airfield near Leipzig, Germany, and validated the slow-speed benefits of the wing planform. Tufted for full-scale flow visualization flights, the Ju 287 confirmed the nature of flow separation at high angles of attack for a FSW design, leaving the outer panels with attached airflow after the inboard airflow was degraded. One quirk of the wing design was the tendency to drop a wing when yaw was applied to the unorthodox Ju 287. Its slow-speed traits mapped, the big Ju 287 was next dived to 404 miles per hour with attendant aeroelastic issues as predicted. A fix was to build the second bomber with its intended six turbojet engines clustered three apiece under each wing, slightly inboard of midspan and jutting forward to provide mass balance. But the Germans' FSW bomber program suffered a reversal of priorities in the summer of 1944 when renewed emphasis was placed on fighter production to combat the increasing Allied

bomber presence overhead. The Ju 287/He 177 hybrid test bed was seriously damaged in an Allied bombing raid at Rechlin, Germany, but a flicker of work continued on the second example, with the forward swept wing mated to a bomber fuselage with landing gear retracting into the fuselage to preserve the wing's structural integrity. Unfinished aircraft number two was confiscated by the Soviets in 1945 and taken, along with engineer Hans Wocke and members of his team who completed its assembly in time for a 1947 flight in Russia.⁴

Thus ended a most ambitious foray into the world of FSW technology. Certain advantages were evident, but structural and control hurdles remained for a later era to solve. The Ju 287's wing spanned nearly 66 feet, mated to a 60-foot fuselage on the prototype that later was stretched about a foot on the production specification.

During the war, the U.S. Army Air Forces at Wright Field, OH, studied a FSW concept advocated by designer George Cornelius, who had earlier designed a light aircraft, the "Mallard," having a forward swept wing, that first flew in August 1943, showing some promise for further development. Dr. Courtland Perkins, later to become Assistant Secretary of the U.S. Air Force (USAF), reviewed Cornelius's ideas, and in a memoir Dr. Perkins recalled: "The characteristics of the sweptforward wing would be very good with a strong possibility of having a stable airplane at high angles of attack."⁵ Though the Cornelius glider did not lead to production, its concept sparked interest and research at Wright Field. A theoretical aircraft design was created by the Design Branch at Wright Field to enable a wind tunnel model to be constructed. The FSW model had a circular fuselage with a vertical fin. Ailerons were on the outboard portions of the wings and elevators occupied the inboard sections. Tested in Wright Field's 5-foot test section wind tunnel, the radical model "confirmed all our projections," Perkins recalled. "It had good longitudinal and lateral control powers, had excellent directional stability and it was longitudinally stable up into the stall."⁶ The model led to the construction of two manned FSW gliders, the Cornelius XFG-1, which were described as "easy and pleasant to fly," with one possible difficulty being stall/spin recovery, which the National Advisory Committee for Aeronautics's (NACA's) Langley Research Laboratory spin tunnel tests had indicated.⁷

Test pilot Arthur Reitherman died in a spin in the first of these gliders, dampening interest in the type, and other wartime Army Air Forces FSW fighter concepts subsequently went begging. Perkins said that during this wartime research period, he and his colleagues learned about FSW divergence issues. "The load on a sweptback wing when encountering a gust would twist the wing outer panels down, thus alleviating the load. It was a gust reliever. The sweptforward wing on the other hand would act in an opposite fashion. The load on the wing would twist the outer panels up to increase the load. It had a structural divergence possibility and the strength for the wing, and thus its weight had to be increased

Sweeping Forward

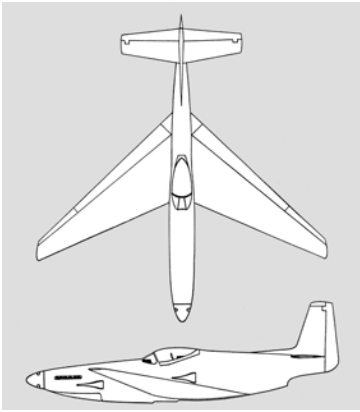

Proposed North American FSW derivative of the P-51 Mustang, to be powered by an Allison piston engine in the nose and a Westinghouse engine in the tail cone. (Drawing by Frederick A. Johnsen)

to withstand this. Any advantage in weight arising from leaving off the horizontal tail was absorbed in this increase in wing weight.⁷⁸ On both sides of the Atlantic, the advantages and limitations of FSW design were distilled during the war.

North American Aviation explored FSW technology as a way to prolong the usefulness of its famed P-51 Mustang fighter design, even as more traditional jet fighters were on the horizon. A postwar notion from North American was a tricycle-gear, FSW variant of the Mustang, riding behind a powerful late-model Allison liquid-cooled V-1710-G6R, and augmented with an aft ventral Westinghouse 19XB-28 jet engine. It remained an unbuilt dream machine.⁹

In the immediate postwar era, NACA's Langley Laboratory evaluated various FSW concepts, including exploring how such a configuration could be applied to its two most significant research aircraft projects of the time, the Bell XS-1 and Douglas D-558 high-speed research aircraft. Tunnel tests demonstrated the value of the FSW configuration but did not lead to actual application of the planform to derivatives of these two important designs.

Other less dramatic FSW designs cropped up in the postwar era, but perhaps the most successful incarnation was the German Hamburger Flugzeugbau HFB 320 Hansa jet transport, whose design was led by the same Hans Wocke who brought the Ju 287 to life nearly two decades earlier. This notable design first flew on April 24, 1964, and subsequently enjoyed limited sales success (despite the loss of the prototype in an accident in 1965). The moderately FSW planform of the Hansa business jet reflected the structural constraints of incorporating a FSW planform constructed of conventional metal structure. Even so, Wocke believed the configuration offered significant advantages for an aircraft intended to have low drag, a speed of 500 miles per hour, and a range of 1,600 miles. Additionally, it enabled an unobstructed cabin, an important consideration for passenger comfort. Traditional straight or rear swept wing design would have either necessitated wing spar location in the cabin area to the detriment of passenger accommodations or, possibly, a larger diameter fuselage, which would add to drag and weight. The Hansa's forward swept wing placed the wing-fuselage juncture aft of the main passenger cabin, allowing smaller dimensions that yielded better performance. The design also enabled



Forward swept wing configuration based upon the Douglas D-558 research aircraft tested at NACA's Langley laboratory. (NASA)

the use of a smaller horizontal tail than a traditional planview would call for, and this further reduced drag. Teardrop wingtip tanks projecting well ahead of the wing on the Hansa helped tame wing twisting and bending. The Hansa jet was a vindication of Hans Wocke's vision for FSW technology, and a total of 47 were built for civil and military use.¹⁰

Norris J. Krone, Jr., and the Genesis of the FSW Concept

The inherent limitations of metal airframes limited the practicality of high-speed FSW designs since the structural concessions necessary to control wing twisting were antithetical to other tenets of fast aircraft design. The promising technology of composite material layup construction changed this. Designers of the X-29A grasped the ability to make a successful high-speed forward swept wing coupled with the low-drag efficiency of a relaxed stability airframe, and they married composite structures with digital fly-by-wire (DFBW) controls to make it happen. The two salient technologies that enabled the X-29 are fly-by-wire and composite structures, yet the program was about many more technologies embedded in one aircraft.

The roots of the X-29 were planted and nourished by Norris J. Krone, Jr., who, while an Air Force lieutenant colonel, pondered his future as a stint in the Pentagon drew to a close in the 1970s. A career fighter pilot, Krone relished the thought of returning to the cockpit of a jet fighter. To his surprise, Air

Sweeping Forward

Force colleagues nominated Krone for an Air Force–funded Ph.D. program. But Krone believed his university years were behind him, and he initially declined the Ph.D. offer. When he was informed that a shortage of B-52 bomber pilots would be addressed by sending him as a fighter pilot to Strategic Air Command, the prospect of flying eight-engine heavy bombers in largely straight-and-level flight was so unappealing that Krone quickly reconsidered his educational option and made plans to enroll in an engineering Ph.D. program at the University of Maryland.¹¹

While searching for a meaningful and unexplored topic for his Ph.D. dissertation, Krone investigated the potential for using modern technologies to accomplish a viable high-speed FSW aircraft design. “I was amazed to find that nothing had been done on it,” he recalled later.¹² His dissertation would explore structural mechanics and aeroelasticity pertinent to such a design. The extant literature documented early FSW aircraft like the Ju 287 and its postwar justification, the Hansa jet. Grumman’s exploratory FSW work following its Highly Maneuverable Aircraft Technology (HiMAT) project proposal emboldened Krone in his research. HiMAT produced a remotely piloted aircraft with fly-by-wire technology and canards mated to a more conservative aft swept wing. As Krone explored the possibilities of forward wing sweep, his efforts were boosted by cooperation from the U.S. Navy’s David Taylor Model Basin west of Bethesda, MD, in the greater Washington, DC, area. The model basin, a sophisticated shipbuilding modeling tool in use since 1939, was an early user of computer technology. The Taylor Model Basin was one of only three Government organizations involved in a pivotal 1959 meeting that resulted in the creation of the pioneering computer language COBOL. By the 1970s, the Taylor Basin boasted a computer sophisticated enough to enable Krone to lay the groundwork for his FSW aircraft premise.¹³

Lieutenant Colonel Krone enlisted help from an East Coast icon of aeronautics, Richard T. “Dick” Whitcomb of the National Aeronautics and Space Administration’s (NASA)’s Langley Research Center in Virginia. Whitcomb’s uncanny comprehension of airflow had led to repeated breakthroughs, including the area rule, which mapped wing-fuselage interface to facilitate efficient transition to supersonic speed, and the supercritical wing, which yielded efficiencies in the transonic speed range. Both of these innovations would ultimately enhance the X-29 design. Upon visiting Whitcomb at Langley, Krone was impressed to see NASA reports Whitcomb presented on earlier FSW wind tunnel tests. Emboldened by the corroboration and encouragement Whitcomb provided, Krone attempted to encourage major U.S. aerospace contractors to design a high-speed FSW aircraft. Initially, no interest was forthcoming from industry.¹⁴

When Norris Krone finished his doctoral program, his follow-on assignment was with the Defense Advanced Research Projects Agency (DARPA).

The Background of the X-29

DARPA showed interest in Krone's FSW research, and the concept started to coalesce. Ever the fighter pilot, Colonel Krone initially relished the idea of weaponizing the FSW prototype, which he envisioned as a prelude to demonstrating military usefulness. But he was counseled by others in the Air Force to keep the concept free of armament to preserve its purely research pedigree, lest it encounter the same institutional push back then being experienced by advocates of the new General Dynamics lightweight fighter, the YF-16. In a time of seriously constrained budgets and an expanding Soviet threat, the Air Force leadership was quite rightly concerned that the growing F-16 might endanger acquisition of far more capable systems, such as the McDonnell-Douglas F-15 Eagle. (Fortunately, it subsequently did not, though numbers of F-15s were indeed reduced by the F-16 buy.) Accordingly, supporters of the FSW demonstrator did not want to cause any comparisons with the lightweight fighter research project, lest Air Force supporters grow skittish.¹⁵ Consequently, Krone quietly set aside some studies on FSW fighter prototypes that he had requested from Grumman and Rockwell, making sure they did not circulate where they could cause harm to the research X-29 effort.¹⁶

Krone shared his research about forward swept wings and composite construction. A 1975 paper presented by the new Ph.D. encapsulated the issue: "The use of swept-forward airfoils has generally been ruled out due to the aeroelastic phenomenon known as divergence. With the advent of advanced composite materials, a new capability (material tailoring) has been added to the structural field.... [By] tailoring the composite material properly, the structural weight penalty normally associated with divergence prevention can be greatly reduced."¹⁷

Krone explored the reasons that divergence became a hurdle. High subsonic aircraft speeds produced shock waves and compressibility issues that adversely affected aircraft controllability and drag. Thin airfoil cross sections coupled with sweep delayed the onset of these problems. A wing structure has structural elastic restoring forces; that is, when it is bent or flexed, it will tend to return to its original shape. Aeroelastic divergence occurs in some wings "when the dynamic pressure is sufficiently large that a change in lift caused by a wing deformation is greater than the structural elastic restoring forces, and the deformation increases until the structural limits are exceeded and the structure fails."¹⁸ This tendency for forward swept wings to experience divergence problems was already established long before Krone began his work in this area. He rightly realized that a more substantial divergence-defeating structure could make high-speed forward swept wings practical, but only if the structure weight did not grow as a side effect of the need to tame divergence. Krone's hypothesis was "that the traditional divergence problem of swept-forward wing designs can be alleviated by the judicious use of the advanced composite materials now commercially available."¹⁹ Krone

Sweeping Forward

acknowledged that the acceptable divergence (“q”—dynamic pressure—in engineering shorthand) level for forward swept wings would be lower than that for unswept wings. “The important consideration that designers face is associated with the amount of additional structural weight needed for the increased stiffness required to ensure the absence of divergence within the operating performance envelope of the aircraft.”²⁰ Traditional metal construction required prohibitive extra weight to suppress divergence in a forward swept wing, but nonmetallic composite materials could be tailored to meet specific wing-loading demands. Krone’s 1975 professional paper sought to demonstrate, by evaluating specific wing configurations, the degree to which tailored use of composites could tame divergence.²¹

For his 1975 paper, Krone used a computer model to analyze wing shapes that were trapezoidal plates. The computer-aided structural design synthesis program incorporated mathematical models to perform structural analysis, to determine aerodynamic loads, and to optimize the wing. The program was also able to quantify changes in lift attributed to wing deformation, both spanwise and chordwise. Krone’s theoretical wings were presumed to carry all structural loads in the skins instead of in a standard covered-spar-and-rib structure. Krone modeled a lightweight fighter similar to the then-new YF-16. The baseline design had a 15-degree rear sweep. Since this baseline wing was not susceptible to divergence phenomena, the weights of the baseline wing structures were defined by a combination of strength and minimum skin gauge. Krone’s other theoretical wings maintained the same wing surface area, aspect ratio, taper ratio, span, thickness ratio, and camber while having different sweep angles measured at the quarter chord (25 percent back from the leading edge of the wing). Krone’s model wings were trapezoids that all used the same length for root and tip chord, with the root and tip always remaining parallel to the airstream. His FSW configurations minimized structure weight by “a procedure that incorporates a divergence constraint.”²² This yielded a direct comparison of the effect of divergence on the weight of an aluminum versus a composite forward swept wing. Computer speeds of the 1970s being what they were, the modeling of these wings had a limited number of elements considered. “The upper limit on the number of elements is dictated by the computer running times required,”²³ Krone’s paper explained. “There are 70 panels used in this study.”²⁴ To solve equations and produce pressure distributions for his theoretical wings, Krone used ROT, an Ames Research Center analytical tool.

Krone’s fighter-style wing models used the YF-16 wing as a baseline and then improvised three equivalent planforms at 14.5 degrees, 27 degrees, and 35 degrees of forward sweep. Krone’s theoretical wings had skin thicknesses varied in both spanwise and chordwise directions as dictated by applicable equations; layer thicknesses were evenly divided between upper and lower skins. With the

The Background of the X-29

numbers crunched, Krone's efforts said a lightweight fighter with a forward sweep of only 14.5 degrees would have an aluminum skin weight of 562 pounds. This rises to 1,577 pounds for the 27-degree forward swept fighter wing and to a whopping 3,500 pounds for the 35-degree forward sweep, clearly showing the roadblock imposed by trying to make forward swept metal wings resistant to divergence. Exciting news came with the calculations for composite load-bearing skins on the same forward swept planforms, where the weights not only were low but also remained less than 30 pounds apart between baseline and full 35-degree forward sweep. The composite baseline wing weight was 308 pounds; the most radical 35-degree forward sweep weighed only 335 pounds, according to calculations. This was less than 10 percent of the weight of its aluminum equivalent design. An additional advantage of composite wing skins, Krone said, was that the actual aluminum wing weights would probably be higher than what computer models could replicate. Among the remarkable tricks that layered composite forward swept wings could perform, according to Krone's calculations, was the ability to carry loads in a way that promoted twisting the leading edge downward, thus decreasing angle of attack (AoA) and inhibiting divergence.²⁵

Krone stood at an exciting threshold mid-decade when he concluded: "[The] structural tailoring capability afforded with the advent of advanced composite materials, in conjunction with recent developments in the areas of optimization theory and high-speed computer software programs have opened the door for vehicle designers to use swept-forward airfoils with little fear of suffering the weight penalties that have previously been caused by the divergence phenomenon."²⁶ Clearly, it was "game on" for the design of a high-performance FSW aircraft. Nonetheless, Krone later recalled that he received counsel from some who were not as steeped in FSW and composite technologies who told him, essentially: "Don't build that airplane. You'll kill somebody."²⁷ But he had to put such thoughts aside and rely on the ample preconstruction research and analysis that said it could be done.

In 2011, Krone recalled events leading to the decision to build a FSW demonstrator:

The X-29 program was conceived to have two major phases:

1. The proof of concept, technical viability, and proof of operation usefulness in order to justify the funding for the building of an experimental aircraft.
2. The building and flight testing of a technology demonstration aircraft that would clearly show the ability to combine several complimentary and supplementary technical advances (in addition to the forward swept wing) in an aircraft that had the operational performance of a modern fighter aircraft.

Sweeping Forward

While working at the Air Force Systems Command [AFSC] Headquarters for General [William J.] Bill Evans [commander of AFSC] as chief of the Acquisition Cost Evaluation (ACE) project, I contacted Mr. Robert Moore—Director of the Tactical Technology Office (TTO) at DARPA—and told him of the Forward Swept Wing (FSW) work I had done at the University of Maryland (as an Air Force Institute of Technology PhD student) to see if they would be interested in such a project. His reply was that DARPA would and offered me the opportunity to join DARPA as the program manager for the effort. I accepted the offer and joined DARPA in 1976. After arriving at DARPA I briefed the director, Dr. George Heilmeier, of the proposed program and he gave approval for funding the project with \$300,000 for the initial year of the first phase of [a] multiyear program.

It was clear from the beginning that a number of tasks had to be accomplished and questions had to be answered before the building of full-scale aircraft (Phase 2) could be commenced. These included the following:

1. The aerospace community had to verify and believe that the structural divergence problem could be solved without a weight penalty—the conclusion of my work at Maryland. This required independent analysis by industry members as well as government organizations.
2. The aerodynamic advantages had to be shown, and that there were no offsetting disadvantages.
3. It had to be shown that there are configurational advantages of FSW designs that could result in a superior fighter aircraft when compared to an aft swept design (either lighter weight or better performance for the same weight and cost.)
4. It was necessary to determine which other technologies would be incorporated in the experimental FSW aircraft that would serve to justify the large funding requirement of such an X-aircraft program.

The first action needed was to obtain a service partner that would act as a DARPA agent and to do the contracting for the program funding of the contractors' efforts. This responsibility was accepted by the Air Force Aeronautical Systems Division at Wright-Patterson Air Force Base [AFB]—Dr. Tom [Thomas M.] Weeks accepted this responsibility. This prompted a number of actions over a number of years (1976-1980) at Wright-Patterson including independent studies and analysis, and wind tunnel testing at

The Background of the X-29

Arnold AFB. In the same time period meetings with NASA Langley officials were held with resulting agreements to support the effort by contributing wind tunnel time and technical expertise, including participation on numerous advisory committees. These committees included experts from the academic community.

I knew that if we were ever to get to Phase 2 the project would require heavy support from the major airframe manufacturers. Therefore, meetings were held with most of them to determine which were interested and which had done previous work on the subject. This resulted in proposals from General Dynamics, North American [Rockwell] and Grumman aircraft companies. These three were awarded contracts with the general requirement to address the four tasks stated above. After approximately three years it was determined that all tasks had positive results and there remained no serious doubt that the X-plane could be built successfully. Therefore, Grumman and North American were contracted for detail design of the experimental flight demonstrator aircraft. As a result of this competition both designs were judged acceptable; Grumman was selected based on cost to build the X-29 demonstration aircraft. Mr. Glenn Spacht had been the supporter and leader at Grumman from the beginning [and] continued to run the building and test effort. The final decision depended upon an agreement between the Air Force and DARPA for the funding of the plane. After much negotiation this agreement was reached in early 1981 and the contract to build was awarded about six months later. Col. Jim Allburn took my place as the DARPA X-29 program manager.

The X-29 aircraft program, from its beginning until the completion of the flight test effort nearly 20 years later, was made possible by the participation and support of many people and organizations. It is my belief that there has been no other aircraft program that has had as many—the X-29 is unique in this regard.²⁸

As Krone continued researching and advocating his project, Air Force wind tunnel tests of forward swept wings were encouraging. A technical paper reported: “It was shown that under identical transonic maneuver design conditions, a forward swept wing can be designed to provide lesser drag than an equivalent aft swept wing. A potential for further drag reduction was demonstrated by comparing the wing bending moments and showing that the FSW bending moment is lower, thereby allowing possible growth in FSW aspect ratio and reduced induced drag.”²⁹

Sweeping Forward



Proposed General Dynamics FSW derivative of the F-16 Lightweight Fighter. (USAF)

DARPA and AFFDL Launch the X-29

In 1977, DARPA and the Air Force Flight Dynamics Laboratory (AFFDL) (part of the service's Wright Aeronautical Laboratories) published proposals calling for a research aircraft to explore potential benefits of a forward swept wing. Tantalizing research suggested that such an aircraft would possess better control and lift during extreme maneuvers while possibly creating less aerodynamic drag than conventional aircraft of similar capability. As referenced earlier, a study by Norris J. Krone, Jr., said the time was right for this, because new composite construction materials and techniques would enable the wing to be light and yet strong enough to cope with the aeroelastic exigencies of high-speed flight. Rockwell International showed a full-size mockup of its FSW proposal that featured forward canards placed in a higher plane than that of the wing. General Dynamics proposed mounting a forward swept wing on its F-16 fuselage, retaining aft-mounted horizontal stabilizers instead of canards.³⁰ Grumman devised an angular canard-equipped airframe that employed a Northrop F-5A forward fuselage and F-16 main landing gear as construction efficiencies.

In December 1981, Grumman won the ensuing competition to build the FSW X-29 aircraft. It was the first time in more than 10 years that a new X-plane design was under way.³¹ James Allburn, DARPA's second X-29 program manager following Norris Krone, cites the Future Applications Committee (FAC) as a salient benefit of the X-29 program for the way in which it efficiently disseminated knowledge gained from the X-29 to other American aerospace firms. Even before formally invoking of the FAC, representatives from the Air Force, the Navy, NASA, and industry were involved in the proposals, Allburn recalled. "I don't know whether anybody other than DARPA could have pulled that off."³² This diverse group of interested parties evaluated proposals but did not see the costs proposed by the three finalists. DARPA made the final selection.

The General Dynamics submission was based largely on the F-16, but with a forward swept wing and no canards. The Grumman design used many off-the-shelf components as economies of cost and time but presented a dramatically unstable aircraft in the offering. Rockwell's variant was all new. "There was a risk associated with everything in the Rockwell design, selectors believed,"³³ Allburn recalled. So on the relative merits of technology, risk, and cost in all three designs, the Grumman approach was selected as the right mix, offering advanced technology demonstration at an acceptable level of risk.

Grumman's Glenn Spacht characterized the three FSW proposals that were placed before DARPA for selection: General Dynamics' iteration of its F-16 was the most traditional in appearance, and Spacht believed it had an instability in the range of 5 percent or so. Rockwell's all-new design, with instability Spacht characterized in the 15-percent region, used forward canards with dihedral—canards that were located where they would have little direct interaction on the wing of the aircraft. Grumman's proposal instead embraced interaction between the canards and the wing. "Our canard was within a couple percent of being co-planar with the wing,"³⁴ he explained. This deliberately promoted canard-wing interaction on the Grumman design; the canard was the primary pitch control for Grumman's design. Grumman's 35-percent instability for its X-29 produced an interaction between the canard motion and camber-changing flaps, with control inputs constantly dithering at 40 times per second to maintain stable flight. Except at high angles of attack, the canard would induce pitch when commanded and then return to essentially zero pitch to trim the aircraft, where it was most efficient at contributing to aircraft lift. The strake flaps toward the rear of the fuselage helped reduce nosewheel liftoff speed, and they also participated in the computerized pitch control of the X-29. The control surfaces on the X-29 were in continual, if not always visually obvious, motion, driven by the flight control computers to keep the aircraft stable. "It's the same as trying to balance an umbrella [pointing upward] on your hand...you're moving your hand all the time,"³⁵ Spacht said. Where Rockwell

Sweeping Forward

envisioned an all-new design for its FSW concept, Spacht said Grumman used “a junkyard dog approach” with parts from existing aircraft where feasible to minimize cost, and the Grumman approach worked.³⁶ Six months after the contract award, Grumman had taken delivery of the first of two available F-5A forward fuselages and created a mockup X-29 cockpit layout in it for evaluation first by Grumman pilots and then by the Air Force.³⁷

The storied instability of the X-29 was characterized by NASA research pilot Rogers Smith. The meaningful data are the times to double amplitude. At its worst, in slow flight, if all computers went offline, the X-29’s time to double amplitude was about 0.12 seconds, or only 120 milliseconds. Smith explained: “The degree of instability means that the basic X-29 (computers off) would diverge at a pitch rate such that it doubles its amplitude every 0.12 seconds 5 degrees pitch attitude to 10 in 0.12 seconds; 10 to 20 [degrees of pitch] in 0.12 seconds, and so on. That’s very, very fast. No human operator could stabilize it.”³⁸ By comparison, the Wright Flyer was measured to have a time to double amplitude of only 0.5 seconds, Smith noted, “and that was barely flyable.”³⁹

Grumman’s involvement in the program reflected longstanding interest. In 1976, Grumman engineers had analyzed data from HiMAT model tests in NASA Langley’s 8-foot transonic pressure tunnel that promised a decrease in induced drag and improvements in maneuverability for a wing “by sweeping the wing forward (leading edge of the tip forward of the leading edge of the root).”⁴⁰ A Grumman memo dated April 27, 1976, noted succinctly: “Further study of the forward swept wing concept is recommended.”⁴¹

Grumman placed itself at the forefront of forward swept wing and aeroelastic tailored composite structures after exploratory work in the mid-1970s by Grumman aerodynamics engineer Glenn Spacht revealed that tantalizing drag and weight benefits could be derived. Grumman’s unsuccessful bid for the remotely piloted HiMAT technology demonstrator was premised on a swing-wing design that used tailored composite construction of wing covers to yield desired strength and weight margins while taking aeroelastic effects into consideration. Following Grumman’s loss of the HiMAT competition, NASA Langley offered some wind tunnel test time with the Grumman model for further research. During the HiMAT post-test analysis, Grumman derived mathematical formulas that correlated the results of two-dimensional tests of its thin supercritical airfoils to the measured performance of the three-dimensional HiMAT wing design. Those formulas indicated that a forward swept wing would yield lower drag at a shallower angle of sweep than with a comparable aft swept wing design. The length of the structural wing box was also shorter and therefore lighter in weight than an aft swept wing employing the same airfoil technology. The combined reduction in wing weight and drag

The Background of the X-29

would result in a significant reduction in the takeoff gross weight of a fighter aircraft, such as the F-16, optimized for transonic maneuvering.

“Since we had used aeroelastic tailoring on our aft swept HiMAT configuration to increase the twist of the wing, it seemed obvious that we could use the same technology on a forward swept wing to increase the wing’s divergence speed,”⁴² Spacht explained. This promising research coincided with the discovery by Warner Lansing, a Grumman engineer, of Norris Krone’s Ph.D. dissertation on forward swept wings and aeroelastic tailoring. “At this point it was an interesting exercise,”⁴³ Spacht recalled later. The promised weight savings were intriguing. Engineer Spacht voiced a truism of aircraft procurement: “Airplanes are like baloney—you buy them by the pound.”⁴⁴ If Grumman could deliver high performance at lower weight, the company could be especially competitive. Part of the forward swept wing’s appeal was its ability to diminish profile drag from a transonic shock wave. In transonic flight, just below Mach 1, the aircraft is still flying subsonically while the accelerated movement of air over the upper surface of the wing has attained supersonic speed.

By 1978, with its exploratory work on a FSW HiMAT version in hand, Grumman identified a theoretical FSW aircraft concept as Grumman Design 712.⁴⁵ The company ultimately designed a forward swept wing piloted demonstrator that was as bold and new as it needed to be while realizing economies by using numerous off-the-shelf components. This would become the X-29.

As Glenn Spacht continued to demonstrate the potential advantages of a forward swept wing, high-performance aircraft, he gave the concept life. “It started off with a blank piece of paper and me telling a designer to draw an airplane with a forward swept wing.”⁴⁶ Before cost considerations drove the decision to incorporate off-the-shelf components, an early Grumman notional FSW airplane design used a single chin inlet for the jet engine instead of the twin side-by-side inlets of the actual X-29, a byproduct of its solid-nose F-5 forward fuselage. The choice of an F-5A forebody for the X-29 was informed by several requirements in the Grumman design. “First of all, you wanted a supersonic airplane,”⁴⁷ Spacht explained. That necessity ruled out slow jets. And the forebody had to be a component the Air Force could furnish, which in the early 1980s pointed to something like the F-5. And from a mechanical standpoint, along with the intended F-16 main landing gear came a requirement to match the nose-gear length so that the nose section would conform to the overall design of the airframe. Here, the F-5A’s nose gear promised to keep the nose section within limits otherwise imposed by the length of the main gear struts, Spacht explained.⁴⁸

Keith Wilkinson was involved in Grumman’s early FSW forays. He described the company’s exploratory adventures with technologies that would bear fruit in the X-29:

Sweeping Forward

As the lead aeroelastician from the early days of the FSW program at Grumman, the obvious concern was wing divergence. After a search of the very limited data base on forward swept wing technology at that time, it became clear that Grumman needed to verify the accuracy of our analytical tools for predicting divergence speed through an experimental test program. In a meeting with Renso [L.] Caporali, Grumman's Vice President of Engineering, in 1977, we were able to get some seed money to scope out a program. It was decided that the wind tunnel model should replicate the aeroelastically tailored composite wing cover of the full scale design. This required the development of ultra thin graphite tape for accurate stiffness replication, so the model was going to be quite expensive. We met with Colonel Krone at Wright-Patterson around September 1977 to lay out our plan. Close to the end of the year FDL issued an RFP [Request for Proposals] for an FSW validation program and ultimately Grumman and Rockwell both won \$300,000 contracts in 1978. Incidentally, the total cost of our program was closer to \$500,000. Grumman was well placed to address the issue of aeroelastic tailoring of the FSW composite wing design as a result of the earlier development of the FASTOP optimization program, under contract to Wright-Patterson, which addressed the design of minimum weight metallic wing structures for strength and flutter speed constraints. The program was later expanded, through in-house funding, to address composite structures with divergence speed constraints.

Grumman, under contract to Wright-Patterson, subsequently designed, fabricated, and tested a half-scale advanced composite model of an early variant of the X-29 wing in the TDT [Transonic Dynamics Tunnel] tunnel at NASA Langley in 1980. Test results, using a variety of experimental divergence prediction methods provided by NASA, indicated that analytical predictions were slightly unconservative at Mach 0.95, where the minimum divergence speed occurred.

In the later pre proposal-risk reduction phase of the FSW program, all three contractors were subject to reviews by a committee of experts from government, industry, and academia under the auspices of SRI [Stanford Research Institute, now SRI International]. It was during that time period that I got a call from Mike Shirk, at the Structural Dynamics Branch at

The Background of the X-29



Grumman configuration model of the proposed X-29, showing the features that won the competition. (USAF)

Wright Field, requesting that we give priority to investigation of the potential coupling of the FSW wing bending mode with the aircraft rigid body stability mode at high-dynamic-pressure flight conditions. This instability, referred to as body freedom flutter, occurs when a forward swept wing loses its net stiffness (structural, positive plus aerodynamic, negative) as airspeed is increased. As a consequence, a higher airspeed results in a reduction in wing bending frequency. As the wing bending frequency approaches the frequency of the aircraft's short period stability mode, unstable coupling can occur.

Since our analytical tool, SAEL, which addressed such analyses for digital flight control systems, was still in development, the Grumman Dynamics Group and the Stability and Control Group, hastily kluged some programs together for an analysis which showed that an unstable coupling would occur before the onset of wing divergence, but adequate margins of safety were demonstrated, i.e. greater than 15% above V_L , as required by the MIL [Military] specification." [Note: V_L is defined as Limit speed. For basic and high drag configurations, it is the maximum attainable speed commensurate with the operational use of the airplane].⁴⁹

Configurational and Structural Design Aspects

Executed as a pure research aircraft, the X-29 existed to prove capabilities that could be incorporated into future fighter designs. As such, the X-29 largely looked like a fighter. Its fuselage from the cockpit forward was grafted from a Northrop F-5A. One X-29A used a former USAF F-5A fuselage (aircraft 63-8372) as its basis; the other was cleaved from a former Royal Norwegian Air Force (RNoAF) F-5A. Grumman added new fuselage structure aft of the cockpit that served to host a single General Electric (GE) F404 jet engine comparable to one of the powerplants of an F/A-18 fighter. Main landing gear was off-the-shelf F-16 hardware, as were the flight control actuators. The flight control system (FCS) was a triple-redundant, three-channel DFBW computer system proven in the exotic Lockheed SR-71 Blackbird. Each digital computer had an analog computer backup, further minimizing the possibility of catastrophic loss of control capability. The composite-skinned forward swept wing spanned 27 feet, its overall length was 48 feet, and the new vertical fin topped out at 14 feet. Its empty weight was 13,600 pounds and takeoff weight was not that much heavier, at 17,600 pounds—only two tons more. Clearly, the X-29 was a lightweight speedster geared for the test environment, not operational military service. It lacked aerial refueling capability and was not finished to carry external stores.⁵⁰

From the outset, DARPA wanted the X-29 to be more than only a FSW demonstrator, as Dryden's Dave Lux and Gary Trippensee recounted: "During the preliminary design studies, DARPA stressed the incorporation of other technologies into the aircraft to maximize the return on investment for any new flight test vehicle. These additional technologies, although highly synergistic with the FSW design, could also be used in comparable aft-swept-wing aircraft."⁵¹

The amalgam of technologies hosted in the X-29's diminutive airframe included, most obviously, the radical forward swept wing. Its 30-degree-negative-sweep angle reduced drag by as much as 20 percent in transonic maneuvering flight. This efficiency equated to needing less power and fuel to achieve the same results as a traditional fighter. The inward migration of airflow over the forward swept wing also promoted greater controllability at high angles of attack, as airflow remained attached at the outboard sections of the wing, promoting aileron controllability even as the inboard section began to stall and lose effective airflow. NASA summed up the benefits of the forward swept wing as: "less drag, more lift, better maneuverability and more efficient cruise speed."⁵² Traditionally, aft swept wings require downward twist at the tips to keep the tip sections, and the ailerons located there, still flying and not stalling when the inboard section of the wing is already stalling at higher angles of attack. The detriment to this twist is lost efficiency through increased aerodynamic drag, increasing at higher

speeds. The forward swept wing's inherent change in the way air migrates spanwise during flight calls for a slight upward twist to be built into the tips, but at less severe an angle than with traditional wings. This translates into less aerodynamic drag than with a conventional wing twist.

The availability of composite construction technologies enabled the X-29's designers to employ aeroelastic tailoring in which the wing skins were layered specifically to prevent divergence—adverse twisting of the wingtips at high speed. Previous use of composite structures

essentially replaced metal parts with composite parts without taking advantage of construction advantages offered in some areas by composites. The X-29, following the HiMAT unpiloted vehicle, used aeroelastic tailoring to leverage the strengths of composites.

Just as the prolific X-29 program created a wealth of engineering results for future use, so did the X-29's very premise rely on measurement methodology reaching back to 1932. That is when R.V. Southwell developed his analysis for use as a tool in predicting buckling in steel columns. This model was applied to X-29 wing divergence since that divergence is both precipitous and catastrophic. At NASA Langley Research Center in 1979, the Southwell analysis was adapted for use with simplified models of forward swept wings. Subsequent FSW wind tunnel testing by Grumman and Rockwell further validated this use of an adapted Southwell analysis to predict FSW divergence.⁵³ Both Rockwell and Grumman tested FSW configurations in NASA Langley's Transonic Dynamics Tunnel in 1979. At this early juncture, the Grumman FSW idea differed substantially from its final configuration as the X-29; the 1979 iteration appears to be based on the all-new fuselage structure, with the cockpit placed farther forward than on the actual X-29, and with no leading-edge extensions as seen on the real aircraft.⁵⁴

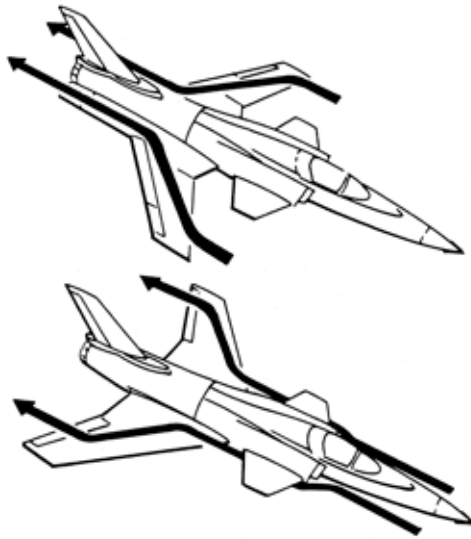

“Inward” (tip toward root) flow pattern over an FSW aircraft as compared to the “outward” (root toward tip) flow pattern of a conventional aft swept wing. (NASA)

Sweeping Forward

The Southwell analysis was applied to wing data after certain X-29 missions, as described in a NASA X-29 report: “Static wing divergence clearance was accomplished by use of both strain gauge and FDMS [flight deflection measurement system] data. Separate postflight analysis of the data with the Southwell technique gave an estimate of the divergence speed, which was compared with predictions.”⁵⁵

Predicting when wing divergence would occur and ensuring the X-29’s flight envelope remained inside this parameter were crucial to the entire FSW effort. NASA engineers produced a detailed analysis of the Southwell data’s strengths and shortcomings as they developed ways to accurately and safely plumb the limits of X-29 wing divergence. In a 1988 NASA technical paper, authors Lawrence S. Schuster and William A. Lokos explained the issues:

One of the concerns about structural divergence of the X-29A is that static divergence is not likely to be the limiting factor in envelope expansion. Another phenomenon, the coupling of the wing first bending mode with the rigid body pitch mode, is predicted to occur at lower speeds than static divergence. . . . However, frequency trends for this dynamic divergence are highly nonlinear, allowing only point-to-point clearances as speed is increased. The wing first bending frequency drops toward the pitch rigid body frequency, but the nonlinearity of the frequency trend prevents extrapolation to the actual divergence speed at speeds well below the divergence speed. Thus, comparisons between actual and theoretical predictions of the divergence speed cannot be made.

Likewise, the phase and gain margins for the control system become unacceptably small as the divergence speed is approached, and controllability becomes a problem. These effects are also nonlinear, requiring a point-to-point clearance approach. If the Southwell method can be used successfully with flight data, the resulting comparison between the design divergence speed and the flight data extrapolation of the divergence speed can be used to provide an independent indication of whether the aircraft limits are actually closer than expected to the flight envelope boundaries.

The flight test challenge is to apply the Southwell method to flight data to provide a reliable extrapolation to the actual structural divergence speed boundary during the envelope expansion program. Furthermore, the method ought to provide reliable results that can be used in comparisons with the predicted divergence speed in order to validate the methods used during the

design process to assure that the divergence speed is outside the flight envelope.

The problem with using the Southwell method is that the flight data are obtained at dynamic pressures well below the divergence dynamic pressure. The wind tunnel data were available at conditions relatively near the actual divergence speed. None of the flight data is at conditions that can be considered near the actual divergence speed. In fact, the extent of the extrapolation is quite large.... The accuracy of flight test measurements is not much better than in the wind tunnel, and control of the test conditions is certainly more difficult. Considerable effort is required to improve the chances of successful application of the Southwell technique. The highest quality flight data are needed, an analytical assessment of the characteristics of the data is required, and very careful and thorough flight data analysis techniques must be used.

Strain gauges calibrated to provide shear, bending moment, and torque measurements at several locations on the X-29A... are used to provide data for the structural divergence flight tests. Although all load measurements on the wing are available for analysis, the principal load measurement used for divergence is the wing root bending moment. This measurement is the most accurate one available on the wing and is also thought to be the best measure of the loads that produce the structural divergence phenomenon. In other words, the streamwise twisting of the wing is likely to be proportional to the wing root bending moment.⁵⁶

Light-emitting diodes (LEDs) enabled wing twist measurements to be quantified under actual flight conditions:

To measure the wing twist during flight maneuvers, an electro-optical flight deflection measurement system (FDMS) was installed early in the flight test program. The wing box twist can be calculated from wing deflection measurements made at streamwise measurement stations on the wing.... The FDMS as installed on the X-29A consists of a control unit, a target driver, twelve infrared light-emitting diode (LED) targets and two receivers. The control unit interfaces with the aircraft pulse code modulation (PCM) data system and also commands the operation of the target driver and receivers. The surface-mounted LED targets serve as active location markers and are momentarily energized one at a time by the target driver beginning with target number 1 and

Sweeping Forward

ending with target number 12. This cycle is repeated $12\frac{1}{2}$ times/sec. The light image from the energized LED is focused by the receiver's cylindrical lens as a line cutting perpendicularly across its linear photodiode array. This output from the photodiode array in the receiver is the signal that is converted by the control unit into a displacement data sample. Because of vertical field-of-view restrictions, one receiver monitors the inboard six targets while the other receiver monitors the outboard six targets.... Wingtip twist is calculated from the displacements of the forward and aft tip targets.⁵⁷

The need for useful wing strain data called for clever adaptation of the X-29's unique computer flight control system. Normal operations would induce surface movements that could mask or skew the needed wing activity measurements. The engineers developed a workaround that capitalized on the X-29's programmable flight control system:

The standard mode of operation of the X-29A control system is known as normal digital mode, with automatic camber control (ND/ACC). This mode controls the flap position as a function of normal load factor such that the flaps deflect more trailing edge down during increasing load factor maneuvers. In order to obtain the necessary load coefficient data for the divergence extrapolations, wing loads and deflections must be a function of angle-of-attack changes only. Therefore, a special flight test mode has been designed, called manual camber control (MCC), to allow operation of the X-29A at constant camber settings during maneuvering flight.... In the MCC mode, the camber setting can also be set at the same value for flight test points from very low to very high dynamic pressure values. To achieve this while preventing the trim loads on the canard surfaces from becoming large, canard protection logic is incorporated into the control system. This essentially limits operation in MCC mode to only two or three camber settings at each flight condition. The camber settings available at transonic flight conditions (either zero flap angle or trailing edge up flap angles of 5° or 10°) are not ideal for collecting aerodynamic data. However, without the MCC mode, it would be extremely difficult to obtain the necessary data for the divergence investigation.

Load coefficient and twist data are obtained during angle-of-attack sweep maneuvers, both pushover-pull-ups and windup

The Background of the X-29

turns, in order to obtain data over the widest possible angle-of-attack range. The maneuvers are performed at several altitudes at each Mach number of interest.... From each maneuver, the slope of the data with respect to angle of attack is obtained for use in the extrapolation.⁵⁸

The NASA engineers matter-of-factly described a chilling scenario that could lead to wing failure on the X-29:

The purpose of subcritical divergence prediction techniques is to extrapolate the static aeroelastic characteristics of the configuration to the critical dynamic pressure at which the aeroelastic effects become infinite. When the dynamic pressure is at the critical value, the slightest disturbance results in essentially instantaneous and catastrophic overload of the aircraft structure. The aerodynamic load coefficients with respect to angle of attack are infinite at the critical condition.⁵⁹

Not all data sources agreed on the final critical value by extrapolation: “The flight data for root bending moment coefficient and tip twist do not extrapolate to the same value of divergence dynamic pressure, but disagree considerably.... Such disagreement leads to the use of a combination of techniques to accomplish the envelope expansion process.... Because of the disagreement in Southwell extrapolation results, the envelope expansion program consists of a combination of the Southwell results with point-to-point clearances.”⁶⁰ The data allows judgments to be made about the likely measurements at the next dynamic pressure point, even though the data cannot be reliably extrapolated to the critical divergence speed. “As long as the values...do not increase considerably more than expected from one dynamic pressure point to the next higher point, the envelope expansion can proceed as planned. As more data are obtained at higher dynamic pressures, the reliability of the extrapolation of a particular measurement generally improves. However, because the critical dynamic pressure values obtained from a variety of measurements do not agree, these values cannot establish an actual flight-derived divergence speed limit.”⁶¹ Nonetheless, the careful interpretation of X-29 wing-load data enabled the X-29 team to determine that catastrophic divergence would not occur within the performance envelope as they expanded it precisely, yet quickly. Even as they were computing X-29 divergence numbers, the team understood they were pioneering and validating research methods of lasting use to future programs as well.

High-strength composites including carbon fibers, Kevlar, glass, and other materials were embedded in a plastic matrix to create the X-29's FSW covers.

Sweeping Forward

The wings used 752 crisscrossed composite tapes building up to a maximum thickness of 156 layers to create the top and bottom surfaces of the wing's torsion box. The lightweight strength of these composites enabled a practical taming of the divergence problem that thwarted earlier notions of high-speed FSW designs. The X-29's designers were emboldened by the inherent strength of the aeroelastically tailored wing construction to employ a thin supercritical wing airfoil. The supercritical wing was one of several aerodynamic breakthroughs fostered by NASA's prolific Richard T. Whitcomb. The supercritical airfoil shape delays the onset of transonic shock waves on the upper surface of a wing. Since these shock waves increase drag and decrease lift, their minimization with a

supercritical wing increases the efficiencies of that wing in the transonic speed range. Jet airliners having cruise speeds above Mach 0.8 benefit from supercritical wing technology, and the X-29 used a thinner version of the technology to bring supercritical wing benefits to the fighter world.⁶²

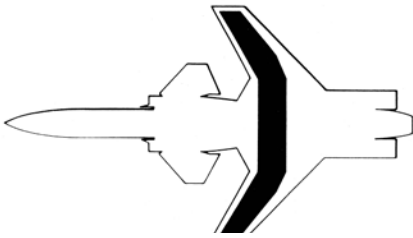

The X-29 Wing Torsion Box; robust composite construction ensured it had sufficient rigidity to withstand aeroelastic divergence. (NASA)

The composite graphite-epoxy wing covers were bolted to the underlying wing structure with a series of bolts ranging from $\frac{3}{16}$ -inch to $\frac{7}{17}$ -inch diameters.⁶³

This supercritical wing was equipped with flaperons—combined usage of trailing-edge flaps and ailerons—capable of altering the X-29's wing camber for optimal performance in different speed ranges. Some camber facilitates supercritical efficiencies in the transonic range, while a flatter airfoil helps at supersonic speeds. And the X-29's forward canards added pitch control, lift, and inboard stall resistance to the X-29's flying abilities. Where traditional pitch controls—aft-mounted elevators—produce a downward moment to stabilize the aircraft, the X-29's canards added lift, at the price of inherent stability. The DFBW controls enabled this. At high angles of attack, the canards directed airflow over the inboard wing area to resist stalling. The canards were capable of independent motion through an arc of 30 degrees up and 60 degrees down. The flattened strakes running aft from the wings culminated in the rear of the fuselage with 30-inch strake flaps that augmented the strakes for pitch control of the X-29. All of these control surfaces worked together, and continuously, to keep the X-29 under control. NASA described the action: "To minimize trim drag and maximize the X-29's responsiveness at the onset of maneuvers, the canards, flaperons and strake flaps are driven in concert and continuously. The canards provide primary pitch control, the flaperons provide roll control,

The Background of the X-29

high lift and camber adjustments, and the strake flaps augment the canards at low speeds such as rotation for takeoff or recovery from a deep stall.⁶⁴ At high angles of attack, the strake flaps positioned themselves to give the X-29 a slight nose-down pitching moment, which conserved canard power to help prevent a hung stall.⁶⁵

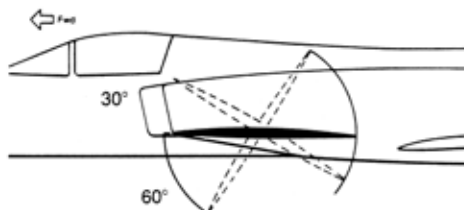

Range of motion of the X-29's canard control surfaces, from +30 degrees leading edge up to -60 degrees leading edge down. (NASA)

Even as the X-29 design proceeded, available limited analysis hinted at transonic buzz and supersonic flutter in the flaperon system that threatened to give the X-29 a smaller-than-desired flight envelope. Efforts to stiffen the flaperon hardware against such problems did not fix the theoretical problem. A possible alteration of the flaperon system was proposed that would allow flight throughout the envelope but at the expense of limiting wing camber, which would also limit drag reduction. Fortunately, an accurate 16-percent-scale reflection-plane (half of the X-29 planform) model was made and tested at Ling-Temco-Vought (LTV) in a high-Reynolds-number wind tunnel. This model used a dynamically scaled flaperon system. Test results refuted earlier predictions of buzz or flutter in the X-29's proposed design envelope, giving the X-29 team increased confidence to continue on its original course.⁶⁶

Grumman's lead aeroelastician, Keith Wilkinson, described the perceived problem:

The X-29 geared flap/tab was essentially a variable camber device and was also used for roll control. Although none of the X-29 flaperon features could be considered unique to a FSW concept, they introduced potential risk to the program from a flutter standpoint. Historically control surface tabs have been the cause of in-flight flutter instabilities, primarily because of the difficulty of predicting tab aerodynamic force derivatives using linear aero codes in the deepened boundary layer at the trailing edge of a wing or tail surface. In addition, the possibility of shock induced instabilities in the X-29 transonic flight regime lead Grumman to recommend and conduct an experimental wind tunnel flutter model test program of an X-29 flaperon. This 16 percent scale model included a rigid wing, and a dynamically scaled flap and tab. Testing was performed at LTV's blow-down tunnel in Texas where we were able to demonstrate that the flaperon was stable throughout the X-29 flight regime.⁶⁷

Sweeping Forward

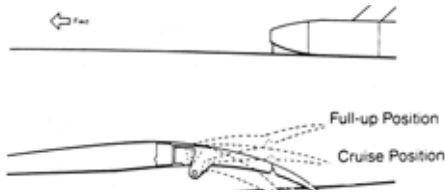

The X-29's variable camber wing could be tailored to assume the best airfoil cross section for the speed at which it was flying. (NASA)

This illustrates the iterative nature of the experimental design process. The original data, which suggested potential buzz and flutter problems, was a valid warning that prompted efforts to redesign the system or explore other modeling techniques; the latter carried the day.

The X-29's Flight Control System: A Major Design Challenge

Embracing a computerized flight control system for an aircraft as radical as the X-29 was a major show of confidence by Grumman in the early 1980s. As early as July 1982, Glenn Spacht, Grumman's deputy director of development for the X-29 program, acknowledged scheduling concerns for this ambitious undertaking: "Our major area of concern continues to be the verification and validation of the Flight Control System."⁶⁸ By January 1983, Grumman management could see slippages in the X-29's cost and schedule objectives. As described by an Air Force Advanced Development Projects Office (ADPO) observer at the time: "During January and February [1983], Grumman conducted an independent audit of the program with extensive emphasis on the flight control system and its interaction with the aircraft's structural dynamics characteristics. The basic technical problem is the aeroservoelastic characteristics of the current X-29 design. The flight control system is presently designed with backup modes that are attempting to permit safe flight throughout the envelope with a single set of gains. When flying in these backup modes, gains set for reasonable flying qualities are causing a coupling between the structural modes of the aircraft and the flight control system. When the gains are turned down to protect against structural instabilities at high speed, the flying qualities become unacceptable at low speeds. It is important to note that the normal digital flight control mode does not have this problem because it has the flexible option of numerous sets of gains across the envelope."⁶⁹

Grumman's remedy was to offer the X-29 with a set of flight-envelope parameters initially limited to an AoA of 15 degrees, a speed not to exceed 300 knots (or 0.6 Mach), and a ceiling of 30,000 feet. Meanwhile, company resources would be spent on making the FCS and its backup modes fully capable over the entire planned spectrum of operations for the X-29. This scenario

The Background of the X-29

played out, although Grumman's desire to have the first flight take place at its Calverton facility in April 1984 went unfulfilled on both location and date.⁷⁰

The design and construction of any aircraft involves a shifting battle between weight saved and weight gained as requirements evolve. Some fighter development programs have suffered what has come to be known as the "pound a day" weight gain during their development process. Grumman monitored weight trades in X-29 development with mathematical precision. A company X-29 progress report noted in April 1982 that the then-current takeoff gross weight forecast for the X-29 was 17,067 pounds, a drop of 57 pounds from the previous month's tally. Weight losses achieved that month included a savings of 17.6 pounds realized by replacing some steel panels in the fighter F-5A forward fuselage with lighter aluminum panels that would meet the needs of the test bed X-29. Every pound matters, and engineers only reluctantly resorted to using ballast, if needed, to keep the X-29's center of gravity within design limits.⁷¹

Grumman's selection to build the FSW technology demonstrator had multiple underpinnings. Grumman's proposed aircraft was the least "fighter-like" of the three designs submitted, as their winning X-29 design carried no armament—not even hard points for carrying arms—and some observers believed this distanced the Grumman design from criticism that it was only a fighter proposal "in disguise" that the Air Force would have to fund or fight against. The Grumman proposal was also the most technically challenging, with its use of three primary flight control pitch surfaces and a high degree of instability.

The X-29's storied instability was about 35 percent at subsonic speeds. As explained by pilots Rogers Smith and Kurt Schroeder: "Subsonically... the aircraft's center of gravity is [located at] 35% of the mean aerodynamic chord (MAC), aft of the neutral point."⁷² Interestingly, this instability diminished with increasing airspeed until the X-29 was neutral to slightly stable at supersonic speeds. The subsonic instability could only be handled by flight control computers, Smith and Schroeder noted. "This level of instability translates into a divergence time to double amplitude on the order of... [as little as 0.12] seconds—an unprecedented level of instability for a manned aircraft.... Clearly, operation of the aircraft is dependent totally on the sophisticated full-authority, fly-by-wire flight control system. Containment of this extreme instability placed major design constraints on the flight control system. In fact, the flight control system was the pacing item in the development phase of this multi-technology aircraft."⁷³

The instability was not a product of the forward swept wing; earlier FSW aircraft had flown with only manual controls. Pilots Smith and Schroeder said: "The instability is caused by and controlled by the same control surface—the canard. The wing/body combination itself is neutrally stable. Because of these characteristics, the required variable incidence canard surface rates are within

Sweeping Forward

current state-of-the-art capabilities. Additionally, should the canard stall, the remaining control surfaces must only deal with the effects of a neutrally stable wing/body.⁷⁴ The original X-29 concept was projected to be only 20-percent unstable based on a canard sized to be 15 percent of the wing area. That size was not adequate to handle transonic maneuvers with reasonable surface rates, so the canard was resized to be 20 percent of the wing area. This had the additional effect of increasing instability to 35 percent.⁷⁵ The enlarged 20-percent canard size permitted the canards to be effective with motion rates that matched the capabilities of existing actuators.⁷⁶

To enable the X-29 flight control system to work as needed, traditional flight control system stability margins needed to be relaxed (to half normal margins). Smith and Schroeder said: “This compromise was justified in the context of this closely monitored flight test program.”⁷⁷ The subsonic instability caused by displaced center of gravity could not be altered readily. “It would take the equivalent of a Volkswagen (automobile) hanging from the noseboom to bring the subsonic configuration to a neutrally stable condition.”⁷⁸

Grumman’s X-29 and its proposal for the unmanned HiMAT test airframe were the first designs to use aeroelastically tailored composites, where layers of composite materials are oriented and built up specifically to accommodate load patterns on the wings. During construction of the X-29, Grumman demonstrated leadership in the use of composites.⁷⁹

Grumman used computational fluid dynamics (CFD) modeling to help verify the design of the two laterally mounted inlets that fed air to the single GE F404 engine of the X-29. This enabled performance estimates to be derived from fluid computer modeling at high angles of attack beyond the capabilities of some wind tunnels. The inlets on the X-29 needed to be able to serve the aircraft in low-speed, supersonic, and high-AoA (or “high alpha”) flight modes. Some air turbulence at the inlet lip at high AoA was smoothed by the length of the inlet duct, which promoted air mixing before reaching the engine.⁸⁰

Modern jet fighters rely on power to run systems vital to keeping the aircraft safely in flight. Loss of electrical power can be remedied temporarily by using an efficient emergency power unit (EPU) that burns hydrazine for fuel. Once the finite supply of hydrazine is exhausted, the pilot better have the aircraft safely on the ground—or be ready to eject immediately to save himself at the expense of his now functionally inoperative aircraft. But the extreme altitudes attainable by such jets can create an untenable situation where the aircraft cannot safely reach a landing before the hydrazine is depleted. This situation, unlikely as it may be statistically, is still very real in the performance envelopes of some operational aircraft. It also pertained to the X-29. One of the tradeoffs in making the X-29 a compact demonstrator was the lack of fuselage volume. The X-29’s amalgamation of components

The Background of the X-29

from other successful aircraft included the hydrazine system from the F-16, with its fuel tank shortened by 25 percent.

A background memorandum in the files of Air Force Flight Test Center (AFFTC) X-29 participant Lt. Col. Theodore “Ted” Wierzbanski highlighted the situation:

During the course of the X-29A flight test program there will be times, especially during expanded envelope (greater than .6M/30,000) flight test, when because of a limited hydrazine supply, certain catastrophic failures will preclude bringing the aircraft back to a landing. This has been known throughout the development of the X-29A, but because of the very low probability of these type[s] of failures, DARPA has agreed that this is an acceptable program risk. It in no way jeopardizes flight safety and pilot survivability since there is more than an adequate supply of hydrazine for the pilot to get the aircraft to acceptable ejection conditions.... However, because the X-29A is a valuable, one-of-a-kind, government asset, the project has determined that it would be prudent, when possible, to plan and attempt to execute flight test profiles which would allow aircraft recovery in the event of complete dependence on the EPU for flight.... [Mission rules in support of this included:] No procedure will be written which will subject the aircrew to a condition from which safe ejection is not possible. Anytime it is determined, for whatever reason (hydrazine quantity low, deteriorating systems, lack of range, etc.), that ejection may be required, the first course of action will be to put the aircraft in a flight condition where ejection is possible in the event of total system failure. This may require slowing the aircraft to approximately 165 KIAS [knots indicated airspeed] and preclude recovery of the aircraft, even though a suitable landing site is within gliding range at a higher airspeed... [Alternate landing sites included Mojave airport, and Cuddeback, Three Sisters, and Harper dry lakes] using a straight-in approach and a windmilling engine.⁸¹

Planners did not even consider the higher drag of a locked rotor causing a frozen engine, calling this type of engine failure so unlikely “that it was not rational to plan for such an occurrence.”⁸²

Another potentially lethal issue discussed before first flight of the X-29 was a complete loss of hydraulic power. Grumman examined scenarios in which hydraulic power could be lost and how long it would take for this to incapacitate the aircraft. The pilot’s physical ability to eject was taken into account by

Sweeping Forward

Grumman: “It is estimated that the pilot can no longer operate the seat ejection mechanism above 6gs [acceleration of gravity] at the cockpit. Therefore the time to reach 6gs is a function of the maneuver conditions at the time of the (hydraulic) accumulator exhaustion.”⁸³ In some conditions, this could be less than half a second. So the usable time an X-29 pilot could expect to have to respond to a hydraulic failure “is the sum of the time to bleed off the accumulator pressure and time to diverge to 6gs. Thus if we add the accumulator exhaustion time of 3 to 6 seconds to the time to 6gs of .4 to 1.7 seconds, the pilot can expect 3.4 to 7.7 seconds for decision and reaction time to safely exit the aircraft if the speed is high enough to attain 6gs.”⁸⁴ That 3-to-6-second window of time before the critical canards no longer had hydraulic functionality was a best guess since actual flight conditions would drive how active the canards were at any moment. Some flight conditions were not capable of producing 6 g divergence, to the advantage of the pilot. Grumman noted: “[W]e find that at speeds below 224 KEAS [Knots Equivalent Airspeed] the pilot will not experience 6gs at the cockpit resulting in additional time for egress. Therefore after the first failure, pilot safety can be increased and egress time increased by slowing down to below 224 knots.”⁸⁵

The X-29’s relaxed static stability, made possible by its quick-reacting DFBW controls, gave the X-29 less drag than that produced by a traditional airframe. The pitch canards shared lift, not downward force, and the X-29 was considered to be 35-percent unstable, described in the terminology as relaxed static stability. A positively stable aircraft tends to remain in straight and level flight when control inputs are not being made—not so, the X-29. The DFBW system provided artificial stability. Much like the unconscious muscle motor movements of a soaring bird in flight as it seems to effortlessly remain stable, the X-29’s DFBW system continuously sent commands to the aircraft’s controls up to 40 times a second to keep it in stable flight. Then, when the pilot made deliberate control inputs, the three computers instantaneously computed the amount of control-surface deflection required to accomplish the maneuver based on aircraft speed, altitude, and other sensible parameters. The triply redundant DFBW system and its triple analog computer backups each could operate with only two computers functional. The risk of a complete computer control failure in the X-29 was described by NASA as “less than the risk of incurring a mechanical failure in a conventional system.”⁸⁶

Nonetheless, the rigors of exploring the X-29’s very demanding flight regime led to the comprehension of a potential flight control system vulnerability early in the program, involving the possibility of simultaneous dual-null failures of two of the three pitch-rate gyros. As explained by NASA X-29 pilot Rogers Smith: “If such a highly improbable failure...occurred, as soon as the pilot commanded a pitch rate greater than the detection threshold, the remaining

The Background of the X-29

‘good’ gyro (there are three primary gyros) would be declared failed”⁸⁷ because the other two bad gyros would be incorrectly assumed to be correct in the FCS voting scheme. “One of the three backup gyros would be brought in to replace the ‘good’ gyro and it would be promptly thrown out by the system logic. In a few cycle times (each 1/40 of a second) all the ‘good’ pitch gyros would be eliminated and the highly unstable X-29 would very rapidly depart (and likely break up in flight).”⁸⁸

The X-29 test team concluded that the possibility of simultaneous dual pitch gyro failures was so unlikely that it was a risk the program could live with. Additionally, the test team required that a dedicated test engineer monitor the health of the rate gyros in the control room at all times. On flight 23 with pilot Kurt Schroeder, alert control room observers detected an anomaly in lateral axis control—important, but not as crucial as the unstable pitch control. By asking pilot Schroeder to perform a lateral control input, the control room observers thereby prompted the onboard computer system to recognize that one lateral gyro had failed. The system worked as designed, and this faulty gyro was taken offline and automatically replaced with a working spare. Schroeder returned to land uneventfully. This gave the X-29 team confidence, and Smith noted: “with careful monitoring in the control room we felt we could detect the first ‘null’ failure and, as in Kurt’s flight, request an immediate input from the pilot.... The real problem would be dual, simultaneous, pitch gyro null failures. That event was considered to be sufficiently improbable to take the risk. Our action was to closely monitor the gyros in the control room (special monitoring data) and catch the first one and immediately take action, as in Kurt’s case, and eliminate the faulty gyro (actually replace it with one of the three secondary gyros).”⁸⁹

The X-29 program relied on the fundamental safety and redundancy built into the aircraft’s computerized flight control system. Some potential failures, like the dual-null pitch-rate gyro issue, were calculated as too unlikely to pose a real threat. Other situations were simply to be avoided, recalled software engineer Joel Sitz. An example was the situation in which the airplane’s computer gains would adjust catastrophically in the event that the pilot extended the landing gear while the aircraft was inverted in close proximity to the ground. Loss of control was the expected result of such a maneuver—yet its simple avoidance was its cure.⁹⁰ Air Force X-29 project pilot Lt. Col. Theodore “Ted” Wierzbowski provided an eloquent description of the X-29’s maneuvering mechanics:

The X-29...has three pitch control surfaces, versus the classical one [elevators]. It has the canard, it has full span elevons, and it has a strake flap in the back. What that means is that, simply, we use those surfaces to trim the system—the aircraft system—to optimum trim.

Sweeping Forward

Not just the wing, but the whole aircraft body so that it is at its optimum drag using those three surfaces. You've got strake flaps in the back, full span elevons that act differentially as ailerons and symmetrically as elevons and the canard. So basically, when I tell PacMan, the computer, [a reference to the X-29's computer flight control system as an early-generation computer game] that I want to go this way—I want to go up—I put the command in through the stick which tells the computer what I want. The computer says “he wants to go that way; let's go unstable that way” and the airplane goes unstable that way. It [the flight control system] then says “he's unstable but he only wants to go so far.” The canard then goes the other way, stops the airplane (in pitch) and starts balancing. The entire system, in fact all three pitch surfaces, start the airplane to go the way you want but then after you get to where you want to be, a command of G for instance, the airplane then says “aha! What's my altitude? What's my airspeed? What's my G?” Then it goes to a table in the computer that says for this altitude, this airspeed, this G, optimum trim for this system is canards here, strake flap here, elevon here, and then it drives these control surfaces to these positions for optimum trim. The aircraft also has a variable camber mode for the wing. To go from variable camber to set camber could mean (in the 90 percent power regime—which is where you develop your most thrust) a five percent increment on thrust RPMs [revolutions per minute]. This is a significant amount of thrust which means it really is a significant amount of drag that you're reducing by trimming the airplane or trimming the system.⁹¹

Even a seemingly rigid aircraft like the X-29 undergoes some flexing during flight. Movements within the fuselage structure of the X-29 were mapped carefully and were understood before first flight. With its highly sensitive computer flight control system commanding deflection of three separate pitch control surfaces, the X-29 depended on pitch-rate gyroscopes for stability. Grumman engineers knew where fuselage pitch nodes and antinodes occurred on the X-29. At a node point, erroneous pitch information could confuse the flight control system's pitch-rate gyros by imparting a different pitch-rate indication than the whole aircraft was actually experiencing at that moment in flight. Wierzbanski explained: “It wouldn't have given a true pitch rate, so the airplane would have gone crazy.”⁹²

At an antinode site, the airframe only transmitted vertical movement, not pitch. For this reason it was necessary to mount the pitch-rate gyros on an antinode point for accurate input to the flight control system. A desirable antinode

The Background of the X-29

occurred at a fuselage bulkhead where the canards mounted to the airframe, but during ground vibration tests, the constant canard activity proved detrimental to the pitch-rate gyros' performance. Another antinode location beneath the cockpit was chosen for the pitch-rate gyros, but the closely packed contents of the X-29 fuselage did not permit the gyros to be fully contained within the fuselage contours. The final solution was to mount the pitch-rate gyros at this crowded antinode, where they protruded outside the fuselage. A fairing provided some streamlining and bird-strike protection, Wierzbanski recalled. But the ventral protrusion of the pitch-rate gyros often generated questions from visitors who wondered what the bump was for.⁹³

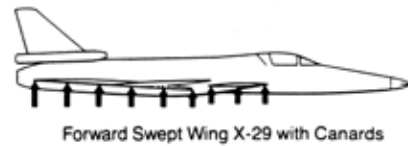
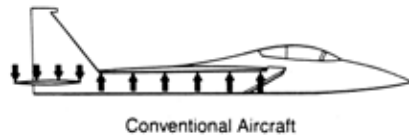

Unlike the conventional F-15 (top), which had to have a download on its horizontal tail to balance the wing's lift, the statically unstable DFBW X-29 had uploads on its canards and wing, thus minimizing its trim drag. (NASA)

A fairing provided some streamlining and bird-strike protection, Wierzbanski recalled. But the ventral protrusion of the pitch-rate gyros often generated questions from visitors who wondered what the bump was for.⁹³

Keith Wilkinson was Grumman's lead aeroelastician early in the company's development of FSW capability. In 2011, he recalled the pitch-rate-gyro problem and solution:

A somewhat unexpected fallout of the X-29 program, during the detailed design phase, was the considerable amount of time that had to be devoted to the avoidance of aeroservoelastic instabilities, in which aircraft flight sensors (e.g., rate gyros, accelerometers) detect airframe dynamic response, feed the signal to the flight control actuators, and create an airframe instability. At this point in time, the SAEL program was fully operational for these analyses. The unexpected extent of the effort was largely attributable to the multiple X-29 flight control system modes (basic digital, digital reversion, analog reversion for both the longitudinal and lateral directional modes) that had to be investigated. It was this extensive analytical effort, in conjunction with a very well-planned ground test validation program, prior to flight, that resulted in the most trouble-free flight test program I have ever experienced.⁹⁴

Wilkinson related his work with the pitch-rate-gyro bulkhead issue:

Because of our well planned ground test validation program at Bethpage, New York, during which the aircraft had extensive

Sweeping Forward



The spin-parachute installation on the second Grumman X-29 aircraft, 1989. Note as well the stylized and controversial “NASA worm” on the vertical fin, which was a source of annoyance for veteran NASA traditionalists. (NASA)

instrumentation, we recognized that the measured pitch rate gyro response during canard frequency sweeps was well above our predictions. On further investigation it became clear that the pitch rate gyro, which was mounted to the canard actuator support bulkhead, was registering erroneous pitch rate response due to bulkhead flexing. In relocating the pitch rate gyro to an optimum location it became clear that the interior real estate was fully occupied, so the bump that can be seen in the lower fuselage is the relocated external pitch rate gyro location.⁹⁵

The X-29’s flight envelope included a maximum operating altitude of 50,000 feet and a top speed of Mach 1.6. With no provisions for aerial refueling or external fuel tanks, flight endurance was about one hour. (The longest flight lasted 1½ hour at subsonic speeds and was flown by NASA’s Rogers Smith on November 27, 1985).⁹⁶

Fuel capacity limited flying time, which lengthened overall test-program time. The ability to refuel in flight would have enabled longer missions in which more test data points were collected more efficiently than by descending, landing, servicing the airplane, and taking off again to climb to test altitude. The

The Background of the X-29

decision to build the X-29 without aerial refueling capability was made early. Just as the X-29 was not intended to carry weapons, some in the Air Force presumed it would not benefit from aerial refueling, which was estimated to add about \$1 million to the cost of the aircraft. The longer schedule required to test a nonaerial-refueled X-29 could equate to a half-million dollars each month in overhead paid for Grumman engineering staff, Wierzbowski explained. Plausibly, 8 months of X-29 testing could be accomplished in 6 months with aerial refueling, thereby paying back the initial investment. This was a key lesson learned with the X-29 that the AFFTC team members shared with other test aircraft design teams in an effort to get aerial refueling capability built into other experimental aircraft, like the Lockheed YF-22A and Northrop YF-23A Advanced Tactical Fighter (ATF) prototypes—and it was.⁹⁷

The main difference between the two X-29s was the installation of a spin-parachute device above the exhaust and at the base of the rudder on the number two aircraft. The forecast controllability at high angles of attack was borne out to 45 degrees during the X-29 research program.⁹⁸

Endnotes

1. Dan Sharpes, "Forward Sweep Aircraft in Europe," *AIAA Newsletter, Dayton-Cincinnati Section* 14, no. 2 (March 1986), Wierzbanski X-29 papers and general X-29 files, Air Force Test Center History Office, Edwards AFB, CA.
2. William Green, *Warplanes of the Third Reich* (Garden City, NY: Doubleday, 1970).
3. Ibid.
4. Ibid.
5. Dr. Courtland Perkins, "Recollections—Chapter 5—Wright Field & Aircraft Laboratory—World War II, 1941–1945," manuscript pages, Wierzbanski X-29 papers and general X-29 files, Air Force Test Center History Office.
6. Ibid.
7. Ibid.
8. Ibid.
9. Frederick A. Johnsen, *North American P-51 Mustang, Warbird Tech*, vol. 5 (North Branch, MN: Specialty Press, 1996).
10. Emiel Slood, "Hansa Jet Retirement," *Air International* 47, no. 4 (October 1994): 234–235; Sharpes, "Forward Sweep Aircraft in Europe."
11. Dr. Norris J. Krone, Jr., interview by Frederick A. Johnsen, June 1, 2011.
12. Ibid.
13. Ibid.
14. Ibid.
15. Ibid.
16. Dr. Norris J. Krone, Jr., interview by Frederick A. Johnsen, September 14, 2011.
17. Norris J. Krone, Jr., "Divergence Elimination with Advanced Composites," American Institute for Aeronautics and Astronautics (AIAA) Paper 75-1009 (1975).
18. Ibid.
19. Ibid.
20. Ibid.
21. Ibid.
22. Ibid.
23. Ibid.
24. Ibid.
25. Ibid.

The Background of the X-29

26. Ibid.
27. Dr. Norris J. Krone, Jr., interview by Frederick A. Johnsen, October 4, 2011.
28. Dr. Norris J. Krone, Jr., e-mail message to Frederick A. Johnsen, October 16, 2011.
29. G.C. Uhuad, T.M. Weeks, and R. Large, "Wind Tunnel Investigation of the Transonic Aerodynamic Characteristics of Forward Sweptwings," *Journal of Aircraft* 20, no. 3 (March 1983).
30. Ben Kocivar, "Wrong-Way Wings," *Popular Science* (April 1980).
31. "Fact Sheets: X-29," NASA Website, last modified December 16, 2009.
32. James Allburn, interview by Frederick A. Johnsen, October 20, 2011.
33. Ibid.
34. Glenn Spacht, interview by Frederick A. Johnsen, October 24, 2011.
35. Ibid.
36. Ibid.
37. Grumman Aerospace Corp. (GAC), "X-29A Advanced Technology Demonstrator R&D Status Report No. 7, 15 June 1982 to 15 July 1982," GAC Report No. 712/670-PGM-RPT-82-002, approved: Glenn L. Spacht, Wierzbowski X-29 papers and general X-29 files, Air Force Test Center History Office.
38. Rogers Smith, e-mail message to Richard Hallion, January 12, 2012.
39. Ibid.
40. G. Spacht, Grumman Memorandum, "Subj: Analysis of LRC 8 Foot Transonic Pressure Tunnel HiMAT K Wing Test Results" (April 27, 1976), Wierzbowski X-29 papers and general X-29 files, Air Force Test Center History Office.
41. Ibid.
42. Spacht, interview, October 24, 2011.
43. Ibid.
44. Ibid.
45. Glenn Spacht, John Calandra, Mike Moore, Tom Taglarine, Jimmie Chin, Keith Wilkinson, Douglas Frei, Arnold Whitaker, and Edward Laurie (Grumman Aircraft Systems Division), "Unusual Aerodynamics of X-29," *Aerospace America* (February 1986).
46. Spacht, interview, October 24, 2011.
47. Ibid.
48. Ibid.
49. Keith Wilkinson, e-mail message to Frederick A. Johnsen, October 22, 2011.

Sweeping Forward

50. NASA Fact Sheet, "X-29," Ames-Dryden Flight Research Facility, release no. 85-3A (March 15, 1985).
51. Gary A. Trippensee and David P. Lux, "X-29A Forward-Swept-Wing Flight Research Program Status," NASA Technical Memorandum (TM) 100413 (November 1987).
52. NASA Fact Sheet, "X-29."
53. Rogers E. Smith and Kurt C. Schroeder, "Flight Testing the X-29," NASA document ID 19870060567, Society of Experimental Test Pilots (SETP) 1986 Report to the Aerospace Profession—30th Symposium Proceedings (September 24–27, 1986).
54. Stanley R. Cole, Thomas E. Noll, and Boyd Perry III, "Transonic Dynamics Tunnel Aeroelastic Testing in Support of Aircraft Development," *Journal of Aircraft* 40, no. 5 (September–October 2003).
55. John W. Hicks, James M. Cooper, Jr., and Walter J. Sefic, "Flight Test Techniques for the X-29A Aircraft," NASA TM 88289 (1987).
56. Lawrence S. Schuster and William A. Lokos, "Current Flight Test Experience Related to Structural Divergence of Forward Sweptwings," NASA TM 100445 (August 1988).
57. Ibid.
58. Ibid.
59. Ibid.
60. Ibid.
61. Ibid.
62. NASA Fact Sheet, "X-29."
63. Spacht et al., "Unusual Aerodynamics of X-29."
64. NASA Fact Sheet, "X-29."
65. Spacht et al., "Unusual Aerodynamics of X-29."
66. Col. James N. Allburn, Lt. Col. John P. Retelle, Jr., Norris J. Krone, and William E. Lamar, "X-29 Revives the Experimental Aircraft," *Aerospace America* (February 1986), Wierzbanski X-29 papers and general X-29 files, Air Force Test Center History Office.
67. Keith Wilkinson e-mail message to Frederick A. Johnsen, October 26, 2011.
68. GAC, "X-29A Advanced Technology Demonstrator."
69. Lt. Col. Philip W. Bruce (USAF, Program Manager, X-29 ADPO), memorandum, "Subj: X-29 Program Status, Mar. 14, 83," Wierzbanski X-29 papers and general X-29 files, Air Force Test Center History Office.
70. Ibid.
71. J. Calandra (Engineer Manager, X-29A) to R. Roemer/G. Spacht, Grumman Engineering Status Report, "X-29A Program—March

The Background of the X-29

- 1982,” Wierzbowski X-29 papers and general X-29 files, Air Force Test Center History Office.
72. Smith and Schroeder, “Flight Testing the X-29.”
 73. Ibid.
 74. Ibid.
 75. Ibid.
 76. Spacht et al., “Unusual Aerodynamics of X-29.”
 77. Smith and Schroeder, “Flight Testing the X-29.”
 78. Ibid.
 79. Lt. Col. Theodore Wierzbowski, interview by Richard P. Hallion, Air Force Flight Test Center, circa November 1984.
 80. R.H. Tindell and W.G. Hill, Jr., Grumman Corporation, Bethpage, NY, “CFD Analysis of the X-29 Inlet at High Angle of Attack,” *Journal of Aircraft* 30, no. 4 (July–August 1993).
 81. Anon., memorandum, “Aircraft Emergency Recovery,” undated, Wierzbowski X-29 papers and general X-29 files, Air Force Test Center History Office.
 82. Ibid.
 83. A. Whitaker, memorandum, “Subj: X-29 Egress Envelope Conditions When Complete Loss of Hydraulics has Occurred,” GAC (November 8, 1984), Wierzbowski X-29 papers and general X-29 files, Air Force Test Center History Office.
 84. Ibid.
 85. Ibid.
 86. NASA Fact Sheet, “X-29.”
 87. Smith, e-mail message to Hallion.
 88. Ibid.
 89. Rogers Smith, e-mail message to Frederick A. Johnsen, January 31, 2012.
 90. Joel Sitz, interview by Frederick A. Johnsen, February 3, 2012.
 91. Wierzbowski, interview by Hallion.
 92. Theodore Wierzbowski, interview by Frederick A. Johnsen, Anaheim, CA, September 24, 2011.
 93. Ibid.
 94. Wilkinson, e-mail message to Johnsen, October 22, 2011.
 95. Ibid.
 96. “X-29 aircraft No. 1 flight log,” Wierzbowski X-29 papers and general X-29 files, Air Force Test Center History Office.
 97. Wierzbowski, interview by Hallion.
 98. NASA Fact Sheet, “X-29.”



The first Grumman X-29A FSW demonstrator in flight over the Edwards range, 1985. (NASA)

CHAPTER 2

From Concept to Flightline

The X-29 was a research aircraft that demonstrated numerous advanced technologies that might find practical application in future fighter aircraft. Its development and testing intersected with the interests and capabilities of three Federal organizations. Funding of \$87 million came from the DARPA. With these funds, the Air Force procured two X-29 aircraft from Grumman Aerospace Corp. (GAC), which conducted four acceptance flights before releasing the jets to the Government. NASA managed and conducted the X-29 flight research program at what was then the Ames-Dryden Flight Research Facility (ADFRF) (now called the Dryden Flight Research Center) on Edwards Air Force Base in California.¹ The NASA role was as Responsible Test Organization (RTO), and the Air Force Flight Test Center functioned as a Participating Test Organization (PTO), with DARPA funding. Overall, X-29 program management was the responsibility of the Air Force Wright Aeronautical Laboratories (AFWAL), part of Aeronautical Systems Division (ASD) at Wright-Patterson AFB, OH.

At Wright-Patterson, a model X-29A underwent testing in a 5-foot wind tunnel that was a landmark in tunnel development when new—in 1922! Still a viable research tool in the age of FSW technology, the 5-foot tunnel (designating the diameter at the test section where the model is mounted) was designated a National Historic Mechanical Engineering Landmark by the American Society of Mechanical Engineers in 1992.²

Many pilots eventually flew one or both of the single-seat X-29s. At the outset of the program, Grumman assigned Charles “Chuck” Sewell, a Marine Corps combat veteran and highly experienced fighter test pilot, as their chief X-29 pilot, along with Navy veteran Kurt Schroeder, another distinguished naval aviator. Stephen D. Ishmael, who had flown as an Air Force Reservist, was NASA’s X-29 project pilot. NASA research pilot Rogers Smith, who had flown fighters with the Canadian Air Force and was currently also a fighter pilot with the USAF-Air National Guard (ANG), was assigned as co-project pilot. The Air Force Flight Test Center’s X-29A first project manager and pilot

Sweeping Forward



Four X-29 milestone makers (left to right): Ted Wierzbanski (1st USAF flight), Rogers Smith (longest duration flight), Chuck Sewell (first flight of X-29 aircraft), and Steve Ishmael (100th X-29 flight). (NASA)

was Maj. Theodore J. “Ted” Wierzbanski, a veteran fighter test pilot known to his fellow airmen as “W+12.”³

Aware of the multiagency nature of the X-29 program, Wierzbanski contemplated how to achieve the best working relationships among the partners. He availed himself of the corporate memory in the AFFTC History Office and inquired about previous multiagency research programs and how they had fared. The legendary X-15 program spanning the decade of the 1960s, and the X-24 program somewhat later, were prime examples of highly productive NASA-USAF cooperative efforts. The three-aircraft X-15 program had yielded a remarkable 199 flights between 1959 and 1969, with useful and varied data flowing from the effort. Ultimately, the X-29 would accomplish even more research flights than did the X-15. At least one veteran of X-15 research, engineer Robert Hoey, served the Air Force’s X-29 interests as well.⁴

Ted Wierzbanski preserved in his extensive X-29 files copies of correspondence between Air Force leadership and Hugh L. Dryden, NASA Deputy Administrator and later the namesake for the Dryden Flight Research Center, from 1961 when they were creating the collaborative process for the X-15 that would later influence the X-29 multiagency organization. The X-15

memorandum signed by NASA, the Air Force, and the Navy characterized the importance of such research: “The X-15 is a program of national importance undertaken in accordance with the terms of a Memorandum of Understanding dated 28 December 1954 among the Department of the Air Force, Department of the Navy, and the NACA (now the NASA). It is recognized that the X-15 flight research program will soon complete the initial phase of flight research.... It is necessary that an optimum follow-on research program be formulated to insure that maximum benefit to the national objectives accrue from the research program.”⁵ The concept of national objectives overriding any one organization’s interests is perhaps the truest test of a program’s ultimate value. (Semanticists will also note Hugh Dryden’s use of “the” in front of NASA, perhaps a holdover from the way “the NACA” was always phrased; later, NASA would become a universally recognized standalone phonetic acronym).

Gremlins from the ongoing multiagency Advanced Fighter Technology Integration (AFTI) program were dealt with before the X-29 flew, to avoid reliving those experiences. Even as the X-29 was being built, it was apparent to Ted Wierzbowski that “DARPA and the ADPO and no one, really, had come out with any firm specific objectives for the program. *Why* did we build the airplane?”⁶ Of course, everyone understood the promise of the X-29 and savored its impending availability, but its testing priorities had not been codified or ranked before first flight. This reminded Wierzbowski of another common AFTI experience in which interested Air Force parties at Wright-Patterson might tell their AFFTC counterpart to change an upcoming test priority without coordinating with AFTI’s other partner, Dryden. Wierzbowski determined that the X-29 program, fortunately, would not operate that way because “we do have an outstanding working relationship with the NASA folks.”⁷ Again, lessons—some hard-learned—from past cooperative Air Force–NASA programs at Edwards helped steer and inform the X-29 effort.

Wierzbowski understood that the joint venture represented by the X-29 could become mired in misunderstanding if roles and responsibilities were not well defined and understood by all. As he was working to insert the AFFTC into the X-29 program, Wierzbowski was aware of procedural difficulties experienced by Air Force and NASA partners on the AFTI F-16 program. Until resolved, AFTI F-16 labored under duplicative flight readiness review (FRR) processes in which either the Air Force or NASA could unilaterally declare the aircraft unready to fly. The eventual outcome—giving NASA overall AFTI F-16 FRR responsibility, with AFFTC participation at a level lower than show-stopping, would also work for the X-29 once the airplane was loaned to NASA following completion of the first four flights by the contractor. Those initial contractor flights would be made with the FRR, including safety, handled by the Air Force Flight Dynamics Laboratory process.⁸ Detailed exploration of

Sweeping Forward

several defining Memorandum of Agreement documents that codified roles and responsibilities for X-29 partners is covered later in this narrative.

Interestingly, as the X-15 program was winding down in 1968, NASA recast its role in aeronautics to accommodate more immediate problems and breakthroughs that could benefit American civil and military aviation. A decade later, as X-29 was taking shape, the new NASA model seemed a good fit.⁹

Chief NASA X-29 pilot Stephen D. Ishmael and Wierzbowski jointly wrote a background paper on the X-29 in 1985, after flights had been made but before the program concluded its original goals. Their succinct encapsulation of the program's marching order was: "The overall objective for the X-29 Advanced Technology Demonstrator Program is to validate, evaluate, and quantify (where possible) advances in integrated aerodynamic, structural, and flight control technologies so they can be made available as design options for future aircraft."¹⁰

Grumman Aerospace Corporation was an interested partner on more than one level. Designing, building, and delivering the X-29 to the Air Force for loan to NASA was one level of effort. But observers believed Grumman wisely saw the X-29 technology demonstrator as an opportune vector into the world of Air Force test and development largely untapped by Grumman, known for decades as a prime builder of naval aircraft.

The X-29 contract was created in an era of fixed-price Government contracts that were viewed by some as a necessary bulwark against headline-making cost overruns. But as several aircraft development programs were to show, a fixed-price contract creates a daunting gamble for the contractor, who must make up for cost overruns out of company coffers. With the X-29, delays caused by difficulties in developing the remarkable computer flight control system extended Grumman's obligation before turning the aircraft over to the Air Force, and this increased Grumman's out-of-pocket costs. The fixed-price contract called for the first four flights to be made by Grumman pilots, after which the aircraft was to be handed over to the Air Force, and Grumman's original contractual obligations (except for follow-on support of the program) would be concluded. It was in Grumman's interest to execute four flights as quickly as possible, thereby completing the fixed-price contract so that Grumman could continue X-29 support under a more lucrative cost-plus contract. But before first flight, the Air Force's Advanced Development Projects Office (ADPO) showed concern that not all functional aircraft checks would be finished after four takeoffs and landings and that, possibly, the contractor would be off the hook after technically completing four flights even if issues remained with the aircraft. Lt. Col. Wierzbowski summed up the debate over what constitutes a flight: "Is it a test card completion or is it a takeoff and landing?"¹¹ NASA, as the RTO, took a firm stand that four flights meant takeoff to landing regardless

of test point accomplishment. Wierzbanski said NASA's stance "has nothing to do with piloting. It has to do with who's controlling the program. NASA's lending their facilities to a contractor to fly."¹² And NASA, understandably, did not want to have a contractor-controlled initial flight program using NASA premises beyond the contractual first four flights. Ultimately, the X-29 was signed off and handed to the Air Force, to be lent to NASA, after four flights by Grumman pilots.

Where to Test?

Flying X-aircraft at bases other than Edwards had long been contemplated for many different programs (back to the original Bell XS-1, intended at first to be flown at Langley Field), but in almost all cases, planners have ultimately opted for the safety of the High Desert. In this regard, the X-29 was to prove no exception to this legacy. The different entities comprising the X-29 test team were ultimately cooperative and collaborative, if the team was occasionally infused with a dynamic tension typical of any amalgamation of such diverse interests. To NASA's surprise, Grumman made an unsolicited proposal to DARPA calling for conducting the first portion of X-29 flight testing at Grumman Calverton in New York.¹³

Grumman proposed in August 1982 to conduct a 20-month X-29 flight-test program at Calverton, starting with four functional flights, 59 envelope expansion sorties, and performance reporting. The nascent X-29 program, already framed as a multitechnology demonstration effort that could inform future production aircraft designs, could not operate in a vacuum. Already on the horizon was the Air Force's ATF quest as well as a Navy future fighter. If some observers believed that NASA's handling of the X-29 as a pure research vehicle could lead to a longer wait for results, Grumman demonstrated eagerness in 1982 to accelerate the program. The Grumman argument was succinct and optimistic: "The program has as its objective the improvement of aerodynamic, structural and system design technologies to satisfy the demanding performance requirements of future tactical and strategic aircraft.... The value of these new technologies is a function of its timeliness in relationship to the technology availability dates of the next generation advanced aircraft as well as its technical merit. The X-29's innovations must be flight demonstrated in the minimum time, so that introduction of these concepts to future weapons systems can be effected rapidly."¹⁴

Grumman described the ticking clock of technology that faced the still unflown X-29 in the company's August 1982 proposal to conduct more flight research at Calverton:

Sweeping Forward

Current planning schedules for the Air Force Advanced Tactical Fighter (ATF) and Navy Advanced Fighter/Attack Aircraft (VFMX) programs indicate that a Technology Availability Date (TAD) for major configuration items on both programs is about January 1985. This date represents the start of the validation point design studies for ATF with an IOC [Initial Operational Capability] of 1993 and the start of conceptual studies for VFMX with an IOC of 1996. The January 1985 TAD dates make it evident that initial X-29 flight test results should be available within 11 months after first flight for the information to be useful for these programs. Thus, for the X-29 demonstration program to be most effective for ATF/VFMX, a reasonably high X-29 development program flight rate combined with a rapid dissemination of meaningful quantitative flight test answers is required.¹⁵

Grumman's 1982 test proposal was premised on a 28-week flight-test program with a projected sortie rate of nine flights per month. Grumman said their confidence was

Made possible by use of the Grumman Flight Test System featuring the Automated Telemetry System (ATS) with the most sophisticated Real Time advanced test data analysis software in the industry and uncongested dedicated test ranges. In addition, multiple shift operation in the areas of aircraft maintenance and data reduction enhances the achievement of the programmed high-fly rate. Integrating designated Government personnel into the Grumman test team will provide the additional benefit of assuring trained personnel when the Government team assumes flight test of the X-29.¹⁶

Grumman's ability to conduct nine X-29 flights per month at Calverton needed to remain an academic exercise since the company did not win its bid to do this testing, as it was unacceptable to NASA. The flight log for the original X-29A-1 aircraft shows it first achieved nine missions a month in July 1986 when a well-experienced X-29 team produced 11 flights. Some subsequent months had mission tallies into the teens, but large flight gaps between these months lowered the overall average to around five X-29A-1 missions per month between first flight in December 1984 and this aircraft's last test mission in December 1988.

Not factored into Grumman's August 1982 flight-test proposal was the subsequent need to extend X-29 development time that ultimately placed first

flight date at December 14, 1984, which was nearly 2 months later than the date the 1982 Grumman proposal set for the completion of its own 59-flight envelope expansion phase at Calverton. Grumman is not alone among aircraft manufacturers who have made ambitious, optimistic flight-test schedules for new aircraft. Industry observers have sometimes argued that Government gets in its own way during flight test, prolonging its duration; Government flight testers have countered, saying the industry, rightly proud of its capabilities, sometimes underestimates or diminishes potential obstacles to ambitious test schedule completion.

As early as June 1982, DARPA sought ways to accelerate the scheduled X-29 envelope expansion flight-test phase faster than the timetable embraced by NASA. A memorandum by Ted Wierzbanski describing meetings held June 8 and 9 at Wright-Patterson AFB detailed the situation regarding accelerated technology transfer:

The DARPA objective for the X-29A program is to “build and flight test a manned demonstrator to validate and develop confidence in the FSW concept and related advanced technologies so that they may be considered viable design options for future military aircraft”. Because of this, DARPA is interested in accelerating the flight test of the X-29A so that a determination can be made as to the practicality and desirability of the various X-29A advanced technologies in time to be an input into the design of the Advanced Tactical Fighter (ATF). The proposed NASA 18-month envelope expansion (50 flights) has caused concern for DARPA in that they feel that this extended flight test program will preclude any significant transfer of X-29A advanced technologies into the ATF design process. In order to accelerate this technology transfer, DARPA is considering several alternatives. One solution DARPA is considering is to fund a Grumman flight test program to be flown out of the Grumman flight test facility in New York. Grumman will be submitting an unsolicited proposal for this effort (50-flight envelope expansion) which they feel they can accomplish in six months.¹⁷

Wierzbanski offered an alternative flight-test methodology that would insert, within the framework of Dryden’s envelope expansion at Edwards AFB, a concurrent flight evaluation of those new technologies that could be accommodated in this dual manner.

Nor was Grumman the only participant interested in conducting X-29A flight research at a location other than Dryden-Edwards AFB. During this same

Sweeping Forward

period in 1982, the commander of the Naval Air Test Center (NATC) proposed conducting the entire X-29A flight-test program at NATC's Patuxent River, MD, test facilities.¹⁸ The Navy's offer did not gain traction, largely because Edwards had much better range, safety, and weather advantages. In September 1982, the Air Force Wright Aeronautical Laboratories weather staff studied climatic conditions expected at Edwards Air Force Base and at Grumman's Calverton, NY, location. Using available data from nearby John F. Kennedy International Airport (JFK) to represent Calverton, the Air Force study predicted that the percentage of the year in which Edwards AFB would have visibility equal to or greater than 3 miles, and/or ceilings greater than or equal to 50,000 feet, was 84 percent, compared to only 47 percent at Calverton. Turbulence and wind shear were a problem at Calverton 52 percent of the time; at Edwards, it was only 37 percent of the time. But Edwards's crosswinds equal to or greater than 15 knots were predicted 6.64 percent of the time, compared with a lesser figure of only 5 percent at Calverton. Ultimately, only Edwards AFB would host X-29 test flights, and not Grumman at Calverton, or "Pax" River.¹⁹

In January 1983, DARPA broached a plan to have Grumman conduct the first four company flights of the X-29 at Calverton with the remainder of the program operating from NASA's Dryden facility on Edwards Air Force Base. NASA X-29 management balked, and the Air Force Flight Test Center team declined to be involved in sending a team to Grumman's test location. After all, the collocated NASA Ames-Dryden Flight Research Facility and Air Force Flight Test Center at Edwards AFB were where appropriate Government flight testing was conducted, with a robust infrastructure to support it. AFFTC X-29 program manager Wierzbowski took a philosophical approach to the Grumman test proposal. While the proposal was unsupportable from an Air Force and NASA standpoint, Wierzbowski understood Grumman's desire to keep its company test facilities and staff busy. He also had reason to believe Grumman decision makers underestimated the facilities available at Edwards. Wierzbowski took a Grumman official to see the smooth merge between the paved runway at Edwards and the hardened playa of the vast dry lakebed to quash a bizarre rumor that there was an 18-foot dropoff from the pavement to the lakebed. In fact, some test aircraft had made the transition from pavement to lakebed when brakes had failed. The demonstration of Edwards Air Force Base's actual capabilities and facilities effectively put an end to the discussion of testing at Calverton. Resolution of this issue helped strengthen the position of Edwards and Dryden as test facilities.²⁰ Ted Wierzbowski also believed that there was an upside for Grumman to test at Edwards Air Force Base. The opportunity for Grumman to get immersed in the Air Force Flight Test Center way of flight testing could help the company in its future work with the Air Force.²¹

Structuring Institutional Relationships and Program Focus

As issues of roles and responsibilities among the X-29 participants were distilling, the nature of the program best fit the combined test force (CTF) model, which accommodated Grumman as an ongoing participant beyond delivery of the aircraft after the first four flights by company pilots. As Wierzbanski described it in a 1984 interview before first flight had occurred: "NASA is still the RTO. NASA will be running the show; however, we'll have significant contractor participation...engineering- and pilot-wise."²² This combined test force was initially envisioned to be in place 4 or 5 months into flights, until delivery of the fully capable flight control system. (Initial flight control software could not accommodate upper speed ranges in some backup conditions without changing gain on the software; fixed gain in a backup mode limited the speeds that could be attained.)

Elements within the Air Force were either attracted to or repulsed by the X-29 concept, and this dynamic tension affected Air Force participation. The sophisticated flight-test organization operated by the Air Force Flight Test Center at Edwards AFB in California's Mojave Desert was geared to test aircraft and concepts intended for production on a fleet scale for operational use by the service's combat forces. The demands of this type of testing are different than those imposed by research programs flying only one or two highly specialized aircraft like the X-29. In fact, NASA etymologists make a distinction between NASA *research* pilots and other organizations' *test* pilots. Research pilots seek to understand and expand access to aeronautical fundamentals; test pilots, on the other hand, prove the merits or demerits of a specific production-type aircraft typically before it goes into general-fleet service. In the scope of this definition, both the Air Force Flight Test Center and NASA's Ames-Dryden Flight Research Facility agreed that the X-29 program more closely matched the NASA research model. Yet professional testers at AFFTC saw spinoff benefits from having at least some involvement in the X-29 program. Lurking at higher levels within the Air Force was a lingering suspicion of any program touted as "demonstration" or "research" in the wake of the YF-16 and YF-17, which were cast as lightweight fighter technology demonstrators rather than the production prototypes that they actually became. Both the YF-16 and YF-17 (the latter of which evolved into the Navy's F/A-18) garnered production budgets to the detriment of other programs. To these planners, the X-29 appeared dangerously like a production fighter in waiting. Advocates of the X-29 as a technology demonstrator would need to adhere scrupulously to its conception as a true X-plane, and not as a lead-up to a production fighter variant.

Ted Wierzbanski elaborated on this in 1984, noting:

Sweeping Forward

There are several reasons the Air Force did not want, and does not want, to be involved in the X-29 program. One of them is the YF-16/YF-17 push-it-down-the-throat syndrome that a lot of the Four Stars had. You know, the F-16 the Air Force really didn't want! This was supposed to be a technology design (a couple of airplanes) that eventually turned into a flyoff, that eventually turned into a major procurement of a weapon system some Air Force generals felt was sort of pushed down their throats.... So way back when General [Alton D.] Slay [commander of Air Force Systems Command from 1978 to 1981] and a bunch of the generals saw the X-29 program, they felt that the X-29 was going along the same road. And in fact, concern over this was one of the reasons it was called an X-Airplane.²³

Additionally, concern was expressed that DARPA would generate the initial startup funding but ultimately look to the military services to pay for its technology dream. The Air Force combat forces and acquisition community understandably (as Wierzbanski characterized it) felt: "We don't want DARPA building airplanes and deciding what is going to be on the next Air Force fighter."²⁴

DARPA lacked the type of organization that could technically get the X-29 contracted and built, and thus the Air Force acted as DARPA's technical agent to help DARPA build the airplane, via Air Force Systems Command's (AFSC's) Flight Dynamics Laboratory's Advanced Development Project Office. NASA was to be the RTO. The contract was written to buy one completed X-29 plus all the parts to construct a second aircraft. The overall initial fixed-price contract with Grumman was for about \$100 million. The contract specified that the option to build the second X-29 would need to be exercised by March 1983, at a cost of \$3 million. DARPA exercised the second-aircraft option basically as insurance in the event that the first X-29 crashed.²⁵

The mechanism under which the Air Force purchased the X-29s on behalf of DARPA, so that they then could be managed by NASA, required a loan agreement to transfer the aircraft to NASA custody for the duration of the program. Until Grumman completed its first four flights of the X-29A-1, the Air Force did not own the X-29. The custody trail for an aircraft, always important, becomes even more so in the event of a mishap, with far-reaching ramifications ranging from fiscal issues to ultimate responsibility. At various times in the X-29 program, Grumman, the Air Force, and NASA had custodial responsibility. Between the first and second flights, in January 1985, the AFSC and NASA executed the X-29A loan agreement that spelled out responsibilities in detail, anticipating the Air Force taking delivery of the first X-29 shortly.

The agreement covered both X-29s (serial numbers 82-0003 and 82-0049). The loan of the aircraft was to facilitate the objectives of the DARPA X-29 Concept Evaluation Program (CEP). The property to be loaned to NASA included X-29A number one (82-0003) plus “spares, supporting material and equipment being procured in support of the X-29A under Contract No. F33615-82-C-3000.”²⁶ When signed in late 1984 and early 1985, the loan agreement was less specific about the second X-29: “X-29A aircraft #2, serial number 82-0049, will be loaned to NASA ADFRF for use as a backup for #1 aircraft. However, in the event DARPA determines that Aircraft #2 can be utilized more effectively for other purposes, loan of this aircraft to NASA as a backup may be suspended.”²⁷ The loan also provided for three F404 jet engines, serial numbers 215213, 215209, and 21215, “to provide propulsion for each aircraft and one spare.”²⁸

The original loan period was for 18 months, with extensions available as needed to achieve program objectives. The loan began “upon initial AF [Air Force] acceptance under AF Contract... of the X-29A aircraft with a limited envelope flight control system (FCS) and upon completion of an acceptance inspection by NASA. The loan period will be interrupted by return of the aircraft to Grumman Aerospace Corporation (GAC) as government-furnished property (GFP) for modification of the FCS to incorporate variable gain reversion modes and to conduct a second set of functional check flights. Upon completion of the FCS modification and functional check flights thereof by GAC, final acceptance of the aircraft by the Air Force, and reinspection by NASA, the loan to NASA will be resumed for continuation of the CEP.”²⁹

The agreement gave latitude to the use of the X-29s: “The X-29A aircraft provided in this Agreement will be used initially by NASA to conduct the DARPA CEP flight testing. Subject to mutual agreement by NASA, USAF, and DARPA, NASA may also employ either or both aircraft in cooperative flight research programs with the USAF and/or Navy.”³⁰ The Air Force provided, on an as-required basis, “contractual services, logistics support, petroleum oil and lubricants (POL), time compliance technical order (TCTO) modification kits, and repair and/or overhaul of contractor-furnished equipment (CFE) and government furnished property (GFP). Support will be provided by the Air Force Flight Test Center (AFFTC)... DARPA will reimburse for costs of the above in accordance with the NASA and DARPA MOU [Memorandum of Understanding] of 22 Apr 81...”³¹

NASA assumed responsibility under the loan agreement “for the safety of the X-29A aircraft in storage and during ground and flight operations.”³² This included “responsibility for the physical security and control of access to the X-29A aircraft and associated equipment.”³³ At the end of the loan agreement (plus any extensions), “The X-29A aircraft shall be returned in the configuration

Sweeping Forward

existing (including normal wear and tear) at the conclusion of the loan period, and in a safe flying condition, except for lack of parts or occurrence of a mishap, or as mutually agreed to by NASA and the X-29 ADPO/DARPA.”³⁴ The loan agreement covered loss of aircraft: “In the event of aircraft loss or destruction, NASA will not be responsible to reimburse DARPA or the USAF.”³⁵ But in the event of an accident or incident involving the X-29, “NASA is responsible for reporting and investigating the mishap in accordance with the established NASA accident reporting procedures. All such mishaps will be reported by NASA ADFRF immediately to the Commander, AFFTC; the Director of Aerospace Safety, Norton AFB, CA; Headquarters ASD Directorate of Safety, Wright-Patterson AFB, OH, and to the X-29 ADPO.”³⁶ In practice, both NASA and the Air Force had well-developed aircraft handling, maintenance, and mishap programs in place. The codified X-29A loan agreement simply answered questions about roles and responsibilities in anticipation of eventualities.

By January 1982, DARPA was showing signs of concern over NASA’s proposed flight schedule for the X-29, believing it to be too conservative. NASA forecast a flight rate of about one per week. This was plausible and prudent in view of the X-29’s amalgamation of technologies into a hand-built airplane. Wierzbanski understood NASA’s rationale: “NASA knew the maintenance on the aircraft was going to be a nightmare. They foresaw all kinds of problems.... They planned to schedule two or three times a week, but realistically they were saying: ‘we’re probably only going to get one flight’.”³⁷ At the opposite extreme, the contractor forecast a higher fly rate if Grumman ran the program. In the midst of this, ADPO asked AFFTC to reevaluate its ability to be the X-29 RTO in place of NASA. ADPO members came to Edwards to discuss this with Lt. Col. Mike Reinard, chief of fighter test, and Ray Jones at the USAF Test Pilot School (TPS). During that visit, the Edwards testers ascertained that the overall objective at that time was to validate the various advanced technologies on the X-29. Wierzbanski said that was too generalized to be the only stated objective used as a basis to determine the correct RTO for the program. That led to the establishment of objectives in greater specificity created primarily by the Dryden flight-test team, which included AFFTC participation. The X-29 operation was in the unusual position of having its objectives defined from the bottom up rather than being handed to the team from the top.

When ADPO asked if AFFTC could replace NASA as Responsible Test Organization, Lt. Col. Reinard asked key AFFTC participants in maintenance, engineering, and operations not only if AFFTC could be the RTO but if AFFTC could do a better job than NASA. The AFFTC respondents all reported that they probably could not be RTO because its one-of-a-kind nature was outside the expectations placed on AFFTC at that time, and expertise and manpower would be lacking. The AFFTC testers also said NASA’s planned

program as RTO looked reasonable and that NASA was well suited to execute programs of this nature. This was briefed by Reinard to the then-AFFTC commander Maj. Gen. Philip J. Conley, Jr. The general agreed with the findings that AFFTC should not be RTO and that NASA was well positioned to be RTO. Within that framework, and mindful that higher service headquarters personnel were not enthusiastic about the X-29, Major General Conley nonetheless wanted AFFTC participation on the X-29 to give the Flight Test Center experience in the kind of testing and technologies represented by the X-29.³⁸

Air Force logistics planner L.T. Byam at Edwards framed his office's response to the ADPO request with eloquent simplicity:

During the time frame for the X-29 test program, we will have increased activity in the F-16 programs...with a total of 11 F-16 aircraft to support. At the same time, we will be providing support to F-15 PMALS [Prototype Miniature Air-Launched Segment] and the LANTIRN [Low Altitude Navigation and Targeting Infrared for Night] programs.

We have identified additional manpower and support equipment we will need to support these programs. It is still undetermined if the personnel and/or the expertise will be available to fill our requirements.

The X-29 is an experimental aircraft and we do not have blue-suit (Air Force military) capability to fully maintain and support an experimental weapon system. Some areas of consideration would be Air Force technical data and training requirements.

*We foresee no problems in providing general support, such as weight and balance, thrust, hydrazine, etc., to NASA if they are the RTO for this program. [Emphasis added.]*³⁹

Edwards's Flight Dynamics Division weighed in on their lack of staffing to support X-29 if the Air Force were to become RTO, noting: "It is not prudent to think that additional manpower authorizations will turn this condition [over commitment of staff] around. We would need highly experienced personnel, not just bodies in number.... The Flight Dynamics Division recommends against accepting the X-29 test program as a total AFFTC effort."⁴⁰

Even as Grumman embarked on the first X-29 metalwork in January 1982, center commander Conley directed then-Major Wierzbowski to look into the X-29 effort to determine what level of participation by the AFFTC would be advantageous. Three months later, Wierzbowski reported that the X-29 project at that time appeared to be "all velocity but no direction,"⁴¹ due at least in part to resistance to it at some levels elsewhere in the Air Force. His

Sweeping Forward

initial assessment included the observation: “NASA appears to have their act together—don’t think we should attempt to change anything right now.”⁴² Wierzbowski opined that the AFFTC should do research and get up to speed on the X-29 in case future Air Force testing came along, adding: “My gut feeling is that it will happen.”⁴³ Wierzbowski then set about gathering literature relating to forward swept wings and other technologies embraced by the nascent X-29.

Wierzbowski spent the summer of 1982 working with DARPA, ADPO, and NASA in an effort to place AFFTC’s participation correctly within the X-29’s alphabet soup. In fact, some at Dryden, including then-program manager Terry Putnam, had earlier invited the AFFTC to send pilots to join the X-29 program. This seemed appropriate to Dryden since the X-29 was really Department of Defense (DoD) funded, and DARPA works for DoD. “About the end of summer,” Wierzbowski related, “I finally got DARPA and the ADPO and NASA to agree that the AFFTC really should participate.”⁴⁴ The coalescing of AFFTC pilot participation during 1982 initially envisioned Air Force pilots flying the X-29 on 10 flights, representing 20 percent of a 50-flight program. Ted Wierzbowski was in the right position to volunteer to be the AFFTC X-29 program manager and pilot, which he did with the optimistic view that he would actually get to fly the X-29 more than initially specified. “The stipulation that NASA came up with, though, was that if the AFFTC did assign a pilot to the program way back then [1982]... the pilot would have to stay through the program (finishing) the envelope expansion phase so that we didn’t just bring somebody on and then, just before flying change pilots,”⁴⁵ Wierzbowski said. The AFFTC exercised its ability to freeze Wierzbowski’s assignment until the spring of 1986 to accommodate NASA’s request.

Wierzbowski felt strongly about the need to have AFFTC participation in X-29 so that the AFFTC could act in the best interests of the Air Force should the Air Force subsequently decide to get involved in a bigger way. AFFTC could be the service’s trusted agent to advise the Air Force on where its money would be best spent, should that become the case.

This illustrates an important difference in how the Air Force and NASA are chartered to do business. NASA engineers and research pilots may serve their entire careers at only one of NASA’s regional Centers, moving up without ever moving out. The Air Force rotates members in and out of positions regularly, sharing opportunity and responsibility among all active duty members in a fairly predictable cycle. Relocation to new bases is the routine. In the case of Major Wierzbowski, the AFFTC temporarily took him out of the normal Air Force rotation to enable him to plant seeds and then harvest the fruits of his labors on X-29, in keeping with his NASA counterparts.

Two reasons placed the AFFTC in the X-29 team composition, as Wierzbanski recalled: “Number one was NASA invited us...and, number two, General Conley wanted...just from a testing standpoint—wanted us to be involved in the program.”⁴⁶ In other words, the process of testing this cutting-edge X-plane was more valuable at the AFFTC level than were the technologies or their potential applicability to future aircraft such as the ATF (later the YF-22 and YF-23)—those attributes that would matter more for DARPA. Nonetheless, the rationale that Wierzbanski worked out with DARPA, NASA, and ADPO for AFFTC involvement was: “We were going to evaluate the military utility of the various advanced technologies on the X-29.... Not that we were going to go out and try and drop bombs or shoot guns with the airplane—but to look at the basic technologies and see if there is any worth to them.”⁴⁷ Even before first flight, Wierzbanski gave an interesting perspective on the relative merits of those technologies: “Forward swept wing is the most prevalent technology, however, with respect to program goals, forward swept wing actually now is a long term goal, looking at performance advantages. There are other things that are on the airplane that some of us think might be more relevant to ATF. For one, you’ve got the canard and the unknowns involved with the canard-wing interactions, the wing-canard interactions.”⁴⁸ The canard on the X-29 was designed to move through 90 degrees of travel in less than a second. “It is a powerful canard and the interaction of that canard on the wing is a big unknown.”⁴⁹ (At that time, 1984, early thoughts on the ATF concept included the likelihood of a canard, although neither the winning Lockheed F-22 design nor its Northrop YF-23 runner-up featured this kind of design.)

The X-29 program had a Navy component, albeit much smaller than the Air Force presence. ADPO tasked the Naval Air Test Center at Patuxent River, MD, to monitor the development and testing of the X-29’s flight control software. The Navy did this through a software audit, test monitoring, ground-based flight simulation, in-flight simulation, and independent verification and validation tests.⁵⁰

From Hope to Hardware

ADPO fostered a monthly Forward Swept Wing Technical Activity Report, surviving copies of which provide a chronological sense of momentum as the X-29 effort matured toward flight. Wind tunnel tests at NASA Ames Research Center in May 1982 included oil flow visualization runs that mapped surface airflow “to assess actuator and hinge fairing interference.”⁵¹ That month, an ADPO assessment of the contractor’s X-29 work said: “Grumman’s engineering design effort to date is comprehensive and conservative.”⁵²

Sweeping Forward

In June 1982, ADPO heard from NASA Langley Research Center wind tunnel specialists that the Langley rotary balance wind tunnel facility had tested a model of the X-29 that indicated some proclivity for the aircraft to enter a spin at extremely high angles of attack. “Data showed that these results were dominated by F-5A forebody aerodynamics,” the ADPO monthly report noted, adding: “Since the flow characteristics in this area are highly viscous dominated, substantial scaling corrections must be made to remove uncertainty in the results.”⁵³ The X-29 would ask its incorporated F-5A forebody to fly at angles of attack at which it was not designed to fly.

On August 27, 1982, ADPO took note of a significant milestone as Grumman placed the first components of X-29A-1 in the final assembly fixture that day. At that time, the first X-29 was forecast to emerge from the final assembly fixture in April 1983. Additionally, in August 1982, a suitable donor F-5A airframe was found in Norway for the second X-29’s forward fuselage. Another X-29 milestone on August 27 was the presentation of findings by the Aeronautical Systems Division that indicated a FSW aircraft with X-29 characteristics and construction could be expected to be 5 to 10 percent lighter at takeoff gross weight than a traditional aft swept wing jet would be. By August 1982, the gait of X-29 progress was sufficient to produce numerous advances and opportunities. That month, Calspan proposed an in-flight simulation program that it could perform for the X-29 team, using a Calspan aircraft as a surrogate for X-29 flight characteristics. (This was accomplished in 1984 with Calspan’s versatile NC-131H Total In-flight Simulator [TIFS] test bed aircraft that featured a second cockpit with a flight control system enabling a test pilot to replicate at least some of the X-29’s flying qualities.) During August, NASA pilot Steve Ishmael, the Air Force’s Maj. Ted Wierzbanski, and Marine Maj. Bob Cabana evaluated Grumman’s domed motion-based X-29 flight simulator. They gave the simulator marginal marks for lateral-directional flying qualities, which improved somewhat when roll damping was added. Later, Grumman identified a lag in the CRT (cathode ray tube) visual display in the simulator. Once this delay was fixed, improved lateral-directional handling was reported.⁵⁴ (As valuable as simulation proved in the X-29 program, pilot feedback about visual lags was vital to improve simulation fidelity; it should be noted, of course, that this simulator represented the state of the art of simulation by the standards of the early 1980s, approximately a dozen generations of electronic systems capability behind contemporary standard, as defined by Moore’s law).

Fifteen Government engineers descended on Grumman Aerospace Corporation on August 17 and August 18, 1982, for an X-29 cockpit design review. They reviewed the instrument panel layout, “switchology” (i.e., rationale for how cockpit switches and controls work), escape system, human factors considerations, systems interfaces, and operational procedures. The primary

emphasis was on safety of flight. ADPO reported: "GAC accepted 18 action (items) requiring minor modification to the cockpit. Twenty issues were identified that will require further investigation. Major issues include throttle design, limited hydrazine quantity for the EPU, and flight control mode changes during takeoff."⁵⁵

In September 1982, ADPO visitors observed the first X-29 aeroelastically tailored composite FSW cover layup in progress. That month, nine Government engineers converged on Grumman for a milestone technology assessment of the X-29 landing gear systems. Grumman took 12 action items requiring additional analysis and investigation, according to an ADPO document. "Main issues included main gear wheel/brake qualification test requirements, nose gear slap down sensitivity analysis and weight-on-wheels switchology and its interface with the flight control system."⁵⁶

Although the visible NASA focal point for the X-29 was the Ames-Dryden Flight Research Facility, the wind tunnels and research capabilities of other NASA Centers were vital as well. An October 1982 ADPO report described updates on NASA Langley Research Center's collaboration with Grumman on a 1/16-scale wind tunnel model for the Langley transonic facility and Langley's development of a test for an X-29 bend-pitch flutter model. Concurrently, at NASA Langley's dynamic stability branch, work was under way on high-AoA piloted simulation, a spin tunnel study, the impending X-29 helicopter drop model design, and a study and test of the X-29A/Aden nozzle model. Also during October, Grumman met with Air Force and NASA engineers to refine the X-29's flight flutter exciter system to enable study of flutter traits under controlled conditions. Grumman also spent time reviewing differences between the first USAF F-5A nose section received for the X-29A-1 and the Norwegian Air Force F-5A nose obtained for the X-29A-2.⁵⁷ Inspection revealed differences between the Norwegian production A-model and the USAF example, described as "pre-production" in an ADPO report. A Government team from Air Force and NASA offices visited Grumman in November 1982 "to inspect and prepare cost estimates for putting the second forebody into the same configuration as the first."⁵⁸

November 1982 was notable for the achievement of a stable flight control system for the X-29. ADPO's deputy program manager Thomas M. "Tom" Weeks described the progress: "NASA, Navy, and Air Force representatives received a technical update on the work-in-progress for the Flight Control Laws. It appears that the redesign has progressed in a timely fashion with all points (gains) identified by the scheduled date. Early results indicate a stable, controllable system. Further examination of gains will continue analytically with simulation scheduled to continue through the first of the year."⁵⁹ Normal digital control was demonstrated that month, when NASA's Steve Ishmael

Sweeping Forward



The first X-29A FSW demonstrator flying in formation with a Northrop T-38A Talon from the Dryden Flight Research Facility. The T-38A shared much with the F-5A that formed the basis for the X-29's forward fuselage. (NASA)

became the first Government pilot to experience normal digital control on the simulator and since the incorporation of fully active strake flaps. Weeks reported: "Steve was basically pleased with what he saw, but some complaints on landing roll-out with crosswinds. Also, with Speed Stability operating mode engaged, he has a tendency to over control pitch rotation. Grumman will continue development of their control system...."⁶⁰

By December 1982, the Air Force Test Pilot School successfully completed a project to devise a way to use a Northrop T-38A Talon—which had the same basic airframe as the Northrop F-5A except with two, not one, seats, and a modified cockpit and canopy—to simulate X-29 engine-out deadstick landing profiles, adding yet another layer of realism to the flight simulation options available to X-29 pilots. That month, Dryden began looking at replanning their envelope expansion program based on two flight periods each week. The goal was to compress the envelope expansion duration from a forecast 18 months to only 9 months.⁶¹ (In actuality, envelope expansion required more than 9 months; early sustained flight-rate predictions tended to be overly ambitious—not a problem unique to the X-29.)

By early 1983, Grumman had assessed problems with the fixed gains intended for the backup flight control system. The primary flight control system had multiple gains; initially, the backup system used a fixed gain, which proved inadequate in preventing aeroelastic coupling throughout the flight envelope. By March 1983, Grumman forecast to ADPO that first flight of the X-29 with a limited performance envelope could take place by April 1, 1984, with full envelope capability achievable by August 1 of that year.⁶² (In actuality, first flight was in December 1984, and then only with limited capability.)

While Grumman tackled significant flight control issues, in March 1983, progress on assembling the first X-29 included items heralded by the monthly ADPO report: "Both sides of the F-16 main landing gear were fitted to the ship 1 fuselage.... The gear were obtained from the F-16XL program."⁶³ Additionally, a special windscreen assembly, three-quarters of an inch in thickness, was completed by the Air Force's 4950th Test Wing and sent to Grumman for the X-29. "This activity was in response to concerns relative to bird-strike protection adequacy."⁶⁴

On March 22, 1983, the X-29 program's Maj. Doug Schroeder gave a detailed X-29 program overview to Otto Sacher and Peter Sensburg from Germany's Messerschmitt-Bölkow-Blohm (MBB) organization, the ultimate inheritors of the HFB 320 Hansa FSW design. MBB's interests, as ADPO noted, included "a conceptual design study of a high performance forward swept wing airplane. MBB also completed flight testing last year of a modified *Luftwaffe* canard-equipped Lockheed F-104G Starfighter...."⁶⁵ This aircraft, the F-104 CCV (for "control-configured vehicle"), had a second F-104 all-moving horizontal tail installed on the spine of the aircraft aft of the cockpit and a fully digital redundant quadruplex flight control system that gave it substantial negative stability in the pitch axis. Expansion of the negative stability envelope was thus an international quest illustrating that the X-29 effort certainly did not reside in a vacuum.

The forward swept composite wing of the first X-29A was mated to its fuselage early on the morning of June 16, 1983, a milestone construction event noted by ADPO. A further dividend came when the weight of the finished wing was found to be 30 pounds less than predicted, a most pleasant discovery.⁶⁶

Where some full production programs budget for the construction of a static test airframe, the experimental X-29 program had no such option. A static test airframe is a genuine aircraft that is not intended to fly but one which will be subjected to applied loads in a ground structure that measures deflections and stresses to prove (or disprove) the soundness of the structure. For the X-29 program, the actual flight-article aircraft performed loads tests. In November 1983, the newly finished X-29A-1 underwent static structural load testing at Grumman's Bethpage, NY, facility. Lt. Col. James Wansack, X-29 program manager from

Sweeping Forward

the Air Force Flight Dynamics Laboratory, documented the results: "The test was considered an outstanding success.... Three critical 8g wing box design conditions were scheduled for 100% of limit load proof test verification."⁶⁷ One test for critical wing root loads had to be delayed when a hydraulic fluid leak caused adhesive to fail on lower surface fuselage load pods. Once accomplished, the wing tests were a gratifying affirmation of the X-29's structural concept. "The wing proof tests, in addition to verifying structural strength, also verify the aeroelastic tailoring design of the composite wing box covers,"⁶⁸ Wansack noted. "The tailoring provides favorable bend/twist coupling with minimal weight penalty to offset the inherent wing divergence tendency of forward swept wings. The wing deflection and strain characteristics were predicted in advance to serve as a guide during the test. The actual deflections (that were) measured along the wing span at the front spar on 23 Nov were essentially identical to these predicted.... The measured data are well within normally anticipated deviations from those analytically predicted."⁶⁹ Two more wing proof tests that month validated wing box design outboard of the wing root area with results similar to the wing root tests. Wansack said: "The wing box test results reflect very highly on Grumman's design and test personnel."⁷⁰

Test Planning

At least a year before first flight, NASA characterized the upcoming X-29A effort as a design and test validation, and Dryden's Terrill W. Putnam noted: "The X-29 flight-research program provides a unique and timely opportunity to close the loop on the aircraft analysis, design, fabrication, and ground- and flight-test process. The flight research program will provide the data necessary to validate and improve the entire aircraft design, fabrication, and test process for future aircraft."⁷¹

NASA Ames-Dryden Flight Research Facility developed the program plan for the X-29A, submitted by its X-29 program manager Walter J. Sefic. Concurrence on the program plan came from Kenneth E. Hodge, chief of the Dryden Aeronautical Projects Office; Ronald S. Waite, chief of the Dryden Research Aircraft Operations Division; and Kenneth J. Szalai, chief of Dryden's Research Engineering Division (and a future director of the Dryden Flight Research Center). The plan received approval from Martin A. Knutson, Dryden's Director of Flight Operations. The plan encapsulated much about the program:

The overall objective for the X-29A Advanced Technology Demonstrator Program is to build and flight-test a manned demonstrator to validate advances in integrated aerodynamic,

structural and flight control techniques so they can be considered viable design options for future aircraft. The purpose of this plan is to describe current government plans for the flight test of the X-29A and how the results of these tests will be communicated to interested organizations in both industry and government.⁷²

The plan gave its own orienting description of the aircraft:

The X-29A Advanced Technology Demonstrator... is a single seat, single engine aircraft which incorporates many of the advanced technologies being considered for incorporation into this country's next generation of aircraft. These advanced technologies include: a full authority, closely coupled canard; a thin supercritical wing airfoil; full-span, dual-hinged flaperons that provide variable camber control; a triple channel digital fly-by-wire flight control system used to control the aircraft's highly relaxed longitudinal static stability; aft fuselage strake flaps which provide a third longitudinal control surface that is control coupled with the canard and flaperons; and last, but not least, a forward swept wing... design made possible through aeroelastic tailoring of advanced composite wing skins. Since the prime objective of the X-29A program is to validate and develop confidence in these technologies, existing flight proven hardware was used in the aircraft wherever technology was not being advanced. Thus, the aircraft was designed using an F-5 nose section and ejection seat, F-16 landing gear, emergency power unit, and actuators, F-14 sensors, F-18 engine, and Honeywell HDP5301 flight control computers.⁷³

From the outset, Grumman built the X-29 to explore the high-AoA flight regime. The two inlets for the jet engine were designed with large-radius lips to improve operation at high AoA and low dynamic pressures. Since experience with the F-5 fighter had shown a tendency for asymmetric vortex flow at high AoA, the F-5 noses incorporated into the X-29 design had the forebody length shortened by 11 inches with small nose strakes added in an effort to delay the phenomenon of asymmetric vortex shedding to a higher AoA.⁷⁴

The X-29's debut as the first nonproduction high-performance experimental manned aircraft in a decade coincided with advances in test data-gathering abilities and improved simulation assets. NASA and its forerunner, NACA, have long pursued dual goals in flight research. While exploring and expanding aeronautical frontiers by quantifying specific aircraft behaviors, NASA also validates testing and sampling processes to give testers and engineers the proper

Sweeping Forward

level of confidence in the results they get from modeling and flight testing. The NASA X-29 program plan said the X-29

Provides a rare opportunity to validate the entire aircraft design process by careful correlation and comparison of flight test results with wind tunnel results and design predictions. An audit trail linking the analysis, design and fabrication with the ground and flight testing is being developed as a major element of the X-29A program. NASA and the Department of Defense (DoD) have developed and are implementing a series of coordinated analytical efforts, wind tunnel tests, ground and airborne simulations, and ground and flight tests into this program to more fully exploit this opportunity.... Analytical predictions and projections of wind tunnel test results have indicated that the various advanced technologies incorporated in the X-29A will provide substantial improvements. These advancements are significant when considered individually, however, their impact is expected to be even greater when combined synergistically into the X-29A flight vehicle. This combination of technologies will also result in a special challenge to the X-29A researchers to develop methods of extracting the individual technology benefits in order that they may be properly assessed.⁷⁵

The NASA X-29A program plan encapsulated research leading to the aircraft's forward swept wing: "Extensive analyses and studies of the forward swept wing concept were conducted under the direction of the Air Force Flight Dynamics Laboratory by Rockwell, General Dynamics and Grumman. Trade-off studies were conducted between forward and aft swept wing designs for selected mission requirements, wind tunnel tests were run and final designs were developed. These studies showed a number of potential benefits could be derived from a forward swept wing design."⁷⁶ The NASA document characterized these benefits as reduced takeoff weight, improved transonic maneuverability, improved low-speed/high-AoA control, improved takeoff and landing characteristics for short takeoff and landing (STOL) designs, and increased external and internal design freedom. From the Ames-Dryden program plan, it is immediately evident that NASA enthusiastically embraced the potential of the technologies amalgamated into the X-29 design. The higher trailing-edge wing sweep "provides the opportunity for higher shock wave sweep (and correspondingly reduced shock strength) in the transonic regime when the shock is located aft of mid chord. Such shock location is prevalent where supercritical airfoils are successfully integrated into wing design.... Reductions in shock

strength reduce wave drag and drag due to shock-induced separation (of air-flow over the wing). This provides for increased specific excess power levels in maneuvers and increased drag divergence Mach number for potential aircraft range/combat radius improvements. Reduced shock strength also inhibits the potential for shock-induced buffet, or in the event that this occurs, reduces its severity.”⁷⁷

Most conventional straight or aft swept wings have built-in twist, or washout, in the design. This can be seen as a downward leading-edge twist at the tips of the wing, and it is readily visible on some aircraft. On traditional (nonforward swept) wings, this washout is an aerodynamic compromise that ensures the outer portion of the wing associated with ailerons for roll control will remain “flying,” with attached airflow unstalled at higher angles of attack. Reduced built-in wing twist in forward swept wings promised advantages in certain flight regimes. “An example of this opportunity is in the case of a mission which requires substantial transonic maneuver capability along with supersonic dash/cruise. Here, a forward swept wing configuration could meet these requirements with a reduced weight penalty associated with twist compromise,”⁷⁸ the plan noted. Although, the plan acknowledged, if “the conflict in twist requirement for optimization of the configuration for maneuver and cruise are small enough to be treated with no weight penalty on an aft swept wing configuration (e.g., with aeroelastic tailoring), then there is no relative advantage in this area to be realized by employing forward swept wings.”⁷⁹ This exploration highlights the inevitable, and sometimes frustrating, compromises that must attend construction of an essentially rigid airframe, where one configuration would favor maneuverability while another would be best for cruise economy. A variety of airfoil augmenting flaps and leading-edge devices could ameliorate this “either/or” situation and make compromise more palatable.

NASA looked forward to exploring the X-29’s reduced wing twist requirements, made possible by the canard ahead of the wing: “The flow field induced by a canard reduces the basic wing twist required to minimize induced drag for a forward swept wing in contrast to an aft swept wing where the twist requirement is amplified by the canard flow field. Forward swept wing configurations incur benefits similar to aft swept wings for other canard considerations,” the X-29 plan noted.⁸⁰

One of the great and sometimes unsung benefits of FSW designs with canards is the aft location of the wing-fuselage juncture, behind the aircraft’s center of gravity. This contrasted with aft swept wings, where the wing root is typically near the aircraft’s c.g. The NASA X-29 program plan discussed what this could mean to aircraft design and utilization: “In both cases, wing location is determined by aircraft balance considerations. Transonic/supersonic area ruling for wave drag optimization tends to result in a large useable fuselage volume near the c.g. for

Sweeping Forward

forward swept wing configurations relative to aft swept wing configurations. This permits the location of expendables (such as fuel and weapons), high flotation tire stowage (for soft field operations), and vectorable thrust engines (for V/STOL [vertical and/or short takeoff and landing] configurations such as the Harrier) near the c.g. with less area rule compromise for the forward swept wing configuration.⁸¹ Expendables such as fuel and ordnance near the c.g. cause less of a shift in c.g. when expended than such items cause when they are located farther from the c.g. With a forward swept wing's c.g. largely unaffected by expendables, trim drag is reduced over the course of a mission. "Such considerations are the subject of overall system synthesis/design trades so that other compromises might be made in light of specific mission requirements."⁸²

The lower sweep angle of the leading edge on forward swept wings was of interest to NASA: "For a given platform, forward swept wings have lower leading edge sweep than aft swept wings. This results in a higher lift curve slope which, in turn, provides higher lift at a given angle-of-attack. Thus, for configurations where approach speed is limited by the tail strike angle, forward swept wings generate more lift thus reducing takeoff/landing ground roll."⁸³ The forward swept wing also favored a higher aspect ratio (wing span to wing chord; slim-winged sailplanes have high aspect ratio wings), increasing lift while decreasing induced drag, "which would lead to improved cruise and maneuver capability."⁸⁴ Before the X-29 flew, modeling indicated the lower leading-edge sweep also improved desirable natural laminar flow over the wing versus the amount of laminar flow achieved on a wing with sharper leading-edge sweep, "since spanwise flow instabilities which inhibit LFC [laminar flow control] are amplified with increasing leading edge sweep."⁸⁵ But compromises remained—the shallower leading-edge sweep on the forward swept wing "also implies higher bluntness drag supersonically"⁸⁶ and possible ride quality degradation. These were more potential tradeoffs to be weighed when designing future aircraft based on these tenets.

The reverse geometry of the FSW planform produced other effects NASA wanted to explore with the X-29:

Geometrically, forward swept wing tips are ahead of the root region, as contrasted with aft swept wings. Since the forward swept wing tips are in a weaker upwash field than the inboard region, the tips stall last. This provides stronger lateral control to higher angles of attack without wing twist compromise. For STOL designs, if the roll control requirement for takeoff and landing challenges a design which has been optimized for other aspects of the mission requirements, the forward swept wing could also show a relative trade advantage.⁸⁷



The second X-29A on a high-AoA research flight. Note the deflected canards, tufts (to reveal flow patterns), and smoke visualization employment. (NASA)

Efficiencies were forecast with FSW trailing-edge flaperons due to the wing's geometry: "For configurations with canards which have been balanced and optimized for considerations other than takeoff and landing ground roll, the trailing edge high lift devices tend to be nearer the c.g. with the forward swept wing than for the aft swept wing. This results in a higher trimmable lift without design compromise since the nose-down pitching moment induced by the high lift devices is lower for the forward swept wing (assuming that sufficient lift can be generated by this means to challenge the canard authority)."⁸⁸

With aeroelasticity issues tamed by careful composite wing ply layup methods, NASA flight test planners and engineers believed that

Structurally, the flight envelope of a forward swept wing aircraft is not bounded by classical flutter such as [it] is for aft swept wing configurations. When stores are mounted on aft swept wings, the flight envelope is typically reduced by their impact on flutter. For forward swept wings there appears to be a larger margin between the classical flutter boundary and the flight envelope.⁸⁹

NASA posited the idea that a FSW aircraft could carry some number of weapons "without a placard for classical flutter."⁹⁰

Sweeping Forward

Nonetheless, some FSW configurations could lead to low-frequency flutter derived from wing bending and aircraft pitch modes, so untried stores carriage on a forward swept wing needed more research. “This phenomenon in conjunction with forward swept wing stores carriage considerations in general, require further investigation.”⁹¹

The NASA X-29 plan also theorized about the future potential of wings with variable forward sweep. Forward sweep could counter a trim-and-drag problem associated with aft sweeping wings, and planners noted:

For variable sweep configurations, forward swept wings would sweep forward with increasing free stream Mach number in contrast with aft swept wings which sweep aft. The forward sweep motion counters the aft center of pressure (c.p.) shift associated with the increase of Mach number into the supersonic regime. The opposite occurs for the aft swept wing, thus accentuating the c.p. shift.⁹²

This is important because a c.p. shift causes a change in aircraft moment, which requires trimming the aircraft in order to maintain level flight. This trimming typically adds drag. The NASA X-29 plan looked into the future and foresaw benefits to forward swept wings:

Conceptually, the forward swept wing trim drag penalty due to moving the wing forward could be minimized through a Mach number–sweep schedule. These considerations are also the subject of overall aircraft synthesis/design trades which are dependent on specific mission requirements.⁹³

In other words, the concept and benefit of forward sweeping wings was not a one-size-fits-all recipe. As can be seen elsewhere in this volume, the benefits of forward swept wings are not strictly for small, fast aircraft; transports and even bombers could make use of the wings’ unique features. Another potential benefit of forward swept wings is the fact that the wingtips move upward as a FSW aircraft rotates for takeoff, delivering greater ground clearance. Some aft swept wing configurations could be impacted by the downward rotation of their wingtips during rotation.

The NASA X-29A program plan embraced the desirability of evaluating multiple technologies, far exceeding the basic thin supercritical airfoil FSW/ close-coupled canard concept. Other technologies, it noted:

Were chosen because of the significant advantage they might offer to any aircraft configuration. The specific technologies that have been designed into the X-29A and the project payoffs are:

A forward swept wing, designed and fabricated with advanced graphite composite covers which employ aeroelastic tailoring to control structural divergence.

A thin supercritical airfoil that provides reduced transonic cruise and maneuver drag.

Trailing edge double hinged flaperons which provide camber control efficiency approaching that of smooth variable camber.

A statically unstable configuration with an all movable close coupled canard in conjunction with high authority strake flaps and trailing edge flaperons for minimization of trim drag across the flight envelope.

A triplex digital flight control system that provides for vehicle control and redundancy to safely explore the relaxed static stability configuration.

Approach and landing flight control mode to exploit the projected STOL capabilities.⁹⁴

As explained in the NASA X-29A program plan, the aircraft “has been designed and fabricated primarily on the basis of aerodynamic and structural computer design codes with a minimal amount of wind tunnel testing and configuration development. Thus, the success of these technologies relies heavily on analytical design codes and methodology.”⁹⁵ The subsequent success of the X-29 validated these methodologies and doubtless gave designers added confidence to migrate away from wind tunnel intensive preparations, as had been the precomputer norm.

The plan for the X-29 program acknowledged its many constituents—NASA, DoD, and the various contractors. NASA Ames, Dryden and Langley, and the Air Force Flight Dynamics Laboratory and Grumman Aerospace all undertook preflight simulations, the most valuable of which were those flown by the contracted TIFS in-flight simulator aircraft. Wind tunnel testing, though limited compared to some classic programs, was conducted at NASA Ames and Langley as well as at Grumman’s facility and the Air Force’s Arnold Engineering Development Center (AEDC) in Tennessee. Before first flight, NASA acknowledged a greater potential of the X-29: “Even with all the testing and analyses that has been accomplished and is scheduled and funded, all the data necessary to meet current and follow on research objectives will not be in hand. It therefore follows that additional analyses, ground tests and flight tests will have to be advocated to fully exploit the opportunities provided by the X-29A airplanes.”⁹⁶

Eight program phases, some already completed, were tallied in the NASA Ames-Dryden program plan:

Sweeping Forward

Phase I: Conceptual design, analyses, trade studies and wind tunnel validation of wing divergence control using composites.

Phase II: Preliminary design, wind tunnel configuration testing, and concept validation that resulted in firm proposals for design, fabrication, and test of one or two demonstrator aircraft.

Phase III: Preliminary design, final design, analyses, wind tunnel testing, and functional flight testing of one aircraft with an option for a second aircraft.

Phase IV: Expansion of the flight envelope to design Mach number, design dynamic pressure, and 80% of design limit load for symmetric maneuvers at angle-of-attack less than 20 degrees.

Phase V: Continuation of the envelope expansion to include high angles of attack, low dynamic pressure testing.

Phase VI: Development and implementation of advanced control laws for optimal flying and handling qualities.

Phase VII: Carriage of wing mounted stores to assess the divergence and flutter characteristics of the forward swept wing with stores.

Phase VIII: The development and flight testing of a vectored thrust system to assess control integration benefits, enhanced maneuverability, and STOL capability.⁹⁷

NASA envisioned potential civil and military uses for concepts embodied in the X-29. NASA and DoD devised specific flight-test objectives for the concept evaluation phase of the program:

4.1: Comparison and correlation of concurrent wing load and deflection measurements with divergence analysis, design criteria, and ground test results.

4.2: Comparison and correlation of flutter accelerometer and flight control system measurements with flutter, buzz, and aeroservoelastic analyses, design criteria, and ground test results.

4.3: Comparison and correlation of structural load and deflection measurements for symmetric maneuvers up to 80% of design limit load, with analytical structural model predictions and proof load test results.

4.4: Measurement of the total aircraft lift and drag for comparison with wind tunnel results. Comparison of the lift, drag, and sustained “g” capability at the maneuver design points (30,000 feet at 0.9M and 1.2M) with predictions.

4.5: Establish the wing and canard aerodynamic characteristics through the careful measurement for correlation with computational aerodynamic codes and wind tunnel results.

4.6: Establish aerodynamic stability and control characteristics by careful measurement of control system performance and aircraft dynamic response for comparison with the design criteria and simulation results.

4.7: Establish the flying qualities for both open loop and closed loop tasks for comparison with predictions and existing criteria.

4.8: Evaluate and document approach and landing performance and characteristics for correlation with predictions and design goals.

4.9: Evaluate the military utility of the various advanced technologies incorporated into the X-29A.⁹⁸

The NASA plan acknowledged the need to evaluate the military utility of the technologies incorporated in the X-29 but, with good cause, does not presume the X-29 itself should ever be a candidate for military use. The diminutive size of the X-29, predicated at least in part by its use of the small F-5A forward fuselage, meant all data gathered by the aircraft’s instrumentation suite had to be transmitted to a ground station. The NASA program plan observed: “because of volume constraints, there is no on-board recording capability.”⁹⁹ Instrumentation carried on the X-29 transmitted basic parameters, including air data, angle of attack, sideslip, pitch, roll, and yaw attitudes; rates and accelerations; center of gravity accelerations; engine speed; temperature and nozzle; and surface positions. The flight control system was monitored to measure

Sweeping Forward

computer parameters, stick position and forces, and cockpit accelerations. Flutter and buffet were captured by accelerometers. Structures data, including wing deflection under load, used strain gauges and an optical deflection measurement system. Propulsion data included engine speed, temperatures, and geometry, tallied separately from basic engine parameters. Aerodynamic measurements monitored wing/strake static pressure and canard static pressure. Other instruments recorded miscellaneous data on hydraulics, Environmental Control System (ECS), electrical system, temperature, Emergency Power Unit, and AMAD (Aircraft Mounted Accessory Drive).¹⁰⁰

Endnotes

1. NASA Fact Sheet, "X-29," Ames-Dryden Flight Research Facility, release no. 85-3A (March 15, 1985).
2. Helen Kavanaugh-Jones, ed., *Splendid Vision, Unswerving Purpose: Developing Air Power for the United States Air Force During the First Century of Powered Flight* (Wright-Patterson AFB, OH: History Office, Aeronautical Systems Center, 2002).
3. Ibid.
4. Dr. James Young, interview with Frederick A. Johnsen, Air Force Flight Test Center History Office, April 2011.
5. Hugh L. Dryden, "Subj: X-15 Flight Research Program," Memorandum of Understanding, signed August 15, 1961, Wierzbanski X-29 papers and general X-29 files, Air Force Test Center History Office.
6. Wierzbanski, interview by Hallion.
7. Ibid.
8. Ibid.
9. William J. Normyle, "NASA Reshapes Aeronautics Role," *Aviation Week & Space Technology* (January 15, 1988).
10. S.D. Ishmael and T. Wierzbanski, "X-29 Initial Flight Test Results," NASA document ID 19860060204, 1985.
11. Wierzbanski, interview by Hallion.
12. Ibid.
13. Ibid.
14. Grumman Aerospace Corporation, "Proposal for X-29 Expanded Flight Test Program, 1," technical proposal, file no. 82-6AF(U) (August 1982), Wierzbanski X-29 papers and general X-29 files, Air Force Test Center History Office.
15. Ibid.
16. Ibid.
17. Maj. Wierzbanski to 6512 TESTS/CC, et al, memorandum, TEOF, "Subj: AFFTC Support of the X-29A Program" (July 20, 1982), Wierzbanski X-29 papers and general X-29 files, Air Force Test Center History Office.
18. Ibid.
19. Air Force Wright Aeronautical Laboratory (AFWAL)/(WEF) to AFWAL/FIF (Maj. Doug Schroeder), "Subj: Calverton—Edwards Climatic Data," letter, September 20, 1982, Wierzbanski X-29 papers and general X-29 files, Air Force Test Center History Office.
20. Wierzbanski, interview by Hallion.

Sweeping Forward

21. Ibid.
22. Ibid.
23. Wierzbowski, interview by Hallion.
24. Ibid.
25. Ibid.
26. AFSC and NASA, "Loan Agreement for X-29A Aircraft # 82-0003 and # 82-0049," final approval January 14, 1985, Wierzbowski X-29 papers and general X-29 files, Air Force Test Center History Office.
27. Ibid.
28. Ibid.
29. Ibid.
30. Ibid.
31. Ibid.
32. Ibid.
33. Ibid.
34. Ibid.
35. Ibid.
36. Ibid.
37. Wierzbowski, interview by Hallion.
38. Ibid.
39. L.T. Byam (supervisor, Programs Branch, Logistics Plans Office, 6510th Maintenance and Supply Group [AFSC], Edwards AFB), to 6512 TESTS/TEOF, "Subj: X-29 Aircraft Support Capability Assessment," letter, February 5, 1982, Wierzbowski X-29 papers and general X-29 files, Air Force Test Center History Office.
40. Charles O. Johnson (Chief, Flight Dynamics Division), "X-29 Support—Flight Dynamics Division," paper (circa February 1982), Wierzbowski X-29 papers and general X-29 files, Air Force Test Center History Office.
41. "History of the Air Force Flight Test Center 1 Oct. 1984–30 Sep. 1987," (excerpted from unclassified, unrestricted portions), Air Force Test Center History Office.
42. Ibid.
43. Ibid.
44. Wierzbowski, interview by Hallion.
45. Ibid.
46. Ibid.
47. Ibid.
48. Ibid.
49. Ibid.

50. E. Bruce Jackson and Thomas F. Coyle (Naval Air Test Center, Patuxent River, MD), "Assurance of the X-29A Advanced Technology Demonstrator Flight Control Software," AIAA, copy undated.
51. Thomas M. Weeks (deputy program manager), "Forward Swept Wing Technical Activity Report," X-29 ADPO (May 1982), Wierzbanski X-29 papers and general X-29 files, Air Force Test Center History Office.
52. Ibid.
53. Thomas M. Weeks, "Forward Swept Wing Technical Activity Report," X-29 ADPO (June 1982), Wierzbanski X-29 papers and general X-29 files, Air Force Test Center History Office.
54. Thomas M. Weeks, "Forward Swept Wing Technical Activity Report," X-29 ADPO (August 1982), Wierzbanski X-29 papers and general X-29 files, Air Force Test Center History Office.
55. Ibid.
56. Thomas M. Weeks, "Forward Swept Wing Technical Activity Report," X-29 ADPO (September 1982), Wierzbanski X-29 papers and general X-29 files, Air Force Test Center History Office.
57. Thomas M. Weeks, "Forward Swept Wing Technical Activity Report," X-29 ADPO (October 1982), Wierzbanski X-29 papers and general X-29 files, Air Force Test Center History Office.
58. Thomas M. Weeks, "Forward Swept Wing Technical Activity Report," X-29 ADPO (November 1982), Wierzbanski X-29 papers and general X-29 files, Air Force Test Center History Office.
59. Ibid.
60. Ibid.
61. Philip W. Bruce (program manager), "Forward Swept Wing Technical Activity Report," X-29 ADPO (December 1982), Wierzbanski X-29 papers and general X-29 files, Air Force Test Center History Office.
62. Thomas M. Weeks, "Forward Swept Wing Technical Activity Report," X-29 ADPO (March 1983), Wierzbanski X-29 papers and general X-29 files, Air Force Test Center History Office.
63. Ibid.
64. Ibid.
65. Ibid. For the German F-104 relaxed stability research program, see Horst Prem, "Control Configured Stability," in *Aeronautical Research in Germany: From Lilienthal to Today*, Ernst Heinrich Hirschel, Horst Prem, and Gero Madelung, eds., (Berlin: Springer, 2004), 265.

Sweeping Forward

66. Thomas M. Weeks, "Forward Swept Wing Technical Activity Report," X-29 ADPO (June 1983), Wierzbanski X-29 papers and general X-29 files, Air Force Test Center History Office.
67. Lt. Col. James K. Wansack (X-29 Program Manager), "X-29 Advanced Technology Demonstrator Technical Activity Report," Flight Dynamics Laboratory (November–December 1983), Wierzbanski X-29 papers and general X-29 files, Air Force Test Center History Office.
68. Ibid.
69. Ibid.
70. Ibid.
71. Terrill W. Putnam, "X-29 Flight-Research Program," NASA TM 86025 (1984).
72. Walter J. Sefic (NASA Ames-Dryden X-29A Project Manager), "X-29A Program Plan—Forward Swept Wing (FSW)" (undated, circa 1984), Wierzbanski X-29 papers and general X-29 files, Air Force Test Center History Office.
73. Ibid.
74. W. Smith, "X-29 High AOA Flight Test Results: An Overview," SAE International technical paper 931367, 1993 SAE Aerospace Atlantic Conference & Exposition, Dayton, OH (April 20–23, 1993).
75. Sefic, "X-29A Program Plan—Forward Swept Wing (FSW)," Wierzbanski X-29 papers and general X-29 files, Air Force Test Center History Office.
76. Ibid.
77. Ibid.
78. Ibid.
79. Ibid.
80. Ibid.
81. Ibid.
82. Ibid.
83. Ibid.
84. Ibid.
85. Ibid.
86. Ibid.
87. Ibid.
88. Ibid.
89. Ibid.
90. Ibid.
91. Ibid.
92. Ibid.

From Concept to Flightline

- 93. Ibid.
- 94. Ibid.
- 95. Ibid.
- 96. Ibid.
- 97. Ibid.
- 98. Ibid.
- 99. Ibid.
- 100. Ibid.



Both X-29A aircraft were transported by sea from Long Island to California via the Panama Canal. Here the X-29A-2 arrives at Edwards, still wrapped in protective blue plastic, passing some of the Mojave Desert's distinctive, gnarled Joshua trees, 1988. (NASA)

CHAPTER 3

Initial Flight Testing

Grumman presented the X-29 publicly at a rollout ceremony in Calverton on August 27, 1984. Dr. Robert Cooper, DARPA's director, said the X-29 represented a return to necessary major risk-taking in experimental aircraft development. The principal speaker at the rollout event was then-Vice President George H.W. Bush, a veteran pilot of the Grumman-designed TBM Avenger from World War II, who said the X-29 was evidence that "we are determined not to neglect our technological edge."¹

The FSW X-29, the physical embodiment of all things futuristic, arrived at its first flight destination via a seemingly anachronistic mode—sea travel through the Panama Canal. This was the chosen means of delivery after Grumman looked into the possibility of mounting the X-29 atop NASA's specially modified Boeing B-747 Shuttle Carrier Aircraft (SCA), or using a modified Boeing Super Guppy outsized transport aircraft flying in Europe. NASA voiced some concerns about using the 747 SCA, which at the time was the only one available for ferrying Space Shuttles. Grumman X-29 pilot Chuck Sewell described requests from NASA for wind tunnel modeling and other assurances that mounting and carrying an X-29 atop the SCA would not unduly put the 747 at risk, adding that the time required for this investigation, plus the construction of a special rig to hold the X-29, could consume too much time.²

Lt. Col. Theodore "Ted" Wierzbanski remembered that the discussion about using the 747 to ferry the X-29 across the United States embraced this unique opportunity to gather data in flight. "We talked about having the data system on" during the cross-country trip, he said. "It's basically a flying wind tunnel with the full-size airplane."³ Some airflow interaction between the 747 and the mounted X-29 would have to be taken into account, much as wind tunnel data must subtract the effect of the model mounting forks and pylon.

The Super Guppy—aircraft option would necessitate removal of the X-29's wingtip caps to assure slightly under 2-inches clearance inside the modified Boeing B-377 Stratocruiser transport. Grumman engineers also had to contend

Sweeping Forward

with making a special mounting fixture for the X-29 inside the Super Guppy aircraft, and concerns were expressed about the amount of load the landing gear would take in turbulence if the X-29s were to be ferried with their landing gear extended inside the Guppy. Even an Air Force Lockheed C-5A Galaxy airlifter did not have enough clearance for the X-29. Sewell said nobody wanted to risk trucking the oversized X-29s all the way across the United States from New York to California. The seagoing transportation would necessitate a much shorter truck trip to Edwards Air Force Base from the docks.⁴

These extreme logistics requirements were due at least in part to the X-29's strong, yet light, FSW structure, which incorporated a one-piece box beam from wingtip to wingtip instead of separate and potentially removable left and right wing halves.⁵

Arrival at Edwards

Sea passage to California was accomplished after Grumman made taxi tests at its Calverton facility on Long Island, NY. On one high-speed taxi run at Calverton to demonstrate functionality of all systems, including the flight control system, the system switched briefly to the flight mode.⁶ But first-flight rights belonged to the vast and sparsely populated desert ranges comprising Edwards Air Force Base, on which NASA operated its forward-thinking Ames-Dryden Flight Research Facility.

Though the X-29 program was driven by goals of proving advanced technologies, the effort was continually evolving and necessarily light on its feet at some level. The overwater shipment of X-29 aircraft in 1984 was envisioned, as late as March of that year, to mean both X-29s, as explained in a Grumman memorandum: "Transfer date of both aircraft from Calverton Test Operations (CTO) to DFRF (Dryden Flight Research Facility) will be by shipboard on or about September 6 with first flight expected on or about November 26. The four functional flights are scheduled to extend through 31 December 1984. At the completion of these flights both aircraft will be DD-250 (Material Inspection and Receiving Report) signed over to DFRF."⁷ But only the first X-29 was to be shipped in 1984; the second aircraft would not arrive at Dryden from Grumman until 4 years later.

Shipping the X-29 required preparation of the aircraft to include draining jet fuel and adding preservative to the fuel system, draining and purging the emergency-power hydrazine tank, rendering the oxygen system inert, depressurizing the emergency-power unit nitrogen tank, depressurizing two 600-pounds-per-square-inch (psi) fire extinguisher bottles and removing their activating pyrotechnic squibs, bleeding and filling the hydraulic system, and

establishing about 5-psi pressure in the landing-gear emergency reservoir and accumulators. The cockpit canopy was to be taped, and upper surfaces of the fuselage, canards, wing, strakes, and canopy were to be padded, with the entire aircraft covered with a specially made vinyl cover.⁸

Meanwhile, at Dryden, a modular building was placed on the grounds across the parking lot from the main Dryden complex. This structure was to accommodate the Grumman X-29 team. Years later, even as of this writing, this building subsequently housed Dryden's various public affairs and outreach activities.

Grumman engineer and company X-29 Deputy Program Manager Glenn Spacht's commitment to the X-29 ran deep. When Grumman needed to chase the number one X-29 during high-speed taxi runs approaching takeoff speeds at the company's Calverton operation, Spacht's gold Chevrolet Corvette sports car ably substituted for a chase plane, charging line abreast with the X-29 down the Calverton runway in 1984. The computer-driven canards on the X-29 were an external manifestation of the wizardry that went on inside the computer flight control system. The canards' performance was as good as the data the computers received and interpreted. During taxi runs at Calverton in 1984, it was possible to see the canards go into a seeking frenzy as the X-29 rolled over a seam in the pavement that vibrated an extraneous signal to the aircraft's sensors. The canards would move to counteract the perceived imbalance, and then continue moving because the ground-bound aircraft could not respond as it would later in flight. It was to better understand canard performance in high-speed taxiing that Spacht and a company motion picture cameraman raced the X-29A-1 along the Calverton runway at speeds up to 134 miles an hour.⁹

Nor was Spacht alone in his dedication to the X-29. Grumman Aircraft Systems Division President Renso L. Caporali forsook Long Island, NY, for the Mojave Desert late in 1984. He rented a group of rooms at the Antelope Valley Inn, a legendary gathering spot for the aerospace industry in Lancaster, CA, near Edwards Air Force Base. Caporali, who had an engineering background, personally supervised Grumman's X-29 first-flight activities.¹⁰

Since 1989, the Air Force Flight Test Center has operated a huge anechoic chamber, the Benefield Anechoic Facility (named in honor of Tommie D. "Doug" Benefield, a legendary Air Force and Rockwell chief test pilot lost in the 1984 crash of a B-1A bomber), in which full-size aircraft are subjected to electromagnetic energy to test their systems' resilience to interference, among other things. But in November 1984, this facility was not yet available. Before first flight, the X-29A-1 needed to pass an electronic vulnerability test. The simplest means of doing this was to point the radar of another aircraft in the direction of the parked X-29. Grumman drafted a test plan for the procedure in which its purpose was explained: "The EMV (Electromagnetic Vulnerability) test will demonstrate the ability of the aircraft flight control system to maintain

Sweeping Forward

normal functional operation while operated in the electromagnetic environment of the Base.”¹¹ An earlier component test of the X-29 flight control system had been performed on June 29, 1984. “The assessment concluded the aircraft flight control system can maintain normal functional performance in the electromagnetic environment of Edwards Air Force Base with a 2.5 NM (nautical mile) distance restriction to other aircraft. However, because one... emitter frequency could not be tested and because of the desirability of validating the conclusion of assessment, the Edwards EMV test will be performed.”¹²

The Grumman test description said: “The EMV test...described herein utilizes the emitters at Edwards Air Force Base to radiate at the X-29 aircraft while operating and monitoring the aircraft flight control system.... During the EMV test, the X-29 aircraft is operated on engine power.”¹³ The Grumman test plan, including notes added to the original document, acknowledged the importance of maintaining personnel safety precautions for radiation hazards, engine exhaust, engine noise, and flight control surfaces (which would be subject to movement during the test). “The aircraft cockpit operation and monitoring will be performed by the aircraft project pilot.”¹⁴

In addition to radiating the X-29 with a stationary radar at Edwards, tests would be performed using an F-15 and an F-14, both of which would be modified to permit radar operation while the aircraft was on the ground. (Typically, a weight-on-wheels switch prevents aircraft radar from operating while the aircraft is on the ground to prevent inadvertent danger to ground personnel, who might be too close to the arc of coverage of the radar.) Once a safety spotter confirmed no personnel were in the path of the radar, the test would begin. The radar aircraft would be positioned at set distances from the X-29, radiating it for 1 minute, according to a memo prepared by Air Force X-29 project manager Lt. Col. Wierzbanski. “After one minute the X-29A test team will interrogate the flight computers to determine if the F-15 radar had any effect on the X-29.”¹⁵ Upon clearance of the first test position, the F-15 (and, on a separate day, the F-14) would move forward a predetermined distance and repeat the procedure up to a minimum safe distance that was a factor of two or four times the accepted minimum distance for personnel from the radars being used. Wierzbanski added, “a radiation measuring device will be located by the X-29A to ensure hazardous levels are not reached.”¹⁶ An Air Force Flight Test Center safety office opinion said risks associated with these tests were low.

Preflight Simulations: Sorting out Potential PIO

Taxi testing continued before first flight at Edwards. The expanse of the giant California test base can be discerned from a November 1984 test report: “The

Initial Flight Testing



F404 engine test of the first X-29, November 1984, prior to initial flight trials. (USAF via NASA)

X-29 airplane was taxied from pad 19 to the hot guns area of Runway 04, up Runway 04 and to the hot guns area of runway 22, then to the NASA flightline, a total distance of about 13 (statute miles).¹⁷

Grumman test pilot Chuck Sewell, who would shortly first take the X-29 into the air, noted that

The airplane tracks very well without the requirement to hold the NWS (nosewheel steering) on continuously. It also appears that NWS may not be required during the takeoff roll. Rudder effectiveness speed is about 55 KIAS [knots indicated airspeed]. The airplane will actually respond to full rudder at speeds as low as 50 KIAS, however, the response is too slow to be classified as effective. The airplane maintains 62 KIAS at Flight Idle with 2900 lb. of fuel remaining, and about 57 KIAS at Ground Idle. Flight Idle (about 71% RPM) is too high a thrust setting for any long distance taxiing. It requires a constant riding of the brakes to maintain the desired taxi speed.... The emergency brake will not hold the airplane stationary with 3000 lb. of fuel remaining at thrust settings greater than 82% RPM. The wheel brakes will hold the airplane stationary up to 87% RPM at the same gross weight.¹⁸

The computer flight controls of the X-29 used software that could be adjusted to provide optimal control responses. The software also was a boon to preflight simulations, enabling ground-based flight simulators to give pilots

Sweeping Forward

and engineers a glimpse into how the X-29 was expected to behave in flight. But the most remarkable simulator, as discussed previously, was a modified turboprop variant of a Convair twin-engine transport, the Calspan NC-131H Total In-Flight Simulator (TIFS), which could mimic the control responses of computer-flight-controlled aircraft. Using a forward fuselage section with a separate cockpit grafted ahead of and below the NC-131H's cockpit, the TIFS could be flown by a test pilot in the nose cockpit, with a safety pilot in the regular cockpit ready to revert control of the aircraft if safety warranted. Operated for the Air Force by Calspan, TIFS gave future X-29 pilots actual airborne experience with the software they would use to fly the Grumman jet.

Earlier in 1984, TIFS flying simulations suggested a revamping of the X-29's stick gearing and software lateral-directional gains in digital primary and backup modes following a number of pilot-induced oscillation (PIO) events. On November 16 and 17, 1984, the highly modified TIFS flew multiple landing approaches to the paved runway at Edwards with several future X-29 pilots operating the X-29's flight control software from the front cockpit while TIFS crewmembers used the NC-131's built-in wizardry to simulate everything from wind gusts to control malfunctions.

The potential gremlin of lateral PIO again surfaced during these flights. Lt. Col. Wierzbowski noted several instances where he detected lateral oscillations, or "bobbles," in descent to landing. Toward the end of his time in the seat that day, Wierzbowski flew aggressive approaches in the analog reversion mode of the X-29 flight control software. "I flew these approaches as aggressively and as tight as safety would allow. Safety observers stated that they were as aggressive as they have seen in TIFS. The purpose in doing this was to prove to myself that the X-29A analog reversion mode, as implemented in TIFS, could be safely flown even in a demanding environment."¹⁹ He flew these approaches "as I would a tight F-4 pattern."²⁰ Wierzbowski made an interesting observation about the on-again, off-again sensation of lateral control issues: "On one of the approaches I experienced a slight lateral PIO and on the other I didn't. My own personal feeling is that by the time I had flown these approaches I was so high up on the learning curve that, as an experiment, this exercise was over and that pilot compensation was masking true aircraft (simulated X-29A) flying characteristics."²¹

Ted Wierzbowski recalled that, to his surprise, the PIO was lateral (i.e., in the roll axis) and not longitudinal (i.e., in the pitch axis), where the complicated three-surface control mechanism might be expected to reveal understandable growing pains. "The longitudinal axis was all right," he recalled; "It was the lateral axis. They had fine-tuned the lateral axis on the ground-based simulator and it ended up being a very, very sharp response."²² This led to a significant lateral PIO. "There was no doubt in anybody's mind that there was a tendency

to lateral PIO. First time I grabbed the [TIFS] stick [I thought] ‘this thing is *way* too sensitive!’ Not only sensitive, but it got really jerky in the cockpit,” he recalled.²³

The X-29’s preflight development embraced multiple ground-based simulators as well as the in-flight TIFS aircraft. “We’ve used extensive ground-based simulation throughout the whole X-29 flight control development... probably too many ground-based simulations,” Wierzbanski said. “We’ve finally got it down to a reasonable number. But for awhile there, we had a bunch of simulators.”²⁴ He detected a problem with the visual simulations available from ground-based flight simulators of the early 1980s. Even the Air Force’s Large Amplitude Multi-mode Aerospace Simulator (LAMARS), touted as the premiere ground-based simulator for Air Force development in that era, produced lags detectable to experienced pilots, and this interfered with the realism of the simulation, Wierzbanski said. The simulated representation of the horizon was in the pilot’s peripheral vision. “Well, peripheral vision for things like lateral PIO and flying qualities is very critical,”²⁵ he explained. A 200-millisecond delay in the LAMARS simulator was enough to throw off the similarity between flying the simulator and flying the actual aircraft, he said. He registered complaints about LAMARS’s lack of clarity in its visual system, “the problems with the time delays, and the peripheral system they have.”²⁶ While acknowledging that LAMARS, in its day, was “very valuable in the development of flight control laws,”²⁷ Wierzbanski predicted already in 1984 that another benefit of the X-29 program’s development would be to identify weaknesses in overreliance on simulation. Looking ahead at that time to the ATF development then on the horizon, he observed: “You can’t really use LAMARS to develop the ATF flight control laws unless they improve the visual system... or they’re going to get themselves in the same boat that we did with the X-29, in that we fine-tuned our flight control laws on a ground-based simulator and you go out and fly them and they’re (poor).”²⁸

When the actual X-29 was flying, the conditions that had produced lateral PIO in TIFS were replicated with no such problem recurring. As amazing as TIFS was, it could only mimic what it was told to fly. Evidently, errors in the predicted mathematical model of the X-29, as well as techniques used to make the large TIFS transport fly like the small X-29, led to the discrepancy. Nonetheless, TIFS proved to be an amazing tutor for the X-29.²⁹

Wierzbanski’s recommendations after his November 17 flights in TIFS were influenced by the evidence of lateral PIO tendencies experienced in TIFS: “Based on test results... it appears that X-29A control laws are adequate to begin the flight test program of the X-29A but that the analog reversion (AR) flight control mode still exhibits a lateral sensitivity which could lead to lateral PIO. Because of this I recommend that, unless the AR mode is changed now

Sweeping Forward

to replicate the lateral characteristics of ND (normal digital) and DR (digital reversion), the flight test of the X-29A be restricted to very benign wind conditions and turbulence levels.”³⁰ Wierzbanski further recommended that the restriction should not be removed until either the AR mode was changed “to replicate the lateral characteristics of ND and DR” or unless “the actual aircraft lateral characteristics in the AR mode are evaluated by government pilots and found satisfactory.”³¹

Air Force engineer Fred Webster recalled the lateral PIO question, and its outcome, years later:

Early on, before the first flight of the number 1 X-29, in flight simulations showed that the Analog Reversion (AR) mode might have a relatively severe lateral PIO on approach. We were concerned about this since at the time, we didn't really trust digital controls and thought we might indeed have a very good chance of having to come home in the AR mode. Since the in-flight simulation (the old Calspan TIFS) was not necessarily a high fidelity [simulator], we were not sure how much confidence to place in it. There was a fair amount of professional disagreement as to whether or not the PIO indicated by the TIFS was real or not. We (the USAF and Dryden engineers) therefore wanted to get some flight testing relative to PIO susceptibility and do so early on in the number 1 envelope expansion program. The Grumman folks, and in particular Chuck Sewell, really didn't think the PIO would be present and thought we were somewhat wasting our time with the tests. However, since Dryden had the test safety hat, the side that thought we needed to do some testing won out. We designed some low approach “PIO hunting” handling qualities maneuvers to investigate if the PIO was really present. Chuck Sewell flew these particular flights and they did demonstrate that there was no PIO in the AR mode for the X-29; the TIFS had been in error. After finishing the tests, we were in the de-briefing and I can still recall Chuck saying to me in a good natured way: “Well Fred, are you satisfied that there are no damn PIOs in the AR mode now?”, [t]o which I replied[:] “Yes Chuck, I'm satisfied”. I think I really remember it because I was struck by how Chuck managed to get his point across that he had been right, but did it in a fashion and tone that was good-natured and light-hearted, therefore saving my young engineer's ego from too much bruising. I have tried to keep this in mind over my career as I deal with young engineers.³²

During the same series of TIFS landing approach sorties November 16 and 17, NASA research pilot Rogers Smith also flew the replicated X-29 computerized flight control system. Smith methodically divided his testing into two categories. Sometimes, he would fly the TIFS/X-29 “in an aggressive fashion employing a variety of pilot techniques to explore the flying qualities and hopefully expose any deficiencies.”³³ At other times, Smith flew the aircraft “to achieve the best possible performance using all your available compensation skills.”³⁴ With the X-29 TIFS setup, he concluded that the normal digital flight control system suggested the X-29 would be “a good aircraft all around.... It could be flown instinctively with confidence for all tasks.”³⁵ He found the AR mode in need of fixing as the other modes had already been, and he had “generally no difficulties” in the DR mode. The throttle was a different story. Smith was succinct: “The throttle is terrible; if the simulation is correct then something should be done to bring this new aircraft up to the standards of an old aircraft like the [F-104 Starfighter]. The throttle is too sensitive and the initial forces are very high.”³⁶ Based on the most realistic simulation available to anyone at the time, Smith concluded: “...the AR mode clearly has a latent lateral PIO problem. This feature represents a risk to the X-29 program. In the context of the four flight program with its flight restrictions and a highly trained, skillful pilot...this risk is acceptable.”³⁷

Grumman’s Chuck Sewell, who was to be first pilot of the X-29, flew TIFS sorties in mid-November. His November 14 flights included simulated anomalies and outages, one of which involved an aggressive control correction from a lateral offset.

Some pitch transients and/or coupling were observed during the offset correction maneuver combined with degraded airspeed control. This was undesirable and unacceptable. Lateral control was very sensitive. A lateral PIO occurred just prior to touchdown, excited by less than \pm one inch of lateral stick. I did not attempt to damp it as it was actually damped by airplane touchdown.... The PIO did not prevent a successful landing from being performed, however, it was highly unsatisfactory. The second approach and landing in ACC did not have a PIO as I was careful not to excite the lateral mode. Gusty and/or turbulent conditions would do this automatically, however. It must be determined if this situation is real. If it is, then an ACC landing is unsatisfactory.³⁸

Sewell also performed a landing with the rudder simulated to be inoperative and faired, with no crosswind. He had no problem with this configuration. “Lateral offset maneuvering and careful control inputs did not excite the Dutch

Sweeping Forward

roll mode. Due to the high probability of a crosswind exciting the Dutch roll mode, a lakebed landing should be considered rather than a crosswind landing or the runway.”³⁹

The following day, Sewell again flew the TIFS at Edwards. He expressed confidence at the outcome that day. Sewell said he was not given an advance notice of which of the three available flight control modes he was flying each time. “As on previous TIFS evaluations, I found it impossible to determine which mode I was flying. I found all three modes to have Level 1 flying qualities and to be entirely satisfactory.... [T]he X-29 FCS (flight control system) enables the airplane to be flown precisely, safely, and with a large amount of confidence.”⁴⁰ Sewell noted one problem when trying to take the TIFS out of a crab in a crosswind situation, but as an experienced pilot, he quickly determined that “a wing down, top rudder crosswind correction was found to be highly satisfactory and easier to fly, and resulted in well controlled sink rates at touchdown.”⁴¹ Sewell concluded his report by saying: “if the X-29 airplane flies as well as the TIFS X-29 model, we should be very pleased.”⁴² He added kudos to the TIFS aircraft and its team of operators: “The TIFS airplane is an outstanding engineering and training tool, and has done much to inspire confidence in me regarding the X-29 flying qualities. It has also greatly aided the development and enhancement of the X-29 FCS. The TIFS crew should be commended for their excellent performance and cooperation during this exercise.”⁴³

Air Force pilot Lt. Col. Edwin A. Thomas, then director of the F-16E Combined Test Force, flew the X-29/TIFS on November 16. He noted: “In general, the configuration was responsive and predictable. The only objectionable characteristic noted was very high throttle friction that resulted in a substantial, and unnecessary, increase in pilot attention to power changes.”⁴⁴ Lt. Col. Thomas described his introduction to the analog reversion mode, which other pilots acknowledged performed differently than the digital modes:

Run five was my first exposure to AR (under benign conditions), and I felt that I was able to put the airplane where I wanted it in spite of a perceived lateral sensitivity and the aforementioned high throttle friction. Run six was a classic example of a ‘handling qualities cliff’ where the increased lateral stick activity required by the crosswind and offset approach developed into a full-blown lateral PIO in the round-out. The safety pilot took control of the aircraft from me several feet above the runway. Runs seven and eight, both offset approaches with a crosswind, required very close pilot attention and slow, smooth lateral inputs to avoid the oscillation seen on run six. The result was high pilot workload, a

general rushed feeling, new problems in pitch due to inattention and a poor job ruddering out of crab prior to runway contact.⁴⁵

Thomas commented further on the increased pilot workload in analog reversion flight control mode. As a member of the X-29 Flight Readiness Review board, he commented on the TIFS/X-29 experience with caveats: “the last two approaches showed that an inexperienced X-29 pilot can land the AR configuration safely on a long wide runway under near ideal conditions. The minimizing procedures established by the FRR are appropriate because, by my direct experience, this configuration is highly PIO prone. It is my opinion that the aircraft could be landed in the AR mode without excessive risk under carefully controlled conditions including an experienced pilot with demonstrated capability to get desired performance; little or no crosswind; adequate fuel reserve to allow multiple approaches; a long, wide runway; and remainder of the aircraft fully functional.”⁴⁶ He added: “There is no reason to delay the Grumman four-flight test program due to handling qualities concerns with the AR mode.” He also stressed the need for NASA to “make corrections to the lateral characteristics of the AR mode one of their highest priorities. Similarly, throttle friction should be reduced at the earliest opportunity.”⁴⁷

Grumman pilot Kurt Schroeder took several turns at the TIFS in mid-November. Like his corporate compatriot Sewell, Schroeder noted lateral control issues. In some configurations, gusts could pose problems. “The [TIFS] results correlated very well with the Plant 14 [Grumman Bethpage] simulation conclusions; ability to land the airplane will be a function of the existing atmospheric conditions. TIFS approaches in normal turbulence were abandoned due to the roll and yaw excursions during the approach, but the airplane could be successfully landed when the turbulence level was cut in half. The damping provided by the lateral axis is adequate to eventually damp the Dutch roll after even an aggressive lateral maneuver, however, the gain is insufficient when the constant excitation provided by turbulence is present.”⁴⁸

Following his flight on November 16, 1984, Schroeder commented further about the TIFS/X-29 system. He said: “At normal approach airspeeds, AR mode is more sensitive laterally and does warrant improvement when the expanded envelope gains are incorporated. Until that time, the limited number of pilots in the program should be able to compensate for the characteristic.”⁴⁹

December 4 and 5 saw the first high-speed X-29 taxi tests on Runway 04-22, the 15,000-foot-long runway at Main Base. Data showed “satisfactory rudder effectiveness was obtained at 55 KIAS.”⁵⁰ For these taxi runs, ground stations were staffed at Edwards as well as at Grumman’s Calverton, Long Island, facility where some initial X-29 taxi tests took place. During the high-speed taxi work-ups at Edwards, designated first pilot Chuck Sewell gained an

Sweeping Forward

appreciation of the X-29's capabilities and limitations: "Airplane deceleration at ground idle (engine throttle setting) was very slow and considerable braking was required to reduce to taxi speed. The residual thrust at ground idle is apparently considerable. The X-29 is definitely not a short airfield airplane."⁵¹

Later, when engineers extrapolated some high-speed taxi data to simulate flight conditions, the simulation showed a "concern for a possible unacceptable inflight lateral control situation,"⁵² a Grumman test report explained. Another look at the possible lateral control issues led Grumman to some mechanical maintenance. "Accordingly, after...uncovering and resolving a main gear servicing anomaly, additional taxi tests reported herein were conducted. Based upon the taxi test results...the contractor considers the aircraft ready for first flight."⁵³ The X-29 aircraft was married to its simulators, including TIFS, and simulation helped probe X-29 flight parameters before the unorthodox aircraft took to the sky.

The discussions by pilots who experienced lateral control issues in TIFS in November illuminate the flight-test process. Many acknowledged a problem, but none wanted it to delay first flight of the X-29. The ultimate outcome, determined by NASA to be a variation in simulation performance versus actual aircraft characteristics, provides guidance on both the value of simulation and the need to compare simulation to actual flight data for cross-check validation.

Before first flight, Ted Wierzbowski described the TIFS evaluations to then-AFFTC historian Richard P. Hallion: "The government pilots basically rated the airplane, especially in its back-up modes, a level-three airplane.... The contractor pilots rated it at level one."⁵⁴ Level one in the accepted Cooper-Harper ratings scale was the best; level three was cause for concern; and level 10 was the worst. Changes were made in the airplane's computer control laws, Wierzbowski said. "And we went back and re-evaluated it and...improved it to where, in the normal modes, it's borderline level-one, level-two airplane. Not a great airplane, but it's flyable...in power approach...."⁵⁵

Wierzbowski suggested the differences in the initial TIFS ratings given by Government pilots compared to the higher ratings given by the company pilots may have stemmed from differing assumptions. He said, "the reason we rated it as low as we did and the potential reason for Chuck [Sewell] and other company pilots rating it as high as they did [may be] just a difference in what we were trying to do. We were evaluating the flying qualities of the airplane against a specific task.... It appeared to us from the words that were being spoken that the contractor guys were evaluating whether or not they could fly the airplane.... [which is a] different question."⁵⁶

The taxi tests of December 7, 1984, saw the X-29 rotate its nose as high as 10 degrees at speeds as high as 140 KIAS. A fine line separated high-speed taxiing and flying; on two taxi runs that day, the X-29 rotated off the nosewheel and

lifted its weight off the mainwheels. (Weight-on-wheels switches confirmed this.) Chuck Sewell gave his endorsement after the taxi runs that day: “In my opinion, the airplane is ready for the first flight.”⁵⁷

Due to delays, the first flight was about a year behind schedule. Grumman had a fixed-price contract, which meant the company was paying for work out of its own funds until the milestone of first flight and handing the aircraft over to the Government. Wierzbanski said Sewell did not appear pressured to execute the first flight too soon in an effort to please some in company management. “Chuck...did really well in keeping the management issues—or the pressure of flying the airplane and getting four flights over with—so that we didn’t get ourselves in any kind of safety problems. He really didn’t do anything until he knew we were ready to do it.”⁵⁸

Into the Air

December in the Mojave Desert brings relief from the triple-digit heat of summer. On the morning of December 14, 1984, the winter sun yielded only 43 degrees Fahrenheit as a lull in recent winds finally gave flight conditions suitable for the radical X-29’s first takeoff. Grumman’s Chuck Sewell brought the F-5A canopy down on the X-29 with its simple mechanical overcenter closure mechanism. To maximize the jet’s internal-only fuel capacity, its tanks were topped off at the runway “last chance” apron. The slim X-29 taxied the last few feet to the end of the nearly 3-mile-long Edwards Runway 04. Years of design, construction, simulation and practice built up to this moment as Sewell finished end-of-runway checks and moved the X-29’s single throttle forward with a minimum of delay as he sought to retain maximum fuel at takeoff. Upward deflection of the strake flaps and pitch-correcting twitches of the canards accompanied Sewell’s historic first takeoff in the X-29.⁵⁹

Sewell described his first takeoff in the X-29A:

Normal takeoff technique was used, accelerating the engine to 85% RPM, disengaging NWS [nosewheel steering], and selecting military thrust as the brakes were released. The FCS [flight control system] was in normal digital [ND] mode. The brakes will not hold the airplane above 89% RPM. NWS should not be used during the takeoff roll as it greatly increases the risk of directional divergence on the runway. The rudder became effective at about 55 knots. Differential braking can be used for directional control until the rudder is effective. Nosewheel liftoff occurred very smoothly and nose position was easily and precisely controlled.

Sweeping Forward



First flight of the X-29, December 14, 1984, at Edwards AFB. Grumman test pilot Chuck Sewell kept the landing gear down throughout the flight, which reached 15,000 feet. (USAF)

Canard position at nosewheel liftoff was 17 degrees LEU [leading edge up]. Nosewheel liftoff speed was 139 KIAS. Airplane liftoff occurred at 154 KIAS...and was smooth and easily controlled.⁶⁰

The landing gear remained extended during this pioneer first flight, a common practice with untried aircraft. Sewell kept the X-29's pitch attitude low until he gained a feel for the new airplane, and then the Grumman test pilot increased pitch to about 25 degrees for the military thrust climb. Sewell judged the X-29's takeoff roll, liftoff, and climb characteristics as excellent while observing two differences from the simulator: "The nosewheel liftoff was more easily achieved in the airplane and occurred at a lower airspeed."⁶¹ Shortly after that first flight, Sewell pondered a potential reason: "Possibly, our nose down moment due to thrust is too strong in the simulation."⁶² He also noted actual takeoff airspeed "was about 20 knots less in the airplane than in the simulator," although a predicted value for this was within a half-knot of calibrated airspeed.⁶³

Sewell leveled the X-29 at 15,000 feet in normal digital flight control mode with moderate turbulence, which made it difficult to trim the airplane. "The turbulence resulted in an airspeed fluctuation of ± 3 knots," Sewell reported, "and made the airplane feel very 'loose' in all axes and trimming difficult."⁶⁴ Two chase aircraft observed the X-29 during its first flight. Sewell wrote: "The #2 chase pilot remarked after the flight that, when #1 chase was on my wing,

#1 chase airplane was bouncing around significantly more than the X-29 was. Apparently, the FCS is performing extremely well in smoothing out perturbations resulting from the turbulence.”⁶⁵

Sewell noted the X-29’s handling qualities: “A 5 degree sideslip required about 7-8 degrees wing down in the opposite direction for a steady heading,” he reported. “Pitch, bank angle, and heading captures were easily performed. Bank angle changes with just over one-half lateral stick deflections were also easily performed and no problems were noted. The airplane pitched down slightly during rolls. An HQR [handling qualities rating] of 2 was assigned....”⁶⁶ (A rating of 2 is used to describe aircraft characteristics that are good, with negligible deficiencies.)

Sewell said the X-29 differed in actual flight from previous simulations in several ways: “The simulator did not show a negative dihedral effect. Trim [engine] RPM was 6% less in the airplane. The nose of the airplane dropped more in the simulator than in the airplane during rolling maneuvers. The airplane was easier to trim and to fly precisely.”⁶⁷ The pilot flew maneuvers in the airplane in all three flight control system modes—ND, DR, and AR. “The transitions to and from the degraded modes were absolutely transient free and no problems were noted. As in the simulator and the TIFS, I could not determine any difference between the FCS modes and an HQR of 2 was assigned for each mode.”⁶⁸ Though some specific flight operations in the airplane were different than in the simulator, Sewell said: “Qualitatively, the airplane and the simulator behaved identically.”⁶⁹ This argued for the continued use of simulation in this and other flight research programs. Turning maneuvers while descending with a pitch down attitude of 5 to 7 degrees resulted in significant airspeed increase. “The X-29 is a very ‘slick’ airplane and difficulty in maintaining a desired airspeed and a good rate of descent will probably be encountered,” he opined.⁷⁰

Sewell performed some simulated landing approaches at altitude before descending back to Edwards. Still experimenting, he made a low approach with a military thrust waveoff and climbout with a pitch attitude of about 30 degrees. “There was no apparent pitch transient due to thrust changes,”⁷¹ he reported. Sewell came in for a full stop landing at about 167 KIAS. “Airspeed and attitude control in the landing approach and landing were excellent, HQR 2. A crosswind from the left was easily handled with a left wing low touchdown at a very low sink rate,”⁷² he said. “In my opinion, our recommended airspeed for landing approach is too high, as I stated several months ago after several simulator evaluation sessions using lower approach airspeeds. The airplane floated during the flare and wasted too much of the runway.... The landing approach, landing, airspeed control and thrust management were more easily controlled in the airplane than in the simulator.”⁷³

Sweeping Forward

Sewell briefly described the first flight of the X-29: “In summary, the X-29 within the scope of these tests, exhibited excellent flying qualities and performance. The acceleration on takeoff with military thrust and the climb were impressive.”⁷⁴ Discounting minor issues, he said the airplane systems “functioned as per design.”⁷⁵ He praised the Grumman design, engineering, and manufacturing teams. “It is absolutely amazing to me that an airplane this complex can be built and flown, and return with no discrepancies. It certainly says a lot for how GAC [Grumman Aerospace Corporation] designs and builds airplanes. And it sure makes my job easier and less risky.”⁷⁶

In addition to Dryden and Edwards AFB facilities participating in the first flight, structural loads data, including all-important wing-bending moments, were monitored across the United States at Grumman’s Calverton facility. The first flight report said all parameter values “were well within flight allowable load levels as expected.”⁷⁷ The X-29’s first flight, simultaneously symbolic and substantive, was an unqualified success that opened the door to envelope expansion and flight research with the FSW demonstrator.

Frustration: Weather and a Flooded Lake Forces Flight Test Delays

Freak snows caused the X-29 team to stand down in the desert until February. Ted Wierzbanowski recalled: “we had some weather problems with snow all over the lakebed.”⁷⁸ One of Edwards Air Force Base’s assets is the huge (and usually dry) lakebed immediately east of and contiguous with the paved runway. This hard, dry lakebed has been the saving grace for many test aircraft in trouble. Takeoff from the paved Runway 04 toward Rogers Dry Lake “was one of the game rules we decided on in the FRR [Flight Readiness Review].... [W]e had to have lakebeds available to land on for the first couple of flights until we understood the airplane a little bit better.”⁷⁹

Test pilots embrace the need for safety; an old saw wryly says pilots had better appreciate safety because they will be the first ones at the scene of a crash. In January 1985, Grumman X-29 pilot Chuck Sewell had to contend with a wet Rogers lakebed that precluded conducting Flight Two since the Flight Readiness Review process had called for having a lakebed runway available for emergency use during this early phase of flight testing the X-29. Meanwhile, Grumman’s interests would be served by getting the first four flights out of the way so that the fixed-price contract that was costing the company millions of dollars could be finished. Sewell had already shown that his stewardship of the X-29 to this point included a methodical interest in keeping it safe. Nonetheless, in January 1985, nobody could have forecast the duration the

wet lakebed would be out of service for, and Sewell sought a safe alternative to continue flight testing the X-29. On January 15, he wrote to Renso L. Caporali, Grumman's technical operations senior vice president, recommending continuing X-29 flights without a dry lakebed backup. "The winter rains and snow have rendered the Rogers dry lakebed unusable for even emergency landings,"⁸⁰ Sewell wrote. "The duration of this situation is unknown but could last for as long as three months, depending on subsequent precipitation."⁸¹ The infrequent rains over the Mojave Desert can be just unpredictable enough at that time of year to cause uncertainty. Rogers Dry Lake is a natural catch basin for desert rain runoff. It is that occasional rain pooling over the lakebed that naturally resurfaces Rodgers, making it useful again for aircraft operations when it dries out. In the face of this uncertainty, Sewell reminded Grumman that at one time, the company had determined "that the initial four flights of the X-29 airplane could be safely and efficiently flown from Calverton. We are now located at Edwards AFB, with a 15,000 foot runway instead of the 10,000 foot one at Calverton, and have successfully flown one flight in the X-29. Data obtained from this first flight show that all the airplane systems, and especially the Flight Control System and propulsion system, performed as per design."⁸² Based on this, Sewell said, "it is strongly recommended that we proceed with the X-29 flight tests without the requirement that a lakebed runway be available."⁸³

Sewell proposed that such flights be made only if no cloud cover existed below test altitude. "This will enable the X-29 pilot to depart from and return to the airfield under visual conditions and maintain airborne visual orientation on the Edwards AFB hard surface runway."⁸⁴ Sewell also recommended that flights be made only if winds were light "and forecast to not exceed the wind limitations placed on the X-29 test flights."⁸⁵ Sewell said that the X-29 flight pattern could be oriented to keep the airplane within engine-off gliding distance to the paved runway at Edwards AFB. Should changes in wind speed and direction occur while the X-29 was airborne, Sewell said the nearby Mojave and Palmdale airports could be considered as alternative recovery sites, although he considered the likelihood of this happening during the brief flight time of the X-29 to be "extremely low." And, to keep him in readiness for a potential deadstick landing on the paved runway, Sewell requested: "NASA Dryden must provide the T-38 for simulated flameout [SFO] practice flights in order for me to become and remain proficient in SFO approaches. Two consecutive flights followed by one flight per week should ensure a high level of proficiency and a strong confidence in my ability to successfully land the X-29 on the 15,000 foot hard surface runway from any position in the flight test pattern."⁸⁶

When Lt. Gen. Thomas McMullen, then the USAF Aeronautical Systems Division commander, asked questions about X-29 flight requirements and

Sweeping Forward

decisions later in January, Air Force Wright Aeronautical Laboratories provided background: “ASD is the release authority for the first four flights. Colonel [Larry] Van Pelt, who chaired the X-29 Flight Readiness Review [FRR,] has been acting as your [ASD’s] agent in releasing the airplane for flight.”⁸⁷ The first X-29 flight came with the FRR requirement to have two alternate runways available, and it required takeoff on Runway 04 at Edwards to permit overrun onto the lakebed should it become necessary. AFWAL’s commander said:

For runway availability on flights 2-4, Colonel Van Pelt has subsequently counseled with the program office, the government pilots, FRR members and Mr. Marty Knutson, who is Director of Operations at the Dryden Flight Research Facility. All have recommended that three miles of lakebed Runway 17 availability is more than sufficient as an alternate to the primary Runway 04-22. We have concurred with this recommendation based on: 1) a review of first flight results that show flight test data right on top of all predictions e.g. structures and flight controls system; 2) flying under specified crosswind limitations...and 3) keeping the flight profile within 10NM [nautical miles] of the airfield (also specified earlier by the FRR). We therefore recommend that the aircraft be released for flights 2-4 with one alternative lakebed runway available that provides a good crosswind alternate to Runway 04.⁸⁸

Fortunately for the X-29 program schedule, the lakebed continued to dry out during January 1985. A January 28 letter from the AFWAL commander reported: “The lakebed is drying out and we now have the first 15,000 feet of Runway 17 to use as an alternate to Edwards hard-surface Runway 04-22. We are buttoning up the aircraft and will do an engine run and another taxi test before flight #2 which is scheduled for Friday 1 Feb 85. Our second flight may not occur until 4 or 5 Feb 85 because we are running into a problem with availability of the NASA control room due to the current Shuttle mission.”⁸⁹

This vignette captured another aspect of operations at Edwards Air Force Base for three decades, coming to an end only with the last Space Shuttle mission in 2011: the Space Shuttle was a huge program with often immovable mission requirements that both took precedence over and disrupted the plans of other activities. Regardless of the Shuttle’s intended landing site, Edwards Air Force Base’s role as the alternate landing site meant NASA and Air Force personnel and assets were required to be poised for action during all Shuttle missions. Mission shifts and weather delays often changed the need for this readiness daily. All at Edwards knew this, and they adapted continually to meet the Shuttle’s needs.

Back Into the Air, and a Contractor-Air Force Contretemps

A drying lakebed put an end to talk of alternate airfields or concerns about 3-month delays; Sewell logged the second flight on February 4, 1985. When the X-29 took off from Edwards on February 22, 1985, for its third flight, Chuck Sewell had 10 ambitious objectives to meet:

- Check aircraft response during transitions to reversion modes.
- Evaluate flying qualities in digital reversion and analog reversion modes with the aircraft in the power approach and up-and-away configurations.
- Conduct functional test of paddle switch operation and evaluate resultant aircraft transients to mode switching.
- Evaluate normal load factor (Nz) limiter functional operation and resultant aircraft transients.
- Evaluate normal-ACC flying qualities at limited envelope maximum speed.
- Evaluate aircraft/system characteristics during 360-degree roll.
- Evaluate engine operability during nonafterburner power transients.
- Conduct afterburner operational check to minimum and maximum afterburner.
- Evaluate simulated flameout approach flight profile.
- Clear aircraft to 300 knots/7,000 feet for aeroservoelasticity.

All of these test objectives were met with no aircraft anomalies noted. Maneuverability and handling qualities of the X-29 were good, and they generally matched simulation forecasts except for dihedral effect, which the simulator showed as positive in all configurations. In actual flight, the X-29 exhibited negative dihedral effect and weak positive dihedral effect in some modes.⁹⁰

The first three flights of the X-29 used a methodology that proved successful and efficient. As described in the Grumman flight report:

This third flight of the X-29 airplane followed the pattern of the first two flights and was highly successful. Approximately 138 data points were successfully accomplished during this 1.3 hour flight. The test maneuvers were stepped through without delay due to having flown the flight several times in the simulator. The flight test engineers were, therefore, very familiar with the test maneuvers and the expected results because of the excellent correlation between the simulator and the airplane. The aerodynamicists and the simulator people on the X-29 program should be congratulated for their outstanding efforts in generating such accurate data.⁹¹

Sweeping Forward

The benefits of modeling and simulation in the X-29 program extended beyond giving pilots and engineers confidence. By practicing flights first on the simulator, X-29 engineers saved time during the more costly and limited flight duration of the actual aircraft. Later in the program, test pilot Maj. Harry C. Walker III characterized the benefit of piloted simulations: “During the course of the flight test the X-29 test team made valuable use of a hardware in the loop piloted engineering simulation. This simulator became an indispensable tool for mission planning, maneuver practice, validation and verification of software changes and prediction of vehicle response. The ability to progress rapidly through the test was in large measure due to this tool.”⁹²

The flight control software team at Dryden used IBIT (Initiated Built-In Test) to exercise the X-29’s controls to ensure that inputs and outputs occurred in real time the same way as predictions had modeled. If inconsistencies developed, the IBIT test enabled engineers to track the source of the problem. In some cases, it proved to be electronic; at other times, IBIT could reveal mechanical flaws in actuators that required replacement. Software engineer Joel Sitz affirmed the value of having the X-29 simulator at Dryden in proximity to the actual aircraft, where engineers and pilots could check changes and practice techniques conveniently. “For the most part we solved the problems on the ground before we took off.”⁹³ With the hardware-in-the-loop and aircraft-in-the-loop simulation capabilities at Dryden, Sitz recalled, “it was a very productive way to develop and test software changes, such as the Built-in-Test software changes which exercised all the critical input-output signals to the digital control system.”⁹⁴

During that third flight, for reasons probably forever lost, Chuck Sewell performed a roll at 5,000 feet—something not on the test cards for that day’s mission. The unintended consequence was to place the Air Force in an awkward position, since it had responsibility for safety-of-flight issues during the first four contractor flights before the X-29 was to be handed over to NASA. Ted Wierzbanski was in the control room when the unannounced roll occurred, and he recalled that the Center’s leadership did not think it could be overlooked, especially as it came after other recent incidents by test pilots doing things not on the test cards. Maj. Gen. Peter W. “Peet” Odgers, the Commander of the Air Force Flight Test Center, subsequently decided to ground Sewell as long as the service had safety of flight responsibility.⁹⁵

NASA was not pleased with the impromptu rolling of the X-29 either. Rogers Smith recalls the day: “I was a chase pilot for the flight but I did not see the roll. I left as soon as the last data point was completed and, not wanting to delay the X-29 in the landing pattern, raced my fuel hungry F-104 to initial for a quick landing. Walking back to Dryden Ops after landing, I was stopped by a clearly agitated USAF colonel who wanted to know if I saw the

roll. I hadn't but I was stunned that it had occurred. Up to the point of my departure from the test flight, I had been very impressed with Chuck Sewell, the test pilot. He did an outstanding job."⁹⁶ Which made the roll all the more baffling. The X-29 represented such a huge leap in aeronautics and systems that its most basic operations were initially considered high risk by some. Smith recalled: "We (NASA/GAC) received several letters from well-founded technical people telling us 'not to fly this highly unstable, unique planformed aircraft' because it was 'too dangerous.'"⁹⁷ And now, on its third flight, the X-29 had been rolled, taking the airplane outside the limits of its cleared envelope at that time, Smith explained. The roll was not on the test cards for the mission, and Sewell had not informed the control room of his intentions to roll the X-29. Accordingly, Dryden management concurred with the Air Force's decision to remove Sewell from the contractor flight phase of X-29 operations, though he eventually returned to flight. "Once the test program began with NASA Dryden as the Responsible Test Organization, Chuck was permitted to join the test pilot rotation,"⁹⁸ Smith said. The event had consequences for Sewell, and now "his experience and skills were recognized as important to the program."⁹⁹

In retrospect, it illustrated how much the climate of High Desert flight testing had changed over 37 years: back in 1947, a curious Capt. Charles E. "Chuck" Yeager had likewise spontaneously rolled the Bell XS-1 during his first glide flight in the experimental rocket plane, following this up with a two-turn spin on his next flight—neither maneuver on its approved test card—incurring nary a protest, aside from a stunned comment by NACA test pilot Herbert H. Hoover to Langley laboratory's leadership that "this guy Yeager is pretty much of a wild one."¹⁰⁰ In the 1960s, when North American Aviation contractor test pilot Scott Crossfield rolled the second of three rocket-powered X-15s, his excursion was not fully grasped until a day or two after the flight when onboard motion picture film was processed, showing the spinning horizon. He received a verbal recommendation that he should avoid a repeat of the maneuver. In any case, this contretemps resulted in Grumman test pilot Kurt Schroeder strapping into the X-29 for its fourth and final contractor flight on March 1, 1985.

The removal of Chuck Sewell from X-29 flights under Air Force control caused a ripple of resentment in some corners of the contractor test pilot community, though Sewell, a crusty Marine fighter veteran, was more bemused than angered by the decision. Decades later, the topic of Chuck Sewell rolling the X-29 could still spark lively debate among those who believed his short-lived grounding from the X-29 was necessary and inevitable and those who instead focused on Sewell's body of test-flying work. Some contractor test pilots already were suspicious of increased involvement by the Air Force early

Sweeping Forward

in service test programs, and Sewell's removal, though of only short duration, heightened their concerns. From the Air Force's standpoint, the placement of Air Force pilots earlier in the test process of most aircraft was simply showing good stewardship, and it was itself a long-standing practice, dating to the insertion of test pilots Chuck Yeager and Robert "Bob" Hoover into the original XS-1 program back in June 1947. This was another event that had, at the time, prompted similar unease about the role of military pilots in the early stages of contractor flight-test programs.¹⁰¹

Endnotes

1. W.P. Schlitz, "Aerospace World News, Views, and Comments," *Air Force Magazine* 66, no. 2 (October 1984), Wierzbowski X-29 papers and general X-29 files, Air Force Test Center History Office, Edwards AFB, CA.
2. (Author unlisted.) "Grumman Seeking Way to Ship X-29 Aircraft to Edwards AFB," *Aviation Week & Space Technology* (June 25, 1984), Wierzbowski X-29 papers and general X-29 files, Air Force Test Center History Office.
3. Wierzbowski, interview with Frederick A. Johnsen, September 24, 2011.
4. "Grumman Seeking Way to Ship X-29 Aircraft to Edwards AFB," Wierzbowski X-29 papers and general X-29 files, Air Force Test Center History Office.
5. Spacht et al., "Unusual Aerodynamics of X-29," Wierzbowski X-29 papers and general X-29 files, Air Force Test Center History Office.
6. Ibid.
7. T. Taglarine to J. Calandra, memorandum, "Subj: Site Survey, Dryden Flight Research Facility (DFRF), 3/5/84," Grumman 712/ENG-M-84-087 (March 12, 1984), Wierzbowski X-29 papers and general X-29 files, Air Force Test Center History Office.
8. Ibid.
9. Spacht interview by Johnsen.
10. John Retelle, interview by Frederick A. Johnsen, October 17–18, 2011.
11. P. Plate (Grumman Aerospace Corp.), "Test Procedure No. 712/ENG-RPT-84-048, Electromagnetic Vulnerability (EMV) Test of X-29 Advanced Development Aircraft at Edwards Air Force Base" (November 4, 1984), Wierzbowski X-29 papers and general X-29 files, Air Force Test Center History Office.
12. Ibid.
13. Ibid.
14. Ibid.
15. Lt. Col. Theodore J. Wierzbowski (USAF, AFFTC X-29A Project Manager), memorandum, "Subj: X-29A Electromagnetic Vulnerability Test" (undated, but circa November 1984), Wierzbowski X-29 papers and general X-29 files, Air Force Test Center History Office.
16. Ibid.

Sweeping Forward

17. C. Sewell to W. Cutler, memorandum, "Subj: Observations Made During X-29 Taxi on 11-26-84 at Edwards AFB, California," Grumman Aerospace Corp. (November 27, 1984), Wierzbanski X-29 papers and general X-29 files, Air Force Test Center History Office.
18. Ibid.
19. Lt. Col. Theodore J. Wierzbanski (AFFTC X-29A project pilot), "X-29A Total In-Flight Simulator (TIFS) Flight Test Pilot Report" (November 17, 1984), Wierzbanski X-29 papers and general X-29 files, Air Force Test Center History Office.
20. Ibid.
21. Ibid.
22. Wierzbanski, interview by Hallion.
23. Ibid.
24. Ibid.
25. Ibid.
26. Ibid.
27. Ibid.
28. Ibid.
29. Mary F. Shafer, "In-Flight Simulation Studies at the NASA Dryden Flight Research Facility," NASA TM 4396 (1992).
30. Wierzbanski, "X-29A Total In-Flight Simulator (TIFS) Flight Test Pilot Report," Wierzbanski X-29 papers and general X-29 files, Air Force Test Center History Office.
31. Ibid.
32. Fred Webster, e-mail message to Frederick A. Johnsen, October 24, 2011.
33. Rogers E. Smith, "Pilot Report, X-29/TIFS Evaluations" (November 16–17, 1984), Wierzbanski X-29 papers and general X-29 files, Air Force Test Center History Office.
34. Ibid.
35. Ibid.
36. Ibid.
37. Ibid.
38. C. Sewell, "Grumman Flight Report, TIFS" (November 14, 1984), Wierzbanski X-29 papers and general X-29 files, Air Force Test Center History Office.
39. Ibid.
40. C. Sewell, "Grumman Flight Report, TIFS" (November 15, 1984), Wierzbanski X-29 papers and general X-29 files, Air Force Test Center History Office.

41. Ibid.
42. Ibid.
43. Ibid.
44. Lt. Col. Edwin A. Thomas (Director, F-16E Combined Test Force), "Handling Qualities Evaluation of X-29A Inflight Simulation (TIFS III)" (November 29, 1984), Wierzbowski X-29 papers and general X-29 files, Air Force Test Center History Office.
45. Ibid.
46. Ibid.
47. Ibid.
48. K. Schroeder, "Grumman Flight Report, TIFS" (date partially obscured, November 1984), Wierzbowski X-29 papers and general X-29 files, Air Force Test Center History Office.
49. K. Schroeder, "Grumman Flight Report, TIFS" (November 16, 1984), Wierzbowski X-29 papers and general X-29 files, Air Force Test Center History Office.
50. Ibid.
51. C. Sewell, "Grumman Flight Report, X-29" (December 4-5, 1984), Wierzbowski X-29 papers and general X-29 files, Air Force Test Center History Office.
52. (Author unlisted.) "Forward Swept Wing Demonstrator X-29 Aircraft No. 1 Functional Check Flight Test Report No. 2 - High Speed Taxi," report no. 712/360/FLT-RP-84-02 (December 10, 1984), Wierzbowski X-29 papers and general X-29 files, Air Force Test Center History Office.
53. Ibid.
54. Wierzbowski, interview by Hallion.
55. Ibid.
56. Ibid.
57. "Forward Swept Wing Demonstrator X-29 Aircraft No. 1" (December 10, 1984), Wierzbowski X-29 papers and general X-29 files, Air Force Test Center History Office.
58. Lt. Col. Ted Wierzbowski, interview by Dr. James Young, AFFTC History Office, July 16, 1986.
59. "X-29A Advanced Technology Demonstrator Flight Report, Flight No.: 1, Flight Date: Dec. 14, 1984," Wierzbowski X-29 papers and general X-29 files, Air Force Test Center History Office.
60. (Author unlisted.) "Forward Swept Wing Demonstrator X-29 Aircraft No.1 Functional Check Flight Test Report No. 3, Flight No. 1," report no. 712/360/FLT-RP-84-03 (December 17, 1984),

Sweeping Forward

Wierzbanski X-29 papers and general X-29 files, Air Force Test Center History Office.

61. Ibid.
62. Ibid.
63. Ibid. NASA and its precursor, the National Advisory Committee for Aeronautics, have a long history of comparing actual flight data to modeling and wind tunnel predictions in an ongoing effort to make predictive modeling as accurate and useful as possible. In one of the NACA's first uses of the vast dry lakebed test area that is now Edwards Air Force Base, in 1944, a team from the NACA's Ames Aeronautical Laboratory towed a P-51 Mustang fighter into the air behind a P-61 tow aircraft. The P-51 had its propeller removed and its prop spinner faired to replicate the smooth contours of a one-third scale P-51 wind tunnel model. Glide flights in the full-size P-51 were meant to check the fidelity of smaller wind tunnel model test data.
64. Ibid.
65. Ibid.
66. Ibid.
67. Ibid.
68. Ibid.
69. Ibid.
70. Ibid.
71. Ibid.
72. Ibid.
73. Ibid.
74. Ibid.
75. Ibid.
76. Ibid.
77. Ibid.
78. Wierzbanski, interview by Young.
79. Ibid.
80. C. Sewell to Dr. R.L. Caporali, memorandum, "Subj: Recommendation to continue flying the X-29 without a dry lakebed requirement" (January 15, 1985), Wierzbanski X-29 papers and general X-29 files, Air Force Test Center History Office.
81. Ibid.
82. Ibid.
83. Ibid.
84. Ibid.
85. Ibid.

86. Ibid.
87. AFWAL/CC to ASD/CC, letter, "Subj: Response to ASD/CC Questions on X-29 Flight #2 and Flight Control Systems" (January 30, 1985), Wierzbanski X-29 papers and general X-29 files, Air Force Test Center History Office.
88. Ibid.
89. AFWAL/CC to ASD/CC, letter, "Subj: Response to ASD/CC question on X-29 Flight Control System Highlighted in FDL Weekly of 17 Jan 85," letter (January 28, 1985), Wierzbanski X-29 papers and general X-29 files, Air Force Test Center History Office.
90. "Forward Swept Wing Demonstrator X-29 Aircraft No. 1 Functional Check, Flight Test Report No. 5, Flight No. 3," report no. 712/360/FLT-RP-85-02 (February, 25, 1985), Wierzbanski X-29 papers and general X-29 files, Air Force Test Center History Office.
91. Ibid.
92. Maj. Harry C. Walker III, "X-29A Performance Flight Test Results and Lessons Learned," Society of Experimental Test Pilots 1988 Report to the Aerospace Profession, 32nd Symposium Proceedings (October 1988), Wierzbanski X-29 papers and general X-29 files, Air Force Test Center History Office.
93. Sitz, interview by Johnsen.
94. Ibid.
95. Wierzbanski, interview by Young.
96. Rogers Smith, e-mail message to Richard Hallion, January 12, 2012.
97. Ibid.
98. Ibid.
99. Ibid.
100. Herbert H. Hoover, letter to Melvin Gough, August 22, 1947, copy in NASA Langley Research Center historical archives.
101. Robert R. Ropelewski, "X-29A Incident Stirs Up Contractor Pilot Resentment With Air Force," *Aviation Week & Space Technology* (April 1, 1985), Wierzbanski X-29 papers and general X-29 files, Air Force Test Center History Office.



A Rockwell X-31 enhanced maneuverability demonstrator, one of two built as part of a joint U.S.-German research program. (NASA)

CHAPTER 4

Program Expansion

At the beginning of April 1985, NASA took over the X-29 program, assuming control of the aircraft under a loan arrangement with the Air Force. The Government commenced its program with flight five, performed by NASA's Steve Ishmael on April 2. Two days later, Air Force Lt. Col. Ted Wierzbanski became the first Air Force pilot of the X-29. NASA now assumed safety responsibility for the X-29. NASA, satisfied that the X-29 roll incident had been properly dealt with by the Air Force, then let Grumman's Chuck Sewell return to the air. It was a busy time, as envelope expansion was under way, and one of the initial concerns remained pilot induced oscillation susceptibility and behavior.

The first three Government flights involved evaluations to determine whether a susceptibility to PIO that simulations had predicted was actually a problem in the real aircraft. As Wierzbanski described the situation:

Our primary purpose was to determine if, in fact, we did have this analog reversion mode problem which was really a pilot induced oscillation problem. We found that the problem was not there. All three of us [Ishmael, Wierzbanski, and Smith] concurred in that and there are two conjectures as to why it wasn't there. Most likely, and we've seen this, the wind tunnel didn't predict the roll characteristics of the airplane very well. In fact, it predicted a very sharp roll-rate increase with an overshoot and a very small roll mode-time constant like 0.19 [seconds] or something, which is really pretty fast, and you would expect it to have some kind of PIO problem with that. The other thing, there may have been some limitations in the Total In-Flight Simulator (TIFS) aircraft, [the] C-131.¹

Rogers Smith recalled the situation:

In the end, it was determined that the model of the X-29 roll characteristics in the AR mode that was programmed into the TIFS

Sweeping Forward

simulator was incorrect. The real X-29 was better than shown in the simulation in the lateral axis. The PIO tendencies shown in the TIFS simulator were real but not representative of the real X-29 because the simulator used an incorrect model of the X-29 lateral characteristics.²

The discrepancy between predicted and actual X-29 aircraft behavior once again validated the interlocking triad of aircraft development: wind tunnel testing, computer simulation and prediction, and actual flight test.³ The wind tunnel and the computer can refine parameters for flight test, making flight testing somewhat easier and more predictable. In the decades since the X-29 was designed, computer modeling has eroded some tasks that formerly were the province of wind tunnels. All forms of modeling are less expensive than flight testing a full-size article and easier to change if problems are found. But in the end, an actual flight-test program that is informed by the most accurate testing, modeling, and simulation is the ideal.

Opening the Envelope: Tests, Facets, Procedures, Data Acquisition

X-29 envelope expansion began in the spring of 1985. Five pilots—two from NASA, two from Grumman, and one from the Air Force—gradually increased the performance window for the X-29, attaining 0.6 Mach and 30,000 feet in altitude by June 13. These limits were well below what the aircraft was designed to achieve, reflecting some limitations of the aircraft's flight control system as initially configured. As first flown, its analog reversion backup mode initially relied on a fixed-gain system.⁴ Electronically, "gain" refers to the ability to change a signal or input. The intent with the fixed-gain system was to have one gain serve the analog flight control backup mode from subsonic flight through transonic and all the way to about Mach 1.7, well within the supersonic regime. The X-29 team determined before first flight that it was impossible for a single gain system to accomplish this goal. But by the time this was understood, the amount of work required to fix the system would have impacted the flight schedule seriously; thus DARPA elected to fly the airplane with its limitations (and within a limited-performance envelope) until the necessary changes could be made.⁵

Grumman's boldness in tackling X-29 computerized flight control system issues made their initial efforts vulnerable since this was new territory in the late 1970s and early 1980s. The company initially adopted a full-state feedback FCS system architecture that relied on angular acceleration data such as roll acceleration. The result could be burdened with signal noise that limited its



Instrument panel of the second X-29, showing the compact arrangement of critical flight instruments and associated switches and controls. Despite its digital-fly-by-wire flight control system, the X-29's instrument panel reflected the late "steam-gauge" needle-and-dial-era of pre-"glass cockpit" computerized pilot displays. (NASA)

effectiveness. Dryden engineers who participated in the X-29 FCS development expressed concerns over this full-state feedback system. At DARPA's direction, NASA engaged the software and hardware maker Honeywell to analyze the Grumman X-29 FCS premise. The upshot was an understanding that changes were needed in the X-29's FCS. NASA pilot Rogers Smith recalled: "Accordingly, a GAC design team, under the direction of Jimmy Chin and others, was given the daunting task of creating a totally new design, based on classic FCS design principles. Impressively, this task was done and the resulting system did do the job."⁶ NASA engineer Joseph Gera recalled: "The software was developed by Honeywell for their triplex computer system. A Honeywell contingent of engineers (Joel Sitz, Mike Thompson, Eric Larson) spent many months at Dryden on the X-29 working together with NASA engineers (Mike Earls). In fact, Sitz and Thompson became NASA employees and are still working at Dryden [as of 2012]."⁷

Where Grumman was known for its pioneering efforts in analog computer flight controls on the F-14, the use of digital computers for the X-29's primary

Sweeping Forward

flight control system represented a skill set that was resident at Honeywell in that era. Honeywell had previously upgraded the Air Force's exotic SR-71 Blackbirds with triply redundant digital flight control computers, and it was an iteration of SR-71 computers that kept the X-29 under control. In this environment, recalled former Honeywell software engineer Joel Sitz, it was possible for Grumman to give a potential flight control system design to Honeywell to execute, during which Honeywell's experts would find flaws and resolve them to Grumman's satisfaction in a professional give-and-take environment of mutual respect.⁸

Joel Sitz came to the X-29 program from Honeywell's Military Avionics Division in Minneapolis, subsequently working with NASA engineers and software experts, including Mike Earls and Mike Thompson. Dispatched to Dryden in 1985, Sitz and his fellow software specialists from Honeywell and Dryden initially faced a daunting wait of up to 6 months before each software change they implemented on the X-29's computer flight control system could be approved and adopted by NASA. Sitz and his compatriots embraced the proactive sense of urgency that imbued the X-29 program. They began inventing automated ways to check software modifications that saved time and manpower. The time to validate software changes was cut to only weeks as a result.⁹

The value of such expedients to the booming world of computerized aircraft systems was not lost. The X-29's accelerated software validation tools became the basis for Dryden's world class Research Aircraft Integration Facility (RAIF), a research and validation facility that has served aerospace research since October 1992—yet another worthwhile outcome of the X-29 team effort that continues to yield benefits. The RAIF significantly reduces aircraft systems checkout time and costs.¹⁰

NASA flight controls engineers from Dryden were regular visitors to Bethpage during the detailed design phase, refining the design of the X-29's flight control system, working with Grumman's Jimmy Chin, Bob Klein, Paul Martorella, and Bob Papsco. Dryden was also helped by an independent assessment and control-law design by Honeywell's Joe Wall and Dale Enns. Flight dynamicist Malcolm Abzug made valuable contributions as a DARPA consultant during the control-law update.¹¹

NASA's Steve Ishmael made the first Government flight of the X-29 program, flight five. Ted Wierzbanski's first X-29 mission was the aircraft's sixth outing. Years later, he recalled how his height—taller than the average fighter pilot—put his helmeted head very close to the inside of the X-29's F-5A-derivative cockpit canopy: "I never closed the canopy until my first flight as I didn't want to know how close it would be. It ended up being OK, but I didn't want to chance it. After my first flight it didn't matter."¹²

The X-29 team appreciated the value of the aircraft and the cost of its support. While this initial limited envelope expansion was being achieved, the

Program Expansion



Air Force test pilot Ted Wierzbanski turning over Rogers Dry Lake on the X-29's 16th Flight, June 13, 1985. (USAF)

team devised other meaningful flights within those parameters while awaiting the flight control gain fix. “We did everything we could imagine with the airplane. We even put tufts on the wing. On one flight, we put on tufts and on another flight, we put on cones and went up and did flow visualization work on the last couple of flights in that 16-flight block,”¹³ Wierzbanski said. The team used the simulator to refine test cards before actual flights, “so that when we went up and flew, we just inundated the engineers with data.”¹⁴ He said these initial flights showed the X-29 to perform very well. In subsequent speaking engagements about the X-29 program, Wierzbanski said, “I always try to give kudos to Grumman for really building a pretty good product.”¹⁵

The tufting flow visualization flights explored the X-29's slow speed and high-AoA capabilities, which proved problematical to photograph. Wierzbanski recalled:

We did have a real problem in taking pictures of tufts and cones at the slow speeds and even in the higher angles of attack because we didn't have a chase plane that was capable of doing it. We didn't have any way of mounting external cameras on the airplane without affecting its structural stuff.... I got an [Cessna] A-37 and an F-15 because we didn't know which one was going to be able to hack it as photo chase. It ended up the A-37 worked better, thanks

Sweeping Forward

largely to its pilot, Patty Randell, who did a fantastic job.... [The A-37] airplane was flying slow and it has an interesting angle of attack or reference angle, which makes it difficult to fly and get pictures—over canopy rails and all that kind of stuff—of [the kind of] scientific quality which is what we were looking for. The F-15 wasn't able to do it either because of the way we were turning and the fact that the [X-29] always flies almost at a zero reference angle because of the three pitch control surfaces. It's sometimes sort of deceiving to the chase guy and with the F-15, we were trying to take pictures in a turn, at elevated angles of attack and he just couldn't get the pictures.¹⁶

It is an inescapable irony of flight test that new, experimental aircraft with capabilities beyond the norm can be difficult or even impossible to properly chase with available older-technology aircraft.

Walt Sefic authored a NASA paper that detailed how the X-29 team functioned:

The basic assumptions made during early planning activities for the X-29A operations were as follows:

1. Flight safety was paramount.
2. The flight rate would be two flights per week.
3. There would be progressive buildup of Mach, altitude, and maneuvering capability.
4. Test planning would include evaluation of flutter and divergence, the FCS, structures, propulsion, aircraft systems, performance, flying qualities, and emergency power unit limits. The emergency power unit capability limit is central to all flight planning. Under certain circumstances in which complete engine power loss occurs, the aircraft cannot be safely returned to base because of limited emergency power unit hydrazine fuel. The reduced fuel capacity results from the use of a modified F-16 hydrazine tank that was made smaller because of emergency power unit space limitations.

Operations for the X-29A aircraft for a typical sortie include a technical briefing one week in advance, a flight test profile conducted on the simulator, a mission briefing, the actual X-29A flight test, and a mission debriefing. The facilities involved in the typical X-29A program operations include the Western Aeronautical Test Range, the mission control center, spectral analysis, and satellite data transmission....

The X-29A operational sequence was initiated with a program plan, flight test plan, and military utility plan. A flight-readiness review [FRR] committee and a flight test team consisting of the Ames-Dryden, AFFTC, and Grumman personnel were formed. The flight test team, employing a project engineer, develops a flight request that results in a number of scheduling activities including configuration control, aircraft maintenance, and simulation that leads to a technical briefing on the proposed flight or group of flights. The technical briefing results in an agreed-to-flight request and an FRR flight release for a first flight or a major modification of the aircraft. After the particular flight is thoroughly conducted on the simulator (including pilot in the loop), a set of final flight cards is briefed, together with the flight operating limits, a mandatory instrumentation list, aircraft configuration, and mission control center layout.

The flight controller is the primary individual communicating with the X-29A pilot and the chase pilot. All other individuals communicate through an intercommunication system to the controller. Under certain conditions, the lead flutter engineer can communicate directly with the pilot with preplanned commands. After the flight...a postflight briefing is held, data processing is initiated, and any discrepancies are documented and prepared for the next configuration control meeting.¹⁷

NASA reports written by X-29 team members explained the test data acquisition process:

The NASA Ames-Dryden Western Aeronautical Test Range provided the real-time monitoring and analysis capability for the envelope expansion work. Since all data from the X-29A aircraft were available only over a telemetry downlink during flight, all data had to be recorded, and in some cases analyzed, in real time on the ground.... The range provides telemetry acquisition and processing, real-time data analysis and display, voice communication links, radar tracking for space positioning, and video displays of the aircraft in flight. This information was made available to two mission control rooms, the "blue room" and the spectral analysis facility, which worked in parallel to direct the flights. The blue room consists of 12 strip charts, numerous CRT displays, and a terminal console hookup to a computer providing real-time

Sweeping Forward

data processing. Gould SEL 32/55 and 32/77 minicomputers are used to process telemetry information, to calibrate it, to convert it to engineering units, and to display it to the control room. This control room contains the test conductor, range communications personnel, project management, and discipline engineers from controls, propulsion, systems loads, and aerodynamic stability and control.

The spectral analysis facility consists of six strip charts, CRT displays, a communications link to the blue room, and two real-time computers. One of the computers, an HP5451C Fourier Analyzer, is used to extract structural dynamics frequency and damping data for the primary airframe modes. The second computer, a Gould Concept Series 9780, is used at a flight controls station to analyze controls system frequency response to determine system stability margins.¹⁸

During the X-29 program, NASA introduced its Remotely Augmented Vehicle (RAV) system into the flight-test tool kit. With RAV, engineers on the ground could display targets for the pilot to follow, enabling the pilot to more closely match the energy and precision required for some maneuvers than if he did not have instrument cues. NASA X-29 team members explained RAV's use in a paper, noting:

To assist in the collection of data of higher quality and larger quantity, the remotely augmented vehicle (RAV) system was incorporated into the X-29A aircraft. The pilot-assist version of the RAV system was tested in this phase. Aircraft state variables calculated from the telemetered data are input to the computers, which generate guidance and control information.

The RAV system has two operating modes. In the first mode, a ground-based computer drives a set of airborne guidance needles through a radio uplink. The ground-based computer calculates the flightpath required to accomplish the maneuver and then computes error signals from the desired and actual values in the form of pitch, roll, and throttle position. These errors are telemetered to the vehicle and displayed as commands to the pilot using the instrument landing system needles and the speed bug as indicators. This guidance assists the pilot not only in flying maneuvers more precisely but also in the transition to new test points.¹⁹

The X-29A was cleverly instrumented to quantify its performance, as summarized by a Dryden reference document:

Because of the nature of the X-29A mission, the aircraft is highly instrumented with almost 700 parameters measured in flight. . . . The types of sensors used are rate gyros, accelerometers, strain gauges, aerodynamic pressure taps, temperature and pressure monitors, Pitot-static monitors and control surface position indicators, and rate indicators. The data acquisition system utilizes both pulse code modulation (PCM) and constant-bandwidth frequency modulation (FM) for data encoding, and integrates instrumentation data with data from the 429 data bus onto a single PCM data stream, which is telemetered directly to the ground station.

The PCM system consists of five separate units, located remotely throughout the aircraft, operating at different frame rates asynchronously. Inputs from these PCM units and the data bus are merged (using an interleaver unit) into a single PCM stream.

The structural dynamics instrumentation consists of accelerometers located in the forward fuselage, on the wing and canard tips, and on each of the flight control surfaces. This instrumentation was used to clear the aircraft for flutter throughout the flight envelope.

Static structures instrumentation . . . consists of shear, bending, and torsion strain gauges located at the root of the left and right wings, left and right canards, and at four stations on the left wing. Actuator loads on all control surfaces as well as stick and rudder pedal forces were also measured.

Pressure survey instrumentation is located on the left-hand wing, canard, and strake. This instrumentation consists of flush static pressure taps located in two rows on the canard, four rows on the wing, and one row on the strake.

A rather unique part of the instrumentation system is the deflection measurement system . . . located on the right-hand wing external to the aircraft. This system consists of 12 individual light-emitting diodes or targets that are focused on a diode array located in the fuselage side. The system pulses each of the targets individually, and the received impulses are input to the PCM system. This information is later reduced to give wing bending and torsion information, which is used by the pressure survey and wing divergence experimenters.²⁰

Sweeping Forward

Supersonic Expansion, Delamination, FCS Health

With the 16-flight limited envelope expansion complete on June 13, 1985, the X-29 went into maintenance until August 14 while the analog backup mode was upgraded. This involved installing four sets of gains with automatic switching using analog sensors, Wierzbanski explained, “so that we were always in the correct gain in analog reversion as we flew up in the envelope and then back down and the computers would take care of that automatically.”²¹

But three flights into the new system, an unrelated problem put the X-29 back on the ground. A different preproduction GE404 engine failed, and the precaution was to ground aircraft with that type engine until the turbine wheel could be replaced. After landing on August 22, the X-29 did not fly again until November 1, when part of its mission was to check engine function after the 404 powerplant was refitted.²²

Engineers on flight-test programs carry a strong sense of responsibility for the safety of the pilot flying a test profile in a test aircraft. The Air Force Flight Test Center’s lead engineer on the X-29 at the time, Maj. Ken Griffin, recalled some heart-stopping moments during early supersonic envelope expansion. The first supersonic X-29 flight occurred on December 13, 1985. Griffin described one early supersonic surprise in the control room:

A particular event during the envelope expansion of the X-29’s flight clearance into the supersonic region really stands out to me since I was in charge of the flutter control room that day. Because we were so limited in fuel our supersonic flight time was very limited in the X-29. In order to perform in near-real-time multiple clearance points in the supersonic region we would have to slow down to just below supersonic speeds after a test condition was sampled. Here we waited for the computer analyses to be completed suggesting we could speed back up go to the next test condition. The first time we throttled back from a new supersonic test point the engine inlets spilled excess airflow because of the sudden low thrust settings. This excess airflow caused an unexpected buffeting of the canards mounted just aft of the inlets. The control room instrumentation suddenly came alive and gave similar responses to what I expected they would exhibit if we were near a flutter instability. The normal recovery to avoid a flutter condition is to slow down. Yet we were already slowing down. When we finally got our wits about us we realized it was the dumped inlet flow rather than a flutter onset that we were seeing in the control room. But just for an instant we were surprised with



Dryden technicians perform maintenance work on the first Grumman X-29, August 1985. Note flight-test instrumentation racks in forward nose bay. (NASA)

a situation that required a different recovery response to what we normally would use.²³

Flights resumed, and the test team continued to expand the X-29's envelope. A momentary roadblock arose when not all engineering parties could agree about potential buffeting issues that the X-29 could face. Dryden X-29 project manager Walter J. Sefic called a halt to the flying program by declaring that the X-29 had to enter its 50-hour inspection phase, buying time to resolve the buffeting questions. During the inspection, technicians discovered a minor composite delamination (about the size of a quarter coin) in a lower right-hand (wing) cover, along the leading edge. Griffin (an expert in aeroservoelasticity) initially thought the delamination could signal a serious issue. He subsequently studied the situation with other composites experts. Together, they concluded the delamination was more benign and that flights could continue, with the delaminated area being watched. Grumman took a more cautious stance, initially not concurring with the decision to fly the X-29 until the problem was more fully studied. Accordingly, Sefic extended the X-29's downtime to permit some instrumentation fixes while technicians studied the delamination. The

Sweeping Forward

loss of the Space Shuttle Challenger on January 28, 1986, offered a grim warning to flight testers about making facile assumptions regarding flight safety and, as a consequence, both NASA Headquarters and the Air Force's Aeronautical Systems Division formed a blue-ribbon panel to study the X-29 delamination, using their resident structures experts.²⁴

Some members of the X-29 test team chafed at the delay over the delamination question. Bill Albrecht, Dryden's operations engineering branch chief, wrote a memo in which he said: "The recent delamination occurrence in an innocuous corner of the Lower Wing Panel on the X-29A has resulted in such an absurd overreaction, and more importantly, a totally unnecessary series of significant Program delays, that this office cannot refrain from comment."²⁵ Albrecht said that composite defects on Dryden's F/A-18 fleet were being "dealt with in routine and effective fashion by Dryden personnel. The presence of the defects, in either one of these instances, is potentially far more serious than that presented by the pesky little void in the X-29A panel, yet we continue to cater to an exercise which is costly, totally unproductive, and frustrating to a competent Dryden team."²⁶

The X-29 did not fly after February 27, 1986, until June 10. Structurally tailored composites were a recent development when the X-29 flew; extra caution likely seemed more prudent then than it might now in hindsight.

Four flights into the post-delamination study, some members of the team thought that the delamination had increased. The X-29 went down again for about a month while the delamination was characterized by ultrasound and found to be the same size as previously measured. "In hindsight," Wierzbanski recalled, "you could say we over-reacted. But, really, we really just didn't have another option. So we had to take the very conservative approach.... I think, in defense of NASA, it just didn't have any option, in light of the times."²⁷

In keeping with the X-29 team's forward-leaning efforts to maximize the aircraft's utility, Ted Wierzbanski enlisted the aid of the Air Force's Materials Lab to test some of their emerging techniques for inspecting composite structures on the X-29. Because the X-29's structurally tailored composite wing covers had been mapped carefully to show the exact locations of any acceptable voids or anomalies before the aircraft flew, the X-29 was a prime teaching aid for nondestructive composites inspection techniques.²⁸

Just before the second delamination standdown, the X-29 executed four missions in one day, on June 12, 1986. The X-29 program initially forecast a flight rate of twice a week. In the first year and a half of flights, the per-week rate hovered between one and two when all the downtime was taken into consideration—still a remarkable pace. Ironically, this rate is what initially caused concern from DARPA, who, comfortably distant from both the testers and the risks that they face, argued for a higher sortie rate. Prudence dictated otherwise, Wierzbanski said, noting, "History again has proven that one

Program Expansion

to two flights a week for a research airplane is reasonable.... After you fly, you have to analyze the data, make sure you're not making a dumb mistake."²⁹

Real-time capabilities resident in Dryden's mission control room greatly enhanced data reduction and analysis for the X-29 research effort. Test methodology was one of the benefits of the X-29 program not immediately linked to this aircraft's unorthodox design. If some unavoidable delays like engine groundings slowed the rate of mission accomplishment for the X-29, Dryden pushed forward to save data reduction time in other areas. Real-time frequency response was first measured on the X-29. NASA was able to perform real-time envelope expansion with the X-29 in flight by analyzing test data points as soon as the data was taken and relayed to the control room. In some respects, this also reflected Grumman's success with its data acquisition and analysis system first employed at Calverton and Patuxent River in support of its F-14 effort.

The X-29 program was a fertile ground for creative and sometimes frugal ways to expand the aircraft's envelope through modeling and comparisons, and throughout the X-29 program, papers and presentations touted the program's ability to use flight data compared with predicted data to quickly expand the envelope. NASA researcher John T. Bosworth explained the process used to validate linear flight control models, noting:

Flight control system design and analysis for aircraft rely on mathematical models of the vehicle dynamics. In addition to a six-degree-of-freedom nonlinear simulation, the X-29A flight controls group developed a set of programs that calculate linear perturbation models throughout the X-29A flight envelope. The models included the aerodynamics as well as flight control system dynamics and were used for stability, controllability, and handling qualities analysis. These linear models were compared to flight test results to help provide a safe flight envelope expansion.³⁰

Dryden engineers eagerly applied breakthrough technology in the form of flight control system health monitoring on the X-29, which accelerated the safe expansion of the aircraft's flight envelope. The health of the FCS is measured by the gain and phase margin available to the FCS at any given flight condition (i.e., speed and altitude). Traditional computerized FCS phase and gain margins were 6 decibels (dB) for gain and -45 degrees for phase. The X-29 system was unable to achieve these margins, explained NASA pilot Rogers Smith.

For this carefully monitored test program, it was agreed that half these margins would be the requirement. It would have been very costly and slow to have to do the expansion one flight at a time.

Sweeping Forward

Accordingly, the X-29 team developed a real-time method, using a 52-second frequency response from pilot inputs. About one minute later, the control room had the answers and proceeded with the tests if the trends looked good.³¹

This level of continuous real-time feedback allowed X-29 testers to continually expand the envelope as long as the margins, and remaining fuel, were in the safe zone. On one mission when the trends did not look good, the flight was terminated. Suitable changes were quickly made to the FCS to keep its operation within the defined safe margins. Safe gain margins greater than the mandated threshold of 3 dB and phase margins higher than 22.5 degrees were eventually demonstrated over the entire flight envelope. Developers of the high-AoA FCS had to create software that was still functional over the entire flight envelope. This required some creative real-time removal of data inputs and limitations on control deflections that had importance at lower Angles of Altitude but could adversely cue the aircraft at high AoA.³²

Dryden engineer Joseph Gera was emphatic about the significance of this FCS feedback: “The importance of the near real-time frequency response from pilot-generated frequency sweeps cannot be overemphasized. This was developed and first used during flight tests at Dryden.”³³ Gera said the near real-time computation of stability margins helped accelerate the pace of envelope clearance. It also facilitated a critical pitch-axis gain reduction by 2.5 dB at high subsonic Mach numbers. “This change did not require the usual, time-consuming parameter estimation process to determine the individual control surface effectiveness derivatives,”³⁴ he noted. Gera continued: “During the X-29 follow-on program the frequency-response analysis was extended to multi-loop systems. Comparison of flight and simulation data was not only in the frequency domain but also in the time domain in a truly real-time fashion. These techniques allowed the simultaneous envelope clearance of all three control modes, ND, DR, and AR in a reasonable time frame.”³⁵ The cleared system modes enhanced pilot confidence in using these modes without any reservation, Gera recalled. “An example of this was taxiing in the AR mode which did not have acceleration feedback and thus avoided the violent canard movements produced by runway bumps, first observed by Glenn Spacht while chasing the X-29 during taxi tests in his souped-up Corvette.”³⁶

The high-alpha control laws for the number two X-29 were designed at Dryden jointly by Robert Clarke and Fred Webster using Dryden’s simulator and analytical capabilities. The lessons learned from these control laws were invaluable for other NASA high-alpha programs, such as the Rockwell X-31 vectored thrust poststall maneuver test bed and the F/A-18 HARV [High Alpha Research Vehicle].³⁷



The NASA F/A-18 HARV high-AoA research aircraft during a research flight over the Edwards range. (NASA)

The X-29's flight control software's development and monitoring, especially for the number two aircraft's high-AoA work, was the subject of a NASA report that concluded:

The X-29A airplanes were evaluated over the full design envelope. The flight control system successfully performed the tasks of stabilizing the short-period mode and providing automatic camber control to minimize trim drag. Compared with other highly augmented, digital fly-by-wire airplanes, the X-29A and its flight control system proved remarkably trouble free. Despite the unusually large, negative static margin, the X-29A proved safe to operate within the design envelope. Flight test showed the following lessons:

- Adequate stability to successfully test a 35-percent statically unstable airframe was demonstrated over the entire envelope in a *flight test research environment*. Extrapolations to a production–operational environment should be made carefully.
- The level of static instability and control surface rate limits did impact the nose up and nose down maximum pitch rates. At low airspeeds, to achieve rates comparable with an F-18, new actuators with at least 50-percent higher rate are required.

Sweeping Forward



(Left to right) X-29 pilots Harry Walker, Steve Ishmael, and Rogers Smith commemorate the 100th flight of the X-29, fittingly, on December 17, 1986, the 83rd anniversary of the Wright brothers' flight at Kitty Hawk—another inherently unstable aircraft with a composite structure! That day, Ishmael flew the X-29 to Mach 1.46 at 50,200 feet. (NASA)

- Testability of a flight control system on an airplane with this level of instability is important and big payoffs can be made if provisions are made for real-time capabilities.
- Air data are critical for highly unstable airframes and extra analysis is required to ensure adequate stability. Typical fighter type airplane air data redundancy management tolerances do not apply. Tight tolerances must be used even at the risk of nuisance failure detection.
- The dial-a-gain concept proved a valuable aid to evaluate subtle predicted differences in flying qualities through back-to-back tests. It was also useful to flight test proposed gain adjustments before major flight control system gain changes were made. This concept might not be easily applied to full state feedback designs, but forward-loop gains are good candidates for this use in any design.
- High angle of attack with high feedback gains will create problems with structural modes and require notch filters to eliminate flight control system response.³⁸

Program Expansion



The first X-29, flown by Major Harry Walker, during simulated air refueling tests, photographed from an AFFTC Boeing NKC-135A Stratotanker, December 23, 1986. (USAF)

Nor did the electronic wizardry stop at the Dryden control room door. Simulators, some praised and others criticized, were integral to the smooth and safe execution of the X-29 flight program. Engineer Joe Gera elaborated: “It should be noted...that the one simulator that was used, updated and flight-validated throughout the X-29 program was the Dryden fixed-base, full-envelope simulation in a ‘hardware in-the-loop’ and an all-FORTRAN version. The latter simulator’s hardware and software was created and maintained by NASA/Dryden simulation engineers ([particularly] Marlin Pickett).”³⁹ This simulation capability underscored the importance of co-location of flight research/test and simulation, enabling pilots and engineers to expeditiously experiment and train at the same facility from which they flew the actual aircraft.

By the end of 1986, the program had proven the basic concept of the aeroelastically tailored composite FSW aircraft with the 35-percent-instability

Sweeping Forward

rating. In most areas, the actual airplane had behaved close to the forecast performance that was based on modeling and simulations, and this built confidence in those tools for future use. It had completed its 100th flight (fittingly, on the anniversary of Kitty Hawk), and it had also ended the year by undertaking simulated air-refueling approaches behind an AFFTC tanker, a measure of the aircraft's controllability and the behavior of a forward swept wing in close proximity to a large tanker aircraft. Despite these and other accomplishments, the delays that plagued the X-29 during envelope expansion kept the team from exploring all the technologies and potentials of the aircraft until the envelope was expanded.

The delays frustrated Ted Wierzbanski, who opined in 1986: "If we can just get a couple of good months of flight test going, we'll be able to crank through the envelope and get the envelope expanded and then do some of the work with the airplane that we really want to do...which is performance measurements and trying to understand the aerodynamics."⁴⁰ At that time, some notional sketches of Advanced Tactical Fighter concepts included canards. This briefly encouraged some in the X-29 program that canard testing after envelope expansion would soon lead to their incorporation on the next American fighter slated for production, though that did not occur.

Powerplants, Pigtails, POPUs, and Performance Quirks

Two days before Christmas, 1986, the X-29 rolled to a stop, marking the beginning of a lengthy grounding for needed maintenance and updating. The airplane was down for 6 months while a calibrated and instrumented F404 engine from NASA's Lewis Research Center was installed in place of its previous powerplant.⁴¹ Unfortunately, this instrumented engine had to be removed and reinstalled, after three pressure probes were found to be broken following an engine test run on May 12, 1987, thus further delaying the X-29's return to flight.⁴²

In mid-May 1987, a second, and unavoidable, external delay was imposed upon the X-29 flight-test program due to a problem experienced on a different F404 engine in a Navy F/A-18 aircraft. To introduce fuel for afterburner combustion, the engine's afterburner used coiled "pigtail" lines feeding the afterburner spraybar. General Electric informed NASA that the pigtails needed to be replaced due to possible fatigue. A week lapsed before the engine repair kit arrived, and technicians completed installing the lines on May 27. Due to a higher priority test, the engine could not be test-run at the Edwards Air Force Base jet engine test cell, so it was shipped over the mountains to the General Electric facility at Ontario, CA, more than 100

miles from Edwards. It was tested on May 29 there, and it was returned to Edwards on June 1.⁴³ Seemingly throughout the X-29 program, the flight-rate pendulum swung from multiple missions in a day to long periods of downtime, the resulting overall average coming close to the predictions of experienced testers.

Some aerodynamic cleanup of the number one X-29 airframe took place during this downtime; the flight load deflection measurement system was taken off, as were podded flaperon shaker devices. Some newly added instrumentation initially balked, and the X-29 did not fly again until June 19, 1987. Now the X-29 team would evaluate all its technologies in earnest and contemplate their military utility. For the next several months, the X-29's pilots performed performance evaluations, loads expansion, and some preliminary forays into high-AoA testing.⁴⁴

Performance testing concluded on December 4, 1987, after 26 flights that gathered performance data, totaling a combined 16 hours and 36 minutes in the air. The X-29 test team's performance testing priorities were:

1. Definition of the subsonic and supersonic lift and drag characteristics of the forward sweptwing configuration. (Drag measurements were only to include parasite and induced drag characteristics.)
2. Comparison of flight test performance data with design and aero model predictions.
3. Verification of the automatic camber control (ACC) mode as the optimum lift versus drag configuration for the vehicle.
4. Investigation of the effects of maneuver dynamics on performance.
5. Definition of the energy maneuverability of the vehicle.
6. Determination of the turn and acceleration performance of the vehicle.
7. Definition of the aircraft's point performance capability.
8. Development of new in-flight thrust modeling and real-time aero-performance analysis techniques.⁴⁵

The X-29 team used standard flight-test maneuvers including Wind-Up Turns (WUT) and Push-Over Pull-Up (POPU) maneuvers at specified Mach numbers and altitudes. POPU maneuvers could, for example, begin with a push-over yielding 0 g, followed by a pull-up registering 2 g's. After that maneuver, a WUT could begin with the airplane slowly experiencing increased g until the desired test limit (e.g., load, buffet, or angle of attack) was attained. To ensure valid data, Mach number and throttle setting were held constant throughout both maneuvers. By this meticulous and disciplined testing, the X-29 team was able to acquire sufficient high-quality data to fulfill all of the program's objectives.⁴⁶

Resulting data reduction showed the performance of the X-29 at subsonic speeds, in terms of lift-over-drag characteristics, was actually better than

Sweeping Forward

predictions. At supersonic speeds, test data either closely matched predictions or showed a nominally lower lift coefficient for a given angle of attack than had been predicted beforehand. Performance gains with the forward swept wing were quantified to be an improvement of at least 20 percent over a similar conventional aft swept wing.⁴⁷

Testers came up against quirks in the X-29's responsiveness traceable to the kind of actuators used by the aircraft, a result of the limited budget supporting the program. While the aircraft showed excellent lift-to-drag characteristics when flown in relatively benign maneuvers, substantial drag penalties accrued during more rapid aggressive maneuvering. This increase in drag was traced to the X-29's ACC system. Simply put, during rapid maneuvering, the system on the X-29 could not reconfigure the wing shape quickly enough to optimize it for desired drag reduction. This was traceable to a combination of flight control laws and actuator limits. The flight control laws were deliberately made conservative to ensure safety of flight in this 35-percent-unstable aircraft, but the limitations on the actuators were a cost consideration. Available F-16 actuators cost far less than the creation of purpose-built X-29 actuators would have been. For the X-29, ACC was designed to reshape the camber of the wing into the optimum configuration for any given flight condition. The onboard computers could reshape the wing camber to provide minimum drag for any combination of altitude, airspeed, and desired lift coefficient. However, basic control of the highly unstable X-29 was of primary importance, so the flight control system was designed in a way that gave higher priority to using the control surfaces to maintain stability in flight. Only then would the flight computers command the flaperons in order to minimize drag. The flaperons were intended to pass through 2 degrees a second for drag minimization purposes, and this rate proved inadequate to maintain the desired automatic camber control whenever the pilot commanded high maneuver rates. A recommendation from the X-29 team to future design teams was to avoid the false economy of using available existing actuators if the capabilities of the aircraft under testing would be best optimized with purpose-built actuators, even if at higher cost.⁴⁸

And therein lay a quirk of the X-29 program: although looking very much like a futuristic jet fighter, and embodying a host of potential next-generation fighter technologies, the X-29 was not designed with the handling qualities of a modern jet fighter. It had handling qualities in keeping with a radically advanced unstable airframe, for which survivability depended far more on the controls' ability to consistently stabilize the aircraft than on aggressively maneuvering it. Among the issues in X-29 flight control quality inconsistent with modern fighter state-of-the-art was a lack of stick harmony. Pilots found lateral (side-to-side) stick movements for roll control were noticeably lighter than longitudinal (fore-and-aft) stick movements for pitch changes. Pitch control

was sluggish and overdamped, which risked over-control in the pitch axis. But the static pitch instability was not leveraged in the X-29's flight control system to capitalize on its rapid pitching potential. Instead, the intent had been to give a safe, stable flight control feel.⁴⁹

By January 1988, the X-29's flight control system gains were modified, along with a reconfiguration of the control stick, making the aircraft more sensitive in pitch than it was previously. Pilots reported a greatly improved pitch response, control harmony was better, and the X-29 now flew more like a fighter. Roll response remained sensitive, however, and pilots found it difficult to stabilize the aircraft in the lateral (e.g., rolling) axis.

During this period, the flight control system underwent continuous refinement. The aircraft was coming into its own—structures testing verified that the airframe was sound and that it could fly within the design envelope. The demons of flutter, aeroservoelastic effects, and divergence could not occur within that envelope. The essential validation of the FSW concept was at hand.⁵⁰

One incident late in 1987 that could have dampened enthusiasm for the X-29's other successes was an electrical short that led to the abort of all three flight control system digital computers on the ground. As described in a "lessons-learned" letter from the 6510th Test Wing Commander [and former NASA Space Shuttle astronaut] Col. Roy D. Bridges: "During a ground check-out of the X-29, a failure occurred that resulted in the abort of all three digital Flight Control Computers (FCCs) with no indication of an analog reversion activation. (In fact, the analog system was operating normally and would have been the controlling entity if the X-29 was in flight.) The cause was the shorting of a 28 VDC [volts, direct current] source (due to a workmanship problem) to a wire inside one FCC that is tied to similar wires from the two other FCCs."⁵¹

Colonel Bridges's letter identified what he considered to be another potential X-29 control problem: "Subsequent to the above failure, a detailed investigation of the circuit diagrams uncovered a second problem with the X-29 flight control system.... The potential existed for a Weight on Wheels (WoW) switch failure to occur that would be a latent failure (not detected as it is not checked except at 25 hour phase inspections). This switch failure would then allow for a single WoW switch failure to send two rate gyros to null resulting in potential loss of the vehicle."⁵² Looking ahead to future designs that would depend on digital flight control systems, Bridges observed, "there will be failures in any mechanical system," adding that "an effort must be made to anticipate these types of failures, minimize the effects of such failures, isolate them from the critical path of aircraft control, and provide a safe backup system that is dissimilar enough from the primary to ensure adequate fault tolerance in the vehicle.... In future designs, a graceful, safe backup system that allows at least crew and vehicle recovery capability is insurance that should be provided."⁵³

Sweeping Forward



NASA Chief Pilot William “Bill” Dana, who flew the first X-29 on its 145th flight, November 18, 1987, during the “guest pilot” program. He subsequently flew the second X-29 on its 110th flight, September 13, 1991, during a High-Angle-of-Attack Evaluation. (NASA)

The concurrent failure of all three digital flight computers experienced while taxiing the X-29 was a low risk calculated to be 10 to the -9th power, recalled Joel Sitz, and yet it had happened—albeit from seemingly unrelated, erroneous wiring that the airplane had flown with for months. Had the failure occurred in flight, the aircraft likely would have safely reverted to analog mode, yet the potential dangers of any control system anomalies were understood.⁵⁴

Pilot swap-outs occurred when Grumman’s Kurt Schroeder made his last X-29 flight on July 24, 1987, handing Grumman X-29 flight duties over to Rod Womer. The Air Force project pilot, Maj. Harry C. Walker III, left the program to take an assignment as an Air Force Test Pilot School instructor, flying the X-29 for the last time on January 22, 1988. His replacement was Maj. Alan Hoover. Steve Ishmael and Rogers Smith remained as NASA’s project and co-project pilots throughout the whole program, flying about half of the total project research flights over the history of the program. During this time, the X-29 program initiated a guest pilot program, with experienced test pilots invited to fly the X-29. These pilots, not otherwise associated with the X-29, were asked to give their opinion of the X-29 and make recommendations on how it could be improved.

The first to fly was NASA’s chief pilot, William “Bill” Dana, whose high-performance-aircraft experience included the venerable F-86 of Korean War vintage; the hypersonic X-15 (which he had flown 16 times, once to an altitude of 59 miles); the Northrop M2-F3, Northrop HL-10, and Martin X-24B lifting bodies; and the AFTI F-16, among many other programs. Dana completed his guest flight on November 18, 1987. Six other guest pilots followed Dana: NASA’s James W. “Jim” Smolka, Thomas C. “Tom” McMurtry, Edward “Ed” Schneider, Col. C. Gordon Fullerton (then an Air Force pilot-astronaut assigned to NASA), and Air Force test pilots Lt. Col. Gregory V. “Greg” Lewis and Maj. Erwin B. “Bud” Jenschke, Jr. Comments from two of these guest pilots reflects both the positive and negative aspects of the program. NASA’s Dana noted: “There is a great deal to commend in the X-29. The cockpit and systems are simple and intuitive, the handling qualities are very good for an

aircraft so early in its control law development.”⁵⁵ The Air Force’s Greg Lewis, a highly experienced F-16 test pilot, concluded: “Pitch response is quick. Harmony good. Stick travel limit not good for agility. Aircraft yaws when gear comes down. During landings pitch good but sluggish in roll.”⁵⁶

NASA’s Rogers Smith completed the 200th flight of the X-29 on June 8, 1988, the first time an X-plane program had achieved 200 flights (the previous record was established with the three-ship X-15 program when NASA’s Bill Dana flew the X-15 rocket on its 199th sortie), and it was all the more remarkable because a single aircraft—the first X-29—had flown all 200 missions. Among Smith’s test tasks for this milestone flight was simulated refueling by positioning the probeless X-29 behind a Boeing NKC-135A Stratotanker as if it were refueling from the tanker. Smith noted, “there was no interference from KC-135 tanker during simulated refueling task.”⁵⁷ Though not the first refueling simulation flown by the X-29—Walker, for one, had flown such sorties previously—this flight reassured the team that there were no untoward flight characteristics of the FSW design configuration that might inhibit aerial refueling. When Smith brought the X-29 back to the Dryden ramp that day, the jet was put into layup for its 175-hour inspection. It returned to flight on July 6, 1988.⁵⁸ Later that month, science and technology served art and education on July 27, 1988, when the X-29 went aloft for the purpose of obtaining film footage for the Smithsonian’s National Air and Space Museum (NASM), which wished to show a 3-minute clip of the X-29 in a new exhibit gallery devoted to the computer age and its impact on the aerospace sciences.⁵⁹

...and Then (Briefly) There Were Two...

As the program anticipated the arrival of the second X-29 aircraft, two issues slowed the program’s pace. The flight control problem that had led to the one-time shutdown of all three digital flight control computers had to be resolved since the second X-29 had the same system installed. Meanwhile, Air Force budget-tightening left the X-29 program with only one team to service both X-29s. The team had to modify the first X-29’s control system first, since it was still on flying status, and then sequentially treat the second aircraft. All of this delayed delivery of the number two X-29, slipping it to late 1988 instead of June of that year as originally planned.⁶⁰

These delays in gaining use of the second X-29 caused some outside the X-29 program to question the value of the high-AoA program for which the number two aircraft had been modified. Planners envisioned that the X-29 high-AoA program would deliver data that could affect the impending ATF, two competitive prototypes of which (the Lockheed YF-22 and Northrop

Sweeping Forward

YF-23) were under way, scheduled to fly in 1990. Significant delays in the high-AoA effort would make any data acquired too late to benefit their design. The sequential use of the first X-29, followed by the second modified for high-AoA work, reflected cost and scheduling realities faced by the plucky X-29 managers. Back in 1986, planners had intended a two-ship, concurrent X-29 flight program. The delays with delivery of the number two aircraft now threatened to cause the program to extend beyond its forecast end date of September 1989, or else the high-AoA effort would have to be truncated to meet the end-of-program date. Nobody on the X-29 test team favored an abbreviated high-AoA program. Ever light on their feet, the X-29 team now shunted some flight control modification testing back to the number one aircraft instead of the number two aircraft as planned. This would buy some more high-AoA time for the second aircraft.⁶¹

After a 10-week down period during which a FCS software change was accomplished and an engine modification was made, the X-29 program resumed flying on October 6, 1988. During the following 2 months, the X-29 went aloft 29 times—the equivalent of one flight almost every other day—bringing to completion the number one aircraft's flight-test program. These ambitious final flights assessed a new software program and gathered data for military utility testing. The Block VIII-AF software package tested on the number one aircraft had been earmarked for the second X-29, but it was shifted to clear the second aircraft's schedule for high-AoA work. The first pilot using the new software was Air Force Maj. Alan Hoover, who pronounced 360-degree rolls “definitely quicker” and “snappier and crisper.”⁶² NASA's Rogers Smith agreed, adding that “pitch acceleration is markedly quicker.”⁶³ This was the payoff of earlier, cautious software that proved the safety of the concept: now the veteran X-29 handled like a fighter. Most who flew the X-29 with the new software rated it a level 1 in handling—the best numerical evaluation it could receive—with some reserving a slightly lesser level 2 for perceived lateral axis deficiencies.

So confident were the X-29 team leaders that they arranged for the X-29 to fly during the Edwards Air Force Base open house and air show in October 1988. October has been the traditional month for open house activities at Edwards, chosen to coincide with the anniversary of the first supersonic flight that took place there in October 1947; also, the summer heat may be expected by that time to have abated somewhat for visitor comfort on the vast tarmac. Unfortunately, a jet fuel system (JFS) failure caused the cancellation of the air show flight, though visitors could still see the X-29 on static display, exemplifying the latest example of the long-standing Air Force-NASA (and Air Force-NACA, before 1959) flight research enterprise.⁶⁴

The first X-29 completed its final test flight on December 8, 1988, not quite 4 years to the day after its first flight, which it had made on December

14, 1984. In between, it had completed a total of 242 flights, accumulating 178.6 hours aloft. Two flights on that final day were made by guest pilots. Col. John M. Hoffman, then the AFFTC vice commander (a veteran F-105 “River Rat” from Southeast Asia and the service’s senior F-15 test pilot), described the X-29 as a “beautiful handling machine across the board.... [O]ne of the best rolling airplanes I’ve ever flown,” though he noted that “laterally, the X-29A-1 wandered a bit.”⁶⁵ He compared a number of the X-29’s traits with current F-15 and F-16 fighters, and he noted that the X-29 handled turbulence better than did the F-16. About an hour later, Col. David McCloud, director of advanced programs at the Air Force’s Tactical Air Command (TAC) Headquarters at Langley AFB (a highly experienced “aggressor” pilot who had commanded TAC’s elite 4477th Test and Evaluation Squadron, the Red Eagles), took his own turn with the X-29. Though he noted the X-29’s “lateral tracking seemed sluggish,” he praised the X-29’s fighter-like attributes, and, in an ironic twist on the X-29 program management’s long-standing efforts to prevent “weaponizing” the airplane, he wrote: “This is a nice little airplane. Let’s hang some missiles on it!”⁶⁶

Air Force Maj. Dana Purifoy flew the X-29 as a guest pilot on November 18, 1988. (Later, he would become the Air Force X-29 project pilot.) After his guest flight, he noted that the X-29 handled well with a few exceptions—some precision rolling maneuvers were unachievable when using the horizon as a reference, and he termed this “an unacceptable flying mode for agility maneuvers.”⁶⁷ For air-to-ground operations, Purifoy deemed the X-29 to have very good longitudinal control, “but laterally the X-29 was too stiff.”⁶⁸ He soon had more opportunities to assess the X-29, when he flew aircraft number two.

The X-29 team always recognized the inherent potential in the design for high-AoA performance. Now the modified second aircraft, X-29A-2, was poised to deliver on that promise. Managed and funded by the Air Force Flight Dynamics Laboratory out of Wright-Patterson AFB, the high-AoA effort set about evaluating the maneuvering, control system, flying qualities, and military utility aspects of the X-29A-2 in the high-AoA flight envelope, looking to attain about 70 degrees in pitch maneuvering and 40 degrees in yaw and roll maneuvering. As confidence in the X-29 continued to grow, these angles represented major increases over the original X-29A-1 flight control system that had been limited to a maximum AoA of only 24 degrees. The forward swept wing was predicted to offer improved lateral control power at high angles of attack. On paper, testers believed that even though lateral control would diminish with higher AoA, the X-29A-2 could still produce about double the lateral control power of conventional aft swept wing fighters above approximately a 45-degree AoA. This was a trait of forward swept wings, whose spanwise air-flow moved from tip to root, the opposite of conventionally swept wings. The

Sweeping Forward

wingtips of forward swept wings, where lateral control surfaces were mounted, retained useful airflow at higher AoA than did the tips of aft swept wings. For pitch, extremely high-AoA controllability was expected to be the dividend of the X-29's remarkable three-surface pitch controls, made possible only by the taming ability of the aircraft's digital fly by wire control system.⁶⁹

X-29: The Pilot Perspective

Many pilots flew and evaluated the X-29. Their experiences helped determine what was right about the X-29 program as well as what occasionally went awry. The Air Force goes to great lengths to ensure that aircraft of the same model and series are configured identically so that pilots will be able to fly any of the same aircraft smoothly because all controls, switches, and instruments are placed in the same location and function in the same way from aircraft to aircraft. The value of this practice became manifest in the X-29 program when a paddle switch in the actual X-29 cockpit was not accurately replicated in the X-29 flight simulator at Dryden. In the actual aircraft, a paddle switch was used to switch the flight control system to analog reversion mode during testing. In the simulator, there was no paddle switch at that location for that function; flight control analog reversion was achieved in the simulator by depressing the "pickle button" on the fighter-style control stick, explained Ted Wierzbanski. This had the unintended consequence of training X-29 pilots to do the wrong thing. In flight, when trying to select analog reversion mode, "every one of us hit the pickle button in the airplane," Wierzbanski said.⁷⁰

The pilots in the X-29 program helped produce after-action mission flight reports following each test sortie. These reports confirmed data points, discussed successes and failures, and provided tie-in continuity for the following missions. Beyond their indispensability as technical records, these pilot reports occasionally carry personal insights worth reviewing as snapshots along the X-29's path, as sampled below.

Chuck Sewell, Flight 8: "A total of 183 data points were successfully flown on this flight, for an average of 2.1 data points per minute. Once again, the accomplishment of this high number of test points was due to very effective practice sessions in the high fidelity simulation. The simulation of each X-29 flight is absolutely mandatory from both safety and productivity standpoints."⁷¹

Kurt Schroeder, Flight 9: "Of interest was the clear air turbulence present during the 6,800 feet work—the first significant turbulence

that I have experienced in the airplane. I would describe it as light to possibly moderate, resulting in airspeed fluctuations of plus/minus 5 KIAS. The T-38 chase was apparently getting bounced around pretty well and in the debrief described the level as at least moderate. This difference in the perception of the turbulence level can be attributed to the X-29 FCS. For these moderate dynamic pressures, the ride qualities are surprisingly good.”⁷²

Rogers Smith, Flight 12: “The one objectionable feature noted was the excessive pitch stick displacement during tracking and maneuvering in the ND mode. Future ‘tuning’ of the FCS will require a solution to this problem if one wants the X-29 to fly like a fighter.”⁷³

Kurt Schroeder, Flight 13: “While descending from 20,000 feet, the lead was passed to the T-38 to provide an opportunity to fly formation with the X-29. The airplane was very pleasant to fly in the lateral axis. In the longitudinal axis, the X-29 flight control system will not permit use of my normal formation flying procedure. In other airplanes, I feed nose down trim and hold some aft stick pressure which eliminates the control stick deadband and breakout characteristics. In the X-29, one must fly with the stick in detent which I felt resulted in excessive longitudinal stick motion and increased difficulty in making precise longitudinal corrections.”⁷⁴

Chuck Sewell, Flight 15: “The flight was nearly aborted just before takeoff due to fuel and lube oil temperatures approaching limits. Only the EPU check at 85 percent RPM saved the day by running the temperatures down far enough to permit flight. The temperatures rise during the taxiing; especially during the 7.2 mile taxi back at the end of the flight with a low fuel quantity. A parade wing position was flown on the chase F-104 at Mach No.’s of 0.60 to 0.50. It was not easy, in fact, it was very difficult. The lateral sensitivity combined with excessive longitudinal deflections and high longitudinal stick forces resulted in very poor control harmony. The absence of speed brakes also added to the difficulties of flying formation. Throttling back in the F/A-18 results in a rapid deceleration but the aerodynamic cleanness of the X-29 eliminates the advantage provided by the rapid F404 spool-down and the resultant drag increase. I believe this situation would make aerial

Sweeping Forward

refueling difficult and probably hazardous as there is no way to quickly check a high closure rate.”⁷⁵

Kurt Schroeder, Flight 23: “Malfunction of the primary roll rate gyro in Channel B was detected in the ground station several minutes before the failure was sensed by the FCS redundancy management system.... The alertness of Kevin Dowling and Mark Wheeler in detecting the initial malfunction, and the proper functioning of the redundancy management system is very gratifying. As we continue to expand into areas where the ramifications of an FCS problem increase dramatically, the successful handling of this situation is a great confidence builder.”⁷⁶

Designers speak of an aircraft’s ability—or lack thereof—to “degrade gracefully,” a gentle way of saying that the aircraft does not have a single-string weakness that could cause an irrecoverable catastrophic failure. The X-29’s FCS redundancies were designed to let it “degrade gracefully,” giving the pilot opportunity to save himself and the aircraft to fly another day.

Rogers Smith, Flight 29: “This ‘other NASA pilot,’ as noted on the canopy for this flight, enjoyed ‘cleaning up’ after my supersonic friends. It was a great day for the X-29 program—three flights and not a single discrepancy to note on the aircraft. We have come a long way over the last year; those who built the aircraft and those who keep it all running get a special ‘well done’ from this pilot.”⁷⁷

Rogers Smith, Flight 33: “[T]he aircraft continues to amaze me. It feels much the same—solid and smooth—whether you are flying supersonic at high altitude or low and slow. I guess there must be something to the magic of electronic flight control systems.”⁷⁸

Kurt Schroeder, flight 40: “During the layup, the profile of the nose-boom was modified to fair out the ‘step’ just forward of the alpha and beta vanes. This was an attempt to rectify the unexplained jumps in indicated angle of attack and sideslip, however no improvement was noted, and the fairing material will be removed.”⁷⁹

Kurt Schroeder, Flight 72: “The primary objective of this first flight out of an extended layup was to verify the modifications incorporated in the Normal Digital ACC FCS gains. The modified gains produced the desired effect of improving the FCS phase

Program Expansion

and gain margins, permitting expansion of the flight envelope to 1.03 TMN [true Mach number] at 15,000 feet.”⁸⁰

Kurt Schroeder, Flight 81: “[This] constitutes the end point for the X-29 airspeed/Mach/altitude envelope expansion program.... Approaching 1.1 TMN, the ambient noise level in the cockpit began to increase significantly with dynamic pressure. Transmissions from the station were difficult to understand, even with maximum UHF [ultrahigh frequency] volume selected. The T-38 has a similar canopy/windscreen design and exhibits the same characteristic.”⁸¹

Steve Ishmael, Flight 105: “During pitch frequency sweep at 0.90 Mach/30,000 feet in AR-UA [analog reversion up-and-away] mode, pilot reported ‘thumping’ sound. This has been previously reported when the fuel is transferred from the strakes.”⁸² (The strakes contained strake tanks for fuel.)

Kurt Schroeder, Flight 111: “The RAV [Remotely Augmented Vehicle] system steering commands were uplinked to the aircraft for each maneuver.... The RAV angle of attack and Mach deviation presentations were useful in reducing the pilot workload.”⁸³

James Smolka, Flight 154: “Overall impression: X-29A-1 flies ‘better than some production aircraft’ and ‘as well as most of the good flying aircraft I have flown.’ ”⁸⁴

Rod Womer, Flight 157: (Military utility [agility and air-to-air] evaluation). “Although the magnitude of the unload (to minus 0.5 gs) during wings level rolls at 0.90 Mach/30,000 feet was predicted by the simulator, the physical effects were surprising and uncomfortable. On the first roll, for instance, the pilot hit his head on the top of the canopy and instinctively released to less than full lateral stick prior to completion of roll.... Aggressive angle-of-attack capture tasks were remarkably easier in the aircraft than in the simulator.... Longitudinal control displacements were excessive and cumbersome when maneuvering above 3 gs.... Some overshoots occurred during gross acquisition of target. Fine tracking was easily accomplished (HQR=3).”⁸⁵

Alan Hoover, Flight 159: “The flight idle deceleration to 15 degrees alpha took too long. Aircraft needs a speed brake.... Flies nice

Sweeping Forward

in the pattern.... Feels funny in flare—it's fine on the glideslope on the final approach, then it doesn't want to set down on the runway.... It felt uncomfortable having to move the stick forward to get down onto the runway."⁸⁶

Harry Walker, Flight 160: "Roll performance—unload is not the same as simulator. Need to use rudder to coordinate roll.... Pitch agility—pitch rate is inadequate. Unacceptable for front-line fighters...."⁸⁷

Ed Schneider, Flight 171: "Aircraft leaped off the ground on take-off. More pitchup than desired.... Aircraft very easy to fly. Very high powered T-38."⁸⁸

Gordon Fullerton, Flight 185: "The pilot was impressively 'underwhelmed' with the handling of the airplane. For all of the exotic elements in the airplane's design and the control system, it wasn't wild at all; it behaved conventionally, with natural pilot inputs being all that was required to fly it.... There was nothing felt when passing through Mach 1. The barometric gauges jumped, but the control system handled any required controls changes automatically (a 1g level acceleration and then a 3g deceleration were performed). During the 3g deceleration from 1.1 Mach to 200 knots, the loop and Immelman maneuvers, the airplane did not feel like it was about to run out of lift.... The X-29 always felt like there was no imminent change to lift during these maneuvers.... Altogether it felt like a good airplane to go 'cut up the sky'. It took very little effort to do the desired maneuvers, through a range of speeds and altitudes, with a solid feeling and smooth response to inputs.... Throttle response was smooth and the acceleration brisk, even through Mach 1. Target airspeeds were easily captured."⁸⁹

Rogers Smith, Flight 197: "Maneuvering with the new stick mod (reduced longitudinal throw and improved ratio of mechanical to electrical dead band) is now more precise. You can stop the aircraft on a dime."⁹⁰

Rogers Smith, Flight 200: "There was no interference from KC-135 tanker during simulated refueling task. Aircraft is controllable."⁹¹

Program Expansion

Alan Hoover, Flight 202: “Stick gearing software is too sensitive at the 1.03 Mach/5,000 foot conditions causing a possible PIO tendency. Pilot was conscious of driving oscillation, but on the second pass at this flight condition he was able to control oscillation by concentrating on holding longitudinal stick constant.”⁹²

Alan Hoover, Flight 218: “Regarding the airshow demonstration profile, the use of gear and flaps as ‘substitute’ speed brakes was satisfactory.”⁹³

Dana Purifoy, Flight 234: “Throttle friction seemed tight and ratchety—got used to it after awhile.... Cockpit visibility ‘was not all that sterling’ for a fighter, but handling qualities were very good.”⁹⁴

Stephen Ishmael, Flight 236: “The aircraft’s handling qualities have definitely been improved.... Air-to-ground—in pitch good. Directional axis, however, it takes tenacity to make aircraft move in this axis. Typical comments from all pilots who have flown this task.”⁹⁵

John Hoffman, Flight 240: “X-29A-1 is a beautiful handling machine across the board.... Landing in the NORM/MCC [normal/mission-control-center] mode was very stable and smooth. Very controllable, with light stick forces and a positive flare action. The X-29A-1 is a ‘solid’ platform and handled turbulence much better than the F-16. Overall impression: *The X-29A-1 was a joy to fly.*”⁹⁶ (Emphasis added.)

Endnotes

1. Wierzbowski, interview by Young.
2. Rogers Smith, e-mail message to Richard Hallion, January 12, 2012.
3. The X-29's PIO characteristics might have reflected a modeling error due to erroneous wind tunnel data, which would have led to inputting erroneous information into the TIFS aircraft, or it might have reflected the TIFS aircraft's own inherent performance limitations. For a detailed examination of the various tunnel tests and free-flight model tests undertaken in support of the X-29 program, see Joseph R. Chambers, *Partners in Freedom: Contributions of Langley Research Center to U.S. Military Aircraft of the 1990's*, NASA Special Publication (SP)-2000-4519 (Washington, DC: NASA, 2000), 109–122.
4. Ted Wierzbowski, interview by Frederick A. Johnsen, Air Force Flight Test Center, June 2011.
5. Ibid.
6. Rogers Smith, e-mail message to Richard Hallion.
7. Joseph Gera, e-mail message to Richard Hallion, January 21, 2012.
8. Sitz, interview by Johnsen, February 3, 2012.
9. Ibid.
10. Ibid.
11. Gera, e-mail message to Hallion.
12. Ted Wierzbowski, e-mail message to Frederick A. Johnsen, September 23, 2011.
13. Wierzbowski, interview by Johnsen.
14. Ibid.
15. Ibid.
16. Ibid.
17. Walter J. Sefic and Cleo M. Maxwell, "X-29A Technology Demonstrator Flight Test Program Overview," NASA TM 86809 (May 1986), 3–4.
18. John W. Hicks, James M. Cooper, Jr., and Walter J. Sefic, "Flight Test Techniques for the X-29A Aircraft," NASA TM 88289 (February 1987), 8.
19. Ibid.
20. Gary A. Trippensee and David P. Lux, "X-29A Forward-Swept-Wing Flight Research Program Status," NASA TM 100413 (November 1987), 3–4.
21. Wierzbowski, interview by Johnsen.
22. Ibid.

23. Ken Griffin, e-mail message to Frederick A. Johnsen, October 18, 2011.
24. Ibid.
25. "History of the Air Force Flight Test Center 1 October 1984–30 September 1987," Air Force Test Center History Office (excerpted from unclassified, unrestricted portions).
26. Ibid.
27. Wierzbanski, interview by Young.
28. "History of the Air Force Flight Test Center 1 October 1984–30 September 1987," Air Force Test Center History Office (excerpted from unclassified, unrestricted portions).
29. Wierzbanski, interview by Young. Just such a desire to accelerate testing led to disaster in the early 1950s with the original F-100A flight-test program. Flights got so far ahead of reliable performance and handling qualities data that the plane entered dangerous test circumstances, leading to the death of North American's chief test pilot, George Welch.
30. John T. Bosworth, "Linearized Aerodynamic and Control Law Models of the X-29A Airplane and Comparison With Flight Data," NASA TM 4356 (1992), 1.
31. Rogers Smith, e-mail message to Richard Hallion.
32. Robert Clarke, John J. Burken, John T. Bosworth, and Jeffery E. Bauer, "X-29 Flight Control System: Lessons Learned," NASA TM 4598 (June 1994).
33. Gera, e-mail message to Hallion.
34. Ibid.
35. Ibid.
36. Ibid.
37. Ibid.
38. Clarke et al., "X-29 Flight Control System: Lessons Learned," 12-14–12-15.
39. Gera, e-mail message to Hallion.
40. Wierzbanski, interview by Young.
41. Ibid.
42. J. Rivers to W. Mebes et al, memorandum, "Subj: X-29A Concept Evaluation Phase (CEP)—On-Site Engineering and Flight Test Engineering Status Report for May 1987," Grumman (June 10, 1987), Wierzbanski X-29 papers and general X-29 files, Air Force Test Center History Office.
43. Ibid.
44. Wierzbanski interview by Young.

Sweeping Forward

45. "History of the Air Force Flight Test Center 1 October 1987–30 September 1988," Air Force Test Center History Office (excerpted from unclassified, unrestricted portions).
46. Ibid.
47. Ibid.
48. Ibid.
49. Ibid.
50. Ibid.
51. 6510th Test Wing Commander to AFWAL/FI, letter, "Subj: Lesson Learned: X-29 Flight Control System," December 1, 1987, Wierzbanski X-29 papers and general X-29 files, Air Force Test Center History Office.
52. Ibid.
53. "History of the Air Force Flight Test Center 1 October 1987–30 September 1988," Air Force Test Center History Office.
54. Sitz, interview by Johnsen.
55. "History of the Air Force Flight Test Center 1 October 1987–30 September 1988," Air Force Test Center History Office.
56. Ibid.
57. Ibid.
58. Ibid.
59. The exhibit was notable for also producing the first overview of the computer-in-aerospace revolution, by exhibit curator Paul E. Ceruzzi. See his *Beyond the Limits: Flight Enters the Computer Age* (Cambridge, MA: The MIT Press, 1989).
60. "History of the Air Force Flight Test Center 1 October 1987–30 September 1988," Air Force Test Center History Office.
61. Ibid.
62. "History of the Air Force Flight Test Center 1 October 1988–30 September 1989," Air Force Test Center History Office.
63. Ibid.
64. Maj. Alan D. Hoover (USAF, X-29 Project Manager), "X-29A Forward Swept Wing Advanced Technology Demonstrator Six Month Project Summary" (undated), Wierzbanski X-29 papers and general X-29 files, Air Force Test Center History Office.
65. "History of the Air Force Flight Test Center 1 October 1988–30 September 1989," Air Force Test Center History Office.
66. Ibid. This was far from the first time that an operational fighter pilot endorsed swiftly weaponizing an experimental airplane. After flying the Convair XF-92 delta test bed, Chuck Yeager had immediately pressed to arm it with six 0.50 caliber machine guns; in the early

1950s, TAC pilots had such enthusiasm for the YF-100A that they forced early release of the airplane over the protests of Edwards test pilots, with disastrous consequences. Fighter pilots and test pilots represent two different wings of the aerospace community, and, like air and land power (to paraphrase the War Department Field Manual of 1943 [FM-100-20]), “are coequal and interdependent. Neither is an auxiliary of the other.”

67. Ibid.
68. Ibid.
69. Ibid.
70. Wierzbowski, interview by Johnsen, September 24, 2011.
71. C.A. Sewell, “Grumman Aerospace Corp. Flight Report, Flight No. 8” (April 16, 1985), Wierzbowski X-29 papers and general X-29 files, Air Force Test Center History Office.
72. Kurt Schroeder, “Grumman Aerospace Corp. Flight Report, Flight No. 9” (May 21, 1985), Wierzbowski X-29 papers and general X-29 files, Air Force Test Center History Office.
73. R.E. Smith, “NASA Flight Report, Flight No. 12” (June 6, 1985), Wierzbowski X-29 papers and general X-29 files, Air Force Test Center History Office.
74. Kurt Schroeder, “Grumman Aerospace Corp. Flight Report, Flight No. 13” (June 6, 1985), Wierzbowski X-29 papers and general X-29 files, Air Force Test Center History Office.
75. C.A. Sewell, “Grumman Aerospace Corp. Flight Report, Flight No. 15” (June 11, 1985), Wierzbowski X-29 papers and general X-29 files, Air Force Test Center History Office.
76. Kurt Schroeder, “Grumman Aerospace Corp. Flight Report, Flight No. 23” (November 20, 1985), Wierzbowski X-29 papers and general X-29 files, Air Force Test Center History Office.
77. R.E. Smith, “NASA Flight Report, Flight No. 29” (December 20, 1985), Wierzbowski X-29 papers and general X-29 files, Air Force Test Center History Office. McCloud went on to an outstanding Air Force career, which ended tragically when, as a Lieutenant General and commander of 11th Air Force and Alaskan Command, he died with a fellow pilot in the crash of a light aircraft on July 26, 1998.
78. R.E. Smith, “NASA Flight Report, Flight No. 33” (February 7, 1986), Wierzbowski X-29 papers and general X-29 files, Air Force Test Center History Office.
79. Kurt Schroeder, “Grumman Aerospace Corp. Flight Report, Flight No. 40” (June 10, 1986). Wierzbowski X-29 papers and general X-29 files, Air Force Test Center History Office.

Sweeping Forward

80. Kurt Schroeder, "Grumman Aerospace Corp. Flight Report, Flight No. 72" (October 24, 1986), Wierzbowski X-29 papers and general X-29 files, Air Force Test Center History Office.
81. Kurt Schroeder, "Grumman Aerospace Corp. Flight Report, Flight No. 81" (November 14, 1986), Wierzbowski X-29 papers and general X-29 files, Air Force Test Center History Office.
82. S. Ishmael, "X-29 Forward Swept Wing Aircraft Post Flight Summary, Flight No. 105" (June 19, 1987), Wierzbowski X-29 papers and general X-29 files, Air Force Test Center History Office.
83. Kurt Schroeder, "X-29 Forward Swept Wing Aircraft Post Flight Summary, Flight No. 111" (July 24, 1987), Wierzbowski X-29 papers and general X-29 files, Air Force Test Center History Office.
84. J. Smolka (guest pilot), "X-29 Forward Swept Wing Aircraft Post Flight Summary, Flight No. 154" (December 11, 1987), Wierzbowski X-29 papers and general X-29 files, Air Force Test Center History Office.
85. R. Womer, "X-29 Forward Swept Wing Aircraft Post Flight Summary, Flight No. 157" (January 13, 1988), Wierzbowski X-29 papers and general X-29 files, Air Force Test Center History Office.
86. A. Hoover, "X-29 Forward Swept Wing Aircraft Post Flight Summary, Flight No. 159" (January 13, 1988), Wierzbowski X-29 papers and general X-29 files, Air Force Test Center History Office.
87. H. Walker, "X-29 Forward Swept Wing Aircraft Post Flight Summary, Flight No. 160" (January 22, 1988), Wierzbowski X-29 papers and general X-29 files, Air Force Test Center History Office.
88. E. Schneider (guest pilot), "X-29 Forward Swept Wing Aircraft Post Flight Summary, Flight No. 171" (March 16, 1988), Wierzbowski X-29 papers and general X-29 files, Air Force Test Center History Office.
89. C.G. Fullerton (guest pilot), "X-29 Forward Swept Wing Aircraft Post Flight Summary, Flight No. 185" (April 22, 1988), Wierzbowski X-29 papers and general X-29 files, Air Force Test Center History Office.
90. R. Smith, "X-29 Forward Swept Wing Aircraft Post Flight Summary, Flight No. 197" (June 8, 1988), Wierzbowski X-29 papers and general X-29 files, Air Force Test Center History Office.
91. R. Smith, "X-29 Forward Swept Wing Aircraft Post Flight Summary, Flight No. 200" (June 8, 1988), Wierzbowski X-29 papers and general X-29 files, Air Force Test Center History Office.

Program Expansion

92. A. Hoover, "X-29 Forward Swept Wing Aircraft Post Flight Summary, Flight No. 202" (July 6, 1988), Wierzbanski X-29 papers and general X-29 files, Air Force Test Center History Office.
93. A. Hoover, "X-29 Forward Swept Wing Aircraft Post Flight Summary, Flight No. 218" (October 18, 1988), Wierzbanski X-29 papers and general X-29 files, Air Force Test Center History Office.
94. Maj. Dana Purifoy (guest pilot), "X-29 Forward Swept Wing Aircraft Post Flight Summary, Flight No. 234" (November 18, 1988), Wierzbanski X-29 papers and general X-29 files, Air Force Test Center History Office.
95. S. Ishmael, "X-29 Forward Swept Wing Aircraft Post Flight Summary, Flight No. 236" (day obscured, November 1988), Wierzbanski X-29 papers and general X-29 files, Air Force Test Center History Office.
96. Col. J. Hoffman (guest pilot), "X-29 Forward Swept Wing Aircraft Post Flight Summary, Flight No. 240" (December 11, 1987), Wierzbanski X-29 papers and general X-29 files, Air Force Test Center History Office.



Beak-to-beak: The first X-29 (X-29A-1, left) and the second X-29 (X-29A-2, right) on a High Desert moonlit evening, 1990. (NASA)

CHAPTER 5

The X-29 Follow-On Program

The X-29A program plan mapped development and test work through four phases while anticipating the requirement for as many as four additional phases, then unfunded. Phase Five called for high-angle-of-attack (high-AoA, or “high alpha”) testing as well as military utility testing. The rigors of these envelope expanding flights would demand the availability of a spin chute—an airframe-mounted parachute to be deployed in the event that the X-29 departed controlled flight and entered an unrecoverable spin. Phase Six envisioned alternate flight control laws for the X-29’s digital-fly-by-wire computers. Phase Seven proposed placing wing-mounted stores on the X-29 to assess their effect on the flutter and divergence characteristics of the forward swept wing. Preliminary analysis and testing suggested that the nature of the wing would accommodate external stores with no net reduction in the limit speed for the airplane, making forward swept wings attractive to military planners. Interestingly, although X-29 planners overtly shied away from making it a combat-capable aircraft, lest its pedigree as an X-plane be questioned by those who held sway over some funding streams, the aircraft nonetheless carried some secrets. According to NASA: “Hard points have been designed and fabricated into the wing structure for the carriage of stores, however, no wiring or other provisions for stores release have been incorporated in the airplane.”¹

Future Plans

The final phase, Phase Eight, contemplated installing a vectored-thrust nozzle on the X-29’s GE F404 engine. A Grumman study suggested significant improvements in X-29 performance and controllability would ensue. This phase would also establish the projected benefits of integrating the propulsion control with the flight control.²

In April 1985, Grumman gave the Air Force an unsolicited proposal calling for installing and instrumenting a spin-parachute system on the second

Sweeping Forward

X-29A, at a cost of \$6.2 million. Testing was not mentioned in this proposal, just hardware and instrumentation. Sent directly to Air Force headquarters, the Grumman proposal generated enough interest that Air Force Systems Command was tasked to study the idea and brief the Air Force on it. Because of ongoing work on the X-29 program, Ted Wierzbowski was in a position to provide good counsel to the Air Force. Working with Col. Larry Van Pelt, former commander of the Air Force Test Pilot School and then commander of the Air Force Flight Dynamics Laboratory, the two Air Force officers came up with a briefing to go up the chain of command regarding Grumman's proposal. When the briefing reached Lt. Gen. Thomas McMullen, Aeronautical Systems Division commander, he committed \$3.6 million of his 1986 budget, provided the Air Force would pick up the needed amount for 1987 and 1988. Grumman voiced the intent to pay some program costs in out-years, as did DARPA. Wierzbowski and other X-29 team members briefed the need to continue flying both X-29s to a number of flag officers who could exert influence over the program, including the Tactical Air Command's vice commander, Lt. Gen. Robert E. Kelley, who expressed his own interest in keeping the X-29 flying. Questions to, and answers from, AFFTC commander Maj. Gen. William T. "Ted" Twinting reinforced AFFTC's interest in keeping the X-29 program funded for high-AoA work and other tests. Wierzbowski's brand of shuttle diplomacy gleaned a commitment in January 1986 from the Air Force to support the follow-on X-29 program with \$4.1 million over a 3-year period.³

The Air Force's commitment was based on some soft-dollar amounts from other players; in January 1986, firm amounts for an X-29 follow-on program were not in hand. NASA and AFFTC refined their statements of work for the proposed high-AoA program in an effort to secure definite funding for that effort. The value of the high-AoA program, explained Wierzbowski, "is not to demonstrate the capabilities of the X-29 but to use the X-29 as a research vehicle to validate our predictive tools, our analysis tools[, and]...to understand all that 'stuff.'"⁴ While other jet fighters could attain high angles of attack, only the instrumented X-29 could generate quantified and documented performance data, which were very valuable to the design community.

With the refiguring of X-29 follow-on program needs in 1986, the program team concluded their total funding streams would only cover \$22.1 million of a program that would actually cost \$30 million. At that time, the Air Force faced critical funding needs across a range of new programs, particularly the ongoing Rockwell B-1, Northrop B-2, Lockheed F-117, McDonnell-Douglas F-15E, Boeing-Martin-Thiokol MX Peacekeeper, McDonnell-Douglas C-17, General Dynamics AGM-129 programs, and the emerging Advanced Tactical Fighter competition; Colonel Thaddeus Sandford, who had succeeded Larry Van Pelt as Air Force Flight Dynamics Laboratory commander, stressed keeping

The X-29 Follow-On Program

laboratory programs on budget. Overruns, whether the result of assumptions and ambitions or the result of deliberate “low-ball” estimates, were intolerable. Wierzbanski asked Colonel Sandford to discuss funding with Grumman to firm up their commitment. But Grumman executives, having already used as much as \$55 million of company money on the X-29 fixed-price contract (and while willing to forego their expected profit on the follow-on program), would not agree to contribute more money from company coffers. Faced with the reality of \$23 million to cover a \$30 million proposal, NASA and the Air Force Flight Test Center regrouped and agreed to fly the high-AoA research flights with the number one airplane without the safety of a spin chute because, as Wierzbanski recalled, “for that amount of money we couldn’t do a complete program.”⁵

Understandably, the Air Staff non-concurred. Instead, Maj. Gen. Donald L. Lamberson, the assistant deputy chief of staff for research, development, and acquisition at Air Force headquarters, recommended that the X-29 team stretch the program out, flying their high-AoA program in 1989 (when more money would be available) instead of 1988. With the program thus “re-baselined,” he contacted DARPA about adding more funding. Following another X-29 team briefing, DARPA agreed to add \$2 million for 1989. The upshot was to be a high-AoA program flown by the number two airplane with the number one airplane’s work being completed before then.⁶

Ground (and Other) Effects

The number one aircraft performed the initial flight envelope expansion between December 1984 and December 1988. During this phase, testers limited the X-29 to an angle of attack of 22.5 degrees. When the spin-chute-equipped second X-29 deliberately attacked high-AoA test points, the experimental FSW aircraft successfully attained a 66-degree angle of attack—but this aggressive AoA work was only possible due to the meticulous envelope expansion conducted earlier with the first X-29.⁷

The forward swept wing offered other unusual phenomena for the test team to consider. When rotating nose-high on takeoff, the wingtips of the X-29 rose higher off the runway; in contrast, on aft-swept wing jets, the wingtips dipped closer to the runway during nose-up rotation. All of this impinged on “ground effect,” an aerodynamic phenomenon that occurs to aircraft typically flying within approximately one-half-wingspan equivalent to the ground. Ground effect stifles the full development of wingtip vortices until the aircraft climbs into free air above the reach of ground effect. Aircraft may fly more efficiently in ground effect as a result of this, with higher lift and lower drag (indeed, researchers have

Sweeping Forward

long-experimented with so-called “Wing-in-Ground Effect” [WIG] designs, taking advantage of this phenomenon). NASA portrayed the X-29 in ground effect in a brief study that compared flight measurements with earlier modeling and wind tunnel predictions. Wind tunnels can employ a ground plane mounted near the model to simulate nearness to the runway, but a wind tunnel ground plane lacks the vertical descent and ascent of an actual airplane as it lands or takes off. Ground effect on the X-29 was described by NASA; the methodology highlights the program’s ongoing efforts to quantify modeling accuracy and devise ways to reconcile modeling and flight-test differences:

A limited flight experiment was conducted to document the ground-effect characteristics of the X-29A research airplane.... The flight-test program obtained results for errors in the air data measurement and for incremental normal force and pitching moment caused by ground effect. Correlations with wind-tunnel and computational analyses were made.

The results are discussed with respect to the dynamic nature of the flight measurements, similar data from other configurations, and pilot comments. The ground-effect results are necessary to obtain an accurate interpretation of the vehicle’s landing characteristics. The flight data can also be used in the development of many modern aircraft systems such as autoland and piloted simulations.

An understanding of ground effects is important for the development of many modern aircraft systems and for accurate interpretation of vehicle flying qualities. These data must include the ground effects on total vehicle forces and moments as well as perturbations of aerodynamic (angle-of-attack and airspeed) sensors which may be used for control system feedback. Valid analytical models of these effects are required to support high fidelity simulators, used for flight-time equivalent pilot training. These models are also required in the development of advanced flight control systems such as autoland.

Ground effects for a variety of planform types such as aft-swept, delta, and low-aspect-ratio wings have been studied in the past.... Recent studies...have indicated substantial variations between ground effects determined from steady-state conditions (constant height above ground) and dynamic conditions (such as landing approaches). Flight testing allows the determination of ground effects under dynamic conditions, which are typically not simulated in wind tunnels or computational analysis.

... As part of the flight-test program a series of maneuvers was conducted to determine the ground effects related to this unique configuration. Flight data were obtained at angles of attack from 6.5 to 8.5 degrees and indicated airspeeds from 145 to 160 kn....

Flight data were obtained from onboard sensors and a ground based optical tracking system during shallow approaches to the runway. The analysis included balancing the vehicle forces and moments and correcting for pilot inputs during the maneuvers. The data were correlated with a limited set of wind-tunnel data, obtained with a fixed ground board in a low-speed wind tunnel. In addition, two numerical techniques, aerodynamic preliminary analysis system (APAS) and panel aerodynamics (PANAIR), were also applied to the configuration in ground effect. The APAS code...uses a constant-pressure panel method with limited modeling capability. The PANAIR code...is a higher-order panel method which offers greater modeling capability but requires more computer resources and user effort.

The principal onboard measurements in this study were inertial rates and accelerations, control surface positions, air data, and fuel quantities. The data were encoded by a pulse code modulation system with 10-bit resolution and were telemetered to a ground station. The flight data were obtained at rates up to 200 samples/sec.... A cine-theodolite (optical tracking) system was used to determine aircraft position with respect to a fixed ground reference system.... Two calibrated motion picture cameras tracked the aircraft as it maneuvered close to the runway. The tracking provided elevation and azimuth values referenced to each camera location. Triangulation of these measurements determined aircraft position. Sink rate, flightpath angle, and other pertinent parameters were derived from the position data. The accuracy of the measurements depended on the distance between the aircraft and the camera installations. Because of the small size of the X-29A aircraft and the shallow approaches used in this experiment, good optical data were available only for approximately the last 50 feet of descent. The optical data were obtained at a rate of 4 samples/second.

All maneuvers were flown by the same general procedure.... While at a constant altitude in the landing pattern, the pilot selected the power approach configuration (wing flap and gear down) normally used for landing the airplane. After the airplane was aligned with the runway, the pilot established a shallow descent at a predetermined sink rate, and optical tracking began.

Sweeping Forward

During the descent the pilot minimized use of the control stick and throttle. As the airplane approached the runway and responded to ground effect, the pilot tried to maintain a constant indicated angle of attack using pitch stick inputs. On some maneuvers, the throttle was reduced in order to ensure touchdown. When the airplane leveled off or the main gear touched down, the optical tracking was terminated and the pilot conducted a “go around” maneuver. Ground-effect maneuvers were not attempted if surface winds exceeded five knots in any direction.⁸

In their analysis of one mission, researchers reported:

The angle of attack, pitch rate, and canard position indicate an oscillation in the pitch axis during the first few seconds, probably caused by small flightpath adjustments or atmospheric turbulence. . . . As the airplane descends below 15 feet above ground level (AGL), it begins to flare, as the altitude and vertical speed data show. At the same time, the angle of attack generally decreases, indicating that additional lift is being generated because of ground effect. During the last 10 feet of vertical descent, stick commands diminish while the canard moves to a more positive (trailing-edge down) deflection. This movement is produced by the flight control system. The strake flap surface movement, not shown, is inversely proportional to the canard movement.

A total of 10 maneuvers were attempted over a series of four nonconsecutive test flights. Of these, four maneuvers were not analyzed because of gaps in the optical tracking data or excessive control inputs. For all maneuvers, the normal force coefficient ranged from 0.95 to 1.15 and angle of attack ranged from 6.5 to 8.5 degrees prior to entering ground effect. Because of the limited flight time available for this study, a wider variety of flight conditions was not attempted, and the pilots had little opportunity to practice the technique.

For several reasons, the flight maneuver was a difficult task to perform with precision. In order to maintain quasi-steady flight conditions, the pilot had to monitor the angle-of-attack display inside the cockpit, while simultaneously verifying a safe approach to the runway. The maneuver relies on the increased lift caused by ground effect to help flare the airplane and provide an acceptable touchdown sink rate. The pilot does not experience this effective ground-effect cushion until the last few seconds of the descent.

As a safety precaution, on the first attempts the targeted descent rates prior to encountering ground effect were very shallow (approximately 100 feet/minute). As confidence increased, the targeted descent rates were increased to 500 feet/minute. In all maneuvers, the sink rate decreased substantially as the airplane descended below about 15 feet AGL....

The pilots attempted to conduct the maneuver near the midpoint of the runway in order to minimize distance from the tracking camera installations.... Because of the shallow sink rates, it was difficult for the pilot to visually plan his descent to touchdown near the midpoint. On the last flight, ground radar tracking data, monitored in the control room, was successfully used to advise the pilot when to begin his descent....

Data from the optical tracking system and aircraft telemetry stream were merged by linearly interpolating the telemetered data to fit the optical data sample times. The center of gravity, weight, and inertias were computed from the fuel quantity data. The acceleration and angular rate measurements were adjusted to the flight center of gravity. The noseboom static pressure and angle-of-attack vane measurements were adjusted for upwash and position error using corrections developed from 'out-of-ground-effect' (altitudes above the point where ground effect influences aircraft behavior) flight calibrations. These calibrations were obtained from tower fly-by, radar tracking, and trajectory reconstruction techniques. The accuracy of the static pressure error calibration is approximately 20 feet (pressure altitude).

The effects of ground proximity on air-data measurements were determined by comparing the onboard aerodynamic sensor data (noseboom angle-of-attack vane and static pressure) to data from independent, non-aerodynamic, sources (optical tracking and inertial sensors). Pressure altitude above ground was determined by subtracting the current ground-level ambient pressure from the noseboom static pressure. The test site is at an altitude of approximately 2,300 ft above sea level. Altitude above ground was also determined from non-aerodynamic sensors by subtracting the runway altitude from the optically measured altitude. The runway was modeled as a sloped surface defined in three dimensional space. The optically measured altitude at touchdown on several runs showed the method to be accurate to within one foot. An angle-of-attack measurement which does not rely on aerodynamic sensors was made from a combination of the onboard pitch

Sweeping Forward

attitude data and the flightpath angle determined from optical tracking data.

The total vehicle normal force, axial force, and pitching moment were determined from the mass, inertias, and accelerations. These values include all aerodynamic forces (including ground effect) and thrust. The pitching moment was adjusted to the reference center of gravity. The contributions of out-of-ground-effect aerodynamics were estimated by the use of a nonlinear aerodynamic database developed from wind tunnel data. This database accounts for control surface positions, angle of attack, angle of sideslip, and pitch rates and has been extensively validated with flight-test results. The database estimates were subtracted from the flight measured forces and moments. The difference generally included a constant offset in the data at altitudes above ground effect. This offset was attributed to the effects of thrust or discrepancies in the database and was subtracted from the results. A nine-point moving average technique was used to fair the final data. This process eliminated extraneous variations in the data from sources such as gusts or inaccuracies in the nonlinear aerodynamic model....

The difference between noseboom measured pressure altitude AGL and the optically measured altitude AGL represents the static pressure measurement error caused by ground effect.... Results from two maneuvers...indicate an error of up to seven feet at touchdown. This magnitude is consistent with results from other noseboom systems.... Two maneuvers...were conducted with constant throttle setting. Useful results were not obtained from the other four test maneuvers, which included variations in throttle setting. Changes in engine thrust level appear to produce static pressure measurement errors of sufficient magnitude to mask the errors caused by ground effect.

The comparison of angle-of-attack measurements from the aerodynamic sensor (noseboom vane) to those from non-aerodynamic sensors indicated no sensitivity to ground proximity. After this was determined, the angle-of-attack vane measurement was used in the analysis of the force and moment data.⁹

The data showed X-29 ground effect to be negligible at altitudes above 15 feet AGL, essentially what one would have anticipated both from the innate phenomenology of ground effect itself and the configuration of the X-29. But, interestingly, modeling and wind tunnel data had both predicted larger ground effect impact for the X-29 than either theory or the actual flight data showed. The wind tunnel and panel methods were based on a steady aerodynamic

The X-29 Follow-On Program



The first X-29 just after takeoff, transiting from ground-effect into full-flight. (NASA)

configuration at constant height above the ground. The lower normal-force increments observed in flight were likely the result of a lag in the aerodynamic flow-field as distance between the airplane and the ground decreased. X-29 testers reviewed earlier model-versus-aircraft data on the huge North American XB-70A Valkyrie Mach 3+ canard-delta, and the Lockheed F-104, and noted a similar trend to predict higher ground effect than flight data actually revealed.¹⁰

NASA analysts concluded:

It was found that even slight power adjustments during the flight maneuvers produced pitching moments which masked the ground-effect characteristics. Therefore, data from several maneuvers which included power adjustments could not be used. The flight data show variations at altitudes well above 30 feet AGL (out-of-ground-effect), presumably because of turbulence or other features which were not accounted for in the analysis. The magnitude of the ground-effect increments are small with respect to the total untrimmed pitching moments at these conditions, which may also account for some of the scatter in the flight data. The ground-effect increment at 9 feet AGL is about 0.01 nose-down, equivalent to the pitching moment created by an angle-of-attack change of only 0.3 degrees.

The flight and wind-tunnel data agree poorly. The discrepancies may be because of dynamic maneuver effects, as discussed in the normal force data, or the use of a static ground plane in the

Sweeping Forward

wind tunnel testing. The data are insufficient to explain the poor correlation of results....

Flight measurements of axial force increments caused by ground effect were inconclusive. The measurements were clearly sensitive to any variation in power setting and no reasonable trends could be developed from the data. Wind-tunnel measurements of axial force... indicate that values at the flight-test conditions may be very small with respect to axial force of the total vehicle.

During early flight tests of the X-29A airplane, pilots commented that the airplane tends to float excessively if the landing flare is initiated too early, requiring the pilot to force the airplane down with forward stick inputs.... This undesirable characteristic has been identified in other aircraft which, like the X-29A, incorporate pitch rate command, attitude hold flight control systems.

Data from the present analysis indicate moderate levels of lift and nose-down pitching moments caused by ground effect. It should be noted that the canard generates positive trim lift when used to balance nose-down ground-effect pitching moments. This is contrary to most configurations with aft-located longitudinal control surfaces. This additional trim lift may account for some of the float tendencies noted by the pilots.

The flight-test program was successful in determining ground effects related to air-data measurements, normal force, and pitching moment of the X-29A airplane. The results were obtained from a minimal amount of total flight time (10 landing approaches). A longer flight program may have allowed a wider variation of flight conditions and would have allowed greater pilot proficiency in conducting the test maneuver.

The static pressure measurement error caused by ground effect was identified and is consistent with other aircraft which use nose-boom systems. The angle-of-attack measurement was found to be insensitive to ground effect. The flight-measured normal forces in ground effect were up to 17 percent greater than the out-of-ground-effect values. The increases predicted by computational or wind-tunnel methods were substantially greater than those encountered in flight. This discrepancy has been demonstrated for other configurations and has been attributed to the dynamic nature of the flight maneuver. The difference between dynamic and steady-state ground-effect results can be of equal magnitude to differences related to configuration.¹¹

Taking on the “High-AoA” Challenge

The procurement of sufficient parts to construct a second X-29 aircraft initially may have been a hedge against the potential for losing the first during testing. Over time, Grumman and its Government partners on the program grew to appreciate the potential for configuring the second X-29 specifically to explore the high-AoA regime. Essentially, the two-aircraft X-29 program ran sequentially, with most flights of the number one X-29 finished before the second aircraft came on line. The second X-29 (designated the X-29A-2 to distinguish it from the first) was the only one of the pair fitted with a spin chute, a pyro-technically launched parachute attached to a mortar-like dispenser on the aft fuselage. Spin chutes are a vital necessity in high-AoA testing, where a “departure” from controlled flight might result in the aircraft entering a stabilized flat spin in which the pilot lacks sufficient control authority to break out of it. Such problems have plagued many aircraft. A spin chute causes an aircraft that is in a spin to pitch downward, breaking the rotation and resulting in the aircraft transitioning into a spiral and, eventually, a dive. With the aircraft stabilized in a dive and conventional control authority restored, the pilot can jettison the chute and continue to fly normally back to base. Installing a spin chute on the X-29A-2 was a prudent precaution given the uncertainties about its behavior at high AoA and the risk that it might depart and enter a stabilized spin.

A necessary evil that attends aircraft programs with finite funds, few spares, and limited time is the “can bird.” Short for “cannibalization,” the can bird is a parked aircraft that surrenders vital parts to keep another aircraft flying. It is usually only a short-term economy since sooner or later the can bird will be needed, and its return to flight can be costly. In the case of the two X-29As, the number two aircraft had given parts to keep the first airplane flying. Now, with some stretch in the high-AoA program schedule, the X-29 team needed to take time to reconstitute the second aircraft for its upcoming role. The main objective for flying the second X-29A “was to evaluate the slow-speed, high-angle-of-attack characteristics of the unique X-29 configuration [in] fully maneuvering flight up to 40 degrees angle of attack and during symmetric pull-ups of pitch pointing to 70 degrees angle of attack.”¹²

In the years leading up to the 1986 go-ahead decision for the high-AoA X-29 follow-on program, the NASA Langley Research Center performed wind tunnel modeling to glean predictive data about the X-29 at high angles. NASA Langley also funded a 22-percent-scale drop model of the X-29 for free-flight realism.¹³ One scale X-29 model flew high-AoA free-flight tests in the NASA Langley 30-by-60-ft Full Scale Tunnel (FST). In a 1982 paper discussing this preflight work, NASA’s Daniel G. Murri said: “The primary purpose of the tests was to study stability and control characteristics up to the stall and to make an

Sweeping Forward

initial assessment of control-system requirements for high-alpha [i.e., high-AoA] flight.”¹⁴ But modeling the X-29 came with two major challenges: the very high level of inherent static pitch instability of the design and the susceptibility of the configuration to large amplitude wing rock above 25 degrees AoA. Murri continued: “To minimize trim drag during transonic maneuvering, the X-29A is balanced to negative 32 percent static margin at low speed. . . . This level of [in] stability is nearly an order of magnitude higher than those of current fighters, such as the F-16, that incorporate the Relaxed Static Stability (RSS) concept. Because of the extreme level of inherent pitch instability, the X-29A is unflyable without a stability augmentation system (SAS). For the free-flight tests, a pitch SAS was developed using angle of attack and pitch-rate feedbacks to drive the all-movable canard. With this system, the model exhibited very good flying characteristics in pitch throughout the angle-of-attack range of the tests.”¹⁵

The Langley model tests predicted undesirable forebody interactions at high angles of attack that could produce unstable roll damping above 25 degrees AoA. Murri explained: “This unstable roll damping characteristic causes the configuration to exhibit large amplitude wing rock which would severely restrict its maneuvering effectiveness. To correct this deficiency, a high-gain roll damper was developed which provides a significant augmentation of roll damping at high angles of attack. . . .”¹⁶ Overall, the model tests were impressive. Without the roll damper, the free-flight wind tunnel model typically departed controlled flight at 28 degrees AoA. “With the full SAS active, the wing rock was effectively suppressed and the overall flying characteristics of the model were significantly improved. . . .”¹⁷ The augmented model exhibited very good characteristics up to 25 degrees AoA and mild nose wandering between 25 degrees and 35 degrees. “The model could not be flown above. . . .40 degrees due to lack of yaw control.”¹⁸ The groundbreaking work at Langley enabled engineers to begin work on computer control laws for high-AoA work. This work at NASA Langley, in addition to helping the X-29 program goals, also positioned Langley to be able to validate their testing equipment and procedures once the high-AoA program kicked in.¹⁹

Even as the X-29 team was devising its arguments in favor of conducting a high-AoA research program as a follow-on effort to the FSW aircraft, a perception existed that this X-29 effort might be in competition with another NASA high-AoA program designed around a modified F/A-18 Hornet. In the end, both were funded and both experienced schedule setbacks. The X-29 was able to pioneer high-AoA flight-test methodology, validating procedures and data corroboration before the even more ambitious NASA High Alpha Research Vehicle (HARV) F/A-18 began its own high-AoA program.²⁰

With the X-29 and HARV (and the X-31 after both), NASA was clearly building a high-AoA database with enough depth across multiple configurations and

The X-29 Follow-On Program

technical approaches to extend the extant aircraft design base and spark further research. Since the presence of strakes and other cross-sectional differences generated a fortuitous opportunity to undertake comparative analysis of the X-29 and more-traditional F/A-18 configurations, NASA analysts compared X-29 and HARV forebody flight phenomena. This analysis, completed in 1992, noted that:

High-angle-of-attack aerodynamic studies have been conducted on both the F/A-18 High Alpha Research Vehicle (HARV) and the X-29A aircraft. Data obtained include on- and off-surface flow visualization and static pressure measurements on the forebody. Comparisons of similar results are made between the two aircraft where possible. The forebody shapes of the two aircraft are different and the X-29A forebody flow is affected by the addition of nose strakes and a flight test noseboom. The forebody flow field of the F/A-18 HARV is fairly symmetric at zero sideslip and has distinct, well-defined vortices. The X-29A forebody vortices are more diffuse and are sometimes asymmetric at zero sideslip. These asymmetries correlate with observed zero-sideslip aircraft yawing moments.²¹

The HARV F/A-18 program placed greater emphasis on this kind of forebody airflow characterization right from the start, with engineers noting:

Although the F/A-18 HARV and X-29A aircraft have been used for high-angle-of-attack research, the projects were operated from different philosophies. From the beginning of the F/A-18 HARV project there were plans to use flow visualization and pressure measurements to help define the aerodynamics of the aircraft at high angles of attack. Therefore, instrumentation to accomplish these objectives was incorporated early in the program and given a high priority. Conversely, on the X-29A project, flow visualization and pressure measurements were performed as part of a follow-on program. This follow-on program was initiated because some of the X-29A high-angle-of-attack flight characteristics were quite different than predicted. It was anticipated that a better understanding of the forebody aerodynamics could help explain the differences, given the success of the F/A-18 HARV experiments.²²

The aircraft behaved differently as well, and researchers noted the following:

[Data for both the X-29 and the F/A-18 HARV] can be correlated with wind-tunnel and computational fluid dynamics (CFD)

Sweeping Forward

results. In the case of the X-29A aircraft, the forebody results correlate well with measured aircraft results and help explain differences from predictions. Some differences were observed in the forebody aerodynamics of the two aircraft. The F/A-18 HARV pressure distributions were symmetric at zero sideslip. This symmetry was also observed in the surface flow visualization. On the other hand, the X-29A pressure distributions were asymmetric at angles of attack...greater than 30 degrees; this correlated with flight-measured yaw asymmetries.²³

Having two test bed aircraft for high-AoA flow visualization research allowed NASA to opine on logical reasons for some differences in results obtained:

The F/A-18 HARV forebody vortices visualized were fairly well defined with distinct cores. At nonzero sideslips, the windward vortex core lifted away from the aircraft surface while the leeward vortex core was drawn into the leading-edge extension (LEX) vortex. The X-29A forebody vortices were more diffuse and nonzero sideslips tended to shift as a pair when viewed from the tail. The location of the X-29A forebody vortex cores at zero sideslip correlated well with flight-measured yawing moment asymmetries. The nose strakes and noseboom on the X-29A forebody may be partly responsible for the diffusion of the forebody vortex cores.²⁴

The anticipated high-AoA program would allow engineers to verify what advantages the X-29's unique airframe and control system offered as well as to check whether that same radical airframe harbored any traits contrary to good high-AoA performance. On the list of questions was whether the canards' vortices, which were expected to separate from close-coupled wing flow at high angles of attack, would inhibit rudder control by disturbing airflow over the vertical tail. On the positive side, engineers predicted that the X-29's fuselage strakes would provide enough surface area behind the aircraft's center of gravity to permit it to remain stable at high angles of attack. If true, this could be a remedy for a deep-stall problem encountered in the F-16. The high-AoA venture had three main phases. Phase One, relying on already-proven, low-AoA flight control software, would put the second X-29 through taxi and flight tests needed to execute a full functional check of the aircraft and its spin-chute system. This phase offered no envelope expansion. Phase Two was all about envelope expansion. Using a new software package, this phase was expected to span about 8 months and 70 flights. The rigorous methodology of Phase Two called for AoA envelope expansion in increments of 5 degrees of pitch.

The X-29 Follow-On Program



The X-29A-2, which featured a spin-recovery parachute to enhance flight safety during high-angle-of-attack flight research, during its first flight on May 13, 1989, piloted by NASA research pilot Steven Ishmael. (NASA)

The incremental pitch increases would take place first at an altitude block of 35,000 to 40,000 feet. The same test points would next be flown at 20,000 to 25,000 feet to characterize the effect of altitude on performance. In execution, the lower altitude test points were accomplished more rapidly than the high-altitude tests due to the experience gained at the high-altitude tests and the database generated by the high-altitude tests first. Ultimately, Phase Three of the program would explore and evaluate various military utility aspects of the X-29 design. These would include tracking tasks, air-to-air operational maneuvers, aerobatic maneuvers, ability tasks, and guest-pilot evaluations. Planners figured on 4 months bridged by about 30 flights to complete the military utility part of the program.²⁵

The X-29A-2 was essentially identical to the first aircraft at conception, but the second X-29 gained some special equipment and capabilities to gird it for its designated high-AoA explorations. Most noticeably, the X-29A-2 featured the truss-work and canister for an explosively deployable spin parachute mounted to the fuselage at the base of the rudder trailing edge. Spin chutes were in use on other high-performance aircraft under testing since experience showed the possibility for experimental aircraft that were tested to the very edge of their

Sweeping Forward

performance parameters to enter unrecoverable spins or stalls. With an airframe as radical as the X-29's, the prudence of installing a spin chute before exploring the high-AoA regime was clear. Typically, should a spin develop, the pilot would employ control inputs intended to stop the spin and get the aircraft back into controlled flight. Since each revolution of a spin was accompanied with loss of altitude, a set of test cards would include a floor altitude below which the pilot was to cease his efforts at stopping the spin and deploy the spin chute. The chute would add drag behind the aircraft that often quashed the spin, enabling the pilot to regain control.

But testers at Edwards were aware of events—especially a dramatically filmed General Dynamics F-111 spin in which the spin chute failed, necessitating that test pilot Charles “Pete” Winters and flight-test engineer Patrick “Pat” Sharp eject from the ailing F-111's self-contained cockpit capsule before the F-111 dove into the ground. There were no guarantees with a spin chute, but there were higher expectations of recovery than without one. The cost of this safety device for the second X-29 was put at \$10 million. To give the pilot additional visual cues in the event of a spin, the main instrument panel added spin recovery lights. These were four directional arrows used to show stick position and two arrows used to show rudder pedal direction. They were set to illuminate when yaw rates reached or exceeded plus or minus 20 degrees per second.²⁶

Another significant change made for AoA flights was the installation of a Litton LN-39 inertial navigation system (INS) in the second X-29. Its purpose was to glean reliable AoA, sideslip, and velocity data at high angles of attack and slow airspeeds. And, in anticipation of changes in cooling efficacy while the X-29 was at high angles of attack, the aircraft's environmental control system was altered to provide proper cooling by the ram air heat exchangers in these unusually nose-high attitudes. Also the emergency power unit/generator switch was changed to a maintained, lever-locked switch to allow operation of the emergency power unit (EPU) in the bleed-air mode during a high-AoA maneuver.²⁷

Other cockpit changes in the second X-29 included installation of an attitude direction indicator/horizontal situation indicator in place of the radar altimeter. A pressure altimeter was inserted where the aircraft clock had been, and the gun-sight camera was modernized to become a videotape recorder instead of a motion picture film camera. Quicker acquisition for the analysis of gun-camera imagery was facilitated by videotape over film that required processing first.²⁸

Modifications to the X-29A-2—specifically, the addition of the spin-chute equipment and the inertial navigation system—increased aircraft weight by nearly 600 pounds.²⁹

The X-29A-2 Explores the High-Alpha Arena

The X-29A-2, serial number 20049, reached Edwards Air Force Base in early November 1988, following a month of travel by ship from Grumman in New York through the Panama Canal and on to Port Hueneme on the California coast.³⁰ Outsized truck travel delivered the X-29A-2 to NASA Dryden Flight Research Facility, where it was positioned to allow the crane intended for Space Shuttle hoisting to remove the X-29 from its truck trailer. Parked in a hangar next to the first X-29, the number two aircraft arrived in good condition, permitting its acceptance by the Air Force on November 17. Then, as with the first X-29, the second aircraft was placed on loan to NASA with all the rights and responsibilities that entailed. Program technical experts wasted no time in preparing the X-29A-2 for its first flight, forecast to be in April 1989. Ground engine runs in March highlighted some problems, the ultimate solutions to which put the program about a month behind schedule before first flight.³¹

Weather delays caused by winter snowfall in the high desert probably added a week to this schedule slip.³²

To get ready for the X-29A-2's high-AoA envelope expansion program, an aerodynamic math model was developed for the Dryden fixed-base simulator. The mathematical model was based on ground tests, and it enabled the simulator to conduct an aerodynamic parameter variation study that was deemed essential to determining approximate high-AoA departure characteristics of the X-29 as well as identifying critical aerodynamic parameters and flight limits.³³ As will be seen, as the high-AoA tests progressed, the way in which the simulation was employed changed to meet the program's needs and abilities.

As April drew to a close, the X-29A-2 spent 8 12-hour days harnessed to the X-29 simulator to conduct flight control open- and closed-loop tests. X-29 testers were painfully aware that this time could have been shortened had NASA's unfinished integrated test facility already been operational. On May 19, the X-29A-2 was ready to fly. The following day, the aircraft performed taxi testing as high as 130 knots. Additionally, a ground-deployment test of the explosive-spin-chute system worked as planned. NASA project pilot Steve Ishmael made the number two aircraft's first flight on May 23, 1989. He gave the aircraft a conservative 52-minute workout that reached only 0.6 Mach and 29,100 feet in altitude mean sea level (MSL). The spin chute was test-deployed in flight on June 13, during the third sortie for the X-29A-2, and again on the fourth flight, on June 23. This occurred as part of the four-flight, low-AoA functional checks of the aircraft, slated for sorties two through five. Pilots Ishmael and Air Force Maj. Alan Hoover occasionally had different descriptions of how the X-29A-2 handled, yet both agreed that the spin-chute system appeared both viable and reliable. Grumman and

Sweeping Forward



The X-29 simulator at Dryden. (NASA)

NASA engineers agreed, and the chute system was fully qualified for use in the X-29A-2 program. Flight number five was a quick-turn second sortie on June 23 that evaluated engine handling at slow speeds and garnered airspeed calibration data as well as flight control clearance data. Phase One was now complete. All major aircraft systems were acceptable, but the Phase One flights uncovered some instrumentation issues requiring remedy before high-AoA testing could commence.³⁴

More than 3 months elapsed before the first two flights of Phase Two, conducted on October 11, 1989, by Grumman's Rod Womer and NASA's Steve Ishmael. Bob Clarke from Dryden, along with Air Force X-29 engineer Fred Webster, designed the control laws for high angles of attack in the second X-29. Webster recalled a young engineer's concerns: "The night before the first flight entry into the AoA regime where these new control laws became active was totally sleepless for me. This was the first control law design I had ever done, and here it was flying on perhaps one of the most visible experimental aircraft in the world. The next day... we got into the mission, and proceeded though the buildups until we finally got to the point of going above 20 degrees AoA and doing some maneuvering."³⁵ Webster remembers saying a little prayer on behalf of the new high-AoA control laws. In the end, the control laws performed well, "but it still amazes me that what we designed worked and worked pretty darn good. I often wonder if presented with the same challenge to do such a design today (being much older and more cynical), if I could pull it off. There is a lot to be said for being too young and dumb to not know you can't do something, therefore you just go ahead and do it. [This is] another lesson I try to keep in mind when dealing with our young engineers."³⁶

Webster's Dryden counterpart, Robert Clarke, recalled a phenomenon that he and his team dealt with handily:

X-29 pitch instability at high angle of attack became only a minor issue. The linear analysis and nonlinear simulation showed that a weak angle of attack feedback added to the system prevented the most objectionable characteristic. The problem we found was that with such a high gain controller (relying on inertial measurements—pitch rate and integral pitch rate mostly) the airplane would exhibit stability relative to its attitude, but not the normal

The X-29 Follow-On Program



The X-29A-2 during high-angle-of-attack flight. (NASA)

airplane characteristic of weathercock [in pitch] stability. This was most evident when flying the nonlinear sim with heads up looking at the out-the-window graphic scene. If you flew to 30 or 35 alpha and then looked up to see how the wing rock was behaving you might quickly find that you were at 50 degrees angle of attack (even with no increase in aft stick), but the attitude of airplane relative to horizon was not changing. Very weak angle of attack feedback (using three noseboom mounted sensors) was added to provide the airplane its 'natural' inclination to pitch into the airstream.³⁷

The high-AoA tests were driven differently than some traditional flight-test programs. Typically, modeling and simulation predict a result, and actual flight test verifies or disproves it. With the X-29A-2, pilots would accomplish a high-AoA data point and then describe the aircraft's handling to engineers on the ground. The data and the pilot's inputs would be modeled after the fact, allowing engineers to clear the aircraft for the next AoA. This process of modeling actual results after the fact allowed safe expansion of the X-29A-2 high-AoA envelope. The high-AoA program was completed by the 85th flight, logging a total of 70.9 hours by February 21, 1991.³⁸

Sweeping Forward

In April 1990, NASA X-29 program team members expressed their delight with high-AoA performance that was better than they had anticipated. Control in the 25- to 45-degree range was a happy surprise, according to NASA pilot Steve Ishmael. “We have much more control than we thought we would have at these angles,”³⁹ he said. “We have good roll control and we have modest yaw control. We didn’t expect this.”⁴⁰ The results cried out for more testing to determine their origin. “This maneuvering capability is really a bonus for us, but we don’t fully understand what is causing it,”⁴¹ said Gary Trippensee, Dryden’s X-29 project manager in 1990.

The successful completion of the high-AoA program left the X-29 team with some intriguing questions. The aircraft’s remarkably good high-AoA handling, they theorized, was due at least in part to the interaction between vortices coming from the forebody of the X-29 and the canards. Flow visualization is a fundamental tool in wind tunnels as well as in actual flight test. It can range from fluids painted on a model’s surface to yarn tufts that map localized airflow to smoke that wafts over an aircraft. Flow visualization devices (including smoke generators and onboard cameras) were installed to characterize forebody airflow. For the X-29A-2, the smoke released over the forebody would be filmed from the aircraft’s right wingtip and from the vertical fin, as well as from chase aircraft. The X-29 could produce smoke for 50 seconds while performing maneuvers at high AoAs. Dryden’s John Del Frate, principal investigator for the X-29A-2 smoke imaging system, explained that “the smoke entrains itself in the vortices, so we can see the path of the forebody vortices, and identify how far they extend, as well as see how strong and tightly coiled they are.”⁴² The results were tantalizing, and they informed a decision to conduct yet another high-AoA-based test with the X-29A-2 that involved vortex flow control.

Both NASA and Air Force officials believed that the X-29 program could benefit from public exposure generated by displaying the aircraft at two major aviation events away from the Edwards AFB area. The annual Experimental Aircraft Association (EAA) air show and display at Oshkosh, WI, draws hundreds of thousands of visitors each summer, including industry leaders and policy makers. About a week before Oshkosh, in July 1990, the U.S. National Airshow in Dayton, OH, was similarly positioned to have high visibility. In March 1990, NASA Headquarters expressed interest in displaying an X-29 at Oshkosh. Air Force support was conditioned on the additional display of the X-29 at the Dayton air show. X-29 program officials were understandably reluctant to commit the modified number two aircraft to air show duty, as its loss would cancel the program outright. Overland shipment was deemed less practical than getting the first X-29 refurbished for flight to discharge its air show obligations. Dormant since December 1988, the first

The X-29 Follow-On Program



The performance parameters of the forward swept wing X-29 were thoroughly mapped, enabling flights to expand quickly on the body of knowledge gained by earlier sorties. (NASA)

X-29 had become the “can bird,” giving up components to keep the number two aircraft flying. Now, its role was reversed: in May 1990, the X-29A-2 was taken off flying status so that it could be cannibalized to make the first aircraft airworthy once more.

On June 15, 1990, NASA's Steve Ishmael flew the X-29A-1 on the first of four preliminary air show check flights before the aircraft would fly across the United States to Ohio and Wisconsin. The fair-weather X-29 test bed was not equipped for adverse weather conditions, and it was bereft of aerial refueling capability. Both northern and southern routes were planned, giving the pilot and X-29 team options for fuel stops on whichever route was forecast to have the best weather in July. Accompanied by a T-38, the X-29 lifted off from Edwards AFB on July 18, flying the preferred southern route to Kirtland AFB, NM. Here, the X-plane refueled and swapped pilot Steve Ishmael for NASA's Rogers Smith, who took the jet to the Oklahoma Air National Guard facility at Oklahoma City for its second en route stop of the day. The final leg, to Dayton, was flown by Air Force Maj. Dana Purifoy, which had the added benefit of having the X-29 arrive at its Air Force event in the hands of an Air Force pilot. The X-29 was supported by maintenance crews, traveling in two Gates Learjets, who arrived at the en route stops in advance, poised to quick-turn the

Sweeping Forward



NASA research pilot Steven Ishmael with the first X-29 (X-29A-1) at Dryden before leaving for the Dayton and Oshkosh air shows, June 1990. (NASA)

aircraft and allow its cross-country journey to finish in 1 day. Grumman pilot Rod Womer ferried the X-29 to Oshkosh on July 23 for the show, which ran from July 27 to August 2. NASA's Smith and Ishmael brought the X-29 home to Edwards on August 5, stopping at McConnell AFB, KS, and Kirtland Air Force Base, NM, en route.⁴³

Following its air show duty, the X-29A-1 gave up its borrowed parts so that the X-29A-2 could resume its high-AoA explorations. First flight of the "reconstituted" X-29A-2 took place on September 6, 1990. That flight's list of accomplishments included some military utility evaluations, which occasionally overlapped other high-AoA tasks.

The high-AoA flight envelope expanded to 66 degrees during 1990. Gary Trippensee, part of Dryden's X-29 team, explained how the AoA effort switched from modeling leading the testing to the aircraft leading the modeling:

Initially, emphasis was placed on aerodynamic parameter identification for the flight envelope expansion process and simulation studies preceding each research flight. However, the approach of using only parameter identification to update the simulation's aerodynamic database had to be altered significantly because of concerns when aircraft performance differed significantly from expectations. The technique was changed to allow the aircraft

The X-29 Follow-On Program

to lead the simulation results. Better aircraft controllability was encountered when compared to the initial simulation studies up to 45 degrees angle of attack with a slow-speed flight envelope virtually free of wing rock. The X-29 aircraft proved to have slow-speed high AoA flying qualities equal to or better than some of the current day United States high performance aircraft.⁴⁴

Trippensee described the program objectives for the X-29A-2 in eloquently simple terms: “The main objective was to evaluate the slow speed, high AoA characteristics of the unique X-29 configuration in fully maneuvering flight up to 40 degrees angle of attack and during symmetric pull-ups or pitch pointing to 70 degrees angle of attack. In addition, the Air Force planned an evaluation of the aircraft under simulated representative tactical maneuvers, in other words, to perform a military utility evaluation.”⁴⁵ He explained that the workup to higher AoA envelope expansion was a precursor to realistic military utility maneuvering. “The goal was to validate and qualify the control laws so that ultimately an aggressive military utility evaluation could be performed. All flight data were used to update the simulation so that the simulator would provide a close match to the aircraft results.”⁴⁶ The high-AoA tests with the X-29A-2 retained the first aircraft’s capability “to drive the flight control surface through the outer loops of the control system and the ability to drive the attitude directional indicator (ADI) pointers with angle of attack, sideslip, and yaw rate,”⁴⁷ Trippensee explained. “This command driving capability was performed from the ground by way of the Dryden remotely augmented vehicle (RAV) facility as an innovative yet routine flight testing technique.”⁴⁸

Trippensee offered a qualitative assessment of the high-AoA capabilities of the X-29A-2 in 1991: “The X-29 demonstrated well coordinated and intuitive pitch control through 43 degrees angle of attack. As long as sideslip remained less than seven degrees, the airplane would reverse the direction of pitch, roll, or yaw with command.”⁴⁹ Powerful pitch control was available right up to 68-degrees-nose-high AoA—this was the limit tested. The old demon of inertial coupling showed up at high AoA for the X-29, however. Trippensee explained: “[F]ull-canard, nose-down pitching moment was exceeded by nose-up inertial coupling during the recovery from pitching up to 68 degrees angle of attack. Although the event was significant from an analytical point of view, the airplane always appeared to respond to pitch stick inputs.”⁵⁰ Inertial coupling involves the mass of an aircraft overpowering normal actions of flying surfaces. It manifested itself in the skies over Edwards as early as the 1950s during tests of early high-speed X-planes. Another X-29 high-AoA summary further probed the inertial coupling phenomenon: “This was due to the more unstable than predicted pitching moment combining

Sweeping Forward

with inertial coupling produced by uncommanded yaw rates. These yaw rates were triggered by asymmetric forebody vortices above 50 degrees AoA.... For this reason, and general concerns over inertial coupling, strict limits were placed on aircraft cg position, yaw rate, and canard position during flights above 45 degrees AoA.”⁵¹ X-29 forebody vortices would become the focus of a later, final X-29 flight-test program that validated ways to produce vortex flow control at high angles of attack.

Aileron control power in actual high-AoA flight was less linear than predictions had indicated. Small aileron deflections gave less control power than predicted while larger control surface deflections gave higher control power than had been forecast. A suggestion was made to incorporate a “more discreet number of control surface positions” in wind tunnel testing for better modeling accuracy. Actual roll damping proved less stable than predicted between 20 and 35 degrees AoA and more stable than predicted above 35 degrees. As reported: “A strong dependence on sideslip was evident, with the stabilizing influence of sideslip larger than predicted.”⁵² Directional stability in the region of zero sideslip matched predictions; at higher angles of attack, directional stability went unstable at higher angles of sideslip than predicted. Rudder control power was larger than predicted up through 35 degrees AoA, and it was nonlinear. Since the flight control system did not permit full rudder deflections, it was difficult for testers to define full deflection control power. Above 45 degrees AoA, rudder control power was negligible. And the maximum angle of sideslip attainable during wings-level sideslips was higher than modeled because of the higher-than-predicted rudder power. “Full rudder inputs between 30-35 degrees AoA required caution as a mild directional instability was encountered in that regime,” one report noted. “This was controllable with opposite rudder.”⁵³ These and other apparent discrepancies between modeling and actual flight testing would help testers refine their predictive skills as they contemplated the reasons for the discrepancies.

Test results showed “lateral/directional maneuvers above 45 degrees AoA were not possible due to the lack of rudder power.” Generally, pilots gave the X-29 good marks for flying qualities in the high-AoA arena. A summary noted: “The aircraft was considered natural to fly in that regime, and very forgiving. Flying qualities above 43 degrees AoA were seen to degrade, but in a graceful manner, with no departures. Stability and control in the pitch and roll axes were generally considered excellent. Pilot ratings of Level 2 (down from the highest Level 1) were given for maneuvers in these axes, primarily due to lower than desired rates and accelerations in pitch, and lower roll rates than desired. The pilots felt the X-29 flew better in the 25-45 degree AoA range than any current front-line fighter.”⁵⁴

The X-29 Follow-On Program

Testers found that the X-29 exhibited noticeable buffeting between 13 and 22 degrees AoA. The buffet was called “moderate” in intensity, and it became overshadowed by random wing drops up to about 25 or 26 degrees AoA. “Precise, well damped lateral directional control”⁵⁵ was found between 25 and 40 degrees AoA. At sideslip angles less than 1 or 2 degrees, the X-29 showed mild wing rock tendencies at about 40 degrees AoA. “However,” Trippensee reported, “modest maneuvering or intentional sideslips in excess of few degrees eliminated the wing rock.” Testers also observed that in the vicinity of 35 degrees AoA, “sideslip would continue to increase without additional rudder input once sideslip exceeded approximately seven or eight degrees.” Other quirks appeared:

When at 45 degrees angle of attack, the X-29 always yawed to the right. If full rudder was input prior to any yaw, lateral handling could be maintained and the X-29 could be controlled with conventional lateral stick inputs. The airplane yawed to the left at 50 degrees angle of attack and no pilot technique was sufficient to keep a constant heading. Although marginal control could be achieved by pitching the airplane between 40 and 45 degrees angle of attack, useful control extended only up to 45 degrees angle of attack.... The X-29 handling qualities can be summarized as showing good controllability in the 25-to-40 degree angle of attack region. Above 50 degrees angle of attack, yawing prevented useful control. Finally, wing rock was effectively damped throughout the region tested.⁵⁶

A succinct summation of the X-29A-2 high-AoA lessons learned was produced by Trippensee in 1991:

The controllability of the X-29 at high AoA was determined to be very good. The aircraft exhibited at least three characteristics which should be present in any airplane maneuvering at high angles of attack. First, controllability was and is always desirable up to a maximum lift coefficient. Second, graceful degradation of control was exhibited and is preferable to abrupt loss of control. Finally, minimum system complexity is superior to more intricate mechanizations. The X-29 flight control system software was not characterized as a complex system.⁵⁷

The X-29 showed itself capable of delivering controllable maneuvering up to its maximum coefficient of lift. Trippensee’s report explained:

Sweeping Forward

If angles of attack are not significantly above the value of the maximum coefficient of lift, sink rates are small enough to permit extended maneuvering. Turn radii and rates are impressively small in the 30-to-40-degree range. The ability of the airplane to achieve target capture and to track with precise control is as important as the traditional departure avoidance in the high AoA region. Good controllability permits the pilot to take advantage of the minimal turn radii that are achievable in a high AoA flight.⁵⁸

The X-29's gradual degradation of controllability at increasing AoAs was praised:

Airplanes which progressively lose precision of control and eventually end up with the aircraft failing to respond to reasonable inputs allow pilots to fly their airplane to its limits, learn its characteristics, and effectively maneuver it at high AoA. Below 45 degrees angle of attack, the X-29 aircraft did not exhibit any departure tendencies.⁵⁹

The X-29, even though it relied on three pitch surfaces, including canards, was described as having simple mechanical systems—a desirable feature:

The X-29 flies in the 25-to-40-degree angle of attack range with good control without leading edge flaps or thrust vectoring. No additional systems were added to the X-29 for its high AoA maneuvering over that required for its overall performance. Such simplicity avoids the potential failures of more complex systems.⁶⁰

When X-29A-2 high-AoA envelope expansion concluded, the aircraft was cleared to perform high-AoA maneuvers up to a speed of 0.75 Mach, between altitudes of 27,000 and 40,000 feet, and to 300 knots calibrated air speed (KCAS) from 17,000 to 27,000 feet. The AoA envelope for the aircraft was cleared to 50 degrees in all center of gravity positions and up to 55-degrees AoA for a limited set of c.g. conditions. Interestingly, the X-29 was cleared for full lateral stick or full rudder pedal inputs, but combined inputs were not cleared. Even though lateral-directional control faded above 45 degrees, it was reported that the X-29 AoA tests revealed “no undesirable flying qualities...below 50 degrees AoA. Good pitch and AoA control below 50 degrees AoA was demonstrated, along with good lateral/directional control below 45 degrees AoA.”⁶¹

The engineering community's voracious appetite for a correlation of accuracy between modeling/simulation and the actual flight-test data was sated again

with the X-29 when a model X-29 was mounted in the National Transonic Facility (NTF), a remarkably accurate high-speed wind tunnel asset at NASA's Langley Research Center in Virginia. Tunnel pressure can be adjusted to yield desired Reynolds number data for a test. Reynolds number refers to fluid flow over a body. Tunnel data matched X-29 high-AoA flight data up to an alpha of 50 degrees. Above that angle, tunnel data and flight data were not as similar. This was attributed to a difference in the roughness of the surface of the model and the actual aircraft, plus some aircraft-unique equipment on the forebody and noseboom that were not modeled on the 1/16-scale wind tunnel version of the X-29. Researchers also posited that interaction from the wind tunnel walls, something that would not happen in actual flight in free air, may have skewed extreme AoA model data.⁶² (This is a known limitation of wind tunnels. Tests have been conducted for years to characterize wind tunnel wall interference and to design wind tunnel test sections with wall geometry that will least impinge upon test data for a specific type of test.)

High AoA Applied: The X-29 and Dissimilar Air Combat Maneuvering

By October 1991, the X-29 team had successfully executed the aircraft's Aerodynamic Characterization and Military Utility test program. Thirty-five flights amassing 28 flying hours yielded the data. Air Force X-29 pilot Maj. Regis Hancock summed up the results. He acknowledged the ability to tightly maneuver the X-29 at slow speeds and high angles of attack, albeit at higher risks than would be encountered in high-speed flight.⁶³ The quest for maneuverability—perhaps a lingering artifact of the air war over North Vietnam and more recent air combat experiences over the Falklands, Lebanon's Bekaa Valley, and Operation Desert Storm—was freighted with peril. The X-29 military utility evaluators said that the first choice should be to avoid slow-speed flight regimes. But if the pilot of a future fighter with X-29 capabilities inadvertently found himself in a slow-speed fight, the aircraft's remarkable maneuverability could prove more valuable than the flight characteristics of more traditional jet fighters.

The value of the X-29's high-AoA maneuverability in simulated dogfights with a NASA F/A-18 was lost at distances greater than 2,000 feet of separation between the combatants. At these longer ranges, the F/A-18 pilot was able to use his aircraft's greater pitch capability to negate the advantage of the X-29's greater roll authority. One pilot put it this way: "Outstanding high AoA maneuverability is not an advantage if you cannot force an adversary to fight 'in the phone booth.'"⁶⁴ (Such was demonstrated again when NASA's thrust-vectoring

Sweeping Forward

X-31 was flown against Air Force aggressor pilots flying conventional F-15s and F-16s. The aggressors denied it the opportunity to exploit its supermaneuverability, and the aggressors maintained a commanding distance and range advantage over the X-31. Historically, this was why German pilot Werner Voss perished in 1917 in his highly agile Fokker Dr I triplane when fighting British adversaries in less-maneuverable but faster and more-energetic Royal Aircraft Factory S.E. 5s that denied him the ability to control, and eventually to exit from, the fight.) It was a problem demanding a solution ever since the First World War, when combatants first raised aircraft with dissimilar performance against each other. The Army Air Forces and Navy flight-test establishments made good use of the protracted duration of World War II by flight testing captured German and Japanese fighters against American aircraft, devising ways to engage the enemy that favored the traits of the U.S. warplanes against more-agile opponents. With the X-29 and high-AoA explorations, the merge of tactical doctrine, capabilities, and rules of engagement renewed itself. Ever-improving air-to-air-missile reliability and efficacy tended to favor the “speed is life” school of thought over the maneuver school—as long as an adversary could be kept at least 2,000 feet or more away.

After a series of tracking tests in which the X-29A-2 and a NASA F/A-18 swapped roles as attacker and target, a limited number of basic fighter maneuver (BFM) events were flown once the X-29’s high-AoA airspeed envelope stretched to 300 KCAS. The engagement began with neutral advantage to either aircraft as the X-29 and the F/A-18 approached each other on opposite headings with a lateral separation of 1,000 feet at about 250 KCAS. As the jousting aircraft passed, both pilots began a circling fight using a 25-to-40-degree-AoA turn. As reported in an Air Force presentation: “Both aircraft attempted to maneuver to slow speed firing advantage in the other’s rear quarter. While the X-29 was able to perform loaded rolls at a higher rate than the F/A-18, the rates produced were not high enough to obtain a clear advantage.”⁶⁵ Based on pilot comments during the envelope expansion as well as the limited military utility results, “the rolling capability of the X-29 at high AoA was not yet sufficient to be tactically useful.”⁶⁶ Using the X-29 flight control system’s variable gain feature, “significant increases in maximum stability axis roll rate were obtained, up to 100 percent at higher airspeeds. At the higher AoAs however, the rudder was not able to provide sufficient yaw rate to coordinate with the higher body axis roll rates being produced and significant adverse yaw was produced.”⁶⁷ In three neutral BFM engagements between the X-29 using high-gain roll control and a NASA F/A-18, the X-29 pilot “was able to gain an advantage over the F/A-18 through its ability to perform loaded rolls at a relatively high rate.”⁶⁸

More high-gain BFM tests used a rolling-scissors-type of fighter attack engagement because this was a high-AoA and low-air-speed scenario that

The X-29 Follow-On Program

“would most clearly show the advantages associated with loaded roll capability.”⁶⁹ Project pilots and guest pilots flew the X-29A-2 against the Dryden F/A-18. Generally, the superior high-AoA rolling performance of the X-29 gave it an advantage over the F/A-18 when the engagement was at 2,000 feet of lateral separation or less. An Air Force paper on the military utility evaluation of the X-29 captured its essence:

The results of the military utility investigation showed that the X-29’s capabilities, particularly in the roll axis, with the increased gains, gave it an advantage in high AoA maneuvering. Deficiencies in the pitch axis were noted however. The possibility of improving the X-29 pitch response through FCS and hardware modifications existed, but was not accomplished for budget reasons. Data were gathered on proposed high AoA evaluation maneuvers which should prove valuable to future high AoA programs. Some advantages and disadvantages associated with high AoA maneuvering in a tactical air combat situation were found. While the capability to maneuver at high AoA can be an important tool for a fighter pilot, its effective use may be limited by parameters such as slant range to the target. Finally, the need for advanced displays with off-boresight capability for use in high AoA maneuvering was shown.⁷⁰

Forebody Vortex Flow Control Research

Even as the military utility program was nearing completion, NASA and the Air Force’s Wright Aeronautical Laboratories agreed to jointly conduct vortex flow control (VFC) testing with the X-29 in fiscal year 1992. VFC was seen as a natural follow-on to the previously completed X-29 high-AoA envelope expansion. In those high-AoA flights, the X-29’s useful AoA envelope was expanded to more than 50 degrees with a maximum of 67 degrees achieved. In these conditions, flying qualities were considered excellent up to 40 degrees, but from 44 to 47 degrees the X-29 showed itself to have a nose-right directional asymmetry. This required the pilot to apply left rudder and left lateral stick force to maintain a zero yaw rate. Then, at 50-degrees AoA and higher, the asymmetry switched to nose left, increasing in intensity. The X-29’s rudder authority was effectively nil at 50-degrees AoA, depriving the pilot of the ability to maintain zero yaw rate at that AoA or higher.⁷¹

Wright Aeronautical Laboratories evaluated X-29 flight data that suggested that the high-AoA yaw asymmetry was caused by forebody vortex interactions with the forward fuselage and canopy area of the X-29. The Wright Laboratory

Sweeping Forward

suggested pneumatic vortex control might tame the problem. Grumman and Wright Aeronautical Laboratories performed three wind tunnel tests using a 1/8-scale model of the X-29 fitted with a pneumatic system and nozzles on the nose of the aircraft. Previous mapping of the X-29's vortices showed strong vortex influence on the aircraft's aerodynamics above 35 degrees. This made the X-29A-2 an excellent test bed for VFC, particularly because it had a spin-chute package.⁷²

NASA took the lead as Responsible Test Organization; the Air Force Flight Test Center would be Participating Test Organization. NASA originally proposed conducting the VFC work later, in fiscal year 1993, due to a combination of funding constraints and project backlog. The Advanced Development Projects Office (ADPO) weighed in, expressing the desire to have the AFFTC assume the vital RTO role in an effort to accelerate its execution in fiscal year 1992. ADPO considered the VFC exploration crucial for follow-on program reasons. In October 1991, three meetings reviewed Memorandums of Agreement (MOAs) written by NASA and the Wright Aeronautical Laboratories with input from the AFFTC. The budget division between NASA and Wright Aeronautical Laboratories was discussed, as was the level of support to be furnished by the AFFTC. This support was expected to be one program manager who was also an engineer and one pilot. Ultimately, the MOA for the X-29 VFC project was signed by the participants, including AFFTC, in April 1992, before first flight.⁷³

Before VFC could be explored, the X-29 team needed to map the forebody vortices in action. Flow cones, tufts, and smoke were used for flow visualization. Pressure measurements were taken as well, all in an effort to study the vortices' flow off the forebody as well as surface flow on the wing and vertical tail. NASA underwrote the cost of this work, which took place between July 24 and September 30, 1991, during flights 86 through 120. Space in the X-29, like most small high-performance aircraft, was at a premium. For smoke-flow visualization, the X-29's LN-39 INS system was removed from the forward-right avionics bay and replaced with a four-cartridge smoke-generating system. Ducting carried the smoke to a pair of exit ports just aft of the nose boom. The pilot used a switch on the control stick to ignite the smoke. To enhance contrast with the gray smoke, the right forebody was painted flat black for this flow visualization work. A probe was mounted on the left wingtip to gather accurate dynamic pressure and altitude data at high AoA for later data reduction. Four rings of static pressure orifices were placed around the fuselage forebody circumference with the forward-most ring placed at the strake station and the others farther back with the last one ringing the fuselage just forward of the canopy. These rings employed 202 pressure taps connected to temperature-controlled electronic scanning

The X-29 Follow-On Program

modules. The rigging of the X-29 for meaningful data gathering could be an exhaustive and meticulous process, but the program team knew this was necessary to ensure usable data.⁷⁴

Flow cones and tufts were placed on the aft portion of the right side of the fuselage, the right wing, and the right side of the vertical fin for some flow visualization flights. If flow cones were the preferred means of visualization, tufts were hardier in areas of high turbulence, like in the wake of the canards at high AoA. The X-29A-2 sprouted a bulbous camera fairing at the base of the vertical fin leading edge, using a then-state-of-the-art miniature, 8-millimeter video camera as well as a 35-millimeter film camera for still photography. On the ground before a flight, these cameras could be trained either on the right wing or with a view over the canopy. Similarly, the right wingtip received both a still and video camera that could be ground-positioned to view either the forebody or aft fuselage and vertical fin.⁷⁵

The smoke was deployed during 1-g flight conditions at AoAs from 25 to 50 degrees and at altitudes between 17,000 and 30,000 feet. As described in an Air Force paper,

Use of the smoke enabled visualization of the vortex system and correlation of its orientation with flight yawing moment data. Generally good agreement between uncommanded yawing moments observed at zero sideslip and the angular position of the vortex system with relation to the forebody was obtained. This confirmed the hypothesis that the zero sideslip yawing moments at high AoA were related to vortex system asymmetries.⁷⁶

The forebody vortices as visualized were more diffused at lower AoAs: "As AoA increased, the vortices became better defined and their distance from the top of the forebody increased."⁷⁷ Tufts and cones on the right wing allowed visualization of wing airflow separation at various AoAs. No flow separation was observed at 10-degrees AoA. "At 15 degrees AoA over 50 percent of the flow over the wing was separated. Between 15 and 25 degrees AoA the percentage of separated flow increased, but at a slower rate. By 30 degrees AoA the flow over the wing was completely separated. This correlated well with lift coefficient data gathered from wind tunnel tests. Separation on the wing was shown to initiate at the wing root, and, as AoA increased, spread outboard."⁷⁸ The tufts and cones on the vertical fin showed little or no flow separation on the upper vertical fin at 20-degrees AoA. At 30 degrees, the flow looked to be completely separated. The Air Force noted: "This correlated well with the vertical tail component of yawing moment due to sideslip obtained from wind tunnel data, and the component of yawing moment due to rudder deflection

Sweeping Forward



The X-29A-2 over the rugged Mojave Desert. (NASA)

data obtained from flight test.⁷⁹ Separated flow began at the base of the vertical fin and spread upward.

Forebody pressure data was gleaned at AoAs ranging from 15 to 66 degrees and from 20,000 to 40,000 feet at Mach numbers from 0.22 to 0.60 while flying 1-g flight the Air Force described as “quasi-steady.” Researchers observed that at AoAs beginning with 20 degrees, the vortices shed from the nose strake caused suction peaks in the measured pressure distributions that tended to increase in magnitude with higher AoAs. Above 30-degrees AoA, pressure distributions became asymmetric at the forward stations; aft stations remained symmetric until about 50-degrees AoA.

Vortex flow control as installed on the X-29A-2 employed two exhaust nozzles side by side atop the nose of the aircraft to send blasts of gaseous nitrogen over the forward fuselage while the aircraft flew at high angles of attack. Testers believed diminished rudder authority could be augmented by this method. The blast of nitrogen, previously modeled in wind tunnel tests, was predicted to accelerate and modify the vortex, creating low pressure on whichever side of the nose the nozzle was in use. This lowered pressure was calculated to draw the nose of the X-29 in that direction.⁸⁰ This radical means of yawing the aircraft was yet another validation of the experimental nature of the X-29 and further amplified its value as a true X-plane. Wind tunnel tests

The X-29 Follow-On Program

indicated that the best design for the nozzles incorporated slots in either side of the nozzle, releasing the gas in a sheet over the forebody. The VFC nozzles were activated by the pilot and were not designed into the X-29A-2's flight control system. This meant that the flight control computers would try to counter the effects of VFC once the computer sensed its action as being an "uncommanded" yaw excursion.⁸¹

Aircraft design is a counterbalancing act between the desire to diminish weight and drag and the need to maintain stability. The X-29 vortex flow control experiment raised the theoretical possibility that vertical tail size could be made smaller as a result of VFC. A Dryden news story explained: "Other potential experiments being considered...include vectoring engine nozzles, reduced vertical tail size and new wing design."⁸² Though these ideas went unfulfilled on the X-29, the later thrust-vectoring X-31 used its sophisticated flight control software to simulate flight with no vertical tail.⁸³

NASA's choices for VFC pilots were Steve Ishmael and Gordon Fullerton. The AFFTC X-29 VFC pilot was Maj. Regis Hancock. Before modification of the aircraft was complete, these pilots participated in simulation tasks to help determine the best placement for VFC cockpit controls. In December 1991, a team from Grumman visited Dryden to conduct a design review of the VFC system proposal concurrent with plans to refurbish the vertical tail of the aircraft. NASA convened a Configuration Control Board (CCB), which approved Grumman's plans for completing these tasks. VFC system installation was to be finished by February or March 1992 to facilitate a first flight in April. In an austere budget climate, the VFC program prioritized costs, enabling lower initial expenditure with a menu of additional test services that could be procured if needed.⁸⁴

The X-29 VFC modifications placed two nozzles atop the nose 20 inches aft of the nose cap and 4½ inches to either side of the centerline. The ideal system would have used an inexhaustible supply of air, probably tapped from engine bleed air. However, for X-29 test purposes where time and money were precious, a simple onboard nitrogen tank system was created. The diminutive X-29's fuselage volume dictated the size of the two VFC onboard tanks, yielding a total volume of 794 cubic inches of nitrogen at 6,000 psi. The VFC system was not integrated with other aircraft systems. Pilots Gordon Fullerton and Regis Hancock wrote afterward:

Cockpit controls consisted of an arm/disarm switch, a nozzle select switch, the stick grip trigger and the stick grip pickle button. Selecting the arm position momentarily opened the first stage regulator and allowed 1500 psi nitrogen to flow to the face of the nozzle regulators. A three position switch (left, both, or

Sweeping Forward

right) located on the left side wall just outboard of the throttle enabled the pilot to select or change which nozzle would exhaust nitrogen. When the trigger switch was squeezed, the preselected nozzle regulators opened to exhaust 400 psi nitrogen. Flow would continue as long as the trigger was squeezed.⁸⁵

By the end of January 1992, the final check of X-29 flight simulator changes for VFC was made. Most of February was consumed with the vertical tail refurbishing by Grumman specialists. Wright Lab tests validated the use of cold-working the tail fastener holes, and work progressed. This method was said to provide longer tail-fatigue life, if at the expense of a measure of catastrophic tail-failure strength. Unexpected tooling problems slowed the tail rejuvenation, but by the end of February all critical tail areas were inspected without discovering any damage, including cracks. The result of the inspection was a zero-time tail structure, meaning its life expectancy equaled that when it was new. While the inspection of the tail was worthwhile to validate the safety of the structure, VFC testers believed that their flight program would be benign, contributing little to the potential degradation of the tail's service life. On February 26, NASA convened a flight readiness review board, which was satisfied with the X-29's readiness for the VFC program. This step preceded a NASA safety review of the X-29 VFC program.⁸⁶

Test programs sometimes face a divergence between reality and the optimistic, can-do expectations of planners who set schedules for completion of milestones only to have these completion dates overcome by events that make them impossible to execute. In tester jargon, delayed dates are said to have "slipped to the right," a reference to programmatic timeline calendars that are read from left to right. By the end of March 1992, VFC equipment installation suffered from the lack of some vital flightworthy parts, including high- and low-pressure regulators and relief valves for the gaseous nitrogen system. Non-flight-rated alternatives were installed for initial fit work, but full checkout of the system could only be accomplished after airworthy components arrived and were substituted in the aircraft. Planners initially slipped the first VFC flight to the right, anticipating a date of April 20, 1992. Concurrent with the plumbing delays, the X-29 team experienced another setback on March 10 when the Navy grounded all GE F404-215 jet engines until further notice because of a failure in one of the engines on an F/A-18. The Dash-215 engine powered the X-29. Once the failure was traced to a fatigue problem in the engine's fan assembly, NASA was unwilling to passively await further resolution. NASA provided the engine manufacturer with a higher-series fan assembly that was still compatible with the Dash-215 engine. General Electric

The X-29 Follow-On Program

performed the parts swap locally, delivering the engine for installation in the X-29 by March 31.⁸⁷

Meanwhile, on March 26, NASA's Airworthiness and Flight Safety Review Panel (AFSRP) endorsed some minor changes in project planning. NASA and AFFTC safety officials were satisfied that the X-29 VFC program was ready to proceed to flight test (pending installation of necessary items including the newly shopped engine and flightworthy valves for the nitrogen system). Systems checks conducted on the ground in April uncovered problems with the fill valve and the high-pressure regulator. While these issues were being fixed, testers wasted no time in ground-testing the system at low pressure, which validated the serviceability of the low-pressure regulators. Working with the valve vendor, testers determined what caused the high-pressure valve problems. Repair and testing of the valves was forecast to have them returned to Dryden the week of May 11. During April, project pilots Gordon Fullerton and Major Hancock flew the X-29 simulator on several first-flight mission profiles. They also practiced emergency procedures.⁸⁸

The VFC-configured X-29A-2 returned to flight in May 1992, logging seven sorties that month. The sequence of flights included one functional check flight (FCF), two pilot familiarization missions, and four VFC test flights. The VFC envelope was expanded to include a 35-degree AoA and plus or minus 5 degrees of sideslip. In an effort to make up for lost time, NASA funded Grumman engineering support for July 1992. Meanwhile, ADPO went looking for funds to extend the program into August to enable completion of the full program as originally planned. To the credit of the Grumman X-29 as well as its Dryden and AFFTC team, the VFC program logged 16 flights in June 1992—more than 1 every 2 days. The VFC envelope expanded to encompass 50-degrees AoA using the smaller of two available VFC nozzles. In June, VFC successfully demonstrated its ability to stop roll rate. While these successes were being logged, a NASA Planning Council approved continuing the VFC effort through July, stopping short of approving it through the end of August. A planned review at the end of July would address August. Meanwhile, ADPO obtained funds to allow the VFC effort to fly to the end of August; AFFTC 6510th Test Wing officials anticipated that NASA support for this would be forthcoming. The X-29 bested its impressive June sortie rate by going aloft 20 times in July. This included a Dryden record for six X-29 flights in 1 day on July 1, 1992.⁸⁹ These flights expanded the large-nozzle envelope to 50 degrees AoA, which made the X-29's VFC system more responsive than with the small nozzles. The successes of the VFC program were encouraging. In July, ADPO sought more funding to enable postflight engineering analysis through the end of September.⁹⁰

Sweeping Forward

The remarkable 20-mission flight rate for July was made even though the aircraft was down for a 25-hour inspection during the last week of the month. Testers took advantage of the downtime to install faster-closing pressure regulators, available when the aircraft returned to flight in August. Bank-to-bank rolls using VFC and the simultaneous use of both nozzles highlighted August test flights. The program ended on August 28 with 60 flights logged. The high sortie rate sometimes saw as many as six flights performed in 1 day. This was necessary to replenish the limited onboard nitrogen supply. (Whenever the X-29 was scheduled to make back-to-back flights in the same day, the engine would be shut down for refueling, but the flight control system remained powered up to avoid having to repeat extensive preflight control system checks and to expedite the turnaround.)⁹¹ When the VFC effort concluded, NASA pilot Steve Ishmael capped the effort with one last victory roll.

The X-29 VFC program correlated flight-test data with previous wind tunnel predictions. All flight-test points were first practiced in the simulator. To enhance simulator veracity, it was continually updated based on actual flight data. The X-29 program continued to marry modeling with real-world flight testing to give pilots the best simulations and to validate testing and measuring methodology. VFC tests were flown at high altitudes before repeating at medium altitudes. More tentative short pulses of the nitrogen system preceded long pulses. Tests expanded the VFC envelope from 10-degrees AoA to 50 degrees. Starting with zero sideslip, tests progressed into sideslip conditions. To quantify the X-29 VFC system's ability to stop a roll maneuver, the aircraft was stabilized in a 45-degree angle-of-bank turn. VFC was applied to induce roll opposite to the turn direction. Upon reaching a specified rate or a specified time, the pilot selected the opposite VFC nozzle to arrest the roll.⁹²

To achieve differential yaw control, a selection of small, medium, or large slotted nozzles was mounted to the aircraft, exhausting to the rear with an inboard cant. In an effort to see if simultaneous blowing of both nozzles could stabilize forebody vortices, two medium, round nozzles were sometimes substituted, facing directly aft. The goal of simultaneous VFC use was to increase lateral-directional stability and to suppress wing rock.⁹³

The VFC program proved its point insofar as the X-29's blown nitrogen system was able to create yaw control responses at high angles of attack even when the rudder lost much of its effectiveness. This relatively lightweight pneumatic approach to high-AoA maneuvering control was in stark contrast to other approaches to this problem. X-29 pilots Gordon Fullerton and Maj. Regis Hancock explained the allure of VFC in a paper presented to the Society of Experimental Test Pilots in 1992:

The X-29 Follow-On Program

Currently the maneuver envelope and agility of fighter airplanes is severely limited due to lack of control power as AoA increases. Two ongoing programs, the X-31 and the F/A-18 High AoA Research Vehicle (HARV), utilize thrust vectoring to improve control at high AoA. This “brute force” method requires heavy, high temperature capable hardware and hydraulic systems. A more elegant approach to improving yaw control at high AoA is vortex flow control (VFC).⁹⁴

Hancock and Fullerton concisely defined the mechanics of vortex flow control:

The technique entails pneumatic manipulation of forebody vortices. By exhausting air through nozzles on top of the airplane forebody one can alter and/or move the forebody vortices. . . . Air exhausted through the right nozzle accelerates the flow of the right vortex and pulls it down closer to the body. As the right vortex is pulled down the left vortex is pushed further away from the body. The result is a lower pressure on the side of the blowing nozzle. This pressure differential results in a side force and yawing moment.⁹⁵

Fullerton and Hancock provided a factual, concise summation of the X-29 VFC results:

VFC proved to be more effective than expected as a yaw moment generator, especially at higher AoA, where the rudder loses effectiveness. . . . VFC effectiveness was roughly proportional to nozzle size and the corresponding mass flow rate. The medium nozzles produced about twice the yaw acceleration as did the small nozzles and the large nozzles showed twice the muscle of the medium nozzles. At AoAs of 40 degrees and greater it took only a one second pulse through a large nozzle to accelerate the airplane to the yaw rate limit established for departure avoidance.⁹⁶

The pilots noted little to no aerodynamic delays at initiation and termination of VFC blowing. Sideslip, which could be deliberately induced by rudder pedal input, proved less effectively controlled by the X-29's VFC system. As the pilots reported: “The effect of sideslip on VFC was evaluated primarily in wings level sideslips, activating VFC in both the direction

Sweeping Forward

opposite to rudder pedal input (adverse) and in the same direction as rudder pedal input (proverse)... [Vortex flow control's] effectiveness dropped off rapidly with sideslip. For a given magnitude sideslip, pilots perceived stronger airplane response to adverse blowing."⁹⁷ An accomplishment of quantifiable flight testing is to determine what does not work as well as what does. Hopes that VFC could diminish X-29 wing rock that existed at zero sideslip above 20-degrees AoA were dashed by the data. "VFC flowing did little to decrease wing rock," Fullerton and Hancock reported. "During the period of approximately four seconds of right nozzle blowing there were insignificant changes in the roll rate oscillation period and amplitude. Likewise, simultaneous blowing through aft pointing round nozzles had little effect on wing rock in the X-29."⁹⁸ Testers noted that the finite nitrogen supply made it impossible to render definitive conclusions on the symmetric blowing effect on natural asymmetries.

The ability of the X-29's limited VFC system to provide desired yaw generation at AoAs between 30 and 50 degrees was impressive. Responsiveness was also good, and testers noted: "If a response was perceived, it was noted to occur almost simultaneously with command of blowing and to stop at termination of blowing. Pilots commented that response was primarily in yaw with negligible pitch or roll effects."⁹⁹

When summing up the lessons learned from the X-29 vortex flow control program, pilots Hancock and Fullerton affirmed the value of close coordination of flight simulation in anticipating actual flights:

In a program where most of the test conditions fall close to the limits of controllability, an accurate simulation is an essential tool for the design of efficient and safe test maneuvers.

Since VFC directly affected controllability, it was critically important to update the simulation data base with the flight measured results day-to-day and sometimes even between flights. The X-29 simulator permitted instant alteration of aerodynamic parameters by an engineer at a terminal immediately adjacent to the cockpit.

During the entire VFC program aircraft control was lost only once. A departure [from controlled flight] to the left occurred at the start of a planned right roll maneuver. This was caused by an earlier than planned initiation of left VFC. The incident made clear the importance of simulator practice not only of the exact intended procedure, but of exploring variations in magnitude and timing of control inputs.¹⁰⁰

The X-29 Follow-On Program

In October 1992, classification specialists declared the X-29 vortex flow control flight-test results to be classified. This caused a temporary suspension of data processing for the VFC final report while its classification and suitable handling procedures were determined. In November, the level of classification was established as Confidential, midway between Unclassified and Secret, and considerably below Top Secret and the even more restrictive Special Access. Even so, this presented an unusual situation since typical NASA research data of the day was not classified; AFFTC security personnel assisted with this issue.¹⁰¹

When the X-29 rolled to a stop after its last VFC sortie on August 28, 1992, the pair of X-29s had amassed a total of 434 flights, 422 of which performed research, a record for the highest number of flights for an X-plane program as of that time.

Endnotes

1. Sefic, "X-29A Program Plan—Forward Swept Wing (FSW)," Wierzbanski X-29 papers and general X-29 files, Air Force Test Center History Office.
2. Ibid.
3. Wierzbanski, interview by Young.
4. Ibid.
5. Ibid.
6. Ibid.
7. Gary Trippensee, "Update of the X-29 High-Angle-of-Attack Program," SAE Technical Paper 912006 (1991).
8. Robert E. Curry, Bryan J. Moulton, and John Kresse, "An In-Flight Investigation of Ground Effect on a Forward-Swept Wing Airplane," NASA TM 101708 (1989), 23-1–23-3.
9. Ibid., 23-3–23-4.
10. Ibid.
11. Ibid., 23-5–23-6.
12. Trippensee, "Update of the X-29 High-Angle-of-Attack Program."
13. Wierzbanski, interview by Young.
14. Daniel G. Murri, "X-29 Free-Flight Tests," paper, Flight Dynamics Branch, Low-Speed Aerodynamics Division (June 8, 1982), Wierzbanski X-29 papers and general X-29 files, Air Force Test Center History Office.
15. Ibid.
16. Ibid.
17. Ibid.
18. Ibid.
19. For Langley's role in testing the X-29, see the previously cited Chambers, *Partners in Freedom*.
20. Wierzbanski, interview by Young.
21. Lisa J. Bjarke, John H. Del Frate, and David F. Fisher, "A Summary of the Forebody High-Angle-of-Attack Aerodynamics Research on the F-18 and the X-29A Aircraft," NASA TM 104261 (1992), 1.
22. Ibid.
23. Ibid., 16.
24. Ibid.
25. "History of the Air Force Flight Test Center 1 October 1988–30 September 1989," Air Force Test Center History Office.
26. Ibid.
27. Ibid.

28. Ibid.
29. Mark B. Tischler, ed., *Advances in Aircraft Flight Control* (London: Taylor & Francis, 1995).
30. Sources conflict on whether it arrived on November 6 or November 8.
31. "History of the Air Force Flight Test Center 1 October 1988–30 September 1989," Air Force Test Center History Office.
32. Hoover, "X-29A Forward Swept Wing Advanced Technology Demonstrator Six Month Project Summary."
33. W. Smith, "X-29 High AoA Flight Test Results: An Overview," SAE Technical Paper 931367, presented at the 1993 SAE Aerospace Atlantic Conference & Exposition, Dayton, OH (April 20–23, 1993).
34. "History of the Air Force Flight Test Center 1 October 1988—30 September 1989," Air Force Test Center History Office.
35. Webster, e-mail message to Johnsen.
36. Ibid.
37. Robert Clarke, e-mail message to Frederick A. Johnsen, January 25, 2012.
38. "History of the Air Force Flight Test Center 1 October 1989–30 September 1991," History Office, AFFTC (only portions without distribution limitations or official-use caveats), Air Force Test Center History Office.
39. NASA, "X-29 Shows Unexpected Maneuverability in 'High-Alpha' Flight," NASA news release 90-10 (April 9, 1990).
40. Ibid.
41. Ibid.
42. "History of the Air Force Flight Test Center 1 October 1989–30 September 1991," Air Force Test Center History Office.
43. Ibid.
44. Trippensee, "Update of the X-29 High-Angle-of-Attack Program."
45. Ibid.
46. Ibid.
47. Ibid.
48. Ibid.
49. Ibid.
50. Ibid.
51. Smith, "X-29 High AoA Flight Test Results: An Overview."
52. Ibid.
53. Ibid.
54. Ibid.

Sweeping Forward

55. Trippensee, "Update of the X-29 High-Angle-of-Attack Program."
56. Ibid.
57. Ibid.
58. Ibid.
59. Ibid.
60. Ibid.
61. Ibid.
62. Pamela J. Underwood, Lewis R. Owens, Richard A. Wahls, and Susan Williams, "X-29 High Alpha Test in the National Transonic Facility (Invited)," AIAA paper no. 2003-0752 (2003).
63. "History of the Air Force Flight Test Center, 1 October 1991–30 September 1992," History Office, AFFTC (only portions without distribution limitations or official-use caveats), Air Force Test Center History Office.
64. "History of the Air Force Flight Test Center, 1 October 1992–30 September 1994," History Office, AFFTC (only portions without distribution limitations or official-use caveats), Air Force Test Center History Office.
65. Smith, "X-29 High AoA Flight Test Results: An Overview."
66. Ibid.
67. Ibid.
68. Ibid.
69. Ibid.
70. Ibid.
71. Maj. Regis Hancock and Gordon Fullerton, "X-29 Vortex Flow Control Tests," NASA document ID 19930054849, as presented to the Society of Experimental Test Pilots in September 1992 and published in SETP's *Proceedings* for that year.
72. Ibid.
73. "History of the Air Force Flight Test Center, 1 October 1991–30 September 1992," Air Force Test Center History Office.
74. Smith, "X-29 High AoA Flight Test Results: An Overview."
75. Ibid.
76. Ibid.
77. Ibid.
78. Ibid.
79. Ibid.
80. "History of the Air Force Flight Test Center, 1 October 1991–30 September 1992," Air Force Test Center History Office.
81. Smith, "X-29 High AoA Flight Test Results: An Overview."

The X-29 Follow-On Program

82. "X-29 Will Fly Again as Research Testbed in Studies of Vortex Flow," *NASA X-Press* (November 15, 1991).
83. The X-31 is the subject of another case study in this series.
84. "History of the Air Force Flight Test Center, 1 October 1991–30 September 1992," Air Force Test Center History Office.
85. Hancock and Fullerton, "X-29 Vortex Flow Control Tests."
86. "History of the Air Force Flight Test Center, 1 October 1991–30 September 1992," Air Force Test Center History Office.
87. Ibid.
88. Ibid.
89. Untitled clipping, probably NASA Dryden *X-Press* newspaper, 1992, Wierzbanowski X-29 papers and general X-29 files, Air Force Test Center History Office.
90. "History of the Air Force Flight Test Center, 1 October 1991–30 September 1992," Air Force Test Center History Office.
91. Smith and Schroeder, "Flight Testing the X-29."
92. Hancock and Fullerton, "X-29 Vortex Flow Control Tests."
93. Ibid.
94. Ibid.
95. Ibid.
96. Ibid.
97. Ibid.
98. Ibid.
99. Ibid.
100. Ibid.
101. "History of the Air Force Flight Test Center, 1 October 1992–30 September 1994," Air Force Test Center History Office.



The Dryden X-29 test team commemorating the 100th flight of the X-29, December 17, 1986. (NASA)

CHAPTER 6

Program Management and Direction

DARPA's fixed-price contract with Grumman to build two X-29s was valued at about \$100 million.¹ This did not include NASA's out-of-pocket wind tunnel research, nor did it include the amounts NASA was spending for support at Dryden. There was an infusion of about \$15 to \$20 million from NASA before the X-29 flew, but significant additional in-kind support was not counted in that dollar amount.² A Grumman document lists funding received for fiscal year 1982 at \$27.8 million.³

A 1987 NASA report encapsulated the working relationships:

DARPA contracted with the Grumman Corporation to build two aircraft using the U.S. Air Force Aeronautical Systems Division (ASD) as its agent. At the same time, DARPA arranged to have the Dryden Flight Research Facility of NASA Ames Research Center (Ames-Dryden) act as the responsible X-29A test organization. The Air Force Flight Test Center (AFFTC) at Edwards Air Force Base and Grumman continue to provide flight test support. However, in autumn of 1986, DARPA assumed a less active role and the U.S. Air Force took over as the governmental lead and responsible overall program manager, with NASA Ames-Dryden continuing in its role of Responsible Test Organization (RTO).⁴

The choice of the Air Force's ASD as procuring agent for the X-29 was due, at least in part, to the suggestion of Air Force veteran Norris Krone, of DARPA, who knew the Air Force's competencies at Wright-Patterson from previous experience. Early in the development of the program, the Navy expressed interest in conducting the flight-test work at its Patuxent River, MD, flight-test complex. But ultimately, Dryden's unique capabilities as a test facility for experimental research aircraft led to Dryden's (and Edwards Air Force Base's) selection as the testing site.⁵

Defining Institutional Relationships

The roles and responsibilities of the various partners were delineated in several X-29 Memorandum Of Agreement documents. NASA and DARPA entered into such an agreement on April 22, 1981. This MOA characterized DARPA's interest in FSW and other technologies emerging at that time:

The Defense Advanced Research Projects Agency (DARPA) has become increasingly active in the field of aeronautics during the past few years and has selected projects which it believes have broad military utility and significant potential benefit for the country's aviation industry. The Forward Swept Wing (FSW) Demonstration Program may have the potential to produce revolutionary changes and improvements in future aircraft design. The FSW concept is general in nature, but combines synergistically with other advancements to produce large performance improvements. If the practicality of the FSW concept can be established it may generate new families of advanced air vehicles with military and possible civil application.⁶

The MOA acknowledged that the recent interest in FSW technology was, from the outset, "aimed at a flight demonstration phase to develop confidence in and acceptance of the technologies being demonstrated."⁷ DARPA-sponsored investigations since the late 1970s produced a technical foundation for FSW flight research, "and it is hereby agreed that the National Aeronautics and Space Administration (NASA) will provide technical and support assistance to DARPA in the conduct of the flight research and demonstration program."⁸ In this 1981 document, DARPA assumed responsibility "for overall program management of the FSW Flight Demonstrator Program. NASA will be responsible for the overall technical and operational portions of the Government conducted flight test."⁹ The 1981 MOA specified the use of NASA wind tunnels "within scheduling and resources constraints."¹⁰ Significantly, NASA was to "assist in the specification of the flight test instrumentation and provide such instrumentation as may be available within present NASA resources for incorporation in the FSW flight demonstration vehicle(s)."¹¹ This supports the perception that NASA was especially well-credentialed to conduct this kind of highly experimental flight research.

The 1981 MOA detailed NASA responsibilities to include:

Conduct the Government flight tests of the FSW flight demonstration vehicle(s).

Program Management and Direction

- a. Develop the detailed flight test plan.
- b. Provide configuration control under NASA procedures for hardware and software during the Government flight test program.
- c. Provide organizational maintenance support.
- d. Arrange for the Air Force Flight Test Center (AFFTC) to provide normal base services and support spares, fuel, oil, chase, and other aircraft support as appropriate.
- e. Assume responsibility for flight safety during the Government flight test program.
- f. Provide physical space, environmentally controlled, suitable for the installation of a high fidelity flight simulator.
- g. Integrate NASA facilities and equipment with DARPA-provided equipment and contractor support to develop a flight simulation at DFRC to be used during the test program.
- h. Provide for all real-time data processing and for reduction of flight test data to engineering units.¹²

At this early preflight stage of the effort, before the contract had been let with Grumman, DARPA's role was central (afterwards, as the effort moved into procurement, it became less involved). The April 1981 MOA codified DARPA responsibilities as:

1. Loan or otherwise make available, as appropriate and at no cost to NASA, the FSW flight demonstration vehicle(s) for the DARPA programmed flight tests. This includes aircraft spares, supporting material and contractor support for engines, aircraft systems and special equipment and facilities needed at DFRC during the flight testing.
2. Provide vehicle specific equipment to be used by DFRC personnel in constructing a high fidelity simulation of the flight vehicle(s). Provide contractor support for the vehicle peculiar aspects of the simulation.
3. Provide necessary funding to support NASA travel requirements while NASA assists DARPA and its technical agent during the final design, fabrication, ground test, and functional flight test of the demonstrator vehicle(s).¹³

The 1981 MOA said: "A separate loan agreement will be established for the allocation of the FSW flight demonstration vehicle(s) from DARPA to NASA DFRC." Ultimately, with the Air Force actually procuring the X-29s on behalf of DARPA, the loan agreement was between the Air Force and NASA. The MOA was signed by NASA's acting associate administrator for aeronautics and space technology, Walter B. Olstad, and by DARPA Director Robert R. Fossum.

Sweeping Forward

Three months after signing the MOA with NASA, DARPA and Air Force Systems Command detailed their relationship in another MOA. It acknowledged the Air Force's work up to the summer of 1981, noting: "This program has been implemented by the Flight Dynamics Laboratory (FDL) of the Air Force Wright Aeronautical Laboratories serving as DARPA's agent with contracts to three major airframe companies and coupled with independent research by FDL and NASA."¹⁴ The DARPA-Air Force MOA acknowledged the earlier MOA with NASA as it forecast a mutually beneficial relationship among the partners: "The existing DARPA/NASA MOA, 22 April 1981, identifies the responsibilities of DARPA and NASA to conduct the Government flight tests and is complementary to this agreement. The aggregated resources of the three agencies will increase program effectiveness and the combined activities will avoid duplication of effort, enhance working relationships, and foster a more rapid technology transfer."¹⁵ DARPA declared the time was right to build a FSW demonstrator: "Recent DARPA assessments have confirmed the program ready to proceed to Phase III—hardware development, fabrication and flight test demonstration."¹⁶

The July 1981 MOA noted: "DARPA will be responsible for overall program management and funding of the FSW Flight Demonstration Program...." DARPA would provide funds and direction for the design, fabrication, and flight testing of the FSW aircraft contemplated. AFSC would "provide the RDT&E [Research Development Test and Evaluation] technical support and procurement services required to develop, fabricate and test the FSW vehicle(s) in accordance with DARPA direction." AFSC also signed up to "assume the responsibility to assure flight readiness prior to first flight" and to designate the Flight Dynamics Laboratory as the DARPA agent. This put FDL in place to manage the "planning, technical direction and control of the Air Force contracts.... Control will include tracking, monitoring and assessing the technical, financial and program progress and day-to-day administration of Air Force contracts."¹⁷

In November 1984, shortly before first flight of the X-29, NASA and the Air Force Flight Test Center signed a MOA specifically addressing safety responsibilities. This MOA takes on special importance in light of other concurrent AFFTC-NASA program situations arising out of safety issues that could be interpreted differently by either party. The November safety MOA is succinct and direct: "NASA ADFRF has full safety of flight responsibility for the X-29A government flight test program and specific AFFTC flight release approval is not required. AFFTC participation in the NASA ADFRF Flight Readiness Review (FRR) process...complies with the AFFTC safety review requirements of AFFTCR [Air Force Flight Test Center Regulation] 127-3.... AFFTC personnel matrixed to the NASA ADFRF X-29A Project

Team will actively participate in all facets of the NASA ADFRF FRR process.”¹⁸ The MOA stipulated participation, not approval, by the AFFTC Safety Office (AFFTC/SE) in the NASA FRR process: “When available, AFFTC/SE will be provided final results of the NASA ADFRF FRR process for review and signature. This information will then be used by AFFTC/SE personnel to prepare any additional documentation required to keep AFFTC management informed of safety aspects of the X-29A government flight test program.”¹⁹ AFFTC’s chief of plans and programs, J.P. “Phil” Brady, signed the November 1984 MOA along with William F. Ballhaus, Jr., NASA Ames Research Center Director.

By December 11, 1984—3 days before Chuck Sewell made the X-29’s first flight—NASA, the AFFTC, and Air Force Wright Aeronautical Laboratories’ Flight Dynamics Laboratory had all signed off on a Memorandum of Agreement outlining safety responsibilities during the brief contractor functional flight-test program flown out of Dryden at Edwards AFB. This MOA realigns some responsibilities from earlier assumptions that changed over time: “The DARPA/NASA MOA concerning the X-29A Flight Research Program tasks NASA to ‘assume responsibility for flight safety during the government flight test program.’ ”²⁰ This dated to a period when Grumman planned for flight testing at Calverton. “Current plans call for functional flight tests to be flown by the contractor [Grumman] at NASA ADFRF.... FDL, as AFSC’s implementing agency for the X-29A, has full safety of flight responsibility for the X-29A contractor flight test program and specific AFFTC and NASA ADFRF flight release approval is not required. AFFTC and NASA ADFRF participation in the FDL flight readiness review (FRR) process...complies with AFFTC safety review requirements...and applicable NASA ADFRF safety review requirements.”²¹ The safety MOAs of 1984 clearly removed redundancy and potential roadblocks from the X-29 flight safety review and approval process.

While stating these responsibilities, the December 1984 agreement purposefully addressed safety of flight tasks leading up to Grumman functional flight tests that began that month at Dryden. AFSC had already been tasked by the Air Force to conduct an X-29 system safety program and to ensure flight readiness before contractor flight tests. The December 1984 MOA delineated how this was accomplished:

1. The Flight Dynamics Laboratory (FDL), as DARPA’s technical agent and AFSC’s implementing office, has taken action to conduct the Government Flight Readiness Review (FRR) of the contractor flight test program.
2. An Executive Independent Review Team (EIRT) has been established by AFSC’s Aeronautical Systems Division (ASD) to conduct an independent review of the X-29A contractor flight test program.

Sweeping Forward

3. The contractor is also conducting an intensive in-house FRR of this program.²²

The Flight Dynamics Laboratory and the AFFTC executed their own working agreement to codify each organization's X-29 responsibilities and to avoid duplication of effort. FDL was to ensure that the Department of Defense flight-test objectives "reflect requirements as they relate to the design process of future DOD aircraft."²³ FDL was charged with the responsibility to "ensure the flight test and simulator results and analysis from the X-29A Flight Research Program are translated into meaningful criteria applicable to the design and operation of future DOD aircraft."²⁴ This agreement delineated a key AFFTC tasking: "The AFFTC will appoint an X-29A Project Manager who will be responsible for representing the DOD in the on-site day-to-day planning and accomplishment of the X-29A Flight Research Program. The AFFTC X-29A Project Manager will coordinate with the FDL X-29A Program Manager on events or findings of major importance and effect on mutually established objectives. A monthly summary report will be provided."²⁵ AFFTC was also charged with the responsibility to monitor instrumentation and data collection efforts "to ascertain that instrumentation is consistent with DOD data requirements."²⁶

Shortly before NASA began envelope expansion with the X-29A-1, in late March 1985, AFWAL and NASA Ames-Dryden Flight Research Facility signed a Memorandum of Agreement regarding the X-29 Concept Evaluation Program. This program embraced the period from the first Government flight of the X-29 through envelope expansion, technology evaluation, and flight research. This MOA charged NASA ADFRF with the "responsibility for complete and accurate configuration control records during the periods of loan to NASA, and [to] participate with Grumman in ensuring that complete and accurate configuration records are maintained during periods when the aircraft is under control of Grumman."²⁷ Configuration control—knowing exactly what modifications have been made to an aircraft at any point in time—is vital for the safety of any aircraft; with a unique test vehicle like the X-29, the likelihood for changes only increases the need for accurate configuration control records.

The MOA also specified NASA's need to "provide, on an 'as available' basis, for satellite transmission of data to Grumman Aerospace Corporation in New York."²⁸ This satellite data transmission to Grumman, while beneficial to the program, "is not required for the sole conduct of any flight."²⁹ The MOA also placed the NASA X-29 project manager as the single focal point for interface with Grumman's onsite X-29 manager for coordination of activities by the Grumman staff at Dryden in support of the CEP.³⁰ Repeatedly, the various MOAs show evidence of thoughtful planning to forestall any confusion and duplication in roles and responsibilities, and this foresight helped the X-29 program avoid bottlenecks at decision points.

Funding

Funding initially was secured through the first four phases of the X-29 program: (1) Conceptual Design, (2) Preliminary Design, (3) Aircraft Fabrication, and (4) Concept Evaluation. Proponents of the program sought, and received, some additional funds to take the X-29 deeper into high-AoA studies.

Through 1986, program funding was \$215 million. This worked out to about \$120 million from DARPA, \$55 million from Grumman, about \$20 million from NASA, and another \$20 million from other sources. This bought two X-29A aircraft and flight tested them as appropriate to the end of fiscal 1986.³¹

The following table presents direct and indirect funding sources (in millions of dollars, in that year's value) required to keep the program operating after fiscal year 1986:

Direct Funding Sources					
Institution	FY87	FY88	FY89	FY90	Total By Source
USAF	8.5	8.5	3.7	1.0	21.7
DARPA	2.0	1.0	2.0	—	5.0
NASA	1.5	1.5	0.5	—	3.5
Yearly Total	12.0	11.0	6.2	1.0	30.2

Indirect Funding Sources					
Institution	FY87	FY88	FY89	FY90	Total By Source
USAF	1.4	1.4	1.4	.3	4.5
NASA	8.4	9.2	10.2	.5	28.3
Yearly Total	9.8	10.6	11.6	.8	32.8

Funding for the X-29A-2 high-AoA program came from the Air Force Flight Dynamics Laboratory at Wright-Patterson AFB, OH. FDL also managed this part of the X-29 effort.³² DARPA was directed by Congress to end its support of the X-29 program in 1988, resulting in increased funding demands on the Air Force and NASA for all test work thereafter.³³

NASA-Air Force X-29 Program Management and Implementation

NASA's "wiring diagram" for X-29 program management was a straight line descending from NASA Headquarters through NASA Ames Research Center to the then-NASA Dryden Research Facility and to the X-29 project office. Hovering to the side, with a direct link to NASA Headquarters and a dashed

Sweeping Forward

line to the X-29 project office, was DARPA, the think tank behind the whole FSW aircraft concept.³⁴ Air Force involvement in the X-29 program included a practical requirement for an agency familiar with aircraft procurement to act on behalf of DARPA. At the Edwards Air Force Base (Air Force Flight Test Center) level, it was deemed prudent to have a participating, but not lead, role in the X-29. This was done in part to support tenant unit Dryden and, in part, to sharpen Air Force test and evaluation skills with this cutting-edge aircraft, the first true X-plane in a decade.

A second NASA organizational chart broke out the relationships between the diverse agencies. DARPA communicated with both NASA Headquarters and the Air Force Systems Command, with AFSC communicating through the Air Force Flight Dynamics Laboratory to the AFFTC. AFFTC was also in direct communication with Dryden. Air Force headquarters was pictured on the chart with a one-way flow to AFSC.³⁵

Management and implementation of the X-29A program was the responsibility of the Dryden X-29A project manager. At his service was the NASA X-29A program plan to provide guidance on how to meet the program objectives. The NASA X-29A program plan acknowledges programmatic precedents for efficiency and effectiveness established by the earlier X-15 and X-24 programs, both of which required cooperation and collaboration between NASA and the Air Force.

Dryden's X-29 program manager, Walter Sefic, characterized the X-29 team working relationship in 1986: "The organizational responsibilities and the agreements between the respective agencies appear to be complex. In actual practice, the working relationship between the various agencies was problem-free; the memoranda of agreement (MOA), the project management directive, and the contracts were filed and were seldom needed to clarify issues."³⁶

Before first flight, NASA and the Air Force's ADPO had to come to an agreement about overall program responsibility. DARPA initially favored having ADPO, as DARPA's agent, perform overall X-29 program management. After AFFTC indicated that it could not effectively serve as RTO—again in response to entreaties from DARPA—it remained for NASA and the other partners to hammer out the details. The responsibilities of ADPO were to represent DoD interests while NASA became the RTO.

In November 1983, more than a year before first flight, Maj. Ted Wierzbanski wrote Dryden's Walter Sefic about avoiding duplication of Government effort: "It appears that the ADPO will continue to function during the flight test program. Because of this, the responsibilities of NASA DFRF, the AFFTC, and the ADPO need to be identified and agreed upon so that we don't 'trip over each other' in trying to do what we perceive as our responsibility."³⁷ Due to the proactive vigilance of X-29 team members like

Program Management and Direction

Wierzbanski, the project managed to effectively delineate roles and responsibilities, threading a careful path between management oversight and the dangers of excessive bureaucracy.

Early in the program, the Air Force Flight Test Center augmented NASA in some engineering disciplines to help get the X-29 effort under way long before first flight. But AFFTC support was finite, and AFFTC X-29 project manager Ted Wierzbanski felt compelled to rein in some AFFTC support because of a perception in some Air Force circles that NASA would willingly let others perform tasks while using its own resources elsewhere.³⁸ In any case, the coalescing X-29 team at Edwards AFB quickly learned how to extract the best from their multi-agency partnership, demonstrating, yet again, that the partnership of NACA-NASA, the Air Force, and other military services had been a crucial enabler for many of the advances made in the aeronautical sciences since the Second World War.

Endnotes

1. This was put at \$92 million in literature of the period. See, for example, Schlitz, "Aerospace World News, Views and Comments."
2. Wierzbowski, interview by Hallion.
3. Grumman Aerospace Corp., "X-29A Advanced Technology Demonstrator R&D Status Report No. 7, 15 June 1982 to 15 July 1982," Wierzbowski X-29 papers and general X-29 files, Air Force Test Center History Office.
4. Trippensee and Lux, "X-29A Forward-Swept-Wing Flight Research Program Status."
5. Norris J. Krone, interview by Frederick A. Johnsen, October 4, 2011.
6. "Memorandum of Agreement Between National Aeronautics and Space Administration and Defense Advanced Research Projects Agency Concerning Forward Swept Wing Flight Test Program" (April 22, 1981), Wierzbowski X-29 papers and general X-29 files, Air Force Test Center History Office.
7. Ibid.
8. Ibid.
9. Ibid.
10. Ibid.
11. Ibid.
12. Ibid.
13. Ibid.
14. "Memorandum of Agreement, Defense Advanced Research Projects Agency (DARPA) and US Air Force Systems Command (AFSC) for the Conduct of the Forward Swept Wing (FSW) Flight Demonstration Program" (July 22, 1981), Wierzbowski X-29 papers and general X-29 files, Air Force Test Center History Office.
15. Ibid.
16. Ibid.
17. Ibid.
18. "Memorandum of Agreement Between the National Aeronautics and Space Administration Ames Research Center Dryden Flight Research Facility and the Air Force Flight Test Center on X-29A Advanced Technology Demonstrator Government Flight Test Program Safety Responsibilities" (November 16, 1984), Wierzbowski X-29 papers and general X-29 files, Air Force Test Center History Office.
19. Ibid.
20. "Memorandum of Agreement Between the National Aeronautics and Space Administration Ames Research Center Dryden

Program Management and Direction

- Flight Research Facility, the Air Force Flight Test Center and the Air Force Wright Aeronautics Laboratories' (AFWAL) Flight Dynamics Laboratory (FDL) on the X-29A Advanced Technology Demonstrator Contractor Flight Test Program Safety Responsibilities" (December 11, 1984), Wierzbowski X-29 papers and general X-29 files, Air Force Test Center History Office.
21. Ibid.
 22. Ibid.
 23. "Working Agreement Between the Air Force Aeronautical Laboratories' (AFWAL) Flight Dynamics Laboratory (FDL) and the Air Force Flight Test Center (AFFTC) on the X-29A Advanced Technology Demonstrator Flight Research Program Responsibilities" (undated), Wierzbowski X-29 papers and general X-29 files, Air Force Test Center History Office.
 24. Ibid.
 25. Ibid.
 26. Ibid.
 27. "Memorandum of Agreement Between Air Force Wright Aeronautical Laboratories Flight Dynamics Laboratory (and) National Aeronautics and Space Administration Ames Research Center Dryden Flight Research Facility on the X-29A Concept Evaluation Program" (March 26, 1985), Wierzbowski X-29 papers and general X-29 files, Air Force Test Center History Office.
 28. Ibid.
 29. Ibid.
 30. Ibid.
 31. Wierzbowski, interview by Young.
 32. "History of the Air Force Flight Test Center 1 October 1988–30 September 1989," Air Force Test Center History Office.
 33. Trippensee, "Update of the X-29 High-Angle-of-Attack Program."
 34. Sefic, "X-29A Program Plan—Forward Swept Wing (FSW)."
 35. Ibid.
 36. Sefic and Maxwell, "X-29A Technology Demonstrator Flight Test Program Overview."
 37. Maj. Theodore J. Wierzbowski to Mr. Wally Sefic (NASA DFRF), Memo for Record, "Subj: Concerns on X-29A Flight Test Program" (November 14, 1983), Wierzbowski X-29 papers and general X-29 files, Air Force Test Center History Office.
 38. Wierzbowski, interview by Hallion.



The General Dynamics AGM-129 Advanced Cruise Missile incorporated a small forward swept wing. (USAF via NASA)

CHAPTER 7

Lessons Learned and Research Dissemination

“For the investment, my personal opinion is that we are really getting a hell of a lot out of the X-29 program. Just in terms of building a basic technology base, getting us ready to test new generations of airplanes, I think it’s going to pay for itself.”¹ Air Force Flight Test Center X-29 pilot and manager Ted Wierzbanski made that prediction in 1986, even before follow-on programs took place. His view corroborates the notion that the X-29’s biggest benefit may not have had anything directly to do with forward swept wings and may have had much to do with reschooling the testers at the AFFTC and the Ames-Dryden Flight Research Facility on new ways to flight test the unknown.

The ongoing validation or benchmarking of modeling-versus-flight test was a major goal of the X-29 program from the outset. An Air Force Wright Aeronautical Laboratories analysis of X-29 predictions versus results in March 1986 provided a snapshot of this:

Based on initial analysis and ground test, forward swept wings were projected to provide quantified aerodynamic characteristics and configuration dependent advantages when compared to similar geometry aft swept wings of equal weight, principally in five areas:

1. Increased aspect ratio, reducing induced drag.
2. Reduced leading edge sweep, reducing drag due to lift (increased leading edge thrust)....
3. When combined with a supercritical airfoil, increased transonic shock sweep, reducing wave drag....
4. Delayed tip stall allowing deeper stall penetration....
5. When combined with a canard, improved canard integration effectiveness in delaying root stall.

[Flight results as of that time] confirm predicted levels of forward sweptwing aerodynamic benefits in areas 1, 2, 3, and 5 (see above).²

Sweeping Forward

Additionally, the March 1986 review of data showed: “Wing pressure distributions closely match wind tunnel data.... Overall shock wave geometry closely matches wind tunnel data.... Comparison of drag polars, containing X-29 flight results show X-29 performing as well as or better than expected.”³

The evolving ability to acquire and use flight-test data in the mission control room while the mission was under way happened on a parallel track with X-29 development. Real-time data analysis was a universal flight-test goal that happened to be ideally suited to the complex and exotic X-29. One key element was the Telemetry-Radar Acquisition and Processing System (TRAPS), part of NASA’s Code O Data Network’s (CODN’s) Western Aeronautical Test Range (WATR). As CODN summarized its functioning:

The physical front-end of the Code O data network (CODN) is in the NASA WATR (Western Aeronautical Test Range). This facility is responsible for the real-time acquisition, processing, display and distribution of flight test data during a research mission. Multiple telemetry tracking systems, in manual, auto-track or radar slave mode, acquire data in real time from research vehicles. These systems and their associated radio frequency (RF) subsystems deliver the flight test data streams to the real-time processing systems in the WATR mission control centers.⁴

The Future Applications Committee canvassed the American aerospace industry during the X-29 program, seeking inputs about the type of flight demonstration data that would be helpful to industry. Learning industry priorities regarding X-29’s various technologies helped the program deliver useful data and, additionally, the Government permitted engineers from other American aerospace firms to participate in the X-29 program at company expense.⁵ DARPA’s John Retelle and Jim Allburn recalled that FAC members requested “more instrumentation data to substantiate both the longitudinal instability and loads on the composite wing.”⁶ As a result, more pressure probes (Kulites) were placed on the wing to collect data. “Despite the instrumentation and large amount of data collected, it was difficult to determine the performance benefits of the individual technologies integrated on the aircraft,” both men recalled; they added, “This may have contributed to the lack of acceptance of the configuration.”⁷

The X-29 program’s Future Applications Committee was a rare—perhaps unique—venue at which competing American aerospace contractors learned what Grumman was learning as part of the program’s goal of sharing technologies to keep U.S. companies competitive. FAC sessions regularly brought competitors together in a room to learn developments even before the X-29

Lessons Learned and Research Dissemination

flew, and this included future ATF bid competitors. The FAC “had a huge impact” on the broad sharing of X-29 technological developments, recalled DARPA’s John Retelle. “Grumman’s results during the X-29 program were shared to provide the entire U.S. aerospace industry with a national competitive advantage,” he said. The X-29’s accomplishments “gave everybody confidence,” Retelle explained.⁸

From the outset, DARPA’s intended beneficiary of the various technologies demonstrated with the X-29 was the Air Force. Traditionally, the aerospace industry has been understandably reluctant to embrace costly and unproven—even if cutting-edge—technologies when submitting competitive design proposals unless the customer—typically the Air Force or Navy, but also commercial concerns such as airlines—has first indicated that the incorporation of new technologies is a risk for which it is willing to pay. With this in mind, the X-29 team, through AFSC, established an information stream to the potential end user of the X-29’s technologies. This potential end user was the Air Force’s TAC, arbiter of future fighter design requirements.⁹ Ted Wierzbanski said the X-29 forward sweptwing designs would almost certainly not appear on any next-generation “wish list” from the Tactical Air Command, but the team believed at the time that FSW might at least be on such a list for fighters two or three generations hence.¹⁰

In one case, the apparent closeness of the X-29 to an emergent potential fighter aircraft prototype raised more than a few eyebrows—in part, because the design was Russian, not American. Western observers of aeronautical developments sometimes decry any apparent Soviet, and later Russian, copying of technologies first flown in the West. Such copying is evident from even a casual comparison of emergent Western fighter, strike aircraft, and airlifter designs (and even the NASA Space Shuttle orbiter), and their Soviet/Russian “derivatives.” When the Sukhoi S-37 forward sweptwing fighter prototype surfaced in 1997—its impact heightened by a menacing black overall finish—its visual similarity at first glance to the X-29 was striking.¹¹ Closer inspection revealed significant differences and, of course, Russian investigators had a decades-long indigenous heritage of pursuing forward sweptwing technology, and not just after Stalin’s technical intelligence teams had appropriated the unfinished wartime German Junkers Ju 287 airframes.

The S-37 was twice as big as the X-29 and powered by two massive Aviadvigatel D-30F6 afterburning turbofans that produced a combined takeoff thrust of 68,400 pounds. The larger size of the S-37 enabled Sukhoi designers to avoid the problem Grumman faced when trying to carry external stores on the forward swept wings of the diminutive X-29: the Sukhoi simply employed internal weapons stowage à la the later F-22 or F-35. While the S-37 employed canards and its own version of aft strake flaps (looking more like vestigial horizontal stabilizers)

Sweeping Forward

to control pitch, the beefier test bed had two canted vertical fins and rudders instead of the X-29's single-fin design. As with the X-29, computer flight controls and composite construction enabled the S-37 to achieve its desired performance. But even though the Sukhoi design team enthusiastically embraced the high AoA and maneuverability promised by forward swept wings, even this operationally oriented design failed to achieve production, remaining simply an intriguing technology demonstrator. Sukhoi instead turned to reworking its proven Su-27 into later and more powerful variants (typified by the Su-30, with vectored thrust and canard flight controls added to its otherwise traditional Su-27 lineage airframe) and moving beyond to development of a prototype fifth-generation, low-observable fighter roughly comparable to the American F-22 Raptor. While the S-37 likely influenced some of this work (particularly on high-AoA controllability), FSW per se still has yet to make its appearance on the world's stage of combat aircraft employment; whether it will remain an unanswerable question. However, thanks to the meticulous documentation of the X-29's experience, at least a database exists that the global design community can employ to inform their decision making on future civil and military configurations that might employ the FSW planform.¹²

Accomplishments and Legacy, Voices and Perspectives

Any aircraft test or development program is likely to wrestle with dynamic tension between the budgeters, engineers, and fliers. As remarkable and productive as the X-29 program was, it could have done much more, or accomplished the same goals in less time, had the aircraft been fitted with aerial refueling capability and an inexhaustible vortex flow control system. Omission of these and other features was not done capriciously but in light of time and dollar constraints. It has been argued that the cost of installing aerial refueling capability, while initially boosting the purchase price, would have realized savings over the long run in terms of more-productive (i.e., longer) test flights with fewer takeoff and landing cycles. While such is an intriguing possibility, it remains an unproven one.

As Wierzbanski recalled, when the X-29 program was active in the 1980s, team members looked back to the remarkably groundbreaking X-15 program and concluded its risks and unknowns at the time were of such magnitude that the agencies involved would not have been able to secure approval for its development in the X-29 era. Reflecting nearly three decades later on the experience of the X-29, Wierzbanski now believes that the X-29 program likely could not take place in today's increasingly risk-averse climate. Risk aversion is a crucial balancing act. The staggering losses of test pilots and flight-test

Lessons Learned and Research Dissemination

engineers in the early Cold War era are unthinkable and unacceptable today. Yet a test program with low risk is typically a test program with low gain. Gone are the days when testers could “kick the tires and light the fires” and go fly. Now, the 24/7 news cycle places everything under scrutiny, sometimes creating crises where none exist. A successful flight-test enterprise, far greater than any one test program, must manage expectations to educate policymakers and the public about what constitutes a proper level of risk in the quest for aerospace knowledge.

Just as the X-29 program developers researched the existing body of knowledge on topics like forward swept wings and high-AoA flight when they crafted the X-29 effort, it is to be expected that current and future researchers will continue to mine the knowledge gained and preserved in the many X-29 technical reports and professional papers for many years. If forward swept wings and high-AoA flight did not become vital and commonplace in subsequent production aircraft, the knowledge and parameters staked out by exhaustive X-29 flight evaluations were nonetheless vital to enabling designers and researchers to make informed decisions. And the continuing forward march of understanding aeronautical phenomena may plausibly be expected to discover a need for some or all of these technologies in the future, whether for manned aircraft or nano-Remotely Piloted Aircraft (RPA). The X-29's body of work is fertile ground for more research. The teamwork and high level of correlation between modeling and actual flight testing on the X-29 program set an important tone for other test programs, such as the X-31 and NASA's HARV F/A-18, that followed. X-29 pilot Maj. Harry Walker observed in 1988: “In the area of aerodynamics we have built a data base of pressures and deflections for a forward sweptwing aircraft with a high-power close-coupled canard. This data is being analyzed and will allow designers to more clearly understand the aerodynamic characteristics and interaction effects of these technologies.”¹³

NASA's Dave Lux and Gary Trippensee produced a short list of observations for a 1987 NASA paper on the lessons learned from the X-29 program:

Several “lessons learned” have emerged from the flight test program. The most significant of these lessons are the following:

1. Do not compromise the quality of instrumentation or the quantity of sensors. Even though the X-29A airframe and subsystem were very reliable, the instrumentation system required the largest amount of maintenance.
2. A collocated, hardware-in-the-loop simulation is necessary for safe and efficient flight test of this type of air vehicle.
3. Strip chart monitoring of traditional aircraft response parameters does not ensure safe envelope clearance for aircraft

Sweeping Forward

with highly relaxed static stability. Active, online loads and vehicle performance and flight control analyses are required during the flight tests.¹⁴

A 1995 study of the X-29 flight control system and the X-29 program derived a number of conclusions for professional consideration. Among them: the X-29 effort demonstrated that the aircraft flight controls provided adequate stability to enable successful testing of a 35-percent statically unstable airframe over the aircraft's entire performance envelope in the flight-test research environment. The program also revealed that X-29 static instability and control surface rate limits affected the aircraft's maximum nose-up and nose-down pitch rates. At low airspeeds, in order for the X-29 to achieve pitch rates comparable with a production aircraft like an F/A-18, new actuators with a rate at least 50 percent higher were needed. Testers learned how crucial air data precision is for an airframe as unstable as the X-29. Standard fighter aircraft air data redundancy management tolerances proved inadequate to cope with the X-29's flight control system requirements; tighter tolerances were necessary. Variable gain flight control software was a valuable way to evaluate predicted flying qualities changes in back-to-back testing and to flight-test proposed gain adjustments before making major FCS gain changes.¹⁵

Air data anomalies included the initial way in which the FCS chose which probe's data to use. This became increasingly important at high angles of attack, where forebody vortex flow impinged upon the two fuselage-mounted air data sensors. As described in a 1994 NASA paper:

Several changes in the flight control system were required as a result of the high level of instability of the X-29A. A significant change was made to the air data selection logic. The initial control laws used three equally weighted sources (a single noseboom and two side probes) for total pressure measurements. The most accurate source, the noseboom measurement, was almost never used by the flight control system since it was usually an extreme, not the middle value. To compensate, a change was made to use the noseboom as long as it was within the failure tolerance of the middle value. This change came back to haunt the test team as the failure tolerance was very large and it was discovered that a within-tolerance failure could result in such large changes in feedback gains that the longitudinal control system was no longer stable.¹⁶

Large errors in side-probe measurements were caused by strong forebody vortices, which enveloped one or both of the air data probes located on the

Lessons Learned and Research Dissemination

sides of the X-29's fuselage. The solution was a change in tolerance and bias added to the side-probe measurements. "This worked," researchers concluded, "since the sensitivity to the high gain condition (airplane faster than indicated) was much greater than that of the low gain condition (airplane slower than indicated). The airplane had been operated for almost three years before this problem was identified and fixed."¹⁷

At several junctures, the X-29 team's use of real-time data observation was a boon to the schedule. As reported in a technical paper presented to the Society of Experimental Test Pilots in 1988:

The X-29 team incorporated several new data acquisition and reduction techniques to obtain real time performance data. The Computing Devices of Canada (ComDev) system of mass flow computation combined with real time computation of the dynamics data gave the team a real time look at drag polar. This technique allowed the researchers to determine if the flight test point was complete and that quality data had been gathered. The data were also recorded for postflight analysis and further refinement. Using AFFTC data reduction computer programs (DPS and UFTAS) dynamic performance data were reduced to an accuracy of approximately 2.7 percent. Special techniques were developed for use of these data reduction programs to handle the data from this highly unstable aircraft. The techniques inherent in analyzing this class of vehicle are now available for modification of future programs.¹⁸

The X-29's success was clearly a result of its genesis as a pure research aircraft. Necessary shortcuts in its feature set, and in its appearance, made it suitable to demonstrate fighter options without actually being a fighter aircraft. Historically, as a general rule, demonstrators have not been developed successfully into operational aircraft, but they have been highly influential by showing opportunities for exploitation and highlighting or demonstrating technology that is nearing maturation for operational application. Starting with the privately funded Hughes H-1 racer of the mid-1930s, an Air Corps evaluation of its potential to become a fighter ultimately determined that necessary militarization of the H-1 would diminish the original racer's performance, yielding nothing better than the existing Seversky P-35 once necessary changes were made. In 1945, an effort by Bell Aircraft Corporation's chief engineer Robert Woods to turn the XS-1 program into both a supersonic research platform and an operational fighter first centered on using turbojet propulsion, which was clearly inadequate and incompatible with the XS-1's supersonic research

Sweeping Forward

mission. Then, an effort to create a rocket-propelled fighter variant of the XS-1 went stillborn for lack of need as well as for operational impracticality. The Bell X-5, an adopted version of an abortive German jet fighter—the Messerschmitt P.1101 project—demonstrated the benefits of variable wing sweep in the early 1950s, performing so well that the Air Force briefly evaluated it as a potential lightweight export fighter for the nations of the North Atlantic Treaty Organization (NATO). But again, as with the Hughes H-1 racer earlier, the X-5 lost any advantages once it was expected to take on military equipment and armament. The Ling-Temco-Vought XC-142 V/STOL transport, circa 1964, constituted a triservice effort to quickly exploit emergent vertical/short takeoff and landing (V/STOL) technology to produce a joint service multipurpose tactical airlifter. But flight testing, while demonstrating the basic technology used to achieve V/STOL performance, also highlighted significant difficulties and shortcomings that militated against its application to a production aircraft at that time.¹⁹ In the 1970s, Lockheed's XST Have Blue low-observable test bed demonstrated the benefits of integrating computational analysis, fly-by-wire, shaping, materials, and coatings to produce “stealth” aircraft, but it did not itself have the prospect of being a combat design. Rather, thanks to its demonstrations, Lockheed and the Air Force were able to pursue a larger and fully capable “weaponized” stealth aircraft, the F-117.²⁰ Other examples abound, indicating that, as a general rule, research aircraft demonstrate important technical capabilities that are incorporated piecemeal in subsequent designs but almost never by a derivative airframe of the test aircraft itself.

Ken Griffin was an Air Force officer brought in to lead the Air Force Flight Test Center test engineering component of the X-29 flight research program while being collocated and hosted by the aeroelasticity office at the Dryden Flight Research Center. Griffin's Ph.D. dissertation was on the use of active control of FSW divergence using the X-29 as a starting point. He was familiar with the X-29 and its aeroelastic characteristics. Ken had previously performed several years of small-model wind tunnel testing of the X-29 configuration and its reduced tip vorticity while teaching at the Air Force Academy. Griffin was an obvious choice for the X-29 program; he was familiar with the concept of aeroelastic tailoring of advanced composites and authored some of the early technical papers on this subject while assigned as an aeroelastician to the Air Force Flight Dynamics Laboratory (AFFDL). Looking back on the X-29 program from the vantage point of succeeding decades, Ken Griffin provided his insights. When asked if the X-29 lived up to its expectations, Griffin observed: “Technology wise, I believe that it did, since the performance of FSW in terms of lift production at lower drag was shown to be better than expected, and shown in a full scale aircraft uncorrupted by wind tunnel testing techniques. So much so that at first the performance engineers thought the data was too

Lessons Learned and Research Dissemination

good to be true. From all accounts I have received, these positive L/D (lift over drag) numbers especially at the high lift maneuver conditions around transonic speeds held up under continued examination. . . . From a flight test perspective I believe it rekindled an interest and appetite for full scale flight demonstrations that had really gone dormant both in AFFDL and AFFTC. This was a highly successful joint industry/Air Force/DARPA/NASA program that provided an attractive model for several future test programs.”²¹

In Ken Griffin’s view:

Given the cost, schedule, and programmatic constraints I believe the program was just about optimum. Usefulness should not be measured in terms of number of missions or data points collected. In my view the degree of maturity in technology readiness level, or rather more importantly the maturity in the ability to achieve designed performance from the FSW design processes is the correct measure. Using this I believe the expectations of higher performance that FSW could offer was well established. We could design it, and you could count on it. Also the high degree of “jointness” in the participating agencies short circuited much of the potential for side line “pot shots” at FSW potential from competing agency programs.²²

One of the X-29 program’s selling points was the fact that the aircraft was much more than simply a FSW demonstrator. Touted as an economy, the X-29 hosted multiple emerging technologies simultaneously. However, engineers ultimately found it difficult, if not impossible, to isolate specific performance values for individual technologies because they worked in concert with other technologies. Griffin explained:

From an engineer’s perspective the demonstration of multiple technologies on one airframe simultaneously was a very bad idea. We had much difficulty separating out the pluses and minuses of the individual technologies with them all active at the same time. For example we had great difficulty separating out the benefits of the canard from the benefits of the variable camber flaps or from the strake flaps. The X-29 used them all simultaneously and did not have provision for deploying them separately. This was further complicated when Grumman was forced to use old/slow hand-me-down flight control computers. Their slowness and the extreme degree of static instability that the X-29 had left the experimental test program with little room to test individual

Sweeping Forward

technology pieces to better understand their individual contributions. Thus it was very difficult to develop parametrics for their individual contributions.²³

Griffin recalled concerns that FSW designs might be inferior in the emerging world of stealth, noting: “I believe that the incorrect stealth perceptions of FSW prevented its significant influence on ATF designs leading to the F-22. It is not clear how much influence the X-29 had on contemporary weapons configurations that used FSW.”²⁴ (It is worth noting that the Air Force’s General Dynamics AGM-129 stealthy air-launched advanced cruise missile incorporated a forward swept wing, but not one as extreme as that of the X-29.)

On the value of composite construction techniques, Griffin said:

The exploitation of aeroelastic tailoring of advanced composites has become a routine design exercise for lifting surface designs that use advanced composites. Since aeroelastic tailoring was being developed near simultaneously at several of the major airframe manufacturers, it is not clear how much confidence was developed industry wide with the success of the X-29. It has been my observation that it quietly solidified confidence in aeroelastic tailoring as a composite design attribute to exploit by all of the design shops. The X-29[']s fault-free composite performance, even with the scare caused by the [Bell-Boeing V-22] Osprey’s composite wing box failure, settled a lot of fears.²⁵

James Allburn, who succeeded Norris Krone as DARPA’s X-29 program manager, credits much of the X-29 program’s success to the cooperative attitudes of the participants from varied backgrounds, noting: “This was an IPT (Integrated Product Team) before that was even acknowledged as a term.”²⁶ IPTs are frequently used in the military and industry to harness the capabilities of diverse individuals and organizations to achieve a goal. “It worked because of the people involved in it. It was a factor of the personalities and the motivations.”²⁷

Allburn agrees with others on the X-29 team who recalled that it was difficult if not impossible to isolate quantifiable results from some of the integrated technologies on the X-29. “All of those [technologies] were successful in a gross sense,” Allburn said. But the aerospace community knew early that a downside of demonstrating so many interdependent technologies on one aircraft would be the inability to quantify the benefits of each technology individually, should that be desired. NASA did the best they could with instrumentation under the circumstances. “I give great credit to the NASA folks”²⁸ who were involved with instrumenting the X-29, Allburn said. The countdown to completion

Lessons Learned and Research Dissemination

of aircraft number one saw “a lot of NASA people living at Grumman,”²⁹ he recalled. Decades later, Allburn remains impressed with the sense of collaboration that permeated the X-29 effort.

The collaborative spirit manifested by many on the X-29 program was not lost on engineer Jeffrey Bauer at Dryden. Jeff Bauer first came to Dryden in January 1983 as a student co-op, a position that provided real-world learning opportunities for college students. As a student, he was assigned to the X-29 effort. “It was a very good baseline,” he recalled, as the well-run X-29 program provided good experiences for the young co-op. In 2011, Bauer, a career engineer and manager at Dryden, remembered the importance placed upon monitoring data strip charts that tracked the operation of the vital pitch-rate gyros during X-29 missions. These gyros were essential to maintaining control of the aircraft. “I was dumbfounded that they would set a co-op in front of such an important instrument,”³⁰ he recalled. “I was certainly not special in that regard,”³¹ he added. Jeff said Dryden was—and is—good about giving people responsibility on programs, and it showed during his experiences with the X-29.

Kenneth J. Szalai was the head of engineering at Dryden during the X-29 program, and he subsequently served as Dryden Director from 1990 to 1998. Szalai recalled that

[t]he X-29 was a great project for NASA DFRC because it was a true X-aircraft, probing the unknown. The “unknown” in this case was the fusion of forward sweptwing aerodynamics, aeroelastically tailored composite wing structure to counter catastrophic FSW divergence, a unified canard-wing aerodynamic design for transonic maneuvering and high angle of attack capability without wing leading edge high lift devices, a blended three-surface longitudinal flight control system (canards, elevons, strakes) in this tailless configuration, and control law design to stabilize what probably was the most statically unstable piloted aircraft ever flown.... Dryden conceived and developed a real-time gain and phase margin monitoring system never before used to assure safety as the aircraft’s speed envelope was increased.... [Dryden’s deep involvement in the technical aspects of the X-29 effort] utilized and extended Dryden’s technical prowess [and the talented leadership at DARPA and Grumman afforded exceptional] vision and skill that resulted in brilliant execution of this project.³²

Szalai emphasizes that a key “lesson learned” he took away from the X-29 program was that “Dryden is best utilized as a partner [rather] than as a lesser participant.”³³ Dryden “was a full partner in the X-29 with DARPA

Sweeping Forward

and Grumman,” he recalled. “We did parallel analyses and collaborated with Grumman to achieve a team success.”³⁴ Another lesson that Ken Szalai gleaned from the X-29 program was the need to stand on principle: “John Manke [then Director of Dryden] took a very strong position that the very advanced X-29 [should] fly its maiden flight from Edwards AFB rather than Long Island. He prevailed. I learned that leaders must stand on principle, and that sometimes, it is hard to do in strong headwinds.”³⁵

Ken Szalai considers the X-29 program to be an important Dryden project among the many the Center has undertaken in a history that reaches back to the breakthrough XS-1 of the late 1940s and the X-15 of the 1960s. By the time of the X-29, Dryden had evolved the capability to produce a high flight rate during multiple test and research programs, typified by accomplishing more than 100 AFTI F-16 flights in a single year. Thus, he recalled, “[t]he X-29’s reliability and this capability led to a very productive flight project. The uniqueness of Dryden is its collective experience across many configurations, speed regimes, systems, and partners.”³⁶

Dryden engineer Robert Clarke, known for his contributions to the X-29’s high-AoA efforts, summed up the program:

I think that most of the players in program know how really unusual it was, but probably not anybody else. This is the only X project where I have seen the prime contractor—Grumman Aerospace—accept help in the flight testing of the airplane from competitors (McAir [McDonnell-Douglas] and TRW provided embedded engineering staff who became part of the X-29 flight test team). The control system analysis group included the best and brightest from Grumman, Honeywell, NASA, AFFTC, AFFDL, U.S. Navy, University of Kansas, etc. This X-plane project is atypical in my experience at NASA DFRC in the diversity of control system analysis and flight test teams—and it worked very well.³⁷

Clarke posited that the X-29 program’s main contribution was “proof that a highly unstable (in the pitch axis) airplane could be safely flown and that classical linear analysis and design techniques would work so well.”³⁸ He elaborated:

Before the airplane was flown there were many who insisted that a non-linear controller would be required. Grumman assisted by NASA DFRC engineers were able to finally make the simple, classical design work in the pitch axis. Early simple analysis proved to be inadequate (low-order actuator models, simple sensor models, no explicit time delays modeled in the analysis, etc.)

Lessons Learned and Research Dissemination

This simplified analysis predicted very good stability margins, but as the model complexity was increased the margins at the critical flight conditions (low altitude transonic was the worst case) evaporated. The design required much additional lead filtering and even the development of near real-time in-flight stability estimation to achieve an adequate flight rate.³⁹

Software engineer Joel Sitz, who came to Dryden as a Honeywell X-29 employee and stayed as a NASA engineer, identified one of the salient reasons that the X-29 team was able to accomplish so much, fly so many missions, and surmount so many issues in its 8-year run. He said professionals from all disciplines, all agencies and organizations, were “working side-by-side in a badge-less environment”⁴⁰ at Dryden. A good working environment was evident at Dryden, and this encouraged and facilitated the X-29’s successes.

An important aspect of the X-29 was its serving as a veritable “teaching tool” for new engineers and technical personnel. Air Force Flight Test Center engineer Fred Webster offered a succinct overview of the value of the X-29 program to his career:

If you ask any old flight tester, you will usually find out that there is one program in their career that really stands out above all the rest. For me that was the X-29. What I learned on that program, from both a technical point of view and from all of the excellent people I worked with stuck with me for the rest of my career (I am nearing retirement). In fact I think I can safely say that the experience I gained from the X-29 really made the rest of my career. I will always be extremely proud of having been involved with that program. I was indeed fortunate.⁴¹

As for the X-29, Webster retains a dispassionate objectivity when he reviews the X-29’s delivery on its promise, noting:

It certainly lived up to the technical capabilities predicted by the engineers to a large extent. I would not necessarily vouch for some of the hype that was out there. Some was put out by the ever-present PR scramble in the search for funding, but I think most was a general perception that such an exotic looking aircraft must surely have equally exotic performance characteristics. In fact, it was just a multiple technology demonstrator and was not designed to be some wiz-bang fighter of the future. I think a lot of folks expected it to be something it was never intended to be.⁴²

Sweeping Forward

Webster tempers some popular perceptions about the X-29, noting:

It did have good roll control power at high AoA as predicted and did maneuver across the envelope as predicted. However, some of the hype about it being the most maneuverable airplane ever due to the large static instability in pitch was always a misconception. The technical predictions never showed that it would be. The notion that large static instability leads to high maneuverability is a common misperception by many folks. Small static instability (*a la* F-16) does help, but since a little is good does not translate into a lot is better! The aircraft was also g limited (at a much lower g than say an F-16 or F-15) since the structure was only static load tested to 100% DLL and we were only allowed to go to 80% of that. So, its g capability was limited relative to other fighter type aircraft at the time. Again, I think the general perception amongst those not knowledgeable about the technical details thought it would do a lot more.⁴³

Did DARPA's original X-29 objective—demonstrating multiple emerging technologies on one airframe—bear fruit? Webster answers with the clarity and candor of a professional flight tester:

Well, there were certainly many emerging technologies demonstrated, and successfully so. Other than that, in the end, we never saw any of the 5th generation⁴⁴ U.S. fighters employing FSW or canards—although I think we also need to keep in mind that at that time, stealth was becoming the 800-pound gorilla, and most of the focus was on that [capability] for a new generation of fighters [e.g., the YF-22 / YF-23 and the JSF (F-35) later]. I think that [stealth] overshadowed some of the potential X-29 technologies. However, we did see high AoA maneuverability become a key player in the F-22. That was an outgrowth of many projects, most utilizing thrust vectoring (X-31, F-18 HARV, F-16 MATV [multi-axis thrust vectoring]) as well as (I think) some of the pioneering work in high AoA maneuvering on the X-29. The X-29 did get to significant high AoA maneuvering capability a little before the others, and without thrust vectoring. I think it at least helped pave the path for looking at maneuvering at high AoA, vice just preventing departure.⁴⁵

Webster's view of X-29 program management is laudatory:

Lessons Learned and Research Dissemination

I don't think the program could have been managed any better than it was. When you consider the number of flights, some of the weekly fly rates (2-3/wk sometimes) *and* that we never had a serious in-flight safety issue...there is no other conclusion than that the entire management team (spread between DARPA, NASA, USAF and Grumman) did an absolutely excellent job. I think everyone who was associated with that program is very proud of not only the work that they did individually, but also as to what was done as a team. You don't get those types of results without top notch management and good leadership.⁴⁶

Grumman pilot Kurt Schroeder reflected on the X-29 team's successful cooperation:

Test pilots are known for their strong personalities, and with individuals from several different agencies, there is always the possibility of conflicts, however on the X-29 program, the associations were seamless. We all supported each other and worked very well together. I would describe the interactions between the various flight test engineers and the pilots in the same manner. Management might want to give credit to their own management skills, but I believe the credit rests with the individuals involved. The demands of the program caused everyone to pull together.⁴⁷

Flying the X-29 demanded a new rationale from test pilots who were accustomed to being masters of their universe. Schroeder, an experienced Grumman F-14 Tomcat tester, explained the differences when he approached the X-29:

The very nature of experimental flight testing involves risk. During development testing of the F-14, there were test points in some areas of the flight envelope (i.e. low altitude/high speed) that if things went drastically wrong, the pilot was unlikely to survive. But for the majority of the testing, any test pilot worth a darn felt he could deal with any potential problems, and if not able to safely recover the airplane, at least abandon it to fly another day. The X-29 however, was a different animal. At least two of the yet-to-be-proven technologies, controlling structural divergence and the high degree of relaxed static longitudinal stability could serve to ruin your whole day. Structural divergence was not something one could nibble on and then back away. If encountered, it would be abrupt and catastrophic. The abrupt failure of the wing would

Sweeping Forward

certainly create an unsurvivable event for the pilot. The level of static longitudinal instability was such that if the flight control computers failed to update the control surface position for less than one second, the airplane would tumble out of control. Once again, the dynamics of the event would not allow the pilot to survive. In either of these situations, the test pilot's confidence in his skills to compensate for the 'shortcomings' of the airplane would not make a shred of difference. He would just be along for the ride. None of the pilots felt these risks were unacceptable. A great deal of effort went into validating and monitoring the flight control system and the flight envelope expansion was accomplished in conservative increments.⁴⁸

Schroeder recalled initially expecting to see the X-29's vital canard moving visibly throughout flight:

The only control surface which could be seen from the cockpit was the canard. Knowing how statically unstable the airplane was, I expected to look out and see the control surface working its little butt off to stabilize the airplane. To the contrary, in non-maneuvering flight, there was no detectible motion. The surface position was being updated 40 times a second, but the amplitude was so small, it couldn't be seen. Small, but VERY important updates.

During the envelope expansion, I happened to have the data point of reaching 20,000 ft for the first time. In my flight report I noted that the point set an altitude record for the X-29. When the peak altitude event occurred for a previous "X" airplane (which happened to be the X-15), the pilot reported he could clearly see the curvature of the earth. I looked, but the same was not true in the X-29. Perhaps it had something to do with the X-15 being at 354,199 ft rather than the X-29's 20,000 ft.⁴⁹

Schroeder reflected on the overall accomplishments of the X-29 program, succinctly encapsulating 8 remarkable years:

First of all, the physical airplane intended to demonstrate the multiple technologies was not specified. Grumman cobbled together surplus parts from existing designs, and built a one-of-a-kind airplane that proved functional and reliable. The Grumman engineers who designed it, and the manufacturing personnel who built it and maintained it could not have done a better job.

Lessons Learned and Research Dissemination

To describe the objectives of the program as “bold,” would be an understatement. There were many naysayers predicting doom. The goals of the various technologies were ambitious, and at least in the general sense, were successfully demonstrated. Some people tend to judge the success of the program by how many of the individual technologies appeared on the next generation of tactical aircraft design. The purpose of a full-scale demonstrator is to provide confidence in the value of any particular technology, reducing the risk of incorporating it into a new design. No contractor would include a forward swept wing into a new design without this assurance. Of all the technologies incorporated in the X-29, I don’t believe any fell into the category of “looked good on paper, but it didn’t work.”

There are several potential mission requirements for which the X-29 configuration would be ideal. However, tactical aviation is an ever-evolving environment, and the emphasis on stealth and the potential use of vectored thrust introduced new design considerations which did not favor the X-29’s technologies. Addressing the “bang for the buck” analysis of the X-29 program, I would ask anyone to describe a technology demonstrator program that included more challenging technologies. The fact that they were successfully demonstrated is icing on the cake.⁵⁰

Glenn Spacht’s career at Grumman began in the 1970s, in the heyday of the F-14, E-2C, and EA-6B programs, and continued through those programs and the X-29 into the company’s merger with Northrop in 1994. During this period, Spacht progressed from a position as an aerodynamics engineer to become the deputy program manager for Grumman on the X-29 and, ultimately, Grumman Vice President of Engineering and Chief Engineer. Through all that time, across all the programs and program exposure and experiences that he had, the X-29 program remains his favorite. “I knew it while it was happening,”⁵¹ he recalled. He remembers thinking, while driving across the Mojave Desert early on a crisp desert morning en route to Dryden, that this program, the X-29, was the best ever. Earlier at Grumman, he was given sufficient latitude to prove the forward sweptwing concept. “I wore out my [Hewlett-Packard] HP-45 [an early and ubiquitous hand-held calculator that accelerated engineering computations in the 1970s] working out the equations saying we needed a forward swept wing.”⁵² Spacht enjoyed working with Grumman engineers as they solved problem after problem and created a clearing in the technological wilderness that allowed the X-29 to happen. If he challenged people by telling his team that others said it could not be done, his

Sweeping Forward

engineers were inspired to prove them wrong, he said. “I just had a terrifically talented group of people,”⁵³ he proudly recalled.

The successful flight in the NASA Langley Full Scale Tunnel of a small FSW demonstrator model reassured Spacht during early design hurdles. More than once, he recalled, when design issues at Grumman seemed daunting, he would remind himself that the model at Langley confirmed it could be done. Answers were always found to the host of variables that attend a project as groundbreaking as the X-29. And Spacht is clear about what he considers to be the driving force—Grumman talent—that made the X-29 succeed. “The design of the airplane is ours...nobody told us what to do,”⁵⁴ he says with clarity. “The airplane was so integrated, nobody else knew how it worked.”⁵⁵ And he has a different take on that than some in the program, who tried to isolate the demonstrated technologies in an effort to quantify the performance of each technology separately. “The airplane was designed as an integrated system,”⁵⁶ Spacht said, adding that the performance of the technologies in isolation did not matter.

Glenn recalled an urgent tension permeating the team as the first X-29 neared its maiden flight at Edwards in late 1984. Spacht said that he and chief X-29 pilot Chuck Sewell “were at each other’s throat all the time because he was sure I was trying to kill him.”⁵⁷ Both had vital responsibilities: one for creating the computer-controlled marvel, the other for making its first flight. “If something went wrong with the control system,” Spacht said, “the airplane would destroy itself in two-tenths of a second.”⁵⁸ Looking back on the developmental path that brought the X-29 to the eve of its first flight, he recalled initial limitations with the computer flight control system’s analog backup mode, admitting that, with hindsight, “[i]f I had it all to do over again it would be quad digital.”⁵⁹ The triple digital primary control computers were able to accommodate the X-29’s entire anticipated flight envelope, but the analog backup would require separate gains to be installed to enable it to bridge different parts of the flight envelope, and Spacht later considered this to be a hindrance that could have been avoided by adding one more layer of redundancy to the digital computers, noting, “[i]f I had it to do over I would never have put the analog system in the airplane.”⁶⁰

But to the credit of its design team and those who fabricated the components of its control system, in 8 years and hundreds of sorties the flight control system never experienced an inadvertent inflight reversion. “The airplane was just perfect in terms of its performance in flight,” Spacht recalled with satisfaction, noting that the X-29 program greatly benefited Grumman’s overall abilities and corporate technical competencies and acumen because “[i]t taught us how to do flight control systems and integration.”⁶¹ Spacht acknowledged DARPA’s contracting mandate that stated that all findings from the X-29 program were to be shared by Grumman for the benefit of the American aerospace

Lessons Learned and Research Dissemination

industry. “We learned a lot and I think we helped the industry a lot...how much I’ll never know.”⁶² And that will be a lasting legacy of the X-29 team—their accomplishments helped inform an industry and give it confidence.

Disseminating Research Results and Lessons Learned

From the outset, X-29 program leaders embraced the need for the timely reporting of results. NASA’s X-29A program plan explained: “Throughout the X-29A program, the practical utility of the various X-29A advanced technologies, both from a military and civilian viewpoint, will be continually assessed and reported on. The timely and efficient communication of the results of these assessments and results of the flight test program to the U.S. aerospace community and to all the military branches is required to insure that beneficial X-29A technologies are truly candidates for inclusion in the next generation of civilian and military aircraft.”⁶³

Mechanisms established to facilitate this ongoing stream of reporting used six basic vectors:

Written flight reports after each flight to summarize test points, configuration and significant observations.

Monthly letter reports summarizing the flight activity and indicating preliminary results.

Government/industry workshops where results are presented at the viewgraph level.

Informal briefings by test team members both at Dryden and at other locations of the preliminary results and conclusions.

A formal symposium will be held within one year after the Phase IV flight program has been completed to document the significant flight research program results.

NASA contractor reports, technical reports, technical memoranda, and Air Force reports and Navy reports will be formally published documenting the program results as necessary during the X-29A program.⁶⁴

Reporting took place in several professional papers presented to the Society of Experimental Test Pilots (SETP) and published in SETP’s annual *Proceedings*. Extracts from these have been cited previously in this work, and they are listed in appropriate notes and bibliography. Numerous technical papers published by the American Institute for Aeronautics and Astronautics (AIAA) further disseminated X-29 information, while NASA and the Air Force Flight Test

Sweeping Forward

Center both produced technical reports, some of which carry caveats on their releasability. Again, a review of the previous chapters in this work includes significant extracts from these, and they are, as well, listed in the notes and bibliographic references.

Detailed AFFTC technical reports captured specific data quantifying what the X-29 team learned during specific program tasks. These reports are not generally publicly available due to distribution caveats to protect the information. They are prepared with unclassified titles, abstracts, and executive summaries that show their essence without revealing their data. These abbreviated versions have long been used by the AFFTC History Office to prepare unclassified narratives on programs like the X-29. The seminal AFFTC technical report (AFFTC-TR-91-15) on X-29 high-AoA flying qualities was published in July 1991, followed 2 months later by AFFTC-TIM-91-02, documenting X-29 high-AoA agility flight-test results.

Recent public release of these documents now expands the available X-29 technical literature. The X-29 high-AoA flying qualities report (AFFTC-TR-91-15) noted:

AERODYNAMICS

A nonlinear flight test based update of the simulation aerodynamic model was successful in providing characteristics closer to the actual aircraft than the original predicted model.

The ground-based predictive methods adequately determined the stability and control trends with angle of attack (AOA), but the accuracy of individual aerodynamic parameter predictions was low. The greatest difference was noted in the longitudinal axis. High AOA aerodynamic prediction methods had a higher degree of uncertainty compared to low AOA prediction capability.

STABILITY AND CONTROL

Good longitudinal stability, control, and maneuvering characteristics below 50 degrees AOA (55 degrees ahead of 446 inches center of gravity) were achieved with a simple pitch rate command flight control system. The maximum pitch rate capability was comparable to other modern fighter type aircraft. Angle-of-attack control during 3-axis maneuvering was considered good, with acceptable pilot workload.

Good lateral-directional stability, control, and maneuvering characteristics up to 45 degrees AOA were achieved with a simple flight control system architecture which was appropriately gain scheduled. The addition of a variable in-flight gain feature allowed

Lessons Learned and Research Dissemination

the test program to maximize the roll performance of the aircraft between 25 and 35 degrees AOA.

The AOA envelope was cleared to 50 degrees for all centers of gravity and to 55 degrees for centers of gravity at or ahead of 446 inches. Clearance above 55 degrees AOA would require further testing since only one maneuver above 55 degrees was accomplished. The lateral-directional maneuvering envelope was cleared for full separate lateral stick or rudder pedal inputs below 45 degrees AOA. The envelope was not cleared for combined lateral stick and rudder pedal inputs.

The proposed minimum nosedown aerodynamic pitching moment (C_m^*) criteria of Reference 8 was not conservative for the X-29 in the presence of noseup inertial coupling. Marginal recovery was encountered above 50 degrees AOA, which had a more nosedown recovery pitching moment than the C_m^* value taken at 65 degrees AOA.

Future programs designed to provide the X-29 with lateral-directional maneuvering above 45 degrees AOA will have to address the low longitudinal recovery capability. Stability axis roll rates above 20 degrees per second across the center of gravity range will not be possible above 50 degrees AOA without providing increased nosedown pitching moment capability.

FLYING QUALITIES

The pilot's overall qualitative assessment of the X-29 indicated that it flew better in the 25 to 45 degree AOA range than current operational fighters. The improvements included precise AOA tracking, loaded rolling capability to 45 degrees AOA, and gradual degradation of aircraft control as AOA increased. These characteristics made the X-29 a natural aircraft to fly up to 45 degrees AOA.

MILITARY UTILITY

Results from the military utility maneuvers indicated the need for cockpit displays at high AOA which would provide the attacking aircraft flightpath relative to the target, as well as accurate target range and closure rate.

Flight control system in-flight gain changes provided an initial look at an increased roll rate capability which showed promise, however, the program was ended before a full evaluation was accomplished. Limited military utility tests were accomplished with the increased roll rate capability. The military utility tests accomplished

Sweeping Forward

indicated that the maneuvers performed should provide a starting point for future high AOA military utility evaluations.⁶⁵

Although some X-29 data was not releasable to foreign nationals, American companies had ready access to the program. McDonnell-Douglas (MD-D) and Ling-Temco-Vought each paid the expenses of an engineer who participated in the X-29 program while simultaneously gleaning information intended to benefit their companies.⁶⁶

In classic Dryden-AFFTC tradition, the same engineers conducting X-29 flight tests also wrote reports. As Air Force pilot Ted Wierzbowski explained in 1986: “Engineering is getting the reports out, but we also have to flight test the airplane and the same guys are doing it. We are under significant pressure to keep flying the airplane.”⁶⁷ While appreciating the need for reports, Wierzbowski had a strong belief in the value of direct discussions to share information: “You’ve got to sit there and you’ve got to talk about it and the guy’s got to understand what you’re saying because a lot of times you may write something down on paper but you’re not really communicating with the person.”⁶⁸

In Conclusion

There is always a danger of oversimplification and stereotyping when trying to summarize a program as complex, groundbreaking, and multifaceted as was the X-29. Nonetheless, several overarching themes emerge from the thousands of pages of documents and interviews used in preparation of this volume: The X-29 FSW aircraft was a bold technological reach that was comprised of equal parts computer power, composite materials, and technical vision. Norris J. Krone’s pioneering theoretical explorations in the 1970s showed it *could* be done; his tenacity in promoting the idea *got* it done. When conceived, the X-29 demonstrator was viewed as a multitechnology test bed whose features could inform the design of the not-yet-defined Advanced Tactical Fighter. But ATF development could not wait on X-29 execution, and when the bold X-29 ran into developmental delays, its ultimate opportunity for influencing ATF design as a flying test bed diminished. It is also possible that the ever-changing dictates of fighter design began to emphasize other priorities, including stealth, even as the X-29’s stated goals were unfolding. Nonetheless, confidence gained from the X-29’s ability to fly with a 35-percent-unstable airframe had broad impact on digital-fly-by-wire advances and the development of control-configured statically unstable aircraft planforms, and it likely encouraged bold fly-by-wire performance improvements on emerging fighter designs. And on a timetable independent of flight testing, the X-29 program used the remarkable Future

Lessons Learned and Research Dissemination

Applications Committee to share X-29 technology developments with others in the U.S. aerospace industry starting before first flight. Grumman Aerospace Corporation showed fortitude, innovation, and expertise in its development of the X-29; that it experienced delays in development should not seem surprising or out of place given the X-29's radical departure from contemporary designs.

The Air Force, NASA, and Grumman each had different flight-test methodologies and practices, and the outcomes and timelines might have been different had a different agency been responsible for conduct of flight test. But NASA was acknowledged by the Air Force Flight Test Center as the most erudite, experienced, and equipped when it came to pure X-plane programs, and the subsequent melding of talent from the Air Force, Grumman, NASA, and other corporations and agencies is remarkable for the volume of work accomplished. It was thus fortunate for the program and the larger aerospace community that NASA (and the NACA previously) had made the investment to create such a center of technical excellence as Dryden because without Dryden and the legacy of flight-testing professionalism extant before the X-29 arrived, the X-29 program would have proceeded more slowly and without the level of confidence and assurance that characterized its entire flight testing and flight research program.

The FSW platform was clearly validated, as was the structural and construction concepts underpinning the design, and the DFBW flight control system proved capable of taming an unstable airplane that the aerospace community could not have successfully designed just a decade previously. Its high-AoA performance exceeded predictions; overall aircraft performance did as well. Validation and calibration of modeling and simulation techniques offered the aerospace profession the documented example of a "real world" program that gave confidence to those pursuing similarly challenging developmental efforts using similar supportive methodologies. Though forward swept wings have been seen only experimentally in the ensuing years (the operational AGM-129 advanced cruise missile being an exception), this concept cannot be ruled out as viable for future projects where unobstructed fuselage volume or other dictates could draw on this technology's advantages. At the end of its life, the X-29 mapped the incredible control that engineers could achieve by harnessing the vortices of air flowing over an aircraft's nose at high angles of attack, opening new opportunities for aircraft controllability.

A generation of NASA engineers worked on the X-29 at Dryden in the 1980s and into the 1990s. Three of them—Ken Szalai, Kevin Petersen, and David McBride—went on to become successive Directors of the NASA Dryden Flight Research Center. Many others, some of whom continue to ply their craft at Dryden as this was written, cut their teeth on the design, and thus the corporate knowledge they gained on the X-29 still serves the American and

Sweeping Forward

global aerospace communities on a daily basis. Thus, in looking to historical legacies, we are left with an experimental aircraft program that set, and attained, a high goal; a program that honed the skills of engineers and all kinds of testers who have used their experience to move the state of the art forward ever since; and a validation of advanced testing and measuring capabilities. And, by no means least, a toolbox full of proven materials, concepts, techniques, and promises available when needed. Just as the X-29 team acknowledged pioneering work by Junkers on the short-lived Ju 287 of World War II, so surely must the next developer of an unstable FSW aircraft gain a view over the horizon by purposefully perching on the shoulders of the giants who accomplished the X-29. The history of X-plane programs is populated with radical designs that shaped and informed the work of subsequent designers or which, at the very least, contributed to the knowledge base underpinning the aeronautical design enterprise. In the urgency of its era, the X-29 delivered more than a full measure on its promise.

Endnotes

1. Wierzbanski, interview by Young.
2. James J. Mattice, "X-29 Forward Swept Wing Predictions vs. Results" (circa March 1986), Wierzbanski X-29 papers and general X-29 files, Air Force Test Center History Office.
3. Ibid.
4. Archie L. Moore and Constance D. Harney, "Development of an Integrated Set of Research Facilities for the Support of Research Flight Test," NASA TM 100427 (May 1988).
5. Wierzbanski, interview by Johnsen.
6. John Retelle, e-mail message to Frederick A. Johnsen, November 21, 2011.
7. Ibid.
8. Retelle, e-mail message to Johnsen.
9. Thomas M. Weeks and Lt. Col. Ted J. Wierzbanski, "X-29 Aims at Applications," *Aerospace America* (February 1986), 44-46, Wierzbanski X-29 papers and general X-29 files, Air Force Test Center History Office.
10. Wierzbanski, interview by Johnsen.
11. The single letter "S-" in the alphanumeric designation S-37 was Sukhoi's way of designating an experimental prototype; operational fighters use the letters "Su-."
12. Craig Covault, "Russian S-37 Accelerates Fighter Technology," *Aviation Week & Space Technology* 152, no. 22 (May 29, 2000).
13. Walker, "X-29A Performance Flight Test Results and Lessons Learned."
14. Trippensee and Lux, "X-29A Forward-Swept-Wing Flight Research Program Status," 5.
15. Tischler, *Advances in Aircraft Flight Control*.
16. Robert Clarke, John J. Burken, John T. Bosworth, and Jeffery E. Bauer, "X-29 Flight Control System: Lessons Learned," NASA TM 4598 (June 1994), 12-8.
17. Ibid.
18. Walker, "X-29A Performance Flight Test Results and Lessons Learned."
19. R.P. Hallion, "Significant Efforts to Blend Research Aircraft Programs with Combat Aircraft Development Programs" (March 1986), Wierzbanski X-29 papers and general X-29 files.

Sweeping Forward

20. David C. Aronstein and Albert C. Piccirillo, *Have Blue and the F-117A: Evolution of the "Stealth Fighter"* (Reston, VA: American Institute of Aeronautics and Astronautics, 1997).
21. Ken Griffin, e-mail message to Frederick A. Johnsen, October 18, 2011.
22. Ibid.
23. Ibid.
24. Ibid.
25. Ibid.
26. James Allburn, interview by Frederick A. Johnsen, circa September, 2011.
27. Ibid.
28. Ibid.
29. Ibid.
30. Jeffrey Bauer, interview by Frederick A. Johnsen, October 21, 2011.
31. Ibid.
32. Kenneth J. Szalai, e-mail message to Frederick A. Johnsen, October 24–25, 2011. He also noted the innovative X-29 vortex flow control flight experiments developed by the Air Force Research Laboratory that closed out the X-29 era in 1992.
33. Ibid.
34. Ibid.
35. Ibid.
36. Ibid.
37. Robert Clarke, e-mail message to Frederick A. Johnsen, January 25, 2012.
38. Ibid.
39. Ibid.
40. Sitz, interview by Johnsen.
41. E-mail, Fred Webster to Frederick A. Johnsen, Oct. 24, 2011.
42. Ibid.
43. Ibid.
44. Fighter aircraft are commonly ranked in technical "generations." The F-4 Phantom II is considered a third-generation fighter; the F-15, F-16, and F/A-18 are fourth generation; and the F-22 and F-35 are fifth generation.
45. E-mail, Fred Webster to Frederick A. Johnsen, October 24, 2011.
46. Ibid.
47. Kurt Schroeder, e-mail message to Frederick A. Johnsen, February 22, 2012.
48. Ibid.

Lessons Learned and Research Dissemination

49. Ibid.
50. Ibid.
51. Spacht, interview by Johnsen.
52. Ibid.
53. Ibid.
54. Ibid.
55. Ibid.
56. Ibid.
57. Ibid.
58. Ibid.
59. Ibid.
60. Ibid.
61. Ibid.
62. Ibid.
63. Sefic, "X-29A Program Plan—Forward Swept Wing (FSW)."
64. Ibid.
65. Frederick R. Webster and Dana Purifoy, "X-29 High Angle-of-Attack Flying Qualities," Air Force Flight Test Center report AFFTC-TR-91-15 (July 1991), 67, Air Force Test Center History Office.
66. Wierzbanski, interview by Young.
67. Ibid.
68. Ibid.



The X-29's futuristic lines are clearly evident in this view of the aircraft high over the Mojave. (NASA)

APPENDIX 1

X-29 Flight Chronology, 1984–1992¹

X-29A-1

Air Force Serial Number 82-0003

Total Flight Time: 200.2 hours

#	Date	Time (hours)	Max. Alt (feet)	Max. Mach	Pilot	Purpose and Comments
1984						
1	Dec. 14, 1984	1.2	15,000	0.43	Charles A. Sewell, Grumman	Functional evaluation of X-29 systems. Instrumentation validation.
1985						
2	Feb. 4, 1985	1.3	15,000	0.56	Sewell	Functional checks, JFS, ² EPU, gear. Touch-and-go, handling qualities (HQ).
3	Feb. 22	1.4	15,000	0.61	Sewell	HQ, ND, DR, AR, ASE. Simulated Flame-Out (SFO).
4	Mar. 1	1.2	15,000	0.60	Kurt Schroeder, Grumman	S&C, ND, DR, AR, ASE, JFS. AoA calibration.
5	Apr. 2	1.4	15,310	0.55	Stephen Ishmael, Dryden	HQ tracking, AR/PA. First NASA flight: pilot familiarization.
6	Apr. 4	1.4	15,516	0.57	Lt. Col. Theodore "Ted" Wierzbanski, USAF	HQ tracking, AR/PA. First Air Force flight, pilot familiarization.
7	Apr. 9	1.5	20,120	0.60	Rogers Smith, Dryden	HQ tracking, AR/ PA. Control-room familiarization and training.

Sweeping Forward

#	Date	Time (hours)	Max. Alt (feet)	Max. Mach	Pilot	Purpose and Comments
8	Apr. 16	1.5	20,376	0.62	Sewell	A/B Take-off, Landing, AR & DR. Functional test.
9	May 21	1.4	30,188	0.61	Schroeder	ASE & FCS stability clearance. Instrumentation; functional test.
10	May 29	1.2	31,237	0.60	Ishmael	ASE & FCS stab clearance, loads. Gyro problems delayed flight.
11	May 29	1.4	30,861	0.60	Wierzbowski	ASE & FCS stab clearance, loads. EPU functional check, JFS check.
12	June 6	1.3	30,831	0.61	Smith	ASE, FCS stab, loads clearance. Flow visualization, formation flying.
13	June 6	1.1	20,200	0.56	Schroeder	ASE, FCS stab, loads clearance. Flow visualization, formation, throttle transients.
14	June 11	1.2	16,108	0.62	Ishmael	Engine-inlet compatibility, loads maneuver envelopes. Formation, flow visualization.
15	June 11	1.4	30,228	0.58	Sewell	Engine-inlet comp., loads. Formation, flow visualization.
16	June 13	1.2	25,374	0.61	Wierzbowski	Flow visualization, loads buildup. Formation, HQ.
17	Aug. 14	1.5	30,000	0.70	Smith	Envelope expansion, check of gun sight. First expanded envelope flight.
18	Aug. 22	1.3	30,000	0.75	Schroeder	Envelope expansion, air-to-air tracking. PAC mode evaluation.
19	Aug. 22	1.2	30,000	0.70	Ishmael	Nz expansion, tracking. PAC mode evaluation.

X-29 Flight Chronology, 1984–1992

#	Date	Time (hours)	Max. Alt (feet)	Max. Mach	Pilot	Purpose and Comments
20	Nov. 1	1.5	40,904	0.80	Wierzbowski	Engine function, envelope expansion. Flap tab shaker functional.
21	Nov. 7	1.4	40,373	0.79	Ishmael	Envelope expansion. Postflight JFS failure.
22	Nov. 19	1.0	40,308	0.83	Smith	Envelope expansion. Oxygen-system anomaly.
23	Nov. 20	0.8	40,561	0.83	Schroeder	Envelope expansion. Roll-rate gyro fail indication.
24	Nov. 27	1.5	40,000	0.90	Smith	MCC functional. Envelope expansion.
25	Dec. 6	1.4	41,113	0.94	Wierzbowski	Envelope expansion. AR mode landing.
26	Dec. 13	1.0	40,000	1.03	Ishmael	Envelope expansion. ITB-2, at 0.85M.
27	Dec. 20	1.0	40,000	1.07	Schroeder	Envelope expansion. ITB-2, at 0.85M.
28	Dec. 20	1.0	40,000	1.10	Wierzbowski	Envelope expansion. ITB-2, at 0.85M.
29	Dec. 20	1.6	40,000	0.95	Smith	ITB-2, 0.95 M/40 KFT. Buffet wind-up-turn 0.6 M/15 KFT.
1986						
30	Jan. 15, 1986	0.3	9,800	0.40	Ishmael	Attitude heading reference system. AHRS failure; flight aborted.
31	Jan. 23	1.3	30,000	0.85	Schroeder	Envelope expansion. High-AoA investigations.
32	Jan. 23	0.7	40,000	1.20	Wierzbowski	Envelope expansion. AR landing with crosswind.
33	Feb. 7	1.0	40,000	1.10	Smith	Maneuver envelope expansion. Early termination for potential loss of range time.
34	Feb. 7	1.0	30,000	0.85	Ishmael	Maneuver envelope expansion. MCC clearance 0.6M/30 KFT.

Sweeping Forward

#	Date	Time (hours)	Max. Alt (feet)	Max. Mach	Pilot	Purpose and Comments
35	Feb. 19	0.7	15,000	0.60	Ishmael	Envelope clearance aborted due to T/M loss. Clearance 0.6M/10 and 15 KFT.
36	Feb. 21	1.3	40,000	1.12	Ishmael	Envelope clearance. MCC clearance 0.6M/20, 30 KFT & 0.7M/40 KFT.
37	Feb. 21	1.4	30,000	0.73	Ishmael	MCC Clearance 0.7 M/20 KFT. HQ; doublets 0.4 M-0.6, 20 KFT & 30 KFT; MCC maneuvers.
38	Feb. 27	1.2	40,000	1.05	Smith	FCS software verification @ 1.05 M/40 KFT. WUT @ 0.85 M/30 KFT.
39	Feb. 27	1.1	40,000	1.10	Wierzbowski	Envelope expansion. ITB-2 @ 1.1 M/40 KFT, 0.9 M/30 KFT.
40	June 10	1.2	40,000	0.95	Schroeder	Alpha/beta nose-boom interaction test. ITB-2 @ 0.8 M/40 and 30 KFT.
41	June 12	0.7	20,000	0.55	Ishmael	High-AoA maneuvering. Fit. cut short due to AHRS failure on rotation.
42	June 12	1.2	30,000	0.95	Ishmael	Load factor expanded. High-AoA maneuvering, MCC clearance.
43	June 12	0.8	40,000	1.30	Smith	High-AoA maneuvering. Envelope expansion.
44	June 12	0.7	40,000	1.30	Wierzbowski	Envelope expansion. Maneuver expansion ITB-1, 2.
45	July 11	1.0	40,000	0.95	Schroeder	MCC clearance. Constant Mach/const AoA WUT.
46	July 15	1.1	40,000	1.20	Wierzbowski	MCC clearance. Envelope expansion; HQDT.
47	July 15	0.7	40,000	1.40	Smith	Envelope expansion in ACC. MCC maneuvering.

X-29 Flight Chronology, 1984–1992

#	Date	Time (hours)	Max. Alt (feet)	Max. Mach	Pilot	Purpose and Comments
48	July 18	0.8	30,000	1.05	Ishmael	Envelope expansion. MCC clearance.
49	July 18	1.0	30,000	1.10	Maj. Harry Walker, USAF	Envelope expansion. HQ evaluation; pilot fam.
50	July 18	0.7	40,000	1.30	Smith	Maneuver expansion ITB-2. MCC expansion.
51	July 24	0.9	40,000	1.20	Schroeder	Envelope expansion, ITBs-1 & 2. Performance WUT @ design point 0.9 M.
52	July 24	0.5	20,000	0.90	Ishmael	Envelope expansion in ND-ACC, AR-UA.
53	July 30	0.7	30,000	1.20	Walker	Continued envelope expansion. Maneuver expansion.
54	July 30	0.7	30,000	1.20	Smith	Envelope expansion. ITB-1, -2.
55	July 30	0.7	30,000	1.30	Schroeder	VMAX 1.3M. Maneuver expansion.
56	Aug. 1	0.5	30,000	1.30	Ishmael	Envelope expansion. VMAX @ FL300 (1.3M).
57	Aug. 1	0.5	30,000	1.30	Schroeder	Maneuver expansion pt. FL300/1.2M.
58	Aug. 1	0.5	30,000	1.20	Ishmael	MCC clearance (FL 300/1.2 M).
59	Aug. 8	0.6	20,000	1.03	Smith	Envelope expansion. Maneuver expansion (FL 200/0.95 M).
60	Aug. 8	0.5	20,000	1.10	Schroeder	Envelope expansion.
61	Aug. 8	0.5	20,000	1.10	Ishmael	Envelope expansion. Maneuver expansion (FL 200/1.05 M).
62	Aug. 8	0.4	20,000	1.175	Smith	VMAX @ (FL 200/1.175 M).
63	Aug. 13	0.7	30,000	1.20	Schroeder	DR investigation (FL200/0.9M). Performance WUTs @ design point.

Sweeping Forward

#	Date	Time (hours)	Max. Alt (feet)	Max. Mach	Pilot	Purpose and Comments
64	Aug. 13	0.6	25,000	1.20	Ishmael	ITB-1, 10 KFT/0.6 M. Maneuver expansion (FL 200/1.1 M).
65	Aug. 13	0.6	25,000	1.20	Smith	Wing-pressure analysis (FL 250/0.925 M). MCC maneuvering, same condition.
66	Aug. 27	0.9	30,000	0.925	Walker	Envelope and maneuver expansion (15 KFT/0.8 M).
67	Aug. 27	0.6	40,000	0.90	Schroeder	Investigation of Dgr normal (FL 400/0.6 M). AHRS failure on rotation.
68	Aug. 27	0.9	15,000	0.90	Schroeder	Envelope expansion.
69	Aug. 27	0.8	15,000	0.85	Ishmael	Envelope and maneuver expansion (10 KFT/0.7 M/0.8 M).
70	Sept. 5	0.7	15,000	0.97	Smith	Envelope expansion.
71	Sept. 5	0.9	20,000	0.97	Walker	Envelope and maneuver expansion (15 KFT/0.95 M), AR.
72	Oct. 24	0.6	30,000	1.03	Schroeder	Validation of normal mode gain change. Buffet WUT (6,800 FT/300 KIAS).
73	Oct. 29	0.5	15,000	1.10	Ishmael	Envelope expansion.
74	Oct. 29	0.5	30,000	1.10	Smith	Envelope expansion, AR. Buffet WUTs (FL 300/0.6 M to 15.6° AoA).
75	Oct. 29	0.7	34,000	0.90	Walker	Envelope expansion. Buffet WUTs (FL 340/0.9 M, FL 290/0.8 M).
76	Oct. 29	0.5	15,000	1.16	Ishmael	VMAX @ 15,000 FT (1.15 M). Envelope expansion.
77	Nov. 7	0.7	43,000	0.95	Schroeder	Envelope expansion. Buffet WUT (FL 400/0.9 M).

X-29 Flight Chronology, 1984–1992

#	Date	Time (hours)	Max. Alt (feet)	Max. Mach	Pilot	Purpose and Comments
78	Nov. 7	0.7	34,000	0.97	Smith	Envelope expansion. Buffet WUTs (FL 300/0.6 M, FL 340/0.9 M).
79	Nov. 7	0.5	8,000	1.03	Walker	Envelope expansion.
80	Nov. 7	0.4	10,000	1.05	Ishmael	Recheck phase/gain @ 8 KFT/1.03 M. Maneuver expansion.
81	Nov. 14	0.4	10,000	1.12	Schroeder	ASE Clearance (10 KFT/1.1 M). VMAX @ 10 KFT (1.12M).
82	Nov. 14	0.4	10,000	1.10	Smith	Envelope expansion completed with ITB-1/2 @ 10 KFT/1.1 M.
83	Nov. 14	1.0	20,000		Walker	Handling qualities evaluation.
84	Nov. 14	1.0	20,000		Ishmael	Handling qualities evaluation.
85	Nov. 19	0.4	15,000	1.05	Walker	Divergence envelope clearance. (15 KFT/1.05 M, 10 KFT/0.85 M).
86	Nov. 19	0.5	10,000	1.05	Ishmael	Divergence envelope clearance. (10 KFT/0.9 M/0.95 M/1.05 M).
87	Nov. 19	0.5	22,000	1.20	Walker	Divergence envelope clearance. (FL 220/1.2 M).
88	Dec. 3	1.0	20,000		Schroeder	Handling qualities evaluation.
89	Dec. 3	0.6	45,000	1.20	Ishmael	Buffet WUTs, MCC research. Shaker functional checkout.
90	Dec. 3	1.1	20,000		Smith	Handling qualities evaluation.
91	Dec. 5	0.6	41,700	1.33	Walker	MCC, loads expansion. Shaker check.
92	Dec. 5	0.8	45,300	1.02	Smith	Buffet, loads expansion. ASE damping with load factor.
93	Dec. 5	0.5	39,200	1.27	Ishmael	Buffet, loads expansion.

Sweeping Forward

#	Date	Time (hours)	Max. Alt (feet)	Max. Mach	Pilot	Purpose and Comments
94	Dec. 5	0.8	25,900	1.09	Schroeder	Loads expansion. ASE damping with load factor, speed stability evaluation.
95	Dec. 10	0.5	41,100	1.43	Walker	Flap flutter. Buffet, loads expansion.
96	Dec. 10	0.6	36,200	1.29	Schroeder	Flap flutter. MCC (10 KFT/0.9 M).
97	Dec. 12	0.5	22,000	1.20	Ishmael	Loads expansion (15 KFT). Buffet, MCC, envelope expansion (15 KFT).
98	Dec. 12	0.6	18,000	1.10	Smith	Loads expansion (10 KFT). Buffet, MCC, envelope expansion (15 KFT).
99	Dec. 17	0.6	47,600	1.45	Walker	Flap flutter, 5 KFT expansion. Repeat MCC points.
100	Dec. 17	0.6	50,200	1.46	Ishmael	Flap flutter, VMAX Tropopause. Envelope expansion (5 KFT).
101	Dec. 17	0.8	20,000	0.90	Smith	Envelope expansion (5 KFT). Speed stability evaluation.
102	Dec. 23	0.8	30,300	1.00	Walker	RAV functional checkout, MCC WUTs. HQDT simulated refueling.
103	Dec. 23	1.1	22,300	0.80	Lt. Cmdr. Ray Craig	Navy evaluation.
104	Dec. 23	1.5	15,500	0.70	Craig	Navy evaluation.
1987						
105	June 19, 1987	0.8	39,500	1.27	Ishmael	Functional flight. AoA/airspeed calibrations. FCS AR mod check.
106	June 26	0.7	31,500	0.996	Walker	AoA/airspeed calibrations. FCS AR mod check, RAV ADI needles.

X-29 Flight Chronology, 1984–1992

#	Date	Time (hours)	Max. Alt (feet)	Max. Mach	Pilot	Purpose and Comments
107	June 26	0.9	46,100	1.39	Ishmael	AoA/airspeed calibrations. FCS AR mod check.
108	June 26	0.8	30,300	1.10	Walker	AoA/airspeed calibrations. Loads.
109	June 30	0.7	31,700	0.985	Smith	AoA/airspeed calibrations. Loads, EPU tests for A/C #2.
110	June 30	0.8	45,150	1.35	Ishmael	AoA/airspeed calibrations.
111	July 24	0.7	46,100	1.01	Schroeder	Aero pressure survey.
112	July 24	0.5	35,970	1.22	Walker	Aero pressure survey.
113	July 24	0.6	25,039	0.91	Smith	Aero pressure survey.
114	July 29	0.4	20,280	1.17	Ishmael	MCC divergence. FCS AR mod check, loads expansion.
115	July 29	0.7	15,080	0.925	Walker	MCC divergence, speed stability evaluation FCS AR mod check, loads expansion.
116	Aug. 5	0.9	45,512	0.94	Smith	MCC divergence.
117	Aug. 5	0.6	27,300	0.95	Ishmael	MCC divergence.
118	Aug. 5	0.6	33,128	0.95	Walker	MCC divergence. Aero pressure survey.
119	Aug. 7	0.5	12,616	1.05	Smith	MCC divergence, aero pressure survey. Loads and fuel flow checks.
120	Aug. 19	0.4	43,677	1.24	Ishmael	Performance.
121	Aug. 19	0.6	50,707	1.21	Walker	Performance.
122	Aug. 19	0.5	37,927	1.21	Smith	Performance.
123	Aug. 19	0.4	33,178	1.23	Ishmael	Performance.
124	Sept. 9	0.7	32,287	0.94	Walker	Performance, loads expansion.
125	Sept. 9	0.6	38,180	1.31	Ishmael	Performance.
126	Sept. 11	0.5	32,432	1.13	Walker	Performance, loads expansion.
127	Sept. 11	1.1	33,596	0.92	Ishmael	Performance, loads expansion.

Sweeping Forward

#	Date	Time (hours)	Max. Alt (feet)	Max. Mach	Pilot	Purpose and Comments
128	Sept. 11	0.7	25,585	1.21	Walker	Performance, loads expansion.
129	Sept. 11	0.9	43,339	1.01	Ishmael	Gust evaluation.
130	Oct. 9	0.6	30,853	1.33	Walker	Performance.
131	Oct. 9	0.4	31,399	1.33	Ishmael	Performance.
132	Oct. 9	0.6	17,325	1.08	Walker	Performance, loads expansion.
133	Oct. 9	0.4	20,415	1.09	Ishmael	Performance.
134	Oct. 14	0.7	39,505	0.97	Walker	Loads expansion, buffet research.
135	Oct. 14	0.8	44,561	0.96	Ishmael	PID (RAV) research.
136	Oct. 14	0.6	40,174	1.01	Walker	ASE alpha evaluation.
137	Oct. 16	0.6	31,221	0.99	Ishmael	ASE ALPHA evaluation, performance.
138	Oct. 16	0.7	39,305	1.13	Walker	PID (RAV) research, buffet research.
139	Oct. 16	0.4	44,815	1.12	Ishmael	Buffet research.
140	Nov. 4	0.9	38,489	0.98	Smith	Asymmetric loads expansion, buffet research.
141	Nov. 6	0.5	37,656	1.27	Walker	Performance.
142	Nov. 6	0.8	40,752	1.04	Ishmael	Asymmetric loads expansion. K-27 gain handling qualities evaluation.
143	Nov. 18	0.7	35,929	0.96	Smith	BLK-VIII FCS functional checkout, asymmetric loads, buffet research.
144	Nov. 18	0.8	33,692	0.96	Walker	Asymmetric loads expansion, buffet research.
145	Nov. 18	0.8	35,146	0.95	William Dana, Dryden	Guest pilot handling qualities evaluation, buffet research.
146	Dec. 2	0.7	34,325	0.96	Ishmael	Performance, K-27 gain HQ evaluation. Speed stability evaluation.

X-29 Flight Chronology, 1984–1992

#	Date	Time (hours)	Max. Alt (feet)	Max. Mach	Pilot	Purpose and Comments
147	Dec. 4	0.6	40,461	1.48	Walker	Performance, asymmetric loads expansion.
148	Dec. 4	0.9	40,802	1.06	Rod Womer, Grumman	New pilot HQ evaluation, asymmetric loads expansion, PID (RAV).
149	Dec. 9	0.6	33,245	1.01	Ishmael	Symmetric/asymmetric loads expansion.
150	Dec. 9	0.6	49,564	1.33	Walker	RAV sweeps, PID (RAV), buffet research.
151	Dec. 9	0.6	34,873	1.31	Womer	PID (RAV), symmetric loads expansion.
152	Dec. 11	0.8	40,822	0.99	Ishmael	Symmetric loads expansion, shaker fairing baseline, buffet research. Engine vibration.
153	Dec. 11	0.6	46,971	1.31	Walker	Symmetric loads expansion PID (RAV).
154	Dec. 11	1.0	30,739	1.21	James W. Smolka, Dryden	Guest pilot HQ evaluation, shaker fairing evaluation. Engine vibration.
155	Dec. 18	0.8	31,594	0.96	Smith	Asymmetric loads expansion PID (AV). FCS sweeps, performance.
1988						
156	Jan. 8, 1988	0.6	22,437	0.98	Ishmael	Asymmetric loads expansion; GW/CG effects on loads. Engine vibration.
157	Jan. 13	0.8	31,425	0.96	Womer	Military utility evaluation. Engine vibration.
158	Jan. 13	0.7	30,562	0.95	Smith	GW/CG effects on loads, military utility evaluation, asymmetric loads expansion. Engine vibration.
159	Jan. 13	0.5	30,199	1.02	Maj. Alan Hoover, pilot	New pilot; HQ evaluation; military utility evaluation. Engine vibration.

Sweeping Forward

#	Date	Time (hours)	Max. Alt (feet)	Max. Mach	Pilot	Purpose and Comments
160	Jan. 22	0.7	31,889	1.03	Walker	Military utility evaluation. Engine vibration.
161	Jan. 22	0.8	32,662	1.01	Hoover	Military utility evaluation. Engine vibration.
162	Jan. 22	0.7	26,937	1.16	Womer	FCS oscillation check, military utility evaluation. Engine vibration.
163	Jan. 27	0.9	37,589	0.94	Smith	Abrupt symmetrical expansion, roll clearance, military utility evaluation. Boost pump check, engine vibration.
164	Jan. 27	0.8	35,391	0.96	Smith	Roll clearance, military utility evaluation, lat/dir PID. Engine vibration.
165	Feb. 5	0.2	26,201	0.96	Ishmael	Aborted due to in-flight TM data dropout.
166	Feb. 12	0.7	30,307	0.94	Hoover	Shaker hydraulic-lines fairings evaluation, PID (RV), FDMS check-out. MCC loads expansion, engine vibration.
167	Feb. 12	0.6	32,924	1.24	Ishmael	Shaker hyd.-lines fairings (removed) evaluation, PID (RAV). Military utility evaluation; MCC loads expansion; engine vibration.
168	Feb. 12	0.7	38,315	1.04	Thomas C. McMurtry, Dryden	Guest pilot, HQ evaluation. Engine vibration.
169	Mar. 16	0.7	31,223	0.97	Smith	Alpha bias roll coupling evaluation, military utility evaluation. ASE alpha evaluation, engine vibration.
170	Mar. 16	0.6	42,983	1.18	Hoover	FCS oscillation check, aero pressure survey. Engine vibration.

X-29 Flight Chronology, 1984–1992

#	Date	Time (hours)	Max. Alt (feet)	Max. Mach	Pilot	Purpose and Comments
171	Mar. 16	1.0	26,399	0.91	Edward T. Schneider, Dryden	Guest pilot, HQ evaluation. Engine vibration.
172	Mar. 23	0.7	44,348	1.11	Womer	Aero pressure survey, ASE alpha evaluation. Loads expansion, engine vibration.
173	Mar. 23	0.6	36,789	1.23	Ishmael	Loads expansion, aero pressure survey. Engine vibration.
174	Mar. 23	0.6	34,406	1.21	Hoover	Loads expansion, aero pressure survey. Engine vibration.
175	Mar. 30	0.7	50,390	1.27	Womer	Loads expansion, MCC divergence (1.20 Mach). Engine vibration.
176	Mar. 30	0.5	48,883	1.26	Ishmael	Loads expansion, MCC divergence (1.20 Mach). Engine vibration.
177	Mar. 30	0.5	33,799	1.20	Womer	Loads expansion, mil utility evaluation MCC divergence (1.20 Mach), engine vibration.
178	Apr. 6	0.5	48,398	1.21	Smith	Loads expansion, MCC divergence (1.20 Mach). Military utility, engine vibration.
179	Apr. 6	0.6	46,670	1.27	Hoover	Loads expansion, MCC divergence (1.20 Mach). Military utility, engine vibration.
180	Apr. 6	0.6	26,674	1.22	Ishmael	Loads expansion, military utility evaluation. Engine vibration.
181	Apr. 13	0.7	17,824	0.89	Womer	Loads expansion, military utility evaluation. Engine vibration.

Sweeping Forward

#	Date	Time (hours)	Max. Alt (feet)	Max. Mach	Pilot	Purpose and Comments
182	Apr. 15	0.5	32,591	1.22	Hoover	Loads expansion, MCC divergence (1.20 Mach), military utility evaluation. Engine vibration.
183	Apr. 22	0.7	26,719	0.87	Ishmael	Loads expansion, military utility evaluation. Engine vibration.
184	Apr. 22	0.5	36,205	1.21	Smith	MCC divergence, (1.20 Mach) military utility evaluation. Engine vibration.
185	Apr. 22	1.0	31,081	1.08	C. Gordon Fullerton, Dryden	Guest pilot HQ evaluation. Engine vibration.
186	Apr. 22	0.5	41,683	1.26	Hoover	MCC divergence (1.20 Mach). Engine vibration.
187	May 20	0.5	33,522	1.24	Ishmael	Block VIII-AC FCF, MCC divergence (1.20 Mach). Speed stability evaluation.
188	May 20	0.5	28,271	1.22	Smith	Block VIII-AC FCF, MCC divergence (1.20 Mach). Speed stability evaluation.
189	May 20	0.4	28,688	1.21	Hoover	Block VIII-AC FCF, MCC divergence (1.20 Mach).
190	May 20	0.3	30,320	1.31	Ishmael	PID (RAV).
191	May 25	0.5	24,808	1.05	Smith	Revised ACC schedule loads evaluation, PID (RAV).
192	May 25	0.6	46,243	1.29	Ishmael	Revised ACC schedule loads evaluation, PID (RAV) wing/canard loads interact.
193	May 25	0.4	29,849	1.21	Smith	Revised ACC schedule loads evaluation, MCC divergence (1.20 Mach). FCS (AR) ITB-1.

X-29 Flight Chronology, 1984–1992

#	Date	Time (hours)	Max. Alt (feet)	Max. Mach	Pilot	Purpose and Comments
194	June 1	0.7	35,551	1.07	Hoover	Wing/canard loads interaction. Performance, minimum landing speeds, buffet, FCS (AR-UA).
195	June 1	0.7	37,530	1.06	Ishmael	Wing/canard loads interaction, buffet, performance. Minimum landing speeds.
196	June 1	0.6	27,610	1.21	Hoover	Wing/canard loads interaction, MCC divergence (1.20 Mach). Loads ACC evaluation, throttle transients.
197	June 8	0.8	29,788	0.96	Smith	Wing/canard loads interaction, BFF, long stick mod evaluation Block VIII-AD K-27 check, throttle transients, min. landing speeds.
198	June 8	0.8	26,078	0.98	Ishmael	Wing/canard loads interaction, long stick mod. evaluation. Min. landing speeds, buffet.
199	June 8	0.8	31,336	0.97	Hoover	Wing/canard loads interaction, long stick mod. evaluation. Performance, min. landing speeds.
200	June 8	0.6	46,225	1.23	Smith	Wing/canard loads interaction, divergence (1.20 Mach), buffet. HQ simulated refueling with KC-135.
201	July 6	0.5	32,992	1.03	Womer	Revised ACC schedule loads evaluation, BFF expansion.
202	July 6	0.4	20,354	1.03	Hoover	Revised ACC schedule loads evaluation, BFF expansion.

Sweeping Forward

#	Date	Time (hours)	Max. Alt (feet)	Max. Mach	Pilot	Purpose and Comments
203	July 6	0.7	37,102	0.96	Smith	Revised ACC schedule loads evaluation, wing/canard loads interaction. Min. landing speeds evaluation, buffet.
204	July 13	0.6	22,977	0.96	Womer	Wing/canard loads interaction, revised ACC schedule loads evaluation.
205	July 13	0.8	31,242	0.94	Hoover	Revised ACC schedule loads evaluation, military utility evaluation. Wing/canard loads interaction.
206	July 13	0.6	31,598	1.20	Smith	Wing/canard loads interaction, military utility evaluation. Min. landing speeds evaluation.
207	July 22	0.6	21,623	1.01	Ishmael	BFF expansion, military utility evaluation, min. landing speeds evaluation.
208	July 22	0.9	23,713	0.82	Lt. Col. Gregory Lewis	Air Force pilot HQ evaluation.
209	July 22	0.8	21,575	1.01	Smith	Revised ACC schedule loads evaluation, gust response (F-104 comparison). Military utility evaluation.
210	July 27	0.4	15,397	0.57	Womer	Smithsonian movie.
211	July 27	1.1	17,061	0.78	Hoover	Smithsonian movie.
212	July 27	0.9	21,904	0.77	Maj. Erwin B. "Bud" Jenschke, Jr.	Air Force pilot HQ evaluation.
213	July 27	0.7	20,688	0.68	Smith	Smithsonian movie.
214	Oct. 6	0.6	30,580	0.63	Hoover	FCS/ASE expansion (BLK VIII-AF).
215	Oct. 12	1.0	16,411	0.81	Smith	FCS/ASE expansion (BLK VIII-AF), loads/FQ clearance (BLK VIII-AF).
216	Oct. 12	0.8	16,441	0.92	Womer	Same as flight 215.

X-29 Flight Chronology, 1984–1992

#	Date	Time (hours)	Max. Alt (feet)	Max. Mach	Pilot	Purpose and Comments
217	Oct. 12	1.0	22,518	0.96	Smith	Same as flight 215.
218	Oct. 18	0.6	21,250	0.96	Hoover	Loads clearance (BLK VIII-AF), air show practice.
219	Oct. 18	0.8	20,223	0.90	Smith	Loads/FQ clearance (BLK VIII-AF).
220	Oct. 18	0.8	20,587	0.96	Hoover	Loads/FQ clearance (BLK VIII-AF), buffet research.
221	Oct. 20	0.7	40,006	0.97	Womer	Buffet research, loads clearance, formation HQ.
222	Oct. 20	0.8	16,982	0.87	Hoover	FCS HQ clearance, air show practice, gust response (F-104 comparison).
223	Nov. 3	0.8	21,404	0.95	Smith	JFS in-flight start, loads clearance and fcs evaluation (BLK VIII-AF).
224	Nov. 3	1.0	23,432	0.85	Lt. Col. Jeffrey Riemer	Air Force pilot HQ evaluation.
225	Nov. 3	0.9	20,804	0.88	Womer	Loads clearance and FCS evaluation (BLK VIII-AF), gust response (F-104 comparison). Formation HQ evaluation.
226	Nov. 9	0.4	12,235	1.11	Hoover	Loads clearance (BLK VIII-AF), BFF expansion. ³
227	Nov. 9	0.6	32,457	1.04	Smith	Loads clearance (BLK VIII-AF), BFF expansion, buffet research. Military utility (agility).
228	Nov. 9	0.6	40,518	1.26	Hoover	Wing/canard loads interaction study, buffet research, military utility (agility).
229	Nov. 9	0.8	20,295	0.88	Smith	Military utility (agility), A/A, A/G. Formation HQ.
230	Nov. 15	0.8	21,292	0.86	Hoover	Military utility (agility, A/A, A/G w/ ATLAS system and formation HQ).

Sweeping Forward

#	Date	Time (hours)	Max. Alt (feet)	Max. Mach	Pilot	Purpose and Comments
231	Nov. 15	0.9	19,602	0.81	Smith	Buffet research, military utility, air-to-ground (ATLAS), ground effects research. Formation HQ, ASE research.
232	Nov. 15	0.8	20,570	0.96	Hoover	Buffet research, loads roll clearance, military utility (agility & A/A).
233	Nov. 18	0.5	41,675	1.21	Smith	Wing/canard loads interaction study, supersonic roll expansion, military utility (agility). SFO.
234	Nov. 18	1.0	22,720	0.92	Maj. Dana D. Purifoy	Air Force pilot HQ evaluation.
235	Nov. 18	0.8	24,060	0.89	Hoover	Military utility (agility). SFO.
236	Nov. 23	0.8	20,599	0.87	Ishmael	Military utility (agility, formation HQ, A/G with ATLAS system).
237	Nov. 23	0.9	23,402	0.84	Smith	Military utility (agility and A/G with ATLAS system).
238	Nov. 23	0.5	26,892	1.21	Hoover	Military utility (agility), wing/canard loads interaction study, supersonic roll clearance.
239 ^a	Dec. 8	0.5	32,527	1.01	Ishmael	Military utility (agility), HQ (A/A tracking, loads-negative-g expansion).
240	Dec. 8	0.9	25,611	0.84	Col. John M. Hoffman	Air Force pilot HQ evaluation.
241	Dec. 8	0.8	20,838	0.92	Lt. Gen. David J. McCloud	Air Force pilot HQ evaluation.
242	Dec. 8	0.5	33,163	0.97	Smith	Military utility (agility), HQ (A/A tracking), buffet research, wing/canard interaction study. Aircraft placed in flyable storage.

X-29 Flight Chronology, 1984–1992

#	Date	Time (hours)	Max. Alt (feet)	Max. Mach	Pilot	Purpose and Comments
1990						
243	June 15, 1990	0.7	33,598	0.95	Ishmael	Function checks for air show ferry flights: ECS, FCS modes, PTO shaft, RAV, JFS, EPU, engine, aero, loads.
244	June 15	1.2	44,966	1.01	Purifoy	Functional checks for air show ferry flights: rudder trim, cruise performance, JFS, engine, aero & loads, speed stability.
245	June 27	1.0	44,900	0.94	Smith	Functional checks for air show ferry flights: loads, cruise performance. FCS research.
246	June 27	1.1	41,200	1.01	Ishmael	Practice for air show ferry flights. Cruise performance, project appreciation maneuvers.
247	July 17	1.0	44,900	0.93	Purifoy	Functional checks for air show ferry flights: engine, cruise performance. FCS research.
248	July 18	1.1	41,000	0.90	Ishmael	Dayton air show deployment flight, Edwards, CA, to Albuquerque, NM.
249	July 18	1.2	41,000	0.90	Smith	Dayton air show deployment flight, Albuquerque, NM, to Tulsa, OK.
250	July 18	1.3	41,000	0.90	Purifoy	Dayton air show deployment flight, Tulsa, OK, to Dayton, OH.
251	July 23	1.1	41,000	0.90	Womer	Oshkosh air show deployment flight, Dayton, OH, to Oshkosh, WI.

Sweeping Forward

#	Date	Time (hours)	Max. Alt (feet)	Max. Mach	Pilot	Purpose and Comments
252	Aug. 5	1.3	41,000	0.90	Ishmael	Dayton/Oshkosh air show return, Oshkosh, WI, to Wichita, KS.
253	Aug. 5	1.2	41,000	0.90	Smith	Dayton/Oshkosh air show return, Wichita, KS, to Albuquerque, NM.
254	Aug. 5	1.2	41,000	0.90	Ishmael	Dayton/Oshkosh air show return, Albuquerque, NM, to Edwards, CA.

X-29A-2

Air Force Serial Number 82-0049

Total Flight Time: 96.2 Hrs.

#	Date	Time (hrs.)	Max. Alt (feet)	Max. Mach	Max LD FAC (g)	Max Alpha (Deg)	Pilot	Purpose and Comments
1989								
1	May 23, 1989	0.9	29,100	0.65	4.4	15.0	Ishmael	Pilot qualification, FCS clearance, systems evaluation & SFO practice.
2	June 13	0.9	30,100	0.97	5.6	18.5	Hoover	Pilot qualification, FCS clearance, systems evaluation & SFO practice.
3	June 13	1.1	26,000	0.84	5.4	12.0	Ishmael	Loads check; EPU check & high-speed spin-chute deployment.
4	June 23	1.0	30,300	0.83	3.1	18.5	Hoover	FCS clearance, low-speed spin-chute deployment, engine-throttle transients & SFO practice.
5	Jun 23	1.1	30,300	0.87	3.0	13.5	Smith	Pilot qualification, FCS clearance, engine-throttle transients, speed stability, PAC evaluation & SFO practice. End Phase 1 functional flights.
6	Oct. 11	0.9	20,300	0.81	5.3	12.2	Womer	Pilot qualification, RAV checkout, air data calibration, FCS clearance & SFO practice.

Sweeping Forward

#	Date	Time (hrs.)	Max. Alt (feet)	Max. Mach	Max LD FAC (g)	Max Alpha (Deg)	Pilot	Purpose and Comments
7	Oct. 11	0.9	30,000	0.95	5.9	16.2	Ishmael	RAV checkout, air data & radar calibration, FCS clearance & SFO practice. End Phase 2 functional flights.
8	Oct. 19	1.0	37,900	0.83	3.1	22.7	Hoover	1 g ITB-1 expansion to 20° AoA; SFO practice.
9	Nov. 8	1.0	38,900	0.91	3.1	24.2	Smith	1 g ITB-1 expansion to 22.5° AoA; 1 g ITB-2 expansion to 10° AoA; SFO practice.
10	Nov. 8	1.1	38,200	0.87	3.1	24.7	Womer	Same as flight 9.
11	Nov. 28	0.7	39,000	0.90	2.9	29.7	Ishmael	1 g ITB-1 expansion to 27.5° AoA, in-flight abort due to TM data loss.
12	Dec. 19	0.9	38,400	0.82	3.0	32.0	Hoover	1 g ITB-1 expansion to 30° AoA, 1 g ITB-2 expansion to 15° AoA.
1990								
13	Jan. 4, 1990	0.7	39,200	0.93	3.1	39.0	Smith	1 g ITB-1 expansion to 35° AoA.
14	Jan. 4	0.9	38,100	0.91	3.0	36.0	Womer	1 g ITB-2 expansion to 15°, 19°, 25° AoA.
15	Jan. 11	0.9	38,200	0.90	3.0	43.0	Ishmael	1 g ITB-1 expansion to 40° AoA, 1 g ITB-2 expansion to 30° AoA. In-flight abort due to jam of chute-jettison handle.
16	Jan. 25	0.9	39,000	0.87	3.5	42.0	Hoover	WUT ITB-1 expansion to 10°, 15°, and 20° AoA.

X-29 Flight Chronology, 1984–1992

#	Date	Time (hrs.)	Max. Alt (feet)	Max. Mach	Max LD FAC (g)	Max Alpha (Deg)	Pilot	Purpose and Comments
17	Jan. 25	1.0	37,400	0.90	3.1	42.0	Smith	WUT ITB-2 expansion to 10° AoA; flow visualization.
18	Jan. 25	1.1	38,900	0.81	3.0	31.0	Purifoy	Pilot familiarization.
19	Feb. 1	0.8	41,300	0.90	3.0	50.5	Womer	1g ITB-1 expansion to 45° AoA. In-flight abort due to high winds & blowing sand.
20	Feb. 8	0.9	38,400	0.92	3.8	48.0	Ishmael	1 g directional control check at 45° AoA; 1 g ITB-2 expansion to 35° AoA, WUT ITB-1 expansion to 25° AoA.
21	Feb. 8	1.1	38,000	0.95	3.1	51.5	Hoover	Flow visualization.
22	Feb. 8	1.1	37,500	0.85	3.1	46.5	Smith	Flow visualization; WUT ITB-2 expansion to 15° AoA.
23.	Feb. 15	1.0	39,600	0.94	3.2	55.5	Smith	1 g directional control check at 50° AoA, 1 g ITB-1 expansion to 45° AoA, engine expansion.
24	Feb. 15	0.9	38,300	0.92	3.1	53.5	Hoover	1 g directional control check at 50° AoA, 1 g ITB-2 expansion to 40° AoA, engine expansion.
25	Feb. 15	0.9	38,500	0.84	3.7	40.8	Purifoy	Pilot familiarization, high-AoA qualitative evaluation. In-flight abort due to MCR shutdown.

Sweeping Forward

#	Date	Time (hrs.)	Max. Alt (feet)	Max. Mach	Max LD FAC (g)	Max Alpha (Deg)	Pilot	Purpose and Comments
26	Mar. 9	0.7	39,700	0.90	3.5	52.8	Ishmael	1 g directional control expansion to 50° AoA, 160 KCAS/WUT ITB-1 expansion to 35° AoA & ITB-2 expansion to 25° AoA, 200 KCAS/WUT ITB-1 expansion to 20° AoA.
27	Mar. 9	0.4	40,600	0.85	3.4	55.5	Womer	1 g directional control checks at 50° AoA; 200 KCAS/WUT ITB-1 expansion to 25° AoA & ITB-2 expansion to 15° AoA, MIL engine expansion. In-flight abort due to alpha failure on recovery from 50° AoA.
28	Mar. 9	1.0	41,200	0.90	3.8	31.3	Smith	200 KCAS/WUT ITB-1 expansion to 25° AoA, MIL engine expansion, in-flight variable gain (90 percent K2: p/δa) test.
29	Mar. 22	0.9	40,100	0.89	3.1	53.0	Purifoy	Pilot familiarization at 45° and 50° AoA; 200 KCAS/WUT ITB-1 expansion to 25° AoA & ITB-2 expansion to 15° AoA.

X-29 Flight Chronology, 1984–1992

#	Date	Time (hrs.)	Max. Alt (feet)	Max. Mach	Max LD FAC (g)	Max Alpha (Deg)	Pilot	Purpose and Comments
30	Mar. 22	1.0	40,400	0.88	3.2	51.0	Ishmael	PID/aero doublets at 35°, 45°, and 50°AoA; 1 g ITB-3 expansion to 20°, 25°, 30° and 35° AoA; AB engine expansion.
31	Mar. 29	1.0	42,100	0.92	5.6	42.5	Womer	FCS software functional check; 1 g ITB-3 expansion to 20°, 25°, 30° and 35° AoA; in-flight variable gain (80 percent K2: p/δa) test.
32	Mar. 29	0.9	40,100	0.92	3.3	32.5	Smith	In-flight variable gain (80% K2: p/δa) test; 160 KCAS/WUT ITB-1 re-expansion to 35° AoA.
33	Mar. 29	0.9	39,800	0.87	4.0	44.0	Purifoy	In-flight variable gain (80% K2: p/δa) test, 160 KCAS/WUT ITB -1 re-expansion to 25° AoA.
34	Apr. 11	0.8	40,200	0.92	3.6	31.5	Ishmael	160 KCAS/WUT ITB-2 expansion to 25°AoA; 200 KCAS/WUT ITB-1 expansion to 25° AoA.
35	Apr. 17	0.5	39,900	0.90	5.7	40.5	Smith	160 KCAS/WUT ITB-2 expansion to 30° AoA; 160 KCAS/WUT ITB-3 expansion to 15°, 20°, 25°, and 30° AoA. In-flight abort due to left outboard flap failure light during 30° AoA roll.

Sweeping Forward

#	Date	Time (hrs.)	Max. Alt (feet)	Max. Mach	Max LD FAC (g)	Max Alpha (Deg)	Pilot	Purpose and Comments
36	Apr. 17	0.9	42,600	0.90	6.3	41.8	Womer	Variable gain test (80 percent & 100 percent K2:p/δa) 1g ITB-1 expansion to 30° AoA, ITB-2 expansion to 30° AoA; AB engine expansion.
37	Apr. 17	0.7	40,300	0.85	3.2	47.0	Purifoy	AB engine expansion; 200 KCAS/split-S ITB-1 expansion to 30° and 35° AoA & ITB-2 expansion to 20° AoA. RTB due to left & right out-board flap failure lights during 30° AoA Split-S maneuver.
38	Apr. 27	0.8	38,600	0.93	3.4	32.1	Smith	200 KCAS/Split-S ITB-1 expansion to 30° AoA & ITB-2 expansion to 20° and 25° AoA & ITB-3 expansion to 15°, 20°, & 25° AoA.
39	Apr. 27	1.0	40,600	0.91	4.5	49.9	Womer	Airspeed and static pressure.
40	Apr. 27	0.8	40,400	0.92	3.4	32.5	Smith	Variable gain (80 percent K2:p/δa) 160 KCAS/ITB-2 expansion to 30° AoA & 200 KCAS/ITB-2 expansion to 25° AoA; AB engine expansion.

X-29 Flight Chronology, 1984–1992

#	Date	Time (hrs.)	Max. Alt (feet)	Max. Mach	Max LD FAC (g)	Max Alpha (Deg)	Pilot	Purpose and Comments
41	May 9	0.8	40,400	0.89	5.0	52.6	Ishmael	1 g directional control check at 55° AoA; 200 KCAS/Split-S ITB-1 expansion to 35° AoA; loads clearance.
42	May 9	1.0	40,400	0.81	5.4	50.3	Purifoy	1 g directional control check at 55° AoA; 200 KCAS/Split-S ITB-1 expansion to 35° AoA, ITB-2 expansion to 30° AoA & ITB-3 expansion to 30° AoA; variable gain (80 percent 2:p/δa) 200 KCAS/ITB-2 expansion to 30° AoA; loads clearance.
43	May 9	0.8	40,300	0.93	5.0	67.0	Smith	1 g directional control check at 55° AoA; loads clearance; loads expansion; AB & MIL engine expansion.
44	May 30	0.8	41,600	0.90	3.0	19.7	Womer	Vertical tail loads; engine expansion; agility. In-flight abort due to failure of the spin-chute continuity test.
45	Sept. 6	0.9	38,600	0.91	3.0	40.4	Purifoy	FCS check; AB engine expansion; engine power/trim effects; military utility/agility; RAV sweeps.

Sweeping Forward

#	Date	Time (hrs.)	Max. Alt (feet)	Max. Mach	Max LD FAC (g)	Max Alpha (Deg)	Pilot	Purpose and Comments
46	Sept. 6	1.0	40,300	0.86	4.4	36.2	Womer	Engine power trim effects; military utility/agility; RAV sweeps.
47	Sept. 6	0.8	39,000	0.87	3.3	38.2	Ishmael	AB engine expansion; military utility/agility.
48	Sept. 13	0.9	35,100	0.87	3.1	44.2	Purifoy	AB engine expansion; military utility/ agility; APU ITB-2 expansion to 15° AoA.
49	Sept. 18	1.0	40,000	0.90	3.3	36.2	Womer	Military utility/agility; APU ITB-2 expansion to 20° AoA.
50	Sept. 25	0.7	40,700	0.90	3.7	36.2	Ishmael	Military utility/agility; APU/160 ICAS ITB-2 expansion to 25° AoA.
51	Sept. 25	1.2	40,700	0.91	3.1	37.1	Purifoy	Military utility/agility; APU/160 KCAS ITB-2 expansion to 30° AoA.
52	Sept. 25	1.0	39,100	0.83	3.3	36.4	Smith	Military utility/agility; APU/160 KCAS ITB-2 expansion to 35° AoA.
53	Sept. 26	0.9	40,500	0.93	4.6	47.3	Womer	Military utility/agility; APU/160 KCAS ITB-2 expansion to 35° AoA.
54	Sept. 26	0.7	38,000	0.89	3.8	37.5	Ishmael	Military utility/agility.
55	Nov. 9	0.3	25,900	0.90	4.4	10.0	Smith	Vertical tail loads data; agility maneuvers; MIMO data. In-flight abort due to loss of SOF parameter in MCR.

X-29 Flight Chronology, 1984–1992

#	Date	Time (hrs.)	Max. Alt (feet)	Max. Mach	Max LD FAC (g)	Max Alpha (Deg)	Pilot	Purpose and Comments
56	Nov. 14	1.1	40,900	0.82	3.0	37.0	Purifoy	MIMO data; vertical tail loads data.
57	Nov. 14	1.0	40,300	0.88	3.6	37.3	Smith	Vertical tail loads data; agility maneuvers; MIMO data.
58	Dec. 11	1.0	38,900	0.86	4.4	52.2	Ishmael	FCS software check; low-altitude expansion: 1 g/20° AoA, 160 KCAS/ITB-2/20° AoA, 200 KCAS/ITB-1/20° AoA.
59	Dec. 13	0.8	40,600	0.88	3.7	52.0	Smith	1 g directional control check at 45° and 50° AoA; low-altitude expansion: 200 and 250 KCAS/ITB-2/20° AoA.
60	Dec. 13	0.7	41,200	0.91	4.7	53.0	Ishmael	1 g directional control check at 45° and 50° AoA; low-altitude expansion: 275 KCAS/ITB-2/20° AoA.
61	Dec. 13	0.7	38,500	0.91	4.4	20.5	Smith	Low altitude expansion: 300 KCAS/ITB-2/15° AoA; high-altitude expansion: 230 KCAS/ITB-1/20° AoA.
62	Dec. 18	0.8	40,000	0.91	4.0	52.4	Womer	1 g directional control check at 45°; high-altitude expansion: 230 KCAS/ITB-2/20° AoA; 250 KCAS/ITB-1/20° AoA.

Sweeping Forward

#	Date	Time (hrs.)	Max. Alt (feet)	Max. Mach	Max LD FAC (g)	Max Alpha (Deg)	Pilot	Purpose and Comments
63	Dec. 18	0.8	40,400	0.83	4.7	46.3	Purifoy	1 g directional control check at 45°; high-altitude expansion: 250 KCAS/ITB-2/20° AoA; 275 KCAS/ITB-2/15° AoA; Low-altitude aero data: 250 & 275 KCAS/10°, 15°, & 20° AoA.
64	Dec. 18	0.9	38,800	0.91	4.7	32.2	Smith	ASE check data at 1 g/30°; variable gain functional testing at 1 g, 160 & 200 KCAS/10°, 15°, 20° AoA; high altitude aero data: 300 KCAS/10°, & 15° AoA.
65	Dec. 20	1.1	40,700	0.90	3.0	48.0	Purifoy	1 g directional control check at 45° AoA with variable gain; MIMO data: SFO practice.
66	Dec. 20	1.0	40,200	0.89	3.0	47.5	Smith	1 g directional control check at 45° AoA with variable gain; MIMO data: SFO practice.
1991								
67	Jan. 8, 1991	0.8	40,300	0.94	3.2	52.6	Womer	FCS software check; low-altitude expansion: 1 g/ITB-2/40° AoA; 160 KCAS/ITB-1/25° AoA.

X-29 Flight Chronology, 1984–1992

#	Date	Time (hrs.)	Max. Alt (feet)	Max. Mach	Max LD FAC (g)	Max Alpha (Deg)	Pilot	Purpose and Comments
68	Jan. 18	0.6	26,300	0.77	3.7	45.0	Ishmael	Low-altitude expansion: 1 g/ ITB-2/35° AoA; 1 g/ ITB-1/45° AoA; 160 KCAS/ITB-2/35° AoA; 200 KCAS/ITB-1/30° AoA.
69	Jan. 18	0.7	25,700	0.70	3.8	44.0	Purifoy	Low-altitude expansion: 200 KCAS/ITB-2/30° AoA; 215 KCAS/ITB-1 and ITB-2/30° AoA; 230 KCAS/ITB-1/30° AoA.
70	Jan. 23	0.4	26,100	0.79	4.7	32.5	Smith	Low-altitude expansion: 230 KCAS/ITB-2/30° AoA; 215 KCAS/ITB-2/30° AoA; 250 KCAS/ITB-1/25° AoA.
71	Jan. 23	0.7	44,600	0.92	4.3	31.5	Ishmael	High-altitude expansion: 215 KCAS/ITB-1/30° AoA; 230 KCAS/ITB-1/30° AoA; 0.75 Mach/ ITB-1/30° AoA; low-altitude expansion: 250 KCAS/ITB-2/25° AoA.
72	Jan. 23	0.8	25,500	0.76	3.4	39.0	Smith	Variable gain testing at 1 g, 160, & 200 KCAS/10°–35° AoA & 1 g/10°–30° AoA.

Sweeping Forward

#	Date	Time (hrs.)	Max. Alt (feet)	Max. Mach	Max LD FAC (g)	Max Alpha (Deg)	Pilot	Purpose and Comments
73	Jan. 23	0.7	25,400	0.73	3.6	39.5	Ishmael	Variable gain testing at 1 g/35° AoA, 160 KCAS & 200 KCAS/10°–35° AoA; low-altitude aero data: 250 KCAS/25° AoA.
74	Jan. 25	0.8	26,700	0.77	3.4	46.5	Smith	Variable gain testing at 1 g/10°–45° AoA; agility: 200 KCAS pitch captures.
75	Jan. 25	0.5	23,500	0.62	3.9	39.0	Ishmael	Variable gain testing at 1 g/10°–20° AoA; agility: 200 KCAS pitch captures.
76	Jan. 25	0.7	26,600	0.67	3.8	43.5	Smith	Variable gain testing at 1 g/20°, 25° AoA; agility: 200 KCAS pitch and roll captures.
77	Jan. 25	0.5	26,500	0.69	3.4	42.0	Ishmael	Variable gain testing at 1g/30°, 35° AoA; agility: 200 KCAS pitch captures and roll transients.
78	Jan. 25	0.5	23,200	0.65	3.8	46.0	Smith	Variable gain testing at 160 KCAS/10°, 15° AoA; agility: 200 KCAS roll captures.
79	Feb. 7	0.7	41,500	0.83	3.5	37.0	Purifoy	Engine functional check; WP AFB agility: 180° aileron rolls; military utility: BFM.
80	Feb. 7	0.9	40,100	0.90	3.7	42.0	Ishmael	WP AFB agility: 180° aileron rolls; slow deceleration; theta zoom; abrupt pull-up.

X-29 Flight Chronology, 1984–1992

#	Date	Time (hrs.)	Max. Alt (feet)	Max. Mach	Max LD FAC (g)	Max Alpha (Deg)	Pilot	Purpose and Comments
81	Feb. 7	0.8	30,000	0.79	4.0	30.0	Smith	Variable gain testing at 1g/160, 200, 250 KCAS and at 10°, 15°, 20°, 25° AoA/250 KCAS; military utility: BFM.
82	Feb. 8	0.5	34,900	0.83	3.9	43.8	Ishmael	Military utility: BFM with baseline & variable FCS gains.
83	Feb. 20	0.6	25,600	0.76	4.2	41.0	Purifoy	Agility: 200 KCAS roll captures; military utility: loaded decelerations at 250 & 275 KCAS.
84	Feb. 20	0.9	43,300	0.91	4.4	38.5	Smith	High-altitude expansion: 0.75 Mach/ITB-1/25° AoA & ITB-2/15° AoA; military utility loaded decels. at 275 & 300 KCAS.
85	Feb. 21	0.1	6,000	0.50	2.1	8.0	Ishmael	In-flight abort due to FCC inlet temperature and ECS anomalies.
86	July 24	0.7	38,600	0.92	3.5	42.0	Ishmael	Functional flight: ECS system evaluation; FCS mode switching; 1 g/15°, 30° AoA aero checks; smoke point: 1 g/35° AoA.
87	July 25	0.9	39,200	0.88	3.1	47.0	Purifoy	Functional flight: 1 g/40° & 45° AoA aero checks; smoke point: 1 g/40° AoA.

Sweeping Forward

#	Date	Time (hrs.)	Max. Alt (feet)	Max. Mach	Max LD FAC (g)	Max Alpha (Deg)	Pilot	Purpose and Comments
88	Aug. 6	0.9	39,500	0.94	4.6	51.7	Purifoy	Functional flight: 1 g/50° AoA directional control check; 1 g/15° & 40° AoA aero checks; 0.95 M/23 KFT & 0.60 M/15 KFT ITB-2; 1 g, 15° & 25° AoA/200 KCAS aileron rolls.
89	Aug. 6	0.6	27,200	0.67	3.0	49.0	Ishmael	Functional flight: smoke point: 1 g/25°-50°-25° AoA sweep; forebody pressure: 1 g/15° AoA; variable gain checks: 200 KCAS roll captures @ 1 g, 15° & 25° AoA/TW47 & TW53. In-flight abort due to loss of MCR telemetry data.
90	Aug. 7	0.5	33,700	0.80	3.4	42.0	Ishmael	Functional flight: forebody pressure: 1 g/40° AoA; variable gain checks: 200 KCAS roll captures @ 15° & 25° AoA/TW53; agility: 30° AoA/200 KCAS/TW47 roll captures; BFM with TW47.
91	Aug. 7	0.6	26,600	0.74	4.8	38.5	Purifoy	Agility: 200 KCAS roll captures @ 30° AoA/TW47 & 25° AoA/TW53; BFM with TW47.

X-29 Flight Chronology, 1984–1992

#	Date	Time (hrs.)	Max. Alt (feet)	Max. Mach	Max LD FAC (g)	Max Alpha (Deg)	Pilot	Purpose and Comments
92	Aug. 7	0.4	24,000	0.57	3.1	37.5	Ishmael	Agility: 200 KCAS roll captures @ 25° AoA/TW53; BFM with TW53.
93	Aug. 16	0.8	28,200	0.69	3.0	50.0	Smith	Air data calibration: 1 g deceleration to 50° AoA; forebody pressures & tufts @ 1 g/15°, 20°, 25°, 30°, 35°, 40° & 45° AoA.
94	Aug. 16	0.9	28,500	0.65	3.3	51.0	Smith	Forebody pressures & tufts @ 1 g/50° AoA; smoke point: 1 g/15°–35° AoA sweep; agility: lat. gross acquisition with TW09, TW47, & TW53.
95	Aug. 16	0.7	26,500	0.66	3.2	46.0	Smith	Smoke point: 1 g/15°–35°–15° AoA sweep; agility: 200 KCAS roll captures @ 1 g, 15° AoA/TW53; BFM, rolling scissors with TW47.
96	Aug. 21	0.8	27,500	0.60	3.5	53.5	Purifoy	Tuft data: 1 g deceleration to 50° AoA; 1 g/15°, 20°, 25°, 30°, 35° AoA; smoke point: 1 g/15°–35°–15° AoA sweep; variable gain testing; 200 KCAS roll captures @ 1 g, 15°, 25°, 30° AoA/TW47 & TW09.

Sweeping Forward

#	Date	Time (hrs.)	Max. Alt (feet)	Max. Mach	Max LD FAC (g)	Max Alpha (Deg)	Pilot	Purpose and Comments
97	Aug. 28	0.6	2,400	0.63	3.8	12.0	Ishmael	Air data calibration: tower fly-bys @ 400, 350, 300, 250, 200 KIAS in-flight abort due to loss of MCR telemetry data.
98	Aug. 28	0.8	35,100	0.91	3.0	52.0	Smith	Air data calibration: 0.6 Mach decels. to 50° AoA @ 27.5, 20, 35 KFT; 0.5–0.9 Mach acceleration/deceleration to 20° AoA @ 27.5, 20, 35 KFT; smoke point: 1 g/25° AoA; USAF agility: lat. gross acquisition w/TW09.
99	Aug. 30	0.6	28,300	0.68	3.5	51.5	Ishmael	Forebody pressures; 1 g/20 KFT @ 15°, 20°, 25°, 30°, 35°, 40°, 45°, & 50° AoA; smoke point: 1 g/45° AoA.
100	Aug. 30	0.6	41,300	0.84	3.6	51.5	Smith	Forebody pressures; 1g/40 KFT @ 15°, 20°, 25°, 30°, & 50° AoA; smoke point: 1 g/20° AoA.
101	Aug. 30	0.5	40,500	0.83	3.9	46.5	Ishmael	Forebody pressures: 1 g/40 KFT @ 35°, 40°, & 45° AoA; variable gain testing: 200 KCAS roll captures @ 1 g, 15° AoA/TW47 & TW53; 25° AoA/TW47; 30° AoA/TW09.

X-29 Flight Chronology, 1984–1992

#	Date	Time (hrs.)	Max. Alt (feet)	Max. Mach	Max LD FAC (g)	Max Alpha (Deg)	Pilot	Purpose and Comments
102	Sept. 4	0.5	22,000	0.62	4.1	42.0	Smith	Forebody pressures @ 0.5 Mach: 40 KFT WUT to 15°, 20°, 25°, 30°, 35°, 40° AoA; 20 KFT WUT 15°, 20°, 25° AoA.
103	Sept. 4	0.4	40,300	0.83	4.2	35.5	Ishmael	Forebody pressures @ 0.5 Mach: 20 KFT WUT to 30° AoA; variable gain testing: 200 KCAS roll captures @ 1g, 15° AoA/TW47 & TW53; 25° AoA/TW47; 30° AoA/TW09.
104	Sept. 4	0.7	22,900	0.67	3.7	38.0	Smith	Variable gain testing: 200 KCAS roll captures @ 1 g, 25° AoA/TW09, TW47 & TW53; forebody pressures @ 0.5 Mach: 20KFT WUT to 15°, 20°, 25°, 30° AoA; agility: lat. gross acquisition TW47 & TW53.
105	Sept. 10	1.0	40,300	0.86	2.0	51.5	Ishmael	Forebody pressures & tufts: 1 g deceleration to 50° AoA; 1 g/5°–30° AoA (5° intervals).
106	Sept. 10	0.8	27,600	0.68	3.3	37.0	Smith	Forebody pressures: 200 KCAS/40 KFT WUT to 15°, 20°, 25°, 30°, 35° AoA; smoke point: 1 g/25° AoA.

Sweeping Forward

#	Date	Time (hrs.)	Max. Alt (feet)	Max. Mach	Max LD FAC (g)	Max Alpha (Deg)	Pilot	Purpose and Comments
107	Sept. 10	1.0	40,100	0.83	4.2	53.7	Ishmael	Forebody pressures & tufts: 1 g deceleration to 50° AoA; 1g @ 5°, 10°, 35° AoA; forebody pressures: 200 KCAS/40 KFT WUT to 40° AoA; smoke point: 1 g/15°–35°–15° AoA sweep.
108	Sept. 13	0.9	25,500	0.64	3.0	53.0	Smith	1 g directional control check at 25 KFT/52.5° AoA; ITB-1 @ 45° AoA/20 KFT; level flight deceleration to max AoA in max AB; smoke point: 1 g/30° AoA; variable gain testing: 200 KCAS roll captures @ 1g/TW47; BFM, rolling scissors with TW47.
109	Sept. 13	0.9	25,500	0.64	4.1	52.7	Ishmael	1 g directional control check at 25 KFT/52.5° AoA; ITB-1 @ 45°, 50° AoA/20 KFT; smoke point: 1 g/15°–35°–15° AoA sweep; agility: 200 KCAS APU to 40° AoA.
110	Sept. 13	0.6	25,900	0.77	3.3	51.5	Dana	High-AoA guest pilot evaluation.

X-29 Flight Chronology, 1984–1992

#	Date	Time (hrs.)	Max. Alt (feet)	Max. Mach	Max LD FAC (g)	Max Alpha (Deg)	Pilot	Purpose and Comments
111	Sept. 19	0.7	40,200	0.85	3.5	48.0	Smith	Forebody pressures: 1 g deceleration to 50° AoA; smoke point: 1 g/35° AoA; BFM rolling scissors with TW47, TW53, TW09.
112	Sept. 19	0.8	26,800	0.68	3.8	52.0	Maj. John Rickerson, USAF	High-AoA guest pilot evaluation by pilot from Nellis Air Force Base.
113	Sept. 19	0.5	29,000	0.72	4.0	52.0	Ishmael	Forebody pressures: 1 g deceleration to 50° AoA; smoke point: 1 g/50° AoA; Langley PID; TW47 PID data @ 1 g/15°, 30°, 40° AoA.
114	Sept. 24	0.6	27,800	0.70	3.7	50.0	Smith	TW47 PID data @ 1 g/50° AoA; Langley PID; Forebody pressures: 200 KCAS/40 KFT WUT to 20° AoA; 0.50 Mach/20° AoA spiral dive from 27 KFT; smoke point: 0.50 Mach/25° AoA spiral dive from 27 KFT.
115	Sept. 24	0.7	26,500	0.70	3.7	50.5	Purifoy	TW09 PID data @ 1 g/50° AoA; smoke point: 1 g/40° AoA; BFM, rolling scissors with TW47, TW53: SFO.
116	Sept. 24	0.7	26,100	0.71	3.4	50.0	Schneider	High-AoA guest pilot evaluation.

Sweeping Forward

#	Date	Time (hrs.)	Max. Alt (feet)	Max. Mach	Max LD FAC (g)	Max Alpha (Deg)	Pilot	Purpose and Comments
117	Sept. 26	0.9	31,000	0.74	3.6	50.5	Ishmael	Smoke point: 1 g/15°–35°–15° AoA sweep; forebody pressures: 0.50 Mach/30° AoA spiral dive from 27 KFT; Langley PID; TW35 PID data @ 1 g/45° AoA; roll performance evaluation in TW47 @ 40° AoA; air data calibration: tower fly-bys 350, 300, 250, 200 KIAS.
118	Sept. 26	0.9	27,900	0.73	3.2	68.4	Purifoy	Smoke point: 1 g/52.5° AoA; TW32 & TW35 PID data @ 1 g/45°, 50° AoA; roll perform. Evaluation in TW47 & TW53 @ 40°, 45° AoA; air data calibration: tower fly-bys @ 400, 200 KIAS.
119	Sept. 26	0.9	20,800	0.66	3.7	42.0	Ishmael	Canard streamers @ 1 g/15°–40° AoA; handling qualities in TW09, TW47 & TW53.
120	Sept. 30	0.9	30,200	0.76	3.6	52.0	Smith	Smoke point: 1 g/25°–50°–25° AoA sweep; Langley PID; MIMO/RAV data @ 0.70 Mach/30 KFT; roll performance evaluation in TW47 @ 30°, 35°, 40°, & 45° AoA.

Vortex Flow Control Flights

Note: In 1992, the U.S. Air Force initiated a program to study the use of vortex flow control (VFC) as a means of providing increased aircraft control at high angles of attack when the normal flight control systems are ineffective. The no. 2 aircraft was modified with the installation of two high-pressure nitrogen tanks and control valves with two small nozzle jets located on the forward upper portion of the nose. VFC was more effective than expected in generating yaw (left-to-right) forces, especially at higher angles of attack where the rudder loses effectiveness. VFC was less successful in providing control when sideslip (relative wind pushing on the side of the aircraft) was present, and it did little to decrease any rocking oscillation of the aircraft.

#	Date	Pilot	Time (hrs.)	Purpose and Comments
1992				
121	May 12, 1992	Ishmael	0.5	FCF; nose gear remained down during gear cycle.
122	May 15	Maj. Regis Hancock, Air Force Flight Test Center	0.9	PF; pilot's first X-29 flight.
123	May 27	Ishmael	0.4	First VFC flight, medium nozzles.
124	May 27	Hancock	0.9	VFC.
125	May 29	Fullerton	0.9	VFC; pilot's first high-AoA flight in X-29.
126	May 29	Hancock	0.7	VFC.
127	June 3	Ishmael	0.3	VFC.
128	June 3	Fullerton	0.7	VFC.
129	June 3	Hancock	0.6	VFC.
130	June 10	Ishmael	0.5	VFC.
131	June 10	Fullerton	0.6	VFC.
132	June 10	Ishmael	0.5	VFC.
133	June 10	Fullerton	0.4	VFC.
134	June 12	Hancock	0.6	VFC.
135	June 17	Ishmael	0.5	VFC.
136	June 17	Fullerton	0.6	VFC.
137	June 17	Hancock	0.8	VFC.
138	June 17	Ishmael	0.5	VFC.
139	June 24	Fullerton	0.6	VFC.
140	June 24	Hancock	0.7	VFC; down mode to AR on takeoff.
141	June 24	Fullerton	0.7	VFC.
142	June 24	Hancock	0.5	VFC.

Sweeping Forward

#	Date	Pilot	Time (hrs.)	Purpose and Comments
143	June 24	Fullerton	0.6	VFC.
144	July 1	Ishmael	0.3	VFC; first flight with large nozzles.
145	July 1	Hancock	0.3	VFC.
146	July 1	Fullerton	0.3	VFC.
147	July 1	Hancock	0.3	VFC.
148	July 1	Fullerton	0.4	VFC.
149	July 1	Hancock	0.4	VFC.
150	July 10	Ishmael	0.3	VFC.
151	July 10	Fullerton	0.4	VFC.
152	July 10	Hancock	0.4	VFC.
153	July 10	Ishmael	0.4	VFC.
154	July 10	Fullerton	0.4	VFC.
155	July 10	Hancock	0.5	VFC.
156	July 15	Ishmael	0.4	VFC.
157	July 15	Fullerton	0.5	VFC.
158	July 15	Hancock	0.6	VFC.
159	July 15	Ishmael	0.4	VFC; departure to 68 degrees true AoA.
160	July 24	Fullerton	0.9	VFC; first flight with small nozzles.
161	July 24	Hancock	0.8	VFC.
162	July 24	Ishmael	0.5	VFC.
163	July 24	Fullerton	0.6	VFC.
164	Aug. 12	Fullerton	0.7	VFC; first flight with one modified regulator and medium nozzles installed.
165	Aug. 12	Smith	0.6	GP.
166	Aug. 12	Fullerton	0.7	VFC.
167	Aug. 12	Smith	0.5	GP.
168	Aug. 19	Hancock	0.4	VFC; first flight with both regulators modified and with nonslotted nozzles.
169	Aug. 19	Ishmael	0.4	VFC.
170	Aug. 26	Fullerton	0.4	VFC.
171	Aug. 26	Hancock	0.5	VFC.
172	Aug. 26	Ishmael	0.5	VFC.
173	Aug. 26	Fullerton	0.3	VFC.
174	Aug. 26	Hancock	0.3	VFC.
175	Aug. 26	Ishmael	0.5	VFC.
176	Aug. 26	Fullerton	0.8	VFC; medium nozzles.
177	Aug. 26	Hancock	0.7	VFC.
178	Aug. 26	Fullerton	0.5	VFC.

X-29 Flight Chronology, 1984–1992

#	Date	Pilot	Time (hrs.)	Purpose and Comments
179	Aug. 26	Hancock	0.6	VFC.
180	Aug. 26	Ishmael	0.7	VFC; control room fly-by.
181	Oct. 14	Hancock	0.2	Practice for Edwards Air Force Base annual open house.
182	Oct. 18	Hancock	0.1	Edwards Open House air show demonstration.

Endnotes

1. Sources: Flight logs compiled by the X-29 program supplemented by available flight reports and the flight logs kept in the NASA DFRC Pilots Office.
2. Acronyms are defined and explicated in Appendix 5.
3. Flight #226, new X-29 airspeed record of 665 KEAS (1.11 Mach/5,032 feet).
4. Flight #239, new X-29 negative load factor of -1.9 g (equivalent) and angle of attack of -4.2° were attained at 0.60 Mach/10,000 feet; new X-29 positive load factor of 6.7 g's (equivalent) was attained at 0.95 Mach/20,600 feet.

Sweeping Forward

APPENDIX 2

X-29 Three-View

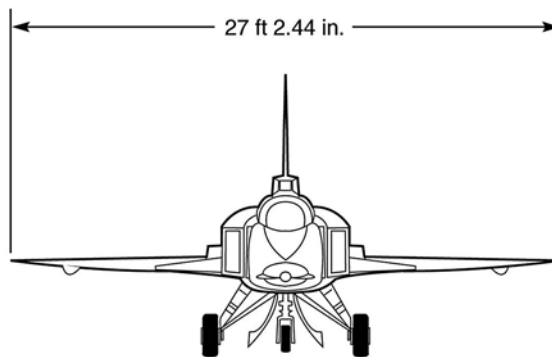
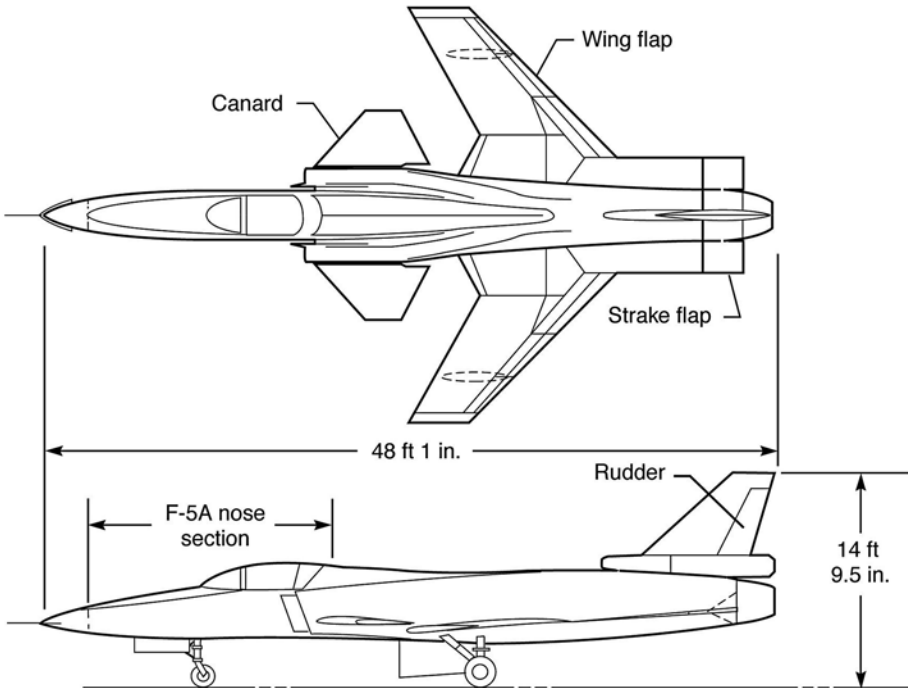

(NASA)

APPENDIX 3

Detailed Description of the Grumman X-29

On August 15, 1984, less than 2 weeks before rollout of the first X-29, Grumman published the X-29 flight manual, noting: “The X-29 is a single-place, forward swept wing demonstrator aircraft manufactured by Grumman Aerospace Corporation, Bethpage, New York. The aircraft is designed to demonstrate the feasibility of the forward swept wing concept. The principal distinguishing characteristics of the aircraft are the forward swept wings, all moveable canards on the forward fuselage, and strakes on the fuselage from the trailing edge of the wings to the end of the fuselage. The aircraft is powered by a General Electric F404-GE-400 turbofan engine with afterburner.”¹ Grumman described the advanced fly-by-wire flight control system, “which is used to stabilize as well as control the aircraft. In flight, the all-moveable canards interact with the forward swept wing to minimize trimmed drag and provide relaxed static stability at subsonic speeds and positive static stability at supersonic speeds.”²

The tightly packed airframe of the X-29 was sensitive to weight gain or loss with equipment changes. The flight manual states, “the zero fuel weight of the aircraft is approximately 17,000 pounds.” For aircraft dimensions, Grumman reports: “The aircraft is 48 feet, 1 inch long. Wing span is 27 feet, 2.44 inches. Distance to the top of the vertical stabilizer is 14 feet, 5 inches.”³

The General Electric F404-GE-400 engine was characterized in the X-29 flight manual as producing maximum thrust in afterburner “in the 16,000 pound class. The aircraft thrust-to-weight ratio is in the 1 to 1 class.” The X-29 could be self-starting: “An aircraft-mounted jet fuel starting unit is used to start the engine.”⁴ Jet engines of an earlier era were characterized by an explosive sound when the afterburner was lit off; newer engines like the F404 overcame this with a sophisticated sequencing of fuel flow quantity to the engine’s afterburner pilot spraybar. This reduced flow would produce ignition that was detected in the engine controls before fuel flow could be advanced significantly. “Since main fuel flow is withheld until a positive lightoff is attained, a hard light should not occur.”⁵

X-29 internal fuel capacity is described in the flight manual: “Fuel is contained in two fuselage bladder type tanks and two integral strake tanks. The aft fuselage tank is designated the feed tank and provides all fuel flow to the

Sweeping Forward

engine. Fuel from the forward fuselage tank and strake tanks flows into the feed tank.”⁶ The feed tank held 1,832 pounds of fuel; the forward tank held 1,809 pounds, and the strake tanks held 337 pounds, giving a fuel total weight listed in the flight manual of 3,977 pounds (possibly a math or fractional rounding error from the individual quantities, which would produce 3,978 pounds when summed). To augment normal positive-g fuel flow operations, the X-29 was designed with a negative-g feature: “The engine feed tank contains a negative g compartment in the aft lower portion of the tank. A negative g valve in the compartment is designed to trap sufficient fuel for 10 seconds of inverted flight at maximum fuel demand.”⁷ Fuel transfer between tanks was normally performed automatically: “In the automatic fuel transfer sequence, the forward fuselage tank empties first, maintaining the feed tank full. Feed tank fuel is then used until 1,000 pounds remain. At 1,000 pounds remaining in the feed tank, strake tanks fuel flows into the feed tank.”⁸ As X-29 pilots reported, the limited internal fuel tankage of the aircraft, unaugmented by aerial refueling, necessitated missions of around 1-hour duration to the occasional detriment of data collection, as time had to be taken to descend, land, refuel, take off, and return to test conditions.

The X-29’s fuel tanks were pressurized with engine bleed air to 2 pounds per square inch, as described in the flight manual. “This is sufficient to meet all normal venting requirements and maintains a constant internal tank pressure to prevent fuel boiloff at altitude.”⁹ For venting the tanks, “the main vent line originates at the front end of the forward tank and terminates overboard on the lower skin of the right strake tank.”¹⁰

The X-29’s remarkable digital-fly-by-wire flight control system and its analog backups were described in the Grumman flight manual: “The flight control system is a computer controlled, fly-by-wire electronic signal system that electrohydraulically positions control surfaces in response to pilot commands. The pilot generates command signals through the control stick, rudder pedals and trim controls.... Control surfaces include midfuselage mounted moveable canards which deflect symmetrically. Roll control is provided by the rudder and two sets of independent flaperons on each wing. The flaperons operate symmetrically for camber control and asymmetrically for roll control.”¹¹ Since fly-by-wire control systems remove the sense of “feel” pilots have grown accustomed to in mechanical flight controls, Grumman installed “feel force bungees to generate feel forces proportional to stick displacement both in pitch and roll axes. The bungees are double acting, thus producing the same force gradient in both directions. An eddy current damper augments control forces by generating forces proportional to control stick velocity. Pilot pitch and roll commands are effected by triply redundant, linear variable, differential transformers (LVDTs). The transformers for pitch, roll, and yaw control are identical.”¹²

Detailed Description of the Grumman X-29

The Grumman manual's description of the X-29's usefully unorthodox flight control surfaces describes the mechanics of their operation:

The flight control surfaces consist of canards, inboard and outboard flaperons, strake flaps, and a rudder. All control surfaces are driven by hydraulically powered servo actuators, each of which receives commands from three flight control computers. The canards operate symmetrically but are independently driven. The drive range is 60 degrees trailing edge up to 30 degrees trailing edge down. The canard actuators have a fail-safe mode which, when armed by the pilot, command the surface to zero degrees when a second failure occurs. The left and right inboard flaperons consist of two sections; the flap, which is driven by a pushrod, and the tab which is slaved to provide 2:1 lead gearing. Each flaperon has its own actuator. The operational surface motion is 13 degrees down and 19.5 degrees up from the nominal maneuver position. The left and right outboard flaperons are divided into two sections, the mid and outboard. Each flaperon consists of two sections: the tab, which is driven by a crank and tab horn, and the flap which is slaved to provide 1:2 lag gearing. Each flaperon has its own actuator. Operational surface motion is identical to the inboard flaperon travel. The flaperons, when armed by the pilot, are automatically commanded to a fail-safe position. With a double failure, the inboard section goes to 3.3 degrees down and the outboard to 5.3 degrees down regardless of the last commanded position. The left and right strake flaps operate independently but symmetrically. Each is powered by its own hydraulic actuator in a travel range of ± 30 degrees. In the fail-safe condition either strake is driven to the 30-degree down position regardless of last commanded position. The rudder is operated by a single hydraulic actuator in response to rudder pedal deflection. It operates in a travel range of ± 30 degrees. In the fail-safe condition, the rudder goes to a position of zero degrees. Failures of the FCS in normal mode of operation are backed up by analog and digital reversion modes which employ only the vital sensors of the FCS to provide adequate control of the aircraft....¹³

The X-29's landing gear consisted of F-5A nose gear and F-16 main gear, each of which retracted and extended independently of the others when the "lollypop" landing gear lever was moved to select gear up or down. Normally an electrohydraulic system, the landing gear had an emergency extension

Sweeping Forward

mechanism that provided pneumatic pressure to extend the main gear, while a mechanical linkage and cable system released the nose gear and opened the nose gear forward door. "Gravity and air loads then extend the nose gear," the Grumman flight manual explained. "The [nose] gear is assisted into the down lock over-center position by spring bungees."¹⁴

Typical to most aircraft, the X-29's brakes were activated on the main-wheels by depressing the toes of the rudder pedals. Equal pressure on both pedals provided uniform braking; differential pressure provided differential braking for deliberate yaw during ground handling. Primary ground steering was provided by nosewheel steering. In the event nosewheel steering proved insufficient for a particular ground maneuver, the Grumman manual states: "If necessary slightly increased turn rate can be achieved by light use of the inside brake."¹⁵ To prevent damage in the wheel wells, the Grumman manual said: "The brakes are applied automatically during the retraction cycle to stop wheel rotation before the wheels enter the wheel well. Prebraking is applied by routing up hydraulic pressure to the prebrake restrictor valve. The prebrake restrictor valve then supplies reduced pressure through the brake shuttle valves to three pistons of each brake."¹⁶

The possibility that engine failure could render the X-29 completely dependent on its limited supply of hydrazine fuel for its emergency power unit was discussed when plans were made for missions that could conceivably exceed the range of the hydrazine (monopropellant) system. Grumman described the emergency power unit in the X-29 flight manual: "When demand exceeds bleed air capability, hydrazine is automatically used to augment system output. If bleed air is not available (engine failure) there is sufficient hydrazine fuel to operate the system for up to 10 minutes."¹⁷ A green light would illuminate on the EPU control panel any time monopropellant was being used to power the unit. The monopropellant worked in a process called "fuel decomposition" in the presence of a catalyst. "The gaseous product of the reaction is used to spin the [EPU] turbine."¹⁸ Gases exhausted by this process were primarily nitrogen, hydrogen, ammonia, and water. "The temperature of gases can approach 1600 degrees F and will ignite in the presence of flame,"¹⁹ the manual cautioned. The finite 10-minute period of hydrazine power production would coincide with an expedited descent to landing with the possibility of an emergency ejection should the hydrazine deplete before the X-29 was safely on the ground.

Vital, though never used, the experimental X-29's pilot ejection system centered around a Martin Baker MK-GRQ7A ejection seat capable of safely removing the pilot from the aircraft in most of its operating regime, including zero speed and zero altitude. On the front of the seat pan, a handle could be accessed between the knees of the pilot. The pilot would pull this handle to initiate the ejection sequence, which would jettison the canopy three-tenths

Detailed Description of the Grumman X-29

of a second before the seat ejection sequence began. A powered inertia reel would automatically pull the pilot's shoulder straps and the pilot's back into the seat to safely restrain the pilot. The flight manual described what followed immediately:

The seat is ejected by action of gas pressure developed within a telescopic ejection gun when the cartridges are ignited. A rocket motor located under the seat pan is fired as the seat leaves the aircraft and sustains the thrust of the ejection gun to carry the seat to a height sufficient for parachute deployment even though ejection may be initiated at zero speed, zero altitude. After ejection, the seat is stabilized and the forward speed is retarded by a duplex drogue system. This is followed by deployment of the personnel parachute.²⁰

Depending on the pilot's size and weight, he could expect to be traveling in the seat at about 65-feet-per-second separation velocity. As the seat would move up the rails of the ejection catapult gun, fittings for oxygen, anti-g suit, and electrical systems would disconnect. Leg restraints would pull taut, keeping the pilot from inadvertently flailing. Automatically, the pilot's emergency oxygen system would activate, as would a time-delay mechanism for drogue-chute deployment. The rocket motor firing mechanism would activate. Less than four-tenths of a second after the pilot pulled the ejection sequence handle on the seat, the drogue gun would fire to deploy the drogue chute to stabilize and decelerate the pilot, who was still strapped to the seat. Then, about 2 seconds into the sequence, the time release mechanism would automatically open the harness locks to release leg restraints, lap belt, and parachute harness. "The drogue chute is also unlatched from the seat to deploy the personnel chute. Line stretch or opening shock of the personnel chute separates the occupant from the seat. The two second delay does not start until the seat/man are below a preset altitude level (13,000 feet)."²¹ The seat carried a manual release should the automatic sequence not operate. "The total time from first motion to line stretch is approximately 2.5 seconds."²²

The Grumman X-29 flight manual described circumstances under which ejection should be used: "Ejection is mandatory under the following conditions, except when unusual circumstances clearly indicate to the pilot that the cause of safety to himself and others will be better served by a flameout approach than by ejection."²³ The normally mandatory conditions included uncontrolled fire, aircraft uncontrollable at an altitude of 10,000 feet AGL or lower, and engine flameout below 1,500 feet AGL and 250 KIAS. The manual advised: "If repeated [engine] relight attempts between 30,000 feet

Sweeping Forward

and 10,000 feet are unsuccessful, eject at 10,000 feet. If still on first or second relight attempt at 10,000 feet and relight appears likely, airstart attempt may be continued to a minimum of 5,000 feet above ground level.”²⁴ If the pilot needed to eject, and still had control of the X-29, he was advised to slow airspeed to 250 KIAS. The ejection seat is an amazing lifesaver, proven in thousands of real-world high-performance-aircraft emergencies over many decades. Nonetheless, its deployment can subject the pilot to risk, and the X-29 flight manual included a warning to pilots: “A natural reaction to reaching down to pull the ejection handle is for the head to move forward, thus placing the spine in a curve which may result in injury on ejection. Make a conscious effort to keep the head back against the headrest. Use both hands to pull the ejection handle. This will tend to keep the arms close to the body and clear of the canopy sills during ejection.”²⁵

As set up by Grumman in 1984, the X-29 flight instrument suite was on the main instrument panel, centered as much as possible in the pilot’s direct field of view. A 5-inch attitude directional indicator (ADI) displayed pitch, roll, and heading information with full freedom about each axis, and it showed flight director and turn-and-slip information. The heart of the visualization for this instrument was a spherical background with a horizon indicator, moving behind a miniature aircraft representation to give the pilot visual cues to the aircraft’s attitude. In the X-29, the ADI received inputs from Flight Control Computer B, including true angle of attack transmitted to the horizontal crosspointer, angle of sideslip to the vertical crosspointer and yaw rate to the rate-of-turn needle. From the X-29’s attitude heading reference system (AHRS), the ADI received inputs including aircraft roll, pitch, and azimuth. The X-29 carried a vertical velocity indicator, standard in most aircraft, that used a needle oriented horizontally for level flight with no vertical velocity component, and which would point up or down from level to indicate the presence of, and rate of, positive or negative vertical velocity up to an instrument limit of 6,000 feet per second.²⁶

The X-29 was fitted with a sensitive Mach meter as described in the flight manual: “The sensitive mach meter is a flight test instrument that permits the pilot to read more precise indications of Mach number required for test purposes. The instrument scale reads from Mach 0 to Mach 2.0 and is graduated in 0.1 increments.”²⁷ For altitude readings, the X-29’s altimeter was electronically informed by signals from Flight Control Computer B. The altimeter had a back-up integral standby aneroid mechanism “that will operate the instrument display in the standby mode when selected or due to a servoed mode failure, presenting pneumatic pressure altitude with normal barosetting correction,”²⁸ the flight manual explained. The X-29’s sensitive airspeed indicator, another special flight-test instrument, enabled the pilot to read precise values

Detailed Description of the Grumman X-29

of indicated airspeed. Unique to the X-29 were two canard position indicators, one for each canard. These 2-inch, circular-faced instruments used a pointer at the nine-o'clock position to indicate zero canard deflection. The indicators could show positive and negative movements through 60 degrees either way of neutral (i.e., greater than actual possible canard deflection). Also unique to the X-29 was the flaperon rudder strake position indicator. This instrument showed seven control surface position indicators on a single instrument.²⁹

Even sophisticated aircraft often have simple emergency backup devices. The X-29s each carried an old-school standby magnetic compass on the upper right portion of the windscreen frame. But where some aircraft have a manual switch to turn pitot heat on or off to keep the pitot mast—an airspeed data sensor—from freezing over, the X-29 had no such controls in the cockpit; pitot heat was turned on automatically once the aircraft's weight-on-wheels sensors detected that the aircraft was in flight. For flight-test precision, the X-29 was fitted with a flight-test accelerometer, angle-of-attack indicator, and angle-of-sideslip indicator. Just as any aircraft has a standardized preflight walkaround procedure as a safety condition check before a mission, the X-29's flight manual depicted a walkaround tour beginning at the left side of the cockpit and circling the aircraft in a clockwise manner. This walkaround was performed to look for tagged pins requiring removal before flight, as well as any skin wrinkling, rivet damage, or fluid leaks that could indicate an unsafe condition from a previous flight.³⁰

The X-29's redundant computer flight control system came with this caution in the Grumman flight manual: "Do not change mode switch from one operational mode to another during maneuvering flight. The separate modes can each be commanding different control surface positions during maneuvering flight and changing modes may induce undesirable transient control inputs."³¹ Presumably, a pilot would suffer any such undesirable control inputs with gratitude in the event that a real-world computer flight control failure during maneuvering flight demanded an immediate reversion to another mode.

Takeoff technique for the X-29 was briefed in the Grumman flight manual to include throttle set at military power. Nosewheel steering could cause problems, according to the manual: "Use of nosewheel steering above 65 KIAS can result in nosewheel shimmy. Use nosewheel steering button on control stick grip until rudder control becomes effective."³² (Rudder effectiveness for an aircraft increases as the aircraft accelerates its takeoff run, with increased slipstream giving the rudder more authority.) The manual called for retracting the X-29's landing gear before the aircraft's speed reached 240 KIAS. (Typically, aircraft landing gear components are not intended to withstand airloads above a certain speed since extended landing gear is only required during lower speeds for takeoff and landing.) For landing, the X-29 pilot was advised (in light or

Sweeping Forward

no crosswind) to “accomplish a normal flare to touchdown and if conditions permit, use aerodynamic braking to conserve brakes and tires.”³³ (Aerodynamic braking typically involves keeping the nosewheel off the runway as long as possible to use drag produced by the wings and exposed area of the fuselage at higher angles of attack to slow the aircraft while minimizing mechanical braking that creates wear and tear on tires and brakes.) Rolling to a stop, if the pilot suspected hot brakes, he was to avoid setting the parking brake until the brakes cooled. Maximum speed for tire rotation on the runway was 200 KIAS.³⁴

An artifact of its timing in the development of the X-29 flight control system, the Grumman manual of August 1984 brackets the aircraft’s performance at a maximum speed of only 350 KIAS with a maximum Mach number of 0.60 and a maximum permissible altitude of 30,000 feet.³⁵ Envelope expansion and flight control system improvements would ultimately remove all of these performance restrictions and enable higher, faster flight exploration.

Endnotes

1. Grumman Aerospace Corporation, *X-29 Flight Manual* (Bethpage, NY: GAC, August 15, 1984).
2. Ibid.
3. Ibid.
4. Ibid.
5. Ibid.
6. Ibid.
7. Ibid.
8. Ibid.
9. Ibid.
10. Ibid.
11. Ibid.
12. Ibid.
13. Ibid.
14. Ibid.
15. Ibid.
16. Ibid.
17. Ibid.
18. Ibid.
19. Ibid.
20. Ibid.
21. Ibid.
22. Ibid.
23. Ibid.
24. Ibid.
25. Ibid.
26. Ibid.
27. Ibid.
28. Ibid.
29. Ibid.
30. Ibid.
31. Ibid.
32. Ibid.
33. Ibid.
34. Ibid.
35. Ibid.

APPENDIX 4

Milestones in Forward Swept Wing Design and X-29 Flight Test

August 18, 1943: First flight of the Cornelius Mallard two-seat experimental forward swept wing (FSW) tailless aircraft, leading to the subsequent Cornelius XFG-1 experimental forward swept wing glider of 1944.

August 16, 1944: First flight of the forward swept wing Ju 287 four-engine jet bomber in Germany.

April 24, 1964: First flight of the forward swept wing Hamburger Flugzeugbau HFB 320 Hansa light twin-engine jet transport, the world's first production forward swept wing aircraft.

During 1975: Air Force Col. Norris Krone of DARPA conceptualizes and proposes building a forward swept wing demonstrator employing extensive composite construction to prevent aeroelastic divergence.

During 1977: DARPA and the Air Force Flight Dynamics Laboratory prepare and then issue proposals calling for a research aircraft to explore potential benefits of a forward swept wing planform.

During 1978: Grumman Design 712 takes form—progenitor of the X-29.

September 1981: X-29 nomenclature applied to DARPA's forward swept wing technology demonstrator study.

December 1981: Grumman awarded contract to build X-29.

August 1982: Grumman proposes a company-operated initial flight test and evaluation program for the X-29 at its Calverton, Long Island, test facility. The idea is not adopted.

Milestones in Forward Swept Wing Design and X-29 Flight Test

August 27, 1982: First components of the X-29 placed in the final assembly fixture at Grumman.

August 27, 1984: X-29 rollout ceremonies at Grumman's Calverton, NY, facility. Vice President George H.W. Bush among 1,000 in attendance.

December 14, 1984: First flight of X-29A number one, Grumman pilot Chuck Sewell.

April 2, 1985: First Government flight, X-29A-1 flight number five, performed by NASA's Steve Ishmael.

October 29, 1985: Limited envelope expansion completed.

November 27, 1985: Longest flight of X-29 program, 1.5 hours, flown by NASA's Rogers Smith.

December 13, 1985: First X-29 supersonic flight, Mach 1.03 attained by NASA pilot Steve Ishmael.

During 1985: First flight of the prototype General Dynamics AGM-129A forward swept wing low-observable air-launched cruise missile.

November 14, 1986: 1 g envelope expansion completed.

December 17, 1986: X-29 makes 100th flight on anniversary of Wright brothers' first flight.

June 8, 1988: 200th flight of X-29 marks the first time an X-plane program achieved 200 flights, flown by NASA's Rogers Smith. Previous record of 199 flights was set by three X-15s.

November 6, 1988: The number two X-29, serial number 20049, reached Edwards Air Force Base and Dryden Flight Research Facility following a month of travel by ship from Grumman in New York through the Panama Canal.

December 8, 1988: Last research flight of X-29A number one aircraft.

May 23, 1989: First flight of X-29A number two, NASA's Steve Ishmael, pilot.

Sweeping Forward

June 13 and June 23, 1989: X-29A-2 spin chute flight tested in preparation for high-AoA work.

October 11, 1989: First flight of Phase Two, high-AoA flight research.

July 1990: X-29A number one returned to flight to attend air shows in Dayton, OH, and Oshkosh, WI, between July 18 and August 5.

January 25, 1991: X-29 sets a record for NASA Dryden flight research aircraft by flying five times in 1 day.

February 21, 1991: The high-AoA program completed by 85 flights, logging a total of 70.9 hours.

July 1, 1992: NASA Dryden record set when X-29 flew six missions in a day for vortex flow control (VFC) study. Limited capacity of nitrogen tank aboard the aircraft necessitated more and shorter flights for VFC for tank replenishment.

August 28, 1992: Last flight of X-29 program, aircraft number two.

APPENDIX 5

X-29 Acronyms and Abbreviations

AA, A/A	Air-to-Air
AB, A/B	Afterburner
A/C	Aircraft
AC	Aerocharacterization (Flow Visualization)
ACC	Automatic Camber Control
ACD	Aerospace Change Directive
ACO	Administrative Contracting Officer
ADFRF	NASA Ames Dryden Flight Research Facility (see also DFRC)
ADI	Attitude Directional Indicator
ADPO	Advanced Development Projects Office
AFB	Air Force Base
AFFDL	Air Force Flight Dynamics Laboratory
AFFTC	Air Force Flight Test Center
AFFTC/HO	Air Force Flight Test Center History Office
AFSC	Air Force Systems Command
AFSRP	Airworthiness and Flight Safety Review Panel (NASA)
AFTI	Advanced Fighter Technology Integration
AFWAL	Air Force Wright Aeronautical Laboratory
AG, A/G	Air-to-Ground
AHRS	Attitude Heading Reference System
Alpha	α , Angle of Attack
AMAD	Aircraft Mounted Accessory Drive
AoA	Angle Of Attack (Also expressed as α or Alpha)
APU	Abrupt Pull-Up
AR	Analog Reversion (Flight Control System operating mode)
AR/PA	Analog Reversion/Powered Approach
AR/UA	Analog Reversion/Up and Away
ARC	(NASA) Ames Research Center
ASD	Aeronautical Systems Division
ASE	Aeroservoelastic/Aeroservoelasticity

Sweeping Forward

ATF	Advanced Tactical Fighter
ATLAS	Adaptable Target Lighting Array System
Beta	β , Angle of Sideslip
BFF	Body Freedom Flutter
BFM	Basic Fighter Maneuver
BIT	Built-in Test
BLK	Refers to software version number or “block” number, as BLK-VIII-AC
CAL	Air-data, INS Calibration
CCB	Configuration Control Board
CDR	Critical Design Review
CDRL	Contract Data Requirements List
CEP	Concept Evaluation Program (or Phase)
CFD	Computational Fluid Dynamics
CFE	Contractor Furnished Equipment
c.g.	Center of Gravity
CLP	Control Law Processor
CO	Calverton Operations (Grumman)
CODN	Code O Data Network
c.p.	Center of Pressure
CTO	Calverton Test Operations (Grumman)
DARPA	Defense Advanced Research Projects Agency
DEL	Direct Electric Link (FCS mode)
DFBW	Digital Fly-By-Wire
DFRF	NASA Dryden Flight Research Facility
DFRC	NASA Dryden Flight Research Center
Dgr normal	Degraded Normal Mode
DoD	Department of Defense
DR	Digital Reversion (FCS operating mode)
DSD	Detailed System Definition
EAA	Experimental Aircraft Association
ECS	Environmental Control System
EE	Envelope Expansion
EIRT	Executive Independent Review Team
EPU	Emergency Power Unit
FAC	Future Applications Committee
FCC	Flight Control Computer
FCF	Functional Check Flight
FCS	Flight Control System
FDMS	Flight Deflection Measurement System
FL	Flight Level

X-29 Acronyms and Abbreviations

FLT or Flt	Flight
FLT CON	Flight Condition
FM	Frequency Modulation
FOD	Foreign Object Damage
FQ	Flying Qualities
FRR	Flight Readiness Review
FSCP	Failure Status Control Panel
FSW	Forward Swept Wing
GAC	Grumman Aerospace Corp.
G or g	Acceleration; 1 g is equal to the force of gravity at sea level
GFE/P	Government Furnished Equipment/Property
GP	Guest Pilot
GSE	Ground Support Equipment
GVS	Ground Vibration Survey
GW/CG	Gross Weight/Center-of-Gravity
HADS	High Accuracy Digital Sensor
HARV	High Alpha Research Vehicle
HQ	Handling Qualities
HQDT	Handling Qualities During Tracking
HQR	Handling Qualities Rating
IBIT	Initiated Built-In Test
ILS	Integrated Logistics Support
ILSP	Integrated Logistic Support Plan
INS	Inertial Navigation System
IOC	Initial Operational Capability
IOP	Input-Output Processor
ISA	Integrated Servoactuator
ITB	Integrated Test Block
JFS	Jet Fuel System
K2: $p/\delta a$	Roll Rate Gain
K-27	Lateral Stick Gain
KCAS	Knots Calibrated Airspeed
KEAS	Knots Equivalent Airspeed
KFT	Altitude in 1,000s of feet
KIAS	Knots Indicated Airspeed
LAT/DIR	Lateral/Directional
L/D	Lift Over Drag Ratio
LONG STICK	Longitudinal Stick
LVDT	Linear Variable, Differential Transformer
MAC	Mean Aerodynamic Chord
MCC	Manual Camber Control

Sweeping Forward

MCR	Mission Control Room
MIL	Military (Power Setting)
MIMO	Minimum Input/Minimum Output
MOA	Memorandum Of Agreement
MU	Military Utility
MSL	Mean Sea Level (altitude as measured from sea level)
NACA	National Advisory Committee for Aeronautics
NADC	Naval Air Development Center
NASA	National Aeronautics and Space Administration
NATC	Naval Air Test Center
NAVPRO	Naval Plant Representative Office
ND	Normal Digital (operating mode)
NTF	National Transonic Facility
Nz	Normal load factor; Acceleration in Z-axis, i.e., “g” or normal acceleration
OFP	Operational Flight Program
ORB	Operational Review Board
PA	Power Approach
PAC	Precision Approach Control
PCI	Physical Configuration Inspection
PCM	Pulse Code Modulation
PDC	Product Development Center (Grumman)
PDR	Preliminary Design Review
PF	Pilot Familiarization
PIO	Pilot Induced Oscillation
POPU	Push Over Pull Up (flight test maneuver)
psi	pounds per square inch
PTO	Participating Test Organization
PTO	Power Take Off
QA/C	Quality Assurance/Control
RAV	Remotely Augmented Vehicle
RDT&E	Research Development Test and Evaluation
ROR	Repair of Repairables
RSPL	Recommended Spare Parts List
RSS	Relaxed Static Stability
RTB	Return to Base
RTO	Responsible Test Organization
S&C	Stability and Control
SAS	Stability Augmentation System
SCSS	Sensor Computer Subsystem
SFO	Simulated Flameout

X-29 Acronyms and Abbreviations

SOF	Safety of Flight, e.g., flight system hydraulic pressure data relating thereto
SRB	Safety Review Board
SVI	Safety Validation Item
TAD	Technology Availability Date
TCTO	Time-Compliance Technical Order
TDT	Transonic Dynamics Tunnel
TIFS	Total In Flight Simulator
T/M, TM	Telemetry
TMN	True Mach Number
TPS	Test Pilot School
TW09, TW47, and TW53	Thumb-Wheel Settings
UA	Up and Away (FCS mode)
USAF	United States Air Force
VDC	Volts, Direct Current
VFC	Vortex Flow Control
VMAX or V_{\max}	Maximum Velocity
VT	Vertical Tail Strain Gauge Data
WATR	Western Aeronautical Test Range
WOW	Weight on Wheels
WPAFB	Wright-Patterson Air Force Base
WUT	Wind-Up Turn (flight test maneuver)

Acknowledgments

An old saw suggests that a sure-fire way to identify your true friends is to move your household across town and see who shows up to help. An author has the same experience, particularly when tackling a subject as challenging as the X-29. Fortunately, in my case I benefited from many, and thus this volume has the figurative fingerprints of a number of individuals and organizations whose support is greatly appreciated.

With apologies to anyone inadvertently overlooked, the list of those who significantly helped includes: Air Force Flight Test Center (AFFTC) History Office (and Jim Young, Jeannine Geiger, Freida Johnson, and Stephanie Smith), AFFTC Technical Library (and Darrell Shiplett), NASA Ames Research Center (and historian Glenn Bugos), NASA Dryden Flight Research Center (especially its remarkably resourceful technical librarian Karl A. Bender, plus Jeffrey Bauer, Robert Clarke, Jay Levine, Peter Merlin, Debbie Rodden, Joel Sitz, and Valerie Zellmer), Jim Allburn, Joseph Gera, Ken Griffin, Dr. Norris Krone (whose seminal research and tenacious advocacy made the X-29 possible), John Retelle, Kurt Schroeder, Rogers Smith (whose patience in explaining complex X-29 issues is a gift), the Society of Experimental Test Pilots (and Becki Hoffman and Paula Smith), Glenn Spacht, Ken Szalai, Fred Webster, Keith Wilkinson, and (slightly out of alphabetical sequence) Ted Wierzbowski.

Ted “W+12” Wierzbowski showed pragmatism, humor, and insight in discussions he and I had about the X-29 program, as well as in lengthy interviews he gave to AFFTC historians when the program was flying. Ted appreciates the work of historians, and he saved boxes of valuable X-29 documentation that are a treasure in the AFFTC history office collection. The body of available X-29 documentation owes much to Wierzbowski’s efforts, as he enthusiastically assumed the role of de facto archivist/historian over much of the X-29 program (including his giving two in-depth interviews to then-AFFTC historians Dick Hallion and Jim Young in the mid-1980s). He kept materials pertinent to the U.S. Air Force, NASA, Grumman, and the Defense Advanced Research Projects Agency (DARPA), preserving breadth and depth in X-29 documentation. The need for attribution in a book of this nature highlights Air Force officer Ted Wierzbowski often. But readers should not infer from this attribution (and Ted would be the first to point this out) too much Air Force influence on the X-29. It was a NASA-led program. Grumman

Acknowledgments

masterfully created the X-29 aircraft, the Air Force supported DARPA and NASA research goals, and all partners achieved success and deserved accolades for their collaborative work on the X-29. But to NASA must go the ultimate credit for leading the X-29 program and nurturing it under NASA's unique mantle as the Nation's aerospace research agent.

And finally, a special word of thanks to Richard P. "Dick" Hallion, whose invitation to write this book set a most ambitious cadence for my first year of retirement. His support complemented that of my wife, Sharon, who knows all too well what the household can be like in the middle of book creation, and yet she still encourages me to write.

Frederick A. Johnsen
March 31, 2012

Sweeping Forward

Selected Bibliography

Books

- Anderson, Seth B. *Memoirs of an Aeronautical Engineer—Flight Tests at Ames Research Center: 1940–1970*. Washington, DC: NASA SP-2002-4526, June 2002.
- Borchers, Paul F., James A. Franklin, and Jay W. Fletcher. *Flight Research at Ames—Fifty-Seven Years of Development and Validation of Aeronautical Technology, 1940–1997*. Moffett Field, CA: NASA SP-1998-3300, 1998.
- Chambers, Joseph R. *Partners in Freedom: Contributions of the Langley Research Center to U.S. Military Aircraft of the 1990s*. Washington, DC: NASA SP-2000-4519, 2000.
- Green, William. *Warplanes of the Third Reich*. Garden City, NY: Doubleday & Co., 1970.
- Hallion, Richard P., ed. *NASA's Contributions to Aeronautics*. Two vols. Washington, DC: NASA SP-2010-570, 2010.
- Hirschel, Ernst Heinrich, Horst Prem, and Gero Madelung, eds. *Aeronautical Research in Germany: From Lilienthal to Today*. Berlin: Springer, 2004.
- History Office. *Splendid Vision, Unswerving Purpose: Developing Air Power for the United States Air Force During the First Century of Powered Flight*. Wright-Patterson AFB, OH: Aeronautical Systems Center, 2002.
- Miller, Jay. *The X-Planes—X-1 to X-45*. Hinckley, England: Midland Publishing, 2001.
- Tischler, Mark B., ed. *Advances in Aircraft Flight Control*. London: Taylor & Francis, 1995.

Wallace, Lane E. *Flights of Discovery—50 Years at the NASA Dryden Flight Research Center*. Washington, DC: NASA SP-4309, 1996.

Key Reports and Papers

Bauer, J.E., R. Clarke, and J.J. Burken. "Flight Test of the X-29A at High Angle of Attack: Flight Dynamics and Controls." NASA TP-3537, 1995.

Bauer, J.E., D.B. Crawford, D. Andrisani II, and J. Gera. "Real-Time Comparison of X-29A Flight Data and Simulation Data." American Institute of Aeronautics and Astronautics (AIAA) Paper 87-0344, 1987.

Bjarke, L.J., J.H. Del Frate, and D.F. Fisher. "A Summary of the Forebody High-Angle-of-Attack Aerodynamics Research on the F-18 and the X-29A Aircraft." NASA TM-104261, 1992. Also presented as Society of Automotive Engineers (SAE) Paper 92-1996, 1992.

Bosworth, J.T. "Linearized Aerodynamic and Control Law Models of the X-29A Airplane and Comparison With Flight Data." NASA TM-4356, 1992.

Bosworth, J.T., and T.H. Cox. "A Design Procedure for the Handling Qualities Optimization of the X-29A Aircraft." NASA TM-4142, 1989.

Bowers, A.H. "X-29A Longitudinal and Directional Force and Moment Supplemental Transonic Wind Tunnel Test Results." NASA TM-85909, 1984.

Budd, G.D. "Locally Linearized Longitudinal and Lateral-Directional Aerodynamic Stability and Control Derivatives for the X-29A Aircraft." NASA TM-84919, 1984.

Budd, G.D. "Predicted Pitching Moment Characteristics of X-29A Aircraft." NASA TM-88284, 1987.

Butts, S.L., and D. Purifoy. "X-29A High Angle-of-Attack Agility Flight Test Results." AFFTC-TIM-91-02, 1991.

Chacon, V., and D. McBride. "Operation of the X-29A Digital Flight-Control System." ARC-12209. *NASA Tech Briefs* 14 (April 1, 1990): 45.

Sweeping Forward

Chin, J., V. Chacon, and J. Gera. "X-29A Flight Control System Performance During Flight Test." AIAA Paper 87-2878, 1987.

Clarke, R., J.J. Burken, J.T. Bosworth, and J.E. Bauer. "X-29 Flight Control System Lessons Learned." NASA TM-4598, 1994. Published subsequently as "X-29 Flight Control System: Lessons Learned." *International Journal of Control* 59, no. 1 (1994): 199–219; and then presented as "X-29 Flight Control Systems: Lessons Learned." NATO, Advisory Group for Aerospace Research and Development (AGARD). *Active Control Technology: Applications and Lessons Learned*. CP-560, 1995.

Connors, T.M. "Measurement Effects on the Calculation of In-Flight Thrust for an F404 Turbofan Engine." NASA TM-4140, 1989. Published subsequently as "Measurement Effects on the Calculation of In-Flight Thrust for an F404 Turbofan Engine." *International Journal of Turbo and Jet Engines* 10 (1993): 107–125.

Cotton, S.J., and L.J. Bjarke. "Flow-Visualization Study of the X-29A Aircraft at High Angles of Attack Using a 1/48-Scale Model." NASA TM-104268, 1994.

Curry, R.E., B.J. Moulton, and J. Kresse. "An In-Flight Investigation of Ground Effect on a Forward-Swept-Wing Airplane." NASA TM-101708, 1989.

Del Frate, J.H., and J.A. Saltzman. "In-Flight Flow Visualization Results From the X-29A Aircraft at High Angles of Attack." NASA TM-4430, 1992. Also presented as AIAA Paper 92-4102.

Earls, M.R., and J.R. Sitz. "Initial Flight Qualification and Operational Maintenance of X-29A Flight Software." NASA TM-101703, 1989. Also presented as AIAA Paper 89-3596.

Fisher, D.F. "Six Decades of Flight Research: An Annotated Bibliography of Technical Publications of NASA Dryden Flight Research Center, 1946–2006." NASA TP-2007-213684, 2007.

Fisher, D.F., D.M. Richwine, and S. Landers. "Correlation of Forebody Pressures and Aircraft Yawing Moments on the X-29A Aircraft at High Angles of Attack." NASA TM-4417, 1992. Also presented as AIAA Paper 92-4105.

Selected Bibliography

- Gera, J. "Dynamics and Controls Flight Testing of the X-29A Airplane." NASA TM-86803, 1986. Also presented as AIAA Paper 86-0167.
- Gera, J., D. Andrisani II, J. Bauer, and D.B. Crawford. "Real-Time Comparison of X-29A Flight Data and Simulation Data." *Journal of Aircraft* 26, no. 2 (February 1989): 117–123.
- Gera, J., and J.T. Bosworth. "Dynamic Stability and Handling Qualities Tests on a Highly Augmented, Statically Unstable Airplane." NASA TM-88297, 1987. Also presented as AIAA Paper 87-2258.
- Gupta, K.K., M.J. Brenner, and L.S. Voelker. "Integrated Aeroservoelastic Analysis Capability With X-29A Analytical Comparisons." AIAA Paper 87-0907 (1987). Published subsequently as "Integrated Aeroservoelastic Analysis Capability With X-29A Comparisons." *Journal of Aircraft* 26, no. 1 (January 1989): 84–90.
- Guyton, R.W., and G. Maerki. "X-29 Forebody Jet Blowing." AIAA 92-0017, 1992.
- Hancock, R., and G. Fullerton. "X-29 Vortex Flow Control Tests." In *1992 Report to the Aerospace Profession*, 209–219. Lancaster, CA: Society of Experimental Test Pilots, 1992.
- Hicks, J.W., James M. Cooper, Jr., and Walter J. Sefic. "Flight Test Techniques for the X-29A Aircraft." NASA TM-88289, 1987.
- Hicks, J.W., and T. Huckabone. "Preliminary Flight-Determined Subsonic Lift and Drag Characteristics of the X-29A Forward-Swept-Wing Airplane." NASA TM-100409, 1989.
- Hicks, J.W., J. Kania, R. Pearce, and G. Mills. "Challenges in Modeling the X-29 Flight Test Performance." NASA TM-88282, 1987.
- Hicks, J.W., and N.W. Matheny. "Preliminary Flight Assessment of the X-29A Advanced Technology Demonstrator." NASA TM-100407, 1987. Also presented as AIAA Paper 87-2949.
- Hicks, J.W., and K.L. Petersen. "Real-Time Flight Test Analysis and Display Techniques for the X-29A Aircraft." NASA TM-101692, 1988.

Sweeping Forward

- Iloff, K.W., and K.C. Wang. "X-29A Lateral-Directional Stability and Control Derivatives Extracted from High-Angle-of-Attack Flight Data." NASA TP-3664, 1996.
- Ishmael, S.D., and T. Wierzbanski. "X-29 Initial Flight Test Results." In *1985 Report to the Aerospace Profession*, 95–113. Lancaster, CA: Society of Experimental Test Pilots, 1985.
- Kehoe, M.W., E.J. Laurie, and L.J. Bjarke. "An In-Flight Interaction of the X-29A Canard and Flight Control System." NASA TM-101718, 1990. Also presented as AIAA Paper 90-1240.
- Krone, Norris J., Jr. "Divergence Elimination with Advanced Composites." AIAA Paper 75-1009, 1975.
- Moore, A.L., and C.D. Harney. "Development of an Integrated Set of Research Facilities for the Support of Research Flight Test." NASA TM-100427, May 1988.
- Putnam, T.W. "X-29 Flight-Research Program." NASA TM-86025, 1983. Also presented as AIAA Paper 83-2687.
- Putnam, T.W., and T.G. Ayers. "Flight Research and Testing." In NASA LRC. *Transonic Symposium: Theory, Application, and Experiment* 1, pt. 1, 33–59. NASA CP-2020, 1989.
- Putnam, T.W., K.L. Petersen, S.D. Ishmael, and W.J. Sefic. "X-29 Flight—Acid Test for Design Predictions." *Aerospace America* 24, no. 2 (February 1986): 40–42.
- Ray, R.J. "Evaluation of Various Thrust Calculation Techniques on an F404 Engine." NASA TP-3001, 1990.
- Ray, R.J., J.W. Hicks, and R.I. Alexander. "Development of a Real-Time Aeroperformance Analysis Technique for the X-29A Advanced Technology Demonstrator." NASA TM-100432, 1988. Also presented as AIAA Paper 88-2145. Published subsequently as "Development of a Real-Time Aeroperformance Analysis Technique for the X-29A Advanced Technical Demonstrator." *Journal of Aircraft* 27, no. 7 (July 1990): 660–667.

Selected Bibliography

- Saltzman, E.J., and J.W. Hicks. "In-Flight Lift-Drag Characteristics for a Forward-Swept-Wing Aircraft and Comparisons with Contemporary Aircraft." NASA TP-3414, 1994.
- Schuster, Lawrence S., and William A. Lokos. "Current Flight Test Experience Related to Structural Divergence of Forward Sweptwings." NASA TM-100445, 1988.
- Sefic, W.J., and W. Cutler. "X-29A Advanced Technology Demonstrator Program Overview." AIAA Paper 86-9727, 1986.
- Sefic, W.J., and C.M. Maxwell. "Flight Research on a Forward-Swept-Wing Airplane." ARC-11740. *NASA Tech Briefs* 11 (October 1, 1987): 1.
- Sefic, W.J., and C.M. Maxwell. "X-29A Technology Demonstrator Flight Test Program Overview." NASA TM-86809, 1986.
- Shafer, M.F., R. Koehler, D.R. Levy, and E.M. Wilson. "Initial Flight Test of a Ground Deployed System for Flying Qualities Assessment." AIAA Paper 89-3359, 1989.
- Sims, R., P. McCrosson, R. Ryan, and J. Rivera. "X-29A Aircraft Structural Loads Flight Testing." NASA TM-101715, 1989.
- Smith, W. "X-29 High AOA Flight Test Results: An Overview." SAE Paper 931367, 1993.
- Smith, R.E., and K.C. Schroeder. "Flight Testing the X-29." In *1986 Report to the Aerospace Profession*. Lancaster, CA: Society of Experimental Test Pilots, 1986: 116–134.
- Stewart, J.F., and C.A. Bauer. "A Project Management System for the X-29A Flight Test Program." AIAA Paper 83-2712, 1983.
- Stewart, J.F., and C.A. Bauer. "Project Management Techniques for Highly Integrated Programs." NASA TM-86023, 1983.
- Tindell, R.H., and W.G. Hill, Jr. "CFD Analysis of the X-29 Inlet at High Angle of Attack." *Journal of Aircraft* 30, no. 4 (July–August 1993).

Sweeping Forward

Trippensee, G.A. "Update of the X-29 High-Angle-of-Attack Program." SAE Paper 912006, 1991.

Trippensee, G.A., and D.P. Lux. "X-29A Forward-Swept-Wing flight Research Program Status." NASA TM-100413, 1987. Also presented as SAE Paper 872418.

Uhuad, G.C., T.M. Weeks, and R. Large. "Wind Tunnel Investigation of the Transonic Aerodynamic Characteristics of Forward Sweptwings." *Journal of Aircraft* 20, no. 3 (March 1983).

Underwood, Pamela J., Lewis R. Owens, Richard A. Wahls, and Susan Williams. "X-29 High Alpha Test in the National Transonic Facility." AIAA Paper-2003-0752, 2003.

Voracek, D.F. "Monitoring Techniques for the X-29A Aircraft's High-Speed Rotating Power Takeoff Shaft." NASA TM-101731, 1990.

Voracek, D.F., and R. Clarke. "Buffet Induced Structural/Flight-Control System Interaction of the X-29A Aircraft." NASA TM-101735, 1991. Also presented as AIAA Paper 91-1053.

Waggoner, E.G., L.A. Jennet, and B.L. Bates. "X-29 Flight Test Program Including Wind Tunnel and Computational Support." SAE Paper 861642, 1986.

Walchli, L.A., and R.E. Smith. "Flying Qualities of the X-29 Forward Swept Wing Aircraft." Paper 19 in NATO, Advisory Group for Aerospace Research and Development (AGARD), In *Flying Qualities*, CP-508, 1991.

Walker, H.C. III. "X-29A Performance Flight Test Results and Lessons Learned." In *1988 Report to the Aerospace Profession*. Lancaster, CA: Society of Experimental Test Pilots, 1988.

Webster, F.R., and D. Purifoy. "X-29 High Angle-of-Attack Flying Qualities." AFFTC-TR-91-15, 1991.

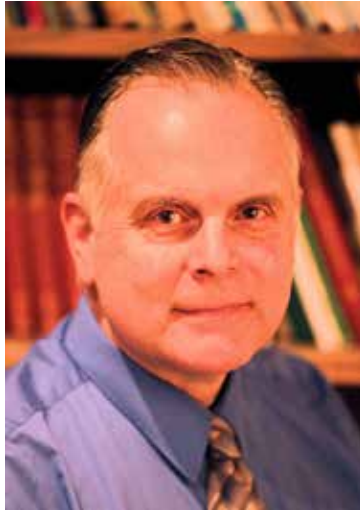

About the Author

Frederick A. Johnsen retired from the Air Force Flight Test Center Museum directorship at Edwards Air Force Base, CA, after nearly 30 years of civil service as an Air Force historian and museum curator at Edwards and McChord (Washington State) Air Force Bases, as well as service as the NASA Dryden Flight Research Center public affairs director. He worked his way through college in Seattle at the University of Washington's Kirsten Wind Tunnel while pursuing degrees in history and journalism. Before entering Air Force civil service, Fred served as an award-winning daily newspaper reporter in Washington State and as the editor of *Western Flyer* (now *General Aviation News*). He was the consulting curator on the development team, creating the Museum of Flight at Boeing Field in Seattle. The author of more than 20 historical aviation books, Johnsen also writes for many aviation periodicals published in the United States and abroad. His video productions are used by a wide range of organizations, including the Society of Experimental Test Pilots, the Experimental Aircraft Association, the Air Force Flight Test Center Museum, and the Flight Test Historical Foundation.



The X-29's fighter-like agility led some to envision a weaponized version with radar and carrying air-to-air missiles and an onboard gun, but it was supplanted by emergence of the Advanced Tactical Fighter (ATF) prototypes, the Lockheed YF-22 and Northrop YF-23, the world's first "Fifth Generation" fighter designs. (NASA)

Index

Numbers in **bold** indicate pages with illustrations

377 Super Guppy transport, 77–78

747 Shuttle Carrier Aircraft (SCA), 77

A

A-37 aircraft, 109–10

Abzug, Malcolm, 108

accelerometers, 68, 70, 113, 277

Acquisition Cost Evaluation (ACE) project, 10

acronyms and abbreviations, 283–87

actuators

canard sizing and, 28

characteristics and description of, 273

cost of, 119

data-gathering parameters and

instrumentation, 113

evaluation of, 119

F-16 hardware, 18

type of and performance of, 119

Advanced Tactical Fighter (ATF) program, 45, 46,

47, 55, 122, 127–28, 144, 201, 220, 298

aerodynamic braking, 278

Aerodynamic Characterization and Military Utility
test program, 169–71

aerospace industry

new and unproven technologies, reluctance
to embrace, 201

participation in X-29 flight testing, 210

relationships and collaboration among
partners, 207

reporting, dissemination, and sharing of
research results, 181, 200–202, 203–4,
216–21

technologies from X-29 and future aircraft
designs, 200–201, 203, 212

aft swept wings

airflow and, 2, 18–19, **19**, 63

drag and, 1

fighter aircraft designs, 10

ground effects, 145

load on, response to, 3

technology research with X-29 program,
transfer to, 18

twist (washout) in design of, 63

wing-fuselage juncture, 63–64

AGM-129A cruise missile, 144, **198**, 208, 221,
281

ailerons

elevons compared to, 32

FSW designs and controllability, 2, 18

high-AoA research, 166

roll control and, 63

Wright Field FSW model, 3

aircraft

computer design codes and design and
development of, 67, 106

Cooper-Harper rating scale, 88

design limitations, 1

loss of in test programs, 202–3

risk-averse climate and experimental aircraft
programs, 202–3

stealth aircraft, 206, 208, 212

technologies from X-29 and future aircraft
designs, 200–201, 203, 212

Sweeping Forward

- wing-fuselage juncture, center of gravity, and design and utilization of, 63–64
- Aircraft Mounted Accessory Drive (AMAD), 70
- airflow
 - aft swept wings and, 2, 18–19, **19**, 63
 - area rule and, 6, 63–64
 - asymmetric vortex flow and shedding, 61
 - FSW designs and, 1, 2, 15, 18–19, **19**, 63
 - oil-flow visualization test, 55
 - smoke-flow visualization flights, 162, 172–74
 - supersonic envelope expansion and inlet airflow spilling, 114–15
 - tufting flow visualization flights, **65**, 109–10, 162, 172–74
 - Whitcomb research on, 6
 - wing twist (washout) and, 63
 - See also* shock waves
- Air Force
 - Advanced Tactical Fighter (ATF) program, 45, 46, 47, 55, 122, 127–28, 144, 201, 220
 - budget and funding for aircraft programs, 144–45
 - budget and funding for X-29 program, 11, 50, 144–45, 193
 - careers, promotions, and relocations, 54
 - destruction or loss of aircraft, responsibility for, 52
 - evaluation of X-29 proposals, 13
 - F-16 AFTI program, 43
 - flight-testing methodology and techniques, 221
 - loan agreement to transfer aircraft to NASA, 50–52, 189
 - management of program, 213
 - military applications for X-29 aircraft, 27, 55, 69
 - pilot involvement in early testing process, 97–98
 - procurement of X-29 aircraft, funding for, 41, 50, 189
 - relationships and collaboration among partners, 189–90, 194, 207, 208–9, 211, 213, 221
 - role in program, 49–55
 - safety responsibility for X-29 program, 96–97, 190–92
 - spin chute for X-29A-2 aircraft, 143–44
 - technologies from X-29 and future aircraft designs, 201
 - wind tunnel testing of FSW designs, 11
 - X-15 program collaborative process, 42–43
- Air Force Advanced Development Projects Office (ADPO)
 - first four flights requirement, 44–45
 - goals and objectives of program, 43, 52
 - monthly report of X-29 program progress, 55, 59
 - pace of X-29 development, 26
 - relationships and collaboration among partners, 50, 52–55
 - role and responsibilities in program, 187, 194
 - vortex flow control research, 177
- Air Force Aeronautical Systems Division, 10, 41, 116, 191–92
- Air Force Flight Dynamics Laboratory (FDL)
 - aerial refueling capabilities for experimental aircraft, 35
 - budget and funding for program, 144–45, 193
 - flight readiness review processes, 43
 - FSW research, 62
 - proposals and contract to design aircraft, 12, 16, 50, 280
 - relationships and collaboration among partners, 190–92
 - role and responsibilities in program, 67, 190–92, 194, 206–7, 210
 - safety responsibility for X-29 program, 191–92
 - static structural load testing, 59–60

- Air Force Flight Test Center (AFFTC)
 - Benefield Anechoic Facility, 79
 - budget and funding for program, 144–45
 - classification of VFC test results, 181
 - F-15 Eagle fighter program, 53
 - F-16 AFTI program, 43, 53
 - flight testing at Grumman Calverton facility, 48
 - flight-testing methodology and techniques, 48, 49, 221
 - high-AoA flight research, 129, 144
 - History Office records of multiagency programs, 42
 - loan agreement to transfer aircraft to NASA, 51, 105
 - Participating Test Organization role, 41
 - relationships and collaboration among partners, 52–55, 190–92, 221
 - Responsible Test Organization role, 52–53, 194
 - role and responsibilities in program, 43, 49, 52–55, 111, 187, 189, 190–92, 194–95, 195, 206–7, 210
 - safety responsibility for X-29 program, 190–92
 - supersonic envelope expansion, 114–15
 - technical reports, 217–20
 - test flight roll by Sewell and grounding of from testing, 96
 - vortex flow control research, 177
- Air Force Large Amplitude Multi-mode Aerospace Simulator (LAMARS), 83
- Air Force Materials Lab, 116
- Air Force Research Laboratory, 224n32
- Air Force Systems Command (AFSC), 10, 50, 144, 190, 194, 201
- Air Force Wright Aeronautical Laboratories (AFWAL)
 - management role of, 41, 94
 - predictions versus results of X-29 performance, 199–200
 - proposals and contract to design aircraft, 12
 - relationships and collaboration among partners, 191, 192
 - vortex flow control research, 171–72
 - See also* Air Force Flight Dynamics Laboratory (FDL)
- air shows, 128, 135, 162–64, 245–46, 282
- Albrecht, Bill, 116
- Allburn, James “Jim,” 11, 13, 200, 208–9
- Allison V-1710-G6R engine, 4
- altimeter, 158, 276
- altitude
 - high-AoA envelope expansion, 157
 - initial limitation on, 26, 34, 106, 278
 - peak altitude, 214
- American Consolidated–Vultee B-24 Liberator bomber, 2
- American Institute for Aeronautics and Astronautics (AIAA), 217
- American Society of Mechanical Engineers, 41
- Ames Research Center/Ames Aeronautical Laboratory
 - correlation and validation of testing results, 102n63
 - role in program, 67, 187
 - ROT analytical tool, 8
 - wind tunnel testing at, 55, 67
 - See also* Dryden Flight Research Center/Ames-Dryden Flight Research Facility
- angles of attack (AoAs)
 - asymmetric vortex flow and shedding, 61
 - canards and stall prevention, 24–25
 - composite wing design and decrease in, 9
 - controllability at high AoAs, 35
 - correlation and validation of high-AoA testing results, 164–65, 168–69
 - data-gathering parameters and instrumentation, 69, 158
 - dogfight simulations and high-AoA maneuverability, 169–71
 - engine inlet design and, 28, 61

Sweeping Forward

- flight control laws for high AoA, 118, 154, 160, 165
 - flow visualization flights and AoA capabilities, **65**, 109–10, 162, 172–74
 - flying qualities during high-AoA flights, 35, 219
 - FSW designs and maneuverability at high AoA, 1, 2, 62
 - high-AoA capabilities and performance, 35, 144, 145, 162, 165–69, 212, 218–20, 221
 - high-AoA configuration and methodology, 154–58
 - high-AoA envelope expansion, 156–57, 159–62, 164–65, 168, 171
 - high-AoA flight reports, 218–20
 - high-AoA flights, **65**, 119–20, 123, 127–28, 129–30, 145, 160–62, **161**, 282
 - high-AoA pilot simulations, 57
 - high-AoA program budget and funding, 144, 145, 193
 - high-AoA research objectives, 153, 165
 - indicator on instrument panel, 276, 277
 - initial limitation on, 26, 129
 - lateral control and, 129–30
 - military applications for high-AoA research, 129, 157, 165, 169–71, 219–20
 - pitch instability issues at high AoA, 160–61
 - spin chute for high-AoA flights, **34**, 35, 143–44, 145, 153, 157–58, **157**, 282
 - VFC, diminished rudder effectiveness, and higher AoAs, 267
 - wind tunnel model testing of high-AoA flight, 153–54
 - wing strain data collection, 22–23
 - X-29A-1 flight tests, 244, 269n4
 - Antelope Valley Inn, 79
 - area rule, 6, 63–64
 - Arnold Air Force Base, 11
 - Arnold Engineering Development Center (AEDC), 67
 - attitude directional indicator (ADI), 276
 - attitude heading reference system (AHRS), 276
 - automatic camber control (ACC), 22, 85, 95, 119, 123, 124, 132–33
 - Aviadvigatel D-30F6 afterburning turbofan engines, 201
- ## **B**
- B-1/B-1A bomber, 79, 144
 - B-2 bomber, 144
 - B-24 Liberator bomber, 2
 - Ballhaus, William F., Jr., 191
 - Bauer, Jeffrey, 209
 - Bell-Boeing V-22 Osprey, 208
 - Bell X-5 aircraft, 206
 - Bell XS-1 aircraft, 4, 45, 97, 98, 205–6
 - Benefield, Tommie D. “Doug,” 79
 - Benefield Anechoic Facility, 79
 - bird-strike protection, 59
 - body freedom flutter, 17, 20
 - Boeing B-377 Super Guppy transport, 77–78
 - Boeing B-747 Shuttle Carrier Aircraft (SCA), 77
 - Boeing-Martin-Thiokol MX Peacekeeper, 144
 - Boeing NKC-135A Stratotanker, 121, 122, 127, 134
 - Bosworth, John T., 117
 - Brady, J.P. “Phil,” 191
 - brakes and braking
 - aerodynamic braking, 278
 - characteristics and description of, 274
 - effectiveness of brakes, 81, 89
 - emergency brake, 81
 - landing procedures, 278
 - parking brake, 278
 - speed brake, 131, 133, 135
 - taxi tests and riding the brakes, 81
 - Bridges, Roy D., 125
 - buffet and buffeting, 63, 70, 114–15, 167
 - Bugatti R-100 aircraft, 1
 - Bush, George H.W., 77, 281

- buzz
 flaperons and concerns about, 25–26
 flight testing for correlation and validation of
 measurements, 68
 Byam, L.T., 53
- C**
- C-5A Galaxy airlifter, 78
 C-17 aircraft, 144
 Cabana, Bob, 56
 Calspan, v
 Calspan NC-131H Total In-Flight Simulator
 (TIFS) test bed aircraft, 56, 67, 82–87, 105–6,
 136n3
 canards
 actuators, 28, 273
 advantages and benefits of, 63–64
 data-gathering parameters and
 instrumentation, 70, 113
 fighter concepts use of, 55, 122
 flight testing for correlation and validation of
 aerodynamic characteristics, 69
 flow visualization tests to explore interaction
 between vortices, 162
 high-AoA capabilities and performance and,
 162
 high-AoA flight, **65**, 156
 HiMAT project, 6
 instability issues with X-29 and, 27–28
 instrument showing position of, 277
 interaction between wing and, 13, 27–28,
 55, 63
 lift and, 13, 24–25, 30, **33**
 maneuvering mechanics, 31–32
 movement of, visibility of, 214
 performance predictions versus results, 199
 pitch control through, 13, 24–25
 pitch-rate gyro location and, 33, 34
 proposals for X-29 aircraft, 12, 13
 purpose and performance of, 24–25, **25**, 55,
 63, 67, 79, 271, 272
 S-37 aircraft, 201–2
 sizing of, 28
 Su-30 aircraft, 202
 taxi tests and performance of, 79, 118
 X-29 aircraft, **270**
 can bird, 153, 163, 164
 Caporali, Renso L., 16, 79, 93
 center of gravity
 data-gathering parameters and
 instrumentation, 69
 wing-fuselage juncture, aircraft design and
 utilization, and, 63–64
 center of pressure, 66
 Ceruzzi, Paul E., 138n59
 Cessna A-37 aircraft, 109–10
 chase planes, **58**, 90–91, 109–10, 131
 Chin, Jimmy, 107, 108
 chutes/parachutes
 drag chute, 2
 ejection seat drogue chute, 275
 personnel parachute, 275
 spin chute, **34**, 35, 143–44, 153, 157–58,
157
 spin chute cost, 143–44, 145, 158
 X-29A-2 spin chute testing, 159–60, 282
 Clarke, Robert, 118, 160–61, 210–11
 COBOL, 6
 cockpit
 design review, 56–57
 glass cockpit displays, 107
 instrument panel and flight instruments,
 69–70, **107**, 130, 158, 203, 276–77
 layout mockup, evaluation of, 14
 modifications to, 57
 pitch-rate gyro location, 33
 size of and height of pilot, 108
 VFC simulation tasks and cockpit control
 placement, 175
 visibility from, 135
 Code O Data Network (CODN), 200
 compass, 277

Sweeping Forward

- composite materials
 - advancements in aircraft design and, 1
 - aeroelastic tailoring, value of, 208
 - aeroelastic tailoring of, 7–9, 14–15, 16, 19, 24, 28, 60, 67, 116
 - construction and specifications of X-29 wing, 18, 23–24, **24**
 - delamination issues, 115–16
 - FSW designs and, 5, 7–9
 - graphite tape development for FSW program, 16
 - layup of tailored composite materials, 57
 - static structural load testing of aeroelastic tailoring to prevent, 60
 - value of, 208
 - weight of wing made from, 8–9, 14–15, 16, 18
 - computational fluid dynamics (CFD), 28
 - computers
 - advancements in and aircraft design, 9
 - aerospace science and computers museum exhibit, 127, 138n59
 - analysis of wing shapes and weights, 8–9
 - analytical design codes and aircraft design, 67, 106
 - data-gathering parameters and instrumentation, 69–70, 111–13, 200
 - IBIT software, 96
 - Computing Devices of Canada (ComDev), 205
 - configuration control records, 192
 - Conley, Philip J., Jr., 53, 55
 - control surfaces
 - characteristics and description of, 272–73
 - data-gathering parameters and instrumentation, 69–70, 113
 - instrument showing position of, 277
 - maneuvering mechanics, 31–32
 - X-29 stability and, 13, 24–26, **25, 26**, 204
 - See also* actuators; canards; flaperons
 - Convair XF-92 test bed, 138–39n66
 - Cooper, Robert, 77
 - Cooper-Harper rating scale, 88
 - Cornelius, George, 3
 - Cornelius Mallard, 3, 280
 - Cornelius XFG-1 FSW glider, 3, 280
 - Cornell Aeronautical Laboratory, v
 - Craig, Ray, 234
 - Crossfield, Scott, 97
 - cruise missiles, 144, **198**, 208, 221, 281
 - Cuddeback landing site, 29
- ## **D**
- D-30F6 afterburning turbofan engines, 201
 - D-558 aircraft, 4, **5**
 - Dana, William “Bill”
 - career and flying experience of, 126
 - guest pilot role, 126
 - opinion of X-29 flying qualities, 126–27
 - research pilot role, 126, **126**
 - X-29A-1 flight chronology, 236
 - X-29A-2 flight chronology, 264
 - data collection and analysis
 - air data sensors and priority of data from, 204–5
 - data-gathering parameters and instrumentation, 69–70, 111–13, 130, 158, 192, 200, 203, 208–9
 - data reduction and analysis during flight testing, 117, 205
 - data transmission to ground station, 69, 111
 - real-time data gathering and analysis, 111–13, 117–18, 120, 123, 189, 200, 203–4, 205, 211
 - David Taylor Model Basin, 6
 - Dayton air show, 162–63, 245–46, 282
 - Defense Advanced Research Projects Agency (DARPA)
 - budget and funding for program, 10, 11, 41, 50, 144, 145, 187, 190, 193, 196n1
 - catastrophic failures, probability of, 29
 - first four flights requirement, 48
 - goals and objectives of program, 47

- Krone assignment to, 6–7, 10, 208
- loan agreement to transfer aircraft to NASA, 50–52, 189
- management of program, 193, 213
- pace of flight testing, 116
- proposals and contract to design aircraft, 12, 280
- relationships and collaboration among partners, 54–55, 188–92, 207, 208–10, 211, 213
- role and responsibilities in program, 10–11, 13, 187, 188–92, 194
- schedule for flight tests, 47, 52
- technology research with X-29 program, 18
- de Monge, Louis, 1
- divergence
 - approval for building X-29 aircraft and solution to, 10
 - composite materials, structural tailoring, and divergence prevention, 7–9, 14–15, 16, 19, 24, 28, 67
 - concept and description of, 7, 19
 - flight testing for correlation and validation of measurements, 68
 - FSW issues, 3–4, 7
 - prediction and measurement of, 19–23
 - static structural load testing of aeroelastic tailoring to prevent, 60
 - weight of wing materials and divergence prevention, 7–9
 - wing failure scenario, 23, 213–14
 - wing-mounted stores and, 143
- Douglas D-558 aircraft, 4, **5**
- Dowling, Kevin, 132
- drag
 - aft swept wings and, 1
 - flight testing for correlation and validation of test results, 69
 - FSW designs and, 1, 4–5, 11, 14–15, 18–19, **19**, 64
 - ground effects and, 145–46
 - lift-to-drag characteristics, 123–24, 206–7
 - reduction of, designing for, vi
 - stability and maneuverability and, vi
 - transonic flight and, 1, 11, 15, 18–19, **19**, 24, 62–63, 154, 199
 - wing-fuselage juncture, center of gravity, and, 63–64
- Dr I triplane, 170
- Dryden, Hugh L., 42
- Dryden Flight Research Center/Ames-Dryden Flight Research Facility
 - after-action reports on flights, 220
 - assignments of personnel to projects, 209
 - building for X-29 team, 79
 - configuration control records, 192
 - F-16 AFTI program, 43
 - fixed-base simulator, 121, 159
 - flight-test capabilities and facilities, v, 41, 187, 191, 210, 221
 - flight-testing team, 111, **186**, 190–92, 195
 - flight-test program proposal, 45–48, 60–61
 - high-alpha control laws, 118
 - maintenance on X-29 aircraft, **115**
 - management of program, 193–95
 - naming of, 42
 - record number of test flights in a day, 177
 - relationships and collaboration among partners, 189–92, 209–10, 211, 213, 221
 - Research Aircraft Integration Facility (RAIF), 108
 - Responsible Test Organization role, v, 97, 187
 - role and responsibilities in program, 67, 187, 189–92, 209–10
 - satellite data transmission to Grumman from, 192
 - technology research with X-29 program, 18
 - transport of X-29 aircraft to, **76**, 77–79, 159, 183n30, 281
 - vortex flow control research, 175, 177
 - working environment at, 211

Sweeping Forward

X-15 program collaborative process, 42–43

See also Edwards Air Force Base

Dutch roll mode, 85–86, 87

E

Earls, Mike, 107, 108

Edwards Air Force Base

climatic conditions at, 48

dry lakebed test areas, 29, 92–95, 102n63,

109

EMV tests, 79–80

first flight of X-29A-1 aircraft, 78, 210

Flight Dynamics Division, 53

flight-test capabilities and facilities, **40**, 48,

187, 191

flight-test program proposal for, 45–48

open house and air show at, 128

role in program, 187

runways at, length of, 93, 94

Space Shuttle program role, 94

staffing for X-29 program, 53

taxi tests, 80–81, 87–89, 159

transport of X-29 aircraft to, **76**, 77–79,

159, 183n30, 281

See also Dryden Flight Research Center/

Ames-Dryden Flight Research Facility

ejection system. *See* pilot ejection and ejection system

electrical system

data-gathering parameters and

instrumentation, 70

hydrazine system and emergency power unit

(EPU), 28–29, 57, 70, 110, 274

preparations for aircraft shipping, 78

shorts and component failures, 125–26

Electromagnetic Vulnerability (EMV) tests, 79–80

elevators, 3, 24, 31

elevons, 32

engine inlets, 15, 28, 61, 114–15

engines

Aviadvigatel D-30F6 afterburning turbofan engines, 201

data-gathering parameters and instrumentation, 70

failure of, probability of, 29

failure of and emergency electrical power, 274

failure of and grounding of aircraft, 114

failure of and pilot ejection, 275–76

failure of F404-215 engine, 176–77

GE F404 jet engines, 18, 28, 51, **81**, 114, 122–23, 143, 176–77, 271

loan agreement to transfer aircraft to NASA, 51

pigtail lines for feeding fuel to afterburner, 122–23

starting unit, 271

testing of, **81**

Enns, Dale, 108

Environmental Control System (ECS), 70

Evans, William J. “Bill,” 10

experimental aircraft

accomplishments and legacy of programs, 222

record number of test flights, 181, 281, 282

risk-averse climate and programs to develop, 202–3

weaponization and military applications for, 138–39n66, 143, 205–6

Experimental Aircraft Association air show,

162–64, 245–46, 282

F

F-4 Phantom II fighter, 224n44

F-5A aircraft

aerodynamics of and AoA requirements, 56

aluminum panels and weight of aircraft, 27

differences between USAF and Norwegian nose sections, 57

forward fuselage use, 12, 14, 61

landing gear, 15, 273–74

- reason for choosing, 15
- Royal Norwegian Air Force F-5A aircraft, 18, 56, 57
- T-38A Talon similarity to, 58, **58**
- USAF F-5 aircraft, 18, 57
- F-14 Tomcat
 - components from for X-29 concept, 61
 - data acquisition and analysis to support, 117
 - EMV test role, 80
 - flight control system, 107
 - flight testing and research, 213
- F-15 Eagle
 - aerodynamics of, **33**
 - AFFTC role in program, 53
 - chase plane role, 109–10
 - dogfight simulations and high-AoA maneuverability, 170
 - EMV test role, 80
 - fourth-generation fighters, 224n44
 - g capabilities, 212
 - procurement of, 7
- F-15E Strike Eagle, 144
- F-16 Advanced Fighter Technology Integration (AFTI)
 - aeroelastic tailored composite materials and design of, 14–15
 - AFFTC role in program, 53
 - components from for X-29 concept, 12, 15, 18, 59, 61, 124, 273–74
 - Dana role in, 126
 - development of and F-15 program, 7
 - dogfight simulations and high-AoA maneuverability, 170
 - flight readiness review processes, 43
 - flight testing and research, 210
 - fourth-generation fighters, 224n44
 - g capabilities, 212
 - hydrazine system and emergency power unit (EPU), 29
 - proposals for X-29 based on, 12, **12**, 13
 - relationships and collaboration among partners, 43
 - static instability, 154, 212
- F-16 MATV (multi-axis thrust vectoring), 212
- F-18 aircraft, 61
- F-22 Raptor/YF-22 Advanced Tactical Fighter, 35, 55, 127–28, 201, 202, 212, 224n44, 298
- F-35 fighter, 201, 212, 224n44
- F-100A/YF-100A aircraft, 137n29, 138–39n66
- F-104 CCV (Control-Configured Vehicle), 59, 73n65
- F-104/F-104G Starfighter, 59, 85, 151
- F-111 aircraft, 158
- F-117 stealth aircraft, 144, 206
- F404 jet engines, 18, 28, 51, **81**, 114, 122–23, 143, 176–77, 271
- F/A-18 HARV (High Alpha Research Vehicle)
 - composite material defect issues, 116
 - configuration and methodology for research, 154–56
 - control laws for, 118
 - goals and objectives of research, 155
 - research flight, **119**
 - technologies from X-29 and design of, 203, 212
 - thrust vectoring and high-AoA control, 179
- F/A-18 Hornet
 - development and design of, 49
 - dogfight simulations and high-AoA maneuverability, 169–71
 - engine failure, 122, 176–77
 - engines, 18
 - fourth-generation fighters, 224n44
 - speed brakes and throttling back, 131
- fighter aircraft
 - Advanced Tactical Fighter (ATF) program, 45, 46, 47, 55, 122, 127–28, 144, 220, 298
 - Air Force ATF program, 45, 46, 47, 55, 201
 - applications for experimental aircraft, 138–39n66, 205–6
 - canards for fighter concepts, 55, 122

Sweeping Forward

- dogfight simulations and high-AoA maneuverability, 169–71
- fifth-generation designs, 202, 212, 224n44, 298
- fourth-generation designs, 224n44
- FSW designs, 7, 10, 55, 202
- Navy VFMX program, 45, 46
- performance of compared to enemy aircraft, 170
- technical generations, 224n44
- technologies from X-29 and future aircraft designs, 201, 203
- third-generation designs, 224n44
- weight saved and gained during development, 27
- flaperons
 - actuators, 124, 273
 - buzz and flutter concerns, 25–26
 - characteristics and description of, 273
 - instrument showing position of, 277
 - lift and, 24–25, 65
 - performance values for individual technologies in X-29 program, 207
 - purpose and performance of, 24–26, **26**, 65, 67, 124, 272
 - scale-model testing of, 25
- flight control laws
 - air data sensors and priority of data from, 204–5
 - changes to, 88, 143, 204
 - development and design of, 57–59, 68, 83–84, 108, 209
 - high-alpha control laws, 118, 154, 160, 165
 - performance of aircraft and, 124
- flight control system
 - advancements in aircraft design and computer flight controls, 1
 - air data sensors and priority of data from, 204–5
 - backup system, 18, 26, 30, 59, 106, 114, 216, 273
 - computer failures, 125–26, 127
 - control surface motion and X-29 stability, 13, 204
 - data-gathering parameters and instrumentation, 69–70, 200, 205
 - design challenges, 26–35
 - development and design of, 57–58, 210
 - digital fly-by-wire system, 5, 24, 30, 67, 106–8, 125–26, 220, 271, 272
 - electrical system short and failures, 125–26
 - evaluation of performance of, 119–20
 - F-104 aircraft, 59, 85
 - failure of, probability of, 30
 - feedback system, 106–7, 117–18
 - feel force bungees, 272
 - fixed-gain system, 106
 - flying qualities for open-loop and closed-loop tasks, 69, 159
 - gains settings, 57, 59, 120, 125, 132–33, 204
 - health monitoring and safe gain and phase margins, 117–18, 209
 - HiMAT project, 6
 - instability issues with X-29 and, 14, 26–28, 30, 213–14
 - instrument panel and flight instruments, 69–70, **107**, 130, 158, 203, 276–77
 - linear flight control models and design of, 117
 - maneuvering mechanics, 31–32
 - off-the-shelf components, 61
 - pace of X-29 development and, 27
 - pitch-rate gyros, 30–31, 32–34, 209
 - roll-rate gyros, 132
 - safety and redundancy arrangements, 30, 31, 216, 272, 277
 - simulation testing of, 57–58, 81–87, 88
 - software changes and performance of, 106–8, 114, 125, 127, 128–30
 - SR-71 Blackbird system, 18, 108
 - stick harmony, 124–25, 127, 131

- TIFS simulation flights and rating of flying qualities, 88
- wing strain data collection through, 22–23
- flight control system modes
 - analog reversion (AR), 33, 82, 83–84, 85, 86–87, 91, 105–6, 114, 118, 125, 130, 216, 273
 - automatic camber control (ACC), 22, 85, 95, 119, 123, 124, 132–33
 - basic digital, 33
 - changing modes during maneuvering flight, 277
 - changing modes during takeoff, 57
 - digital reversion (DR), 33, 84, 85, 91, 118, 273
 - electrical system short and, 125
 - fixed-gain system and, 106
 - manual camber control (MCC), 22, 135
 - normal digital (ND), 22–23, 57–58, 84, 85, 89, 91, 118
 - Speed Stability operating mode, 58
 - standard operation mode, 22
- flight deflection measurement system (FDMS), 21–22, 113, 123
- flight testing and research
 - acceptance flights, 41
 - advances in test data-gathering operations, 61
 - after-action reports on flights, 130–35, 220
 - Air Force pilot involvement in early testing process, 97–98
 - chase planes, **58**, 90–91, 109–10, 131
 - communication with pilots during, 111, 133
 - correlation and validation of testing results, 33–34, 61–62, 68–69, 88, 90, 91, 95–96, 102n63, 105–6, 117, 121, 122, 136n3, 164–65, 168–69, 199–200
 - data gathering and analysis, real-time, 111–13, 117–18, 120, 123, 189, 200, 203–4, 205, 211
 - data-gathering parameters and instrumentation, 69–70, 111–13, 130, 158, 192, 200, 203, 208–9
 - data reduction and analysis during, 117, 205
 - data transmission to ground station, 69, 111
 - at Dryden, v, 210
 - Edwards range, flight over, **40**
 - envelope expansion program, 20–21, 23, 58, 68, 145, 214, 278, 281
 - envelope expansion to supersonic flight, 114–22
 - film footage for aerospace science and computers museum exhibit, 127, 138n59
 - final flight, 128–29
 - first Air Force pilot, 105
 - first flight, delay in, 89
 - first flight, readiness for, 88–89
 - first flight, tensions surrounding, 216
 - first flight location and date planning, 27, 59, 210, 280
 - first flight of X-29A-1 aircraft, **42**, 46–47, 59, 78, 88, 89–92, **90**, 191, 210, 281
 - first flight of X-29A-2 aircraft, 281
 - first four contractor flights, 43, 44–45, 48, 50, 78, 79, 89, 94
 - flight readiness review processes, 43, 87, 92, 94, 111, 190–92
 - flow visualization flights, **65**, 109–10, 162, 172–74
 - government flight tests, 48, 61, 89, 105–6, 108, 188–89, 190
 - ground effects, 145–52
 - ground test validation before, 33–34
 - high-AoA envelope expansion, 156–57, 159–62, 164–65, 168, 171
 - high-AoA flights, **65**, 119–20, 123, 127–28, 129–30, 145, 160–62, **161**, 282
 - initial limitation on flight-envelope parameters, 26–27, 106, 108–9, 145
 - inspection following flights, 127
 - last flight, 282

Sweeping Forward

- lateral PIO evaluation, 105–6, 136n3
- length of flights, 34, 110, 272, 281
- location for, 45–48, 92–95, **109**, 187, 191
- methodology and techniques for, vi, 47, 95–96, 110–11, 221
- milestone flights and pilots, **42**, 105, 108, **120**, 127, 280–82
- NASA control room availability for, 94
- number of flights, v, 42, 127, 128–29, 181, 281
- number of flights in a day, 116, 177, 178, 282
- number of flights per month, 46
- number of flights per week, 110, 116–17, 213
- objectives, priorities, and planning for, 43, 60–70, 95, 109–11, 123–24, 215
- 100th flight, **42**, **120**, 122, **186**, 234, 281
- optimistic schedule for, 47, 58
- pace of, 116, 122–23, 127, 137n29
- preflight walkaround procedure, 277
- RAV system for guidance during, 112
- record number of test flights, 181, 281
- record number of test flights in a day, 177, 282
- reporting, dissemination, and sharing of research results, 181, 200–202, 203–4, 216–21
- results of and X-29 potential, 67
- risks associated with, 213–14
- roll during third flight, 96–98
- safety and redundancy arrangements, 204
- schedule delays, 92–94, 122–23, 159
- schedule for, 45–48, 52, 58, 89
- team approach to, v, vi, 110–11, **186**, 190–92, 195
- 200th flight, 127, 134, 241, 281
- VFC flights, 177–81, 224n32, 267–69, 282
- X-29A-1 aircraft flight chronology, 227–46
- X-29A-2 aircraft flight chronology, 247–66
- X-29A-2 spin-chute testing, 159–60, 282
- flow visualization flights, **65**, 109–10, 162, 172–74
- flutter
 - data-gathering parameters and instrumentation, 70
 - flaperon system and concerns about, 25–26
 - flight testing for correlation and validation of measurements, 68
 - FSW designs and, 65–66, 68
 - research and testing to study, 57
 - wing bending frequency, rigid body stability, and body freedom flutter, 17, 20
 - wing-mounted stores and, 143
- fly-by-wire/digital fly-by-wire (DFBW) controls. *See* flight control system
- Fokker Dr I triplane, 170
- forward swept wing (FSW)
 - advantages and benefits of, 1–5, 10, 18–19, 62–67, 221
 - danger associated with, 9, 97
 - early designs and technology, 1–5, 201, 222
 - fighter aircraft designs, 7, 10, 55
 - Krone research about, 5–11, 15, 280
 - limitations of, 2, 3–4
 - load on, response to, 3–4
 - milestones in design and X-29 flight tests, 280–82
 - stores location, flutter, and, 65–66, 68
 - validation with X-29 aircraft, 125, 207, 221
 - variable forward sweep wings, 66
 - weight of wings, 3–4, 7–9, 14–15, 16
 - wing twisting and structural materials, 5, 7–9
 - See also* divergence
- Fossum, Robert R., 189
- frequency modulation (FM) data acquisition system, 113
- fuel and fuel system
 - aerial refueling capabilities, 18, 34–35, 131–32, 202, 272
 - characteristics and description of, 271–72

- cost of aerial refueling components, 35, 202
 - failure of, 128
 - lesson learned about aerial refueling
 - capabilities for experimental aircraft, 35
 - pigtail lines for feeding fuel to afterburner, 122–23
 - preparations for aircraft shipping, 78
 - refueling simulation flight, **121**, 122, 127, 134
 - tanks and fuel capacity, 271–72
 - weight of fuel, 272
 - wing-fuselage juncture, center of gravity, and location of fuel, 67
 - Fullerton, C. Gordon
 - after-action reports on flights, 134
 - guest pilot role, 126
 - opinion of X-29 flying qualities, 134
 - VFC flights, 175–76, 267–68
 - VFC performance, 178–80
 - VFC simulation flights, 175, 177
 - X-29A-1 flight chronology, 240
 - fuselage and forebody
 - antinode sites for pitch-rate gyros, 32–34
 - flexing during flight, 32, 34
 - flow visualization tests to explore interaction between vortices, 162, 172–74
 - interaction between vortices, 166, 171–72
 - wing-fuselage juncture, center of gravity, and aircraft design and utilization, 63–64
 - See also* vortex flow control (VFC)
 - Future Applications Committee (FAC), 13, 200–201, 220–21
- G**
- Gates Learjets, 163
 - General Dynamics
 - FSW research, 62
 - proposal for FSW derivative of F-16 fighter, 12, **12**, 13
 - proposal for X-29 aircraft, 11
 - X-29 program role, 11
 - General Dynamics AGM-129A cruise missile, 144, **198**, 208, 221, 281
 - General Dynamics F-16 fighter. *See* F-16
 - Advanced Fighter Technology Integration (AFTI)
 - General Dynamics F-111 aircraft, 158
 - General Dynamics YF-16 fighter, 7, 8–9, 49–50
 - General Electric (GE) F404 jet engines, 18, 28, 51, **81**, 114, 122–23, 143, 176–77, 271
 - Gera, Joseph, 107, 118
 - Germany
 - captured fighters from, performance of, 170
 - F-104 CCV (Control-Configured Vehicle), 59, 73n65
 - fighter production for World War II, 2–3
 - FSW designs, 1–3, 4–5, 201, 222
 - gliders, 3, 280
 - Gould Concept Series 9780 computer, 112
 - Gould SEL 32/55 computer, 112
 - Gould SEL 32/77 computer, 112
 - Griffin, Ken, 114–15, 206–7
 - ground effects, 145–52, **151**
 - ground testing
 - correlation and validation of testing results, 33–34, 61–62, 68–69, 199–200
 - program for, 33–34
 - results of and X-29 potential, 67
 - Grumman Aerospace Corporation (GAC)
 - acceptance flights, 41
 - aeroelastic tailoring of composite materials, 14–15, 16, 28, 57
 - budget and funding for program, 11, 41, 50, 144–45, 187, 193, 196n1
 - cockpit layout mockup, 14
 - configuration control records, 192
 - contract to build X-29 aircraft, 11, 13, 44, 280
 - cost-plus contract, 44
 - development and design of X-29 aircraft, v, 11, 12–17, **17**, 27
 - EMV tests, 79–80
 - engineering personnel, talent of, 215–16

Sweeping Forward

- first four flights requirement, 43, 44–45, 48, 50, 78, 79, 89, 94
 - fixed-price contract, 44, 50, 89, 145, 187, 196n1
 - flight-testing methodology and techniques, 221
 - flight-testing team role, 111
 - FSW research, 6, 7, 14–17, 62
 - HiMAT project, 6, 14–15, 28
 - loan agreement to transfer aircraft to NASA, 43, 50–52, 78, 89, 105, 159, 189
 - management of program, 213
 - motion-based flight simulator, 56
 - off-the-shelf components use by, 12, 14, 15, 18, 61, 124, 214
 - relationships and collaboration among partners, 44–45, 49–52, 107–8, 188–92, 207, 208–10, 211, 213, 221
 - role in program, 11, 44, 49, 50–52, 67, 79, 187, 210
 - satellite data transmission to, 192
 - schedule for flight tests, 52
 - Southwell analysis adaptation for FSW
 - divergence prediction, 19
 - spin-chute cost, 143–44, 145
 - spin chute for X-29A-2 aircraft, 143–44
 - vision and drive of, v
 - vortex flow control research, 171–72, 175, 177
 - wind tunnel testing by, 67
 - X-29A-2 spin chute testing, 159–60
 - Grumman Aerospace Corporation (GAC)
 - Bethpage facility
 - flight control system design at, 108
 - static structural load testing at, 59–60
 - Grumman Aerospace Corporation (GAC)
 - Calverton facility
 - climatic conditions at, 48
 - first flight location, plans for, 27, 210, 280
 - flight-test program proposal for, 45–48, 93, 191
 - rollout ceremony at, 77, 281
 - taxi tests, 78, 79, 87, 118
 - transport of X-29 aircraft from, **76**, 77–79, 159, 183n30, 281
 - Grumman Design 712 aircraft concept, 15, 280
- ## **H**
- H-1 racer, 205, 206
 - Hallion, Richard P., 88
 - Hamburger Flugzeugbau HFB 320 Hansa jet transport, 3, 4–5, 59
 - Hancock, Regis
 - military applications for high-AoA research, 169
 - VFC flights, 175–76, 267–69
 - VFC performance, 178–80
 - VFC simulation flights, 175, 177
 - handling qualities rating (HQR), 91
 - Hansa jet transport, 3, 4–5, 59
 - Harper dry lakes landing site, 29
 - Have Blue low-observable test bed, 206
 - HDP5301 flight control computers, 61
 - Heilmeier, George, 10
 - Heinkel He 177A bomber, 2–3
 - Hewlett-Packard HP-45 calculator, 215
 - HFB 320 Hansa jet transport, 3, 4–5, 59
 - high-AoA flights. *See* angles of attack (AoAs)
 - Highly Maneuverable Aircraft Technology (HiMAT)
 - project, 6, 14–15, 28
 - HL-10 lifting body, 126
 - Hodge, Kenneth E., 60
 - Hoey, Robert, 42
 - Hoffman, John M.
 - after-action reports on flights, 135
 - guest pilot role, 129
 - opinion of X-29 flying qualities, 129, 135
 - X-29A-1 flight chronology, 244
 - Honeywell, 107–8, 210, 211
 - Honeywell HDP5301 flight control computers, 61
 - Hoover, Alan
 - after-action reports on flights, 133–34, 135

opinion of X-29 flying qualities, 128,
 133–34, 135
 test pilot role, 126
 X-29A-1 flight chronology, 237–44
 X-29A-2 flight chronology, 247–49
 X-29A-2 spin chute testing, 159–60

Hoover, Herbert H., 97
 Hoover, Robert “Bob,” 98
 HP-45 calculator, 215
 HP5451C Fourier Analyzer computer, 112
 Hughes H-1 racer, 205, 206
 hydraulic system, 29–30, 60, 70, 78–79, 273
 hydrazine system and emergency power unit
 (EPU), 28–29, 57, 110, 274

I

inertial navigation system (INS), 158, 172
 Initiated Built-In Test (IBIT), 96
 instrument panel and flight instruments, 69–70,
107, 130, 158, 203, 276–77
 Integrated Product Team (IPT), 208
 interial coupling, 165–66
 Ishmael, Stephen D.
 after-action reports on flights, 133, 135
 air show check flights, 163
 air show ferry flights, 163, 164, **164**, 245,
 246
 background paper about program, 44
 first flight of X-29A-2 aircraft, 281
 first government flight, 108
 flight control system testing, 57–58
 high-AoA capabilities and performance, 162
 high-AoA flights, 160
 milestone flights and pilots, **42**, **120**, 281
 motion-based flight simulation, 56
 opinion of X-29 flying qualities, 133, 135
 photos of, **42**
 research pilot role, 41, 126
 VFC flights, 175, 178, 267–69
 VFC simulation flights, 175
 X-29A-1 flight chronology, 227–42, 244–46

X-29A-2 flight chronology, 247–51, 253–55,
 257–66
 X-29A-2 spin-chute testing, 159–60

J

Japan, 170
 Jenschke, Erwin B. “Bud,” Jr., 126, 242
 Jones, Ray, 52
 Junkers Ju 287 jet bomber, 1–3, 4, 6, 201, 222
 Junkers Ju 352 aircraft, 2
 Junkers Ju 388 aircraft, 2
 Junkers Jumo 004 turbojet engines, 2

K

KC-135A Stratotanker, 121, 122, 127, 134
 Kelley, Robert E., 144
 Kirtland Air Force Base, 163, 164
 Kitty Hawk flight, 120, 122, 281
 Klein, Bob, 108
 Knutson, Martin A. “Marty,” 60, 94
 Krone, Norris J., Jr.
 career of, 5–6, 10
 DARPA assignment, 6–7, 10, 208
 divergence prevention and wing design, 7–9
 doctoral program studies and research, 6,
 10, 15
 FSW research, 5–11, 15, 280
 Grumman FSW and meeting with, 16
 program phases, 9–11
 role in program, 10–11, 13, 187
 weaponization of FSW design, 7
 Whitcomb meeting with, 6

L

Lamberson, Donald L., 145
 landing gear
 aerodynamic braking, 278
 assembly of, 59
 assessment of, 57
 characteristics and description of, 273–74
 extension of and loss of control, 31

Sweeping Forward

- F-5A nose gear, 15, 273–74
- F-16 hardware, 12, 15, 18, 59, 61, 273–74
- first flight of X-29A-1 aircraft, 90, **90**
- Junkers aircraft, 2, 3
- preparations for aircraft shipping, 79
- retraction of, 277
- taxi tests and lifting off mainwheels, 88–89
- landing operations
 - alternative landing sites, 29, 93
 - AR mode, recommendation about landing in, 87
 - braking, 278
 - Edward runways, length of, 93, 94
 - first flight of X-29A-1 aircraft, 91
 - flight testing to evaluate, 69
 - flooding and weather concerns and, 92–95
 - ground effects, 145–52
 - performance during, 133–34, 135
 - procedures and technique, 277–78
- Langley Research Center/Langley Research Laboratory
 - FSW concept research at, 3, 4, **5**
 - Full Scale Tunnel, 153–54, 216
 - high-AoA research, 153–54
 - HiMAT project, 14
 - National Transonic Facility, 169
 - role in program, 11, 67
 - rotary balance wind tunnel facility, 56
 - Southwell analysis adaptation for FSW
 - divergence prediction, 19–21, 23
 - Transonic Dynamics Tunnel testing, 16, 19, 57
 - Transonic Pressure Tunnel testing, 14
 - wind and spin tunnel testing at, 3, 11, 16, 56, 57, 67, 136n3, 153–54, 169, 216
- Lansing, Warner, 15
- Large Amplitude Multi-mode Aerospace Simulator (LAMARS), 83
- Larson, Eric, 107
- lateral control
 - AR mode and, 87
 - Cornelius XFG-1 FSW glider, 3
 - corrections to, 87, 128–30
 - flight control system modes for, 33
 - gyro failure, 31
 - high-AoA and, 129–30, 166–67, 168, 218–19
 - motion-based flight simulation and
 - evaluation of, 56
 - performance of, 128–30, 131
 - pilot-induced oscillation (PIO) events, 82–87, 105–6, 136n3
 - stick harmony, 124–25, 131
 - taxi tests and concerns about, 88
 - VFC and, 178
- Learjets, 163
- Lewis, Gregory V. “Greg,” 126, 127, 242
- Lewis Research Center, 122–23
- lift
 - canards and, 13, 24–25, 30, **33**
 - flaperons and, 24–25, 65
 - flight testing for correlation and validation of
 - test results, 69
 - FSW designs and, 12, 18–19, **19**, 64
 - ground effects and, 145–46, 152
 - lift-to-drag characteristics, 123–24, 206–7
 - shock waves, supercritical wings, and, 24
 - sweep angle of leading edge and, 64
 - tail configuration to balance, **33**
 - See also* divergence
- light-emitting diode (LED) flight deflection measurement system (FDMS), 21–22, 113, 123
- linear flight control models, 117
- Ling-Temco-Vought
 - participation in X-29 flight testing, 220
 - X-29 model testing, 25
- Ling-Temco-Vought XC-142 V/STOL transport, 206
- Litton LN-39 inertial navigation system (INS), 158, 172

- loan agreement to transfer aircraft to NASA, 43,
 50–52, 78, 89, 105, 159, 189
- Lockheed C-5A Galaxy airlifter, 78
- Lockheed F-104 CCV (Control-Configured Vehicle), 59, 73n65
- Lockheed F-104/F-104G Starfighter, 59, 85, 151
- Lockheed F-117 stealth aircraft, 144, 206
- Lockheed SR-71 Blackbird, 18, 108
- Lockheed XST Have Blue low-observable test bed, 206
- Lockheed YF-22 Advanced Tactical Fighter/F-22 Raptor, 35, 55, 127–28, 201, 202, 212, 224n44, 298
- Lokos, William A., 20–23
- longitudinal control
 - Cornelius XFG-1 FSW glider, 3
 - data collection on performance of, 200
 - flight control system modes for, 33
 - high-AoA flights, 218–19
 - performance of, 129–30, 131, 133, 134
 - pilot-induced oscillation (PIO) events, 135
 - simulation testing and control response, 82
 - static longitudinal instability, 213–14
 - stick harmony, 124–25, 131
- Lux, Dave, 18, 203–4
- M**
- M2-F3 lifting body, 126
- Mach number
 - aircraft performance and increase in, 134
 - indicator on instrument panel, 276
 - initial limitation on, 26, 34, 106, 278
 - supercritical wing and, 24
- Mallard aircraft, 3, 280
- Manke, John, 210
- manual camber control (MCC), 22, 135
- Martin Baker MK-GRQ7A ejection seat, 274–75
- Martin X-24/X-24B lifting body program, 42, 126, 194
- Martorella, Paul, 108
- McBride, David, 221
- McCloud, David J., 129, 132, 139n77, 244
- McConnell Air Force Base, 164
- McDonnell-Douglas and X-29 program participation, 210, 220
- McDonnell-Douglas C-17 aircraft, 144
- McDonnell-Douglas F-15 Eagle. *See* F-15 Eagle
- McDonnell-Douglas F-15E Strike Eagle, 144
- McMullen, Thomas, 93–94, 144
- McMurtry, Thomas C. “Tom,” 126, 238
- Memorandum of Agreement, 43–44, 188–92, 194
- Messerschmitt-Bölkow-Blohm (MBB), 59
- Messerschmitt fighters, claims about speed of, 1
- Messerschmitt P.1101 project, 206
- military services
 - dogfight simulations and high-AoA maneuverability, 169–71
 - experimental aircraft, applications for and weaponization of, 138–39n66, 143, 205–6
 - FSW applications, 202
 - high-AoA research, applications for, 129, 157, 165, 169–71, 219–20
 - wing-mounted stores and applications for, 143
 - X-29 aircraft, applications for and weaponization of, 7, 27, 35, 49–50, 55, 69, 129, 143, 298
 - X-29 technologies, applications for, 69, 143
- MK-GRQ7A ejection seat, 274–75
- Mojave airport, 29
- Mojave Desert, 93, **174**
- Moore, Robert, 10
- Murri, Daniel G., 153–54
- MX Peacekeeper, 144
- N**
- National Aeronautics and Space Administration (NASA)/National Advisory Committee for Aeronautics (NACA)

Sweeping Forward

- advances in test data-gathering operations, 61
- budget and funding for program, 144–45, 187, 193
- careers and promotions, 54
- classification of VFC test results, 181
- control room availability for flight tests, 94
- correlation and validation of testing results, 61–62, 102n63
- destruction or loss of aircraft, responsibility for, 52
- dry lakebed test areas, 102n63
- evaluation of X-29 proposals, 13
- F-16 AFTI program, 43
- first four contractor flights requirement, 44–45, 50
- flight-test program proposal, 45–48
- focus and role of in aviation, 44
- Headquarters, 116, 193–94
- loan agreement to transfer aircraft to, 43, 50–52, 78, 89, 105, 159, 189
- management of program, 193–95, 213
- relationships and collaboration among partners, 54–55, 188–92, 194, 207, 208–10, 211, 213, 221
- Responsible Test Organization role, 41, 49, 52–53, 194
- role and responsibilities in program, 41, 49–55, 67, 188–92, 210
- safety responsibility for X-29 program, 105, 190–92
- satellite data transmission, responsibility for, 192
- schedule for flight tests, 52
- technical reports, 217–18
- vortex flow control research, 176
- “worm” logo, **34**
- X-29A-2 spin chute testing, 160
- National Historical Mechanical Engineering Landmark, 41
- National Research Council of Canada, v
- National Transonic Facility (NTF), 169
- Naval Air Test Center (NATC), 48, 55, 187
- Navy
 - Advanced Fighter/Attack Aircraft program, 45, 46
 - evaluation of X-29 proposals, 13
 - role in program, 55, 187, 210
 - technologies from X-29 and future aircraft designs, 201
 - X-15 program collaborative process, 43
- NC-131H Total In-Flight Simulator (TIFS) test bed aircraft, 56, 67, 82–87, 105–6, 136n3
- NKC-135A Stratotanker, 121, 122, 127, 134
- North American and X-29 program participation, 11
- North American F-100A aircraft, 137n29
- North American P-51 Mustang fighter testing, 102n63
- North American P-51 Mustang FSW derivative, **4, 4**
- North American XB-70A Valkyrie, 151
- North American YF-100A/F-100A aircraft, 138–39n66
- Northrop B-2 bomber, 144
- Northrop F-5A aircraft. *See* F-5A aircraft
- Northrop HL-10 lifting body, 126
- Northrop M2-F3 lifting body, 126
- Northrop T-38/T-38A Talon, 58, **58**, 93, 131, 133, 134, 163
- Northrop YF-23 Advanced Tactical Fighter, 35, 55, 127–28, 212, 298
- nose strakes, 61

O

- Odgers, Peter W. “Peet,” 96
- oil flow visualization test, 55
- Oklahoma National Guard facility, 163
- Olstad, Walter B., 189
- ordnance. *See* weapons/ordnance
- Oshkosh air show, 162–64, 245–46, 282

P

P-35 aircraft, 205
 P-51 Mustang fighter testing, 102n63
 P-51 Mustang FSW derivative, 4, **4**
 P-61 tow aircraft, 102n63
 P.1101 project, 206
 Palmdale airport, 93
 Panama Canal, **76**, 77, 159, 281
 Papsco, Bob, 108
 Participating Test Organization (PTO), 41
 Patuxent River test facility, 48, 55, 187
 Perkins, Courtland, 3
 Petersen, Kevin, 221
 Pickett, Marlin, 121
 pilot ejection and ejection system
 characteristics and description of, 274–76
 condition for ejection, 275–76
 hydraulic system and, 29–30
 hydrazine system, EPU, and, 29, 274
 pilot positioning to reduce injury during, 276
 safe ejection, 29
 pilot-induced oscillation (PIO) events, 82–87,
 105–6, 135, 136n3
 pilots
 Air Force pilot involvement in early testing
 process, 97–98
 communication with during flight testing,
 111, 133
 fighter pilots and test pilots, differences
 between priorities of, 138–39n66
 guest pilot program, 126–27, 129
 loss of in test programs, 202–3
 milestone flights and pilots, **42**, 105, 108,
 120, 127, 280–82
 opinions about X-29 flying qualities, 86–87,
 91–92, 109, 126–27, 128, 129, 130–35
 removal of Sewell from flight testing, 96–98
 research pilots compared to test pilots, 49
 test and research pilots, **iv**, v, 41–42,
 126–27

TIFS simulation flights and rating of flying
 qualities, 88
 pitch
 canards for pitch control, 13, 24–25
 data-gathering parameters and
 instrumentation, 69
 dogfight simulations and high-AoA
 maneuverability, 169
 double amplitude, 14, 27
 flight control system and pitch commands,
 124–25, 129, 131, 272
 high-AoA and pitch control, 165–66
 instability issues at high AoA, 160–61
 instability issues with X-29 aircraft, vi, 14,
 210–11, 212
 maneuvering mechanics and, 31–32
 VFC and pitch control, 180
 pitch-rate gyros, 30–31, 32–34, 209
 pitot mast and pitot heat switch, 277
 preflight walkaround procedure, 277
 pulse code modulation (PCM) data acquisition
 system, 113
 Purifoy, Dana D.
 after-action reports on flights, 135
 air show ferry flights, 163, 245
 guest pilot role, 129
 opinion of X-29 flying qualities, 129, 135
 test pilot role, 129
 X-29A-1 flight chronology, 244–45
 X-29A-2 flight chronology, 249–61, 265–66
 Push-Over Pull-Up (POPU) maneuvers, 123
 Putnam, Terrill W. “Terry,” 54, 60

R

R-100 aircraft, 1
 radar and EMV tests, 79–80
 Randell, Patty, 110
 Reinard, Mike, 52–53
 Reitherman, Arthur, 3
 relaxed static stability, 30, 154, 203–4, 271

Sweeping Forward

- Remotely Augmented Vehicle (RAV) system, 112, 133, 165
- Remotely Piloted Aircraft (RPA), 203
- Research Aircraft Integration Facility (RAIF), 108
- research results, reporting, dissemination, and sharing, 181, 200–202, 203–4, 216–21
- Responsible Test Organization (RTO), v, 41, 49, 52–53, 97, 187, 194
- Retelle, John, 200, 201
- Reynolds number, 169
- Rickerson, John, 265
- Riemer, Jeffrey, 243
- Rockwell B-1/B-1A bomber, 79, 144
- Rockwell International
 - FSW research and studies, **viii**, 7, 62
 - proposal for X-29 aircraft, 11, 13–14, 16
 - role in program, 11
 - Southwell analysis adaptation for FSW
 - divergence prediction, 19
- Rockwell X-31 aircraft. *See* X-31 vectored thrust test vehicle
- Rogers Dry Lake, 92, **109**
- roll
 - data-gathering parameters and instrumentation, 69
 - dogfight simulations and high-AoA maneuverability, 169–71
 - Dutch roll mode, 85–86, 87
 - flaperons and roll control, 24–25, 272
 - flight control system and roll commands, 124–25, 129, 134, 272
 - high-AoA and roll control, 162, 165, 166
 - physical effects on pilot during roll, 133
 - VFC and roll control, 177, 178, 180
 - wing twist (washout) for roll control, 63
- roll damping, 56, 87, 154, 166
- roll-rate gyros, 132
- ROT analytical tool, 8
- Royal Aircraft Factory S.E. 5 aircraft, 170
- Royal Norwegian Air Force F-5A aircraft, 18, 56, 57
- rudder
 - actuators, 273
 - fail-safe condition and position of, 273
 - high-AoA flight and, 156, 166, 171
 - instrument showing position of, 277
 - S-37 aircraft, 202
 - taxi tests, 81
 - VFC to compensate for diminished rudder effectiveness, 267
 - X-29 aircraft, **270**
- Russia and Soviet Union, 3, 7, 201–2

S

- Sacher, Otto, 59
- SAEL analytical tool, 17, 33
- Sandford, Thaddeus, 144–45
- Schneider, Edward T “Ed,” 126, 134, 239, 265
- Schroeder, Doug, 59
- Schroeder, Kurt
 - accomplishments and legacy of program, 213–15
 - after-action reports on flights, 130–31, 132–33
 - instability issues with X-29 aircraft, 27–28
 - opinion of X-29 flying qualities, 132–33
 - pitch-rate gyro failure on test flight, 31
 - relationships and collaboration among partners, 213
 - test pilot role, 41, 97, 126
 - TIFS simulation flights, 87
 - X-29A-1 flight chronology, 227–35
- Schuster, Lawrence S., 20–23
- Sefic, Walter J. “Walt,” 60, 110–11, 115–16, 194
- SEL 32/55 computer, 112
- SEL 32/77 computer, 112
- Sensburg, Peter, 59
- Seversky P-35 aircraft, 205
- Sewell, Charles A. “Chuck”
 - after-action reports on flights, 130, 131–32
 - first flight, readiness for, 88–89

- first flight of X-29A-1 aircraft, **42**, 89–92, **90**, 191, 210, 281
- flight test schedule for and flooding and weather interruptions, 92–93
- milestone flights and pilots, **42**, 281
- opinion of X-29 flying qualities, 91–92
- removal from flight testing, 96–98
- return to flight-test rotation, 97, 105
- roll during third flight, 96–98
- safety, appreciation for, 92
- Spacht, relationship with, 216
- taxi tests, 81, 87–88
- test pilot role, 41
- TIFS aircraft, opinion about, 86
- TIFS simulation and lateral PIO events, 84, 85
- TIFS simulation flights, 85–86, 88
- transport of X-29 aircraft, 78
- X-29A-1 flight chronology, 227–28
- Sharp, Patrick “Pat,” 158
- Shirk, Mike, 16
- shock waves
 - subsonic flight, drag, and control issues, 7
 - transonic flight, drag, and FSW design, 15, 24, 62–63, 199
- short takeoff and landing (STOL) designs, 62, 64, 67, 68
- sideslip
 - data-gathering parameters and instrumentation, 69
 - high-AoA research, 166, 167
 - indicator on instrument panel, 276, 277
 - VFC and, 177, 178, 179–80, 267
- simulators and simulation program
 - correlation and validation of testing results, 69, 88, 90, 91, 95–96, 102n63, 105–6, 121, 122, 136n3, 164–65, 168–69, 199–200
 - flight control system development and testing, 57–58, 81–87, 88
 - ground-based flight simulators, 81–82, 83, 121, 159
 - high-AoA simulations, 57, 159
 - instrument panel and flight instruments, 130
 - Large Amplitude Multi-mode Aerospace Simulator (LAMARS), 83
 - lateral PIO events, 82–87, 105–6
 - motion-based flight simulator, 56
 - participants in, 56, 67
 - rating of flying qualities based on, 88
 - Sewell opinion about TIFS aircraft, 86
 - T-38A Talon simulation, 58, 93
 - technology for simulators, 56, 121
 - TIFS test bed aircraft, 56, 67, 82–87, 105–6, 136n3
 - value of pilot simulations, 96
 - VFC simulation flights, 175, 177, 178, 180
 - VFC simulation tasks and cockpit control placement, 175
- Sitz, Joel, 31, 96, 107, 108, 126, 211
- Slay, Alton D., 50
- Smith, Rogers E.
 - after-action reports on flights, 131, 132, 134
 - air show ferry flights, 163, 164, 245, 246
 - background and career of, v
 - flight control system design, 107, 117–18
 - instability issues with X-29 aircraft, vi, 14, 27–28
 - lateral PIO events, 105–6
 - length of test flights, 34, **42**, 281
 - milestone flights and pilots, **42**, **120**, 127, 281
 - opinion of X-29 flying qualities, 128, 132, 134
 - photos of, **iv**, **42**
 - pitch-rate gyro failure, 30–31
 - refueling simulation flight, 127, 134
 - research pilot role, **iv**, v, 41, 126
 - test flight roll by Sewell during third flight, 96–97
 - TIFS simulation flights, 85

Sweeping Forward

- VFC flights, 268
- X-29A-1 flight chronology, 227–46
- X-29A-2 flight chronology, 247–59, 261–66
- Smithsonian National Air and Space Museum exhibit, 127, 138n59
- smoke-flow visualization flights, 162, 172–74
- Smolka, James W. "Jim," 126, 133, 237
- Society of Experimental Test Pilots (SETP), 178, 205, 217
- Southwell, R.V., 19
- Southwell analysis method, 19–21, 23
- Soviet Union and Russia, 3, 7, 201–2
- Space Shuttle Challenger, 116
- Space Shuttle orbiter, 201
- Space Shuttle program, 94
- Spacht, Glenn
 - accomplishments and legacy of program, 215–17
 - aeroelastic tailoring of composite materials, 14–15
 - career of, 215
 - development of X-29 concept, 15
 - flight control system design, 26
 - proposals for X-29 aircraft, 13–14
 - role in program, 11, 79, 215
 - Sewell, relationship with, 216
 - taxi tests role, 79, 118
- speed
 - aircraft performance and increase in, 134
 - airspeed record of X-29A-1 aircraft, 243, 269n3
 - data-gathering parameters and instrumentation, 69, 70
 - FSW designs and low-speed controllability, 2
 - initial limitation on, 26, 34, 278
 - instrument panel and flight instruments, 276–77
 - takeoff speed, 90
- spins and spin recovery
 - F-5A aerodynamics, AoA requirements, and, 56
 - FSW designs and, 3
 - spin chute for unrecoverable spin, **34**, 35, 143–44, 145, 153, 157–58, **157**, 282
 - technique for spin recovery, 158
- SR-71 Blackbird, 18, 108
- SRI International, 16
- stability, control, and maneuverability
 - body freedom flutter, 17
 - control surface motion and X-29 stability, 13
 - dogfight simulations and high-AoA maneuverability, 169–71
 - double amplitude time, 14, 27
 - drag and, vi
 - flight testing for correlation and validation of performance, 69
 - flying qualities, 121–22, 123–25, 204
 - flying qualities, pilot opinions about, 86–87, 91–92, 109, 126–27, 128, 129, 130–35
 - flying qualities and flight control system evaluation, 119–20
 - flying qualities and graceful degradation, 132–35, 167
 - flying qualities during high-AoA flights, 219
 - flying qualities for open-loop and closed-loop tasks, 69, 159
 - FSW designs and high angles of attack, 1, 2
 - FSW designs and low-speed controllability, 2
 - handling qualities rating (HQR), 91
 - high-AoA capabilities and performance, 35, 144, 145, 162, 165–69, 212, 218–20, 221
 - instability issues with X-29 aircraft, vi, 14, 26–28, 30, 210–11, 212, 213–14, 271
 - linear flight control models for analysis of, 117
 - relaxed static stability, 30, 154, 203–4, 271
 - static instability, 119–20, 121–22, 154, 212, 213–14
 - stick harmony, 124–25, 131
 - TIFS simulation flights and rating of flying qualities, 88

- wing bending frequency, rigid body stability,
 - and body freedom flutter, 17, 20
 - Wright Field FSW model testing, 3
 - stability augmentation system (SAS), 154
 - stalls and stall recovery
 - canards and stall prevention, 24–25
 - FSW designs and, 3
 - high-AoA research, 156
 - wing twist (washout) and stall prevention, 63
 - Stanford Research Institute, 16
 - static test airframe, 59
 - stealth aircraft, 206, 208, 212
 - steering
 - characteristics and description of, 274
 - nosewheel steering, 81, 89
 - taxi tests, 81
 - STOL (short takeoff and landing) designs, 62, 64, 67, 68
 - stores location
 - flutter, FSW designs, and, 65–66, 68
 - S-37 aircraft, 201
 - wing-mounted stores, 143
 - strake flaps
 - actuators, 273
 - characteristics and description of, 273
 - data-gathering parameters and instrumentation, 70, 113
 - flight control system testing, 58
 - instrument showing position of, 277
 - maneuvering mechanics, 32
 - performance values for individual technologies in X-29 program, 207
 - purpose and performance of, 13, 24–25, 67
 - S-37 aircraft, 201–2
 - X-29 aircraft, **270**
 - structural materials
 - FSW, wing twisting, and, 5, 7–9
 - metal wings, weight of, 8–9, 16
 - weight of wing materials and divergence prevention, 7–9
 - See also* composite materials
 - subsonic flight
 - instability issues with X-29 aircraft, 27, 28, 271
 - lift-to-drag characteristics, 123–24
 - shock waves, drag, and control issues, 7
 - Sukhoi S-37, 201–2, 223n11
 - Sukhoi Su-27 aircraft, 202
 - Sukhoi Su-30 aircraft, 202
 - supercritical wing, 6, 24, 67
 - Super Guppy transport, 77–78
 - supersonic flight
 - area rule and, 6, 63–64
 - envelope expansion to, 114–22
 - first X-29 flight, 281
 - flaperons and flutter concerns, 25–26
 - lift-to-drag characteristics, 124
 - stability of X-29 aircraft, 27, 271
 - wing camber adjustments for, 24, **26**
 - sweptback wings. *See* aft swept wings
 - Szalai, Kenneth J., 60, 209–10, 221, 224n32
- ## T
- T-38/T-38A Talon, 58, **58**, 93, 131, 133, 134, 163
 - Tactical Air Command (TAC), 129, 138–39n66, 144, 201
 - Tactical Technology Office (TTO), 10
 - tails
 - F-15 fighter, **33**
 - F-104 CCV, 59
 - Hansa jet transport design, 4–5
 - refurbishing for VFC research, 176
 - S-37 aircraft, 202
 - VFC and, 175
 - X-29 aircraft, **33**
 - takeoff operations
 - first flight of X-29A-1 aircraft, 89–90
 - ground effects, 145–52, **151**
 - nosewheel steering, 81, 89
 - performance during, 134
 - procedures and technique, 277

Sweeping Forward

- speed at takeoff, 90
 - tanks, wingtip, 5
 - taxi tests
 - at Calverton facility, 78, 79, 87, 118
 - canard performance during, 79, 118
 - at Edwards AFB, 80–81, 87–89, 159
 - high-speed tests and lifting off mainwheels, 88–89
 - Taylor Model Basin, 6
 - technology
 - accomplishments and legacy of program, v–vi, 199–200, 202–17, 220–22
 - computer design codes and incorporation of in aircraft design, 67, 106
 - early FSW designs and technology, 1–5, 201, 222
 - future aircraft and technologies from X-29 program, 200–201, 203, 212
 - goals and objectives of program and, 44, 66–67, 215
 - incorporation into X-29 program, v–vi, 5, 6, 9, 10, 18, 209
 - incorporation of experimental technologies into aircraft, 205–6
 - military applications for X-29 technologies, 69, 143
 - new and unproven, reluctance of industry to embrace, 201
 - performance values for individual technologies in X-29 program, 207–9, 215, 216
 - reporting, dissemination, and sharing of research results, 200–202, 203–4, 216–21
 - risk-averse climate and experimental aircraft programs, 202–3
 - Telemetry-Radar Acquisition and Processing System (TRAPS), 200
 - Thomas, Edwin A., 86–87
 - Thompson, Mike, 107, 108
 - Three Sisters landing site, 29
 - thrust vectoring. *See* vectored thrust system
 - tires and tire rotation, 278
 - Total In-Flight Simulator (TIFS) test bed aircraft, 56, 67, 82–87, 105–6, 136n3
 - transonic flight
 - area rule and, 63–64
 - drag and, 1, 11, 15, 18–19, **19**, 24, 62–63, 154, 199
 - flaperons and buzz concerns, 25–26
 - FSW designs and drag reduction, 1, 11, 18–19, **19**
 - instability issues with X-29 aircraft, 211
 - shock waves, drag, and FSW design, 15, 24, 62–63, 199
 - supercritical wing and, 6, 24, 67
 - wing camber adjustments for, 22, 24, **26**
 - Trippensee, Gary
 - correlation and validation of testing results, 164–65
 - FSW research objectives, 18
 - high-AoA capabilities and performance, 162, 165–68
 - high-AoA research objectives, 165
 - lesson learned, 203–4
 - TRW, 210
 - tufting flow visualization flights, **65**, 109–10, 162, 172–74
 - turbulence, 130–31
 - Twinting, William T. “Ted,” 144
- ## **U**
- University of Kansas, 210
- ## **V**
- V-22 Osprey, 208
 - Van Pelt, Larry, 94, 144
 - variable forward sweep wings, 66
 - variable wing sweep program, 206
 - vectored thrust system
 - advantages and benefits of, 143
 - applications for, 64, 68

development and testing of, 68
 installation of, 143
 Su-30 aircraft, 202
 vertical and/or short takeoff and landing (V/
 STOL) aircraft, 62, 206
 vertical velocity indicator, 276
 vortex flow control (VFC)
 airworthiness and safety review, 177
 budget and funding for program, 175, 177
 classification of test results, 181
 concept and purpose of, 267
 effectiveness of, 267
 flight readiness review processes, 176
 flight tests, 177–81, 224n32, 267–69, 282
 flow visualization tests to explore interaction
 between vortices, 162, 172–74
 goals and objectives of research, 171–72
 higher AoAs, diminished rudder
 effectiveness, and, 267
 interaction between vortices, 166, 171–72
 mapping of vortices, 162, 172–74
 mechanics of, 179
 nitrogen tank capacity and flight length,
 282
 nozzle jets, tanks, and control valves for,
 174–76, 177, 267
 number of flights, 181
 number of test flights in a day, 177, 178,
 282
 record number of test flights, 181
 schedule delays, 176–77
 sideslip and, 267
 simulation flights, 175, 177, 178, 180
 simulation tasks and cockpit control
 placement, 175
 success of, 177
 yaw forces and, 171–72, 174–75, 267
 Voss, Werner, 170
 V/STOL [vertical and/or short takeoff and
 landing] aircraft, 64, 206

W

Waite, Ronald S., 60
 Walker, Harry C., III
 after-action reports on flights, 134
 flight tests, **121**
 milestone flights and pilots, **120**
 opinion of X-29 flying qualities, 134
 simulations, value of, 96
 technologies from X-29 and future aircraft
 designs, 203
 test pilot role, 126
 X-29A-1 flight chronology, 231–38
 Wall, Joe, 108
 Wansack, James, 59–60
 weapons/ordnance
 flutter, FSW designs, and, 65–66, 68
 S-37 aircraft, 201
 weaponization and military applications for
 experimental aircraft, 138–39n66, 143,
 205–6
 weaponization and military applications for
 X-29 aircraft, 7, 27, 35, 49–50, 55, 69,
 129, 143, 298
 wing-fuselage juncture, center of gravity, and
 location of, 67
 Webster, Fred, 84, 118, 160, 211–13
 Weeks, Thomas M. “Tom,” 10
 Weight on Wheels (WoW) switch, 125
 Welch, George, 137n29
 Western Aeronautical Test Range (WATR), 110,
 111, 200
 Westinghouse 19XB-28 jet engine, 4
 Wheeler, Mark, 132
 Whitcomb, Richard T. “Dick,” 6, 24
 Wierzbanski, Theodore J. “Ted”
 accomplishments and legacy of program,
 199
 AFFTC role in program, 53–54
 Air Force career and assignment to X-29
 program, 54
 analog backup system upgrade, 114

Sweeping Forward

- background paper about program, 44
- budget and funding for program, 144, 145
- cockpit size and height of, 108
- collaborative relationship among X-29 partners, 42–45, 49–50, 53–55
- delamination issues, 116
- EMV tests, 80
- first Air Force pilot, 105
- first flight, readiness for, 89
- first four contractor flights requirement, 44–45
- flight-testing location decisions, 48
- flight-test methodology, 47
- flight test schedule delays, 92, 122
- goals and objectives of program, 43, 47, 52
- high-AoA program, 144
- hydrazine system, EPU, and pilot ejection, 29
- instrument panel and flight instruments, 130
- lateral PIO events, 82–84, 105
- manager and pilot role, 41–42, 54, 105, **109**, 194–95
- maneuvering mechanics, 31–32
- milestone flights and pilots, **42**
- military applications for X-29 aircraft, 49–50, 55
- motion-based flight simulation, 56
- nickname for, 42
- number of test flights per week, 116–17
- opinion of X-29 flying qualities, 109
- pitch-rate gyro location, 33
- reports and discussions to share information, 220
- risk-averse climate and experimental aircraft programs, 202–3
- schedule for flight tests, 52
- spin chute for X-29A-2 aircraft, 144
- test flight roll by Sewell during third flight, 96
- TIFS simulation flights and rating of flying qualities, 88
- transport of X-29 aircraft, 77
- X-29A-1 flight chronology, 227–30
- Wilkinson, Keith, 15–17, 25–26, 33–34, 35
- wind and spin tunnel facilities
 - Langley Full Scale Tunnel, 153–54, 216
 - Langley rotary balance wind tunnel facility, 56
 - Langley spin tunnel, 3
 - Langley Transonic Dynamics Tunnel, 16, 19, 57
 - Langley Transonic Pressure Tunnel, 14
 - National Transonic Facility, 169
 - Wright Field 5-foot test section wind tunnel, 3, 41
- wind and spin tunnel testing
 - at AEDC, 67
 - by Air Force, 11
 - at Ames, 55, 67
 - budget and funding for, 187
 - computer design codes and reduction in use of, 67, 106
 - correlation and validation of testing results, 61–62, 69, 95–96, 102n63, 106, 122, 136n3, 164–65, 168–69, 199–200
 - design of wind tunnels, 169
 - flaperon model testing, 25–26
 - ground-effects testing, 146, 147, 150–52
 - at Grumman facility, 67
 - high-AoA research, 153–54, 168–69
 - HiMAT project, 14
 - at Langley, 3, 11, 16, 56, 57, 67, 136n3, 153–54, 169, 216
 - limitations of, 169
 - model FSW demonstrator, 216
 - modeling costs compared to full-scale testing, 106
 - model X-29A testing, 41, 56, 57
 - positive outcomes of, 11
 - Southwell analysis adaptation for FSW
 - divergence prediction, 19
 - VFC nozzle placement, 174–75
- windscreen, 59
- Wind-Up Turn (WUT) maneuvers, 123

- wing bending frequency and body freedom flutter, 17, 20
 - wing bending moment, 11
 - wing flaps
 - configuration and compromises in design of, 63
 - X-29 aircraft, **270**
 - See also* flaperons
 - Wing-in-Ground Effect (WIG) aircraft designs, 146
 - wings
 - aeroelastic tailored composite materials and design of, 7–9, 14–15, 16, 19, 24, 28, 60, 67, 116
 - aeroelastic tailored composite materials layup, 57
 - aspect ratio, 64, 146, 199
 - assembly of, 59
 - box beam design, **24**, 60, 78
 - camber adjustments, 24–26, **26**, 32, 67
 - computer analysis of wing shapes and weights, 8–9
 - data-gathering parameters and instrumentation, 70, 113, 200
 - delamination issues, 115–16
 - divergence and failure scenario, 23, 213–14
 - external stored mounted on, 143
 - flight testing for correlation and validation of aerodynamic characteristics, 69
 - flight testing for correlation and validation of loading predictions, 69
 - flow visualization tests to explore interaction between vortices, 172–74
 - fuselage-wing juncture, center of gravity, and aircraft design and utilization, 63–64
 - interaction between canards and, 13, 27–28, 55, 63
 - removable wing halves, 78
 - static structural load testing, 60
 - sweep angle of leading edge, 64
 - twist (washout) in design of, 63
 - weight of, 3–4, 7–9, 14–15, 16, 18, 59
 - wing twist flight deflection measurement system, 21–22, 113, 123
 - See also* aft swept wings; forward swept wing (FSW)
 - Winters, Charles “Pete,” 158
 - Wocke, Hans, 2, 3, 4–5
 - Womer, Rod
 - after-action reports on flights, 133
 - air show ferry flights, 164, 245
 - high-AoA flights, 160
 - opinion of X-29 flying qualities, 133
 - test pilot role, 126
 - X-29A-1 flight chronology, 237–39, 241–43, 245
 - X-29A-2 flight chronology, 247–56
 - Woods, Robert, 205–6
 - World War II
 - captured German and Japanese fighters, performance of, 170
 - German fighter production for, 2–3
 - Wright brother’s flight, anniversary of, 120, 122, 281
 - Wright Flyer, vi, 14, 120
 - Wright-Patterson Air Force Base/Wright Field
 - Aeronautical Systems Division, 10, 41, 94, 187
 - Design Branch, research by, 3
 - FSW concept research at, 3
 - Grumman FSW research with, 16
 - high-AoA flight research, 129
 - model testing in 5-foot test section wind tunnel, 3, 41
 - role in program, 10–11, 187
 - Structural Dynamics Branch, 16–17
- X**
- X-5 aircraft, 206
 - X-15 program
 - Dana role in, 126, 127
 - maneuvers outside of test card, 97

Sweeping Forward

- NASA role after program, 44
- number of flights, 127, 281
- peak altitude, 214
- relationships and collaboration among partners, 42–43, 194
- risks associated with and approval for program, 202
- X-24/X-24B lifting body program, 42, 126, 194
- X-29A-1 aircraft
 - air shows, 128, 135, 162–64, **164**, 282
 - airspeed record during Flight 226, 243, 269n3
 - angle of attack during flight 239, 244, 269n4
 - assembly of, 56, 59, 281
 - can bird, 153, 163, 164
 - EMV tests, 79–80
 - final flight of, 128–29
 - first flight, **42**, 46–47, 59, 78, 88, 89–92, **90**, 210, 281
 - flight chronology, 227–46
 - ground effects and takeoff operations, **151**
 - high-AoA flights without spin chute, 145
 - last flight of, 281
 - loan agreement to transfer aircraft to NASA, 50–52, 78
 - maintenance on, **115**, 122–23
 - negative load factor during flight 239, 244, 269n4
 - nose section for, 56, 57
 - number of flights flown, 128–29
 - number of test flights per month, 46
 - off-the-shelf components use, 18
 - photos of, **40, 58, 121, 142, 151**
 - positive load factor during flight 239, 244, 269n4
 - static structural load testing, 59–60
 - taxi tests, 78, 79, 80–81, 87–89, 118
 - transport to Edward AFB, 78
- X-29A-2 aircraft
 - can bird, 153, 163, 164
 - data from and high-AoA designs, 127–28
 - delivery delays, 127–28
 - dogfight simulations and high-AoA maneuverability, 169–71
 - first flight, 281
 - flight chronology, 247–66
 - high-AoA capabilities and performance, 35, 144, 145, 162, 165–69, 212, 218–20, 221
 - high-AoA configuration and methodology, 154–58
 - high-AoA envelope expansion, 156–57, 159–62, 164–65, 168, 171
 - high-AoA flights, **65**, 119–20, 123, 127–28, 129–30, 145, 160–62, **161**, 282
 - high-AoA program funding, 143–44, 145, 193
 - high-AoA research configuration, 153
 - high-AoA research objectives, 153
 - last flight of, 282
 - loan agreement to transfer aircraft to NASA, 51
 - nose section for, 56, 57
 - off-the-shelf components use, 18
 - phase one testing, 159–60
 - photos of, **76, 142, 163, 174**
 - spin-chute cost, 143–44, 145, 158
 - spin chute for high-AoA flights, **34, 35**, 143–44, 145, 153, 157–58, **157**, 282
 - spin-chute testing, 159–60, 282
 - tail refurbishing for VFC research, 176
 - taxi tests, 159
 - transport to Edward AFB, **76**, 78, 159, 183n30, 281
 - VFC flights, 267–69, 282
 - VFC modifications, 267
 - weight of, 158
- X-29 aircraft
 - approval for building and solution to divergence issues, 10
 - assembly of, 56–57, 59, 281

- can bird, 153, 163, 164
- catastrophic failures, probability of, 29
- characteristics, configuration, and
 - description of, 18–26, **19, 24, 25, 26**, 61, 271–78
- configuration control records, 192
- destruction or loss of, responsibility for, 52
- evaluation of proposals, 13, 16
- flight manual, 271–78
- flight readiness review processes, 43, 87, 92, 94, 111, 190–92
- flying qualities, pilot opinions about, 86–87, 91–92, 109, 126–27, 128, 129, 130–35
- loan agreement to transfer aircraft to NASA, 43, 50–52, 78, 89, 105, 159, 189
- maneuvering mechanics, 31–32
- off-the-shelf components, 12, 14, 15, 18, 61, 124, 214
- performance predictions versus results, 123–24, 199–200
- photos of, **40, 58, 76, 109, 142, 151, 186, 226, 298**
- potential of, 67
- proposals and contract to design and develop, v, **viii**, 11, 12–17, **12, 17**, 27, 44, 50, 280
- risks associated with flying, 213–14
- rollout ceremony, 77, 281
- systems preparations for shipping, 78–79
- transport to Edwards AFB, **76**, 77–79, 159, 183n30, 281
- validation of FSW with, 125, 207, 221
- view drawings of, **270**
- weaponization and military applications for, 7, 27, 35, 49–50, 55, 69, 129, 138–39n66, 143, 298
- weight of, 27, 56, 271
- X-29 Concept Evaluation Program, 51, 192
- X-29 program
 - accomplishments and legacy of, v–vi, 199–200, 202–17, 220–22
 - background paper about, 44
 - budget and funding for, 10, 11, 41, 44, 50, 124, 143, 144–45, 187, 190, 193, 196n1
 - control of, 44–45
 - cost-plus contract, 44
 - fixed-price contract, 44, 50, 89, 145, 187, 196n1
 - follow-on programs funding, 144–45
 - goals and objectives of, 18, 43, 44, 47, 52, 55, 60–61, 62–70, 188, 211, 215, 220–22
 - management of, 41–42, 54, 94, 192, 193–95, 212–13
 - Memorandum of Agreement, 43–44, 188–92, 194
 - pace of X-29 development and flight control system, 26, 27
 - phases of, 9–11, 67–68, 143, 193
 - relationships and collaboration among partners, v, 11, 42–45, 49–55, 107–8, 188–92, 208–10, 211, 213
 - reporting, dissemination, and sharing of research results, 181, 200–202, 203–4, 216–21
 - risks associated with and approval for program, 202–3
 - safety responsibilities, 92, 96–97, 105, 114, 190–92
 - success of, 67, 205, 214–15
- X-31 vectored thrust test vehicle
 - case study about, 185n83
 - control laws for, 118
 - design of, 175
 - dogfight simulations and high-AoA maneuverability, 169–70
 - high-AoA research, 154, 179
 - photo of, **104**
 - technologies from X-29 and design of, 203, 212
- XB-70A Valkyrie, 151
- XC-142 V/STOL transport, 206

Sweeping Forward

XF-92 test bed, 138–39n66
XFG-1 FSW glider, 3, 280
XS-1 aircraft, 4, 45, 97, 98, 205–6
XST Have Blue low-observable test bed, 206

Y

yaw

data-gathering parameters and
instrumentation, 69
flight control system and yaw commands,
129, 272
high-AoA and yaw control, 162, 165–66,
167
VFC and yaw control, 171–72, 174–75,
178, 179, 180, 267
Yeager, Charles E. “Chuck,” 97, 98, 138–39n66
YF-16 fighter, 7, 8–9, 49–50
YF-17 fighter, 49–50
YF-22 Advanced Tactical Fighter/F-22 Raptor,
35, 55, 127–28, 201, 202, 212, 224n44, 298
YF-23 Advanced Tactical Fighter, 55, 127–28,
212, 298
YF-100A/F-100A aircraft, 137n29, 138–39n66