

MIL-STD-633E-6  
22 February 1980

MILITARY STANDARD  
MOBILE ELECTRIC POWER  
ENGINE GENERATOR STANDARD FAMILY  
MEP-016A, 3 kW, 60 Hz, GASOLINE ENGINE-DRIVEN GENERATOR SET  
CHARACTERISTICS DATA SHEET

CLASSIFICATION

Description: 3 kW @ 0.8 power factor, 60 Hz, 120 V, 240 V, 120/208 V.

Model:	MEP-016A	Type:	I (tactical)
NSN:	6115-00-017-8237	Class:	2 (utility)
Spec:	MIL-G-52732/6	Mode:	III (60 Hz)

PHYSICAL CHARACTERISTICS

Dimensions: See Figure 6 on page 42.

Weight: 285 lbs (129.3 kg).

Mobility: Mounted on skid base (tubular frame). Lifting and tie-down attachment provided.

Engine: Gasoline. Standard: MS39299. Horsepower: 6 @ 3600 RPM. No. of cyl: 4. Cycle: 4. Air cooled. Rope start. Operating speed: 3600 RPM. Fuel tank capacity: 3.6 gallon (approx 4 hrs at rated load). Fuel pump lift: 3 ft.

Fuel:

Primary: MIL-G-3056 and VV-G-76 Automotive gasoline.  
Emergency fuel: MIL-G-5572, Grades 80/87, 100/130 and 115/145 Aviation gasolines.

Electrical:

Drip proof generator enclosure. Fungus and moisture treatment.  
Solid state voltage regulator. Brushless rotary exciter.

Voltage Connection: 120 V, 2 wire, 1 phase. 240 V, 2 wire, 1 phase.  
120 V, 3 wire, 3 phase. 120/208 V, 4 wire, 3 phase.

MIL-STD-633E-6  
 22 February 1980

Protective Devices: Short circuit protection.

Instrumentation: Voltmeter. Frequency meter. Percent-of-load meter (ammeter).  
 Hourmeter.

FUNCTIONAL/OPERATIONAL CHARACTERISTICS

Reliability: Mean Time Between Failure (MTBF): 250 hours (specified)

Fuel Consumption: 0.84 gph at rated load.

Electromagnetic Interference: Suppressed to MII-STD-461 limits.

	<u>Voltage</u>	<u>Frequency</u>
<u>Steady State Stability (variation)</u>		
Short Term (30 see)	2% Bandwidth	1% Bandwidth
Long Term (4 hours)	2% Bandwidth	2% Bandwidth
<u>Transient Performance</u>		
Application of rated load	30% Dip	3% Undershoot
recovery	2 Sec	4 Sec
Rejection of rated load	30% Rise	5% Overshoot
recovery	2 Sec	6 Sec
<u>Waveform</u>		
Maximum Deviation factor (single phase)	6%	
(three phase)	5%	
Individual Harmonic (single phase)	3%	
(three phase)	3%	
<u>Regulation:</u>	4%	3%
(for 240 V, 2 wire)	5%	3%

Adjustment Range for Standard Voltage Connections

120/208 v Corm: 197 to 218 V. 140 V Corm: 228 to 252 V.

120 V, 1 phase Corm: 114 to 126 v. 120 V, 3 phase Conn: 114 to 126 V.

ENVIRONMENTAL DATA

Power Output at Environmental Conditions

3 kW, 60 Hz, Sea Level: Minus 25° F (-31.7° C) to plus 125° F (+51.7° C)

3 kW, 60 Hz, 5000 feet: Minus 25° F (-31.7° C) to plus 107° F (+41.7° C)

3 kW, 60 Hz, 8000 feet: Minus 25° F (-31.7° C) to plus 95° F (+35.0° C)

Winterization system extends lower ambient temperature limit to -65° F (-53.9° C).

MIL-STD-633E-6  
 22 February 1980

Shock and Rough Handling: 10 mph railroad impact. 3 foot drop. Vibration.

Attitude: Operate with base level or inclined no more than 15 degrees from level.

Noise Level: 79 dbA @ 25 feet (estimate).

OPTIONAL EQUIPMENT

See 4.4.1 of MIL-STD-633 for additional information on optional equipment.

<u>Description</u>	<u>NSN</u>	<u>Weight lbs (kg)</u>	<u>Effect on Dim</u>
Spark Arrester Kit	2990-01-032-7384		None
Winterization Kit			
Canvas Cover	6115-00-960-2703	6 (2.7)	Negligible
Torch	4520-00-710-4341		

REFERENCE DOCUMENTS

Technical Manuals:

<u>Army</u>	<u>Air Force</u>	<u>Marine Corps</u>	<u>Navy</u>
TM	TO		<u>NAVFAC</u>
5-6115-271-14	35C2-3-386-1		
5-6115-271-24P	35C2-3-386-4	SL-4-05926A	
5-2805-203-14	38G2-90-1		
5-2805-203-24P	38G2-90-14	SL-4-03522B	P-8-613E-24P

LO  
 5-2805-20 3-12

MIL-STD-633E-6  
22 February 1980

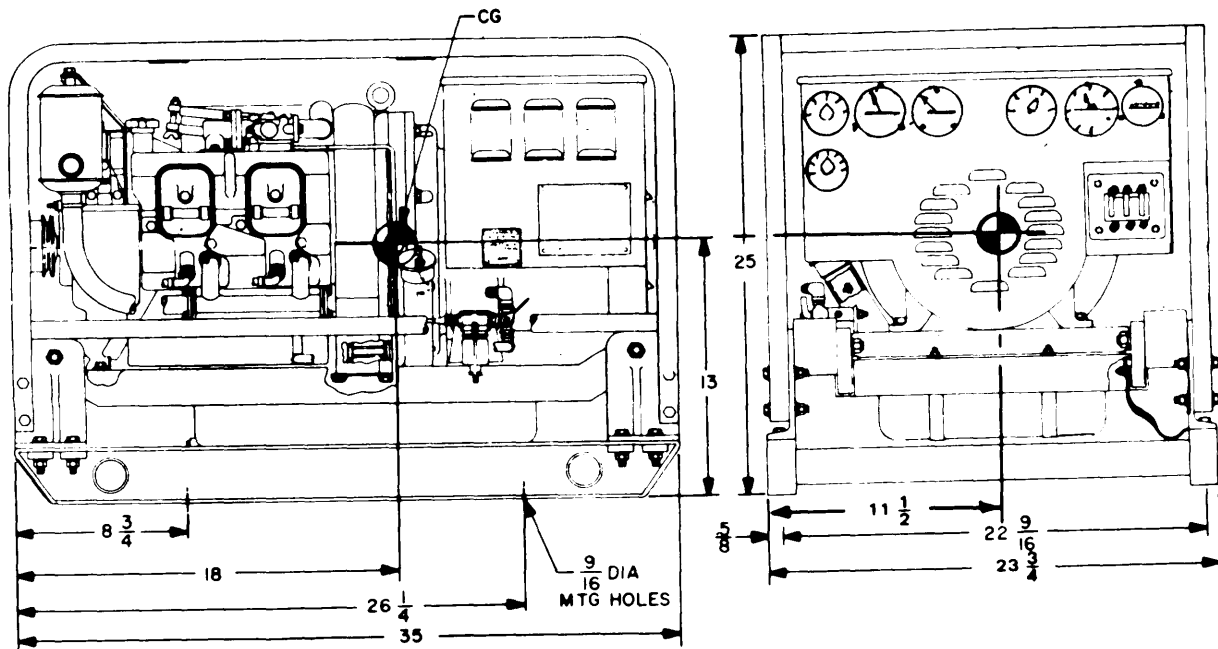
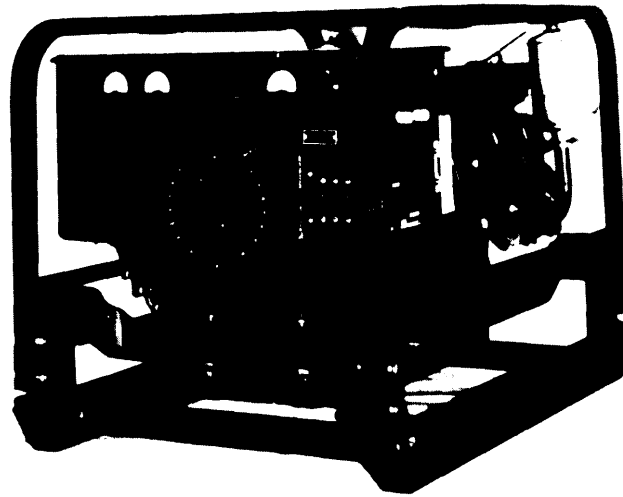

NOTE: ALL DIMENSIONS ARE IN INCHES

FIGURE 6. MEP-016A (3.0 kw, 60 Hz, GED).

x-3542

MIL-STD-633E-13  
22 February 1980

MILITARY STANDARD  
MOBILE ELECTRIC POWER  
ENGINE GENERATOR STANDARD FAMILY  
MEP-003A, 10 kW, 60 Hz, DIESEL ENGINE-DRIVEN GENERATOR SET  
CHARACTERISTICS DATA SHEET

CLASSIFICATION

Description: 10 kW @ 0.8 power factor, 60 Hz, 120 V, 240 V, 120/208 V

Model:	MEP-003A	Type:	I (tactical)
NSN:	6115-00-465-1030	Class:	2 (utility)
Spec:	MIL-G-52889/2	Mode:	III (60 Hz)

PHYSICAL CHARACTERISTICS

Dimensions: See Figures 14 and 15 on pages 71 and 72.

Weight: 1240 lbs (562.5 kg).

Mobility: Mounted on skid base. Lifting, towing and tie-down attachments provided. Fork lift provision.

Engine: Diesel. Std: MIL-STD-1410. Horsepower: 20 @ 1800 RPM. No. of cyl: 4. Cycle: 4. Air cooled. 24 VDC electric start. Operating speed: 1800 RPM. Fuel tank capacity: 12.5 gallons (approx 8 hours at rated load). Fuel pump lift: 6 feet.

Fuel:

Primary: VV-F-800; Diesel Fuel Oil, types DF-1, DF-2 and DF-A.  
Emergency fuel: MIL-T-5624, Aviation Turbine Fuels, grade JP-4

Electrical:

Drip proof generator enclosure. Fungus and moisture treatment.  
Solid state voltage regulator. Brushless rotary exciter.

Voltage Connection: 120 V, 1 phase, 2 wire. 120/240 V, 1 phase, 3 wire,  
120/208 V, 3 phase, 4 wire.

MIL-STD-633E-13  
 22 February 1980

Protective Devices: Short circuit protection. Overload protection.  
 Low oil pressure cut-off switch. High temperature cut-off switch.

Instrumentation: Voltmeter. Frequency meter. Ammeter. Hourmeter.  
 Oil pressure gage. Battery charging ammeter.

FUNCTIONAL/OPERATIONAL CHARACTERISTICS

Reliability: Mean Time Between Failures (MTBF): 500 hours (specified)

Fuel Consumption: 1.09 gph at rated load.

Electromagnetic Interference: Suppressed to MIL-STD-461 limits.

	<u>Voltage</u>	<u>Frequency</u>
<u>Steady State Stability (variation)</u>		
Short Term (30 see)	2% Bandwidth	2% Bandwidth
Long Term (4 hours)	4% Bandwidth	3% Bandwidth
<u>Transient Performance</u>		
Application of rated load	20% Dip	3% Undershoot
recovery	3 Sec	3 Sec
Rejection of rated load	20% Rise	4% Overshoot
recovery	3 Sec	3 Sec
Application of simulated motor load	35% Dip	
recovery	5 Sec	
<u>Waveform</u>		
Maximum Deviation Factor (single phase)	6%	
(three phase)	5%	
Individual Harmonic (single phase)	3%	
(three phase)	2%	
<u>Regulation:</u>	3%	3%

Adjustment Range for Standard Voltage Connections

120/208 V Corm: 205 to 220 V. 120/240 V Corm: 228 to 252 V.  
 120 V, 1 phase Corm: 114 to 126 V.

Frequency Adjustment Range: 60 Hz: ±3%

MIL-STD-633E-13  
 22 February 1980

ENVIRONMENTAL DATA

Power Output at Environmental Conditions

10 kW, 60 Hz, Sea Level: Minus 25° F (-31.7° C) to plus 125° F (+51.7° C)  
 10 kW, 60 Hz, 5000 feet: Minus 25° F (-31.7° C) to plus 107° F (+41.7° C)  
 9 kW, 60 Hz, 8000 feet: Minus 25° F (-31.7° C) to plus 95° F (+35.0° C)  
 Winterization system extends lower temperature limit to -65° F (-53.9° C).

Shock and Rough Handling: 10 mph railroad impact. 12 inch drop. 12 inch end drop. Truck and trailer transportation.

Attitude: Operate with base level or inclined no more than 15 degrees from level.

Noise Level: 77 dbA @ 25 feet.

OPTIONAL EQUIPMENT

See 4.4.2 of MIL-STD-633 for additional information on optional equipment.

<u>Description</u>	<u>NSN</u>	<u>Weight lbs (kg)</u>	<u>Effect on Dim</u>
Winterization Kits			
Aux, Fuel Burning	To be determined	350 (158.8) Max	Aux: (41X40X26)
Slave Receptacle			
Assembly (MS3506)	5935-00-549-4690		Int
Slave Receptacle			
Assembly (MS75058)	5935-00-295-6403		Int

REFERENCE DOCUMENTS

Technical Manuals:

<u>Army</u>	<u>Air Force</u>	<u>Marine Corps</u>	<u>Navy</u>
TM	TO		<u>NAVFAC</u>
5-6115-585-12	35C2-3-455-1	TM-05684C-12	P-8-623-12
5-6115-585-34	35C2-3-455-2	TM-05684C-34	P-8-623-34
5-6115-585-24P	35C2-3-455-4	SL-4-05684C	P-8-623-24P

MIL-STD-633E-13  
22 February 1980

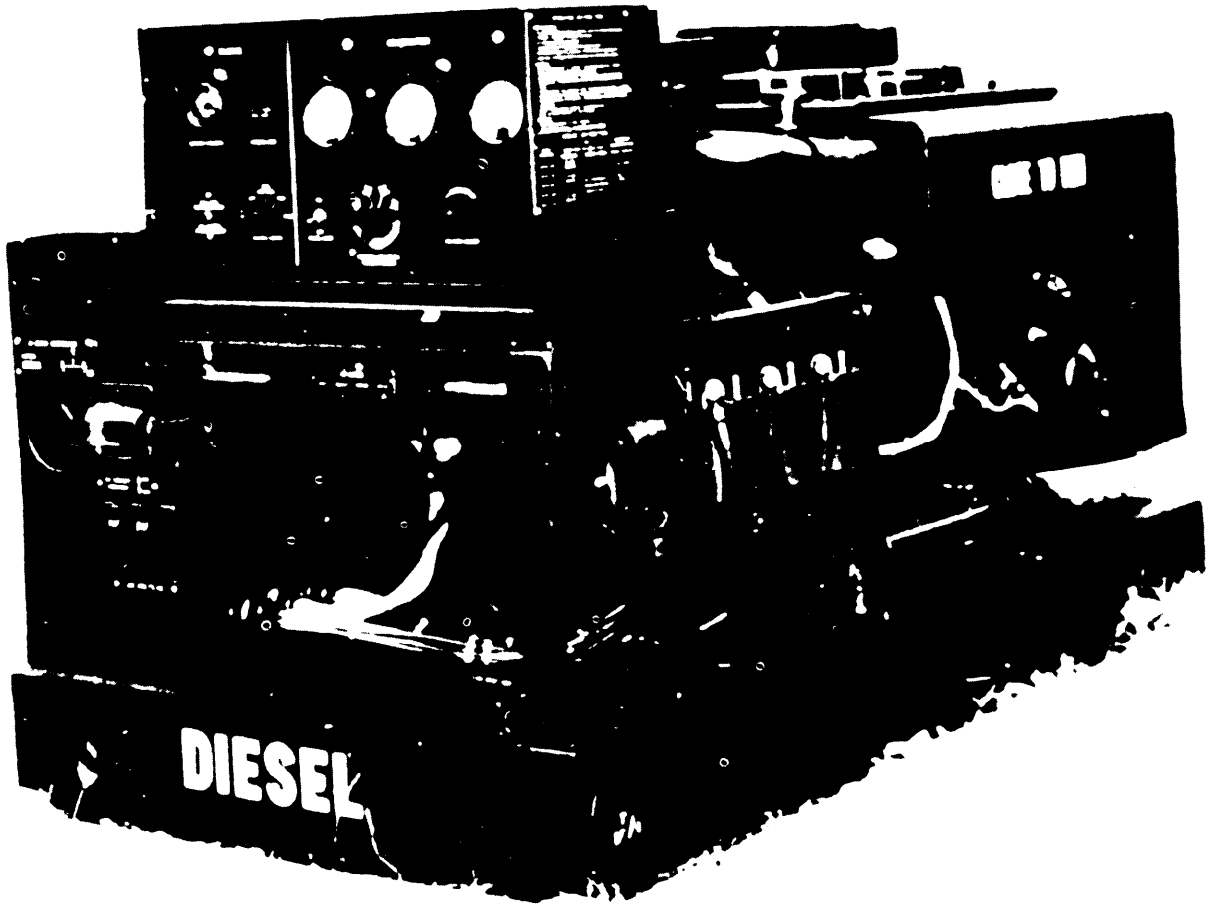

FIGURE 14. MEP-003A (10 kW, 60 Hz, DED).

X-3549



MIL-STD-633E-13  
 22 February 1980

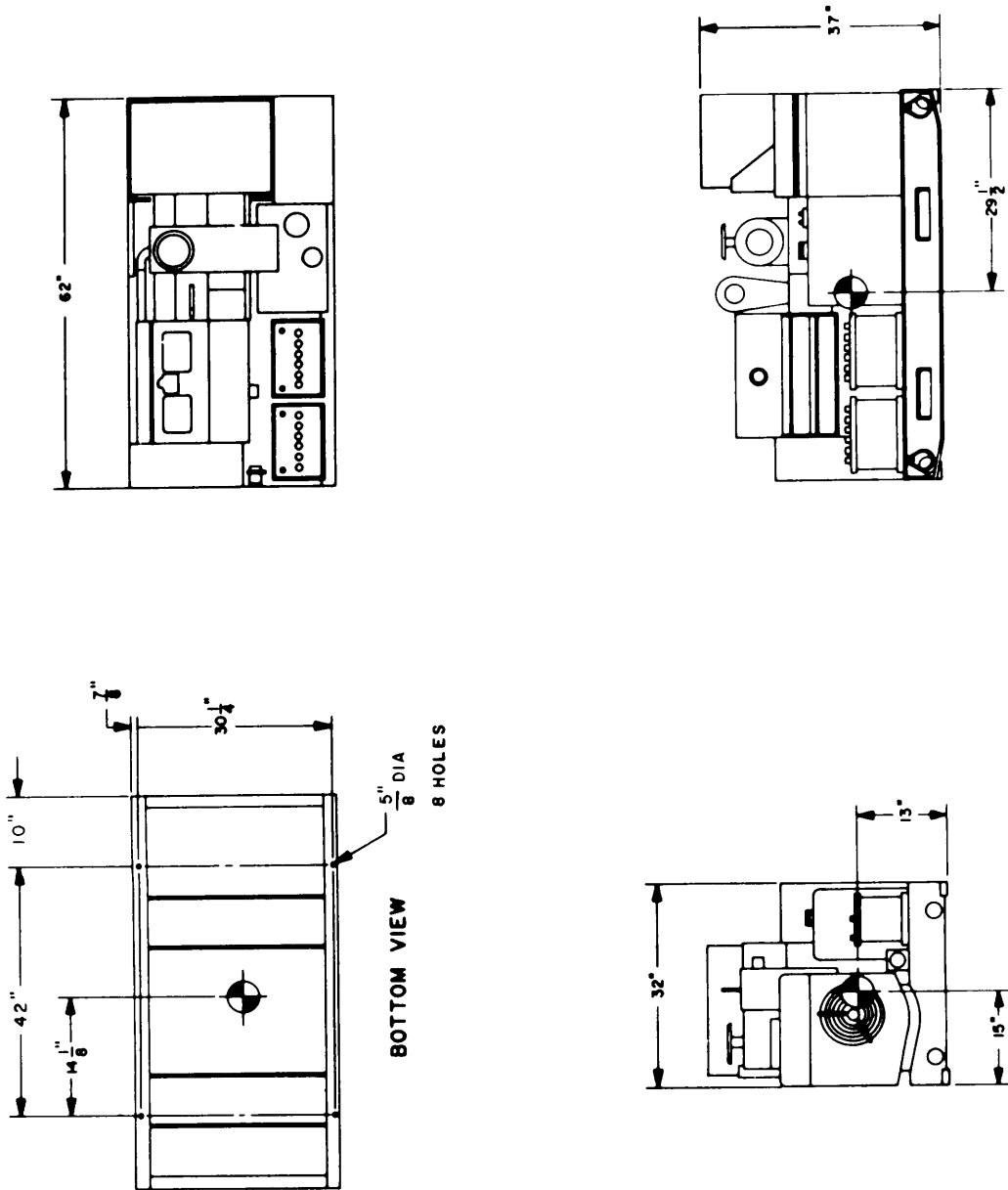

FIGURE 15. MEP-003A (10 kw, 60 Hz, DED).

X-3550

MIL-STD-633E-16  
22 February 1980

MILITARY STANDARD  
MOBILE ELECTRIC POWER  
ENGINE GENERATOR STANDARD FAMILY  
MEP-112A, 10 kW, 400 Hz, DIESEL ENGINE-DRIVEN GENERATOR SET  
CHARACTERISTICS DATA SHEET

CLASSIFICATION

Description: 10 kW @ 0.8 power factor, 400 Hz, 120 V, 240 V, 120/208 V

Model:	MEP-112A	Type:	I (tactical)
NSN:	6115-00-465-1027	Class:	2 (utility)
Spec:	PD, 13 Jul 77	Mode:	II (400 Hz)

PHYSICAL CHARACTERISTICS

Dimensions: See Figures 19 and 20 on pages 85 and 86.

Weight: 1325 lbs (601 kg).

Mobility: Mounted on skid base. Lifting, towing and tie-down attachments provided. Fork lift provision.

Engine: Diesel. Std: MIL-STD-1410. Horsepower: 20 minimum @ 2000 RPM. No. of Cyl: 4. Cycle: 4. Air cooled. 24 VDC electric start. Operating speed: 2000 RPM. Fuel tank capacity: 12.5 gallons (approx 8 hours at rated load). Fuel pump lift: 6 feet.

Fuel:

Primary: VV-F-800; Diesel Fuel Oil, typed DF-1, DF-2 and DF-A.  
Emergency fuel: MIL-T-5624, Aviation Turbine Fuels, grade JP-4.

Electrical:

Drip proof generator enclosure. Fungus and moisture treatment.  
Solid state voltage regulator. Brushless rotary exciter.

Voltage Connection: 120 V, 1 phase, 2 wire. 120/240 V, 1 phase, 3 wire.  
120/208 V, 3 phase, 4 wire.

MIL-STD-633E-16  
 22 February 1980

Protective Devices: Short circuit protection. Overload protection.  
 Low oil pressure cut-off switch. High temperature cut-off switch.

Instrumentation: Voltmeter. Frequency meter. Ammeter. Hourmeter.  
 Oil pressure gage. Battery charging ammeter.

FUNCTIONAL/OPERATIONAL CHARACTERISTICS

Reliability: Mean Time Between Failures (MTBF): 500 hours (specified)

Fuel Consumption: 1.09 gph at rated load.

Electromagnetic Interference: Suppressed to MIL-STD-461 limits.

	<u>Voltage</u>	<u>Frequency</u>
<u>Steady State Stability (variation)</u>		
Short Term (30 see)	2% Bandwidth	2% Bandwidth
Long Term (4 hours)	4% Bandwidth	3% Bandwidth
<u>Transient Performance</u>		
Application of rated load	20% Dip	3% Undershoot
recovery	3 Sec	3 Sec
Rejection of rated load	20% Rise	4% Overshoot
recovery	3 Sec	3 Sec
Application of simulated motor load	35% Dip	
recovery	5 Sec	
<u>Waveform</u>		
Maximum Deviation Factor (single phase)	6%	
(three phase)	5%	
Individual Harmonic (single phase)	3%	
(three phase)	2%	
<u>Regulation:</u>	3%	3%
<u>Adjustment Range for Standard Voltage Connections</u>		
120/208 v Corm:	205 to 220 V.	120/240 V Corm: 228 to 252 V.
120 V, 1 phase Corm:	114 to 126 V.	
<u>Frequency Adjustment Range:</u>	400 Hz:	±5%

MIL-STD-633E-16  
 22 February 1980

ENVIRONMENTAL DATA

Power Output at Environmental Conditions

10 kW, 400 Hz, Sea Level: Minus 25° F (-31.7° C) to plus 125° F (+51.7° C)  
 10 kW, 400 Hz, 5000 feet: Minus 25° F (-31.7° C) to plus 107° F (+41.7° C)  
 8 kW, 400 Hz, 8000 feet: Minus 25° F (-31.7° C) to plus 95° F (+53.9° C)  
 Winterization system extends lower temperature limit to -65° F (-53.9° C)

Shock and Rough Handling: 10 mph railroad impact. 12 inch drop. 12 inch end drop. Truck and trailer transportation.

Attitude: Operate with base level or inclined no more than 15 degrees from level.

Noise Level: 77 dbA @ 25 feet (estimated).

OPTIONAL EQUIPMENT

See 4.4.2 of MIL-STD-633 for additional information on optional equipment

<u>Description</u>	<u>NSN</u>	<u>Weight lbs (kg)</u>	<u>Effect on Dim (ins)</u>
Winterization Kit Aux, Fuel Burning Slave Receptacle	To be determined	350 (158.8) max	Aux: (41x40x26)
Assembly (MS3506)	5935-00-549-4690		Int
Slave Receptacle Assembly (MS75058)	5935-00-295-6403		Int

REFERENCE DOCUMENTS

Technical Manuals:

<u>Army</u>	<u>Air Force</u>	<u>Marine Corps</u>	<u>Navy</u>
TM	TO		<u>NAVFAC</u>
5-6115-585-12	35C2-3-455-1	TM-05684C-12	P-8-623-12
5-6115-585-34	35C2-3-455-2	TM-05684C-34	P-8-623-34
5-6115-585-24P	35C2-3-455-4	SL-4-05684C	P-8-623-24P

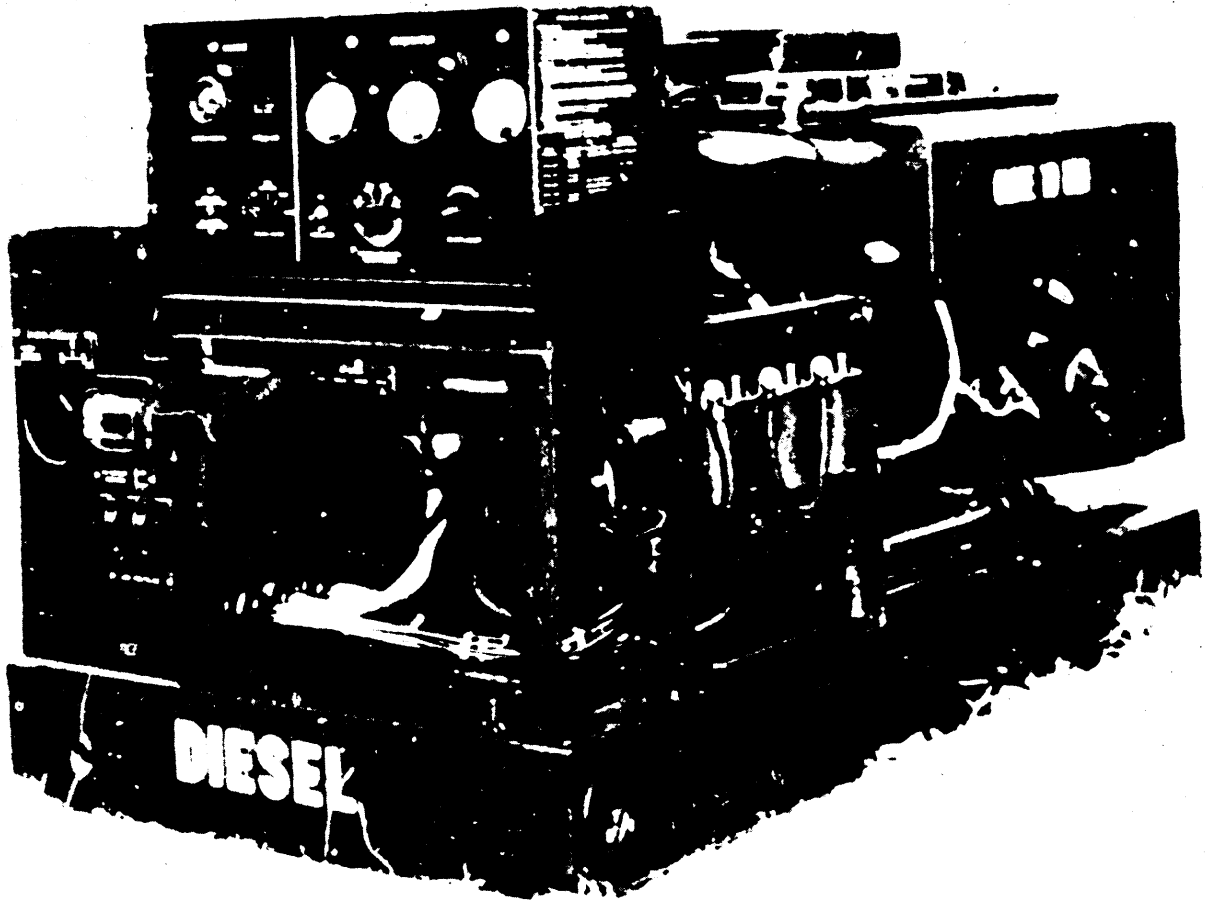

FIGURE 19. MEP-112A (10 kW, 400 Hz, DED).

X-3553

MIL-STD-633E-16  
 22 February 1980

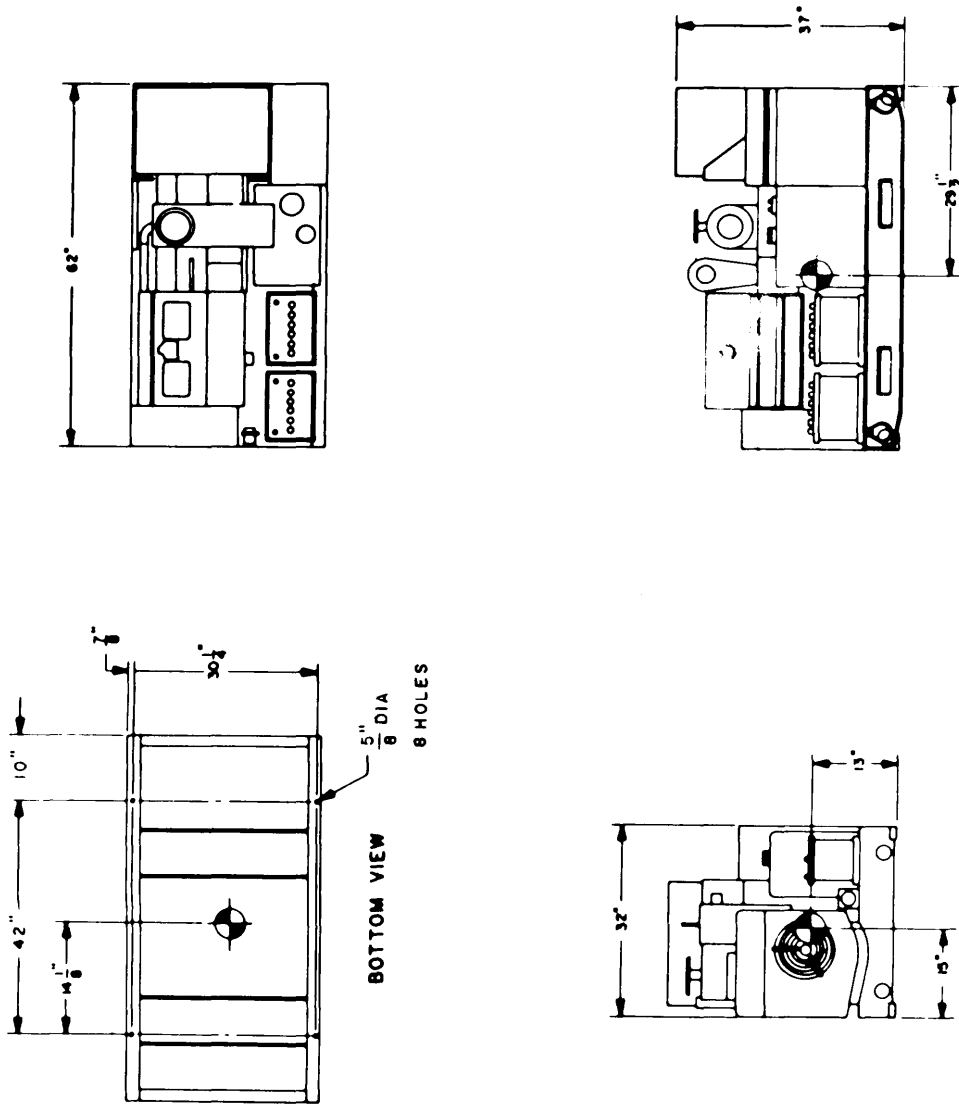

FIGURE 20. MEP-112A (10 kW, 400 Hz, DED).

**X-3554**

MILITARY STANDARD  
MOBILE ELECTRIC POWER  
ENGINE GENERATOR STANDARD FAMILY  
MEP-005A, 30 kW, 50-60 Hz, DIESEL ENGINE-DRIVEN GENERATOR SET  
CHARACTERISTICS DATA SHEET

CLASSIFICATION

Description: 30 kW @ 0.8 power factor, 50/60 Hz, 120/208 V, 240/416 V

Model: MEP-005A	Type: I (tactical)
NSN: 6115-00-118-1240	Class: 2 (utility)
Spec: MIL-G-52884/5	Mode: I (50/60 Hz)

PHYSICAL CHARACTERISTICS

Dimensions: See Figures 29 and 30 on pages 110 and 111.

Weight: 2850 lbs (1293 kg).

Mobility: Fully housed. Mounted on skid base. Lifting and tie-down attachments provided. Fork lift provision.

Engine: Diesel. Std: MIL-STD-1410. Horsepower: 57 @ 1800 RPM. No. of cyl: 6. Cycle: 4. Liquid cooled. 24 VDC electric start. Operating speed: 50 Hz: 1500 RPM, 60 Hz: 1800 RPM. Fuel tank capacity: 26 gallons (approx 8 hours at rated load). Fuel pump lift: 12 feet.

Fuel:

Primary: VV-F-800: Diesel Fuel Oil, types DF-1, DF-2 and DF-A.  
Emergency Fuel: MIL-T-5624, Aviation Turbine Fuels, grades JP-4 and JP-5.

Electrical:

Drip proof generator enclosure. Capable of parallel operation. Fungus and moisture treatment. Solid state voltage regulator. Brushless rotary exciter.

Voltage Connection: 60 Hz: 120/208 V, 3 phase, 4 wire. 240/416 V, 3 phase, 4 Wire. 50 Hz: 120/208 V, 3 phase, 4 wire. 240/416 V, 3 phase, 4 wire.

MIL-STD-633E-21  
 22 February 1980

Protective Devices: Short circuit protection. Overvoltage protection. Overload protection. Reverse power protection. Low oil pressure cut-off switch. High temperature cut-off switch. Low fuel level cut-off switch. Overspeed cut-off switch.

Instrumentation: Voltmeter. Frequency meter. Ammeter. Hourmeter. Wattmeter (% load). Oil pressure gage. Battery charging ammeter (% current). Fault indicating system. Coolant temperature indicator. Fuel level.

FUNCTIONAL/OPERATIONAL CHARACTERISTICS

Reliability: Mean Time Between Failures (MTBF): 670 hours (specified).

Fuel Consumption: 3 gph at rated load.

Electromagnetic Interference: Suppression to MIL-STD-461 limits.

	<u>Voltage</u>	<u>Frequency</u>
<u>Steady State Stability (variation)</u>		
Short Term (30 see)	2% Bandwidth	2% Bandwidth
Long Term (4 hours)	4% Bandwidth	3% Bandwidth
<u>Transient Performance</u>		
Application of rated load	20% Dip	3% Undershoot
recovery	3 Sec	3 Sec
Rejection of rated load	20% Rise	4% Overshoot
recovery	3 Sec	3 Sec
Application of simulated motor load	40% Dip	
recovery	5 Sec	
<u>Waveform</u>		
Maximum Deviation Factor	5%	
Individual Harmonic	2%	
<u>Regulation</u>	3%	2-3% (Adjustable)

Adjustment Range for Standard Voltage Connections

120/208 V Corm: 60 Hz: 197 to 240 V. 50 Hz: 190 to 213 v.  
 240/416 V Corm: 60 Hz: 395 to 480 V. 50 Hz: 380 to 426 V.

Frequency Adjustment Range: 58 to 62 Hz. 48 to 52 Hz.



ENVIRONMENTAL DATA

Power Output at Environmental Conditions:

30 kW, 60 Hz, sea level: Minus 25° F (-31.7° C) to plus 125° F (+51.7° C)  
 30 kW, 60 Hz, 5000 feet: Minus 25° F (-31.7° C) to plus 107° F (+41.7° C)  
 25 kW, 50 Hz, Sea level: Minus 25° F (-31.7° C) to plus 125° F (+51.7° C)  
 25 kW, 50 hz, 5000 feet: Minus 25° F (-31.7° C) to plus 107° F (+41.7° C)  
 Winterization system extends lower temperature limit to minus 65° F (-53.9° C)

Shock and Rough Handling: 10 mph railroad impact. 12 inch end drop. Truck and trailer transportation.

Attitude: Operate with base level or inclined no more than 15 degrees from level.

Noise Level: 82 dbA @ 25 feet.

OPTIONAL EQUIPMENT

SEe 4.4.3 of MIL-STD-633 for additional information on optional equipment.

<u>Description</u>	<u>NSN</u>	<u>Weight lbs(KG)</u>	<u>Effect on Dim (ins)</u>
Wntzn Kit (Fuel burning)		45 (20.4)	Int
Wntzn Kit (Electric)		40 (18.1)	Int
Wntzn Kit, Aux, Fuel burning		350 (158.8)	Aux: (41x40x26)
Wntzn Kit, Aux, Elect		260 (117.9)	Aux: (36x27x19)
Remote Control box		8 (3.6)	Int
Load Bank			Ext: L+9
Wheel Mounting Kit		564 (255.8)	Ext: L+8,W+32,H+9
Panel, Auto, Load Transfer, 60 Hz		825 (374.2)	Aux: (44x19x42)
Paralleling Cable		4 (1.8)	Ext: (L-25 ft)
Relay Assemble, Precise			Int
Spark Arrester Kit		7.5 (3.4)	

REFERENCE DOCUMENTS

Technical Manuals:

<u>Army</u>	<u>Air Force</u>	<u>Marine Corps</u>	<u>N a v y</u>
<u>T M</u>	<u>T O</u>		NAVFAC
5-6115-465-12	35C2-3-446-1	TM-06858B/065859D-12	P-8-625-12
5-6115-465-34	35C-3-446-2	TM-06958B/06859D-34	P-8-625-34
5-6115-465-24P	35C-446-4	SL-4-06858B/06859P	P-8-625-24P
<u>L O</u>			
5-6115-465-12		LO-06858A-06859A-12	

MIL-STD-633E-21  
22 February 1980

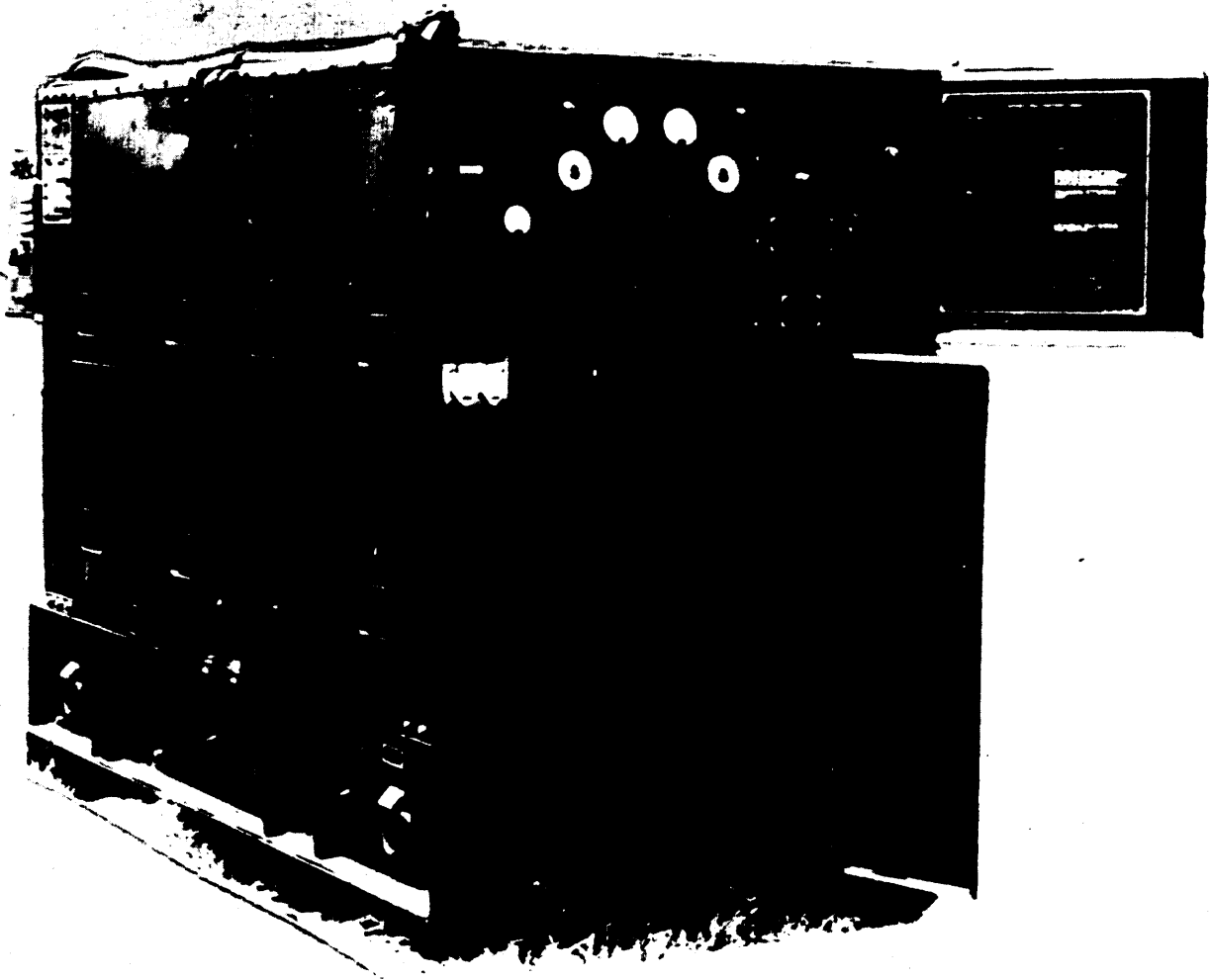
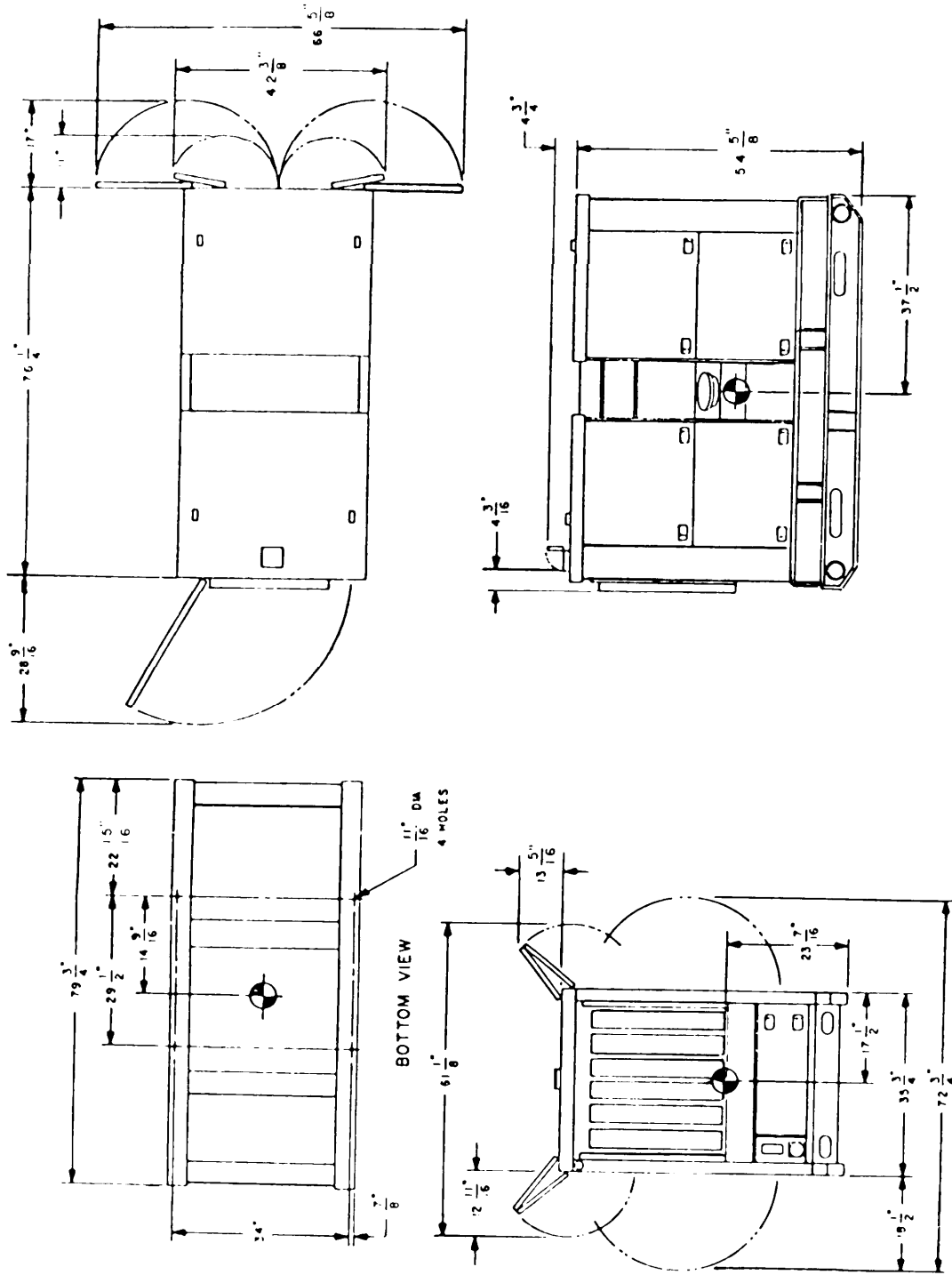

FIGURE 29. MEP-005A (30 kW, 50/60 Hz, DED).

X-3563

MIL-STD-633E-21  
 22 February 1980



**FIGURE 30. MEP-005A (30 kW, 50/60 Hz, DED).**

**X-3564A**

MIL-STD-633E-22  
22 February 1980

MILITARY STANDARD  
MOBILE ELECTRIC POWER  
ENGINE GENERATOR STANDARD FAMILY  
MEP-104A, 30 kW, 50-60 Hz, DIESEL ENGINE-DRIVEN GENERATOR SET  
CHARACTERISTICS DATA SHEET

CLASSIFICATION

Description: 30 kW @ 0.8 power factor, 50/60 Hz, 120/208 V, 240/416 V

Model:	MEP-104A	Type:	I (tactical)
NSN:	6115-00-118-1247	Class:	1 (precise)
Spec:	MIL-G-52884/4	Mode:	I (50/60 Hz)

PHYSICAL CHARACTERISTICS

Dimensions: See Figures 31 and 32 on pages 115 and 116.

Weight: 2850 lbs (1293 kg).

Mobility: Fully housed. Mounted on skid base. Lifting and tie-down attachments provided. Fork lift provision.

Engine: Diesel. Std: MIL-STD-1410. Horsepower: 57 1800 RPM. No. of cyl: 6. Cycle 4. Liquid cooled. 24 VDC electric start. Operating speed: 50 Hz: 1500 RPM, 60 Hz: 1800 RPM. Fuel tank capacity: 26 gallons (approx 8 hours at rated load). Fuel pump lift: 12 feet.

Fuel:

Primary: VV-F-800: Diesel Fuel Oil, types DF-1, DF-2 and DF-A.  
Emergency Fuel: MIL-T-5624, Aviation Turbine Fuels, grades JP-4 and JP-5.

Electrical:

Drip proof generator enclosure. Capable of parallel operation. Fungus and moisture treatment. Solid state voltage regulator. Brushless rotary exciter.

Voltage Connection:

60 Hz: 120/208 v, 3 phase, 4 Wire. 240/416 V, 3 phase, 4 wire.  
50 Hz: 120/208 v, 3 phase, 4 wire. 240/416 V, 3 phase, 4 wire.

Protective Devices: Short circuit protection. Overvoltage protection. Overload protection. Reverse power protection. Low oil pressure cut-off switch. High temperature cut-off switch. Low fuel level cut-off switch. Overspeed cut-off switch.

Instrumentation: Voltmeter. Frequency meter. Ammeter. Hourmeter. Wattmeter (% load). Oil pressure gage. Battery charging ammeter (% current). Fault indicating system. Coolant temperature indicator. Fuel level.

FUNCTIONAL/OPERATIONAL CHARACTERISTICS

Reliability: Mean Time Between Failures (MTBF): 370 hours (specified).

Fuel Consumption: 3 gph at rated load.

Electromagnetic Interference: Suppression to MIL-STD-461 limits.

<u>Steady State Stability (variation)</u>	<u>Voltage</u>	<u>Frequency</u>
Short Term (30 see)	1% Bandwidth	0.5% Bandwidth
Long Term (4 hours)	2% Bandwidth	1% Bandwidth
 <u>Transient Performance</u>		
Application of rated load	15% Dip	1.5% Undershoot
recovery	0.5 Sec	1 Sec
Rejection of rated load	15% Rise	1.5% Overshoot
recovery	0.5 Sec	1 Sec
Application of simulated motor load	30% Dip	
recovery	0.7 Sec	
 <u>Waveform</u>		
Maximum Deviation Factor	5%	
Individual Harmonic	2%	
 <u>Regulation</u>	1%	0.25%

Adjustment Range for Standard Voltage Connections

120/208 v Corm: 60 Hz: 197 to 240 V. 50 Hz: 190 to 213 v.  
 240/416 V Corm: 60 Hz: 395 to 480 V. 50 Hz: 380 to 426 V.

Frequency Adjustment Range:  
 58 to 62 Hz. 48 to 52 Hz.

MIL-STD-633E-22  
 22 February 1980

ENVIRONMENTAL DATA

Power Output at Environmental Conditions:

30 kW, 60 Hz, Sea level: Minus 25° F (-31.7° C) to plus 125° F (+51.7° C)  
 30 kW, 60 Hz, 5000 feet: Minus 25° F (-31.7° C) to plus 107° F (+41.7° C)  
 25 kW, 50 Hz, Sea level: Minus 25° F (-31.7° C) to plus 125° F (+51.7° C)  
 25 kW, 50 Hz, 5000 feet: Minus 25° F (-31.7° C) to plus 107° F (+41.7° C)  
 Winterization system extends lower temperature limit to minus 65° F (-53.9° C).

Shock and Rough Handling: 10 mph railroad impact. 12 inch end drop. Truck and trailer transportation.

Attitude: Operate with base level or inclined no more than 15 degrees from level.

Noise Level: 82 dbA @ 25 feet.

OPTIONAL EQUIPMENT

See 4.4.3 of MIL-STD-633 for additional information on optional equipment.

<u>Description</u>	<u>NSN</u>	<u>Weight lbs (kg)</u>	<u>Effect on Dim (ins)</u>
Wntzn Kit (Fuel burning)	6115-00-463-9083	45 (20.4)	Int
Wntzn Kit (Electric)	6115-00-463-9085	110 (18.1)	Int
Wntzn Kit, Aux, Fuel burning	6115-00-463-9098	350 (158.8)	Aux: (41x40x26)
Wntzn Kit, Aux, Elect.	6115-00-463-9099	260 (117.9)	Aux: (36x27x19)
Remote Control Box	6115-00-420-8490	8 (3.6)	Int
Load Bank	6115-00-463-9088		Ext: L+9
Wheel Mounting Kit Panel, Auto, Load Transfer, 60 Hz	6115-00-477-7932	825 (374.2)	Aux: (44x19x42)
Spark Arrester Kit	2990-01-032-0756	7.5 (304)	Ext: L+12

REFERENCE DOCUMENTS

Technical Manuals:

<u>Army</u>	<u>Air Force</u>	<u>Marine Corps</u>	<u>Navy</u>
TM	TO		<u>NAVFAC</u>
5-6115-465-12	35C2-3-446-1	TM-06858B/065859D-12	P-8-625-12
5-6115-465-34	35C2-3-446-2	TM-06958B/06859D-34	P-8-625-34
5-6115-465-24P	35C2-3-446-4	SL-4-06858B/06859p	P-8-625-24P
LO			
5-6115-465-12		LO-06858A-06859A-12	

MIL-STD-633E-22  
22 February 1980

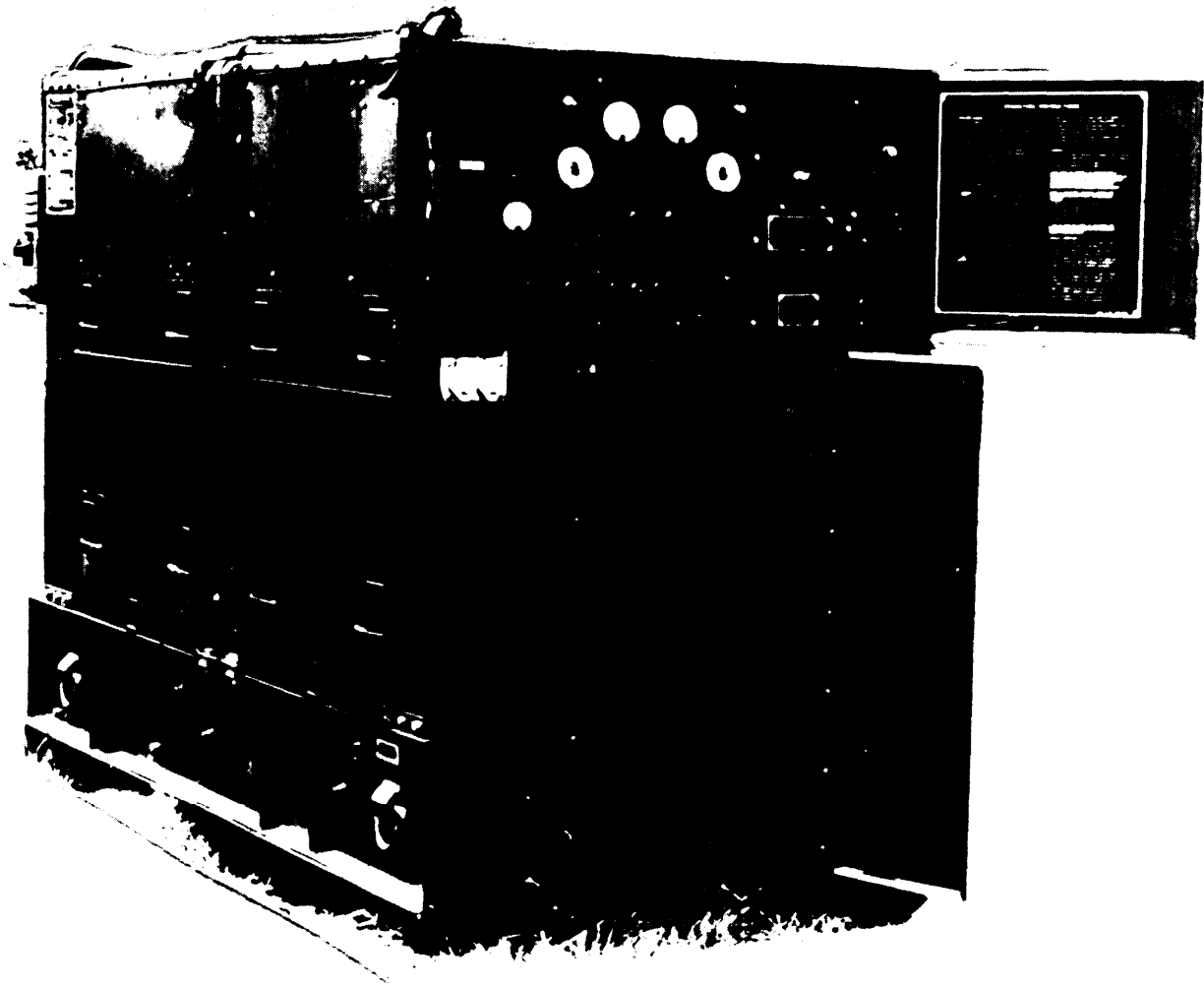
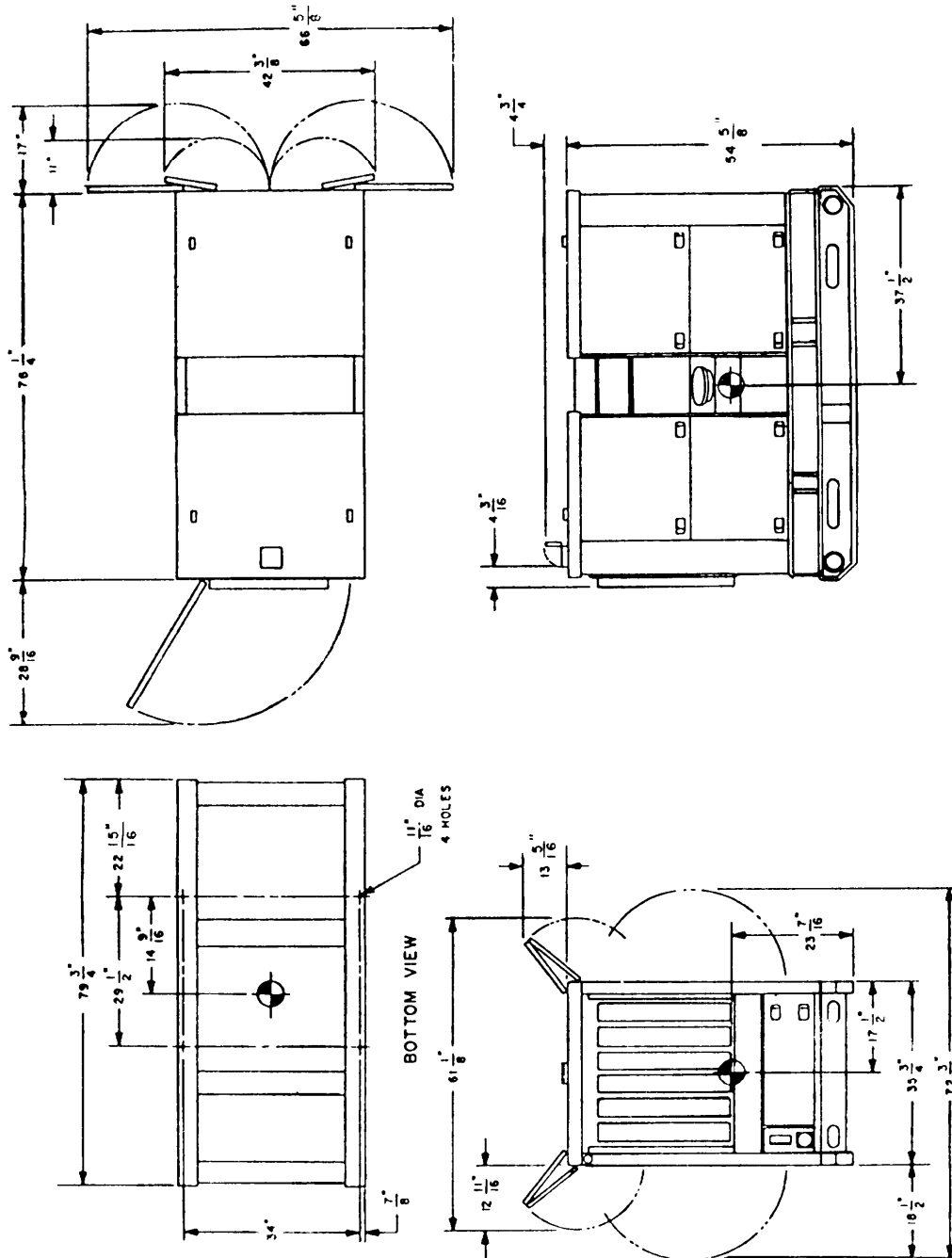

FIGURE 31 MEP-104A (30 kW, 50/60 Hz, DED):

X-3565

MIL-STD-633E-22  
 22 February 1980



**FIGURE 32. MEP-104A (30 kW, 50/60 Hz, DED).**

**X-35666A**



MIL-STD-633E-23  
22 February 1980

MILITARY STANDARD  
MOBILE ELECTRIC POWER  
ENGINE GENERATOR STANDARD FAMILY  
MEP-114A, 30 kW, 400 Hz, DIESEL ENGINE-DRIVEN GENERATOR SET  
CHARACTERISTICS DATA SHEET

CLASSIFICATION

Description: 30 kW @ 0.8 power factor, 400 Hz, 120/208 V, 240/416 V

Model:	MEP-114A	Type:	I (tactical)
NSN:	6115-00-118-1248	Class:	1 (precise)
Spec:	MIL-G-52884/6	Mode:	II (400 Hz)

PHYSICAL CHARACTERISTICS

Dimensions: See Figures 33 and 34 on pages 120 and 121.

Weight: 3000 lbs (1360.8 kg).

Mobility: Fully housed. Mounted on skid base. Lifting and tie-down attachments provided. Fork lift provision.

Engine: Diesel. Std: MIL-STD-1410. Horsepower: 64 @ 2000 RPM. No. of cylinders: 6. Cycle: 4. Liquid cooled. 24 VDC electric start. Operating speed: 400 Hz: 2000 RPM. Fuel tank capacity: 26 gallons (approx 8 hours at rated load). Fuel pump lift: 12 feet.

Fuel:

Primary: VV-F-800; Diesel Fuel Oil, types DF-1, DF-2 and DF-A.  
Emergency Fuel: MIL-T-5624, Aviation Turbine Fuels, grades JP-4 and JP-5.

Electrical:

Drip proof generator enclosure. Capable of parallel operation. Fungus and moisture treatment. Solid state voltage regulator. Brushless rotary exciter.

Voltage Connection:

400 Hz: 120/208 V, 3 phase, 4 wire. 240/416 V, 3 phase, 4 wire.

MIL-STD-633E-22  
 22 February 1980

Protective Devices: Short circuit protection Overvoltage protection.  
 Overload protection Reverse power protection Low oil pressure cut-off  
 switch. High temperature cut-off switch Low fuel level cut-off switch.  
 Overspeed cut-off switch.

Instrumentation: Voltmeter. Frequency meter Ammeter. Hourmeter. Wattmeter  
 (% load). Oil pressure gage. Battery charging ammeter (% current Fault  
 indicating system Coolant temperature indicator Fuel level.

FUNCTIONAL/OPERATIONAL CHARACTERISTICS

Reliability: Mean Time Between Failure (MTBF) 370 hours (specified).

Fuel Consumption: 3 gph at rated load.

Electromagnetic Interference suppression to MIL-STD-461 limits.

<u>Steady State Stability (variation)</u>	<u>Voltage</u>	<u>Frequency</u>
Short Term (30 see)	1% Bandwidth	0.5% Bandwidth
Long Term (4 hours)	2% Bandwidth	1% Bandwidth

<u>Transient Performance</u>	<u>Voltage</u>	<u>Frequency</u>
Application of rated load	12% Dip	1.5% Undershoot
recovery	0.5 Sec	1 Sec
Rejection of rated load	12% Rise	1.5% Overshoot
recovery	0.5 Sec	1 Sec
Application of simulated motor load	25% Dip	
recovery	0.7 See	

<u>Waveform</u>	<u>Voltage</u>	<u>Frequency</u>
Maximum Deviation Factor	5%	
Individual Harmonic	2%	

<u>Regulation</u>	<u>Voltage</u>	<u>Frequency</u>
	1%	0.25%

Adjustment Range for Standard Voltage Connections

120/208 v Corm: 60 Hz: 197 to 229 V.  
 240/416 V Corm: 60 Hz: 395 to 458 V.

Frequency Adjustment Range: 390 to 420 Hz.

ENVIRONMENTAL DATA

Power Output at Environmental Conditions:

30 kW, 400 Hz, Sea level: Minus 25° F (-31.7° C) to plus 125° F (+51.7° C)  
 30 kW, 400 HZ, 5000 feet: Minus 25° F (-31.7° C) to plus 107° F (+41.7° C)  
 Winterization system extends lower temperature limit to -65° F (-53.9° C).

Shock and Rough Handling: 10 mph railroad impact. 12 inch end drop. Truck and trailer transportation.

Attitude: Operate with base level or inclined no more than 15 degrees from level.

Noise Level: 82 dbA @ 25 feet.

OPTIONAL EQUIPMENT

See 4.4.3 of MIL-STD-633 for additional information on optional equipment.

<u>Description</u>	<u>NSN</u>	<u>Weight lbs (kg)</u>	<u>Effect on Dim (ins)</u>
Wntzn Kit (Fuel burning)	6115-00-463-9083	45 (20.4)	Int
Wntzn Kit (Electric)	6115-00-463-9085	40 (18.1)	Int
Wntzn Kit, Aux, Fuel burning	6115-00-463-9098	350 (158.8)	Aux: (41x40x26)
Wntzn Kit, Aux, Elect.	6115-00-463-9099	260 (117.9)	Aux: (36x27x19)
Remote Control Box	6115-00-420-8490	8 (3.6)	Int
Load Bank	6115-00-463-9088		Ext: L+9
Wheel Mounting Kit Panel, Auto Standby, 400 Hz	6115-00-463-9094	564 (255.8)	Ext: L+8,W+32,H+9
Spark Arrester Kit	6115-00-463-9096	12 (5.4)	Int:
	2990-01-032-0756	7.5 (3.4)	Ext: L+12

REFERENCE DOCUMENTS

Technical Manuals:

<u>Army</u>	<u>Air Force</u>	<u>Marine Corps</u>	<u>Navy</u>
TM	TO		<u>NAVFAC</u>
5-6115-465-12	35C2-3-446-1	TM-06858B/065859D-12	P-8-625-12
5-6115-465-34	35C2-3-446-2	TM-06958B/06859D-34	P-8-625-34
5-6115-465-24P	35C2-3-446-4	SL-4-06858B/06859P	P-8-625-24P
LO			
5-6115-465-12		LO-06858A-06859A-12	

MIL-STD-633E-23  
22 February 1980

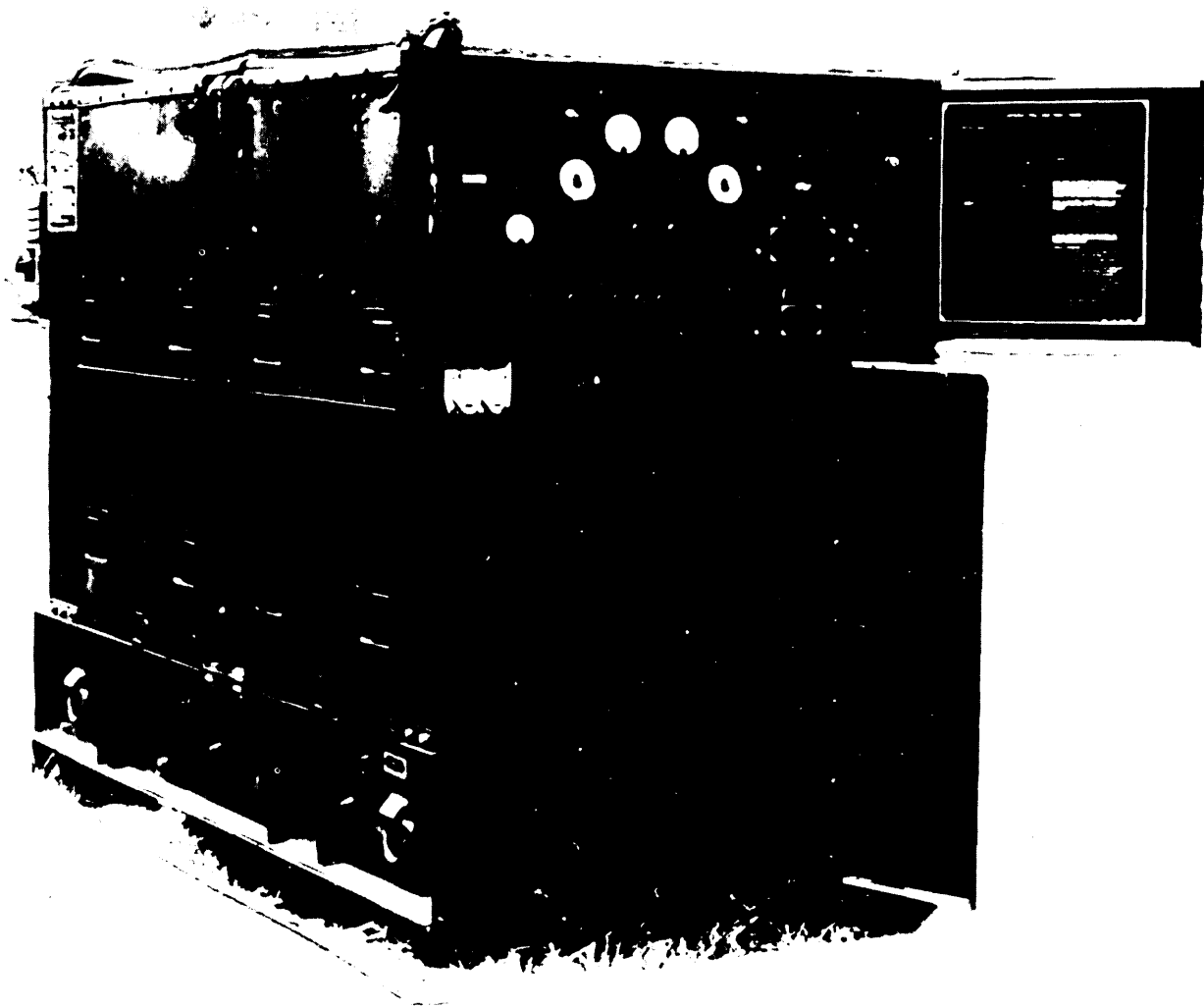

FIGURE 33. MEP-114A (30 kW, 400 Hz, DED).

X-3567

MIL-STD-633E-23  
 22 February 1980

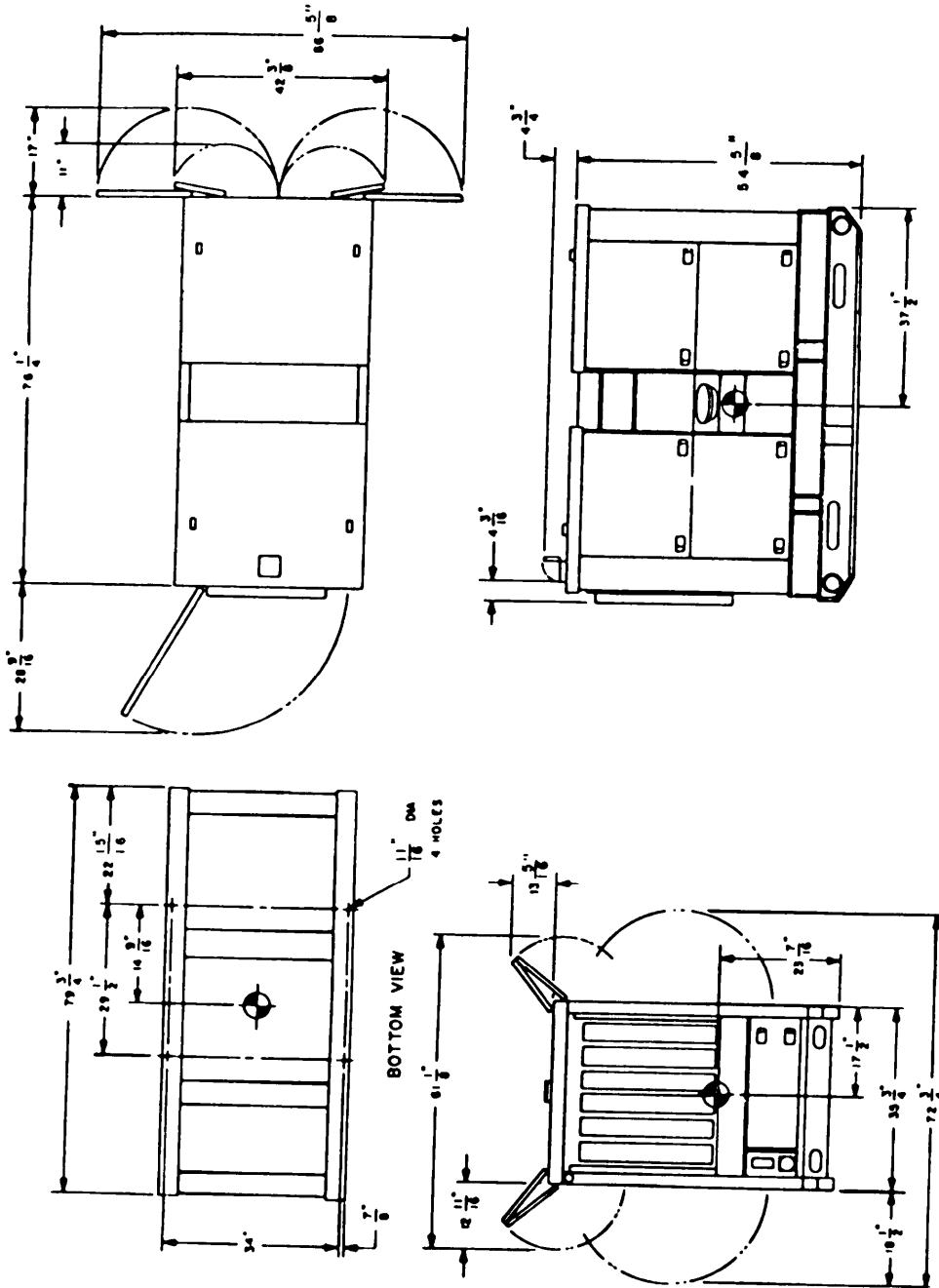

FIGURE 34. MEP-114A (30 kW, 400 Hz, DED).

X-3568A

MIL-STD-633E-24  
22 February 1980

MILITARY STANDARD  
MOBILE ELECTRIC POWER  
ENGINE GENERATOR STANDARD FAMILY  
MEP-006A, 60 kW, 50-60 Hz, DIESEL ENGINE-DRIVEN GENERATOR SET  
CHARACTERISTICS DATA SHEET

CLASSIFICATION

Description: 60 kW @ 0.8 power factor, 50/60 Hz, 120/208 V, 240/416 V

Model:	MEP-006A	Type:	I (tactical)
NSN:	6115-00-118-1243	Class:	2 (utility)
Spec:	MIL-G-52884/8	Mode:	I (50/60 Hz)

PHYSICAL CHARACTERISTICS

Dimensions: See Figures 35 and 36 on pages 125 and 126.

Weight: 4240 lbs (1923 kg).

Mobility: Fully housed. Mounted on skid base. Lifting and tie-down attachments provided. Fork lift provision.

Engine: Diesel. Std: MIL-STD-1410. Horsepower: 167 @ 1800 RPM. No. of Cyl: 6. Cycle 4. Liquid cooled. 24 VDC electric start. Operating speed: 50 Hz: 1500 RPM, 60 Hz: 1800 RPM. Fuel tank capacity: 55 gallons (approx 8 hours at rated load). Fuel pump lift: 12 feet.

Fuel:

Primary: VV-F-800; Diesel Fuel Oil, types DF-1, DF-2 and DF-A.

Emergency Fuel: MIL-T-5624, Aviation Turbine Fuels, grades JP-4 and JP-5.

Electrical:

Drip proof generator enclosure. Capable of parallel operation. Fungus and moisture treatment. Solid state voltage regulator. Brushless rotary exciter.

Voltage Connection:

60 Hz:	120/208 V, 3 phase, 4 wire.	240/416 V, 3 phase, 4 wire.
50 Hz:	120/208 V, 3 phase, 4 wire.	240/416 V, 3 phase, 4 wire.

MIL-STD-633E-24  
 22 February 1980

Protective Devices: Short circuit protection. Overvoltage protection. Overload protection. Reverse power protection. Low oil pressure cut-off switch. High temperature cut-off switch. Low fuel level cut-off switch. Overspeed cut-off switch.

Instrumentation: Voltmeter. Frequency meter. Ammeter. Hourmeter. Wattmeter (% load). Oil pressure gage. Battery charging ammeter (% current). Fault indicating system. Coolant temperature indicator. Fuel level.

FUNCTIONAL/OPERATIONAL CHARACTERISTICS

Reliability: Mean Time Between Failures (MTBF): 500 hours (specified).

Fuel Consumption: 6 gph at rated load.

Electromagnetic Interference: Suppression to MIL-STD-461 limits.

<u>Steady State Stability (variation)</u>	<u>Voltage</u>	<u>Frequency</u>
Short Term (30 see)	2% Bandwidth	2% Bandwidth
Long Term (4 hours)	4% Bandwidth	3% Bandwidth
 <u>Transient Performance</u>		
Application of rated load recovery	20% Dip 3 Sec	3% Undershoot 3 Sec
Rejection of rated load recovery	20% Rise 3 Sec	4% Overshoot 3 Sec
Application of simulated motor load recovery	40% Dip 5 Sec	
 <u>Waveform</u>		
Maximum Deviation Factor	5%	
Individual Harmonic	2%	
 <u>Regulation</u>	 3%	 2-3% (Adjustable)

Adjustment Range for Standard Voltage Connections

120/208 v Corm: 60 Hz: 197 to 240 V. 50 Hz: 190 to 213 v.  
 240/416 V Corm: 60 Hz: 395 to 480 V. 50 Hz: 380 to 425 V.

Frequency Adjustment Range: 58 to 62 Hz. 48 to 52 Hz.

MIL-STD-633E-24  
 22 February 1980

ENVIRONMENTAL DATA

Power Output at Environmental Conditions:

60 kW, 60 Hz, Sea Level: Minus 25° F (-31.7° C) to plus 125° F (+51.7° C)  
 60 kW, 60 Hz, 5000 feet: Minus 25° F (-31.7° C) to plus 107° F (+41.7° C)  
 50 kW, 50 Hz, Sea Level: Minus 25° F (-31.7° C) to plus 125° F (+51.7° C)  
 50 kW, 50 Hz, 5000 feet: Minus 25° F (-31.7° C) to plus 107° F (+41.7° C)  
 Winterization system extends lower temperature limit to minus 65° F (-53.9° C).

Shock and Rough Handling 10 mph railroad impact 12 inch end drop. Truck and trailer transportation.

Attitude: Operate with base level or inclined no more than 15 degrees from level.

Noise Level: 86 dbA @ 25 feet.

OPTIONAL EQUIPMENT

See 4.4.3 of MIL-STD-633 for additional information on optional equipment.

<u>Description</u>	<u>NSN</u>	<u>Weight lbs (kg)</u>	<u>Effect on Dim (ins)</u>
Wntzn Kit (Fuel burning)	6115-00-407-8314	45 (20.4)	Int
Wntzn Kit (Electric)	6115-00-455-7693	40 (18.1)	Int
Wntzn Kit, Aux, Fuel burning	6115-00-463-9098	350 (158.8)	Aux: (41x40x26)
Wntzn Kit, Aux, Elect.	6115-00-463-9099	260 (117.9)	Aux: (36x27x19)
Remote Control Box	6115-00-420-8490	8 (3.6)	Int
Load Bank	6115-00-407-8322	272 (123.4)	Ext: H+15
Wheel Mounting Kit Panel, Auto, Load Transfer, 60 Hz	6115-00-463-9092	564 (255.8)	Ext: L+8, W+32, H+9
Paralleling Cable	6115-00-477-7932	825 (374.2)	Aux: (44x19x42)
Relay Assembly, Precise	6140-00-197-4934	4 (1.8)	Ext: (L=25 ft)
	6115-00-276-7622		Int

REFERENCE DOCUMENTS

Technical Manuals:

<u>Army</u>	<u>Air Force</u>	<u>Marine Corps</u>	<u>Navy</u>
TM	TO		<u>NAVFAC</u>
5-6115-545-12	35C2-3-444-1	TM-00038G-12	P-8-626-12
5-6115-545-34	35C2-3-444-2	TM-00038G-35	P-8-626-34
5-6115-545-24P	35C2-3-444-4	SL-00038G	P-8-626-24P
LO			
5-6115-545-12			



MIL-STD-633E-24  
22 February 1980

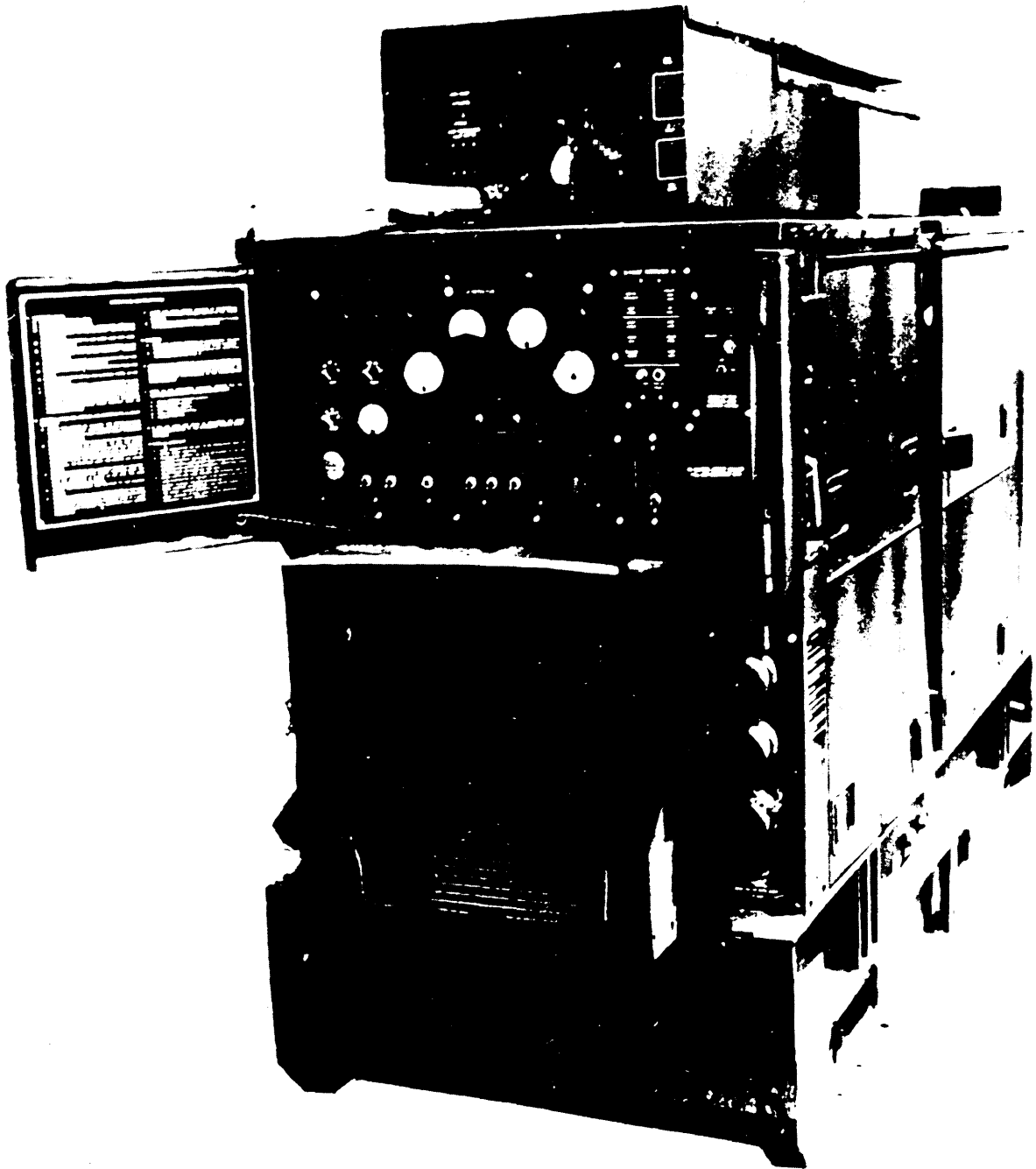
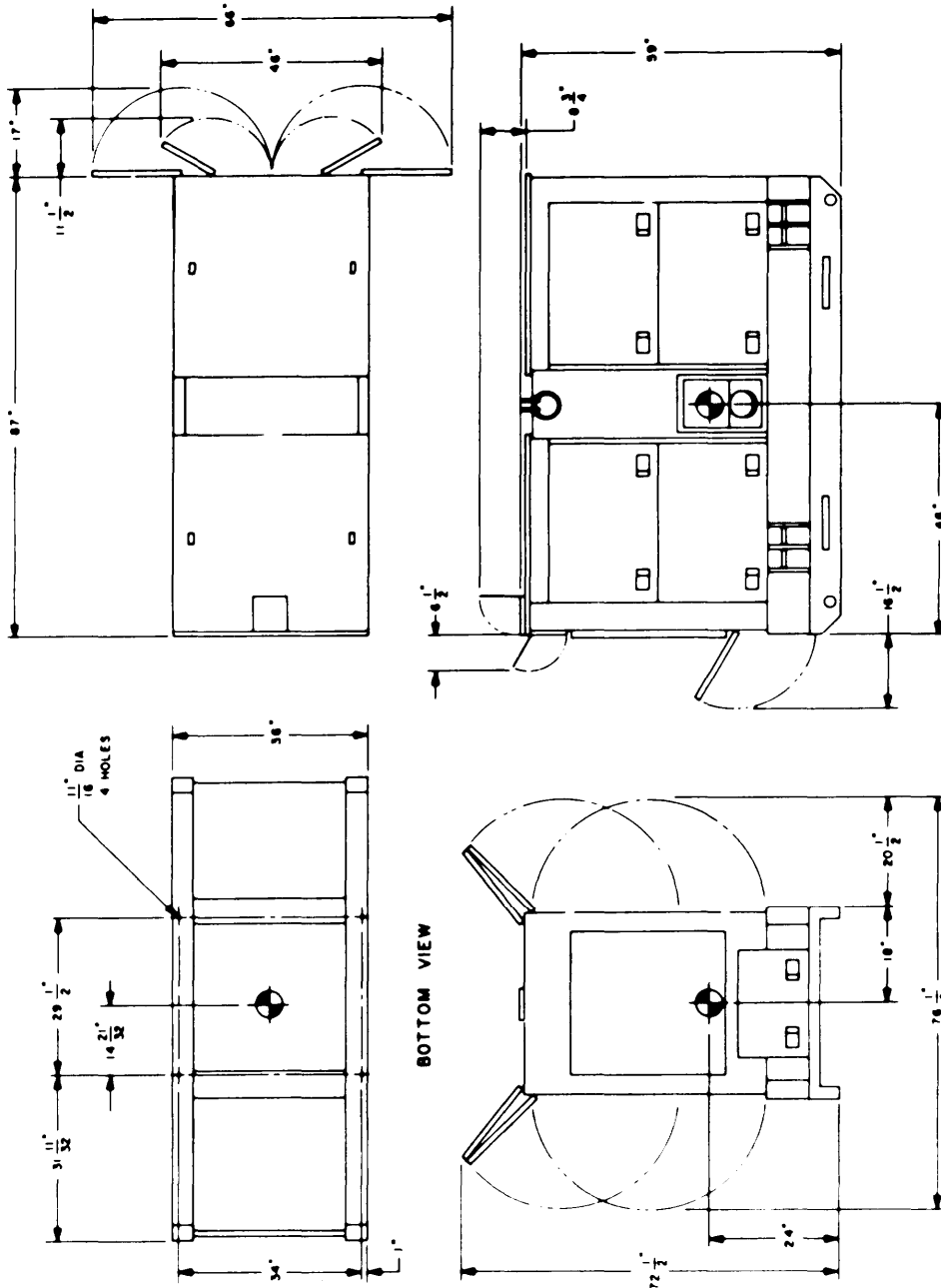

FIGURE 35. MEP-006A (60 kW, 50/60 Hz, DED).

X-3569

MIL-STD-633E-24  
 22 February 1980



**X-3570**

FIGURE 36. MEP-006A (60 kV, 50/60 Hz, DED).

MIL-STD-633E-25  
22 February 1980

MILITARY STANDARD  
MOBILE ELECTRIC POWER  
ENGINE GENERATOR STANDARD FAMILY  
MEP-105A, 60 kW, 50-60 Hz, DIESEL ENGINE-DRIVEN GENERATOR SET  
CHARACTERISTICS DATA SHEET

CLASSIFICATION

Description: 60 kW @ 0.8 power factor, 50/60 Hz, 120/208 v, 240/416 v.

Model: MEP-105A	Type: I (tactical)
NSN: 6115-00-118-1252	Class: 1 (precise)
Spec: MIL-G-52884/7	Mode: I (50/60 Hz)

PHYSICAL CHARACTERISTICS

Dimensions: See figures 37 and 38 on pages 130 and 131.

Weight: 4300 lbs (1950 kg).

Mobility: Fully housed. Mounted on skid base. Lifting and tie-down attachments provided. Fork lift provision.

Engine; Diesel. Std: MIL-STD-1410. Horsepower: 167 @ 1800 RPM. No. of Cyl: 6. Cycle: 4. Liquid cooled. 24 VDC electric start. Operating speed: 50 Hz: 1500 RPM, 60 Hz: 1800 RPM. Fuel tank capacity: 55 gallons (approx 8 hours at rated load). Fuel pump lift: 12 feet.

Fuel:

Primary: VV-F-800; Diesel Fuel Oil, types DF-1, DF-2 and DF-A.  
Emergency Fuel: MIL-T-5624, Aviation Turbine Fuels, grades JP-4 and JP-5.

Electrical:

Drip proof generator enclosure. Capable of parallel operation. Fungus and moisture treatment. Solid state voltage regulator. Brushless rotary exciter.

Voltage Connection:

60 Hz: 120/208 V, 3 phase, 4 wire. 240/416 V, 3 phase, 4 wire.  
50 Hz: 120/208 V, 3 phase, 4 wire. 240/416 V, 3 phase, 4 wire.

MIL-STD-633E-25  
 22 February 1980

Protective Devices Short circuit protection Overvoltage protection.  
 Overload protection Reverse power protection Low oil pressure cut-off  
 switch. High temperature cut-off switch Low fuel level cut-off switch.  
 Overspeed cut-off switch.

Instrumentation: Voltmeter. Frequency meter Ammeter. Hourmeter. Wattmeter  
 (% load). Oil pressure gage. Battery charging ammeter (% current Fault  
 indicating system Coolant temperature indicator Fuel level.

FUNCTIONAL/OPERATIONAL CHARACTERISTICS

Reliability: Mean Time Between Failure (MTBF) 420 hours (specified).

Fuel Consumption 6 gph at rated load.

Electromagnetic Interference Suppression to MIL-STD-461 limits.

<u>Steady State Stability (variation)</u>	<u>Voltage</u>	<u>Frequency</u>
Short Term (30 see)	1% Bandwidth	0.5% Bandwidth
Long Term (4 hours)	2% Bandwidth	1% Bandwidth
 <u>Transient Performance</u>		
Application of rated load	15% Dip	1.5% Undershoot
recovery	0.5 Sec	1 Sec
Rejection of rated load	15% Rise	1.5% Overshoot
recovery	0.5 Sec	1 Sec
Application of simulated motor load	30% Dip	
recovery	0.7 Sec	
 <u>Waveform</u>		
Maximum Deviation Factor	5%	
Individual Harmonic	2%	
 <u>Regulation</u>	1%	0.25%

Adjustment Range for Standard Voltage Connections

120/208 V Corm: 60 Hz: 197 to 240 V. 50 Hz: 190 to 213 v.  
 240/416 V Corm: 60 Hz: 395 to 480 V. 50 Hz: 380 to 426 V.

Frequency Adjustment Range: 58 to 62 Hz. 48 to 52 Hz.

MIL-STD-633E-25  
 22 February 1980

ENVIRONMENTAL DATA

Power Output at Environmental Conditions:

60 kW, 60 Hz, Sea Level: Minus 25° F (-31.7° C) to plus 125° F (+51.7° C)  
 60 kW, 60 Hz, 5000 feet: Minus 25° F (-31.7° C) to plus 107° F (+41.7° C)  
 50 kW, 50 Hz, Sea Level: Minus 25° F (-31.7° C) to plus 125° F (+51.7° C)  
 50 kW, 50 Hz, 5000 feet: Minus 25° F (-31.7° C) to plus 107° F (+41.7° C)  
 Winterization system extends lower temperature limit to minus 65° F (-53.9° C).

Shock and Rough Handling: 10 mph railroad impact. 12 inch end drop. Truck and trailer transportation.

Attitude: Operate with base level or inclined no more than 15 degrees from level.

Noise Level: 86 dbA @ 25 feet.

OPTIONAL EQUIPMENT

See 4.4.3 of MIL-STD-633 for additional information on optional equipment.

<u>Description</u>	<u>NSN</u>	<u>Weight lbs (kg)</u>	<u>Effect on Dim (ins)</u>
Wntzn Kit (Fuel burning)	6115-00-407-8314	45 (20.4)	Int
Wntzn Kit (Electric)	6115-00-455-7693	40 (18.1)	Int
Wntzn Kit, Aux, Fuel burning	6115-00-463-9098	350 (158.8)	Aux: (41x40x26)
Wntzn Kit, Aux, Elect.	6115-00-463-9099	260 (117.9)	Aux: (36x27x19)
Remote Control Box	6115-00-420-8490	8 (3.6)	Int
Load Bank	6115-00-407-8322	272 (123.4)	Ext: H+15
Wheel Mounting Kit	6115-00-463-9092	564 (255.8)	Ext: L+8, W+32, H+9
Panel, Auto, Load Transfer, 60 Hz	6115-00-477-7932	825 (374.2)	Aux: (44x19x42)

REFERENCE DOCUMENTS

Technical Manuals:

Army	Air Force	Marine Corps	Navy
TM	TO		<u>NAVFAC</u>
5-6115-545-12	35C2-3-444-1	TM-00038G-12	P-8-626-12
5-6115-545-34	35C2-3-444-2	TM-00038G-35	P-8-626-34
5-6115-545-24P	35C2-3-444-4	SL-00038G	P-8-626-24P
LO			
5-6115-545-12			

MIL-STD-633E-25  
22 February 1980

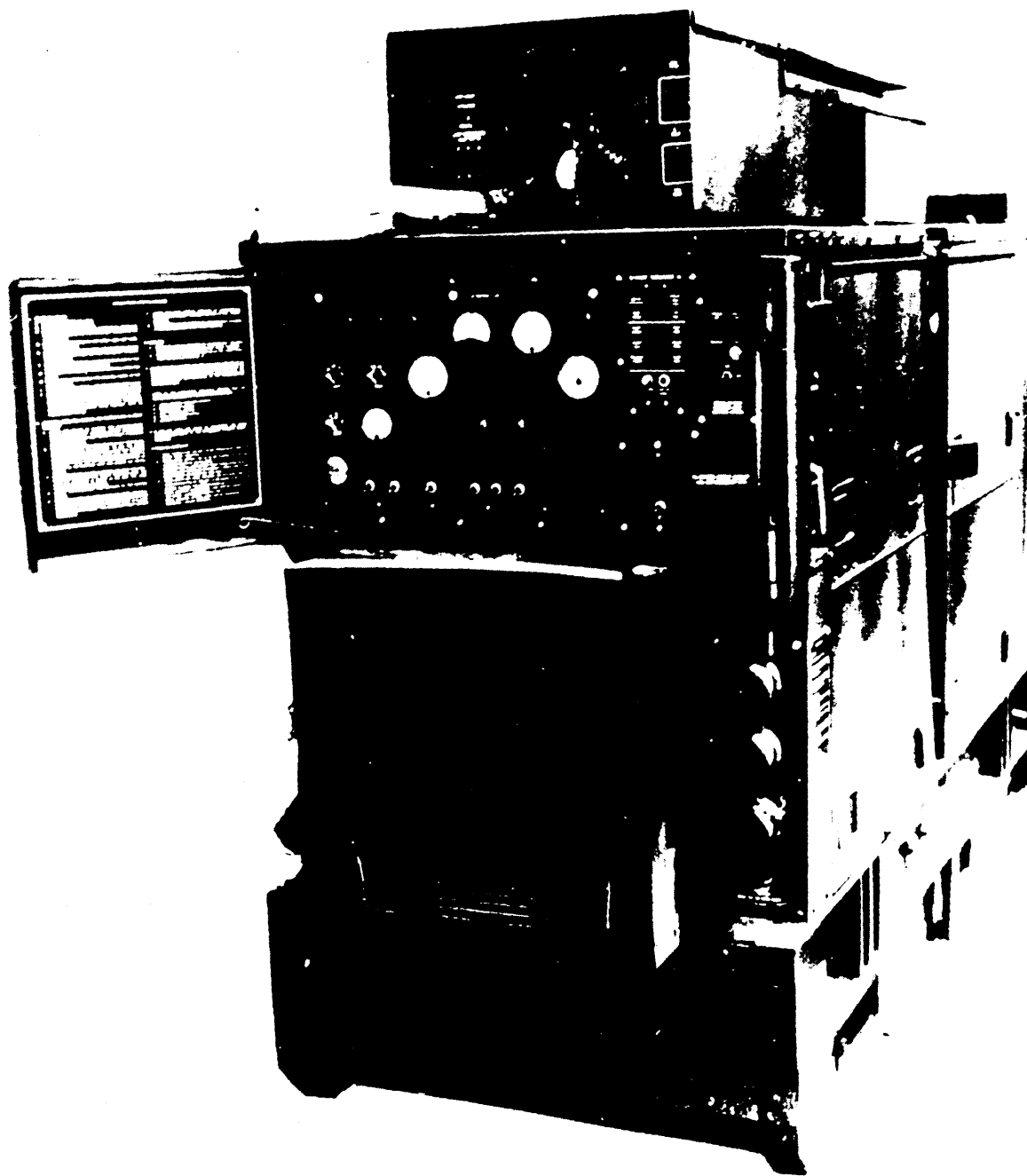

FIGURE 37. MEP-105A(60 kw, 50/60 Hz, DED).

MIL-STD-633E-25

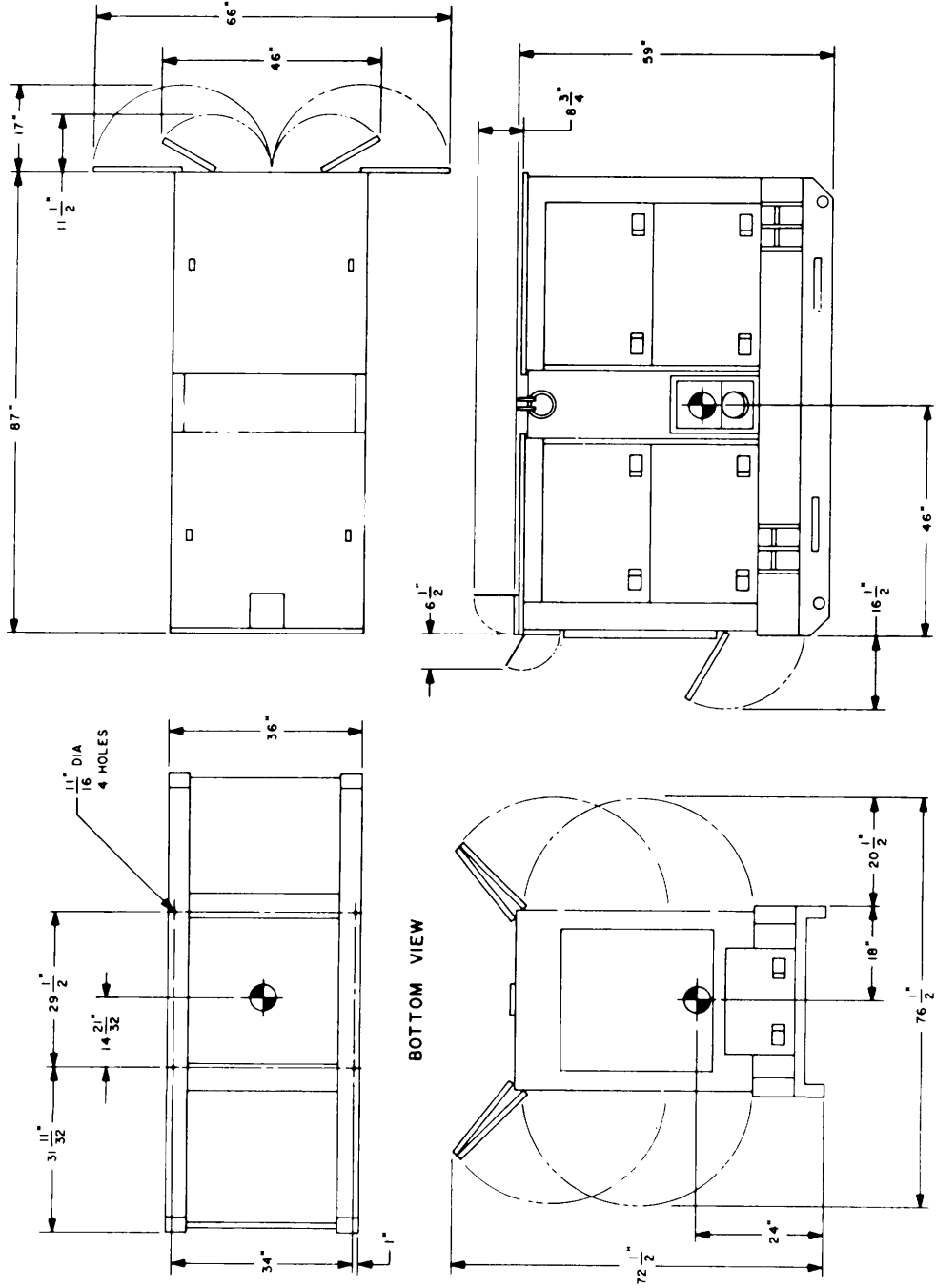

FIGURE 38. MEP-105A (60 kW, 50/60 Hz, DED).

X-3572

MIL-STD-633E-26  
22 February 1980

MILITARY STANDARD  
MOBILE ELECTRIC POWER  
ENGINE GENERATOR STANDARD FAMILY  
MEP-115A, 60 kW, 400 Hz, DIESEL ENGINE-DRIVEN GENERATOR SET  
CHARACTERISTICS DATA SHEET

CLASSIFICATION

Description: 60 kW @ 0.8 power factor, 400 Hz, 120/208 V, 240/416 V

Model:	MEP-115A	Type:	I (tactical)
NSN:	6115-00-118-1253	Class:	1 (precise)
Spec:	MIL-G-52884/9	Mode:	II (400 Hz)

PHYSICAL CHARACTERISTICS

Dimensions: See Figures 39 and 40 on pages 135 and 136.

Weight: 4400 lbs (1996 kg).

Mobility: Fully housed. Mounted on skid base. Lifting and tie-down attachments provided. Fork lift provision.

Engine: Diesel. Std: MIL-STD-1410. Horsepower: 180 @ 2000 RPM. of  
cyl: 6. Cycle: 4. Liquid cooled. 24 VDC electric start. Operating speed:  
400 Hz: 2000 RPM. Fuel tank capacity: 55 gallons (approx 8 hours at rated  
load). Fuel pump lift: 12 feet.

Fuel:

Primary: VV-F-800; Diesel Fuel Oil, types DF-1, DF-2 and DF-A.  
Emergency Fuel: MIL-T-5624, Aviation Turbine Fuels, grades JP-4 and JP-5.

Electrical:

Drip proof generator enclosure. Capable of parallel operation. Fungus and  
moisture treatment. Solid state voltage regulator. Brushless rotary exciter.

Voltage Connection: 400 Hz: 120/208 V, 3 phase, 4 wire.  
240/416 V, 3 phase, 4 wire.



Protective Devices: Short circuit protection. Overvoltage protection. Overload protection. Reverse power protection. Low oil pressure cut-off switch. High temperature cut-off switch. Low fuel level cut-off switch. Overspeed cut-off switch.

Instrumentation: Voltmeter. Frequency meter. Ammeter. Hourmeter. Wattmeter (% load). Oil pressure gage. Battery charging ammeter (% current). Fault indicating system. Coolant temperature indicator. Fuel level.

FUNCTIONAL/OPERATIONAL CHARACTERISTICS

Reliability: Mean Time Between Failures (MTBF): 450 hours (specified).

Fuel Consumption: 6 gph at rated load.

Electromagnetic Interference: Suppression to MIL-STD-461 limits.

<u>Steady State Stability (variation)</u>	<u>Voltage</u>	<u>Frequency</u>
Short Term (30 see)	1% Bandwidth	0.5% Bandwidth
Long Term (4 hours)	2% Bandwidth	1% Bandwidth
 <u>Transient Performance:</u>		
Application of rated load	12% Dip	1.5% Undershoot
recovery	0.5 Sec	1 Sec
Rejection of rated load	12% Rise	1.5% Overshoot
recovery	0.5 Sec	1 Sec
Application of simulated. motor load	25% Dip	
recovery	0.7 Sec	
 <u>Waveform</u>		
Maximum Deviation Factor	5%	
Individual Harmonic	2%	
 <u>Regulation</u>	 1%	 0.25%

Adjustment Range for Standard Voltage Connections

120/208 v Corm: 400 Hz: 197 to 229 V.  
 240/416 V Corm: 400 Hz: 395 to 458 v.

Frequency Adjustment Range: 390 to 420 Hz.

MIL-STD-633E-26  
 22 February 1980

ENVIRONMENTAL DATA

Power Output at Environmental Conditions:

60 kW, 400 Hz, Sea Level: Minus 25° F (-31.7 C) to plus 125° F (+51.7° C)  
 60 kW, 400 Hz, 5000 feet: Minus 25° F (-31.7° C) to plus 107° F (+41.7° C)  
 Winterization system extends lower temperature limit to minus 65° F (-53.9° C)

Shock and Rough Handling: 10 mph railroad impact. 12 inch end drop. Truck and trailer transportation.

Attitude: Operate with base level or inclined no more than 15 degrees from level.

Noise Level: 90 dbA @ 25 feet.

OPTIONAL EQUIPMENT

See 4.4.3 of MIL-STD-633 for additional information on optional equipment.

<u>Description</u>	<u>NSN</u>	<u>Weight lbs (kg)</u>	<u>Effect on Dim (ins)</u>
Wntzn Kit (Fuel burning)	6115-00-407-8314	45 (20.4)	Int
Wntzn Kit (Electric)	6115-00-455-7693	40 (18.1)	Int
Wntzn Kit, Aux, Fuel burning	6115-00-463-9098	350 (158.8)	Aux: (41x40x26)
Wntzn Kit, Aux, Elect.	6115-00-463-9099	260 (117.9)	Aux: (36x27x19)
Remote Control Box	6115-00-420-8490	8 (3.6)	Int
Load Bank	6115-00-407-8322	272 (123.4)	Ext: H+15
Wheel Mounting Kit Panel, Auto	6115-00-463-9092	564 (255.8)	Ext: L+8, W+32, H+9
Standby, 400 Hz	6115-00-463-9096	825 (374.2)	Aux: (44x19x42)

REFERENCE DOCUMENTS

Technical Manuals:

<u>Army</u>	<u>Air Force</u>	<u>Marine Corps</u>	<u>Navy</u>
TM	To		<u>NAVFAC</u>
5-6115-545-12	35C2-3-444-1	TM-00038G-12	P-8-626-12
5-6115-545-34	35C2-3-444-2	TM-00038G-35	P-8-625-34
5-6115-545-24P	35C2-3-444-4	SL-00038G	P-8-626-24P
LO			
5-6115-545-12			

MIL-STD-633E-26  
22 February 1980

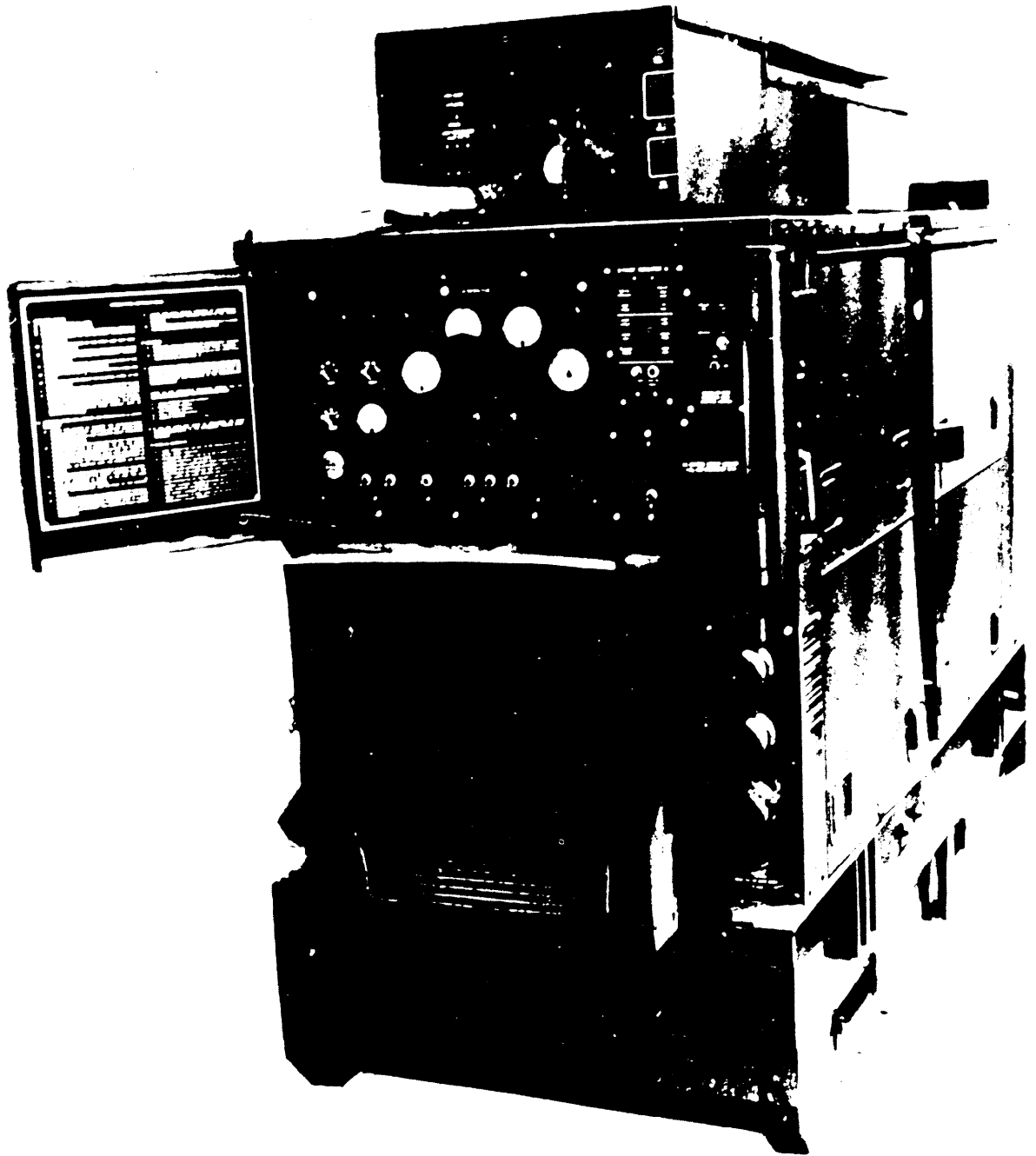

FIGURE 39. MEP-115A (60 kW, 400 Hz, DED).

X-3573

MIL-STD-633E-26  
 22 February 1980

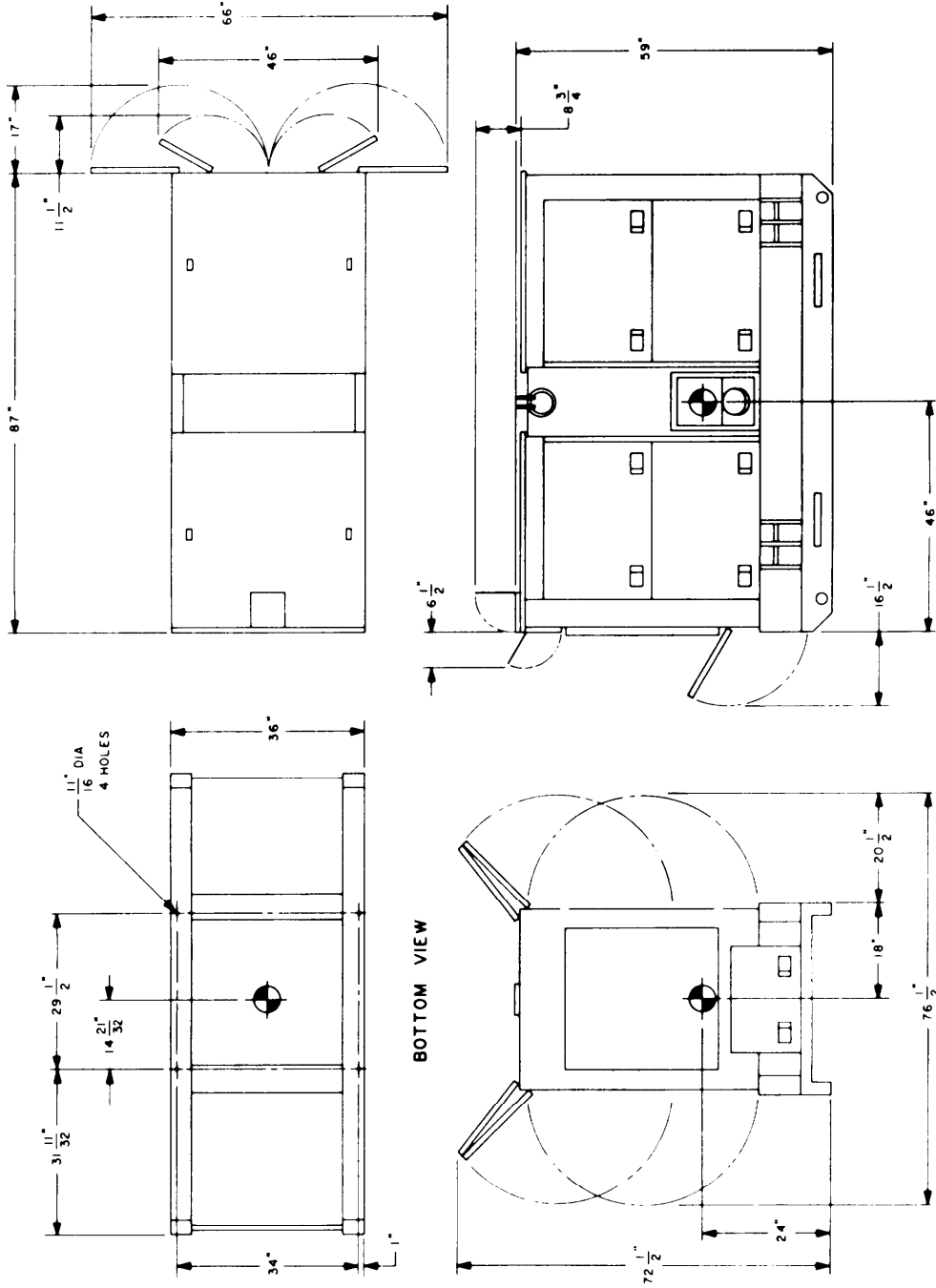

FIGURE 40. MEP-115A (60 kW, 400 Hz, DED).

X-3574

MIL-STD-633E-30  
22 February 1980

MILITARY STANDARD  
MOBILE ELECTRIC POWER  
ENGINE GENERATOR STANDARD FAMILY  
MEP-007B, 100 kW, 50-60 Hz, DIESEL ENGINE-DRIVEN GENERATOR SET  
CHARACTERISTICS DATA SHEET

CLASSIFICATION

Description: 100 kW @ 0.8 power factor, 50/60 Hz, 120/208 V, 240/416 V

Model:	MEP-007B	Type:	I (tactical)
NSN:	6115-01-036-6374	Class:	
Spec:	PD, 17 Mar 78	Mode:	I (50/60 Hz)

PHYSICAL CHARACTERISTICS

Dimensions: See Figures 47 and 48 on pages 155 and 156.

Weight: 7000 lbs (3175 kg).

Mobility: Fully housed. Mounted on skid base. Lifting and tie-down attachments provided. Fork lift provision.

Engine: Diesel. Std:MIL-STD-1410. Horsepower: 217min @ 1800 RPM No. of cyl: 6. Cycle: Liquid cooled. 24 VDC electric start. Operating speed: 50 Hz: 1500 RPM, 60 Hz: 1800 RPM. Fuel tank capacity: 90 gallons (approx 8 hours at rated load). Fuel pump lift: 12 feet.

Fuel:

Primary: VV-F-800; Diesel Fuel Oil, types DF-1, DF-2 and DF-A.  
Emergency Fuel: MIL-T-5624, Aviation Turbine Fuels, grades JP-4 and JP-5.

Electrical

Drip proof generator enclosure. Capable of parallel operation. Fungus and moisture treatment. Solid state voltage regulator. Brushless rotary exciter.

Voltage Connection:

60 Hz: 120/208 V, 3 phase, 4 wire. 240/416 V, 3 phase, 4 wire.  
50 Hz: 120/208 V, 3 phase, 4 wire. 240/416 V, 3 phase, 4 wire.

MIL-STD-633E-30  
 22 February 1980

Protective Devices: Short circuit protection. Overvoltage protection. Overload protection. Reverse power protection. Low oil pressure cut-off switch. High temperature cut-off switch. Low fuel level cut-off switch. Overspeed cut-off switch.

Instrumentation: Voltmeter. Frequency meter. Ammeter. Hourmeter. Wattmeter (% load). Oil pressure gage. Battery charging ammeter (% current). Fault indicating system. Coolant temperature indicator. Fuel level.

FUNCTIONAL/OPERATIONAL CHARACTERISTICS

Reliability: Mean Time Between Failures (MTBF): 580 hours (specified).

Fuel Consumption: 8.5 gph at rated load.

Electromagnetic Interference: Suppression to MIL-STD-461 limits.

<u>Steady State Stability (variation)</u>	<u>Voltage</u>	<u>Frequency</u>
Short Term (30 see)	1% Bandwidth	0.5% Bandwidth
Long Term ( 4 hours)	2% Bandwidth	1% Bandwidth

Transient Performance

Application of rated load	15% Dip	*4% Undershoot
recovery	0.5 Sec	2 Sec
Rejection of rated load	15% Rise	*4% Overshoot
recovery	0.5 Sec	2 Sec
Application of simulated motor load	30% Dip	
recovery	0.7 Sec	
		*Frequency performance at 75% of rated load.

Waveform

Maximum Deviation Factor	5%
Individual Harmonic	2%

Regulation 1% 0.3% adjustable

Adjustment Range for Standard Voltage Connections

120/208 V Corm: 60 Hz: 197 to 240 V. 50 Hz: 190 to 213 v.  
 240/416 V Corm: 60 Hz: 395 to 480 V. 50 Hz: 380 to 426 V.

Frequency Adjustment Range: 58 to 62 Hz. 48 to 52 Hz.

MIL-STD-633E-30  
 22 February 1980

ENVIRONMENTAL DATA

Power Output at Environmental Conditions:

100 kW, 60 Hz, Sea Level: Minus 25° F (-31.7° C) to plus 125° F (+51.7° C).  
 100 kW, 60 Hz, 5000 feet: Minus 25° F (-31.7° C) to plus 107° F (+41.7° C)  
 83.3 kW, 50 Hz, Sea Level: Minus 25° F (-31.7° C) to plus 125° F (+51.7° C)  
 83.3 kW, 50 Hz, 5000 feet: Minus 25° F (-31.7° C) to plus 107° F (+41.7° C)  
 Winterization system extends lower temperature limit to minus 65° F (-53.9° C).

Shock and Rough Handling: 10 mph railroad impact. 12 inch end drop. Truck and trailer transportation.

Attitude: Operate with base level or inclined no more than 15 degrees from level.

Noise Level: 85 dbA @ 25 feet.

OPTIONAL EQUIPMENT

See 4.4.3 of MIL-STD-633 for additional information on optional equipment.

<u>Description</u>	<u>NSN</u>	<u>Weight lbs (kg)</u>	<u>Effect on Dim (ins)</u>
Wntzn Kit (Fuel burning)	To be determined		Int
Wntzn Kit (Electric)	To be determined		Int
Wntzn Kit, Aux, Fuel burning	6115-00-463-9098	350 (158.8)	Aux: (41x40x26)
Wntzn Kit, Aux, Elect	6115-00-463-9099	260 (117.9)	Aux: (36x27x19)
Remote Control Box	6115-00-420-8490	8 (3.6)	Int
Load Bank	6115-00-463-9086	370 (167.8)	Ext: H+19
Wheel Mounting Kit	6115-00-463-9089	580 (263)	Ext: H+13, L+9, W+30
Panel, Auto, Load Transfer, 60 Hz	6115-00-477-7932	825 (374.2)	Aux: (44X19X42)

REFERENCE DOCUMENTS

Technical Manuals: To be published.

MIL-STD-633E-30  
22 February 1980

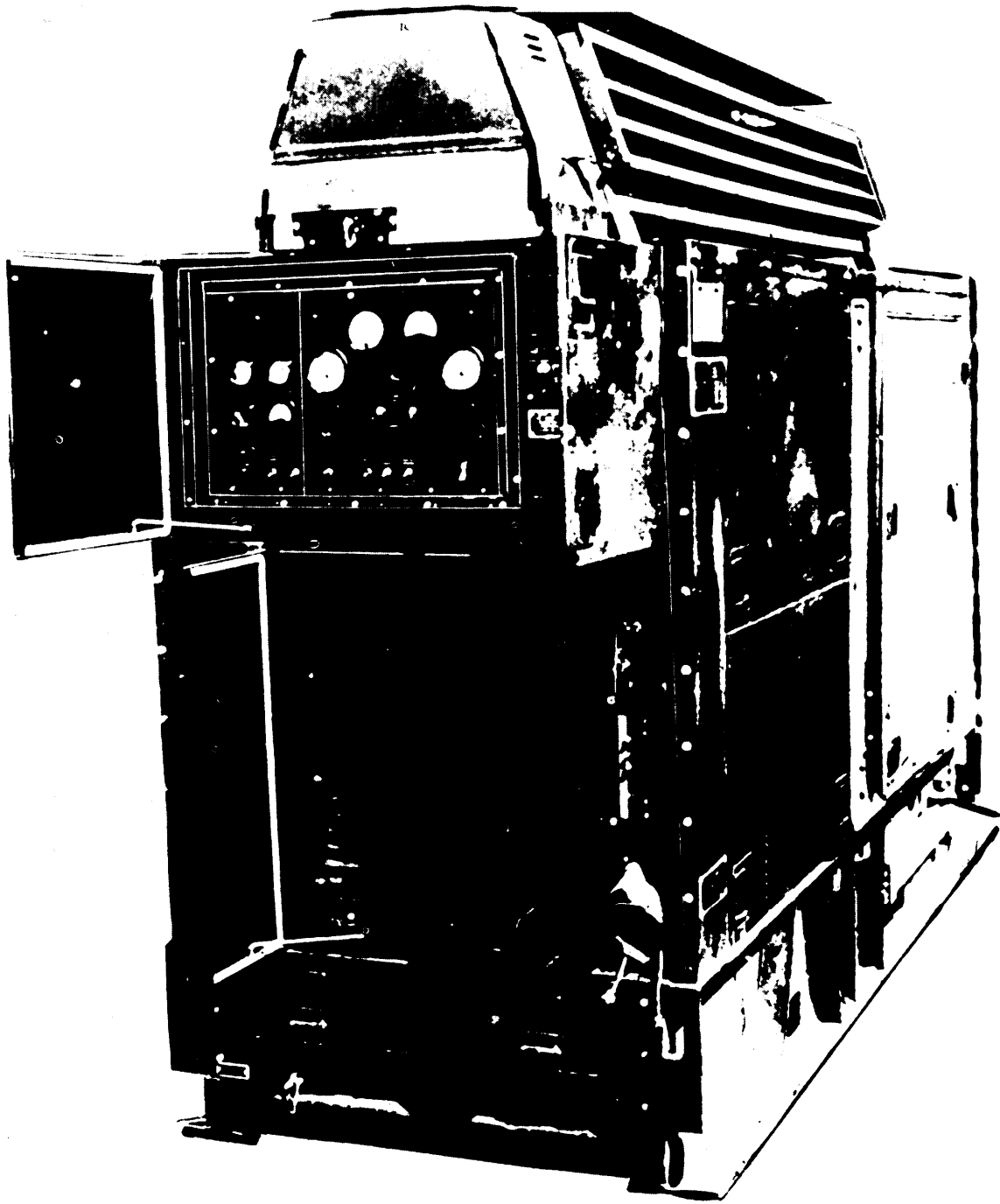

FIGURE 47. MEP-007B (100 kW, 50/60 Hz, DED).

X-3579



MIL-STD-633E-30  
 22 February 1980

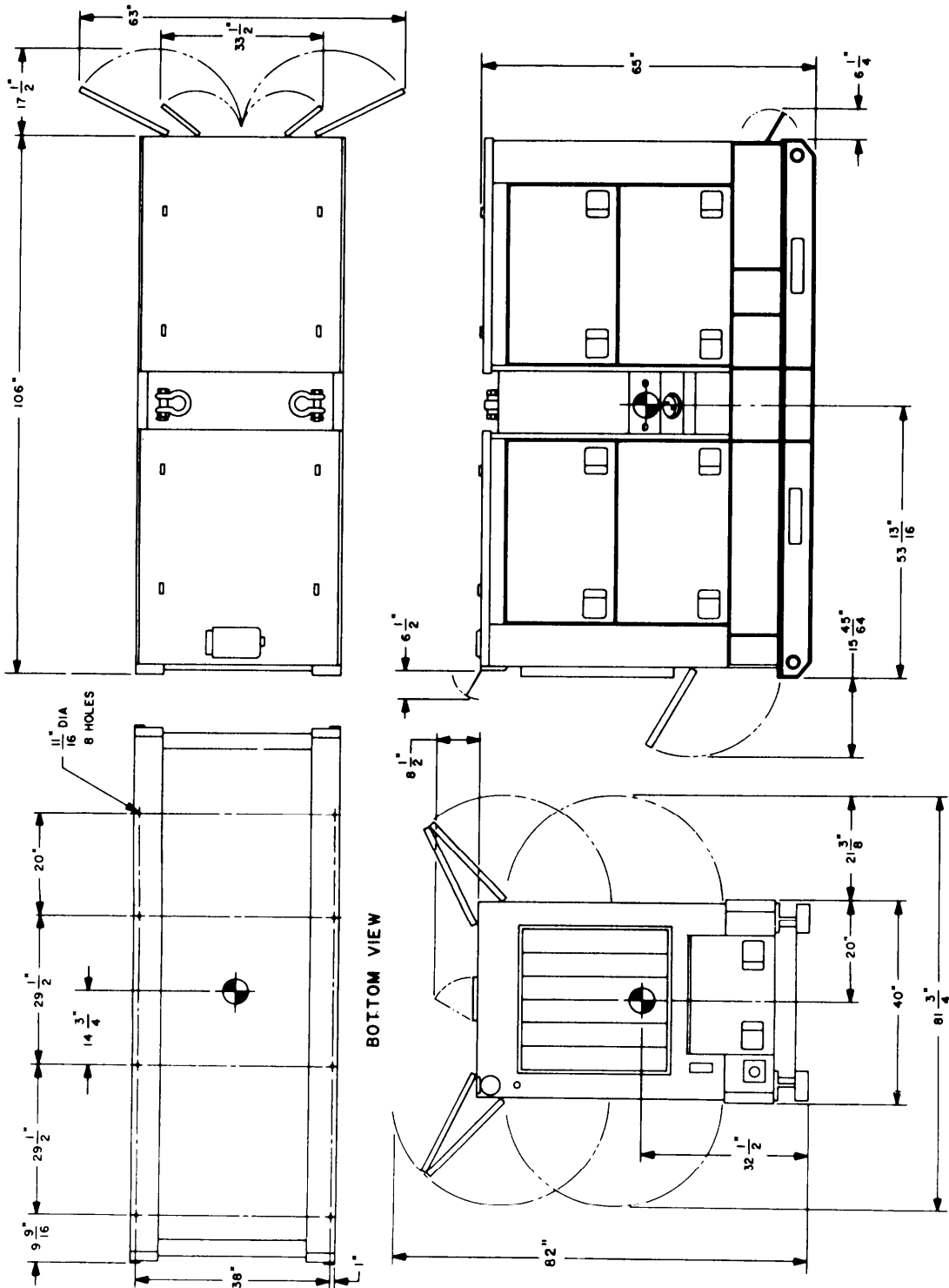

FIGURE 48. MEP-007B (100 kW, 50/60 Hz, DED). X-3580

MIL-STD-633E-37  
22 February 1980

MILITARY STANDARD  
MOBILE ELECTRIC POWER  
ENGINE GENERATOR STANDARD FAMILY  
MEP-007A, 100 kW, 50-60 Hz, DIESEL ENGINE-DRIVEN GENERATOR SET  
CHARACTERISTICS DATA SHEET

CLASSIFICATION

Description: 100 kW @ 0.8 power factor, 50/60 Hz, 120/280 V, 240/416 V

Model:	MEP-007A	Type:	I (tactical)
NSN:	6115-01-133-9101	Class:	2 (utility)
Spec:	MIL-G-52884/11	Mode:	I (50/60 Hz)

PHYSICAL CHARACTERISTICS

Dimensions: See Figures 57 and 58 on pages 186 and 187.

Weight: 6680 lbs (3030 kg).

Mobility: Fully housed. Mounted on skid base. Lifting and tie-down attachments provided. Fork lift provision.

Engine: Diesel, Std: MIL-STD-1410. Horsepower: 170 min @ 1800 RPM. No. of : 6. Cycle: 4. Liquid cooled. 24 VDC electric start. Operating speed: 50 Hz: 1500 RPM, 60 Hz: 1800 RPM. Fuel tank capacity: 90 gallon (approx 8 hours at rated load). Fuel pump lift: 12 feet.

Fuel:

Primary: VV-F-800; Diesel Fuel Oil, types DF-1, DF-2 and DF-A.  
Emergency Fuel: MIL-T-5624, Aviation Turbine Fuels, grades JP-4 and JP-5.

Electrical:

Drip proof generator enclosure. Capable of parallel operation. Fungus and moisture treatment.  
Solid state voltage regulator. Brushless rotary exciter.

Voltage Connection: 60 Hz: 120/208 v, 3 phase, 4 wire. 240/416 V, 3 phase, 4 wire.  
50 Hz: 120/208 V, 3 phase, 4 wire. 240/416 V, 3 phase, 4 wire.

MIL-STD-633E-37  
 22 February 1980

Protective Devices: Short circuit protection. Overvoltage protection. Reverse power protection. Low oil protection. Low oil pressure cut-off switch. High temperature cut-off switch. Low fuel level cut-off switch. Overspeed cut-off switch.

Instrumentation: Voltmeter. Frequency meter. Ammeter. Hourmeter. Wattmeter (% load). Oil pressure gage. Battery charging ammeter (% current). Fault indicating system. Coolant temperature indicator. Fuel level.

FUNCTIONAL/OPERATIONAL CHARACTERISTICS

Reliability: Mean Time Between Failures (MTBF): 800 hours (specified).

Fuel Consumption: 8.5 gph at rated load.

Electromagnetic Interference: Suppression to MIL-STD-461 limits.

<u>Steady State Stability (variation)</u>	<u>Voltage</u>	<u>Frequency</u>
Short Term (30 Sec)	2% Bandwidth	2% Bandwidth
Long Term (4 hours)	4% Bandwidth	3% Bandwidth
 <u>Transient Performance</u>		
Application of rated load	20% Dip	3% Undershoot
recovery	3 Sec	3 Sec
Rejection of rated load	20% Rise	4% Overshoot
recovery	3 Sec	3 Sec
Application of simulated motor load	40% Dip	
recovery	5 Sec	
 <u>Waveform</u>		
Maximum Deviation Factor	5%	
Individual Harmonic	2%	
 <u>Regulation</u>	 3%	 2-3% Adjustable

Adjustment Range for Standard Voltage Connections

120/208 V Corm: 60 Hz: 197 to 240 V. 50 Hz: 190 to 213 V.  
 240/416 V Corm: 60 Hz: 395 to 480 V. 50 Hz: 380 to 426 V.

Frequency Adjustment Range: 58 to 62 Hz. 48 to 52 Hz.

MIL-STD-633E-37  
 22 February 1980

ENVIRONMENTAL DATA

Power Output at Environmental Conditions:

100 kW, 60 Hz: Sea level, minus 25° F (-31.7° C) to plus 125° F (+51.7° C)  
                   5000 feet, minus 25° F (-31.7° C) to plus 107° F (+41.7° C)  
 83.3 kW, 50 Hz: Sea level, minus 25° F (-31.7° C) to plus 125° F (+51.7° C)  
                   5000 feet, minus 25° F (-31.7° C) to plus 107° F (+41.7° C)  
 Winterization system extends lower temperature limit to minus 65° F (-53.9° C)

Shock and Rough Handling: 10 mph railroad impact. 12 inch end drop. Truck and trailer transportation.

Attitude: Operate with base level or inclined to more than 15 degrees from level.

Noise Level: 88 dbA @ 25 feet.

OPTIONAL EQUIPMENT

See 4.4.3 of MIL-STD-633 for additional information on optional equipment.

<u>Description</u>	<u>NSN</u>	<u>Weight lbs (kg)</u>	<u>Effect on Dim (ins)</u>
Wntzn Kit (Fuel Burning)	6115-00-463-9082	45 (20.4)	Int
Wntzn Kit (Electric)	6115-00-463-9084	40 (18.1)	Int
Wntzn Kit, Aux, Fuel Burning	6115-00-463-9098	350 (158.8)	Aux: (41x40x26)
Wntzn Kit, Aux, Elect.	6115-00-463-9099	260 (117.9)	Aux: (36x27x19)
Remote Control Box	6115-00-420-8490	8 (3.6)	Int
Load Bank	6115-00-463-9086	370 (167.8)	Ext: H+19
Wheel Mounting Kit Panel, Auto, Load Transfer, 60 Hz	6115-00-463-9089	580 (263)	Ext: H+13, L+9, W+30
Paralleling Cable	6115-00-477-7932	825 (374.2)	Aux: (44x19x42)
Relay Assembly, Precise	6140-00-197-4934	4 (1.8)	Ext: L=300
	6140-00-199-1616		Int

REFERENCE DOCUMENTS

Technical Manuals:

<u>Army</u>	<u>Air Force</u>	<u>Marine Corps</u>	<u>Navy</u>
TM	TO		NAVFAC
5-6115-457-12	35C2-3-442-1	TM-07464A-12	P-8-627-12
5-6115-457-24P	35C2-3-442-4	SL-4-07464A	P-8-627-24P
5-6115-457-34	35C2-3-442-2	TM-07464A-35	P-8-627-34

MIL-STD-633E-37  
22 February 1980

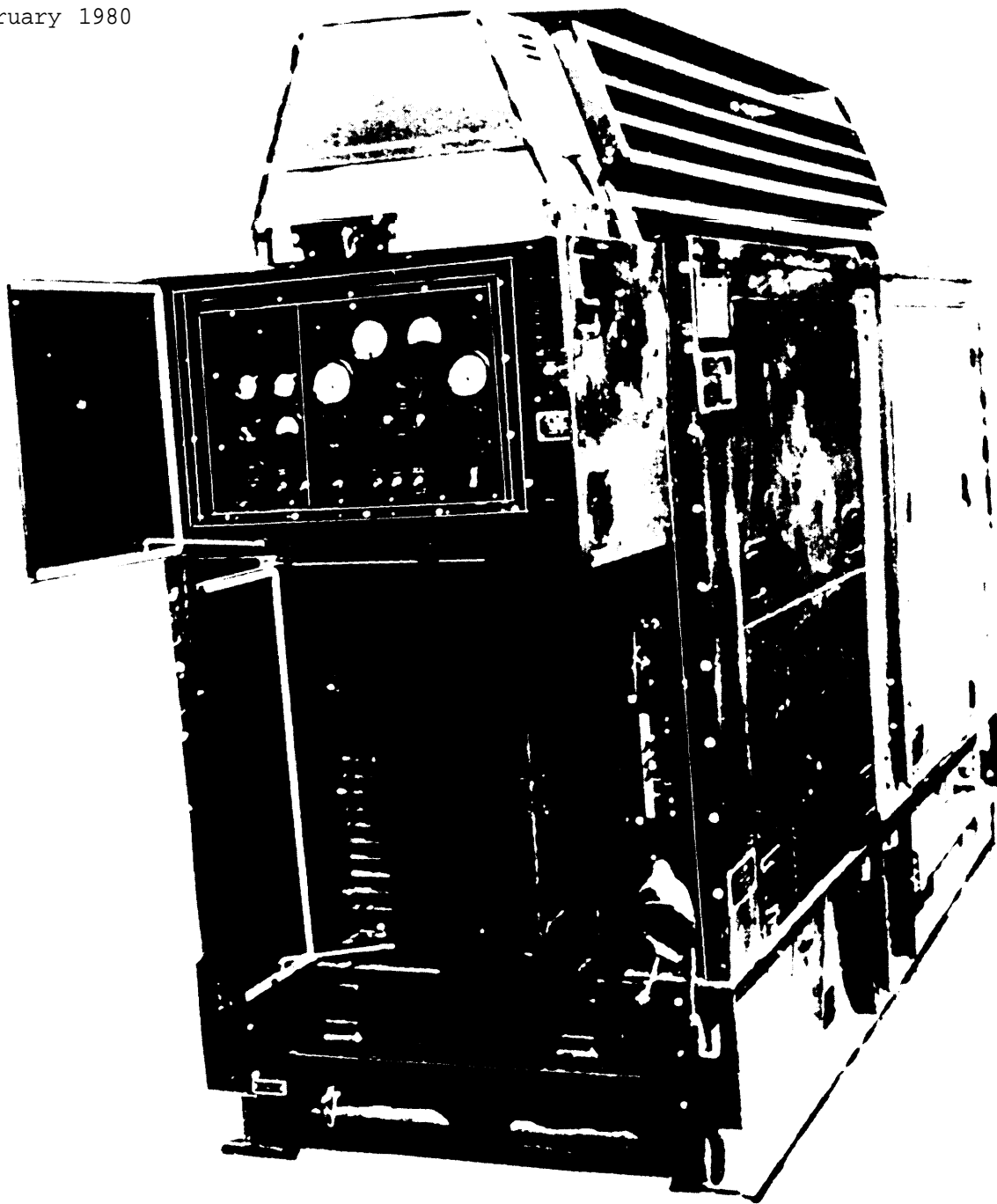

FIGURE 57. MEP-007A (100 kW, 50/60 Hz, DED).

X-3585

MIL-STD-633F-37  
 22 February 1980

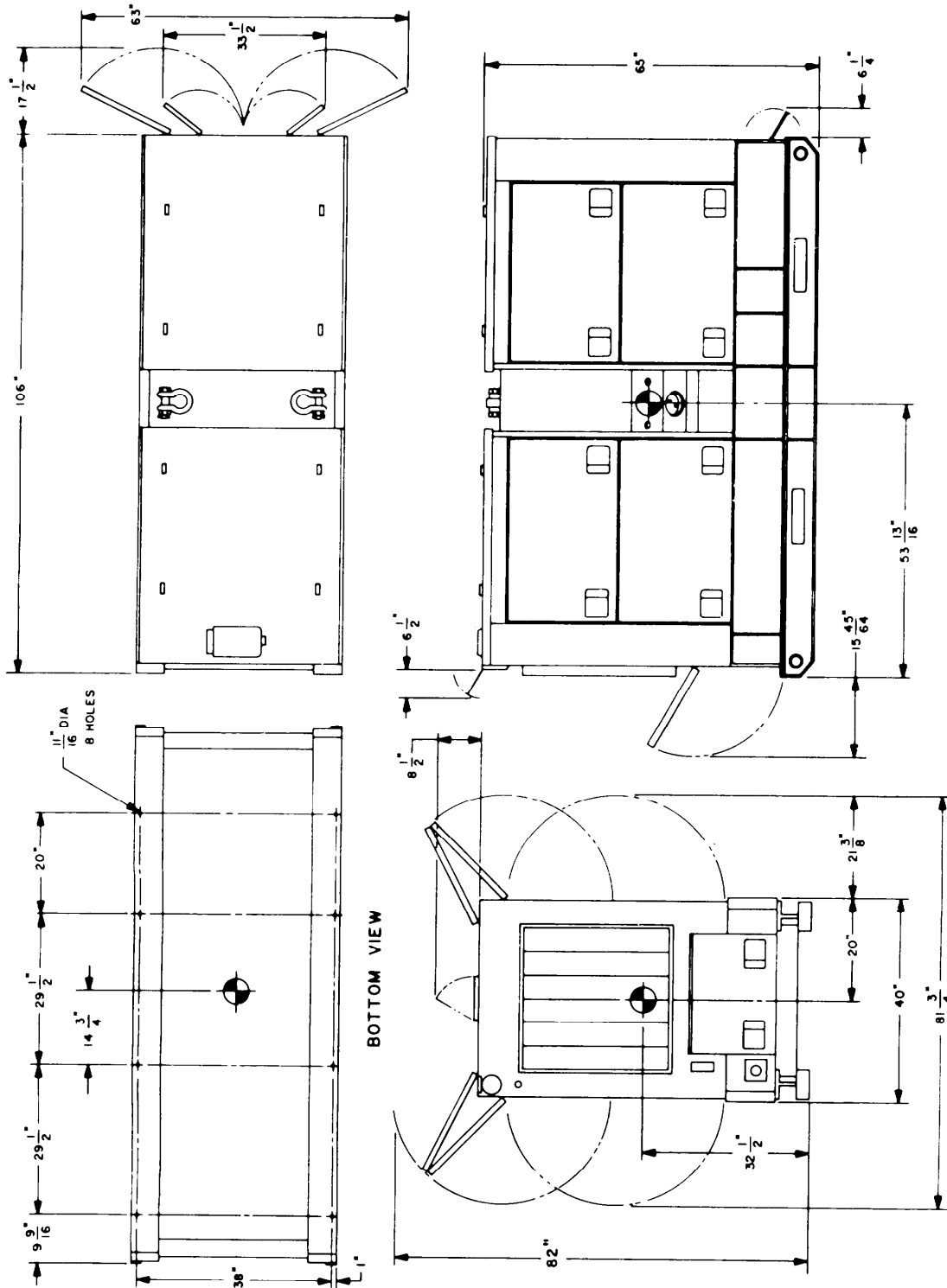

FIGURE 58. MEP-007A (100 kW, 50/60 Hz, DED).

X-3586