

REPORT 1102

THE LINEARIZED CHARACTERISTICS METHOD AND ITS APPLICATION TO PRACTICAL NONLINEAR SUPERSONIC PROBLEMS¹

By ANTONIO FERRI

SUMMARY

The method of characteristics has been linearized by assuming that the flow field can be represented as a basic flow field determined by nonlinearized methods and a linearized superposed flow field that accounts for small changes of boundary conditions. The method has been applied to two-dimensional rotational flow where the basic flow is potential flow and to axially symmetric problems where conical flows have been used as the basic flows. In both cases the method allows the determination of the flow field to be simplified and the numerical work to be reduced to a few calculations. The calculation of axially symmetric flow can be simplified if tabulated values of some coefficients of the conical flow are obtained. The method has also been applied to slender bodies without symmetry and to some three-dimensional wing problems where two-dimensional flow can be used as the basic flow. Both problems were unsolved before in the approximation of nonlinearized flow.

INTRODUCTION

The use of the method of characteristics for the solution of supersonic-flow problems requires numerical procedures which are lengthy and involved and which must be repeated for each set of boundary conditions. The method has received general practical application only for two-dimensional or axially symmetrical problems in steady flow and one-dimensional or quasi-one-dimensional nonsteady flow, and only very few cases of general three-dimensional flow have yet been investigated.

Many problems have been investigated at present by means of the linearized theory in which the disturbance-velocity components (defined as the difference between the local and the free-stream components of the velocity) are considered and are small, so that terms of second order or higher can be neglected. In the present report a simplification is introduced in the equations of motion based on the assumption that one of the velocity components or the variation of the velocity components as a function of a given parameter can be considered small, so that terms of second or higher order in the quantities considered small can be neglected. When one of the velocity components is assumed to be small, the other two velocity components can be expressed in two parts, one of which is large and is a function only of two coordinate positions, and the other of which

is small, of the same order as the third velocity component, and is a function of all three coordinates.

If the variations of velocity components as functions of a given parameter are considered small, all three velocity components can be expressed in two parts. One, large, is independent of the parameter considered, and the other, small, is a function of the parameter considered. When the velocity components are substituted into the differential equations, the equations can be divided into two parts, and the differential equations containing the velocity components considered small become linear; therefore, superposition of solutions is possible. With this assumption the flow field can be represented for any condition by the superposition on a nonlinear basic flow field of a linearized flow perturbation. The flow field, which represents the variation of the basic flow due to the changes of the geometrical parameter considered, changes linearly with the parameter. Because of the simplification, the superposed flow field is defined by differential equations of hyperbolic type which have characteristic surfaces equal to the characteristic surfaces of the basic flow field and known coefficient; therefore, the superposed flow field can be obtained directly without the iteration process along the characteristic net of the basic flow.

A particular application of the linearized characteristics method has been discussed in references 1, 2, and 3 in which bodies of revolution at small angles of attack have been considered. In the present report the basic concept of the linearization is discussed and examples of application to two-dimensional rotational flow, to conical flow, to axially symmetric flow, and to some general three-dimensional problems are discussed. From these examples, other applications of the same method to supersonic steady- or nonsteady-flow problems can be visualized. For example, the method can also be applied to the determination of the flow field in supersonic compressors or turbines having supersonic relative velocity inside the passage. In this case, the two-dimensional flow of the cascade of the blades at each radial station or the axially symmetric flow can be assumed as the basic flow. In the first case the radial component of the velocity must be assumed to be small, whereas, in the second case, the tangential component of the velocity must be assumed to be small.

¹Supersedes NACA TN 2515, "The Linearized Characteristics Method and Its Application to Practical Nonlinear Supersonic Problems" by Antonio Ferri, 1951.

SYMBOLS

- a, b, c, d, e coefficients of the variables in the characteristic equations (defined case by case)
- a speed of sound
- A_n coefficient $\left(\frac{\gamma-1}{a_0^2} (u_0 u_n + v_0 v_n)\right)$
- B and C coefficients defined by equations (20) and (25)
- C_p pressure coefficient
- M Mach number
- R gas constant or radius of hodograph diagram
- S entropy
- u, v, w velocity components along the x -, y -, and z -axes in Cartesian coordinates or along x - and y -axes and perpendicular to the meridian xy -plane in cylindrical coordinates
- u_r, v_n, w velocity components in polar coordinates
- v_T, v_N tangential and normal velocity components in front of the shock
- V intensity of the velocity vector
- β Mach angle
- γ ratio of specific heats
- $\lambda_{1,2}$ inclination of the characteristic lines in the plane $z = \text{Constant}$ or $\theta = \text{Constant}$
- θ coordinate of the meridian xy -plane in cylindrical coordinates or of the $r\psi$ -plane in polar coordinates
- ψ, θ polar coordinates
- φ inclination of the velocity vector with respect to the x -axis
- ξ, η, ζ components of the rotation along the x -, y -, and z -axes

Subscripts:

- 0 properties of the basic flow
- 1 . . . n properties of the superposed linearized flow fields

THE EQUATIONS OF THE LINEARIZED CHARACTERISTIC SYSTEM

Consider, for example, a flow field defined by a velocity vector $V(u, v, w)$ the components of which can be expressed in the form

$$\left. \begin{aligned} u &= u_0 + \sum_1^N a_n u_n \\ v &= v_0 + \sum_1^N a_n v_n \\ w &= \sum_1^N a_n w_n \end{aligned} \right\} \quad (1)$$

For constant stagnation enthalpy in the flow field, the relation between entropy and rotation states

$$\text{curl } \mathbf{V} \times \mathbf{V} = \frac{a^2}{\gamma R} \text{grad } S \quad (2)$$

Assume that u_0 and v_0 are functions only of x and y ; then, by neglecting terms of the order of a_n^2 , equation (2) becomes

$$\left. \begin{aligned} \frac{\partial S}{\partial x} \frac{a^2}{\gamma R} &= -v_0 \left(\frac{\partial v_0}{\partial x} - \frac{\partial u_0}{\partial y} \right) - v_0 \sum a_n \left(\frac{\partial v_n}{\partial x} - \frac{\partial u_n}{\partial y} \right) - \\ &\quad \left(\frac{\partial v_0}{\partial x} - \frac{\partial u_0}{\partial y} \right) \sum a_n v_n \\ \frac{\partial S}{\partial y} \frac{a^2}{\gamma R} &= -u_0 \left(\frac{\partial v_0}{\partial x} - \frac{\partial u_0}{\partial y} \right) + u_0 \sum a_n \left(\frac{\partial v_n}{\partial x} - \frac{\partial u_n}{\partial y} \right) + \\ &\quad \left(\frac{\partial v_0}{\partial x} - \frac{\partial u_0}{\partial y} \right) \sum a_n u_n \\ \frac{\partial S}{\partial z} \frac{a^2}{\gamma R} &= v_0 \sum a_n \left(\frac{\partial w_n}{\partial y} - \frac{\partial v_n}{\partial z} \right) - u_0 \sum a_n \left(\frac{\partial u_n}{\partial z} - \frac{\partial w_n}{\partial x} \right) \end{aligned} \right\} \quad (3)$$

Therefore, the entropy field can be expressed as

$$\left. \begin{aligned} \frac{\partial S}{\partial x} &= \frac{\partial S_0}{\partial x} + \sum_1^N a_n \frac{\partial S_n}{\partial x} \\ \frac{\partial S}{\partial y} &= \frac{\partial S_0}{\partial y} + \sum_1^N a_n \frac{\partial S_n}{\partial y} \\ \frac{\partial S}{\partial z} &= \sum_1^N a_n \frac{\partial S_n}{\partial z} \end{aligned} \right\} \quad (4)$$

Assume that each coefficient $a_1 \dots a_n$ is constant in the entire region of the flow field where it is not zero and is small, so that terms of the order of a_n^2 or higher can be neglected. In this flow a basic flow field exists, represented by the velocity vector $V_0(u_0, v_0)$ and by the entropy distribution S_0 , on which a linearized flow is superposed, represented by a summation of N three-dimensional flow fields, each of which is proportional to the corresponding coefficient a_n . The basic flow field is a two-dimensional flow if Cartesian coordinates are used or an axially symmetric flow if cylindrical coordinates are used and can be determined by known methods. In a similar way, a general three-dimensional flow field can be assumed for basic flow if the flow field can be obtained by simple analysis.

The equation of motion obtained from continuity, momentum, and energy equations can be expressed in Cartesian coordinates in the form

$$\left. \begin{aligned} \frac{\partial u}{\partial x} \left(1 - \frac{u^2}{a^2} \right) + \frac{\partial v}{\partial y} \left(1 - \frac{v^2}{a^2} \right) + \frac{\partial w}{\partial z} \left(1 - \frac{w^2}{a^2} \right) - \frac{uv}{a^2} \left(\frac{\partial u}{\partial y} + \frac{\partial v}{\partial x} \right) - \\ \frac{uw}{a^2} \left(\frac{\partial u}{\partial z} + \frac{\partial w}{\partial x} \right) - \frac{vw}{a^2} \left(\frac{\partial v}{\partial z} + \frac{\partial w}{\partial y} \right) = 0 \end{aligned} \right\} \quad (5)$$

while, in cylindrical coordinates, the equation becomes

$$\left. \begin{aligned} \frac{\partial u}{\partial x} \left(1 - \frac{u^2}{a^2} \right) + \frac{\partial v}{\partial y} \left(1 - \frac{v^2}{a^2} \right) + \frac{\partial w}{\partial \varphi} \left(1 - \frac{w^2}{a^2} \right) - \frac{uv}{a^2} \left(\frac{\partial u}{\partial y} + \frac{\partial v}{\partial x} \right) - \\ \frac{wu}{a^2} \left(\frac{\partial u}{\partial \varphi} + \frac{\partial w}{\partial x} \right) - \frac{vw}{a^2} \left(\frac{\partial v}{\partial \varphi} + \frac{\partial w}{\partial y} \right) + \frac{v}{y} = 0 \end{aligned} \right\} \quad (6)$$

By use of equations (1), expression (5) becomes

$$\begin{aligned}
 & -\left[\frac{\partial u_0}{\partial x}\left(1-\frac{u_0^2}{a_0^2}\right)+\frac{\partial v_0}{\partial y}\left(1-\frac{v_0^2}{a_0^2}\right)-\frac{u_0 v_0}{a_0^2}\left(\frac{\partial u_0}{\partial y}+\frac{\partial v_0}{\partial x}\right)\right]= \\
 & \sum a_n \left[\frac{\partial w_n}{\partial z}+\frac{\partial u_n}{\partial x}\left(1-\frac{u_0^2}{a_0^2}\right)+\frac{\partial v_n}{\partial y}\left(1-\frac{v_0^2}{a_0^2}\right)-\frac{u_0 v_0}{a_0^2}\left(\frac{\partial v_n}{\partial x}+\frac{\partial u_n}{\partial y}\right)-\right. \\
 & \left.\frac{\partial u_0}{\partial x}\left(\frac{2u_0 u_n+u_0^2 A_n}{a_0^2}\right)-\frac{\partial v_0}{\partial y}\left(\frac{2v_0 v_n+v_0^2 A_n}{a_0^2}\right)-\right. \\
 & \left.\left(\frac{\partial u_0}{\partial y}+\frac{\partial v_0}{\partial x}\right)\frac{u_0 v_0 A_n+u_0 v_n+v_0 u_n}{a_0^2}\right] \quad (7)
 \end{aligned}$$

where

$$A_n = \frac{\gamma-1}{a_0^2} (u_0 u_n + v_0 v_n)$$

The basic flow is a two-dimensional flow, and the first part of equation (7) must be zero; therefore, the second part of the equation must also be equal to zero and, for each value of n ,

$$\begin{aligned}
 & \frac{\partial w_n}{\partial z} + \frac{\partial u_n}{\partial x} \left(1-\frac{u_0^2}{a_0^2}\right) + \frac{\partial v_n}{\partial y} \left(1-\frac{v_0^2}{a_0^2}\right) - \frac{u_0 v_0}{a_0^2} \left(\frac{\partial v_n}{\partial x} + \frac{\partial u_n}{\partial y}\right) \\
 & = \frac{\partial u_0}{\partial x} \left(\frac{2u_0 u_n + u_0^2 A_n}{a_0^2}\right) + \frac{\partial v_0}{\partial y} \left(\frac{2v_0 v_n + v_0^2 A_n}{a_0^2}\right) + \\
 & \left(\frac{\partial u_0}{\partial y} + \frac{\partial v_0}{\partial x}\right) \frac{u_0 v_0 A_n + u_0 v_n + v_0 u_n}{a_0^2} \quad (8)
 \end{aligned}$$

Equation (8) is a differential equation of hyperbolic type because $u_0^2 + v_0^2 > a_0^2$ and the characteristic surfaces are cylindrical surfaces perpendicular to the plane $z = \text{Constant}$ with generatrices coincident with the characteristic lines of the two-dimensional flow. This can be seen from the fact that the coefficients of the derivatives $\frac{\partial u_n}{\partial x}$, $\frac{\partial v_n}{\partial y}$, and $\frac{\partial v_n}{\partial x} + \frac{\partial u_n}{\partial y}$ of equation (8) are expressed as functions of the properties of the basic flow and are the same as the coefficients of the derivatives $\frac{\partial u_0}{\partial x}$, $\frac{\partial v_0}{\partial y}$, and $\frac{\partial u_0}{\partial y} + \frac{\partial v_0}{\partial x}$, which define the basic flow, and the coefficient of $\frac{\partial w_n}{\partial z}$ is one (see, for example, reference 4, page 282). Therefore, the disturbance flow field $V_n(u_n, v_n, w_n)$ can be obtained by the method of characteristics by moving along the characteristic surfaces which are cylindrical. The characteristic net, which for the general case must be drawn in spatial coordinates, can be drawn in this case only once for any value of a and n and is equal to the net of the two-dimensional flow. Equation (8) can be transformed for practical use. In the equation, the terms in $u_0 v_0$, $\frac{\partial u_0}{\partial x}$, $\frac{\partial u_0}{\partial y}$, $\frac{\partial v_0}{\partial x}$, and $\frac{\partial v_0}{\partial y}$ are known terms and are given from the two-dimensional flow field.

Assume, in the plane xy , polar components for V and φ for the velocity, defined by

$$\left. \begin{aligned} u_0 &= V_0 \cos \varphi_0 \\ v_0 &= V_0 \sin \varphi_0 \end{aligned} \right\} \quad (9)$$

and, because higher-order terms are neglected,

$$\left. \begin{aligned} u_n &= V_n \cos \varphi_n - \varphi_n V_0 \sin \varphi_0 \\ v_n &= V_n \sin \varphi_n + \varphi_n V_0 \cos \varphi_0 \end{aligned} \right\} \quad (10)$$

where

$$\left. \begin{aligned} V &= V_0 + \sum a_n V_n \\ \varphi &= \varphi_0 + \sum a_n \varphi_n \end{aligned} \right\} \quad (11)$$

If n is the normal to the projection of the streamline in the plane $z = \text{Constant}$, the derivative $\frac{\partial S}{\partial n}$ is expressed by

$$\frac{\partial S}{\partial n} = -\frac{\partial S}{\partial x} \frac{v}{V} + \frac{\partial S}{\partial y} \frac{u}{V} \quad (12)$$

By use of equations (4) and (1), equation (12) becomes

$$\begin{aligned}
 \frac{\partial S}{\partial n} &= -\left(\frac{\partial S_0}{\partial x} + \sum a_n \frac{\partial S_n}{\partial x}\right) \frac{v_0 + \sum a_n v_n}{V_0 + \sum a_n V_n} + \\
 &\left(\frac{\partial S_0}{\partial y} + \sum a_n \frac{\partial S_n}{\partial y}\right) \frac{u_0 + \sum a_n u_n}{V_0 + \sum a_n V_n} \quad (13)
 \end{aligned}$$

By considering only the lowest-order terms, equation (13) becomes

$$\begin{aligned}
 \frac{\partial S}{\partial n} &= \frac{\partial S_0}{\partial n_0} + \sum a_n \frac{\partial S_n}{\partial n_0} + \sum a_n \left[-\frac{\partial S_0}{\partial x} (v_n V_0 - v_0 V_n) + \right. \\
 &\left. \frac{\partial S_0}{\partial y} (u_n V_0 - u_0 V_n) \right] \frac{1}{V_0^2} \quad (14)
 \end{aligned}$$

But,

$$\begin{aligned}
 & -\frac{\partial S_0}{\partial x} (v_n V_0 - v_0 V_n) + \frac{\partial S_0}{\partial y} (u_n V_0 - u_0 V_n) \\
 & = -\varphi_n V_0^2 \left(\frac{\partial S_0}{\partial x} \frac{u_0}{V_0} + \frac{\partial S_0}{\partial y} \frac{v_0}{V_0} \right) = 0
 \end{aligned}$$

because the right-hand term contains as a factor the variation of entropy along the streamline of the basic flow; therefore,

$$\frac{\partial v_n}{\partial x} - \frac{\partial u_n}{\partial y} = \frac{a_0^2}{\gamma R V_0} \frac{\partial S_n}{\partial n_0} - \left(\frac{V_n}{V_0} + A_n \right) \frac{a_0^2}{\gamma R V_0} \frac{\partial S_0}{\partial n_0} \quad (15)$$

where n_0 is the normal to the streamline of the basic flow in the plane xy .

After several transformations the following equations can be obtained (see reference 2): In the plane $z = \text{Constant}$ along the characteristic line defined by

$$\frac{dy}{dx} = \lambda_1 = \tan(\beta_0 + \varphi_0) \quad (16)$$

the following equation is valid:

$$-\frac{dw_n}{dz} \frac{1}{V_0} \frac{\sin \beta_0 \tan \beta_0}{\cos(\beta_0 + \varphi_0)} + \frac{1}{V_0} \frac{dV_n}{dx} - \tan \beta_0 \frac{d\varphi_n}{dx} + \frac{\sin^3 \beta_0}{\cos(\varphi_0 + \beta_0)} \frac{1}{\gamma R} \frac{dS_n}{dn_0} + \varphi_n B_1 + \frac{V_n}{V_0} C_1 = 0 \quad (17)$$

and along the characteristic line of the second family defined by

$$\frac{dy}{dx} = \lambda_2 = \tan(\varphi_0 - \beta_0) \quad (18)$$

the following equation is valid:

$$-\frac{dw_n}{dz} \frac{1}{V_0} \frac{\sin \beta_0 \tan \beta_0}{\cos(\varphi_0 - \beta_0)} + \frac{dV_n}{dx} \frac{1}{V_0} + \tan \beta_0 \frac{d\varphi_n}{dx} - \frac{\sin^3 \beta_0}{\cos(\varphi_0 - \beta_0)} \frac{1}{\gamma R} \frac{dS_n}{dn_0} - \varphi_n B_2 + \frac{V_n}{V_0} C_2 = 0 \quad (19)$$

where B_1 , B_2 , C_1 , and C_2 are coefficient functions of x , y , V_0 , φ_0 , $\frac{dV_0}{dn_0}$, and $\left(\frac{dV_0}{dx}\right)_1 \left(\frac{dV_0}{dx}\right)_2$ along the characteristic lines of the first and second families at each point and are independent of V_n , φ_n , and w_n , and, therefore, can be determined once for the basic flow and used for any kind of disturbance flow in the limits of the approximation accepted. The coefficients B_1 , B_2 , C_1 , and C_2 are given by the following expressions:

$$B_1 = \frac{1}{\cos \beta_0 \cos(\varphi_0 + \beta_0)} \left[\frac{\sin^4 \beta_0}{\gamma R} \frac{dS_0}{dn_0} - \frac{1}{V_0} \left(\frac{dV_0}{dx}\right)_2 \frac{\cos(\varphi_0 - \beta_0)}{\sin \beta_0} \right] \quad (20a)$$

$$B_2 = \frac{1}{\cos \beta_0 \cos(\varphi_0 - \beta_0)} \left[-\frac{\sin^4 \beta_0}{\gamma R} \frac{dS_0}{dn_0} - \frac{1}{V_0} \left(\frac{dV_0}{dx}\right)_1 \frac{\cos(\varphi_0 + \beta_0)}{\sin \beta_0} \right] \quad (20b)$$

$$C_1 = \frac{1}{V_0} \left(\frac{dV_0}{dx}\right)_1 \left(\tan^2 \beta_0 + \frac{\gamma - 1}{2 \sin^2 \beta_0 \cos^2 \beta_0} \right) - \left[\frac{2}{\gamma R} \frac{dS_0}{dn_0} \frac{\sin^3 \beta_0}{\cos(\varphi_0 + \beta_0)} - \frac{1}{V_0} \left(\frac{dV_0}{dx}\right)_2 \frac{\cos(\varphi_0 - \beta_0)}{\cos(\varphi_0 + \beta_0) \cos^2 \beta_0} \right] \left(1 + \frac{\gamma - 1}{2 \sin^2 \beta_0} \right) \quad (20c)$$

$$C_2 = \frac{1}{V_0} \left(\frac{dV_0}{dx}\right)_2 \left(\tan^2 \beta_0 + \frac{\gamma - 1}{2 \sin^2 \beta_0 \cos^2 \beta_0} \right) + \left[\frac{2}{\gamma R} \frac{dS_0}{dn_0} \frac{\sin^3 \beta_0}{\cos(\varphi_0 - \beta_0)} + \frac{1}{V_0} \left(\frac{dV_0}{dx}\right)_1 \frac{\cos(\varphi_0 + \beta_0)}{\cos(\varphi_0 - \beta_0) \cos^2 \beta_0} \right] \left(1 + \frac{\gamma - 1}{2 \sin^2 \beta_0} \right) \quad (20d)$$

where $\left(\frac{dV_0}{dx}\right)_1$ is the derivative along the characteristic of the first family and $\left(\frac{dV_0}{dx}\right)_2$, along the characteristic of the second family.

In order to determine the value of w_n at each point of the characteristic net, the following relations can be used in the

plane $z = \text{Constant}$:

$$\left. \begin{aligned} \xi &= \frac{\partial w}{\partial y} \frac{\partial v}{\partial z} \\ \eta &= \frac{\partial u}{\partial z} \frac{\partial w}{\partial x} \\ \zeta &= \frac{\partial v}{\partial x} \frac{\partial u}{\partial y} \end{aligned} \right\} \quad (21)$$

and, if s_0 is a streamline projection in the plane $z = \text{Constant}$,

$$\frac{\partial w}{\partial s_0} = \frac{\partial w}{\partial x} \frac{u}{V} + \frac{\partial w}{\partial y} \frac{v}{V} = -\frac{u}{V} \eta + \frac{v}{V} \xi + \frac{\partial V}{\partial z} = \frac{\partial V}{\partial z} + \frac{\partial S}{\partial z} \frac{a^2}{\gamma R V} \quad (22)$$

In the approximation accepted,

$$\left. \begin{aligned} \frac{\partial V}{\partial z} &= \sum a_n \frac{\partial V_n}{\partial z} \\ \frac{\partial S}{\partial z} &= \sum a_n \frac{\partial S_n}{\partial z} \end{aligned} \right\} \quad (23)$$

therefore,

$$\frac{1}{V_0} \frac{\partial w_n}{\partial s_0} = \frac{1}{V_0} \frac{\partial V_n}{\partial z} + \frac{\partial S_n}{\partial z} \frac{a_0^2}{\gamma R V_0^2} \quad (24)$$

where s_0 is the streamline of the basic flow.

Equation (24) permits the determination of the value of w at each point of the plane $z = \text{Constant}$ as a function of the local variation of V_n in the z -direction. Therefore, by means of a step-by-step procedure, all the flow field can be determined by working in planes $z = \text{Constant}$ where only one characteristic net must be used, by means of equations (17) and (19), and by determining the value of $\frac{\partial w}{\partial s_0}$ at each point of the net by means of equation (24). The calculations are started from the flow field defined, or along a surface which is not a characteristic surface, or along a characteristic surface and a stream surface. The flow field at the starting surface must be determined from the boundary conditions. If the starting surface is a shock wave, the flow at the shock surface must be obtained from the physical properties of the shock wave related to the boundary conditions considered. Relations between boundary conditions and shock waves are presented in detail subsequently for the problems considered.

Similar equations can be obtained by using cylindrical coordinates in place of Cartesian coordinates.

Equations (17) and (19) remain the same. Only the first term changes: $\frac{\partial w}{\partial z}$ becomes $\frac{\partial w}{y \partial \theta}$, and the coefficients B_1 and

B_2 become

$$\left. \begin{aligned} B_1' &= \frac{1}{\cos \beta_0 \cos(\varphi_0 + \beta_0)} \frac{\sin \beta_0 \sin(\varphi_0 - \beta_0)}{y} + B_1 \\ B_2' &= \frac{1}{\cos \beta_0 \cos(\varphi_0 - \beta_0)} \frac{\sin \beta_0 \sin(\varphi_0 + \beta_0)}{y} + B_2 \end{aligned} \right\} \quad (25)$$

Equation (24) for cylindrical coordinates becomes (see reference 2, equation (8c))

$$\left(\frac{\partial w_x}{\partial \theta_0}\right)_{\theta=\text{constant}} = \frac{\partial V_x}{y \partial \theta} + \frac{a_0^2}{\gamma R V_0} \frac{\partial S_x}{y \partial \theta} - \frac{w_x \sin \theta_0}{y} \quad (26)$$

The use of the linearized characteristic system is simpler in many cases than the complete characteristic system and reduces in some practical applications the extent of the numerical work required, especially if solutions of many similar problems are required. The same concept can also be easily applied in the field of nonsteady or relative motion of flows.

The flow field around slender bodies without axial symmetry can be obtained by means of linearized methods, and some practical three-dimensional problems not analyzed before in the approximation of nonlinearized flow can be analyzed by this method.

In the next sections some typical possible applications are presented.

SOME TYPICAL APPLICATIONS OF THE LINEARIZED CHARACTERISTICS METHOD

TWO-DIMENSIONAL ROTATIONAL FLOW FIELDS

Two-dimensional potential flow permits hodograph solutions, and, therefore, any kind of two-dimensional supersonic potential-flow solution can be obtained in the hodograph plane; the numerical solution in the physical plane then requires only the construction of a characteristic net in order to find the position in the physical plane of each point of the hodograph plane. The solutions of problems in which boundary conditions are given only along a streamline are very simple in the approximation of potential flow because in this case the velocity is constant along a family of characteristic lines (single-wave flow); however, similar calculations for rotational flow are much more involved, because a step-by-step procedure is required for the solution on the hodograph plane as well as for the construction of the characteristic net. By means of the linearized characteristics method a rotational flow field can be considered as a modification of a potential flow field, and the linearized superposed flow is the flow which takes into account the effect of the presence of shock waves and the effect of rotation in the flow.

Consider, for example, a two-dimensional profile which produces a shock wave at the leading edge (fig. 1). If the profile is curved, the shock is curved, and the flow behind the shock is rotational. Assume that the flow field behind the shock can be expressed as

$$\left. \begin{aligned} u &= u_0 + u_1 & v &= v_0 + v_1 \\ V &= V_0 + V_1 & \varphi &= \varphi_0 + \varphi_1 \\ S &= S_1 \end{aligned} \right\} \quad (27)$$

where u_0 and v_0 are the velocity components defined by a potential flow field, which in this case is a single-wave flow,

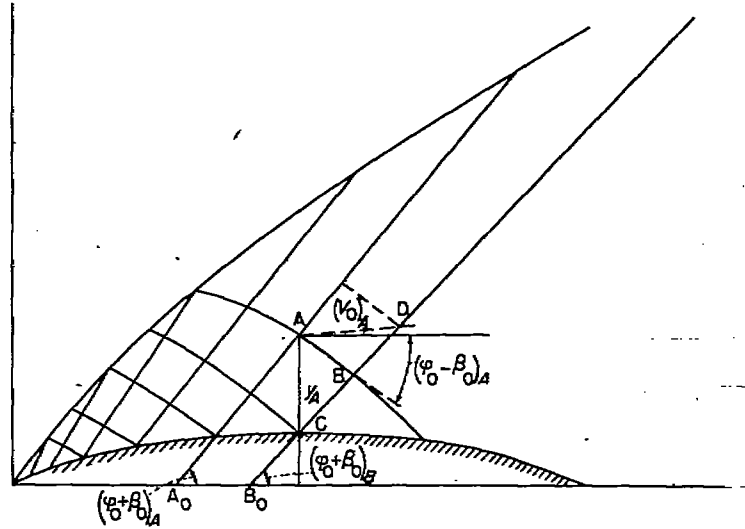

FIGURE 1.—Application of the linearized characteristic system to two-dimensional rotational flow.

$\left(\frac{dV_0}{dx}\right)_1$ along the characteristic lines of the first family is zero, and u_1 , v_1 , and S_1 represent the flow field that takes into account the reflections occurring at the shock and the effects of the entropy gradient. The flow field represented by V_0 and φ_0 can be immediately determined, and V_0 and φ_0 are constant along the characteristic lines of the first family, which are straight lines. The characteristic net of the flow V_0, φ_0 can be drawn in a short time. Then, along the characteristic of the first family,

$$dV_1 \frac{1}{V_0} - \tan \beta_0 d\varphi_1 + \frac{\sin^2 \beta_0}{\gamma R} dS_1 + \varphi_1 B_1 dx_1 + \frac{V_1}{V_0} C_1 dx_1 = 0 \quad (28)$$

where

$$B_1 = -\frac{1}{\cos \beta_0 \cos(\varphi_0 + \beta_0)} \frac{1}{V_0} \left(\frac{dV_0}{dx}\right)_2 \frac{\cos(\varphi_0 - \beta_0)}{\sin \beta_0} \quad (29)$$

and

$$C_1 = \left(\frac{dV_0}{dx}\right)_2 \frac{1}{V_0} \frac{\cos(\varphi_0 - \beta_0)}{\cos(\varphi_0 + \beta_0)} \frac{1}{\cos^2 \beta_0} \left(1 + \frac{\gamma - 1}{2 \sin^2 \beta_0}\right) \quad (30)$$

and, along the characteristic of the second family,

$$\frac{1}{V_0} dV_1 + \tan \beta_0 d\varphi_1 + \frac{\sin^2 \beta_0}{\gamma R} dS_1 + \frac{V_1}{V_0} \frac{dV_0}{V_0} \left(\tan^2 \beta_0 + \frac{\gamma - 1}{2 \sin^2 \beta_0 \cos^2 \beta_0}\right) = 0 \quad (31)$$

Equations (28) and (31) can be simplified by introducing the gradients $(V_0)_x$ and $(\varphi_0 + \beta_0)_x$ along the x -axis defined as

$$\begin{aligned} (V_0)_x &= \left(\frac{\partial V_0}{\partial x}\right)_{x=0} \\ (\varphi_0 + \beta_0)_x &= \left[\frac{\partial(\varphi_0 + \beta_0)}{\partial x}\right]_{x=0} \end{aligned} \quad (32)$$

It can be seen from figure 1 that, at any point A of ordinate y_A on the characteristic line a, crossing the axis at A_0 , the

variation $\left(\frac{dV_0}{dx}\right)_2$ along the characteristic line of the second family at A is

$$\left[\left(\frac{dV_0}{dx}\right)_2\right]_A = (V_{0x})_{A_0} \left[1 - \frac{\cot(\varphi_0 + \beta_0)_{A_0}}{\cot(\varphi_0 - \beta_0)_{A_0}}\right] \frac{1}{1 - \frac{y_A[(\varphi_0 + \beta_0)_{A_0}]}{\sin^2(\varphi_0 + \beta_0)_{A_0}}} \quad (33)$$

because β_0 and φ_0 are the same at A and at A_0 . Therefore,

$$\frac{1}{V_0} \left(\frac{dV_0}{dx}\right)_A = \frac{a}{1 - by_A} \quad (34)$$

where a and b are constants along each characteristic line of the first family. Then equation (28) along the characteristic line of the first family becomes

$$\begin{aligned} \frac{dV_1}{V_0} - \tan \beta_0 d\varphi_1 + \frac{\sin^2 \beta_0}{\gamma R} dS_1 - \\ \varphi_1 \frac{\cos(\varphi_0 - \beta_0)}{\sin(\varphi_0 + \beta_0)} \frac{1}{\cos \beta_0 \sin \beta_0} \frac{a dy}{1 - by} + \\ \frac{V_1}{V_0} \left(1 + \frac{\gamma - 1}{2 \sin^2 \beta_0}\right) \frac{a dy \cos(\varphi_0 - \beta_0)}{1 - by \sin(\varphi_0 + \beta_0)} \frac{1}{\cos^2 \beta_0} = 0 \quad (35) \end{aligned}$$

Therefore, if

$$\left. \begin{aligned} a &= \frac{2}{\sin^2(\varphi_0 + \beta_0)} \frac{(V_0)_x}{V_0} \\ b &= \frac{(\varphi_0 + \beta_0)_x}{\sin^2(\varphi_0 + \beta_0)} \end{aligned} \right\} \quad (36)$$

the equation along the first characteristic line becomes

$$\begin{aligned} \frac{dV_1}{V_0} - \tan \beta_0 d\varphi_1 + \frac{\sin^2 \beta_0}{\gamma R} dS_1 + \varphi_1 \frac{\alpha}{b} d \log(1 - by) - \\ \left(1 + \frac{\gamma - 1}{2 \sin^2 \beta_0}\right) \tan \beta_0 \frac{V_1}{V_0} \frac{\alpha}{b} d \log(1 - by) = 0 \quad (37) \end{aligned}$$

and the equation along the second characteristic line becomes

$$\begin{aligned} \frac{dV_1}{V_0} + \tan \beta_0 d\varphi_1 + \frac{\sin^2 \beta_0}{\gamma R} dS_1 + \\ \frac{V_1}{V_0} \frac{dV_0}{V_0} \left(\tan^2 \beta_0 + \frac{\gamma - 1}{2 \sin^2 \beta_0 \cos^2 \beta_0}\right) = 0 \quad (38) \end{aligned}$$

All the coefficients of equations (37) and (38) are constant along characteristic lines of the first family and can be calculated at few points on the x -axis.

The coefficients of equations (37) and (38) are independent of φ_1 and V_1 ; therefore, with one calculation from points A and C of the net of figure 1 the values of V_1 and φ_1 at a point B can be obtained directly without the necessity of an iteration process, with terms of the order of $(\Delta x)^2$ also included in each step. Indeed, if all the quantities which are variable along the characteristic lines are expressed in

the form

$$\left. \begin{aligned} a_B &= a_A + \left(\frac{\partial a}{\partial x}\right)_A \Delta x + \frac{\partial^2 a}{\partial x^2} \frac{\Delta x^2}{2} + 0(\Delta x^3) \\ \left(\frac{\partial a}{\partial x}\right)_B &= \left(\frac{\partial a}{\partial x}\right)_A + \frac{\partial^2 a}{\partial x^2} \Delta x + 0(\Delta x^2) \end{aligned} \right\} \quad (39)$$

then

$$a_B - a_A = \left[\left(\frac{\partial a}{\partial x}\right)_A \Delta x + \left(\frac{\partial a}{\partial x}\right)_B \Delta x\right] \frac{1}{2} + 0(\Delta x^2) \quad (40)$$

Consider now equations (37) and (38). At point C equation (37) has the form

$$\left(\frac{dV_1}{dx}\right)_C = \left(\frac{\partial \varphi_1}{\partial x}\right)_C a_C + \left(\frac{\partial S_1}{\partial x}\right)_C b_C + \varphi_{1C} \left(\frac{dC}{dx}\right)_C + V_{1C} \left(\frac{de}{dx}\right)_C$$

while at point B it has the form

$$\left(\frac{dV_1}{dx}\right)_B = \left(\frac{\partial \varphi_1}{\partial x}\right)_B a_B + \left(\frac{\partial S_1}{\partial x}\right)_B b_B + \varphi_{1B} \left(\frac{dC}{dx}\right)_B + V_{1B} \left(\frac{de}{dx}\right)_B$$

then, from equation (40),

$$\begin{aligned} 2(V_{1B} - V_{1C}) &= \left(\frac{dV_1}{dx}\right)_C \Delta x + \left(\frac{dV_1}{dx}\right)_B \Delta x \\ &= \left[\left(\frac{\partial \varphi_1}{\partial x}\right)_C a_C + \left(\frac{\partial \varphi_1}{\partial x}\right)_B a_B + \left(\frac{\partial S_1}{\partial x}\right)_C b_C + \left(\frac{\partial S_1}{\partial x}\right)_B b_B + \right. \\ &\quad \left. \varphi_{1C} \left(\frac{dC}{dx}\right)_C + \varphi_{1B} \left(\frac{dC}{dx}\right)_B + V_{1C} \left(\frac{de}{dx}\right)_C + V_{1B} \left(\frac{de}{dx}\right)_B\right] \Delta x \quad (41) \end{aligned}$$

But,

$$\begin{aligned} \left[\left(\frac{\partial \varphi_1}{\partial x}\right)_C a_C + \left(\frac{\partial \varphi_1}{\partial x}\right)_B a_B\right] \Delta x \\ = \left[\left(\frac{\partial \varphi_1}{\partial x}\right)_C + \left(\frac{\partial \varphi_1}{\partial x}\right)_B\right] \frac{a_C + a_B}{2} \Delta x + 0(\Delta x^2) \end{aligned}$$

Indeed,

$$\left(\frac{\partial \varphi_1}{\partial x}\right)_B a_B = \left[\left(\frac{\partial \varphi_1}{\partial x}\right)_C + \left(\frac{\partial^2 \varphi_1}{\partial x^2}\right)_C \Delta x\right] \left[a_C + \left(\frac{\partial a}{\partial x}\right)_C \Delta x\right] + 0(\Delta x^2)$$

and

$$\begin{aligned} \left[\left(\frac{\partial \varphi_1}{\partial x}\right)_C a_C + \left(\frac{\partial \varphi_1}{\partial x}\right)_B a_B\right] \Delta x \\ = \left[2 \left(\frac{\partial \varphi_1}{\partial x}\right)_C a_C + \left(\frac{\partial a}{\partial x}\right)_C \left(\frac{\partial \varphi_1}{\partial x}\right)_C \Delta x + a_C \frac{\partial^2 \varphi_1}{\partial x^2} \Delta x\right] \Delta x + 0(\Delta x^2) \end{aligned}$$

and also

$$\begin{aligned} \left[\left(\frac{\partial \varphi_1}{\partial x}\right)_C + \left(\frac{\partial \varphi_1}{\partial x}\right)_B\right] \frac{a_C + a_B}{2} \Delta x = \left[2 \left(\frac{\partial \varphi_1}{\partial x}\right)_C a_C + a_C \left(\frac{\partial^2 \varphi_1}{\partial x^2}\right)_C \Delta x + \right. \\ \left. \left(\frac{\partial a}{\partial x}\right)_C \left(\frac{\partial \varphi_1}{\partial x}\right)_C \Delta x\right] \Delta x + 0(\Delta x^2) \end{aligned}$$

Therefore, equation (37) along the first characteristic line, terms of the order of $(x_B - x_C)^2$ being neglected, can be written

in the form

$$\begin{aligned} & (V_{1B} - V_{1C}) \frac{1}{V_{0c}} - (\varphi_{1B} - \varphi_{1C}) \tan \beta_{0c} + \\ & \frac{S_{1B} - S_{1C}}{\gamma R} \sin^2 \beta_{0c} + \frac{1}{2} \left(\log \frac{1 - b_B y_B}{1 - b_C y_C} \right) \left[(\varphi_{1B} + \varphi_{1C}) - \right. \\ & \left. \tan \beta_0 \frac{V_{1B} + V_{1C}}{V_{0c}} \left(1 + \frac{\gamma - 1}{2 \sin^2 \beta_{0c}} \right) \right] \left(\frac{\alpha}{b} \right)_c = 0 \quad (42) \end{aligned}$$

and equation (38) along the second characteristic line, terms of the order of $(x_B - x_A)^2$ being neglected, can be written in the form

$$\begin{aligned} & (V_{1B} - V_{1A}) \left(\frac{1}{V_{0A}} + \frac{1}{V_{0B}} \right) + (\varphi_{1B} - \varphi_{1A}) (\tan \beta_{0B} + \tan \beta_{0A}) + \\ & \frac{S_{1B} - S_{1A}}{\gamma R} (\sin^2 \beta_{0B} + \sin^2 \beta_{0A}) + \\ & \left\{ \left[\frac{V_1}{V_0^2} \left(\tan^2 \beta_0 + \frac{\gamma - 1}{2 \sin^2 \beta_0 \cos^2 \beta_0} \right) \right]_B + \right. \\ & \left. \left[\frac{V_1}{V_0} \left(\tan^2 \beta_0 + \frac{\gamma - 1}{2 \sin^2 \beta_0 \cos^2 \beta_0} \right) \right]_A \right\} (V_{0B} - V_{0A}) = 0 \quad (43) \end{aligned}$$

Because of the possibility of considering directly in the calculations terms of the order of $(\Delta x)^2$ also, large steps can be used in the characteristic net and the effect of entropy gradients can be easily evaluated after the basic characteristic net and a few streamlines of the basic flow have been determined and the coefficients of equations (39) and (40) calculated at a few points on the axis.

All the coefficients are constant along each characteristic line of the first family; therefore, in going from B to D, only the terms containing S_1 and γ must be changed and the calculations are simplified to some extent with respect to the rotational-flow characteristic calculations.

AXIALLY SYMMETRIC FLOW FIELDS

For axially symmetric flow, the equation of linearized characteristics becomes

$$\frac{1}{V_0} \frac{dV_1}{dx} - \tan \beta_0 \frac{d\varphi_1}{dx} + \frac{\sin^2 \beta_0}{\gamma R} \frac{dS_1}{dx} + \varphi_1 B_1' + \frac{V_1}{V_0} C_1 = 0 \quad (44)$$

along the characteristic line $\lambda_1 = \tan(\beta_0 - \varphi_0)$ and

$$\frac{1}{V_0} \frac{dV_1}{dx} + \tan \beta_0 \frac{d\varphi_1}{dx} + \frac{\sin^2 \beta_0}{\gamma R} \frac{dS_1}{dx} - \varphi_1 B_2' + \frac{V_1}{V_0} C_2 = 0 \quad (45)$$

along the line $\lambda_2 = \tan(\varphi_0 - \beta_0)$ where B_1' , B_2' , C_1 , and C_2 are defined by equations (25) and (20).

The introduction of equations (44) and (45) simplifies noticeably the numerical calculations without affecting sensibly the precision of the results. The practical use can be as follows: A basic body shape is determined first by means of characteristic calculations, and the characteristic net is then obtained. The basic calculations must be extended in a region in front of the shock wave, determined with the usual

procedure (for example, reference 3), and in a region inside the body as shown in figure 2 in order to determine all the flow field necessary. Thus, a reduced number of points of the characteristic net is chosen at which the superposed flow field for each boundary condition different from the basic shape will be determined. The number of points required depends on the magnitude of the superposed flow field; however, the number is usually small, because for each step between two points A and B the disturbance velocity can be expressed in the form

$$(V_1)_B = (V_1)_A + \left(\frac{dV_1}{dx} \right)_A \Delta x + \left(\frac{d^2 V_1}{dx^2} \right)_A \frac{\Delta x^2}{2} \quad (46)$$

where the term $\left(\frac{d^2 V_1}{dx^2} \right)_A \frac{\Delta x^2}{2}$ is also included because, in the differential equations (44) and (45), the coefficients of the differential equations are independent of the solution and are known at both points. If the entropy term S_1 is neglected, by applying finite-difference methods the velocity components at a given point g5 of the characteristic net can be expressed from the values at two points f5 and g4 in the forms

$$(V_1)_{g5} = (V_1)_{g4} \frac{1-n}{1+n} - (\varphi_1)_{g4} \frac{m+L}{1+n} - (\varphi_1)_{g5} \frac{m-L}{1+n} \quad (47)$$

$$(V_1)_{g5} = (V_1)_{f5} \frac{1-r}{1+r} + (\varphi_1)_{f5} \frac{p+q}{1+r} + (\varphi_1)_{g5} \frac{q-p}{1+r} \quad (48)$$

$$\begin{aligned} (\varphi_1)_{g5} = & \frac{1}{\frac{m-L}{1+n} + \frac{q-p}{1+r}} \left[(V_1)_{g4} \frac{1-n}{1+n} - (V_1)_{f5} \frac{1-r}{1+r} - (\varphi_1)_{g4} \frac{m+L}{1+n} - \right. \\ & \left. (\varphi_1)_{f5} \frac{p+q}{1+r} \right] \quad (49) \end{aligned}$$

where $(\varphi_1)_{g4}$, $(\varphi_1)_{f5}$, $(V_1)_{g4}$, and $(V_1)_{f5}$ are functions of the boundary conditions considered, while the coefficients L , m , n , p , q , and r are functions only of the basic flow field and, therefore, must be determined only once for any boundary condition considered. These coefficients are

$$\begin{aligned} L &= \frac{(V_0 \tan \beta_0)_{g4} + (V_0 \tan \beta_0)_{g5}}{2} \\ m &= (x_{g5} - x_{g4}) [(V_0)_{g4} (B_1')_{g4} + (V_0)_{g5} (B_1')_{g5}] \frac{1}{4} \\ n &= (x_{g5} - x_{g4}) [(C_1)_{g4} + (C_1)_{g5}] \frac{1}{4} \\ p &= \frac{(V_0 \tan \beta_0)_{f5} + (V_0 \tan \beta_0)_{g5}}{2} \\ q &= (x_{g5} - x_{f5}) [(V_0)_{g5} (B_2')_{g5} + (V_0)_{f5} (B_2')_{f5}] \frac{1}{4} \\ r &= (x_{g5} - x_{f5}) [(C_2)_{g5} + (C_2)_{f5}] \frac{1}{4} \end{aligned} \quad (50)$$

If the entropy terms in $\frac{dS_1}{dn_0}$ are considered, two more terms

in $(S_1)_{25}$ and $(S_1)_{24}$ must be considered in equations (47) and (48) and two more terms in $(S_1)_{15}$ and $(S_1)_{24}$, in equation (49). However, because these terms are small, they can usually be neglected in practical calculations.

Because all the coefficients are determined only once, the determination of $(V_1)_{25}$ or $(\varphi_1)_{25}$ for each boundary condition is simple. Points at the boundary can be investigated by means of equations (47), (48), and (49). Points on the shock can be analyzed in a similar manner. A practical calculation can be performed in the following way: The basic flow field and the number of points in which the superposed flow field will be considered having been determined, the new boundary conditions (shape of the body) are placed in the characteristic net (fig. 3). If A is the point where the basic body departs from conical shape and OBC is the new boundary condition, the flow field between the surface of the conical body OB and the conical shock OE are known from cone calculations; therefore, the values of V and φ at each point Ba, 1a, 2a, 3a, and Ea of the basic characteristic net are determined, and by difference the values of V_1 and φ_1 can be obtained. From a1 the flow at the point L of the boundary can be determined from equation (48) where φ_1 is known at L, and the coefficients at L can be determined by linear interpolation between b1 and c1. From the values of V_1 and φ_1 at a1 and L1, the corresponding values at b1 are interpolated. Then all the values for the line b can be obtained. For the determination of V_1 and φ_1 at a point F on the shock wave, the equations of the shock wave and equation (47)

are valid. At the point F the values of φ_0 and V_0 are known, and from the equations of the shock wave the value of $\frac{\partial V}{\partial \varphi}$ as function of φ can be determined. (The value of φ fixes the deviation across the shock wave.) Therefore,

$$(V)_F = (V_0)_F + (V_1)_F = (V_0)_F + \left(\frac{\partial V}{\partial \varphi}\right) (\varphi)_F \quad (51)$$

Then, equation (47) applied between the points 4b and F gives

$$\begin{aligned} (V_1)_F &= \left(\frac{\partial V}{\partial \varphi}\right)_{\varphi_0} (\varphi_1)_F \\ &= (V_1)_N \frac{1-n}{1+n} - (\varphi_1)_N \frac{m+L}{1+n} - (\varphi_1)_F \frac{m-L}{1+n} \end{aligned} \quad (52)$$

and the value of $(\varphi_1)_F$ can be determined.

The work required in the calculation of the flow field for the basic body and the determination of the coefficients $L, m, n, p, q,$ and r can be reduced to a minimum if conical bodies are assumed as basic bodies for the calculations, because in this case the basic flow is available in tabulated values (reference 5) and the coefficients $L, m, n, p, q,$ and r are functions only of the polar coordinate ψ .

For conical flow, the calculations can be performed in the following way: From conical-flow calculations, the values of v_r and v_n as functions of ψ are known, where v_r is the radial component and v_n , the normal component of the flow field in polar coordinates referred to the limiting velocity (fig. 4). The following expressions for $V_0, \beta_0,$ and φ_0 can be determined from the cone calculations:

$$\left. \begin{aligned} V^2 &= v_n^2 + v_r^2 \\ \frac{1}{V_0^2} &= 1 + \frac{2}{\gamma-1} \sin^2 \beta_0 \\ \varphi_0 &= \psi + \gamma \\ \tan \gamma &= \frac{v_n}{v_r} \end{aligned} \right\} \quad (53)$$

Therefore, $\beta_0 + \varphi_0$ and $\varphi_0 - \beta_0$ are known as functions of ψ . From a point A on the conical body, the characteristic line

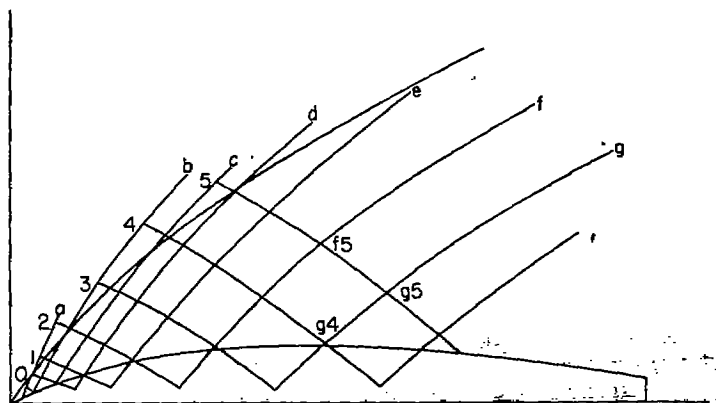

FIGURE 2.—The basic characteristic net for axially symmetric flow.

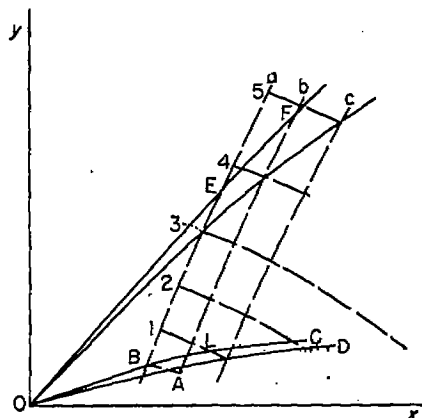

FIGURE 3.—Practical application of the linearized characteristics system to axially symmetric flows.

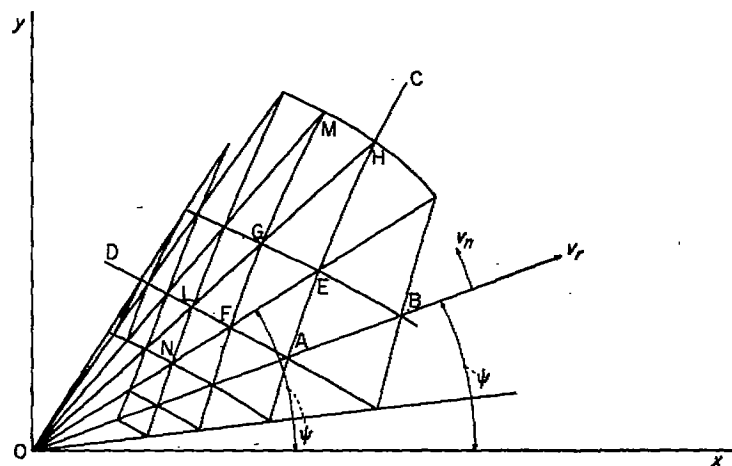

FIGURE 4.—The basic net when conical flow is assumed as the basic flow for the linearized characteristics method.

of the first family AC and of the second family AD can be drawn. The line is defined by the expressions

$$\frac{y_E - y_A}{x_E - x_A} = \frac{\tan(\beta + \varphi)_A + \tan(\beta + \varphi)_E}{2}$$

$$\frac{y_F - y_A}{x_A - x_F} = \frac{\tan(\beta - \varphi)_A + \tan(\beta - \varphi)_F}{2}$$

In order to construct a characteristic net that requires only a small amount of calculation, the points of the net are chosen along straight lines from O so that the conical property of the flow can be utilized. The net can be constructed by fixing the steps along the body.

When point B is chosen along AO, the point E along AC is determined by drawing BE parallel to AF. From E and F (along OE and AD) the lines GE parallel to LF and FG parallel to EH can be determined, and the point G can be obtained. From G and H, point M can be obtained, and by proceeding in a similar way, all the characteristic net can be determined. The coefficients of equations (50) are the same for each point N, F, and E along the same radius. The tabulated values are given only in the region between the body and the shock wave; however, the calculations can be extended by means of conical calculations. For example, from the following equations (see, for example, reference 4, p. 243, and the following pages):

$$(R)_{\psi C} = \left[-\frac{r_r + v_n \cot \psi}{1 - \frac{2v_n^2}{(\gamma - 1)(1 - V_0^2)}} \right]_{\psi C} \quad (54)$$

and

$$\left. \begin{aligned} (v_n)_{\psi C + \Delta \psi} &= (v_n)_{\psi C} \cos \Delta \psi + (R - v_r)_{\psi C} \sin \Delta \psi \\ (v_r)_{\psi C + \Delta \psi} &= (v_r)_{\psi C} \sin \Delta \psi - (R - v_r)_{\psi C} \cos \Delta \psi + (R)_{\psi C} \end{aligned} \right\} \quad (55)$$

(where R is the radius of curvature of the streamline in the hodograph plane); therefore, the characteristic net can be extended to the outside flow. For conical flow the coefficients B_1' , B_2' , C_1 , and C_2 can be determined as functions of ψ . For conical flow, coefficient B_1' of equation (25) becomes

$$B_1' = \frac{1}{\cos \beta_0 \cos(\varphi_0 + \beta_0)} \left[\frac{\sin \beta_0 \sin(\varphi_0 - \beta_0)}{y} - \frac{1}{V_0} \frac{dV_0}{d\psi} \left(\frac{d\psi}{dx} \right)_{\lambda_2} \frac{\cos(\varphi_0 - \beta_0)}{\sin \beta_0} \right]$$

and C_1 becomes

$$C_1 = \frac{1}{V_0} \frac{dV_0}{d\psi} \left(\frac{d\psi}{dx} \right)_{\lambda_1} \frac{1}{\cos^2 \beta_0} \left(\sin^2 \beta_0 + \frac{\gamma - 1}{2 \sin^2 \beta_0} \right) + \frac{1}{V_0} \frac{dV_0}{d\psi} \left(\frac{d\psi}{dx} \right)_{\lambda_2} \frac{\cos(\varphi_0 - \beta_0)}{\cos(\varphi_0 + \beta_0)} \frac{1}{\cos^2 \beta_0} \left(1 + \frac{\gamma - 1}{2 \sin^2 \beta_0} \right)$$

but

$$\left(\frac{d\psi}{dx} \right)_{\lambda_1} = \frac{\sin \psi \sin(\varphi_0 + \beta_0 - \psi)}{y \cos(\varphi_0 + \beta_0)} \quad (56)$$

and

$$\left(\frac{d\psi}{dx} \right)_{\lambda_2} = -\frac{\sin \psi \sin(\psi - \varphi_0 + \beta_0)}{y \cos(\varphi_0 - \beta_0)} \quad (57)$$

Therefore,

$$a = \left[B_1' V_0 \left(\frac{dx}{d\psi} \right)_{\lambda_1} \right]_{\psi} = \frac{1}{\cos \beta_0} \left[V_0 \frac{\sin \beta_0 \sin(\varphi_0 - \beta_0)}{\sin \psi \sin(\varphi_0 + \beta_0 - \psi)} + \left(\frac{dV_0}{d\psi} \right)_{\psi} \frac{1}{\sin \beta_0 \sin(\varphi_0 + \beta_0 - \psi)} \right] \quad (58a)$$

$$b = \left[B_2' V_0 \left(\frac{dx}{d\psi} \right)_{\lambda_2} \right]_{\psi} = \frac{1}{\cos \beta_0} \left[-V_0 \frac{\sin \beta_0 \sin(\varphi_0 + \beta_0)}{\sin \psi \sin(\psi - \varphi_0 + \beta_0)} + \left(\frac{dV_0}{d\psi} \right)_{\psi} \frac{1}{\sin \beta_0 \sin(\psi - \varphi_0 + \beta_0)} \right] \quad (58b)$$

and

$$c = C_1 \left(\frac{dx}{d\psi} \right)_{\lambda_1} = \frac{1}{V_0} \left(\frac{dV_0}{d\psi} \right)_{\psi} \left[\frac{1}{\cos^2 \beta_0} \left(\sin^2 \beta_0 + \frac{\gamma - 1}{2 \sin^2 \beta_0} \right) - \frac{1}{\cos^2 \beta_0} \left(1 + \frac{\gamma - 1}{2 \sin^2 \beta_0} \right) \frac{\sin(\psi - \varphi_0 + \beta_0)}{\sin(\varphi_0 + \beta_0 - \psi)} \right] \quad (58c)$$

$$d = C_2 \left(\frac{dx}{d\psi} \right)_{\lambda_2} = \frac{1}{V_0} \left(\frac{dV_0}{d\psi} \right)_{\psi} \left[\frac{1}{\cos^2 \beta_0} \left(\sin^2 \beta_0 + \frac{\gamma - 1}{2 \sin^2 \beta_0} \right) - \frac{1}{\cos^2 \beta_0} \left(1 + \frac{\gamma - 1}{2 \sin^2 \beta_0} \right) \frac{\sin(\varphi_0 + \beta_0 - \psi)}{\sin(\psi - \varphi_0 + \beta_0)} \right] \quad (58d)$$

and

$$\frac{dV_0}{d\psi} = \frac{v_n}{V_0} \frac{r_r + v_n \cot \psi}{1 - \frac{2v_n^2}{(\gamma - 1)(1 - V_0^2)}} \quad (58e)$$

If equations (58) are used, the coefficients of equations (50) can be expressed as follows:

$$\left. \begin{aligned} m &= \frac{1}{4} (\psi_{E5} - \psi_{E4}) (a_{E4} + a_{E5}) \\ n &= \frac{1}{4} (\psi_{E5} - \psi_{E4}) (c_{E4} + c_{E5}) \\ q &= \frac{1}{4} (\psi_{E5} - \psi_{E5}) (b_{E5} + b_{E5}) \\ r &= \frac{1}{4} (\psi_{E5} - \psi_{E5}) (d_{E5} + d_{E5}) \end{aligned} \right\} \quad (59)$$

Because the coefficients a , b , c , and d are functions only of ψ and of the free-stream Mach number M , they need to be calculated only once for different values of M and given in tabulated form; therefore, the calculation of any flow field for which the basic flow can be considered a conical flow can be reduced to the solution of a few linear equations with known coefficients.

In order to try the method, the flow around an ogive, as shown in figure 5, has been determined at $M=3.016$ by the method of characteristics and by the method of linearized characteristics. In figure 5 the usual characteristic net is shown, while in figure 6 the linearized characteristic net and the basic body are presented. As a first basic body the cone chosen is the cone tangent to the apex having a cone angle of 12.5° . The cone chosen is not the most convenient because the values of φ_1 at the end of the ogive are large, and a better approximation would be obtained if a cone of smaller cone angle would be considered as the basic body. A cone somewhat different from the ogive considered has been chosen in order to have some information on the approximation of the method for sensible variations of the shape of the body from the basic body.

Downstream of the characteristic line AB, the velocity components V_1 and φ_1 would become large because at the surface of the body the component φ is quite different from the component φ_0 of the basic flow; therefore, the flow determination in the region downstream of the line AB has been considered as a new problem, defined by the flow along AB and from the streamline that represents the body shape. In

this region a new basic flow has been considered. Again, a conical flow field has been assumed as the basic flow. From the values of φ and V at B and A, and from the order of magnitude of φ downstream along the body, a conical flow field that would give a small disturbance component in this region has been selected. The cone chosen for the second part is a 5° cone at $M=3.077$. The cone is entirely contained within the body considered in the region used in the calculations as shown in figure 6, and the most convenient region of the conical flow field is used for the calculations.

In order to pass from one basic body shape to the other, the components V_1 and φ_1 along the characteristic line AB for the second basic body must be determined. This operation can be performed by determining the value of $V_0' + V_1'$ and $\varphi_0' + \varphi_1'$ at the points a, b, and n of figure 6 for the first basic body, by interpolating the values at the points a', b', and n' between characteristics 1 and 2 along the characteristic of the other family, and then by determining the new value of V_1'' and φ_1'' for the second basic body along AB from the expressions

$$V_1'' = V - V_0''$$

$$\varphi_1'' = \varphi - \varphi_0''$$

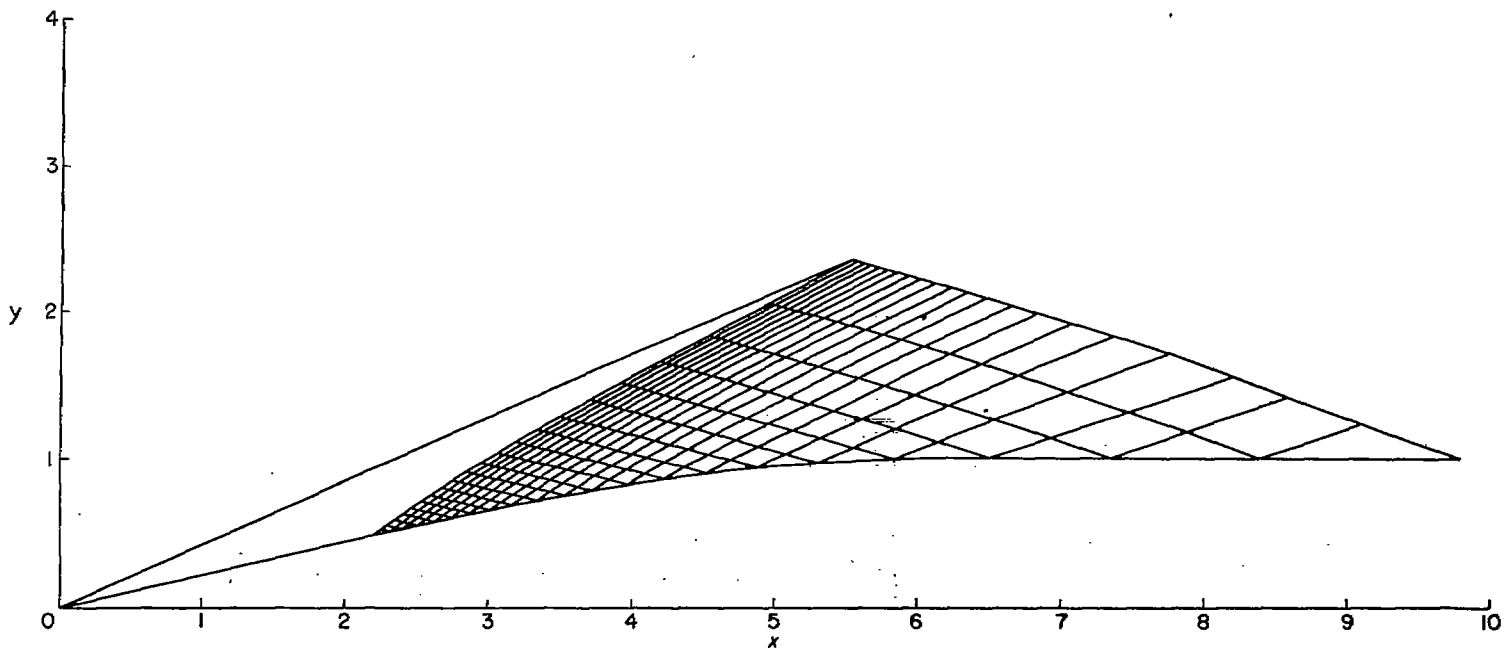

FIGURE 5.—The shape of the body analyzed and the net used for the characteristics method for $M=3.016$.

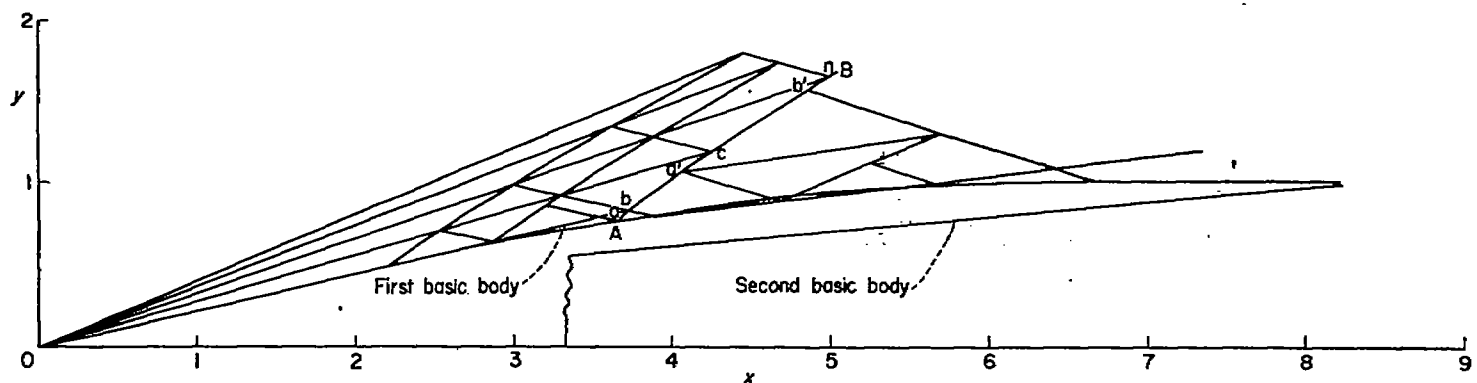

FIGURE 6.—The characteristic net for linearized characteristic calculations. First basic body, 12.5° cone at $M=3.016$; second basic body, 5° cone at $M=3.077$.

and

$$V = V_0' + V_1'$$

$$\varphi = \varphi_0' + \varphi_1'$$

where V_0'' and φ_0'' are the values of V and φ for the second basic body at the position considered and V_0' and φ_0' , the values for the first basic body.

The calculations by linearized characteristics required the solution of 11 linear equations of the type of equation (47), (48), or (49) with one unknown and the interpolation of four points, which can be done in a very short time (of the order of 1 hour) when the net is drawn and the coefficients of the equations are determined. The pressure distribution obtained is presented in figure 7 and is compared with the pressure distribution obtained from the exact method.

For the back part of the body where the flow differs slightly from parallel flow, a cylindrical body with uniform flow at different Mach numbers can be considered as the basic body. In each region of the flow the Mach number for the basic flow is constant; however, the component u can be approximated conveniently by changing the basic-flow Mach number.

When the body has a tail, a conical solution as proposed in reference 6 for flow inside a tube can be assumed as the basic body. In this case, each streamline of the conical solution can be considered as the shape of the basic body (fig. 8), and the flow field can be obtained from conical-flow calculations which can be determined easily in the hodograph plane. By changing the strength of the final shock of the conical solu-

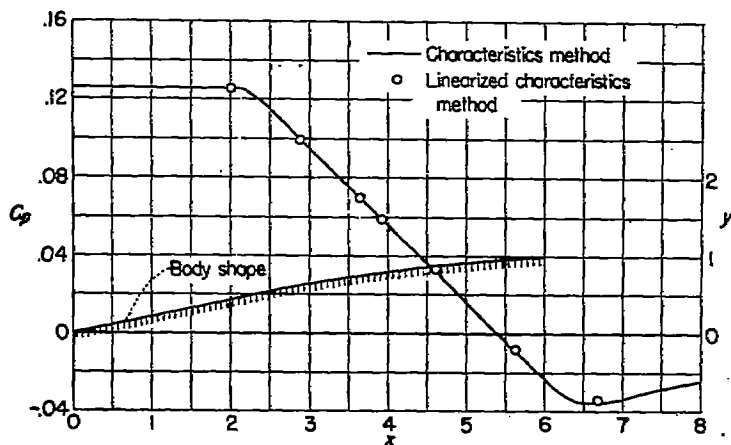

FIGURE 7.—Comparison between results of the calculation by the characteristics method and by the linearized characteristics method obtained at $M=3.016$.

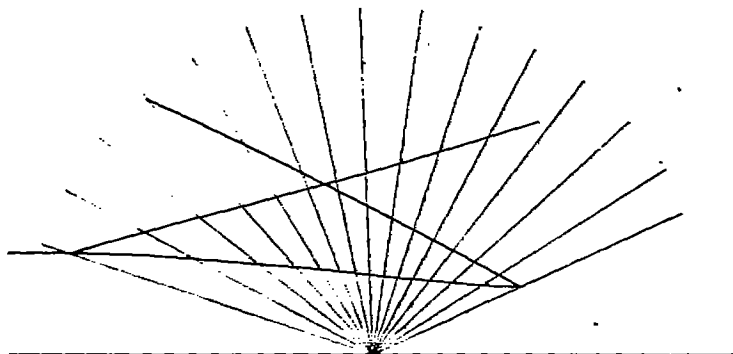

FIGURE 8.—Conical flow for tail of axially symmetric body. Initial $M=3.2$.

tion, different ratios between maximum cross-sectional area and tail area can be obtained. Any part of the streamline can be assumed as the basic body shape.

The present method does not require the existence of a linearized solution and, therefore, can be applied also at high Mach numbers. This method permits obtaining the shape of the shock wave and taking into account entropy variations. High precision can be obtained by using several basic flow fields for the different regions of the body considered. Because of the simplicity of the calculations, the systematic calculations and tabulation of coefficients of equations (58) for different cones and different Mach numbers would be of great practical interest.

Tabulated values can be obtained also in the following way: For each cone OC of cone angle φ_0 considered, a superposed flow must be calculated as shown, for example, in figure 9(a). The values of V_1 and φ_1 for this superposed flow are obtained at given points of the characteristic net. Because of the linearization of equations, if the superposed flow changes in intensity, the values of V_1 and φ_1 at every point change proportionately. Because of the conical property, if the point A (fig. 9 (b)) moves along OC, the flow field changes in scale; therefore, the effect on a point E due to the superposed flow field $\Delta\varphi_1$ starting at A is equal to the effect of a linearized flow field starting at A' and of intensity $\Delta\varphi_1$ at a corresponding point E' defined by

$$\frac{x_{E'}}{x_E} = \frac{x_{A'}}{x_A} = \frac{y_{E'}}{y_E}$$

Therefore, when the flow field for the disturbance AB is determined, the effect of any disturbance of the type of the disturbance AB in the entire flow field can be obtained. Then any body shape can be considered as a superposition of flow fields of the type of flow corresponding to the disturbance $\Delta\varphi$ placed along the basic cone. From the simple calculation of the flow for the shape AB, the velocity can be

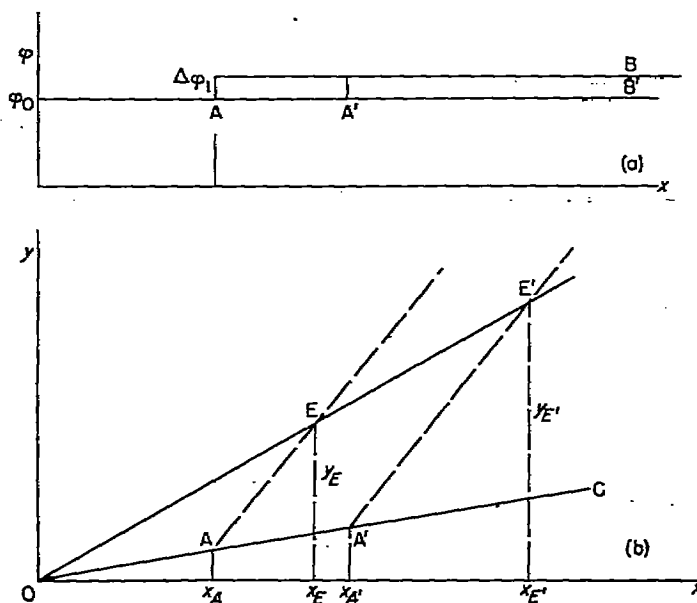

(a) Disturbance distribution.
 (b) Position of the disturbance.

FIGURE 9.—Determination of linearized flow of constant intensity superposed on conical flow.

determined by means of the equation

$$V = V_0 + \sum_1^n V_n$$

where n is the number of the superposed flows that affect the point considered.

Consider, for example, figure 10. Several linearized flow disturbances must be superposed on the basic conical flow field. First, a superposed conical flow at O that can be obtained from conical-flow calculations must be considered. At A_0 a superposed disturbance must be added in order to satisfy the boundary conditions at A . If the calculations have been performed for the disturbance at a_0 and for $\Delta\varphi_1=1$, the velocity at A can be obtained from

$$V_A = (V_0)_A + (V_1)_A + (V_2)_A$$

where $(V_0)_A$ is the velocity of the basic flow at A , $(V_1)_A$ is the velocity disturbance at A due to the conical flow superposed at O , and $(V_2)_A$ is proportional to

$$\varphi_{2A} = \varphi_A - [(\varphi_0)_A + (\varphi_1)_A]$$

and can be obtained from

$$(V_2)_b \frac{(\varphi_2)_A}{(\Delta\varphi)_a} = (V_2)_A$$

where b is determined by

$$\frac{x_{A_0}}{x_{a_0}} = \frac{x_A}{x_b} = \frac{y_A}{y_b}$$

In a similar way V_2 is determined at the points B , C , and so forth. At B another linearized flow field having velocity components V_3 and φ_3 must be considered where

$$(\varphi_3)_B = \varphi_B - [(\varphi_0)_B + (\varphi_1)_B + (\varphi_2)_B]$$

and

$$(V_3)_B = (V_2)_b \frac{(\varphi_3)_B}{(\varphi_1)_a}$$

where b is defined by

$$\frac{x_{B_0}}{x_{a_0}} = \frac{x_B}{x_b} = \frac{y_B}{y_b}$$

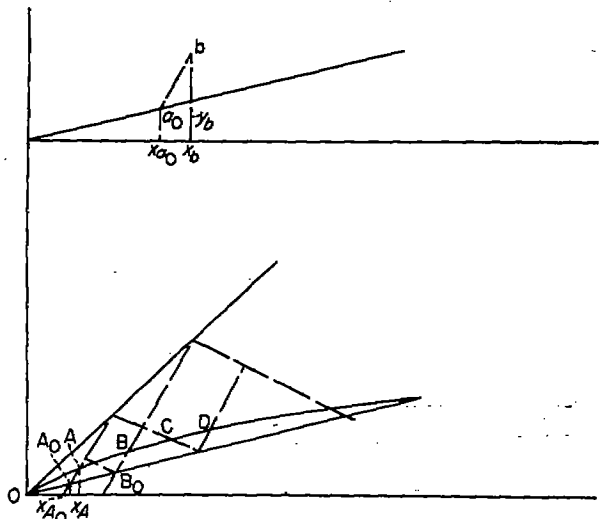

FIGURE 10.—Application of the linearized characteristics method having constant disturbance superposed on a conical basic flow.

Because of the rapidity of calculation, the variation of any geometrical parameter can be investigated in practical applications without the necessity of a large amount of numerical work.

CONICAL FLOW FIELD WITHOUT AXIAL SYMMETRY

The calculation of slender bodies without axial symmetry requires the determination of conical flow without axial symmetry, which can be done by means of the linearized characteristic method. The basic problem of the determination of conical flow consists in determining the shape of the conical shock wave produced by the body. When the shape of the shock is determined, the flow field around the body can be obtained by means of numerical calculations (see, for example, reference 4). Because the relation between the shape of the body and the shape of the shock wave is not known a priori, the method of linearized characteristics can be particularly useful for flow determination of this kind. An approximate shape of the shock wave is assumed as the basic solution and the flow field inside the shock is determined; then a linearized flow field is superposed in order to satisfy the boundary conditions at the body. The calculations are simple if the basic flow can be determined analytically or numerically without a large amount of calculation. For example, for slender bodies the basic flow can be the axially symmetric flow for which values are available in tabulated form. Consider a conical shock wave which can be defined in polar coordinates as

$$\psi_s = (\psi_0)_s + \sum_0^n (\psi_n)_s \cos n\theta + \sum_1^m (\psi_m)_s \sin m\theta \quad (60)$$

where all the values of ψ_n and ψ_m are small so that terms of the order of ψ_n^2 can be neglected. Such a shock wave is approximately of circular cross section, as is found for slender conical bodies. If the flow is assumed to have a symmetry plane, the second summation of equation (60) is equal to zero.

The velocity components in the radial direction $(v_r)_1$, in the tangential direction $(v_T)_1$, and in the direction normal to the shock $(v_N)_1$ in front of the shock wave are (see fig. 11)

$$\left. \begin{aligned} (v_r)_1 &= V_1 \cos \psi_s \\ (v_N)_1 &= -V_1 \sin \psi_s \cos \alpha \\ (v_T)_1 &= -V_1 \sin \psi_s \sin \alpha \end{aligned} \right\} \quad (61)$$

where all the velocity components are referred to the limiting velocity and α is the angle of the dihedral between the plane normal to the shock wave and the plane containing the reference axis. Across the shock wave the following relations are valid:

$$\left. \begin{aligned} (v_N)_1 (v_N)_2 &= \frac{\gamma-1}{\gamma+1} [1 - (v_r)_1^2 - (v_T)_1^2] \\ &= \frac{\gamma-1}{\gamma+1} (1 - V_1^2 \cos^2 \psi_s - V_1^2 \sin^2 \psi_s \sin^2 \alpha) \\ (v_N)_2 &= \frac{\gamma-1}{\gamma+1} \frac{(1 - V_1^2 \cos^2 \psi_s - V_1^2 \sin^2 \psi_s \sin^2 \alpha)}{V_1 \sin \psi_s \cos \alpha} \\ (v_r)_1 &= (v_r)_2 \\ (v_T)_1 &= (v_T)_2 \end{aligned} \right\} \quad (62)$$

If the velocity components behind the shock v_r , v_n , and w of the flow field in polar coordinates are considered at each point $\psi_s = \psi_{0s} + \sum \psi_{ns} \cos n\theta$ (fig. 11),

$$(v_r)_{\psi_s} = v_r = V_1 \cos \psi_s \quad (63a)$$

$$(v_n)_{\psi_s} = \frac{\gamma-1}{\gamma+1} \frac{(1-V_1^2 \cos^2 \psi_s - V_1^2 \sin^2 \psi_s \sin^2 \alpha)}{V_1 \sin \psi_s} - \frac{V_1 \sin \psi_s \sin^2 \alpha}{V_1 \sin \psi_s \sin^2 \alpha} \quad (63b)$$

$$(w)_{\psi_s} = -V_1 \sin \psi_s \sin \alpha \cos \alpha +$$

$$\frac{\gamma-1}{\gamma+1} (1-V_1^2 \cos^2 \psi_s - V_1^2 \sin^2 \psi_s \sin^2 \alpha) \frac{\sin \alpha}{V_1 \sin \psi_s \cos \alpha} \quad (63c)$$

but

$$\tan \alpha = \alpha = \frac{d\psi}{\sin \psi d\theta} = \sum \frac{n\psi_n \sin n\theta}{\sin \psi}$$

Therefore, the velocity components behind the conical shock wave of equation (60), if terms of the order of ψ_n^2 are neglected, are

$$(v_r)_{\psi_s} = V_1 \cos(\psi_{0s}) - V_1 \sin(\psi_{0s}) \sum (\psi_n)_s \cos n\theta$$

$$(v_n)_{\psi_s} = -\frac{\gamma-1}{\gamma+1} \frac{1-V_1^2 \cos^2(\psi_{0s})}{V_1 \sin(\psi_{0s})} -$$

$$\frac{\gamma-1}{\gamma+1} \cos(\psi_{0s}) \left(2V_1 - \frac{1-V_1^2 \cos^2(\psi_{0s})}{V_1 \sin^2(\psi_{0s})} \right) \sum (\psi_n)_s \cos n\theta$$

$$(w)_{\psi_s} = \left[V_1 - \frac{\gamma-1}{\gamma+1} \left(\frac{1-V_1^2 \cos^2 \psi_{0s}}{V_1 \sin^2 \psi_{0s}} \right) \right] \sum n(\psi_n)_s \sin n\theta \quad (64)$$

Then, the velocity components behind the shock defined by equation (60) can be expressed as:

$$\left. \begin{aligned} (v_r)_{\psi} &= (v_{r0})_{\psi} + \sum (\psi_n)_s (v_r)_n \cos n\theta \\ (v_n)_{\psi} &= (v_{n0})_{\psi} + \sum (\psi_n)_s (v_n)_n \cos n\theta \\ (w)_{\psi} &= \sum (\psi_n)_s w_n \sin n\theta \end{aligned} \right\} \quad (65)$$

where v_{r0} , v_{n0} , $(v_r)_n$, $(v_n)_n$, and w_n are independent of θ , v_{r0} and v_{n0} correspond to the flow field for circular conical shock ψ_{0s} , and $(v_r)_n$, $(v_n)_n$, and w_n at the circular cone $\psi = \psi_{0s}$ are independent of n and are defined by

$$\left. \begin{aligned} [(v_r)_n]_{\psi_{0s}} &= -V_1 \sin \psi_{0s} - (v_{n0})_{\psi_{0s}} \\ [(v_n)_n]_{\psi_{0s}} &= -\frac{\gamma-1}{\gamma+1} \cos(\psi_{0s}) \left(2V_1 - \frac{1-V_1^2 \cos^2 \psi_{0s}}{V_1 \sin^2 \psi_{0s}} \right) - \left(\frac{\partial v_{n0}}{\partial \psi} \right)_{\psi_{0s}} \\ [(w)_n]_{\psi_{0s}} &= V_1 + \left(\frac{v_{n0}}{\sin \psi_{0s}} \right)_{\psi_{0s}} \end{aligned} \right\} \quad (66)$$

and

$$\left(\frac{\partial v_{n0}}{\partial \psi} \right)_{\psi_{0s}} = \left[-v_{r0} - \frac{v_{r0} + v_{n0} \cot \psi_{0s}}{1 - \frac{v_{n0}^2}{a_0^2}} \right]_{\psi_{0s}}$$

It can be shown that the flow field defined as in equations (65) satisfies the boundary at a surface of a conical body defined by

$$\psi_c = \psi_{0c} + \sum \psi_{nc} \cos n\theta \quad (67)$$

if the terms ψ_{nc} are small and quantities of the order of ψ_{nc}^2 or higher are negligible with respect to terms of the order of ψ_n . At the surface of the body the velocity must be tangent to the surface of the body; therefore, at each point A of the body

$$\left(\frac{v_n}{w} \right)_A = \frac{d\psi_c}{\sin \psi_c d\theta} = \frac{\sum -n\psi_{nc} \sin n\theta}{\sin \psi_c}$$

and, therefore, the boundary conditions can be expressed in the approximation considered as

$$\begin{aligned} (v_n)_{\psi_c} &= (v_{n0})_{\psi_{0c}} + \left(\frac{\partial v_{n0}}{\partial \psi} \right)_{\psi_{0c}} \sum (\psi_n)_c \cos n\theta + \\ &\quad \sum [(v_n)_n]_{\psi_{0c}} (\psi_n)_c \cos n\theta \\ &= -\left(\sum \psi_{ns} (w_n)_{\psi_{0c}} n \sin n\theta \right) \left(\sum \psi_{nc} n \sin n\theta \right) / \sin \psi_c \end{aligned}$$

where the subscript ψ_{0c} indicates quantities at the surface of the basic circular body and ψ_c indicates quantities at the surface of the conical body considered where the parameters $(\psi_n)_s$ are given by equation (60) and define the shape of the shock. Because each term of the right-side summation is of the order of $(\psi_n)^2$, the boundary conditions are

$$\left. \begin{aligned} (v_{n0})_{\psi_{0c}} &= 0 \\ (\psi_n)_s [(v_n)_n]_{\psi_{0c}} &= -\left(\frac{\partial v_{n0}}{\partial \psi} \right)_{\psi_{0c}} (\psi_n)_c \end{aligned} \right\} \quad (68)$$

Equations (68) show that the basic flow defined by the components v_{r0} and v_{n0} is the flow corresponding to a circular cone of angle ψ_{0c} and permits relation of the equation of the conical shock to the equation of the conical body. The coefficients $(v_r)_n$, $(v_n)_n$, and $(w)_n$ for different values of n can be determined for a given free-stream Mach number and value of (ψ_{0c}) or (ψ_{0s}) ; therefore, from equations (60), (65), (67), and (68), the flow field around any conical body of the type given by equation (67) can be obtained when the terms $(\psi_n)_c$ are small.

The determination of the quantities $(v_r)_n$, $(v_n)_n$, and $(w)_n$ as functions of ψ can be obtained from the following equation

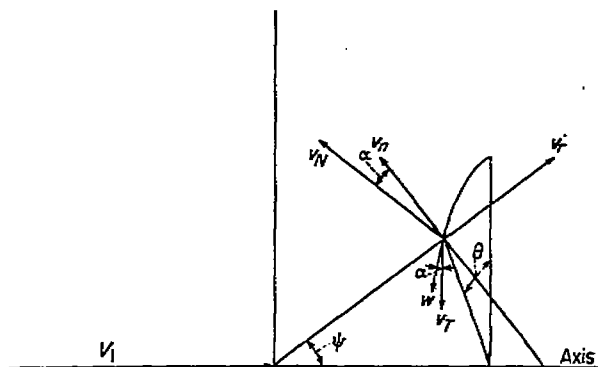

FIGURE 11.—Conical coordinate system.

(see reference 3):

$$v_r \left(2 - \frac{v_n^2 + w^2}{a^2} \right) + v_n \cot \psi + \frac{\partial v_n}{\partial \psi} \left(1 - \frac{v_n^2}{a^2} \right) + \frac{\partial w}{\sin \psi \partial \theta} \left(1 - \frac{w^2}{a^2} \right) - \frac{w v_n}{a^2} \left(\frac{\partial w}{\partial \psi} + \frac{\partial v_n}{\sin \psi \partial \theta} \right) = 0 \quad (69)$$

Equation (69), because of expressions (65), gives

$$\left[(v_r)_n + \frac{\partial (v_n)_n}{\partial \psi} \right] \left(1 - \frac{v_{n0}^2}{a_0^2} \right) = - (v_n)_n \left[\cot \psi + \left(\frac{2v_{n0}}{a_0^2} + \frac{\gamma-1}{a_0^4} v_{n0}^3 \right) \frac{v_{r0} + v_{n0} \cot \psi}{1 - \frac{v_{n0}^2}{a_0^2}} \right] - (v_r)_n \left(1 + \frac{\gamma-1}{a_0^4} \frac{v_{r0} + v_{n0} \cot \psi}{1 - \frac{v_{n0}^2}{a_0^2}} \frac{v_{r0} v_{n0}^2}{v_{r0} v_{n0}^2} \right) - \frac{n^2 w_n}{\sin \psi} \quad (70)$$

Because of the approximation considered, the entropy remains constant in each meridian plane outside of a vorticose layer of infinitesimal thickness around the body (see reference 3). Indeed,

$$\frac{a^2}{\gamma R} \frac{\partial S}{\partial \theta} = v_n \sin \psi \frac{\partial w}{\partial \psi} - v_r \frac{\partial v_r}{\partial \theta} - v_n \frac{\partial v_n}{\partial \theta} + v_r w \sin \psi + v_n w \cos \psi \quad (71)$$

and

$$v_n \sin \psi \frac{\partial S}{\partial \psi} = -w \frac{\partial S}{\partial \theta} \quad (72)$$

From equation (71) there results $\frac{\partial S}{\partial \theta}$ of the order of $(\psi_n)_n$; therefore, where $v_n \neq 0$, $\frac{\partial S}{\partial \psi}$ is of the order of ψ_n^2 and can be neglected. Then

$$\frac{a^2}{\gamma R} \frac{\partial S}{\partial \psi} = 0 = -v_r \frac{\partial v_r}{\partial \psi} - w \frac{\partial w}{\partial \psi} + \frac{w}{\sin \psi} \frac{\partial v_n}{\partial \theta} + v_r v_n - w^2 \cot \psi \quad (73)$$

or, in the approximation considered,

$$v_n = \frac{\partial v_r}{\partial \psi} \quad (74)$$

Then $v_r + \frac{\partial v_n}{\partial \psi}$ is the radius of the hodograph diagram in the plane $\theta = \text{Constant}$ (see reference 4) and $(v_n)_n$ and $(v_r)_n$ can be obtained from a step-by-step calculation from $\psi = \psi_{0s}$ to $\psi = \psi_{0c}$ by means of the equations

$$\left. \begin{aligned} [(v_n)_n]_{\psi-\Delta\psi} &= [(v_n)_n]_{\psi} \cos(-\Delta\psi) + [R_n - (v_r)_n]_{\psi} \sin(-\Delta\psi) \\ [(v_r)_n]_{\psi-\Delta\psi} &= [(v_r)_n]_{\psi} \sin(-\Delta\psi) - [R_n - (v_r)_n]_{\psi} \cos(-\Delta\psi) + (R_n)_{\psi} \end{aligned} \right\} \quad (75)$$

where R_n at station ψ is obtained from equation (70) and

$$[(R)_n]_{\psi} = \left[(v_r)_n + \frac{\partial (v_n)_n}{\partial \psi} \right]_{\psi} \quad (76)$$

can be calculated from the values of $(v_r)_n$, $(v_n)_n$, and $(w)_n$ at ψ .

The value of $[(w)_n]_{\psi-\Delta\psi}$ can be obtained from

$$[(w)_n]_{\psi-\Delta\psi} = [(w)_n]_{\psi} - \left(\frac{\partial w_n}{\partial \psi} \right)_{\psi} \Delta\psi \quad (77)$$

and $\left(\frac{\partial w_n}{\partial \psi} \right)_{\psi}$ can be obtained from equation (71) where

$$S = S_0 + S_1 \sum \psi_n \cos n\theta \quad (78)$$

and S_1 is independent of ψ and can be determined from the equations of the shock from the expression

$$S_1 = \left(\frac{dS}{d\psi_s} \right)_{\psi_{0s}}$$

where ψ_s is the inclination of the shock. Then

$$-\frac{a_0^2}{\gamma R} S_1 = v_{n0} \sin \psi \frac{\partial w_n}{\partial \psi} + v_{r0} (v_r)_n + v_{n0} (v_n)_n + v_{r0} w_n \sin \psi + v_{n0} w_n \cos \psi \quad (79)$$

while, if the quantity S_1 is neglected and the flow is considered potential flow,

$$w_n = -\frac{(v_r)_n}{\sin \psi} \quad (80)$$

The method presented has been applied to the determination, for the condition of zero angle of attack, of the flow field around a cone having an elliptical cross section with axes in the ratio of about 1 to 3, for which experimental data were available at $M=1.8$, and for a cone of elliptical cross section of ratio 1 to 1.88. The calculations have been performed in the following way: The bodies are shown in figures 12 (a) and 12 (b). The value of ψ at $\theta=0^\circ$ is equal to 6.3° , while the value of ψ at $\theta=90^\circ$ is equal to 18.4° .

The angle ψ can be expressed as

$$\psi_c = \psi_{0c} + \psi_{1c} \cos 2\theta + \psi_{2c} \cos 4\theta + \psi_{3c} \cos 6\theta + \psi_{4c} \cos 8\theta + \psi_{5c} \cos 10\theta \quad (81)$$

but

$$\tan \psi_c = \tan \psi_{0c} + \frac{\sum \tan \psi_{nc}}{\cos^2 \psi_{0c}}$$

therefore, by determining the value of ψ at six points, the

following values have been obtained: If $\psi_{0c} = 10^\circ$,

$$\psi_{1c} = -5.07^\circ$$

$$\psi_{2c} = 1.94^\circ$$

$$\psi_{3c} = -0.84^\circ$$

$$\psi_{4c} = 0.43^\circ$$

$$\psi_{5c} = -0.16^\circ$$

Therefore, a 10° cone at zero angle of attack is assumed as the basic body. Reference 5 gives tabulated values for a 10° cone at $M_1 = 1.816$ and the calculations have been performed at this Mach number. The table gives

$$\psi_{0s} = 34.45^\circ$$

The entropy variations S_1 are small and are neglected. Then,

$$(v_r)_{ns} = -0.0145$$

$$(w)_{ns} = 0.0255$$

$$(c_n)_{ns} = 1.285$$

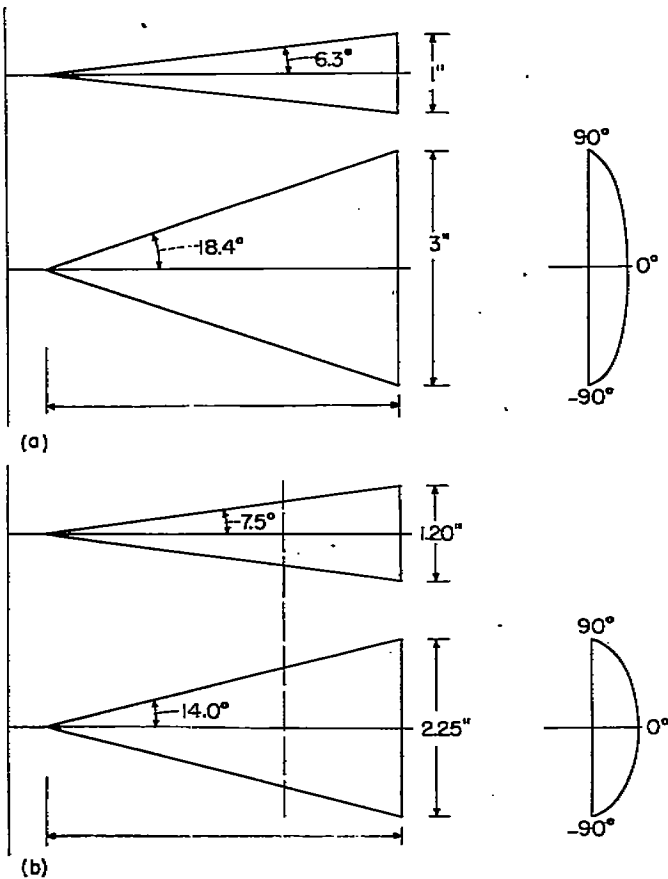

(a) Elliptical cone with axis ratio of 1 to 3.
 (b) Elliptical cone with axis ratio of 1 to 1.88.
 FIGURE 12.—The elliptical cones analyzed.

The values of $(v_r)_n$, $(v_n)_n$, and $(w)_n$ between ψ_{0s} and ψ_{0c} have been determined by means of equations (70), (75), and (80). Then ψ_{1s} , ψ_{2s} , and ψ_{3s} have been determined from equations (68) where

$$\left(\frac{\partial v_{n0}}{\partial \psi}\right)_{\psi_{0c}} = -2(v_r)_{n0} = -2 \times 0.6000$$

The values of ψ_s obtained are

$$\psi_{1s} = -0.24^\circ$$

$$\psi_{2s} = 5.1^\circ \times 10^{-3}$$

$$\psi_{3s} = -1.7^\circ \times 10^{-4}$$

$$\psi_{4s} = 7.4^\circ \times 10^{-6}$$

$$\psi_{5s} = -3^\circ \times 10^{-7}$$

As is shown from the analysis of the values of ψ_s and ψ_c , the shock is very close to a circular shock wave even for large departure of the body from the circular cross section, and the effect of the terms corresponding to $n=6, 8,$ and 10 is very small. The velocity components at the surface of the body are obtained from equations (65) at $\psi = \psi_0$ and the pressure distribution presented in figure 13 is obtained. In the same figure, the pressure distributions obtained by using the same calculated values of $(v_r)_n$, $(v_n)_n$, and $(w)_n$ for $M=1.81$ around an elliptical cone with a cross section having axes in the ratio of 1 to 1.88 are also shown. The conical body having an ellipse of axis ratio 1 to 3 has the same cross-sectional area as a circular cone of $\psi_0 = 11^\circ$. Its pressure drag obtained from this calculation is $C_D = 0.099$ in comparison with 0.12 for the circular cone. The conical body having as cross section an ellipse with axes in the ratio of 1 to 1.88 has a drag coefficient of 0.103, while the equivalent circular cone of $\psi_0 = 10^\circ 30'$ has $C_D = 0.115$. Therefore, those calculations indicate that conical bodies of circular cross section have larger drag than cones of elliptical cross section.

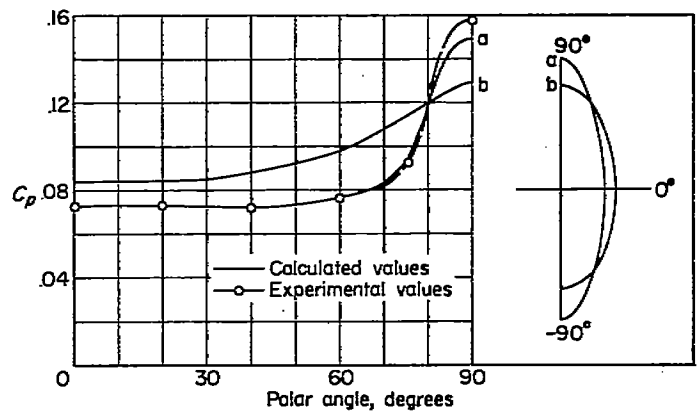

FIGURE 13.—Pressure distribution around the conical bodies at $M=1.81$.

The results obtained agree well with the experimental results, also, if the body shape chosen requires large values for the angle $(\psi_n)_c$. With the same flow fields $(v_r)_n$, $(v_n)_n$, and $(w)_n$, any other conical shape having two planes of symmetry represented by equation (81) when ψ_0 is 10° can be obtained at $M=1.816$. If the flow has only one plane of symmetry, only the terms in $\cos \theta$, $\cos 3\theta$, and so forth, must be considered; whereas, if no symmetry exists, terms in $\sin n\theta$ and $\cos n\theta$ must be considered.

The flow fields defined by $(v_r)_n$, $(v_n)_n$, and $(w)_n$ can be obtained and given in tabulated form without a large amount of numerical work as for circular cones, and, therefore, the determination of conical bodies can be performed without difficulty in a very short time.

When the shock shape is somewhat different from a cone having circular cross section, the basic flow field must be different from the axially symmetric. However, if the basic conical-flow components are expressed in the form

$$v_r = v_{r_c} + v_{r_b} f(\theta)$$

$$v_n = v_{n_c} + v_{n_b} f(\theta)$$

$$w = w_b f'(\theta)$$

the basic flow can still be obtained by solving numerically the equations of motion in two meridian planes, and, therefore, the basic flow can be determined exactly. For conical flow the linearized method can, then, have wide application to any form of boundary conditions.

FLOW FIELDS AROUND SLENDER BODIES WITHOUT SYMMETRY

When the conical flow is determined, the method of characteristics can be applied to the determination of slender bodies. The equations used are similar to the equations for circular bodies at angles of attack and can be directly derived from those equations (reference 2).

Few values of n are required for the determination of the flow field, and one set of calculations can be used for several bodies having the same basic body; therefore, the method can be of interest for practical applications.

QUASI-TWO-DIMENSIONAL FLOW FIELDS

In many general three-dimensional flow fields of practical interest the flow is not too different from a two-dimensional flow, and, therefore, the velocity field and entropy field can be expressed as in equations (1) and (2) with good practical approximation. Flow fields of this kind are found, for example, in wings having plan forms which can be considered close to the two-dimensional type with some twist or a variation of thickness distribution along the span. Flow fields of this kind can be considered also in some problems in which interference between a wing and a two-dimensional tail (downwash effects) or between a two-dimensional wing and a body is considered. In all these problems of practical interest for the airplane design, the component w in the direction of the span of the wing can be considered small; therefore, equations (1) can be used and the components u_1 and v_1 depending on the three-dimensional effect can also be considered small.

Equation (17) expressed along the characteristic line of the first family $\lambda_1 = \tan(\beta_0 + \varphi_0)$ in the plane $z = \text{Constant}$ is

$$\frac{1}{V_0} \frac{dV_1}{dx} \tan \beta_0 + \frac{d\varphi_1}{dx} + \frac{\sin^2 \beta_0}{\gamma R} \frac{dS_1}{dx} + \varphi_1 B_1 + \frac{V_1}{V_0} C_1 = \frac{dw_1}{dz} \frac{1}{V_0} \frac{\tan \beta_0 \sin \beta_0}{\cos(\varphi_0 + \beta_0)} \tag{82}$$

while along the second characteristic line $\lambda_2 = \tan(\varphi_0 - \beta_0)$ the following equation is valid:

$$\frac{1}{V_0} \frac{dV_1}{dx} + \tan \beta_0 \frac{d\varphi_1}{dx} + \frac{\sin^2 \beta_0}{\gamma R} \frac{dS_1}{dx} - \varphi_1 B_2 + \frac{V_1}{V_0} C_2 = \frac{dw_1}{dz} \frac{1}{V_0} \frac{\tan \beta_0 \sin \beta_0}{\cos(\varphi_0 - \beta_0)} \tag{83}$$

where B_1 , B_2 , C_1 , and C_2 are defined by equations (20). Along each streamline s_0 ,

$$\frac{dw_1}{ds_0} = \frac{\partial V_1}{\partial z} + \frac{\partial S_1}{\partial z} \frac{a_0^2}{\gamma R V_0} \tag{84}$$

Equations (82), (83), and (84) permit the determination of the flow field by relatively simple procedures.

Consider, for example, a wing having twist, variable profile distribution, and variable chord, as shown in figure 14. The wing can be analyzed by means of the linearized characteristics method in the following way: First, the root and tip profiles are considered. Section a and section b have different relative thicknesses and chords.

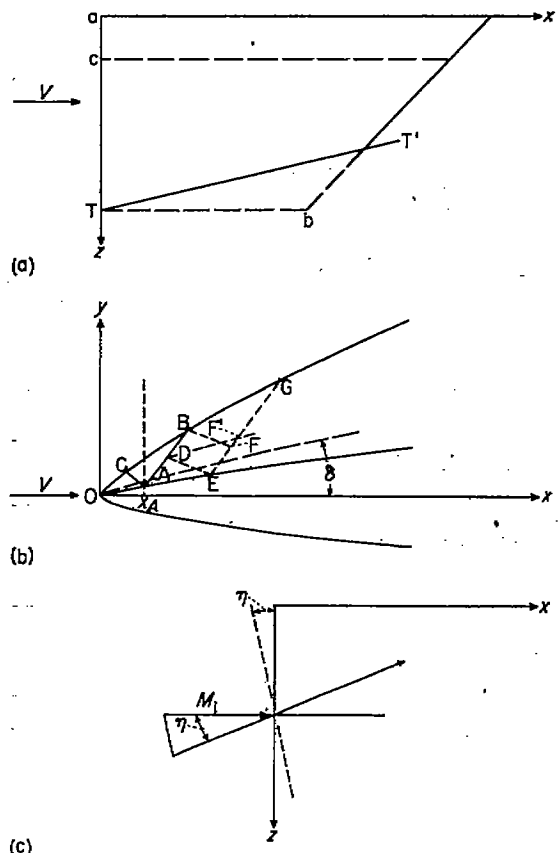

(a) Wing plan form.
 (b) Wing cross section at a plane $z = \text{Constant}$.
 (c) Shock-wave calculation at the leading edge.

FIGURE 14.—Determination of the flow around a three-dimensional supersonic wing

If the variation from a to b is linear, the properties of a two-dimensional cross section at any station c can be obtained by means of linear interpolation between the corresponding values at a and b.

The profiles a and b are analyzed by means of two-dimensional-flow theory and the characteristic net, and the values of the coefficients B_1 , B_2 , C_1 , and C_2 are determined from two-dimensional considerations. If entropy effects are neglected or incorporated in the linearized flow, the coefficients B_1 , B_2 , C_1 , and C_2 can be determined as for the case of two-dimensional potential flow at each point of the axis (equations (29), (30), and (34)) and are constant along characteristic lines of the first family. Then the linearized flow is defined as the flow that considers the three-dimensional effects and the entropy distribution. Therefore,

$$\left. \begin{aligned} u &= u_0(x, y, z) + au_1(x, y, z) \\ v &= v_0(x, y, z) + av_1(x, y, z) \\ w &= aw_1(x, y, z) \end{aligned} \right\} \quad (85)$$

where u_0 and v_0 are the potential-flow solutions in the plane $z = \text{Constant}$ and satisfy the boundary conditions in the plane $z = \text{Constant}$, u_1 and v_1 are the components due to the presence of w_1 (and of the variation of entropy), and a can be a coefficient, for example, proportional to the twist distribution or to the thickness variation. Because u_0 and v_0 are functions of x , y , and z , while for the basic flow they have been determined from two-dimensional considerations, $\frac{\partial u_0}{\partial z}$

and $\frac{\partial v_0}{\partial z}$ are not zero; therefore, equation (22) becomes

$$\frac{\partial w}{\partial s_0} = \frac{\partial w}{\partial x} \frac{u}{V} + \frac{\partial w}{\partial y} \frac{v}{V} - \frac{u}{V} \eta + \frac{v}{V} \xi + \frac{\partial V}{\partial z}$$

or

$$\frac{\partial w_1}{\partial s_0} = \frac{\partial V_0}{\partial z} + \frac{\partial V_1}{\partial z} + \left(\frac{\partial S_0}{\partial z} + \frac{\partial S_1}{\partial z} \right) \frac{a_0^2}{\gamma R V_0} \quad (86)$$

where $\frac{\partial V_0}{\partial z}$ is the variation of the velocity component for the basic flow.

When w_1 is considered small, in all the flow field the terms $\frac{2uw}{a_2} \frac{\partial u}{\partial z}$ and $\frac{2vw}{a_2} \frac{\partial v}{\partial z}$ can still be neglected in the differential equations along the characteristic lines, and, therefore, equations (82) and (83) are still valid.

At each plane $z = \text{Constant}$, the characteristic net is known; therefore, the intersections of the shock wave for the total flow with a plane $y = \text{Constant}$ can be determined from characteristic calculations. If O is a point at the leading edge of the wing (fig. 14 (b)), the shock wave at O can be obtained from shock-wave considerations and from the boundary conditions because δ at O is known, and at O the shock is two-dimensional. Therefore, the velocity components u_1 and v_1

at O are zero, while $\frac{\partial w}{\partial s_0}$ is given by equation (86). If the plane $x = x_A$ is assumed to be close to the plane $x = x_0$, the characteristic lines BA and CA can be drawn in any meridian plane considered for the basic flow.

At the point O, V_1 is zero and, in the neighborhood of O along the shock L, the velocity can be expressed as

$$(V_1)_L = \frac{\partial V_1}{\partial L} \Delta L \quad (87)$$

Now, along the shock wave the direction of the velocity behind the shock is related to the intensity from the equations of the shock wave; therefore, the direction $\varphi_1 = \frac{\partial \varphi_1}{\partial L}$ along the shock and the shape of the shock as a function of $\frac{\partial V_1}{\partial L}$ are determined when $\frac{\partial V_1}{\partial L}$ along the shock is known.

If the velocity V_1 at a point A of the body is

$$(V_1)_A = \frac{\partial V_1}{\partial s} \Delta s \quad (88)$$

then the velocity at C and B can be determined as a function of $\frac{\partial V_1}{\partial s}$ from equations (82) and (83), because the value of w_1 at A is given from equation 86 and is known, and the value of $\frac{\partial w}{\partial z}$ can be obtained from the value of w_1 at A in several planes $z = \text{Constant}$.

If in equations (82) and (83) the values of V_1 , S_1 , and φ_1 at B and C are expressed by means of equation (87) and of the equations of the shock waves which give the coefficients of the expressions

$$\frac{\partial V_1}{\partial x} = \frac{\partial V_1}{\partial L} \frac{dL}{dx}$$

$$\frac{\partial \varphi_1}{\partial x} = \frac{\partial \varphi_1}{\partial V_1} \frac{\partial V_1}{\partial x}$$

$$\frac{\partial S_1}{\partial x} = \frac{\partial S_1}{\partial V_1} \frac{\partial V_1}{\partial x}$$

then equations (82) and (83) give two relations between $\frac{\partial V_1}{\partial s}$ and $\frac{\partial V_1}{\partial L}$, and, therefore, $\frac{\partial V_1}{\partial s}$ and $\frac{\partial V_1}{\partial L}$ can be determined.

The equation of the shock wave can relate u as a function of v , or V_1 as a function of φ_1 without the necessity of the component w , because the component w is proportional to the inclination η of the tangent to the shock with the plane $x = \text{Constant}$, and V_1 and φ_1 are functions of $M_1 \cos \eta$, but $M_1 \cos \eta = M \left(1 - \frac{\eta^2}{2} \right) = M_1$ in the approximation considered here (fig. 14 (c)). The components u and v at B and the position of B having been determined, in each meridian plane $z = \text{Constant}$, the intersection of the shock in the plane $y = \text{Constant}$ is obtained and w at B is determined. Then a point D is interpolated in each meridian plane and the point E is obtained. Then point F is determined. In order to obtain $(w)_F$, the streamline DF' for the basic flow must be drawn and $\left(\frac{\partial V_0}{\partial z} \right)_0$ interpolated between F' and E.

In a similar way, all the flow field can be obtained. The line TT' defining the plan form in figure 14 (a) must be outside of the Mach conoid from T. Because few points along each profile are required, the largest amount of work for such a calculation is represented by the construction of a basic

characteristic net which permits obtaining points which simplify the determination of w . By changing the value of the coefficient a , different thickness distributions or different twists can be considered. The new distributions must be obtained by changing proportionately the variation of thickness or twist with respect to the basic wing and by varying in proportion the value of a .

CONCLUDING REMARKS

The method of characteristics for supersonic flow has been simplified by assuming that one of the velocity components or the effect on the velocity components due to variation of one physical parameter is small, so that the square of the velocity components considered small can be neglected. By means of this simplification, the flow field can be represented as the superposition on a basic flow field (which is not linear and must be determined by the method of characteristics) of linearized flow fields which are defined by a differential equation with variable, but known, coefficients.

The calculations of these linearized flow fields can be performed along the characteristic net of the basic flow field. The method has been applied (a) to the two-dimensional flow with entropy gradient, which has been transformed to a basic potential flow on which a linearized flow due to the entropy gradient is superposed, (b) to axially symmetric problems where conical or cylindrical flows are considered as the basic flow, (c) to the determination of the flow field around cones or slender bodies without axial symmetry, and (d) to particular three-dimensional flows which can be simulated as a basic two-dimensional flow on which three-dimensional linearized flows are superposed. Application (b) permits obtaining in a simple way the flow field around bodies of revolution without using linearized theory and indicates the

possibility of using tabulated values for such determinations. Application (c) permits the determination of flow fields not yet determined by the method of characteristics. Any such conical flows can be determined by using tabulated values that can be obtained as for cones of circular cross section at small angles of attack. The application in (d) can be of interest for wings of approximately two-dimensional form having twist or thickness variation along the span and for interference problems.

LANGLEY AERONAUTICAL LABORATORY,
NATIONAL ADVISORY COMMITTEE FOR AERONAUTICS,
LANGLEY FIELD, VA., July 24, 1951.

REFERENCES

1. Sauer, Robert: Supersonic Flow About Projectile Heads of Arbitrary Shape at Small Incidence. R.T.P. Translation No. 1573, British Ministry of Aircraft Production. (From Luftfahrtforschung, vol. 19, no. 4, May 1942, pp. 148-152.)
2. Ferri, Antonio: The Method of Characteristics for the Determination of Supersonic Flow Over Bodies of Revolution at Small Angles of Attack. NACA Rep. 1044, 1951. (Supersedes NACA TN 1809).
3. Ferri, Antonio: Supersonic Flow Around Circular Cones at Angles of Attack. NACA Rep. 1045, 1951. (Supersedes NACA TN 2236.)
4. Ferri, Antonio: Elements of Aerodynamics of Supersonic Flows. The Macmillan Co., 1949.
5. Staff of the Computing Section, Center of Analysis (Under Direction of Zdenek Kopal): Tables of Supersonic Flow Around Cones. Tech. Rep. No. 1, M. I. T., 1947.
6. Busemann, A.: Conical Supersonic Flow With Axial Symmetry. R.T.P. Translation No. 1593, British Ministry of Aircraft Production. (From Luftfahrtforschung, vol. 19, no. 4, June 5, 1942, pp. 137-144.)