

REPORT 1133

CONTENTS

	Page
SUMMARY.....	547
INTRODUCTION.....	547
METHOD OF CONDUCTING STUDY.....	548
MECHANISM OF CRASH FIRE.....	549
FUEL IGNITION.....	549
IGNITION SOURCES.....	551
Hot Surfaces and Friction and Chemical Sparks.....	551
Exhaust Flames.....	553
Engine Induction-System Flames.....	553
Electric Arcs and Electrically Heated Wiring and Filaments.....	553
Flames from Chemical Agents.....	554
Electrostatic Sparks.....	557
FUEL SPILLAGE.....	557
Fuel Mist.....	557
Time duration of mist ignition hazard.....	557
Dispersion and ignition of fuel mists.....	558
Significance of fuel volatility in crashes involving fuel-mist ignition.....	561
Ground studies of flame propagation through fuel mist.....	562
Liquid-Fuel Spillage.....	565
External fuel spillage.....	565
Internal fuel spillage.....	567
Wetting conduction.....	568
Nacelle fuel spillage.....	571
Fuel-Vapor Spillage.....	571
CRASH-FIRE EXPERIMENTS WITH MODIFIED AIRCRAFT.....	572
Ignition-Source Inerting.....	572
Ground Loop.....	583
High-Contact-Angle Crash.....	583
FIRE DEVELOPMENT.....	584
CONCLUDING REMARKS.....	592
REFERENCES.....	595
TABLES.....	595
SYNOPSIS.....	596

REPORT 1133

MECHANISM OF START AND DEVELOPMENT OF AIRCRAFT CRASH FIRES¹

By I. IRVING PINKEL, G. MERRITT PRESTON, and GERARD J. PESMAN

SUMMARY

Full-scale aircraft crashes, devised to give large fuel spillage and a high incidence of fire, were made to investigate the mechanism of the start and development of aircraft crash fires. The results are discussed herein. This investigation revealed the characteristics of the ignition sources, the manner in which the combustibles spread, the mechanism of the union of the combustibles and ignition sources, and the pertinent factors governing the development of a crash fire as observed in this program.

INTRODUCTION

Recent aeromedical research has shown that the magnitude of deceleration human beings can withstand without serious injuries varies inversely with the time for which the deceleration is applied. The fact that in many airplane crashes high decelerations often exist for only extremely short periods of time indicates that worthwhile gains in crash survival might be realized if the fire that often accompanies crash were avoided. Acting on the recommendation of the NACA Committee on Operating Problems and the Subcommittee on Aircraft Fire Prevention, the NACA Lewis laboratory has engaged in a study of the airplane crash-fire problem. This

study of the manner in which crash fires start and develop is intended to serve as factual background on which features of airplane design can be based in order to reduce the likelihood of fire following crash and to improve the chances for escape or rescue should fire occur. Although this study will ultimately include aircraft powered with various types of turbine engines as well as reciprocating engines, this report considers only the work completed on aircraft with reciprocating engines. While the initiation of crash fires and the subsequent development of these fires are related events, the factors of interest in each of these events are quite different, and they are therefore treated separately in this report.

The current crash-fire research program is one of several studies made in the last 30 years. In general, the results of earlier work have been verified in this more comprehensive investigation. Of particular interest is the full-scale crash-fire study made from 1924-28 by the U. S. Army Air Corps, in which single-engine fighter aircraft powered by Hispano Swiza engines were employed. Notable contributions to the field of aircraft fires have been made by W. G. Glendinning and his associates in England.

The program on crash fire considered herein was conducted with modern aircraft and instrumentation on a scale sufficient to permit an appreciation of important factors not possible heretofore.

The current crash-fire study began in 1949 with a review of past crash accidents, civil and military. The investigation of crash-fire accident records (ref. 1), however, failed to reveal well-defined mechanisms for crash fire, primarily because the pertinent physical factors acting to initiate the fire are often concealed from view or are too short-lived to be reported accurately by eyewitnesses. Fire damage also obscured the true nature of the disruption suffered by the airplane that relates to the fuel spillage and generation of ignition sources. The need for conducting full-scale crashes under conditions permitting careful observation of the successive events in the crash was apparent from this accident study. Acquisition of service-wear twin-engine cargo aircraft from the U. S. Air Force for full-scale crash research made possible the analysis of the mechanism of crash fire discussed herein. Photographs of the low-wing C-46 and the high-wing C-82 airplanes used are shown in figures 1 and 2, respectively. A few of the features of each airplane, to which later reference will be made, are indicated in the figures. Of the 17 full-scale crashes conducted so far in

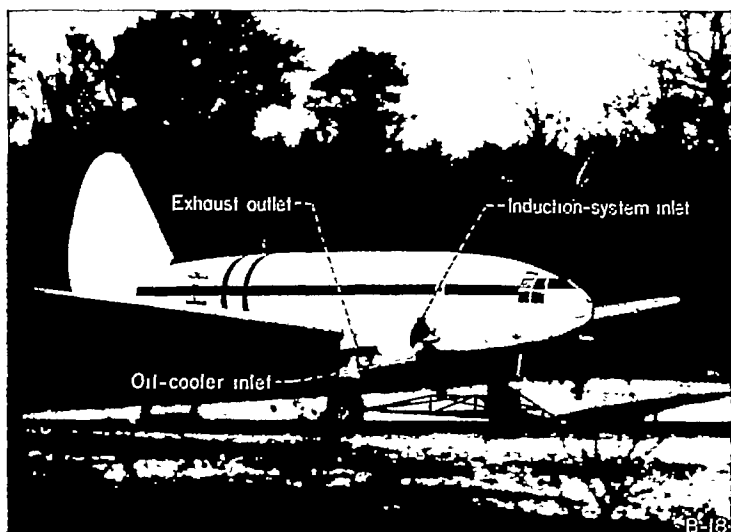

FIGURE 1.—C-46 airplane used in aircraft crash-fire program.

¹ Supersedes NACA RM E52F06, "Mechanism of Start and Development of Aircraft Crash Fires" by I. Irving Pinkel, G. Merritt Preston, and Gerard J. Pesman.

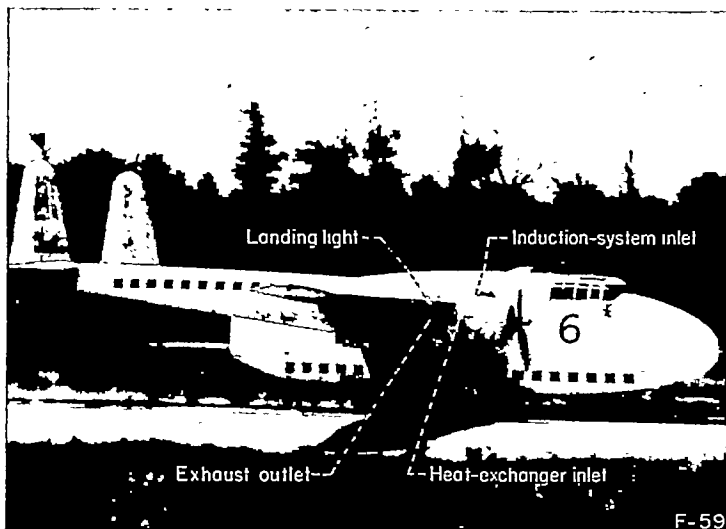

FIGURE 2.—C-82 airplane used in aircraft crash-fire program.

this program, four were C-46 airplanes and 13 were C-82 airplanes.

Since it is desirable to study the mechanism of crash fires under circumstances that approximate real crash conditions, a barrier was designed to impose the gross damage to the airplane similar to that which may occur in unsuccessful take-offs and landings, in which severe engine damage and major fuel spillage occurs. Airplane crashes at flight speed into obstructions such as buildings and mountainsides usually involve a degree of airplane disintegration so severe that design measures or equipment arranged to reduce the likelihood of fire are rendered impotent. For this reason, attention in this study is focused on crashes that occur at take-off and landing speeds, where the likelihood of personnel survival of the impact is high and design safety features and crash-fire protection equipment that may be employed have a reasonable chance to serve their function.

The results of the current work are limited to those features of airplane crash fires that have been investigated in this program. While an attempt has been made to include in this study as many factors involved in crash fires as are revealed by past experience and current results, undoubtedly there remain areas that are not covered in this work.

A synopsis of this report is included at the end for those who are not interested in a detailed discussion of the subject material.

METHOD OF CONDUCTING STUDY

A complete discussion of the crash technique employed in these studies is given in reference 2. It is useful, however, to repeat some of the salient features of this technique. A crash site, shown schematically in figure 3, was arranged to permit the airplane to accelerate from rest under its own power and, constrained by a single guide rail, to arrive at a crash barrier at approximately take-off speed (80 to 105 mph). The crash barrier is shown in figure 4 (a), and

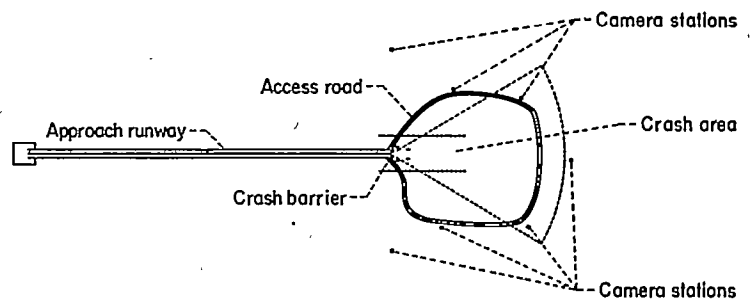

FIGURE 3.—Schematic drawing of test site for aircraft crash-fire program.

schematic views of the airplane as it passes through the barrier are shown in figures 4 (b) to (d). (The height of the abutment was adjusted to permit approximately 18 in. of the propeller tip to hit the barrier (fig. 4 (b)).) The disrupted engine and nacelle installations resulting from the propeller impact with the barrier generate a variety of ignition sources and fuel spillages, characteristic of this type airplane accident. Because the chances of obtaining a fire are higher when the damaged engine and its associated ignition sources stay with the airplane carrying the fuel than when the engine is dropped at the crash barrier, an attempt was made to restrict the barrier height to provide extensive engine damage short of engine break-out. The abutments in the path of the two main landing wheels rip out the landing gear (fig. 4 (c)). As the airplane moves through the barrier, the leading edges of the wings are cut by inclined poles (fig. 4 (d)) fitted with steel pins installed in comb-tooth fashion, which slice open the wing fuel tanks on both sides of the airplane. The airplane then slides to rest on the ground beyond the barrier. By these crash-barrier arrangements, it was hoped to impose damage sufficiently diverse so that a large percentage of actual crashes could be considered to be made up of all or several of these damaged components variously combined. By careful instrumentation of the crash airplane and camera coverage of the crash site with standard and greater-than-normal speed cameras, an appreciation was obtained of the way a variety of factors act to initiate a fire.

Instrumentation and data-recording equipment were carried on the airplane to obtain the following information at appropriate times during the crash and ensuing fire:

- (1) Fire location throughout nacelles, wings, and fuselage
- (2) Personnel compartment temperatures, ambient and radiant
- (3) Distribution of combustible mixtures in wings and nacelles
- (4) Timing and location of electrical short circuits
- (5) Timing of fuel-line ruptures
- (6) Acceleration of separate components of airplane in crash

These data were converted to electric signals that could be read on panel-located meters and indicating lights carried in a fireproof box in the airplane. The signals were photo-

graphed 10 times per second through the crash impact and ensuing fire.

All airplanes carried a total of approximately 1050 gallons of fuel in the outboard wing tanks equally distributed between the wings. In almost every crash, the fuel temperature was between 70° and 80° F. Fuel preheating was employed when required by the weather. Gasoline and low-volatility fuel (8 mm Hg Reid vapor pressure) were employed. Unless otherwise stated, the fuel employed in a given instance was aviation-grade gasoline. Inspection data of the two fuels are shown in table I. In some cases the fuel was dyed red for photographic purposes. In these cases a notation has been made on the figure.

In order to appreciate fully the significance of some of the factors in the mechanism of crash fires observed in the full-scale crash studies, a parallel set of ground studies was conducted. These ground studies helped to define the circumstances under which a particular factor or combination of factors could initiate a fire and indicated how these factors were influenced by variables such as wind, fuel volatility, state of motion of the airplane, and arrangement of the airplane components in their normal and crash configurations.

MECHANISM OF CRASH FIRE

A consideration of the results obtained in the first few airplane crashes conducted in this program showed that a detailed approach to the problem is required if erroneous and contradictory impressions are to be avoided. Factors that were believed to be of secondary importance or that were ignored entirely in a superficial approach were revealed by this study to control the methods by which fire occurs.

Inquiry into the manner in which the crash fire occurs centers on the answers to two principal questions: How and when do ignition sources appear in the airplane crash, and How does the fuel come into contact with the ignition sources? A proper consideration of the mechanism of crash fire thus requires that the subjects of ignition sources and fuel spillage be treated concurrently. In the organization of this discussion, however, it is useful first to consider briefly the factors controlling fuel ignition and the origin of ignition sources and then to consider them again concurrently with a discussion of the fuel spillage. A series of crash experiments with aircraft modified to reveal effects not readily apparent with the aircraft in their normal configuration is discussed separately for purposes of clarity.

FUEL IGNITION

In general, the range of the variables influencing fuel ignition in an airplane crash is within the range of existing combustion experience, and this information is of significance in crash fires. The scientific literature contains several summaries of the factors controlling hydrocarbon fuel ignition. Reference 3 is an example of a recent report on the subject. Unfortunately, the space in which combustible

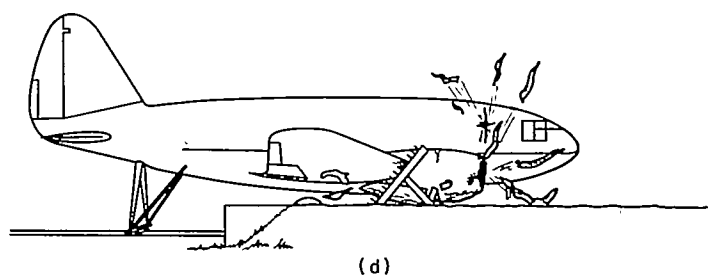
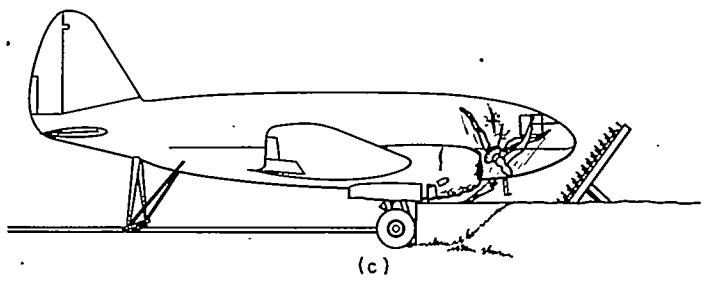
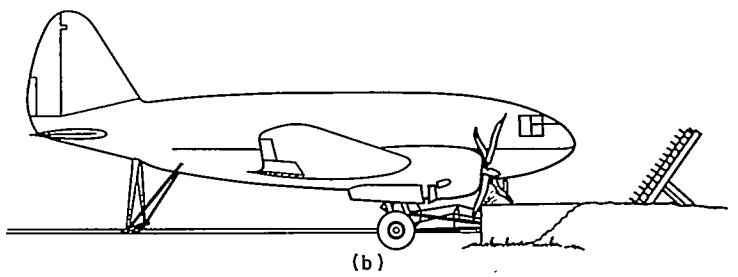
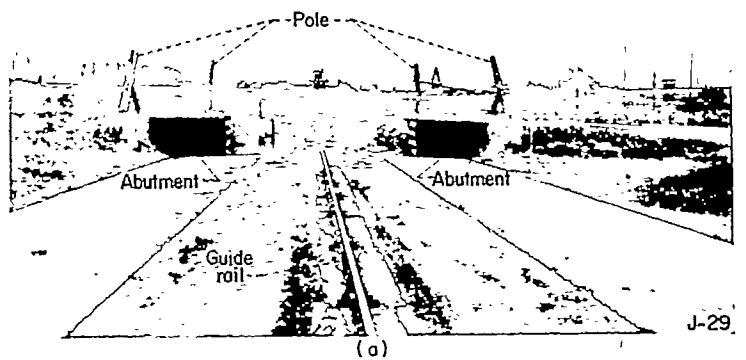

- (a) Approach runway and crash barrier.
- (b) Impact of propeller with abutment.
- (c) Impact of landing gear with abutment.
- (d) Impact of wing with pole barrier.

FIGURE 4.—Crash barrier and successive views of airplane as it passes through barrier.

mixtures are formed and the ignition sources appear in a crash is too large for a measurement of the factors influencing fuel ignition to be taken during the crash. The range of values of many of these factors is fixed, however, by the fact that the crash fire occurs at ground level, usually below 10,000 feet. This fact defines the range of air pressure, temperature, and velocity that exists in a crash. In view of

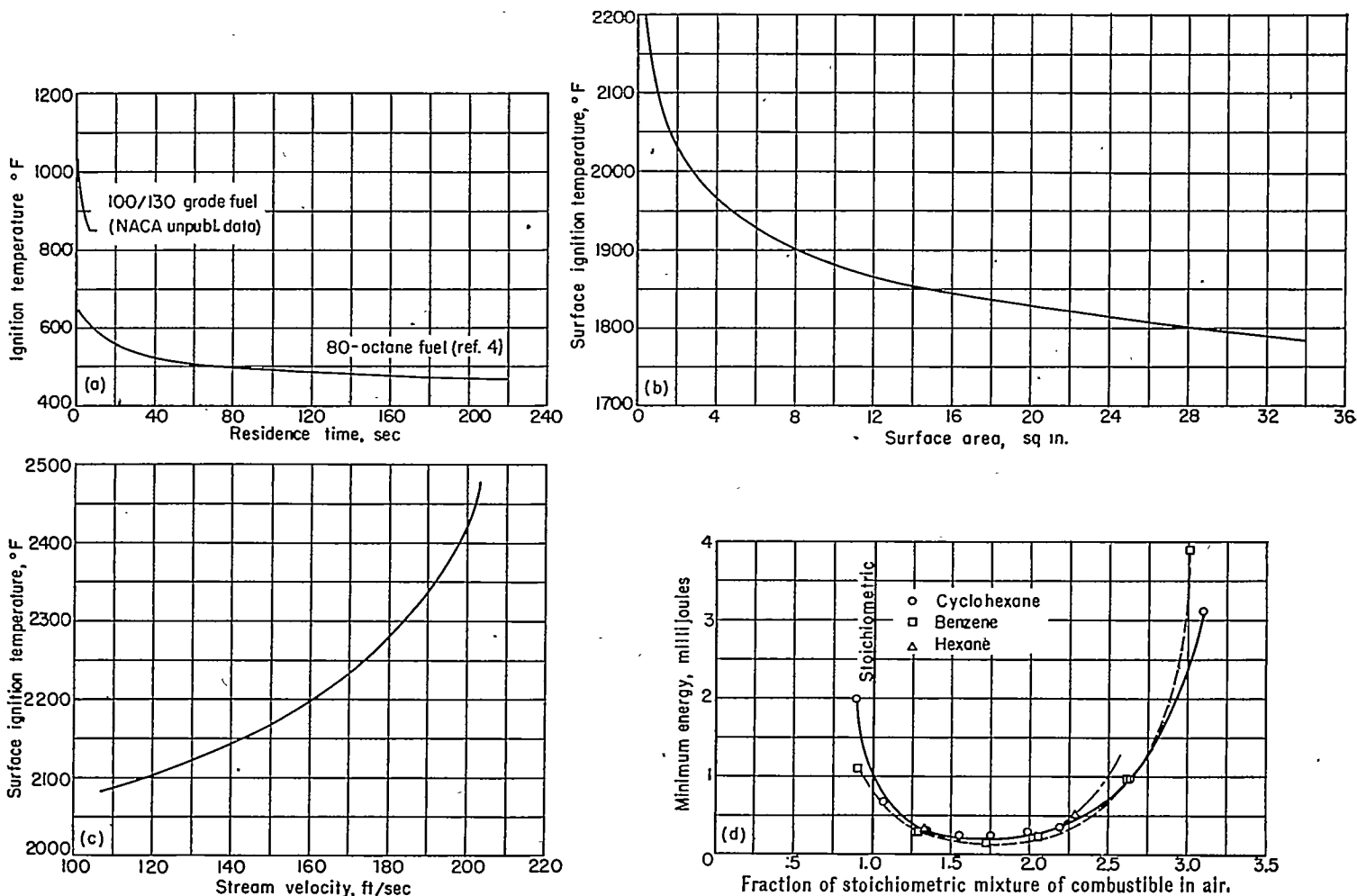

- (a) Effect of residence time on ignition temperature of aviation gasoline.
- (b) Effect of surface area on surface ignition temperature of 7 percent quiescent mixture of natural gas and air. Ignition surface, nickel. (Data from ref. 3.)
- (c) Variation of surface ignition with gas-stream velocity for a stoichiometric mixture of pentane and air at atmospheric pressure and temperature of 155° F. Ignition by ¼-inch heated stainless-steel rods. (Data from ref. 3.)
- (d) Variation of minimum ignition energy of combustible-air mixtures with fraction stoichiometric mixture.

FIGURE 5.—Variation of spontaneous-ignition temperature with residence time, surface area, and air velocity.

these limitations, the principal function served by a background in fuel ignition is in helping to define the circumstances, sometimes quantitatively and often qualitatively, that must have existed in a crash to give the observed results.

While much concerning fuel ignition is well-known and need not be repeated here, the subject of the spontaneous-ignition temperature of hydrocarbons presents certain subtleties that have been the source of much confusion and merit consideration. Chief among these subtleties is the fact that there is no single assignable minimum ignition temperature for hydrocarbon fuels. Experiments on the so-called spontaneous-ignition temperature, conducted in apparatus in which combustible concentrations of hydrocarbons are contained in a uniformly heated cavity of known temperature, provide an ignition temperature-time curve, such as that shown in figure 5 (a), taken from reference 4 and from unpublished NACA data. On this figure appears a curve for 100/130 grade aviation fuel. These data were obtained in a

standard A.S.T.M. spontaneous-ignition-temperature apparatus. The other curve on this figure is for aviation gasoline in use at the time of the experiments (1930) which was probably 80-octane fuel. These data were obtained in an enclosed steel tube 12 inches in diameter and 12 inches long.

From these data it may be seen that, as the residence time of the fuel at elevated temperature increases, the minimum temperature at which ignition may occur reduces. For a brief residence time of 2 seconds for 100/130 grade gasoline, the ignition temperature is 1020° F. This ignition temperature reduces to 850° F for a residence time of 6 seconds. By comparing these data to those of reference 4, it can be seen that this ignition temperature may go even lower if the fuel remains in contact with the heated surface for a longer time; 6 seconds is the longest residence time for which data are available at this time. Variations in the chemical composition and fuel-air ratio will shift the position of this curve on the time-temperature coordinates without altering the essential

fact that the ignition temperature declines with increasing residence time. It is important to appreciate that the residence time refers to the time a given fuel molecule stays at the prescribed temperature. Minimum spontaneous-ignition temperatures for lubricating oil and for hydraulic fluid were obtained in references 5 and 6, respectively. A minimum spontaneous-ignition temperature for lubricating oil of 770° F was obtained with a residence time of 6 seconds. The minimum spontaneous-ignition temperature for hydraulic fluid was 437° F at a residence time of 140 seconds. When the fuel-air mixture is not contained in a uniformly heated cavity but contacts a hot surface maintained at temperatures appreciably above that of the neighborhood, the fuel contact time with the hot surface is governed by the area of the surface and the magnitude of natural-convection currents associated with the hot surface or the local forced-air circulation rate produced by wind or airplane motion. Figure 5 (b) illustrates the marked dependence on surface size of the minimum surface temperature required for ignition, and figure 5 (c) shows how the air motion adjacent to the heated surface raises the surface temperature required for ignition. It is evident from these data that the surface temperature required to ignite a mixture of fuel and air which is in motion past a hot engine exhaust-disposal system is higher than that required when the exhaust-disposal system is at rest in the same atmosphere. Combustible mixtures resident within stationary engine cylinders where prolonged residence time is possible would have spontaneous-ignition temperatures that can be as much as 100° F below the surface temperatures required of the exhaust-disposal system for fuel ignition except in a sheltered zone, according to the data of figure 5 (a).

In contrast with the time delay associated with ignition by hot surfaces, flames and electric sparks provide almost instantaneous ignition. The energy required in an electric spark to ignite the constituents of gasoline decreases from 0.9 to 0.1 millijoule as the fuel-air ratio changes from stoichiometric to 1.8 times stoichiometric (fig. 5 (d)).

Because of the interaction of all these variables in establishing an ignition temperature, a preliminary study was made with an operating engine to determine the ignition temperature of gasoline and lubricating oil on the hot exhaust-collector ring. The minimum ignition temperature obtained in these studies was 950° F for aviation gasoline and 760° F for lubricating oil. Ignition of hydraulic fluid was obtained at 600° F; however, no attempt was made to obtain a lower ignition temperature.

In the subsequent sections of this report, these data on fuel ignition will be helpful in interpreting some of the observations made in the crash-fire studies.

IGNITION SOURCES

The ignition sources revealed by the full-scale airplane crash studies can be classified in the following broad categories:

- (1) Hot surfaces
- (2) Friction and chemical sparks from abraded airplane metals
- (3) Engine-exhaust flames
- (4) Engine induction-system flames
- (5) Electric arcs, and electrically heated wiring and lamp filaments
- (6) Flames from chemical agents
- (7) Electrostatic sparks

HOT SURFACES AND FRICTION AND CHEMICAL SPARKS

Almost all hot metal surfaces present in a crash previous to the start of fire are carried by the airplane before crash impact. These surfaces include the exhaust-disposal system, exhaust-gas heat exchangers or combustion heaters, and the high-temperature spots of the engine cylinder interior. In a crash at take-off, the highest temperatures at local areas of the exhaust-disposal system exceed 1200° F because of the high engine power level employed. The lowest temperature of the exhaust system at which gasoline ignition was obtained on the external surfaces was 950° F. In a normal landing, the exhaust-disposal system has temperatures as high as 840° F in local areas. These data were obtained with a C-82 airplane. While this temperature is too low for gasoline to ignite readily, it is high enough for the ignition of lubricating oil that may, in turn, ignite the fuel. This gasoline ignition temperature of 950° F is in keeping with the data shown in figures 5 (a) and (b), in view of the large heated surface area presented and the low residence contact time between fuel and surface permitted by the convective air movement around the exhaust-system components. If high engine power is employed to correct a faulty landing approach, high exhaust-system temperatures characteristic of take-off may occur upon landing as well. Ignition sources in this category are likely to remain fixed in position with respect to the rest of the airplane in the take-off and landing type of crash considered in this study. Loss of an engine from the nacelle, however, will free some of these hot surfaces to move into different zones around the airplane.

Probability of ignition on hot surfaces is high, because they are present at the moment of crash and remain at dangerous temperatures for several minutes thereafter. The temperature history of the exhaust-disposal system, for example, taken during crash (fig. 6), following operation at take-off power, indicates that it takes 30 seconds for the hottest portions of the exhaust-collector ring to cool to 950° F, the lowest temperature at which gasoline will ignite readily on the external surfaces of the exhaust system, and 84 seconds to cool to 760° F, the lowest temperature at which lubricating oil was observed to ignite readily.

The hot surfaces of the engine cylinder interior also can ignite a fuel-air charge. Since the situation within the cylinder approximates the circumstances under which the spontaneous-ignition temperature of gasoline was measured in a cavity bounded by hot walls, the data of figure 5 (a)

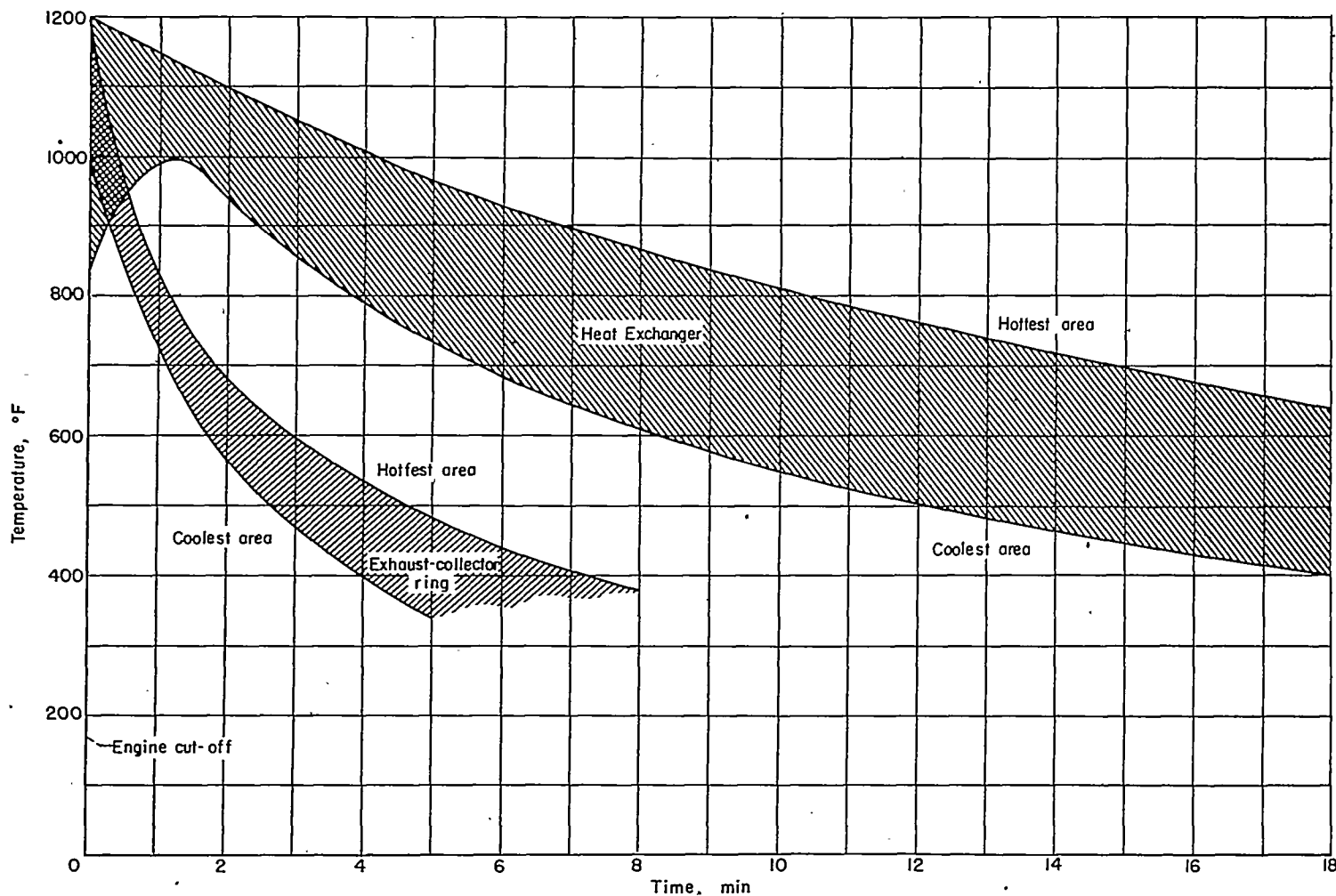

FIGURE 6.—Temperature-time history of exhaust system during crash test.

apply. These data show that the ignition of gasoline is possible if the effective temperature of a portion of the cylinder contents remains above 850° F for the 8 seconds involved. Such conditions are probable around the spark plugs in the cylinder head and the exhaust-valve assembly. Following operation at full engine power, elements of the exhaust-valve port and assembly may be hot enough to ignite the fuel-air charge almost immediately upon contact. At times, however, the cylinder charge that is ingested just as the engine rotation stops ignites after many seconds residence time in the cylinder. In one of the instances noted in this study, the resulting flash appeared as a backfire 3.7 seconds after the engine rotation ceased. The appearance of this flame at the engine inlet is shown in figure 7 (a). Another example noted in this study is shown in figure 7 (b), in which case the engine ignition system was cut 2 seconds before impact while the engine was developing full power. At 2.2 seconds after impact, the backfire shown in figure 7 (b) occurred.

The hot surfaces of friction sparks and the parent metal surface from which the sparking particles are abraded represent possible ignition sources that can appear only while the crashed airplane is in motion, by virtue of the mechanism

by which friction heat and abrasion are developed. Sparks of sufficient size and temperature to ignite gasoline have been obtained from steel airplane parts bearing on concrete paving with contact pressures in excess of 100 pounds per square inch. Ground studies under simulated crash circumstances showed the ignition hazard also associated with the abrasion of magnesium on concrete paving or stony ground. The abraded magnesium particles ignite in the air and provide ignition sources whose temperatures are considerably greater than those of abraded steel particles. The high temperatures of the latter are obtained primarily from friction heat. It is useful to designate sparks that owe their elevated temperatures to high oxidation rates as chemical sparks. Chemical sparks of sufficient size and temperature will ignite aviation gasoline with moderate loads between the materials in grinding contact. Friction sparks that would ignite aviation gasoline must be generated with high bearing force per unit area.

Wheel brakes heated to temperatures high enough to ignite hydraulic fluid and possibly gasoline by heavy application of the brakes have been reported elsewhere and must be included among the hot-surface ignition sources, even though

they were not encountered in these studies. Circumstances under which the brakes plus the hydraulic fluid might constitute an ignition source were observed in a crash in which the wheel and strut stripped from the airplane at the crash barrier followed the airplane in its skid along the ground. The hydraulic fluid, contained under air pressure in the landing-gear strut, issued as a fan-like spray from a longitudinal crack in the strut. If these circumstances were to exist in a crash in which heavy braking was employed previous to or during the crash, experience with ignition of hydraulic fluids would indicate a high probability of fire, first of the hydraulic fluid and then of the gasoline that may flow to the wheel from the crashed airplane.

EXHAUST FLAMES

Plumes of exhaust flames appear in the crash when fuel from the disrupted engine passes into the exhaust-disposal system without completing its combustion in the normal manner in the cylinder. Such a condition may result from failure of a spark plug to ignite the fuel, failure of the exhaust valve to contain the burning cylinder charge, or excessive enrichment of a cylinder charge, which burns as a torch in the air at the exhaust-pipe exit. If the engine ignition is cut off when the engine is drawing fuel, a series of flames often appears at the tail pipe (fig. 7 (c)). If the ignition is cut off just prior to a crash, the exhaust flames may continue to appear following crash impact. Several momentary flashes of exhaust flames are likely to occur immediately after impact of the engine propeller blades with the ground. These flashes may continue at irregular intervals as long as the engine drive shaft is rotating and fuel is drawn into the engine. Because an airplane crash does not always stop the engine completely, exhaust flames can appear for several minutes after crash impact. The appearance of one of the longest exhaust flames observed in these studies is shown within the circle at the engine exhaust in figure 8. In no case did an exhaust flame extend 16 inches beyond the exhaust exit and last for more than 0.2 second in the crashes studied. In the three instances in which engines were torn free from their mounts in the crash, no exhaust flames were observed during and after engine separation. Loss of the carburetor at the beginning of engine separation may be the reason for this effect.

ENGINE INDUCTION-SYSTEM FLAMES

Engine induction-system flames appeared less frequently than exhaust flames in the airplane crashes conducted so far. Backfire of an engine cylinder charge out the inlet port and consequent ignition of the induction-system fuel-air mixture is a principal mode of development of induction-system flames. Because a cylinder charge may become ignited several minutes after the engine has stopped rotating, the induction-system flame can appear at any time from the moment of the crash to several minutes thereafter. If the engine induction system is intact in the crash, the flame appears

at the entrance to the engine inlet scoop. Wherever the engine inlet system is broken, the flame appears as well.

ELECTRIC ARCS AND ELECTRICALLY HEATED WIRING AND FILAMENTS

Disruption of the extensive airplane electrical system in a crash may provide ignition sources at widely scattered locations. Wires that are completely severed may provide electric arcs between the high potential wire terminal and the grounded airplane structure of sufficient intensity to ignite fuel or other combustibles. Wires may become incandescent by short circuits resulting from abrasion of wire insulation or collapse of the metal housing of a junction box onto the terminal post located within the box. Incandescent light filaments are normally present during flight at night. Because of the relatively large diameters of the filaments of the landing light, temperature high enough for gasoline ignition may exist for at least 0.75 to 1.5 seconds after the light bulb is smashed and the filament broken (refs. 7 and 8). Momentary electric sparks produced by interrupting a current-carrying circuit are more likely to have sufficient energy to ignite fuel if the circuit contains coils such as the electromagnets employed in relays and valves.

About 0.15 millijoule is the minimum energy for spark ignition of a slightly richer than stoichiometric mixture of hydrocarbons and air under approximately standard conditions of pressure and temperature (ref. 9). This minimum energy is affected by size, material, and spacing of contacts and the rate and manner in which the energy is delivered. With an optimum contact separation of 0.65 inch, the effect of contact size is negligible. As the contact spacing is decreased, the minimum energy for ignition and the effect of contact size increase. With a needle contact, the minimum energy required for ignition is doubled when the contact spacing is decreased from 0.65 to 0.2 inch. With a contact size of 0.19 inch, the energy required with a contact spacing of 0.2 inch is five times that required at 0.65 inch. Greater energies are required with smaller separations because of the quenching action of the contact surfaces (ref. 10). Reference 11 indicates that, when the rate of delivery of energy is exponential, 90 percent of the energy must be delivered in less than 50 microseconds to provide sufficient current for ignition. In crash fires in which disruption of low-voltage circuits is the biggest problem, arcing potentials are obtained from inductances containing considerable resistance that will absorb energy; since the minimum value given represents the energy delivered to the combustibles, the total circuit energy will be larger by that amount absorbed by the resistance. Because storage batteries are part of the airplane low-voltage circuit, electrical ignition sources may persist for several minutes after crash. Very often, however, electric arcs rapidly burn away the metal forming the arc electrodes, and the arc persists for not more than 0.6 second (ref. 12). A restrike of the arc is possible as the airplane continues to deform in the crash or if the wind deflects the airplane structure adjacent to an electrical failure and new electrical contact is made momentarily.

FLAMES FROM CHEMICAL AGENTS

Combustible chemical agents commonly carried on the airplane, in addition to the fuel, include the petroleum-oil-base hydraulic fluid, lubricating oil, and alcohol for icing protection. During flight, the ignition of any of these agents can produce disastrous fire even if the fuel never becomes involved. On the ground, however, a fire is seldom serious with respect to passenger survival until the fuel is ignited. For this reason, it is convenient in a discussion of crash fire to classify these agents when aflame as ignition sources in the same sense that plumes of burning fuel issuing from the engine exhaust are considered ignition sources.

Because all these chemical agents will ignite at lower temperatures than gasoline and some may require less energy in the electric spark for ignition, the presence of these agents improves the likelihood of the appearance of flaming materials in a crash. Once ignited, these agents burn for a long time and extend the time over which ignition of the fuel may occur. Being liquid, they can flow by gravity, or be distributed explosively (as in the case of hydraulic fluid contained at high pressure), or vaporize and move by convection to form a conducting path for fire from a fixed ignition source to the fuel.

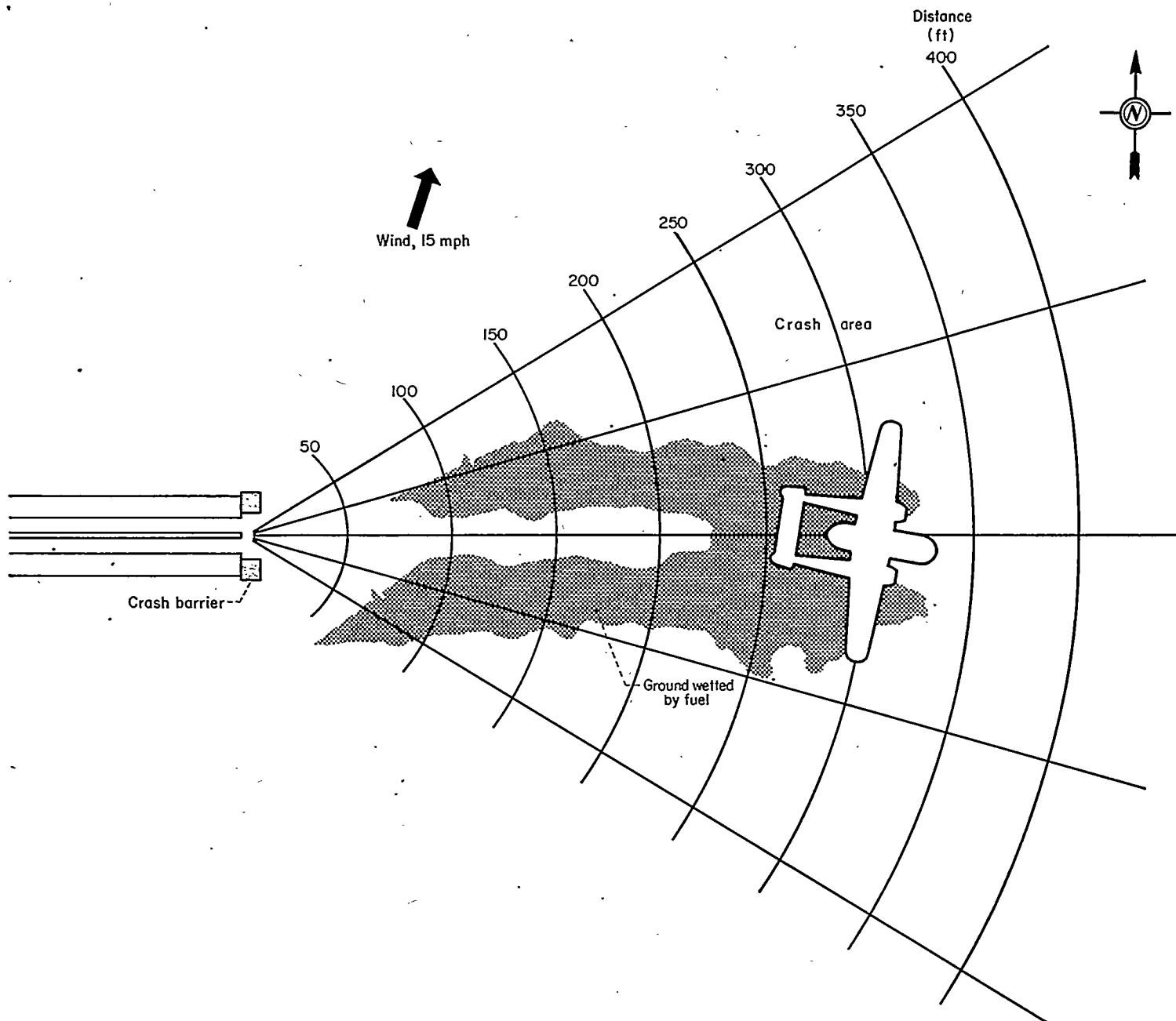
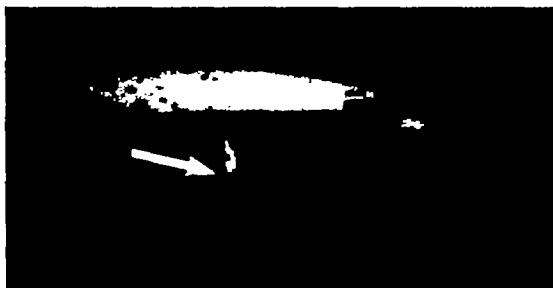

FIGURE 10.—Characteristic ground-wetting pattern of fuel deposited in wake of airplane.



(a) Backfire from engine induction system 7.7 seconds after initial impact and 3.7 seconds after end of engine rotation.



(b) Flaming out of induction system inlet 2.2 seconds after impact with barrier. Ignition system cut 2.0 seconds before impact.



(c) Exhaust flame resulting from cutting of engine ignition system during fullpower operation.

Figure 7.—Flaming out of engine induction system and exhaust flames from engine exhaust.



Fire from
previous
exhaust flame

Figure 8.—Largest exhaust flame from engine exhaust system observed during crash program; 3.3 seconds after initial impact.

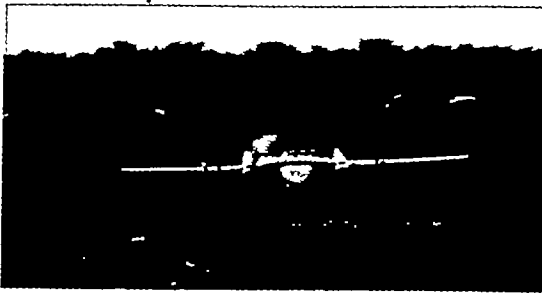

(a) Front view; 0.04 second after impact with first pole barrier. Airplane speed, 125 feet per second.



(b) Side view; 0.87 second after impact with first pole barrier. Airplane speed, 125 feet per second.



(c) Front view; 1.5 seconds after impact with first pole barrier. Airplane speed, 85 feet per second.



(d) Side view; 1.0 seconds after impact with first pole barrier. Airplane speed, 70 feet per second.

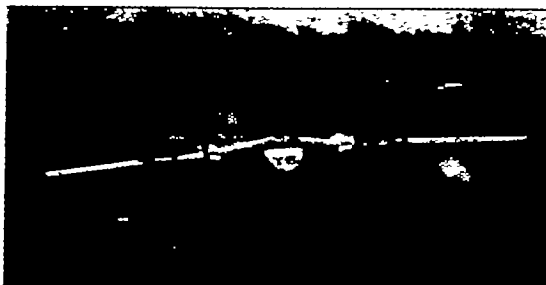

(e) Front view; 3.0 seconds after impact with first pole barrier. Airplane speed, 30 feet per second.



(f) Side view; 3.4 seconds after impact with first pole barrier. Airplane speed, 20 feet per second.



(g) Front view; 4.4 seconds after impact with first pole barrier. Airplane speed, 8 feet per second.



(h) Side view; 4.8 seconds after impact with first pole barrier. Airplane speed, 0.

Figure 9.—Development of fuel mist spillage from ruptured wing tanks. (Fuel dyed red.)

ELECTROSTATIC SPARKS

Electrostatic charge can be accumulated on airplane parts torn from the airplane in the crash as these parts move above ground through the dust and fuel suspended in the airplane wake. As the torn airplane part approaches the ground, an electrical discharge may occur of sufficient intensity to ignite the fuel spread in the airplane wake. Because the bulk of the airplane structure sliding along the ground usually makes good electrical contact with the ground, significant differences from ground potential on this structure are unlikely.

In general, the ignition sources observed in the crashes conducted so far are those expected to apply in airplane crashes on the basis of past experience with normal aircraft operations and by analogy with circumstances in other technical fields that are similar to those obtained in a crash. The full-scale crash studies indicate how the ignition sources arise, the time in the crash that they are likely to appear, and the circumstances under which they will start a fire.

FUEL SPILLAGE

In a crash, fuel is spilled in liquid form from broken fuel lines and tanks, as premixed fuel vapor and air from the damaged engine induction system, and as fuel mist around the airplane when the spillage appears on the outside of the airplane while it is in motion. In the last case, the pressure and viscous forces of the air on the fuel rip it to mist that moves with the air around the airplane. In the crash arrangements employed in this study, liquid and mist spillage occurred in every crash, and carbureted fuel spillage from the engine induction system in only a few cases. These latter instances, however, were sufficient to reveal how such spillage initiates fire.

FUEL MIST

Because the poles located at the crash barrier ripped open the fuel tanks and the adjacent wing skin while the airplane was moving at take-off speed through the crash barrier, the first fuel to appear was in mist form completely suspended in the air. At this time, the fuel mist (dyed red) had the appearance shown in figures 9 (a) and (b). At the existing high relative speed between fuel issuing from the tanks and the air streaming by, a significant percentage of the fuel droplets had a sufficiently small size to be suspended in the air for many seconds. These small fuel droplets could be observed making up the less dense cloud rising above the wing in the airplane wake (figs. 9 (c) and (d)). The large fuel droplets in the dense cloud remained suspended in the highly turbulent air adjacent to a jet of fuel issuing from the wing-tank rupture. As they moved to the rear, some of these large droplets were intercepted by the fuselage and tail-assembly surfaces and the remainder rained to the ground (figs. 9 (e) and (f)). As the airplane slowed, the average droplet size of the fuel particles increased until the fuel appeared to pour in a solid stream from the wing-tank rupture when the airplane came to rest (figs. 9 (g) and (h)).

A characteristic ground-wetting pattern provided by the fuel deposited in the wake of the airplane is shown in figure 10. The fuel trail deposited at the barrier is composed of two separate bands, one for each wing, which tend to broaden and finally coalesce in the neighborhood of the airplane rest point. When a tailwind blows, the ground-wetting pattern extends forward of the wing leading edge. In general, the inertia of the fuel carries it forward of the airplane rest point.

Time duration of mist ignition hazard.—Fuel mists in ignitable concentrations seldom persist around the airplane for more than 17 seconds after the airplane comes to rest. The larger mist droplets rain to the ground, and the air-borne fuel droplets are swept from the area by the wind. In passing from the area of the crash, the fuel mist may be blown over the engine nacelles, and, during the first few seconds of this period, the probability of mist ignition is significant. The hazardous period is short, because the last portion of the fuel mist to pass over the airplane is diluted below the ignitable limit. Even on calm days, the air dragged by the crashed airplane in its slide along the ground sweeps over the airplane when it comes to rest, and brings with it some of the fuel mist suspended in the airplane wake. Fuel-mist dispersal times taken from motion pictures of the crash are plotted in figure 11 as a function of the wind speed. The dispersal time decreases inversely with the wind speed in the expected manner. Because of the large error inherent in making a visual estimate of the persistence time of the fuel mist in the neighborhood of the airplane, indicated by the scatter of the data of figure 11, it was not possible to evaluate the effect of fuel volatility on this persistence time. Fuel

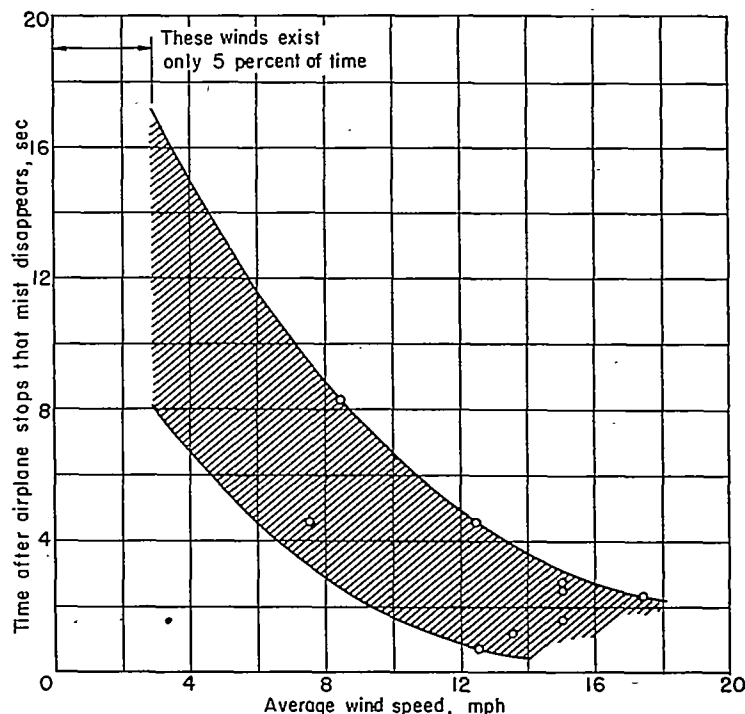
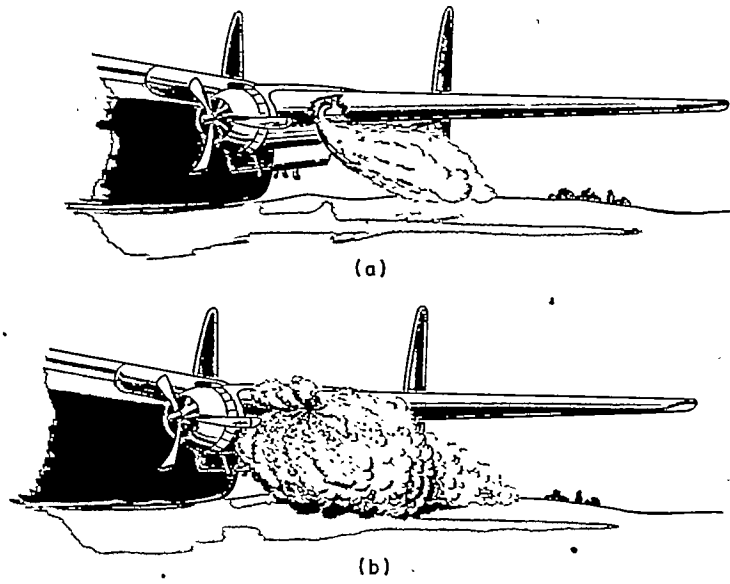

FIGURE 11.—Effect of wind velocity on time after airplane stops that fuel mist remains around crashed airplane.

vapors associated with the mist will move with the wind approximately as the smaller mist droplets and may have a persistence time a few seconds greater than the bulk mist.

Dispersion and ignition of fuel mists.—A first clue to the importance of the dynamics of the dispersion of the fuel mist in the ignition of the fuel was obtained early in the full-scale crash-fire studies when it was observed that this mist can propagate in a spanwise direction from the point of spillage on the wing and reach ignition sources located in and around the nacelle. This spanwise fuel propagation represents a displacement of the fuel droplets approximately perpendicular to the direction of the relative wind over the moving crashed airplane. It was also observed that, when the point of fuel spillage was located spanwise from the ignition source, fuel ignition occurred after the airplane slowed appreciably from its high speed at the crash barrier. A typical instance of this effect is illustrated in figure 12, in which is shown a series of pictures taken in sequence as the crashed airplane slid from the crash barrier to its rest point. Each photograph of the series shows an exhaust flame issuing from the engine tail pipe located 5 feet spanwise from the point of fuel spillage on the wing. Ignition of the fuel mist at the engine tail pipe occurred, however, when the airplane slowed from its initial speed of 137 feet per second at the crash barrier to 10 feet per second, the speed at which the photograph of figure 12 (d) was taken. (The light that appears on top of the pilot's compartment (fig. 12 (c)) is a timing light that is part of the airplane crash instrumentation.)

A study of the spanwise fuel spread conducted with taxiing airplanes and simulated fuel spillage (fig. 13) showed the following mechanism of fuel dispersion: When the leading edge of a fuel tank is breached on a decelerating airplane, the momentum of the fuel in the tank provides a forward surge of the fuel as a solid stream from the tank opening.



(a) High speed and low deceleration.
 (b) Low speed and high deceleration.

FIGURE 14.—Schematic diagram showing effect of deceleration and airplane speed on spanwise propagation of fuel mist emerging from ruptured fuel tank.

Impact with the air spreads the stream to give a spanwise velocity component to the fuel particles somewhat as would occur if the solid stream of fuel were to splash against a wall set normal to the original fuel-jet direction. The forward velocity of the fuel particles is reduced when the spanwise velocity component is acquired, and the advancing airplane intercepts the spreading fuel mist. If the airplane moves slowly, the fuel has an appreciable time to spread spanwise before interception and can extend to the nacelle. Likewise, high decelerations will produce high-velocity fuel jets that extend well ahead of the airplane and acquire high spanwise velocities. The combination of reduced airplane speed and high deceleration represents the critical condition of airplane motion with respect to fuel ignition by a source removed from the zone of fuel spillage.

A fuel-mist pattern obtained when the airplane deceleration is low and the speed is high would have the small apex angle and consequent low spanwise extension at the leading edge of the wing shown in figure 14 (a). In contrast, the mist pattern associated with high deceleration and reduced airplane speed (fig. 14 (b)) shows a wide apex angle and appreciable spanwise spread along the wing leading edge.

Wetting patterns (fig. 15) obtained with the simulated fuel spillage during the airplane taxiing studies show these effects clearly for four combinations of airplane speed and deceleration. The fuel was replaced by dyed water that issued from the wing at the location indicated in the figures. In figure 15 (a), the wetting patterns on the underside of the wing obtained with a fuel-jet velocity corresponding to a sustained deceleration of approximately 2.5g are less extensive spanwise than those obtained in the case of the 6.4g deceleration shown in figure 15 (b). In both figures, the wetting pattern is broader for the lower airplane speed. In the high-deceleration case, the fuel mist had a forward extension sufficient to wet the propeller blades and cowl inlet. Because the fuel droplets in the mist are air-borne, a relative wind having a spanwise component from the wing tip to the

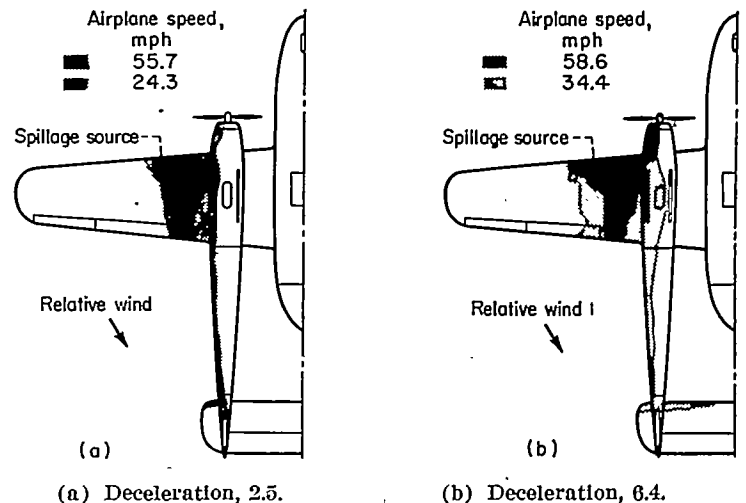

(a) Deceleration, 2.5. (b) Deceleration, 6.4.
 FIGURE 15.—Wetting pattern obtained with simulated fuel spillage during airplane taxiing tests.

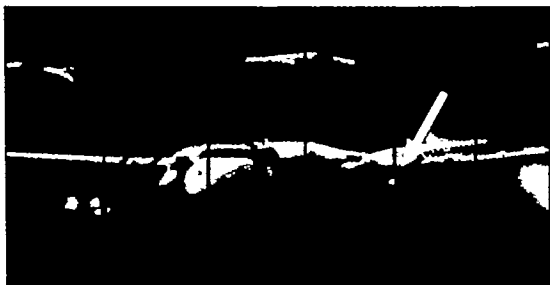

(a) First exhaust flame and spread of fuel mist; 1.1 seconds after initial impact. Airplane speed, approximately 105 feet per second.



(b) Second exhaust flame and spread of fuel mist; 2.0 seconds after initial impact. Airplane speed, approximately 70 feet per second.



(c) Third exhaust flame and spread of fuel mist; 2.2 seconds after initial impact. Airplane speed, approximately 60 feet per second.



(d) Ignition of fuel mist; 4.1 seconds after initial impact. Airplane speed, approximately 10 feet per second.

Figure 12.—Ignition of fuel mist by exhaust flames from exhaust outlet.



Figure 13.—Test setup conducted with taxiing airplanes for simulating spanwise spread of fuel mist during aircraft crashes.

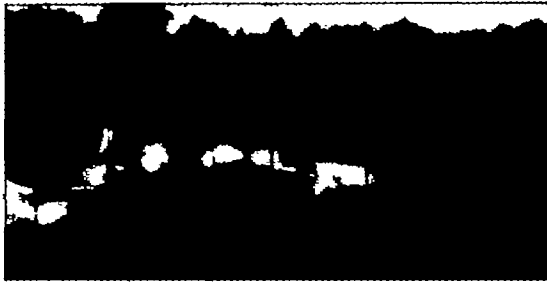

(a) Front view.



(b) Side view.

Figure 16.—Example of extreme forward and spanwise fuel mist development obtained during crash involving high airplane decelerations. Airplane speed, approximately 40 feet per second. (Fuel dyed red.)



(a) Fuel mist; 0.5 second after initial impact. Airplane speed, approximately 95 feet per second.

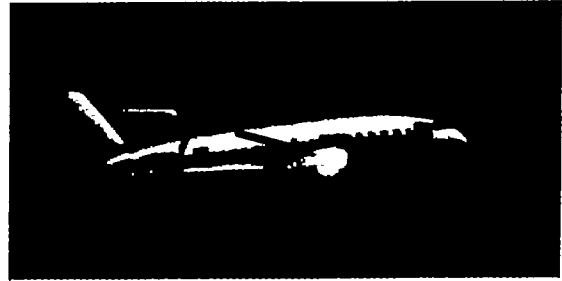

(b) Oil vapors emerging from nacelles; 3.88 seconds after initial impact. Airplane speed, approximately 3 feet per second.

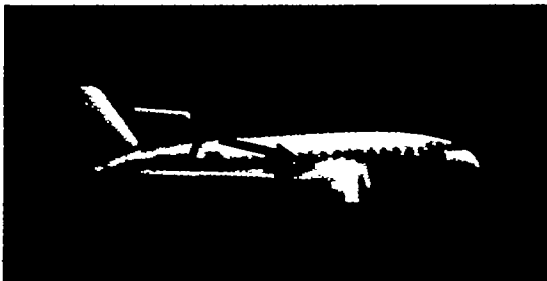

(c) First oil fire outside of nacelle; 3.42 seconds after initial impact. Airplane speed, 2 feet per second.



(d) Ignition of fuel mist by oil fire; 3.5 seconds after initial impact. Airplane speed, 0.



(e) Spread of fuel mist fire; 5.3 seconds after initial impact.



(f) Spread of fuel mist fire; 6.6 seconds after initial impact.

Figure 17.—Role of oil system in aircraft crash fires.

nacelle, as in the case of figure 15, will shift the fuel mist toward the nacelle and increase the likelihood of contact with an ignitor. If the relative wind were directly from the front, the wetting pattern would be approximately symmetrical about a chordwise line through the fuel-spillage point.

An example of an extreme forward development of the fuel mist obtained during a crash involving high airplane decelerations is shown in figure 16. The fuel mist extended

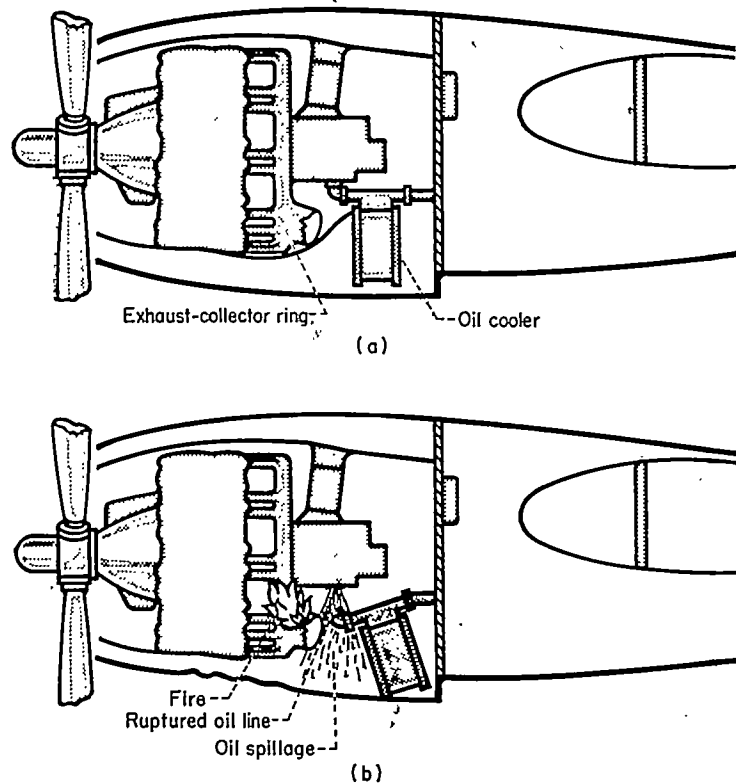

(a) Nacelle configuration.

(b) Oil-line rupture and initial oil fire on exhaust-collector ring 1.9 seconds after initial impact.

FIGURE 18.—Schematic drawing of C-46 airplane nacelle showing oil-cooler location and oil-line rupture in crashes.

28 feet ahead of the wing and reached a height of 12 feet above the top of the wing. Most of the wing span was covered by the fuel mist.

In order to establish the difference in velocity between the airplane and the tank fuel required for the fuel to project ahead of the airplane, the airplane deceleration must be sustained for a time that varies inversely with the magnitude of deceleration. In the case shown in figure 16, 0.3 second after the fuselage nose struck the ground, which represents the onset of high deceleration, fuel appeared at the leading edge of the wing with an initial velocity of approximately 30 feet per second with respect to the airplane wing. One second later the fuel achieved an extension of 28 feet ahead of the wing. In the high-deceleration phase following impact of the nose, the wing reached a momentary peak deceleration of 20g.

The volume of fuel mist generated with a given rate of fuel spillage is greater for a high-winged airplane like the C-82 than for a low-winged airplane like the C-46. This difference results from the fact that the fuel issuing from the tank of a low-winged airplane, the wings of which are close to the ground in a crash, is intercepted by the ground before appreciable atomization of the fuel occurs (fig. 17 (a)). The fuel sweeps forward of the wing leading edge, fans out on the ground, and attains a significant spanwise extension in liquid form (fig. 17 (b)). Slightly above this liquid spillage is an associated fuel mist generated by the splashing fuel in the relative wind.

The ignition of the fuel distributed in this manner by an oil fire in the nacelle forward of the wing leading edge is illustrated in figure 17. The nacelle installation of the airplane used in this crash (fig. 18 (a)) shows an oil cooler located at the bottom of the nacelle directly behind the exhaust-collector ring. Shortly after the airplane passed through the poles at the crash barrier, the fuel spilling from the wing tanks had the pattern shown in figure 17 (a), which is associated with the low airplane deceleration and high airplane speed sketched in figure 14 (a). When the airplane nacelles struck the ground, the oil coolers were broken away from the oil lines and oil poured on the exhaust-collector ring (fig. 18 (b)). The airplane decelerations resulting from the friction and plowing of the airplane structure along the ground provided a fuel-mist pattern whose apex led the wing leading edge, as shown in figure 17 (b), in contrast to the fuel-spillage pattern at the crash barrier, which was well behind the wing leading edge (fig. 17 (a)). At 1.9 seconds after impact at the barrier, the airplane instrumentation indicated a small oil fire at the base of the exhaust-collector ring (fig. 18 (b)). Visible in the photograph taken shortly after this time (fig. 17 (b)) are dense clouds of condensed oil vapor issuing from the nacelle. The spilling fuel can be seen pouring forward of the leading edge of the wing in contrast to its earlier position under the wing at higher airplane speeds, as shown in figure 17 (a). In figure 17 (b) fuel mist and condensed oil vapor merge to form a continuous combustible atmosphere at the reduced airplane speed of 3 feet per second. As the airplane slowed, the fuel pattern increased its forward extension (fig. 17 (c)) until, just before the airplane came to rest, the fuel extended to the nacelle. Propagation of the oil fire through the dense condensed oil-vapor cloud issuing from the nacelle provided the fuel ignition close to the nacelle shown in figure 17 (d). The fuel mist and condensed oil vapor suspended in the air around the airplane were made visible to the camera by the flame that traveled through them (figs. 17 (e) and (f)).

Significance of fuel volatility in crashes involving fuel-mist ignition.—In crashes in which ignition of dense gasoline mist by a potent ignition source is involved, the full-scale crash studies indicated that the substitution of fuel of low volatility for gasoline does not prevent a fire. In figure 19 (a) is shown the ignition of the dense low-volatility fuel mist by an ex-

haust flame. In accordance with the mechanism of fuel-mist dispersal previously described, this ignition took place 2.0 seconds after the airplane crashed at the barrier and slowed to 98 feet per second from its crash speed of 150 feet per second.

A similar fire from fuel-mist ignition by exhaust flames occurred on the right side of the same airplane, as shown in figure 19 (b). The fire burning on the left side of the airplane (fig. 19 (a)), set 1.5 seconds earlier, is also visible. A second crash in which the low-volatility fuel was employed provided a fuel-mist ignition at reduced airplane speed under similar circumstances on the right side of the airplane (fig. 19 (c)). Exhaust flames did not appear on the right engine nacelle in this crash, and fuel ignition did not take place.

Ground studies of flame propagation through fuel mist.—In order to obtain an appreciation of the circumstances under which fuels of low volatility will provide a margin of safety over gasoline when dispersed as a mist, ground studies on the ignition and propagation of flames through mists of fuel with Reid vapor pressures ranging from 0.1 to 20 pounds per square inch were conducted with the multiple fuel-nozzle rig shown in operation in figure 20 (a). Since the details are difficult to differentiate in figure 20 as reproduced in color, black and white copies of the figure in which the details are indicated are also shown. The plume of fuel mist issuing upward from the nozzle rig was laid in a horizontal direction by the wind. When an ignitor, a burning kerosene-soaked rope, moved through the fuel mist toward the nozzle rig, the first evidence of ignition of the mist was indicated by short tongues of flames extending into the mist downwind of the ignitor (fig. 20 (a)). For fuels having a vapor pressure equal to or less than gasoline, this first appearance of mist ignition occurred in portions of the mist that appeared quite dense, the air temperature being approximately 68° F. As the ignitor was brought into the denser mist closer to the nozzle rig, the flames propagated as a continuous sheet downwind from the ignitor through the mist (fig. 20 (b)). In further displacement of the ignitor toward the nozzle rig, a point was reached at which the flame propagated upwind (fig. 20 (c)).

When isopentane, having a Reid vapor pressure of 20 pounds per square inch, was employed as the fuel, the mist evaporated a short distance downwind of the nozzle rig and provided vapor plumes that were visible because of the associated optical refraction effects. Ignition of the fuel took place in the totally evaporated plume. In daylight the flame front moving upwind through fuel vapor was visible only as a colorless circular wave. Visible flame first appeared when the colorless circular wave propagated to the tails of the fuel mist (fig. 20 (d)). The distance between the ignitor and the flame shown in the figure represents the displacement of the colorless wave through the fuel vapor. The same effects probably would be obtained with gasoline on very hot days.

Data on the maximum downwind distance from the nozzle



(a)

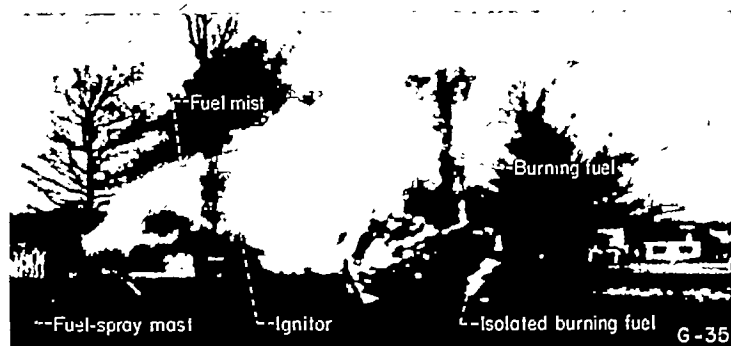

(b)



(c)

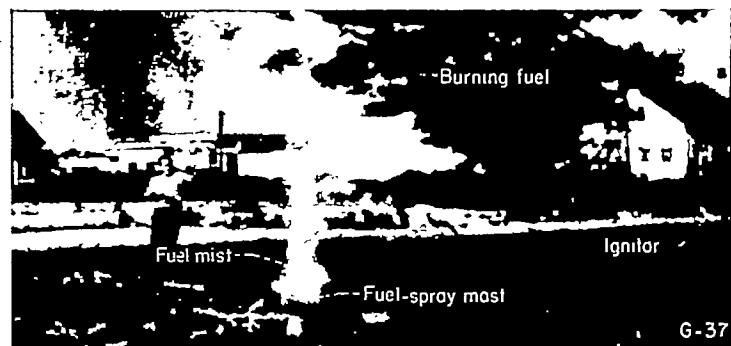

(d)

- (a) First ignition of mist of aviation gasoline.
- (b) Propagation of flame downwind in mist of aviation gasoline.
- (c) Propagation of flame upwind in mist of aviation gasoline.
- (d) Ignition of isopentane.

Black-and-white prints of figure 20.

rig that an ignitor must be placed for upwind propagation of the flame through the fuel mist obtained in these studies are plotted in figure 22. These data cover the range of Reid vapor pressures from 0.1 to 20 pounds per square inch, for



(a) Ignition left nacelle, test 7; 2.0 seconds after initial impact. Airplane speed, approximately 98 feet per second.



(b) Ignition right nacelle, test 7; 3.5 seconds after initial impact. Airplane speed, 50 feet per second



(c) Ignition left nacelle, test 8; 1.0 seconds after initial impact. Airplane speed, 74 feet per second.

Figure 19.—Ignition of fuel mist by exhaust flames from exhaust outlet. Low-volatility fuel.

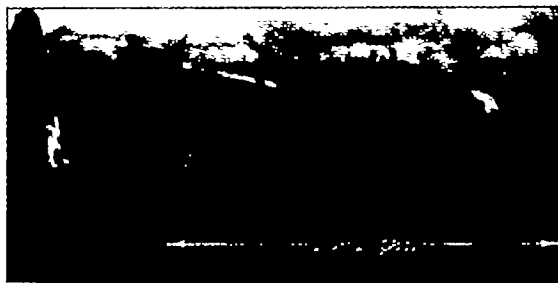
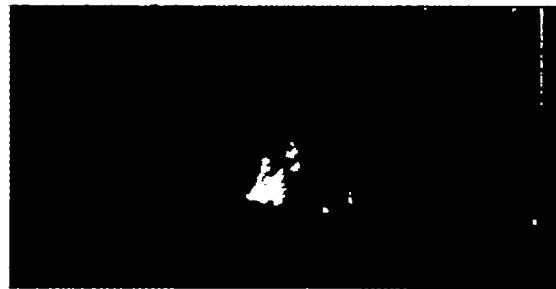
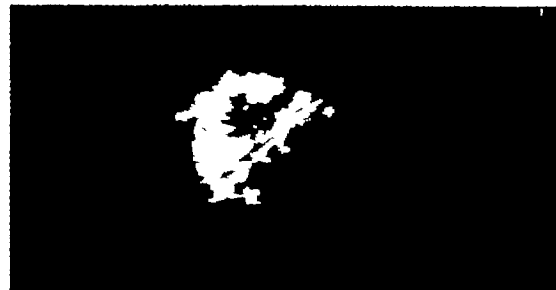

Figure 21.—Small danger distance of aviation gasoline in liquid state in open air.



(a) First ignition of mist of aviation gasoline.



(b) Propagation of flame downwind in mist of aviation gasoline.

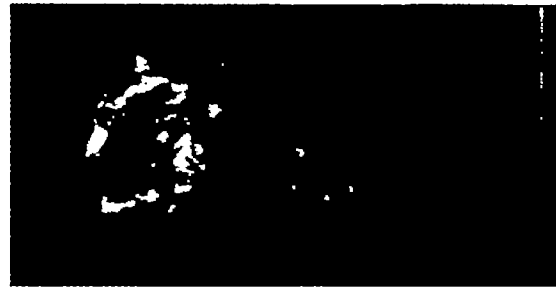

(c) Propagation of flame upwind in mist of aviation gasoline.



(d) Ignition of isopentane.

Figure 20.—Ground studies of ignition of fuel mists.

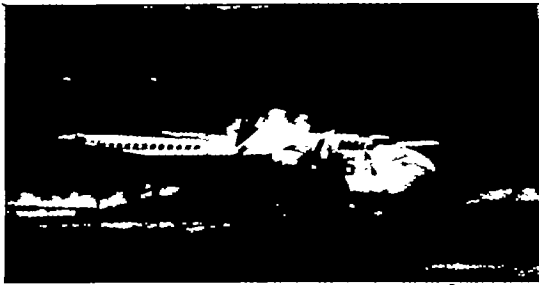

(a) Impact of poles with landing lights; 0.25 second after initial impact. Airplane speed, 143 feet per second.

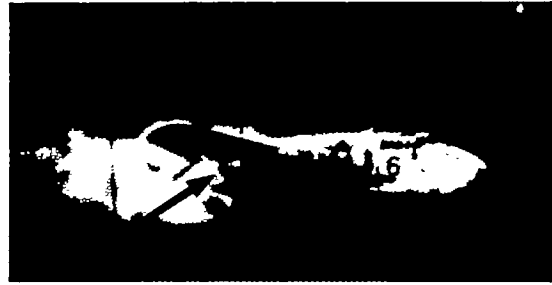

(b) Ignition on right side of airplane; 0.60 second after initial impact. Airplane speed, 135 feet per second.



(c) Simultaneous ignition of both sides of airplane; 0.60 second after initial impact. Airplane speed, 135 feet per second.



(d) Rapid development of fire; 1.8 seconds after initial impact. Airplane speed 96 feet per second.

Figure 24.—Ignition of fuel by landing lights.

LIQUID-FUEL SPILLAGE

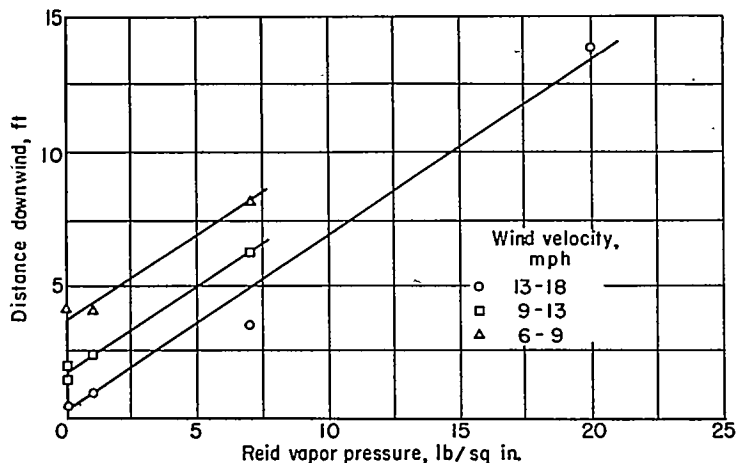

FIGURE 22.—Maximum distance downwind from nozzle rig that flame will propagate upwind as a function of fuel volatility and wind velocity. Ambient-air temperature, 68° F.

an air temperature of 68° F, with a fuel-flow rate of 178 gallons per hour through 17 hollow-cone spray nozzles each having a nominal rating of 10.5 gallons per hour. The data of figure 22 show that, in a given crash involving ignition of fuel mist, the maximum downwind distance the ignitor may be from the point of fuel spillage for the flame to propagate upwind to the airplane through the mist varies directly with fuel vapor pressure and inversely with wind speed. The maximum downwind distance from the fuel source at which upwind flame propagation will occur for gasoline mists (7 lb/sq in. Reid vapor pressure) decreases from 8 to 5 feet when the wind speed is increased from 8 to 18 miles per hour. At a wind speed of approximately 16 miles per hour, a change from gasoline to isopentane (20 lb/sq in. Reid vapor pressure) raises this maximum flame propagation distance from 5 to 14 feet. Because the distances given on figure 22 are a function of the rate of flow of the fuel generating the mist, magnitudes shown are of limited significance. The relative magnitudes given are important, however. These data are consistent with those obtained by the Texas Company in a comparable study (ref. 13), in which the fuel mists were generated by dropping fuel-filled bottles on a concrete platform exposed to a known wind. The presence of the crashed airplane and its debris can modify these results materially by providing wind-protected zones having lower wind speeds than those prevailing generally. The likelihood of upwind flame propagation through the fuel mist along these wind-protected zones is increased over that which would exist in an unobstructed wind.

These data show some advantage for fuels of low volatility under the special circumstances when the ignition source lies downwind of the fuel source producing the mist and upwind flame propagation through the mist is required to spread the fire. In the absence of statistics on the probability of the appearance of these circumstances in a crash, it is difficult to evaluate the margin of safety provided by fuels of low volatility when large fuel mists are generated.

The probability of obtaining combustible concentrations of fuel vapor and air from fuel spilled as liquid depends to a large degree on the local air ventilation around this spillage. Because of the low ventilation rate in the enclosed cavities of the airplane, such as the wings, large volumes of combustible concentrations of fuel vapor can accumulate from relatively little spillage. In zones such as the nacelle and landing-wheel well of a crashed airplane at rest, moderate ventilation rates exist. Relatively large fuel spillage, with evaporation taking place from extensive wetted surfaces, is required for combustible concentration to be realized in these zones. Vapors from liquid-fuel spillage on the ground exposed to the wind are subject to a high rate of air dilution, and combustible concentrations of vapor appear close to the liquid fuel only.

External fuel spillage.—Of the three types of liquid spillage just considered, only the ignition hazard associated with spillage on the ground exposed to the wind has been investigated in some detail at this time. Gasoline spilled in open air as liquid on warm ground or paved runways loses its more volatile constituents quite readily; the heat of evaporation is provided in large part by conduction from the unevaporated fuel and the fuel-wetted surfaces. Following the loss of the most volatile constituents and the associated temperature drop of the wetted surfaces, the fuel evaporation rate declines rapidly. The heat of vaporization is now provided primarily by convective heat transfer between the ambient air and the cool fuel. Exploration of the atmosphere by a combustible-vapor detector downwind of a pool of aviation gasoline arranged in pans measuring 16 feet long by 4 feet wide with the long dimension in the wind direction showed that the maximum horizontal downwind distance from the fuel at which ignition was possible was approximately 2 feet when the fuel was freshly exposed to a 3-mile-per-hour wind on a 70° F day. This danger distance declined to less than 6 inches after the fuel was exposed for several minutes. The downwind-air strata in which combustible fuel concentrations existed seldom attained a height of 6 inches above the fuel level of the ground-supported pans. This horizontal and vertical hazard distance decreased markedly with increasing wind velocities. In a 9-mile-per-hour wind a flame must be placed within 2 inches of the surface of the fuel at the downwind lip of the fuel pans in order to ignite the fuel. A photograph of the ignition of the fuel under these circumstances is given in figure 21, in which is shown the proximity of a cable-supported piece of burning waste to the downwind edge of the pool of gasoline required for gasoline ignition on a 70° F day. The pool of gasoline used in these studies is comparable in dimensions to those observed around the nacelles of airplanes crashed in this research. These results on the marked reduction in ignition danger distance with increasing wind velocity are consistent with those obtained elsewhere with prevaporized fuel released to the wind through single pipes.

The small danger distances around liquid gasoline spill-

ages in open air are due, in part, to the fact that gasoline has a heat of vaporization of approximately 140 Btu per pound, whereas the air which supplies this heat of vaporization by convective heat transfer has a specific heat of approximately 0.24 Btu per pound per °F. The same air flow that provides the heat of vaporization also serves to dilute the evolved fuel

vapors. Because of the large ratio of heat of vaporization of gasoline to the specific heat of air, a reduction in temperature of about 15° F is required of the air moving over the fuel surface to transfer enough heat to the fuel to evolve the mass of vapor necessary to bring the resulting air-fuel mix to the lower combustible limit. Only the air layer moving within a few inches of the fuel surface will undergo such a temperature drop in the short transit distance over the fuel. The combustible concentrations of vapors will be within this air layer of small vertical extent. Air dilution by mixing with adjacent air flow reduces the vapor concentration in this vapor-bearing layer shortly downwind of the pool of gasoline.

The short ignition hazard distance obtained in this work for liquid pools of gasoline exposed to unobstructed winds above 3 miles per hour, which exist more than 95 percent of the time in most of the United States, indicates a small likelihood of ignition of vapors convected by the air from these pools to an ignition source. Even when the gasoline pools were arranged at the engine cowl lips and cowl flaps as shown in figures 23 (a) and (b), respectively, wind-borne vapors from the gasoline in combustible concentration did not extend into the nacelle for a sufficient distance to be considered hazardous.

When the gasoline is spilled in tall grass and similar vegetation, the gasoline-wetted leaf surfaces increase the surface area from which fuel vaporization occurs. Protection of the vapors from air dilution by mixing is also provided. The ignition hazard distance, vertical and horizontal, is considerably longer than that which results from gasoline spillage on bare ground or pavement.

In zones around the crashed airplane that are well protected from the wind, vapor accumulation is possible. In the absence of significant heat transfer by forced convection from the wind, heat flow by conduction through the ground and the metal structure of the airplane and by radiation from the surroundings governs the fuel vaporization rate. Because vapor accumulation is possible, zones of combustible concentrations can develop with time, the magnitude of which is governed by air temperature, fuel volatility, the geometry of the airplane wreckage, and its orientation to the wind. Likewise, when spillage occurs on the ground in still air, the fuel vapors form as a layer adjacent to the ground by virtue of the high density of fuel vapor with respect to air. This fuel-vapor layer flows by gravity and may acquire considerable horizontal extent compared with the dimensions of the liquid pool from which the vapors are generated. Ignition of this vapor requires an ignition source placed close to the ground. Burning oil vapors or droplets dripping from the engine exhaust system, broken elements of the hot exhaust system falling to the ground, or sparks generated by the abrasion of magnesium and steel airplane parts on stony ground or concrete paving may provide the ignition in this instance. Ignition of fuel by friction sparks on a paved concrete slide path specially constructed for this study is shown in figure 23 (c). A portion of a steel propeller blade

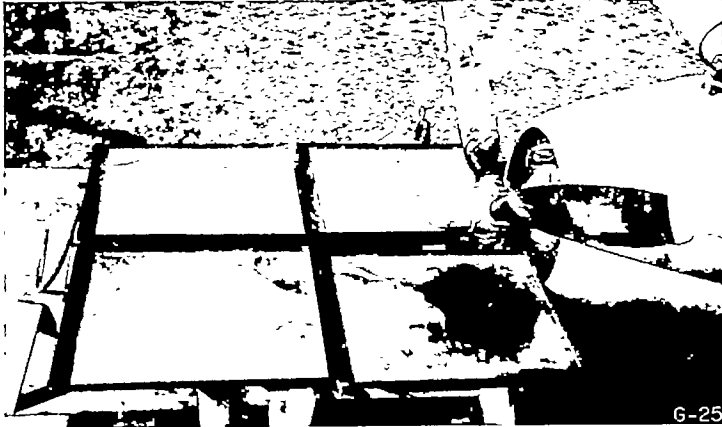

(a)

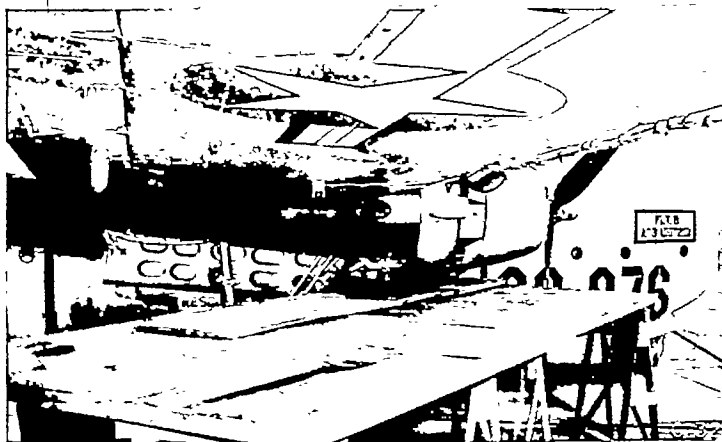

(b)

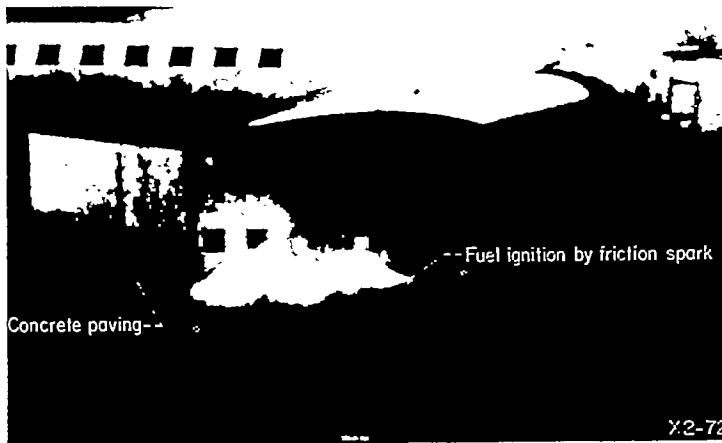

(c)

(a) Pans of gasoline upwind of cowl inlet.

(b) Pans of gasoline upwind of cowl outlet.

(c) Ignition of gasoline by friction spark from steel propeller blade bearing on concrete paving.

FIGURE 23.—Studies of ignition hazard from liquid gasoline spilled adjacent to nacelle.

mounted on the fuselage to bear with pressures in excess of 100 pounds per square inch on the concrete paving provided the sparks that produced the ignition of the gasoline at the fuselage-ground contact line (fig. 23 (c)). Most ignition sources in airplane crashes involving moderate structural damage will lie above this fuel-vapor layer, however.

Internal fuel spillage.—In a crash, the fuel spilled within the wings of airplanes of conventional configurations is exposed to ignition sources belonging primarily to the electrical system. Typical components carried on, or within,

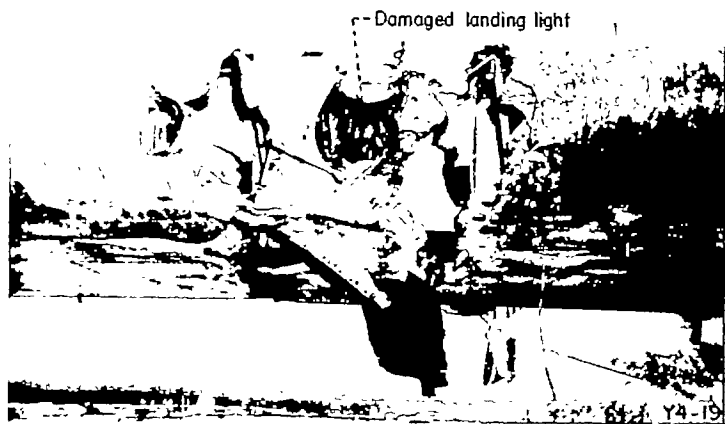

(e)

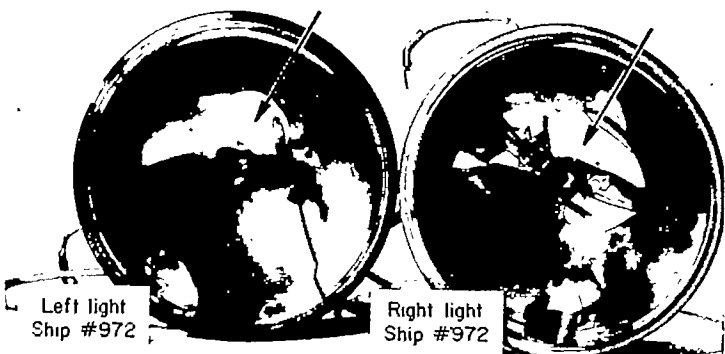

(f)

(e) Landing-light damage.

(f) Holes left in landing-light reflectors by filaments pulled into wing during crash.

FIGURE 24.—Concluded. Ignition of fuel by landing lights.

the wing requiring electrical wiring include wing-tip lights, landing lights, fuel pumps, and fuel-system solenoid valves. Ignition of fuel spilled in the wing by the electrical system was observed in one crash in which the poles at the crash barrier were set to smash the operating landing lights located in the leading edge of the wing and to drive them into the wing where the fuel tanks were also breached (fig. 24 (a)). The landing light on the left wing was struck squarely by the pole at the barrier to damage the light in a manner equivalent to that shown in figure 24 (e). The pole struck close to the landing light on the right wing.

When such close strikes are obtained, the landing-light mount is seriously distorted and the filaments are pulled into the wing by the heavy electric cable serving these lights. The holes made in the landing-light reflector by the withdrawing filaments are shown in figure 24 (f). The exposed hot lamp filament ignited the fuel spilled within the wing within 0.35 second after impact with the pole barrier. The resulting fire as it first appeared issuing from the wing is shown in figure 24 (b). Because of the proximity of the ignition source to the fuel spillage, ignition occurred immediately on exposure of the fuel at an airplane speed of approximately 92 miles per hour. The flame in figure 24 (b) appeared on the outside of the wing before the airplane had moved its own length from the barrier. A front view of the airplane (fig. 24 (c)), taken at the same time, shows a similar fire on the left airplane wing produced under the same circumstances. Propagation of the fire into the fuel mist associated with the fuel spillage from the moving airplane provided the high rate of fire development indicated in figure 24 (d), which shows the airplane fire 1.8 seconds after ignition. The flame-holding action of the airplane elements, such as the damaged wings containing burning fuel, allows high airspeeds in the combustion zones without flame blow-out, as is consistent with jet-engine combustion experience where similar circumstances exist.

When the fuel spilled within the wing forms a continuous wetted path to an outside ignitor, the resulting fire moves along the path to the fuel source. Channels for the distribution of the fuel within the wing may develop in the crash or be a part of the normal airplane configuration. The hot-air duct, for example, lying along the leading edge of the wings for protection against icing, may serve as a fuel distribution channel directing fuel spilled in a crash to a combustion heater or exhaust-gas heat exchanger that normally provides the hot air for icing protection. An illustration of this mode of fuel conduction to an ignition source was provided in the crash depicted in figure 25. The passage of the pole at the crash barrier through the leading edge of the wing in figure 25 (a) bent the skin toward the interior of the wing. Part of the fuel surging forward out of the wing rent was deflected into the leading-edge hot-air duct by the scoops formed by the deformed wing skin, as indicated schematically in figure 25 (b). Because of the wing dihedral, the fuel flowed by gravity toward the heat exchanger located on the engine exhaust tail pipe slightly forward and below the wing, which supplies hot air for the icing-protection system. The fuel flowed through the clearance between the duct wall and the hot-air-flow control flap in the nearly closed position and onto the heat exchanger. Ignition occurred at the heat exchanger, and the flame propagated back to the wing to produce the wing explosion shown in figure 25 (c).

The wing also serves as a channel for conducting wing-spilled fuel to adjacent airplane components. In the aircraft of the general configuration of the C-82, these adjacent components are usually the wheel well and the engine nacelle. A photograph of the distribution of fuel throughout the



(a)

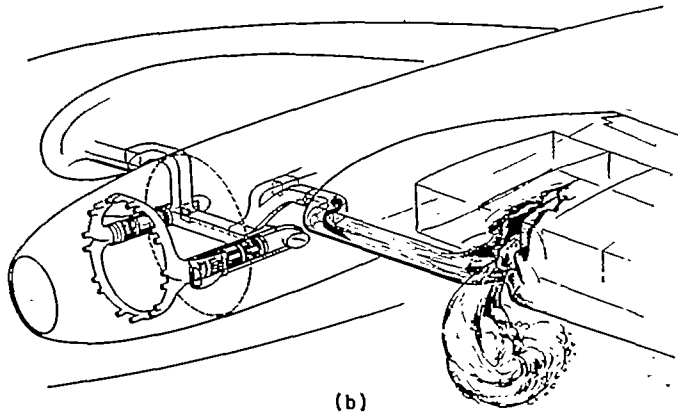

(b)

(a) Rupture of wing produced by pole barriers.

(b) Schematic diagram of hot-air anti-icing system showing path of liquid fuel flowing from wing tanks to heat exchangers.

FIGURE 25.—Mechanism of ignition of liquid fuel flowing through hot-air anti-icing duct.

wheel well of a crashed airplane is shown in figure 26 (a). This red-dyed fuel, released directly from damaged wing tanks, flowed to the wheel well through the internal wing structure. Because the wheel well contains elements of the electrical system, ignition of fuel from this source is probable when the fuel system is disrupted in a crash. Also of interest is the fuel that coursed down the landing-gear strut (fig. 26 (b)). This fuel, in conjunction with overheated wheel brakes, poses the possibility of fire initiation not observable in this crash study because brake application was not employed.

Wetting conduction.—In addition to the trough-flow of liquid fuel through internal channels of the airplane, fuel in rivulets and sheets does flow by gravity along the under side of airplane surfaces inclined to the horizontal. This type of flow is called "wetting conduction" to distinguish it from the other forms of fuel flow.

Wetting conduction of fuel occurs, for example, when some of the fuel spilled within the wing seeps through riveted seams of metal plates forming the skin and clings to the under

side of the wing. While some of this fuel drips to the ground, an appreciable portion wets and adheres to the under side of the wing and flows by gravity. If the wing slopes from the point of fuel-tank spillage toward the airplane nacelle because of the wing dihedral or the attitude imposed by the crash, an appreciable fuel flow is directed toward the nacelle, where many of the ignition sources are located. In figure 27 is shown a typical wetting-conduction trail marked by dye contained in the fuel carried by an airplane that did not burn in crash. The continuous fuel-flow path from the area around the breach in the wing to the wheel-well doors is evident. The dye trail left by the fuel flowing along the airplane skin directly above and behind the exhaust tail pipe is obscured by the dark paint on this portion of the airplane. The likelihood of ignition of this fuel by an exhaust flame is evident. Such ignition was not observed in the limited number of crashes conducted in this program, perhaps because every appearance of exhaust flames that occurred several seconds after crash involved ignition of the fuel mist.

Spreading of the fuel by wetting conduction proceeds at a relatively slow rate. In crashes in which fuel mists do not appear but fuel tank rupture does occur by inertia loading of the fuel on the tank walls during the crash deceleration, wetting conduction may well represent the mechanism by which the fuel reaches the ignition source at the nacelle. Under such circumstances, the ignition that may occur will probably take place several seconds after the airplane comes to rest, the delay involved representing the time for the relatively slow movement of the fuel by wetting conduction. While the airplane is in motion, likewise, the air flow around the wing will impose a chordwise motion on the fuel and direct it to the relatively safe zones at the wing trailing edge if the airplane is moving nose foremost. When the airplane comes to rest, a tailwind would promote the forward movement of the fuel toward the nacelle.

The same process of wetting conduction takes place within the nacelle and the wheel well by fuel lost from the ruptured fuel lines or other fuel-system components, or by fuel flowing through the airplane channels from spillage at remote locations. Fuel flowing by gravity into the nacelle, from a source of small size, can achieve appreciable spread by the combined process of wetting and dripping from one structural or engine component to another. In this way, the likelihood of contact with an ignition source is enhanced. Suitable photographs of this form of fuel spread in the nacelle are unavailable, but the process involved is evident from the spotty, yet widely distributed, fuel wetting shown in the wheel well of a crashed airplane in figure 26 (a).

When wetting conduction or fuel flow through structural channels is responsible for prolonged contact between an ignitor and the fuel in liquid form, so that appreciable quantities of vapors are generated, the use of fuels of low volatility would not materially reduce the likelihood of fire. But, when vaporization of the fuel across an air gap is required for the fuel to reach an ignitor, low-volatility fuels provide a real advantage.



(c) Explosion of wing following ignition of gasoline flowing through anti-icing duct; 13 seconds after initial impact; 0.6 second after ignition.

Figure 25.—Concluded. Mechanism of ignition of liquid fuel flowing through hot-air anti-icing duct.



(a) Wheel well.

(b) Landing gear strut.

Figure 26.—Distribution of fuel throughout wheel well and on landing gear strut from wing-tank spilled fuel. (Fuel dyed red.)

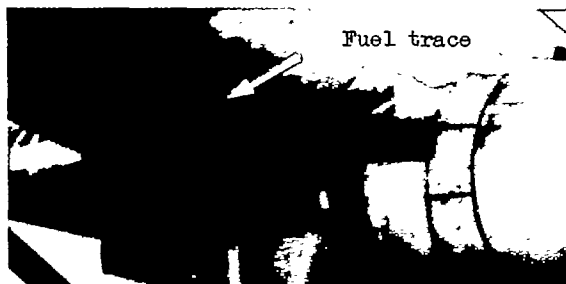
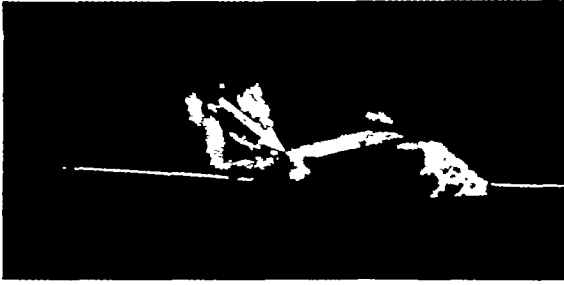

Figure 27.—Wetting conduction trail of fuel on under side of airplane wing. (Fuel dyed red.)



(a) Fire 2.8 seconds after initial impact. Airplane speed, 42 feet per second.



(b) Fire 7.4 seconds after initial impact. Airplane speed, 0.

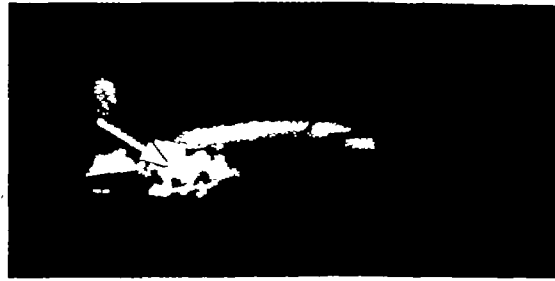

(c) Fire 7.7 seconds after initial impact.

Figure 29.—Extension of fire from nacelle to fuel spilled from wing tanks.



(a) Ignition of induction system vapor-air mixture; 0.13 second after initial impact. Airplane speed, 115 feet per second.



(b) Ignition of engine fuel from broken main fuel line in nacelle; 0.29 second after initial impact. Airplane speed, 111 feet per second.



(c) Ignition of fuel mist from fuel tanks spillage; 0.71 second after initial impact. Airplane speed, 102 feet per second.



(d) Spread of fire in fuel mist; 1.2 seconds after initial impact. Airplane speed, 39 feet per second.

Figure 30.—Spread of fire resulting from ignition of vapor-air mixture in induction-system.

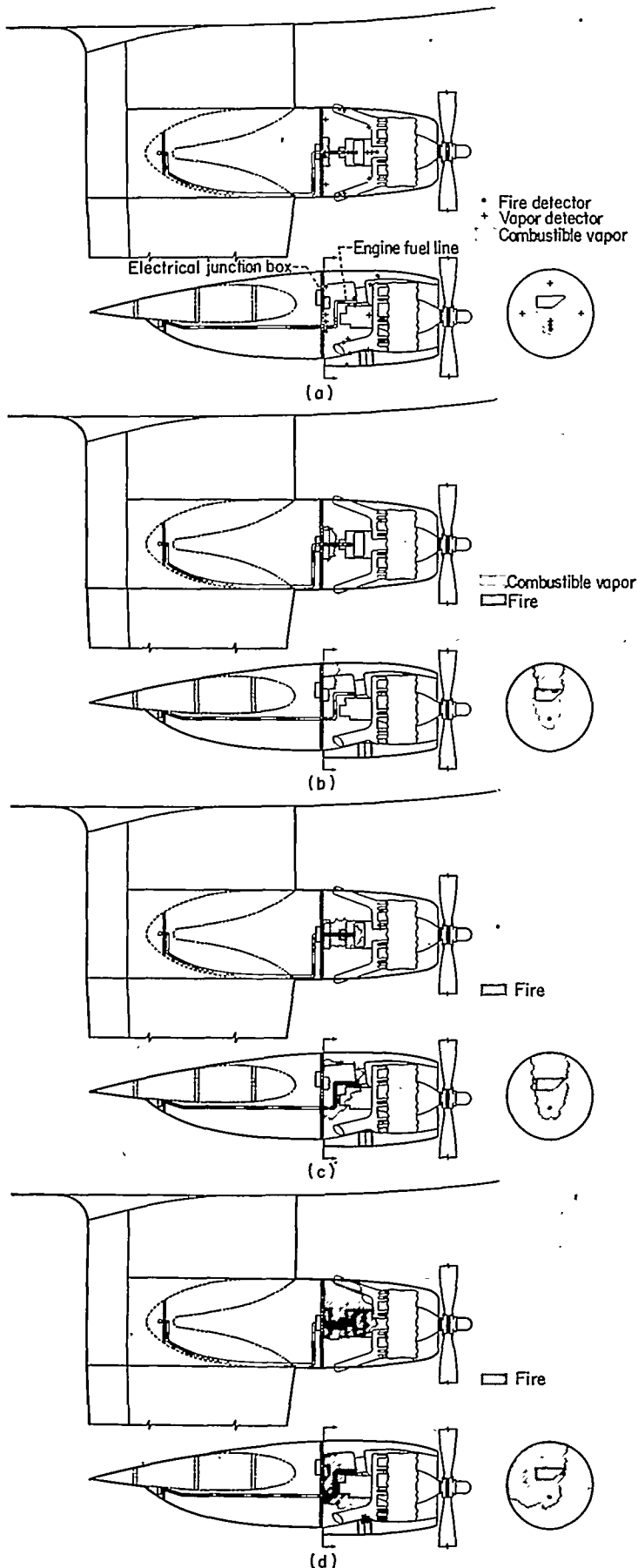

Nacelle fuel spillage.—When liquid-fuel spillage occurs within the nacelle, there is a high probability of ignition by a large variety of ignition sources associated with the engine and the complex electrical installation in the engine accessory section. As an example of the ignition of fuel spilled as liquid within the nacelle, it is instructive to follow the sequence of events leading to the ignition of this fuel by the accessory-section electrical system in one crash as revealed by the crash instrumentation. The crash instrumentation indicated rupture of the engine fuel line in the accessory section upon crash impact with the fuel booster pump at the wing tanks operating at normal speed. Vapor detectors indicated combustible concentrations of fuel at the fuel-line bulkhead fitting on the nacelle fire wall 0.25 second after crash impact. Location of this and other vapor detectors and neighboring fire-detection thermocouples is indicated in figure 28 (a). At this time, 0.25 second after crash impact, combustible vapors did not appear at any other location in the nacelle. Crash instrumentation indicated an electric current surge in the generator-starter circuits starting 0.50 second after crash impact, which reached a peak value of 30 amperes at 1 second after crash. The first fire-detection thermocouples to register were located immediately above the electrical junction box located on the nacelle fire wall (fig. 28 (b)), which is part of the generator-starter system. This junction box, therefore, is taken to be the location of a short-circuit arc that provided the fuel ignition. Successive indications of the fire detectors showed that the fire developed forward uniformly from the fire wall to the exhaust-collector ring, and that the exhaust system was not involved in the first fuel ignition (figs. 28 (c) and (d)). Extension of the fire from the nacelle to fuel spilling from the tanks as the airplane slowed to rest is shown in the succession of photographs in figure 29.

FUEL-VAPOR SPILLAGE

In a crash, spillage of fuel vapor premixed with air in combustible proportions may take place from the damaged engine induction system. When supercharging is employed, release of the compressed fuel-air mixture is rapid. Because of the proximity of the hot exhaust-disposal system and the electrical equipment in the accessory section of the engine nacelle, ignition of this fuel-air mixture will most likely occur within a few seconds after the engine induction system is damaged. If concurrent damage to the nacelle permits a high ventilation rate through the engine accessory section, ignition of the fuel-air mixture must occur imme-

- (a) Location of vapor and fire detectors in nacelle, and combustible vapor detected 0.25 second after initial impact.
- (b) Combustible vapor and fire detected in nacelle 1 second after initial impact.
- (c) Fire in nacelle 2 seconds after initial impact.
- (d) Fire in nacelle 3 seconds after initial impact.

FIGURE 28.—Mechanism of ignition by electrical system in accessory section of airplane nacelle.

diately after spillage if it is to take place at all, because the mixture will be rapidly diluted with air below the combustible limit. Since the quantity of fuel contained within the engine induction system at any time is only enough to produce a fire equivalent to a severe backfire, ignition of this fuel is of little consequence. If, however, other spillage of combustibles occurs previous to this ignition, then these combustibles may be inflamed by the flash fire of the engine induction-system fuel.

In the crash in which this mechanism of fuel ignition was observed, the airplane involved was equipped with steel-bladed propellers. Impact of the propeller with the abutment of the crash barrier produced a rotational displacement of the engine sufficient to rip open the engine induction system and the cylinder exhaust-stack connection to the exhaust-collector ring. The vapor-air mixture released from the engine induction system was ignited by plumes of exhaust flame issuing from the open exhaust stack before the wing fuel tanks were breached by the barrier poles (fig. 30 (a)). At the same time, the crash instrumentation indicated a parting of the engine fuel line in the nacelle produced by the engine deflection. Fuel poured from this line with the fuel booster pump at the tanks operating at normal speed. The fire of the engine induction-system fuel-air mixture ignited the fuel spillage from the broken engine fuel line to produce the fire shown 0.29 second after crash impact (fig. 30 (b)). The air flow around the engine spread the flames into the nacelle wake. The fuel mist issuing from the wing-tank rupture imposed by the poles at the crash barrier was ignited behind the wing, where the spreading fuel mist intercepted the flame extending rearward from the nacelle, as shown in figure 30 (c). At this time the fire had not propagated to the fuel mist under the wing. The resulting wing fire 1.2 seconds after impact is shown in figure 30 (d).

The engine induction-system fuel can be ignited from within the engine by the ordinary backfire mechanism. If the engine induction system is ruptured before the backfire occurs, the resulting flash may appear within the nacelle cowl and play the same role in setting the crash fire as the induction-system fuel played in the fire just described. While no airplane fires occurred by this backfire ignition of the induction-system fuel in the crashes conducted so far, the distinct possibility of setting fires in this way is shown by the under-cowl induction-system fire shown in figure 33. The disarranged engine cowl in its displacement from its normal position severed the engine cowl-inlet connection to the carburetor and provided an opening through which the engine induction-system fire appeared within the nacelle, 3.5 seconds after crash. In this instance, the fuel involved was the low-volatility (8 mm Hg Reid vapor pressure) fuel. The circumstance just described occurred in the crash discussed previously in conjunction with figure 19.

The engine induction-system fuel-air mixture that is spilled when the complete engine assembly is torn free of the nacelle in the crash was never observed to ignite in the three instances in which this spillage occurred in the full-scale crashes.

Two of these engines employed low-volatility fuel (8 mm Hg Reid vapor pressure) and one used gasoline. The brief contact between the released fuel-air mixture and the hot exhaust-system metal (permitted by the tumbling engine and the rapid fuel dilution rate with the surrounding air) is probably responsible for this result.

CRASH-FIRE EXPERIMENTS WITH MODIFIED AIRCRAFT

After the same ignition sources were observed repeatedly in the crashes conducted with the crash arrangements accepted as standard for the first phase of the full-scale crash study, modifications in procedure were employed in an effort to discover other ignition sources and to observe how they initiate fire. These modifications involved alterations to the airplane and the crash barrier. The quantity of fuel carried by the airplane remained unchanged at 1050 gallons. Aviation-grade gasoline was used throughout this phase of the program.

IGNITION-SOURCE INERTING

Since the fires observed in the first phase of the full-scale crash-fire program were set by ignition sources that functioned shortly after crash impact, it appeared probable that these early fires were masking other fire-setting mechanisms that would appear later in the crash. In an effort to prevent these early fires, therefore, the nacelle installation shown schematically in figure 31 was employed to reduce the likelihood of fire by ignition sources revealed in previous airplane crashes.

The ignition-suppression installation consisted of four main components all actuated as soon as possible after crash impact. In order to prevent the generation of flames issuing from the engine inlet, tail pipe, and other elements of a crash-disrupted exhaust-disposal system, a solenoid-operated fuel shut-off valve was placed between the carburetor and the fuel injector on the supercharger impeller. In addition, a second element consisting of a 3-pound charge of fire-extinguishing agent was arranged to discharge into the

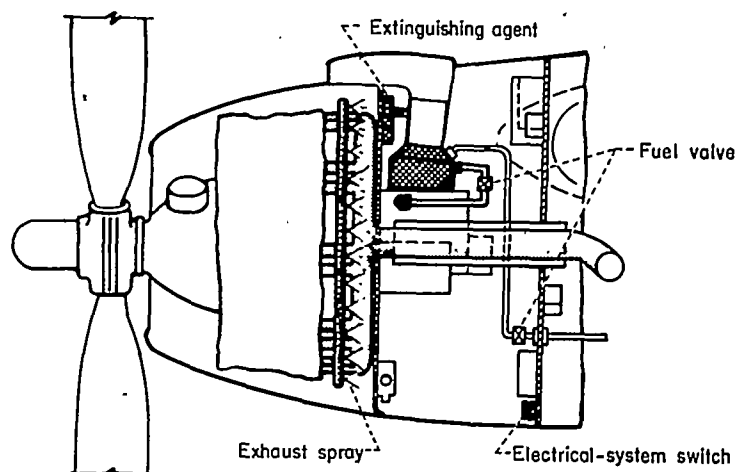

FIGURE 31.—Schematic diagram of ignition-source inerting system.

supercharger-impeller case with sufficient velocity to provide reasonably uniform mixing with the engine induction-system fuel. A 1/2-pound-per-second discharge rate was employed, giving a total discharge time of 6 seconds. This fire-extinguishing agent served to inert the engine induction-system fuel flowing through the engine that is present before the fuel shut-off valve closes completely. It was desirable to inject the extinguishing agent at the impeller housing rather than at the carburetor, in order to reduce the time required to transport the extinguishing agent from the injection station to the engine cylinders. Experience with injection of the extinguishing agent into the air flowing through the carburetor showed that the transport time involved was great enough for undesirable exhaust flames to appear momentarily at the exhaust tail pipe when the engine rotational speed was reduced abruptly by propeller impact at the barrier.

Electric ignition sources were avoided by cut-off switches on the battery and generator circuits. The engine ignition was allowed to remain operative on the thesis that, should combustible mixtures of fuel and air be ingested by the engine because of faulty operation of the fuel shut-off or fire-extinguishing-agent system, then normal combustion could take place in the cylinder. Otherwise, the fuel may pass into the exhaust system, there to ignite and produce an exhaust flame. Because the landing lights remain hot enough to ignite gasoline for at least 0.75 to 1.5 seconds after the elec-

tric current is turned off, interruption of the electric current by the cut-off switches did not represent a satisfactory control of this ignition source. For this reason, the crashes under this phase of the program were conducted with the landing lights inoperative.

The fourth element of the ignition-suppression installation was a system of water sprays distributed to give a simultaneous uniform coverage of the hot metal of the exhaust-disposal system and the associated tail-pipe heat exchanger. The water spray served the twofold purpose of rapidly cooling the hot metal to safe temperatures and providing, meanwhile, a protective blanket of steam generated on the hot surfaces that inerts the adjacent atmosphere. Water was the fluid selected for this purpose because of its high heat of vaporization and low molecular weight. Relatively small weights of water provided effective cooling and generated large volumes of inerting steam in the high-temperature zones adjacent to the hot metal. A consideration of the heat capacity of the hot metal of the exhaust-disposal system and the heat exchanger and the temperature drop of 250° F required to reduce the metal temperature from the maximum temperature of 1200° F at the moment of crash to the lowest exhaust-system surface temperature at which gasoline will readily ignite (950° F) yields a water requirement per nacelle of approximately 1/2 gallon for the C-82 airplane. In order to provide a safety factor, 4 to 6 gallons of water were employed for each nacelle.

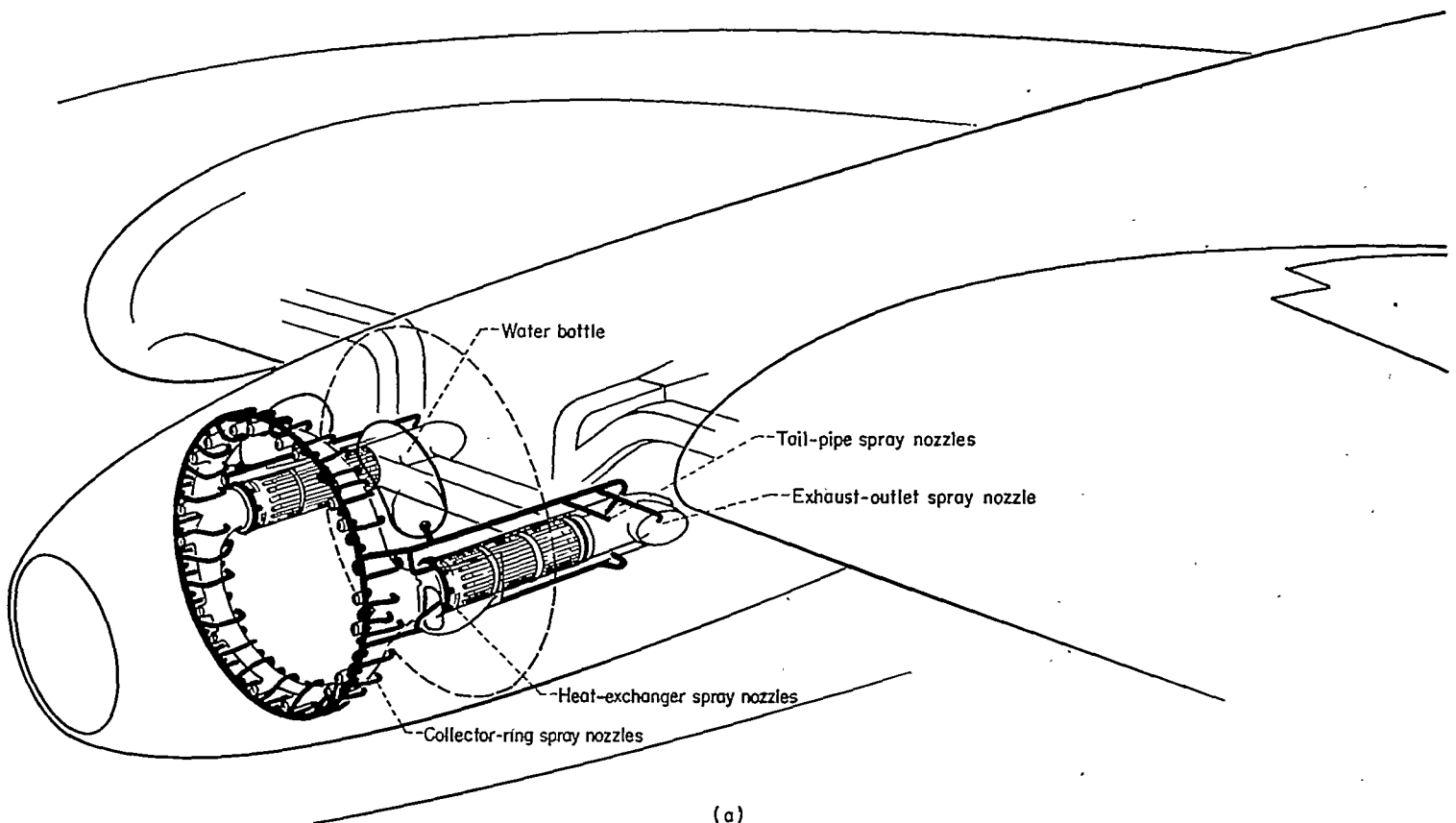

(a) Schematic diagram of nacelle installation.

FIGURE 32.—Water-spray system of ignition-source inerting system.

In view of the 760° F minimum ignition temperature of lubricating oil measured on the hot exhaust-collector ring in these studies, some additional consideration of the temperature to which the collector-ring metal is to be cooled is in order. A review of the sequence of events in a crash with the airplane equipped with water sprays leads to the following assessment of the cooling specification: Immediately following crash impact and in the subsequent motion of the airplane's slide to rest, contact between lubricating oil and any part of the hot exhaust-collector ring is quite likely. During this time, water sprays are in operation, a portion of the oil that may be in contact with the exhaust system evaporates along with the water, and the remainder drips from the exhaust system with some of the water. When the airplane comes to rest with engines and oil pumping stopped, further contact between the exhaust system and oil occurs with the oil flowing by gravity. Under gravity flow the contact that does occur will most likely be confined to the lower octant of the exhaust-disposal system. Water sprayed on the exhaust system also drains by gravity to the lower portions of the exhaust-system elements and provides greater cooling in these zones. In general, all elements of the exhaust system considered individually experience greater cooling on the lower portions for this reason. If the water sprays are maintained for about 10 seconds after the airplane comes to rest, those surfaces likely to be wetted by lubricating oil flowing by gravity are cooled to safe temperatures. The quantity of water carried in this system was more than adequate to meet the modest added water requirements for the lower portions of the exhaust system. In the installation employed here, the water-spray nozzles were sized to give a total spray time of 20 to 30 seconds or a flow for 15 seconds or more after the airplane comes to rest. On the basis of observations made in this study, departures from the mode of oil contact with the exhaust system described are considered to have a low probability of occurrence unless a large degree of distortion and displacement of the exhaust system occurs in the crash.

The essential elements of the water-spray system are shown schematically in figure 32 (a). The water, contained under nitrogen pressure of approximately 400 pounds per square inch, was distributed to all hot metal elements of the engine exhaust system through the 3/4-inch-diameter manifold shown in figure 32 (b). The spray nozzles and branch lines terminating in spray nozzles are required to provide uniform water coverage of the hot metal parts. In order to provide rapid cooling of the hot metal, water was also sprayed into the interior of the exhaust system at six equally spaced locations, one of which is visible in figure 32 (b) at the junction of the tail pipe with the collector ring. The equivalent water-spray installations for the exhaust-gas heat exchanger are shown in figure 32 (c). The necessity for providing a protective blanket of steam around the external surfaces of the hot metal, where contact with combustibles may occur, while it cools to safe temperatures, fixes the external appli-

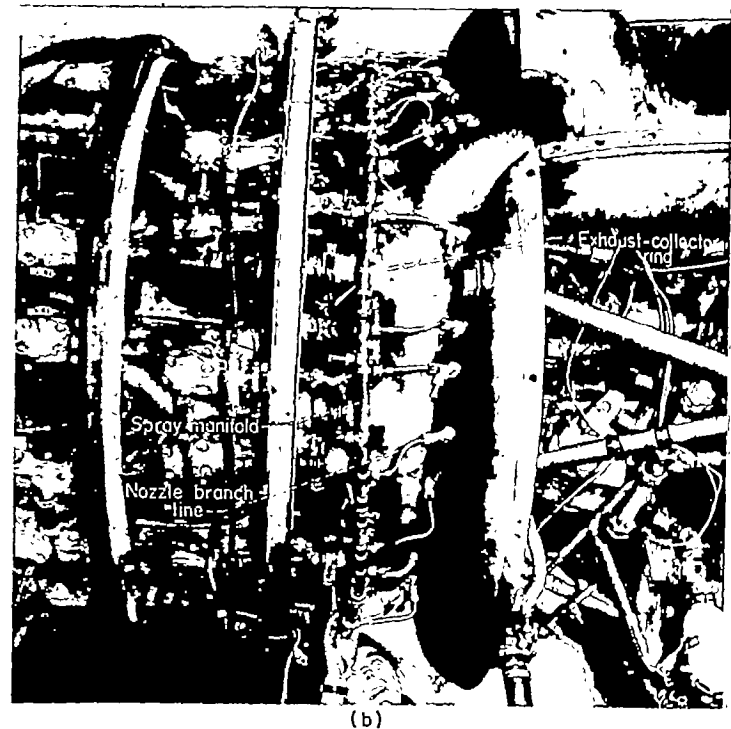

(b)

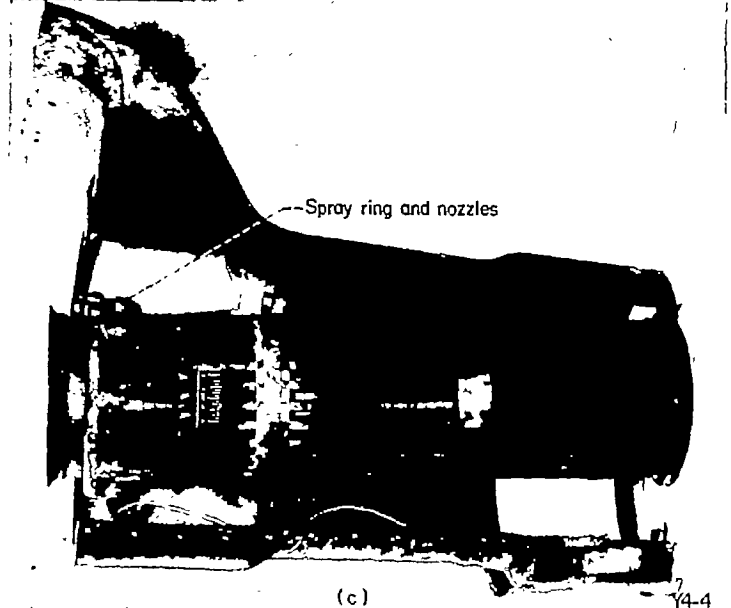

(c)

(b) Water-spray system for exhaust-collector ring.
 (c) Water sprays for exhaust heat exchanger.

FIGURE 32.—Concluded. Water-spray system of ignition-source inerting system.

cation of water as the primary requirement for this method of inerting. This external application is wasteful, however, because of the run-off of water in liquid form. By a proper split between internal and external utilization of water some economy was obtained. Internal application provided the added advantage that the water is totally contained within the exhaust system regardless of twisting and displacement. Because water application had to begin as soon as possible after crash impact, while the airspeed through t-

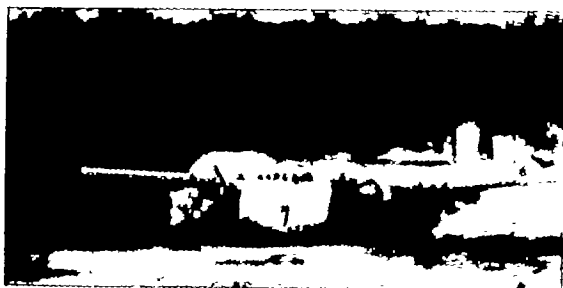

(a) Engine cowl disruption at barrier; 1.0 second after initial impact. Airplane speed, 130 feet per second.



(b) Induction-system fuel ignition 3.5 seconds after initial impact. Airplane speed, 50 feet per second.

Figure 33.—Delayed ignition of induction-system fuel.



(a) Oil fire before water sprays turned on.



(b) 1.0 second after water sprays turned on oil fire.

Figure 34.—Tests of water sprays of ignition-source inerting system.



(a) Deformation of right engine nacelle 2.2 seconds after initial impact. Airplane speed, 60 feet per second.

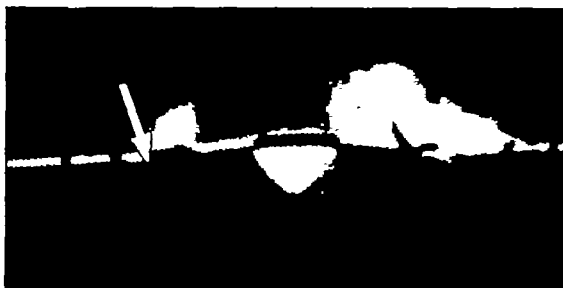

(d) First indication of fire on right nacelle 3.8 seconds after initial impact. Airplane speed, 18 feet per second.

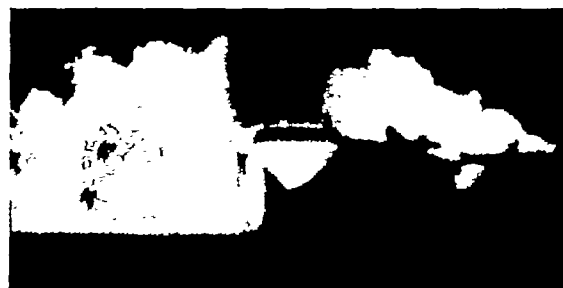

(e) Fire development 4.1 seconds after initial impact; 0.3 second after ignition. Airplane speed, 11 feet per second.

Figure 38.—Mechanism of ignition by hot metal of exhaust collector ring.



(a) Bromochloromethane burning on outside of heated stack.

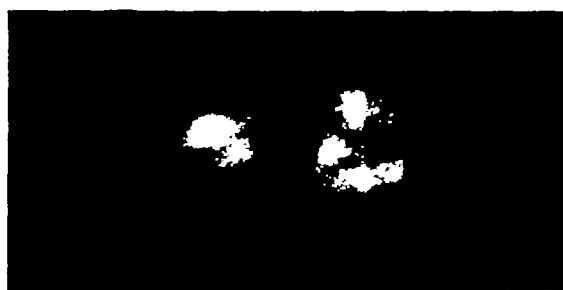

(b) Bromochloromethane burning on inside of heated stack.

Figure 39.—Bromochloromethane burning after ignition by section of exhaust stack heated to 1500° F.

nacelle is high, the spray nozzles were placed close to the hot metal to minimize water loss by air entrainment. The reduced surface coverage per nozzle occasioned by this proximity of the nozzles to the hot surfaces was compensated somewhat by arranging for the water to strike the surface near glancing incidence so that it may fan out along the surface. The water flow rate was adjusted to correspond roughly to the rate at which the water is evaporated initially. Faster water flow rates increase the water waste by liquid run-off.

Before any of the aircraft were committed to this part of the program, the elements constituting the complete inerting system were checked for their functional effectiveness and for the time following crash impact that they can be expected to operate. Fuel and electrical shut-off systems required development to improve reliability and actuation speed. Extinguishing-agent injection systems were engineered for uniformity of distribution within the engine inlet manifold. The effectiveness of the water-spray system was evaluated in an operating engine nacelle by spraying oil on the incandescent exhaust-collector ring and, with the oil continuing to flow, observing the action of the water spray in quenching the resulting fire. The appearance of the oil fire before the water spray was turned on is shown in figure 34 (a). One second after the water spray was applied, the fire was extinguished as shown in figure 34 (b). Because the water spray was effective in putting out an existing fire, it was considered safe to assume that it would prevent ignition in the first place. With a water-spray system that provided effective coverage of the hot metal, ignition of gaso-

line or oil did not occur when they were applied after the water-spray system was in operation.

Tests with gasoline sprayed directly onto the exhaust heat exchanger showed that the water spray did give protection against ignition when proper water distribution was provided with the nozzle arrangement shown in figure 32 (c). As additional insurance, however, against ignition of fuel by conduction through the icing-protection system hot-air duct to the exhaust-gas heat exchanger, a blind flange was inserted into the duct.

When the water spray was employed, the hottest areas of the exhaust-collector ring cooled in 12 seconds from an initial temperature of 1250° to 760° F, the lowest temperature at which lubricating oil ignites on the external surfaces of the exhaust system (fig. 35). The exhaust-gas heat exchanger cooled to temperatures safe for gasoline in 30 seconds. Contact between the hot areas of the heat exchanger and the lubricating oil is highly unlikely, and rapid cooling below 950° F is not required. The relatively stagnant atmosphere of steam within the heat exchanger continues to protect this zone until the heat exchanger cools by radiation and conduction to other portions of the airplane structure.

In the crash, the inerting system was actuated by a switch carried on the guide-rail slipper fastened to the nose-wheel strut, a photograph of which is shown in figure 36. A plywood target (fig. 37) was placed across the rail at the crash barrier to operate the switch after the propellers struck the barrier abutments. To provide a margin of safety against switch failure, a second switch connected in parallel was carried on the side of the airplane. The second plywood target shown on the angle iron support in figure 37 served this auxiliary switch.

The time delay between operation of the inerting-system actuating switch and the inerting component was 0.06 second for the extinguishing-agent discharge, 0.34 second for the fuel shut-off valve, 0.10 second for the electrical-system cut-off switch, and 0.19 second for full water-spray flow

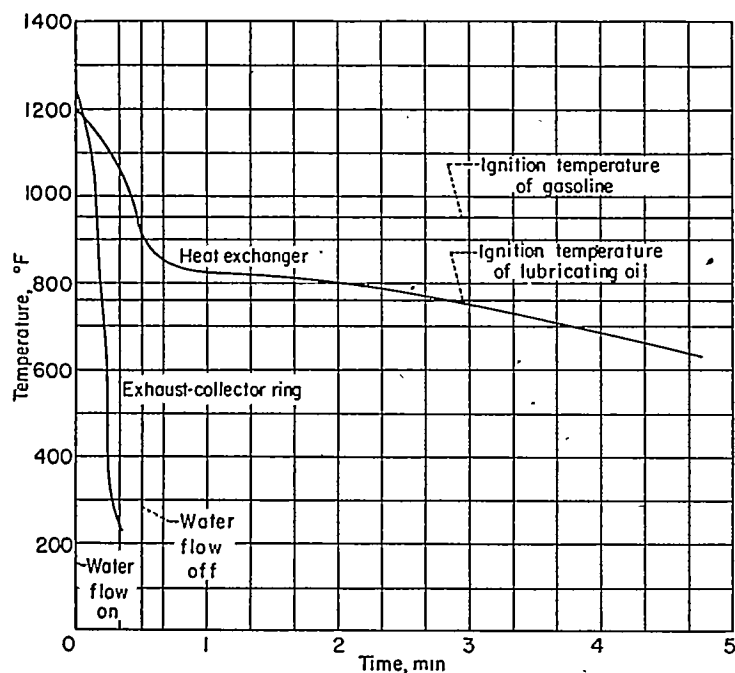

FIGURE 35.—Temperature-time history of hottest portions of exhaust system during crash test. Heat exchanger and exhaust-collector ring water-cooled and inerted.

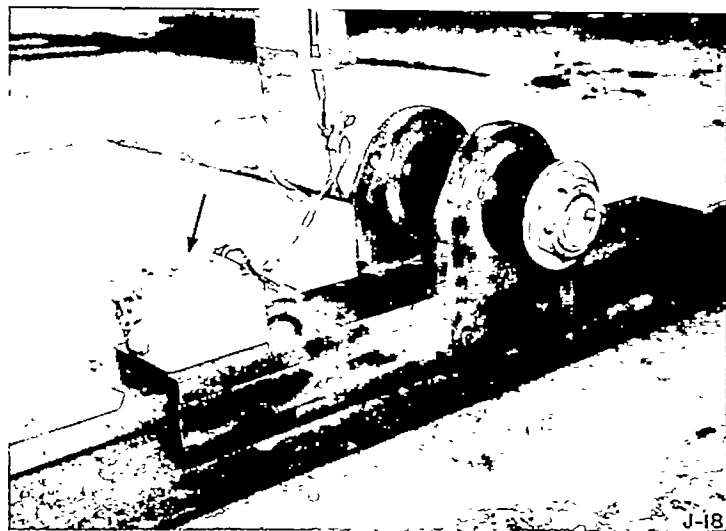

FIGURE 36.—Inerting-system switch.

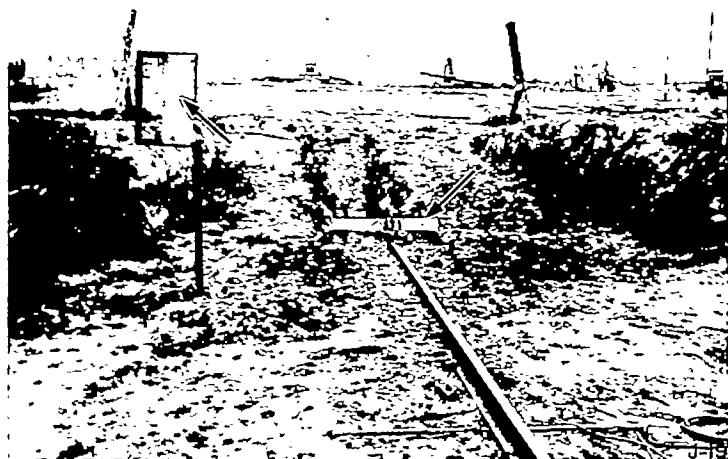

FIGURE 37.—Inerting-system-switch target.

rate. These time delays are listed in table II. A comparison can be made between these time delays and the earliest times following crash that fires were obtained with the various classes of ignition sources the inerting-system components were designed to cover (table II). This comparison shows that in every case except one, the inerting-system components came into operation before the corresponding ignition sources were observed to produce fire. The exception was the full closing of the fuel shut-off valve in 0.34 second with ignition of the contents of the engine induction system occurring within 0.1 second after crash impact. The fire-extinguishing agent attained full flow discharge in 0.06 second, however, and thus provided protection until the fuel valve closed.

In the first crash conducted with airplanes equipped with the inerting system and the standard crash barrier, fire occurred on both sides of the airplane. The circumstances under which these fires took place merit consideration in some detail. In this crash, the water-spray distribution manifold was supported from convenient mounts available on the engine. In the C-82 airplane employed in this phase of the study, the exhaust-collector ring is supported from the fire wall. Upon impact at the crash barrier, the right engine separated from its upper mount and dropped to the attitude shown in figure 38 (a). As a result, the water-spray manifold was carried away from the exhaust-collector ring affixed to the fire wall. The crash instrumentation showed that the fuel shut-off valve and electrical-system switch of the inerting system functioned properly. The fire-extinguishing-agent bottle was stripped from the engine with the carburetor assembly to which it was mounted.

Three-quarters of a second after crash impact, the instrumentation showed the situation existing in the nacelle illustrated diagrammatically in figure 38 (b), which depicts the pertinent nacelle accessory-section layout and location of the fire and vapor detectors. At this time, the only combustible mixture indicated was located close to the damaged fuel strainer fastened to the face of the fire wall at

the base of the nacelle. Apparently most of the fuel lost from the strainer ran down and out of the nacelle and left only a local zone of combustible mixture. The fire-detection thermocouples mounted close to the exhaust-collector ring were normally warmed by radiations from the collector ring. These thermocouples indicated a marked drop in the temperature of the exhaust-collector ring from the 10 to 12 o'clock positions, signifying that by chance some of the water spray was directed at this section of the ring and provided local protection.

At 2.2 seconds after impact, the instrumentation indicated no change in the situation within the nacelle. A photograph

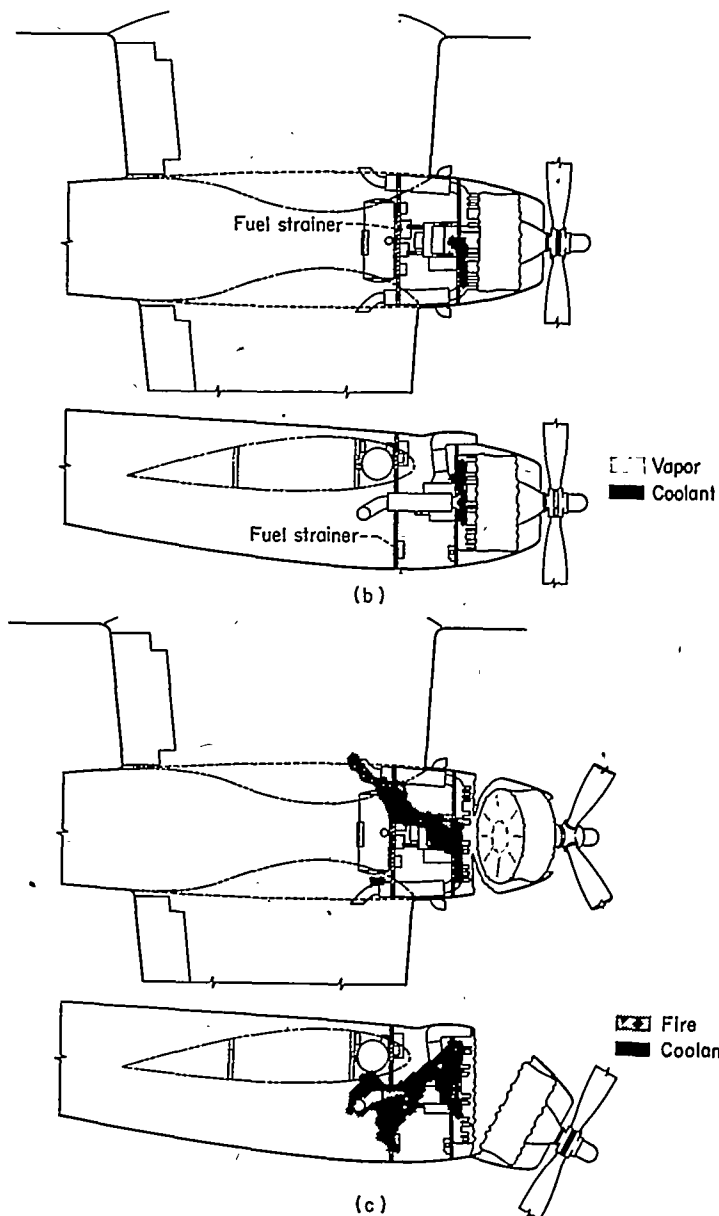

(b) Schematic diagram of nacelle showing location of combustible vapor and coolant in nacelle 0.75 second after initial impact.
 (c) Schematic diagram of nacelle showing fire indicated by detectors in nacelle 4.2 seconds after initial impact.

FIGURE 38.—Mechanism of ignition by hot metal of exhaust-collector ring.

of the airplane at this time (fig. 38 (a)) moving at approximately 60 feet per second shows the marked forward development of the fuel mist close to the ground and the vertical inclination of the engine and cowl. Some of the water spraying uselessly from the damaged water manifold can be seen projecting vertically from the nacelle. At 3.8 seconds after crash, the first evidence of fire appeared between the 12 and 1 o'clock positions on the exhaust-collector ring. The initial flame that appeared at this position did not show in the printed figure. In figure 38 (d) is shown the flame after it propagated to the 11 o'clock position.

At 4.2 seconds, fire-detector thermocouples first registered over the broad zone indicated in figure 38 (c). Failure of the fire-detection thermocouple to register at the 1 o'clock position on the exhaust-collector ring where the fire first appeared before 4.2 seconds is attributed to wetting by the

water spray. Instrumentation that recorded the actuation times of the inerting-system components showed that they functioned properly. Therefore, the unprotected exhaust-collector ring is the most probable ignition source, as is consistent with the visual evidence. Migration of the fuel mist to the inboard side of the nacelle was required in order for ignition to occur, because the top of the outboard segment of the exhaust-collector ring was under water-spray protection. That the fuel mist did extend to the inboard side of the nacelle is evidenced by the flame showing around the nacelle on the inboard side in the photograph of figure 38 (e), taken immediately after ignition.

On the left side of this airplane, the engine remained in place but fire was ignited by exhaust flames that were described under the section on the mechanism of fuel-mist development shown in figure 12. The exhaust flames that

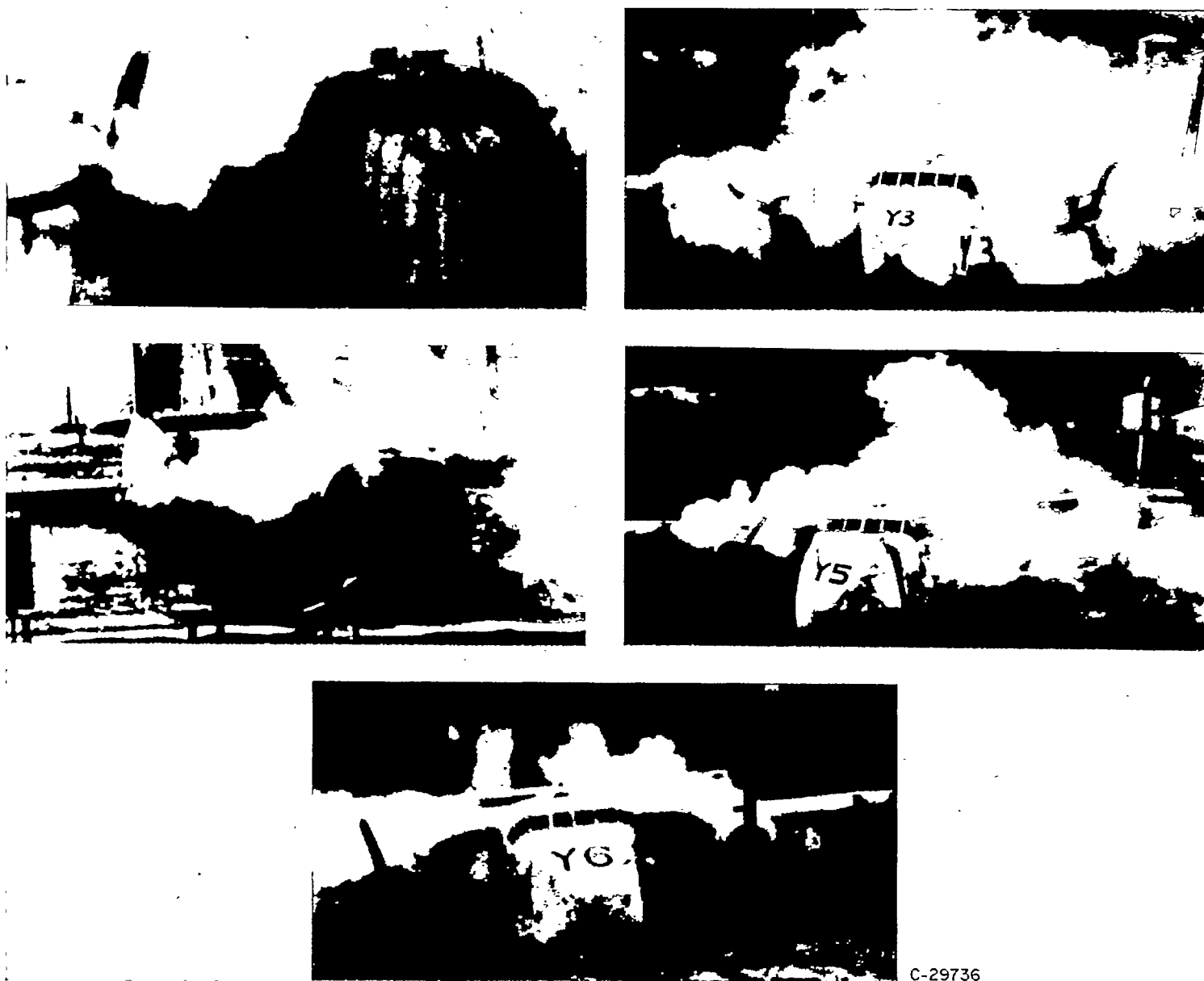

C-29736

FIGURE 40.—Appearance of airplanes following crash without fire.

were observed were provided by the burning of the fire-extinguishing agent employed in the engine induction system. The agent in this case was bromochloromethane (CH_2BrCl), known as CB. This material decomposes thermally at the temperatures of the engine exhaust-system metal, and some of the decomposition fragments released will burn in air. Photographs of this agent burning on the surface of a heated section of exhaust stack are shown in figure 39. In normal application during fire extinguishment, enough CB is employed to provide an inerting atmosphere around the decomposition products, and their ignition does not occur. In a crash, unfortunately, there can be no control of the quantity of extinguishing agent passing through the engine, because the displacement of the pistons meters the extinguishing agent throughput according to the engine rotational speed and the current throttle setting of the damaged engine, neither of which can be specified in a crash. Although high concentrations of CB were provided at the engine inlet of the crashed airplane, the quantity passed through the engine was small enough to allow a sufficient residence time for the CB in the high-temperature environment of the exhaust-disposal system to decompose thermally. Upon contact with the air at the tail-pipe exit, the decomposition products ignited to provide the series of exhaust flames shown in figure 12.

Halocarbons involving bromine and fluorine, in which complete substitution of hydrogen is obtained, would represent satisfactory fire-extinguishing agents for engine inlet inerting, because their decomposition products do not burn at engine metal temperature. Compounds in this class include trifluorobromomethane CBrF_3 and difluorodibromomethane CBr_2F_2 , which have recently become available in restricted quantities.

After the first crash in this series, the water-spray system was mounted to remain with the exhaust-disposal system should the engine be displaced, and carbon dioxide was employed at the engine inlet because it does not decompose appreciably at engine exhaust temperatures. In the next six crashes, one ignition occurred by the movement of fuel through the hot-air duct to the exhaust-gas heat exchanger, as was described in the discussion of liquid-fuel spillage. This result called attention to the need for more careful distribution of the water spray in the heat exchanger and to the desirability of a safety gate in the hot-air duct. After coming to rest, the other five unburned crashed airplanes carrying the inerting system appeared as shown in figure 40. The only visible evidence of the presence of the inerting system was the volume of water vapor issuing from the nacelle. On humid days, the condensed water vapor persisted in the atmosphere long enough to have the appearance shown in some of the photographs.



FIGURE 42.—Crash area for high-contact-angle crash.



(a) 0.3 second after initial impact.



(b) 1 second after initial impact.



(c) 1.7 seconds after initial impact.



(d) 2.3 seconds after initial impact.



(e) 3.0 seconds after initial impact.



(f) 3.7 seconds after initial impact.



(g) 4.7 seconds after initial impact.

Figure 41.—Ground-loop crash. (Fuel dyed red.)



Figure 43.—Damage to forestructure of airplane produced by impact with ground 0.72 second after impact with barrier in high-contact-angle crash. Airplane speed, 100 feet per second.



(a) Wheel strut in air before ignition 1.2 seconds after initial impact. Airplane speed, 75 feet per second.



(b) Ignition of fuel mist 2.4 seconds after initial impact. Airplane speed, 24 feet per second.



(c) Spread of fire 2.9 seconds after initial impact. Airplane speed, 15 feet per second.



(d) Spread of fire 3.9 seconds after initial impact. Airplane speed, 0.

Figure 41.—Ignition of fuel mist by electrostatic charge on landing gear in high-contact-angle crash. (Fuel dyed red.)

GROUND LOOP

After five crashes in which no fires were obtained and no new ignition sources were observed, modifications to the crash barrier were employed in an effort to reveal new mechanisms of crash-fire initiation. In one crash, a ground loop was imposed on the crashed airplane by allowing the right wheel and left wing to pass through the crash barrier without damage. (The abutment on the right side of the airplane and the poles on the left side were removed.) The airplane, with known ignition sources inerted as before, ground-looped as desired, taking on the successive attitudes shown in figure 41. In executing the ground loop, the airplane exposed the long axis of the nacelle and fuselage to the fuel mist generated at the leading edge of the right wing and increased the interception of the fuel by these airplane members over that obtained when ground looping does not occur. Displacement of the fuel mist toward the nacelle on the right is promoted by the large spanwise component of the relative wind in the direction of the nacelle accompanying the yawed attitude of the airplane in the ground-loop maneuver. No new ignition sources were revealed, however, and fire did not occur.

HIGH-CONTACT-ANGLE CRASH

In order to determine whether or not ignition sources are created by the mechanical rending of the aircraft structure in a severe impact, another crash was conducted in which a 16° contact angle between the airplane and the ground occurred. The ground beyond the crash barrier, on which the airplane comes to rest, was sloped and hollowed to give the desired angle of contact. A photograph of the crash area arranged for this crash is shown in figure 42. The crash barrier was maintained in its standard configuration with two abutments and poles for the wing tanks on both sides of the airplane. The known ignition sources were inerted in the usual manner. The marked damage to the forestructure of the airplane upon impact with the ground is evident in figure 43, taken 0.72 second after impact with the barrier. Extensive coverage of the airplane with fuel occurred as in figure 16, which shows photographs of the fuel-mist development experienced in this crash. Because of the time lag associated with the movement of fuel out of the tanks, the time of the maximum forward surge of the fuel follows the period of peak airplane deceleration by 1.1 seconds.

The fact that no ignition of the fuel occurred around the deforming structure indicates the absence of ignition sources of sufficient duration to ignite the fuel in this instance. Ignition sources covered by the inerting system were inactive in spite of the severe nacelle damage sustained. As the airplane slowed to rest, however, the left wheel strut tumbling through the air behind the airplane (fig. 44 (a)) ignited the fuel in the airplane's wake when the strut approached the ground approximately 60 feet behind the left wing (fig. 44 (b)). The fire moved through the fuel mist and liquid fuel on the ground (fig. 44 (c)) toward the airplane, where ignition of the fuel in the wings exploded

both wings (fig. 44 (d)). The flame-propagation rate through the fuel mist around the airplane was determined as 75 feet per second with a 30-foot-per-second tail wind, or a net speed of 45 feet per second (fig. 45). This high rate of flame propagation includes the velocity imposed on the flame front by the expanding burning mass of fuel and air. The large column of fuel mist suspended in the air is evident from the volume of fire shown in figure 44 (d).

From inspection of the terrain in the crash area and inspection of the wheel-strut assembly, it was concluded that the ignition source was neither friction sparks nor compression ignition of the hydraulic fluid in the wheel strut. However, investigation of the electrostatic charge collected on the wheel-strut assembly by friction with the dust and the fuel mist in the airplane wake showed that the ignition in this



FIGURE 45.—Contour of fire propagation through fuel mist after ignition in high-contact-angle crash.

case was most likely produced by electrostatic discharge from the strut to the ground. Studies were made with the same wheel and strut, electrically insulated from the supports, as shown in figure 46. Air was blown over the wheel and strut assembly by the blower shown in the figure, and dust was metered into the air stream. A dust flow rate of 400 grams per second with an airspeed of 45 miles per hour past the strut generated 3900 volts, sufficient to produce sparks capable of fuel ignition in less than 0.75 second (fig. 47). In the crash, the wheel and strut traveled through the air at 43 miles per hour for 1 second, bounced on the rubber tire, and then traveled through the air for another 1-second period at approximately the same speed.

In summary, of all the ignition sources observed during this investigation, 41 percent would have been eliminated by induction-system inerting and fuel shut-off; 41 percent by inerting and cooling of the hot exhaust-system metal; and 14 percent by de-energizing the electrical system. However, if only part of the inerting-system components were used, these percentages would change materially, because the combustible would move to the next available ignition

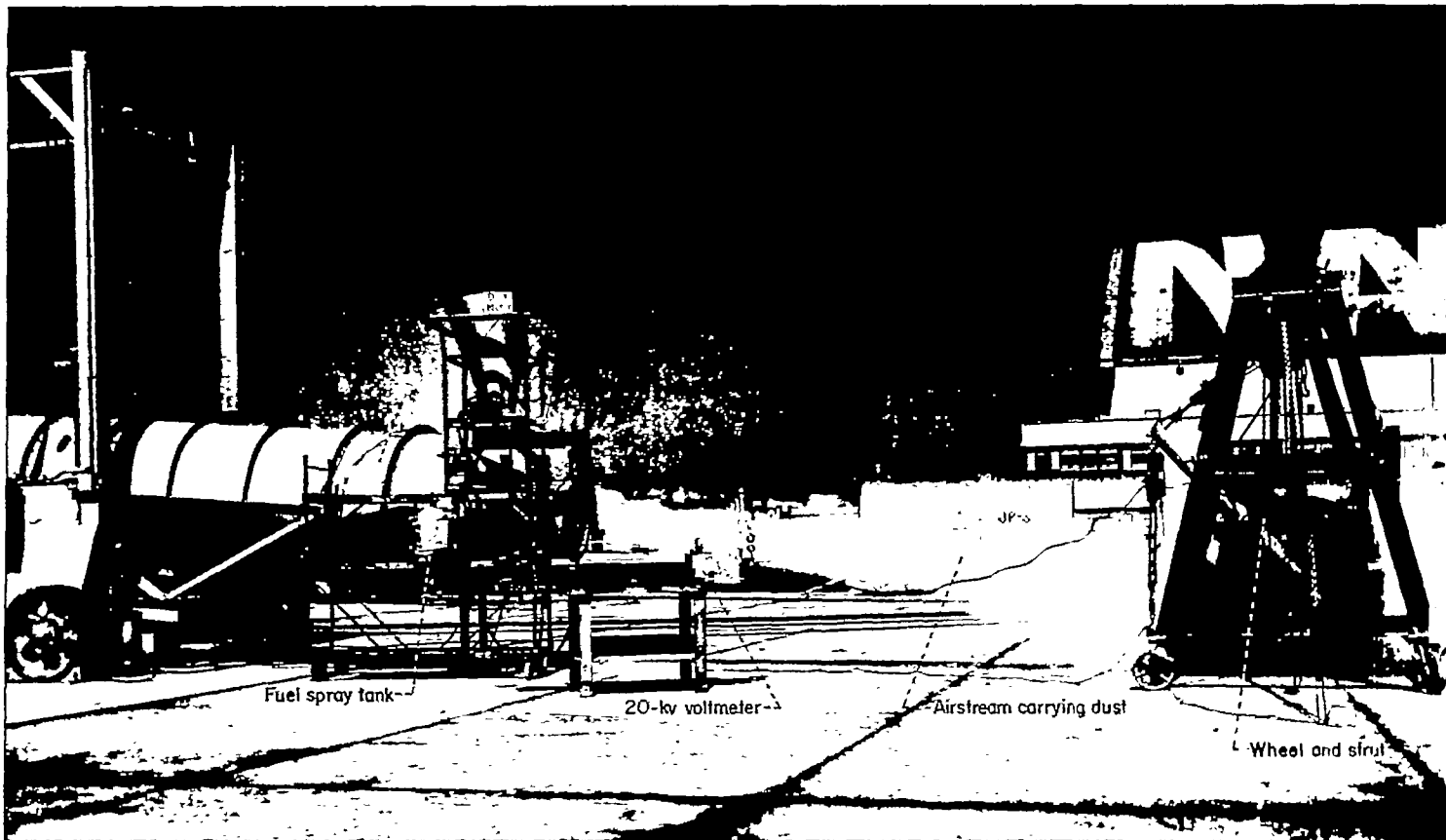
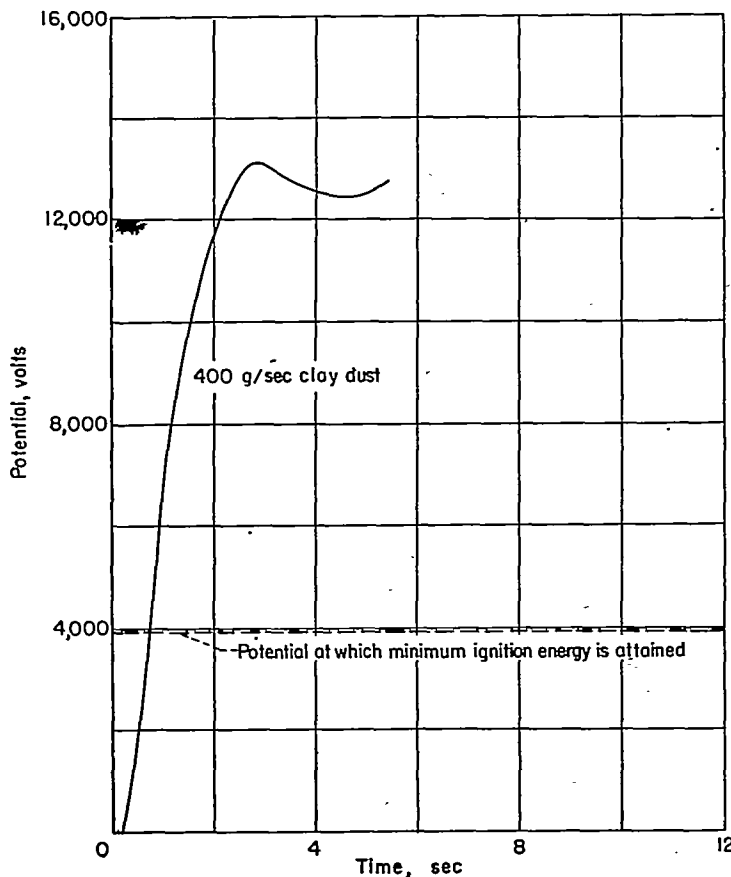

FIGURE 46.—Test setup to determine rate of accumulation of electrostatic charge on a landing-gear strut.



source. This fact is demonstrated in the case of the crash fire illustrated in figure 38. In this case, the electrical system was de-energized, the induction system was inerted, and the fuel to the engine was shut off. However, the exhaust cooling system pulled away from the exhaust system and did not function. Under these circumstances, the fuel mist spread until it contacted the hot exhaust system and ignited. Thus, caution must be used in evaluating the effectiveness of the inerting system when only portions of the system are used. Undoubtedly, in some crash circumstances benefit could be derived by the use of only parts of the inerting system.

FIRE DEVELOPMENT

The progress of the fire following ignition of the fuel tank is some aspects that are common to all crash fires and others that depend on the distribution of the fuel spillage preceding ignition, the wind magnitude and direction, the slope of the ground on which the airplane comes to rest, and the location of the opening in the fuel system from which the fuel issues. A complete description of the progress of crash fire as it is influenced by all of these factors and the conditions

FIGURE 47.—Voltage produced on insulated landing gear by blow of clay dust at 45 mph. Leakage resistance, 0.5×10^{12} ohms; capacitance, 200×10^{-12} farad.

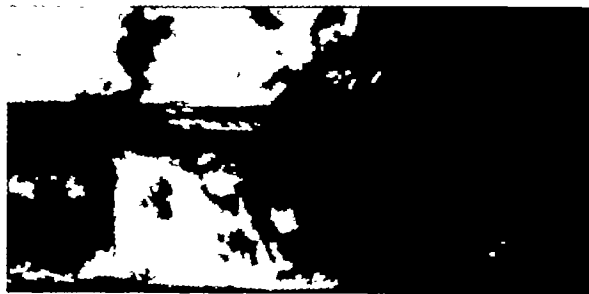

Figure 50.—Burning fuel pouring from rupture in wing fuel tank.



Figure 51.—Explosion of wing due to ignition of fuel vapors in wing and wing tanks.



Figure 52.—Build-up of fire resulting from wing explosion. Photograph taken 0.7 second after photograph of figure 51.

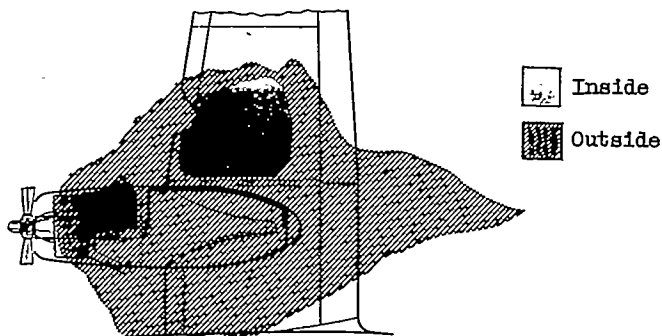

Figure 53.—Schematic diagram of fire burning inside wing and nacelle as compared with fire outside airplane.



(a) 0.9 second after ignition.



(b) 4.0 seconds after ignition.

Figure 54.—Flame movement through fuel on ground behind airplane.



(a) Fuel mist fire at its maximum; 3.0 seconds after ignition.



(b) Fuel mist fire with rising column of smoke and burning core of fuel mist; 5.3 seconds after ignition.



(c) Fire from fuel evaporating from wetted surface of airplane and ground; 10.0 seconds after ignition.



(d) Fire produced by fuel that soaked into ground vaporizing and burning in column continuous with burning fuel from tanks; 10.0 seconds after ignition.

Figure 55.—Rapid burning of fuel mist.



Figure 56.—Magnesium portions of engine burning during crash.



FIGURE 57.—Flames from burning fuel in wing tanks licking sides of fuselage.

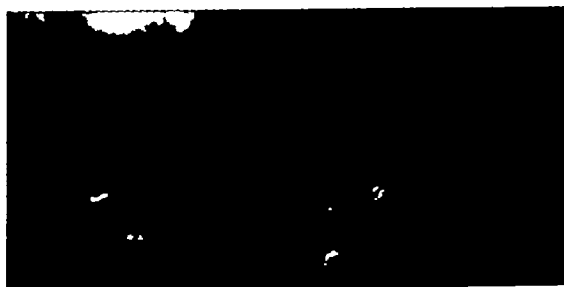

(a) Fire before explosion.



(b) Build-up of fire due to spread of flaming hydraulic fluid.

FIGURE 58.—Fire produced by exploding hydraulic-landing-gear strut.

figuration the airplane assumes in the crash cannot be attempted here. A discussion of some of the main events observed to occur in the crash fires studied will be given, however, in which some of the factors influencing the development of the fire are considered.

In a crash, the fuel system may be broken open by impact of the airplane with obstacles such as trees, posts, boulders, and so forth, that rip holes in tanks; by hydraulic forces generated by the surging fuel contained in the tanks of the decelerating airplane; by flying debris released in the crash, particularly propeller blades, that may cut fuel lines (fig. 48) and strainers, or pierce fuel tanks (fig. 49); and by the relative displacement of airplane components as, for example, the parting of an engine from its mounts and consequent snapping of the carburetor fuel line. Fuel lines, likewise, may be burned through by oil, hydraulic fluid, or alcohol fires. Since there is usually a continuous path of fuel in liquid, mist, or vapor form from the point of spillage to an

ignition source, the fire moves from the ignition source back to the fuel-system rupture from which the fuel issues. This step in the propagation of fuel fire is common to all crashes. The fire burns at the opening from which the fuel issues and ignites the fuel as it leaves. The column of fire shown in figure 50, for example, is ignited fuel pouring from the wing. The fire at the fuel-system leak enlarges the opening and tends, thereby, to increase the fuel efflux rate.

When wing fuel tanks are ruptured, combustible concentrations of fuel vapor often accumulate in the voids around the tanks. Under these circumstances, a wing explosion occurs when the fire reaches the wing. A picture of such a wing explosion is shown in figure 51. The wing skin is generally stripped off to the wing tips as shown in the figure. A marked acceleration in the development of the fire accompanies such explosions because of the broad distribution of the wing-tank fuel that results. A typical example of such accelerated fire development followed the wing explosion of figure 51. In 0.7 second following the explosion, the fire appeared as shown in figure 52.

Fire often burns within the wing without explosion. In this case, the burning rate is governed by the air flowing into the wing. Because of the limitation of available air, the internal wing fire is often of modest proportions and tends to locate near the vents through which the air enters. The extent of one internal wing fire, determined by a grid of thermocouples located in the wing, is shown in figure 53 as the solid area. The limited size of the fire is in contrast to the extent of the fire around the wing shown as the cross-hatched area of the same figure.

In the first few seconds following ignition, the fire propagates also through all the fuel spilled previous to ignition. The fuel suspended in the air as mist ignites and the fire spreads with lineal flame-propagation speeds up to approximately 70 feet per second. This high flame-propagation speed is provided in part by the rapid expansion of burning atmosphere of fuel mist and air. The flame speed through the fuel on the ground along the skid path of the airplane and on the wetted airplane surfaces is somewhat reduced over that obtained through fuel mist, particularly if the propagation is against the wind. Two photographs of flame movement through the fuel on the ground behind the airplane 0.9 and 4.0 seconds after ignition are shown in figures 54 (a) and (b), respectively. The flame speed in this case is approximately 13 feet per second. The fire-spread along the fuel-wetted surfaces of the airplane wings, fuselage, and tailbooms occurs in a manner similar to the ground fire-spread.

If ignition occurs while appreciable fuel is suspended in the air as mist, the heat released from its combustion often represents most of the total heat release in the early phase of the fire. Because the fuel in the mist is dispersed through a large volume of air, each droplet is surrounded by a sufficient quantity of air to burn a significant portion of the droplet. The fuel mist is consumed rapidly, therefore, and



FIGURE 48.—Fuel line cut by flying propeller tip.

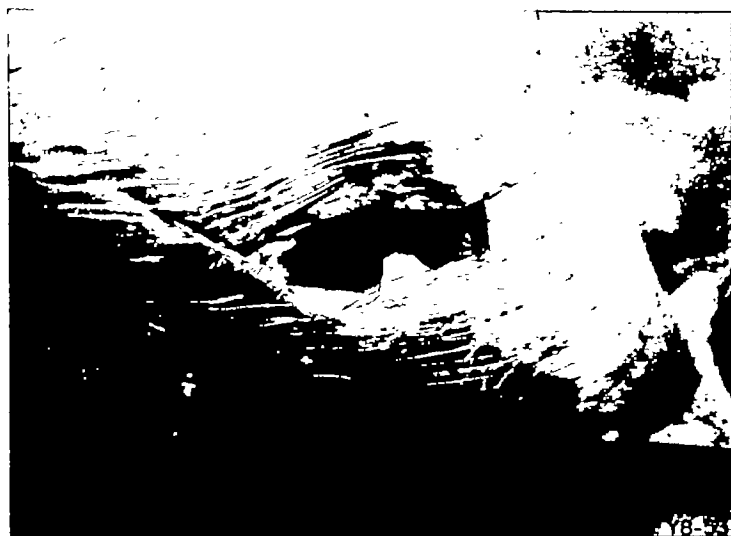

FIGURE 49.—Wing fuel tank ruptured by flying propeller tip.

seldom persists for more than 20 seconds. The fuel-mist fire at its early development, shown in figure 55 (a), 3.0 seconds after ignition, appears as a solid wall of flame extending 45 feet behind and 65 feet above the airplane. The heated fuel mist rises as it burns. The heat radiated to the airplane from burning fuel mist lessens rapidly as the fuel mist rises and acquires at the same time an envelope of opaque black smoke characteristic of petroleum fuels (such as gasoline) burning in the open air. In this phase the mist fire has the appearance shown in figure 55 (b), 5.3 seconds after ignition. The burning core of mist, visible in the figure, is the last to burn out and leaves the fuel evaporating from the wetted surface of the airplane and the ground to continue the fire as shown in the photograph of figure 55 (c).

Of the fuel spilled on the ground, a large portion soaks rapidly into dry unfrozen soil. When the crash takes place on sloping ground, as in the studies conducted here, the pools of fuel that collect are quite shallow, and only during the first few minutes after the crash are there appreciable quantities of liquid fuel exposed in the airplane slide path to provide combustible vapors in large quantities. For a few seconds after the fire starts, these vapors rise and burn to form a column continuous with the burning fuel-mist mass. The lower portion of the towering column of smoke and fire shown in figure 55 (c) is provided by this vaporized fuel. Some of the fuel that soaked into the ground released vapors at a sufficient rate in the hot environment of the fire to maintain small fires that burn close to the ground for several minutes after the fire starts (fig. 55 (d)).

Following the initial rapid consumption of the fuel that is spilled on the ground and suspended in the air while the crashed airplane is in motion, the fire shrinks to the zones adjacent to the airplane with a marked reduction in the heat radiated to the surroundings. Close approach to the burning airplane can now be made by normally clothed personnel. The air temperature at ground level close to the fire differs little from the normal air temperature, since the air heated by the fire rises overhead with the smoke and flames. Radiation from the flames and hot metal of the airplane structure may be intense, but can be tolerated by unprotected skin for several minutes. At this stage, the fire on the outside of the airplane is fed by fuel pouring from the damaged tanks and seeping through the seams on the lower surfaces of the wings; by oil from the fire-damaged or mechanically damaged lubricating system; by hydraulic fluids from the brake and wheel-strut actuating system; and by the aluminum skin and structure, the fabric skin, and the magnesium engine parts. The oil fires lie close to the engine nacelle where the oil distribution system and tanks are located. Once ignited, the magnesium engine parts continue to burn with the characteristic blue-white flame even after the surrounding fuel or oil fire subsides (fig. 56). The aluminum parts, particularly the skin, ignite early in the fire. The aluminum burns only in the high-temperature environment provided by adjacent fire. On the ground close to the fire, rivulets of molten aluminum form and flow by gravity to cooler zones and solidify.

After the flash fire that spread through the fuel spilled previous to ignition burns out and the fire is localized in the immediate area of the airplane, the relatively slow propagation of the fire provided by ignited fuel pouring to the ground and through the wing structure becomes apparent. This burning fuel, running by gravity, spreads the fire to areas not wetted by fuel in the initial fuel spillage while the airplane was in motion. If the ground slopes downward from the wings to the tail, this burning fuel will flow on the ground along the outside of the passenger compartment of the fuselage. Contact between the fuselage skin on the ground and this fuel may occur, depending on the direction taken by small ground grooves and sinuous channels. Such grooves and channels are formed by vegetation and soil erosion usually present on the ground or are plowed by the dangling airplane parts, such as propeller blades or broken wheel struts. The distance this ground-flowing fuel will extend from the fuel-tank source in these grooves and channels depends largely on the fuel flow rate and the rate of ground absorption of the fuel. The fuel fire spread in this way is maintained for many minutes, fed continuously by the fuel pouring from the tanks. Burn-through of the fuselage skin is almost a certainty if contact between fuel stream and fuselage occurs. Loss of the skin by fire burning from fuel streams that extend parallel to the fuselage without contact can occur if the local wind bends the flames to lick against the fuselage skin in the manner shown in figure 57. If the ground slopes downward toward the nose of the airplane, the fuel flows away from the passenger section of the fuselage and fire destruction of this member does not occur by the mechanism just described.

The airplane fire reaches several secondary peak intensities before it finally burns out. Barring explosions, the first of these peaks usually occurs when the fire burning at the fuel tanks enlarges the openings from which the fuel issues or opens undamaged tanks and increases the rate of fuel spillage. Such enlargement of the fuel-tank openings or burn-through of otherwise intact tanks, below the fuel level, will occur sooner with bladder-type tanks than with metal tanks which have good thermal conductivity. The cooling provided by the fuel in the tank retards burning of the tank walls. Wing explosions are usually followed by a marked resurgence of the fire because of the associated fuel scattering (figs. 51 and 52). Such explosions may occur when the fire first propagates to the wing from the point of ignition or after the wing fire has been in progress. Wing explosions that occur after the wing fire has developed are usually less violent than the explosions that sometimes accompany the first ignition of fuel within the wing. Exploding elements of the hydraulic system, such as wheel struts softened in the heat of the fire, will spread flaming hydraulic fluid with spectacular effect (fig. 58).

When the fire burns through the fuselage skin and the combustibles within are made available, the fire development achieves another peak. Exploding hydraulic-system accumulators add the hydraulic fluid to this fire and promote



(a) Smoke and hydraulic oil vapors issuing from fuselage nose.



(b) Resulting fire after burn through of skin of fuselage nose.

Figure 59.—Development of hydraulic fluid fire within fuselage.



Figure 60.—Cross-over of fire from one side of airplane to other through canopy of fuel mist.

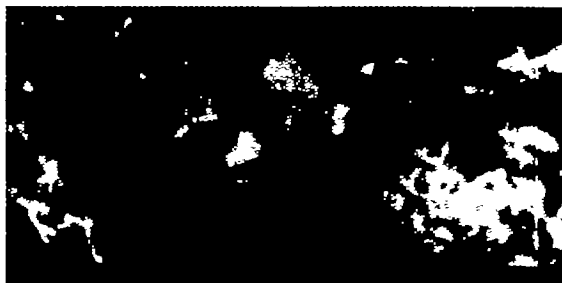

Figure 61.—Fire produced by explosion of both wings; 1.0 second after ignition.

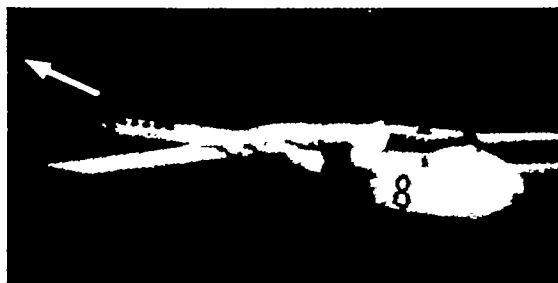

Figure 62.—Burning fabric on tall surfaces ignited by fuel-mist flash fire.



(a) Fire burning on ground on right side under empennage of airplane 78 seconds after ignition of left side of airplane.



(b) Progress of fire burning on ground on right side 84 seconds after ignition of left side of airplane.



(d) Ignition of fuel in right wing tanks 107 seconds after ignition of left side of airplane.

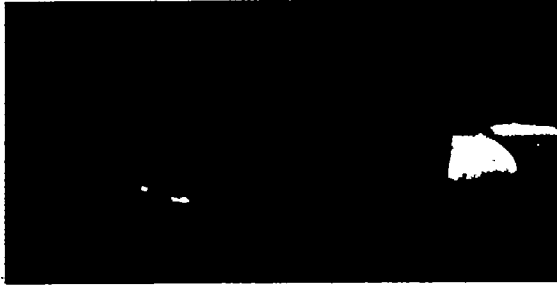

(c) Ignition of fuel pouring from right wing tanks 98 seconds after ignition of left side of airplane.

Figure 66.—Cross-over of fire from left to right side of airplane through fuel trail left on ground by airplane.

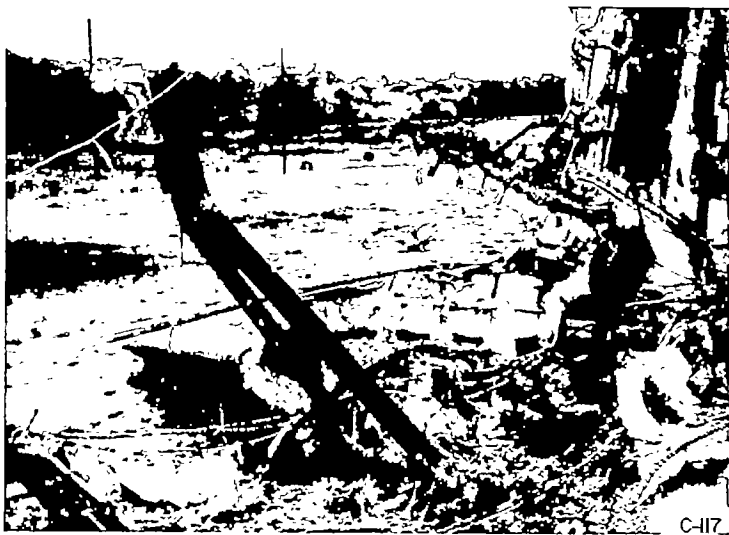

FIGURE 63.—Structural elements melted in a typical crash fire.

ts spread inside the fuselage. The fire within the fuselage burns slowly at first if the fuselage is essentially intact and limited combustion air is available. At this time, large volumes of smoke, representing condensed and partially burned hydraulic-oil vapors and other volatile materials, are often observed issuing from the fuselage, as shown in figure 59 (a). As the fuselage skin is consumed in the fire, access for additional air develops, with a corresponding further fire development. When a large hole burns through the skin at the top of the fuselage, the air flow is further promoted by chimney action. The fuselage fire attains its peak at this time. A view of the fuselage fire (fig. 59 (b)) shows the combustible smoke that issued earlier from the fuselage (fig. 59 (a)) burning with a bright flame. The appearance of flame at the door frame shows the fuselage being consumed by fire from within.

The last fires to burn out are often those from fuel that runs under the airplane fuselage where it burns slowly with restricted air supply, oil around the oil tank and nacelle, magnesium engine parts, and rubber tires of the landing wheels.

Progressive collapse of the main airplane structure not damaged in the crash impact occurs in the fire as main supporting elements are burned, melted, or softened by the heat. Structural elements melted in the fire show the sharp-edged and pointed stalactites of fused aluminum illustrated in figure 63. Typical of structural collapse by fire is the failure of the tailboom shown in figure 64.

At times, with fuel spillage on both sides of the crashed airplane, fuel ignition occurs on one side only. Cross-over of the fire from one side to the other appears to be possible through the canopy of fuel mist that often forms above and slightly behind the crashed airplane, although it has not been observed in the crashes conducted so far. The conditions necessary for a cross-over of fire through the fuel mist are shown in figure 60; however, in this case cross-over did not occur, because of the rapid development of the fire on the

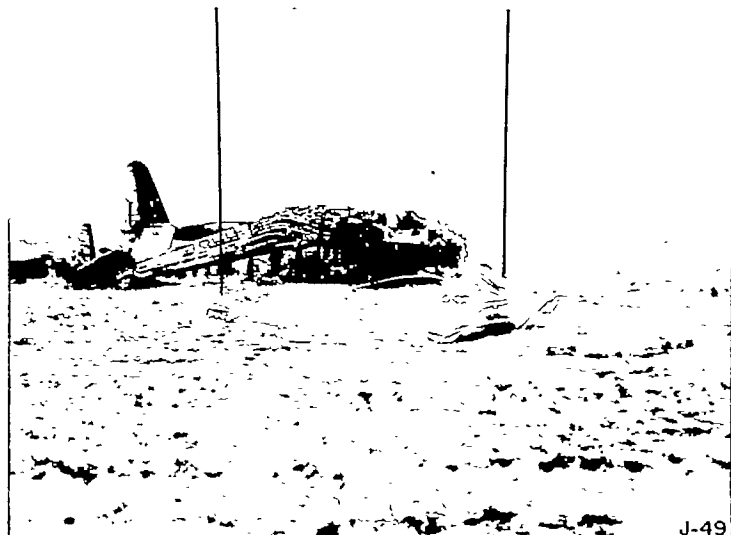

FIGURE 64.—Structural collapse due to melting and burning of skin and structural members.

left side of the airplane. A map of the progress of this fire during the first second following ignition as the flame propagates from the right nacelle towards the left side of the airplane is shown in figure 65. The family of curves in the figure represent the outline of the fire in 0.1-second intervals, starting at the right nacelle and later at the left engine tail pipe. These data show an average vertical rate of propagation of the fire of 60 feet per second and a uniform horizontal rate of 25 feet per second over a 0.6-second period. Explosion of both wings occurred just as this flame pattern was established and produced the fire shown in figure 61.

Cross-over of fire did take place, however, along the liquid-fuel path left in the trail of the crashed airplane and on the airplane itself. In one crash of an airplane carrying fuel of low volatility (8 mm Hg Reid vapor pressure), fire occurred on the left side, as shown in figure 19 (c). The fire, as it appeared on the right side as the airplane came to rest, is shown in figure 62. Only the fabric of the empennage, control surfaces, ignited by the fuel-mist flash fire, is burning on this side. Fire traveled to the right side of the airplane along the rivulet of fuel running from the right-wing tanks downhill to the fire burning in the skid path of the airplane on the left side 60 feet behind the airplane empennage. The fire that moved along this fuel rivulet on the ground is shown in the succession of photographs in figure 66. The right wing became involved in the fire approximately 107 seconds after the crash. That propagation of the fire forward through the thin mist of low-volatility fuel suspended in the air on the right side of the airplane did not occur is probably related to the relative advantage that low-volatility fuel confers under these circumstances, as shown by the data on maximum distance from the mist source for upwind flame propagation (fig. 22).

The history of the crash fires obtained with fuel of low volatility was identical to that involving gasoline. The large heat release from the burning fuel mist raised the

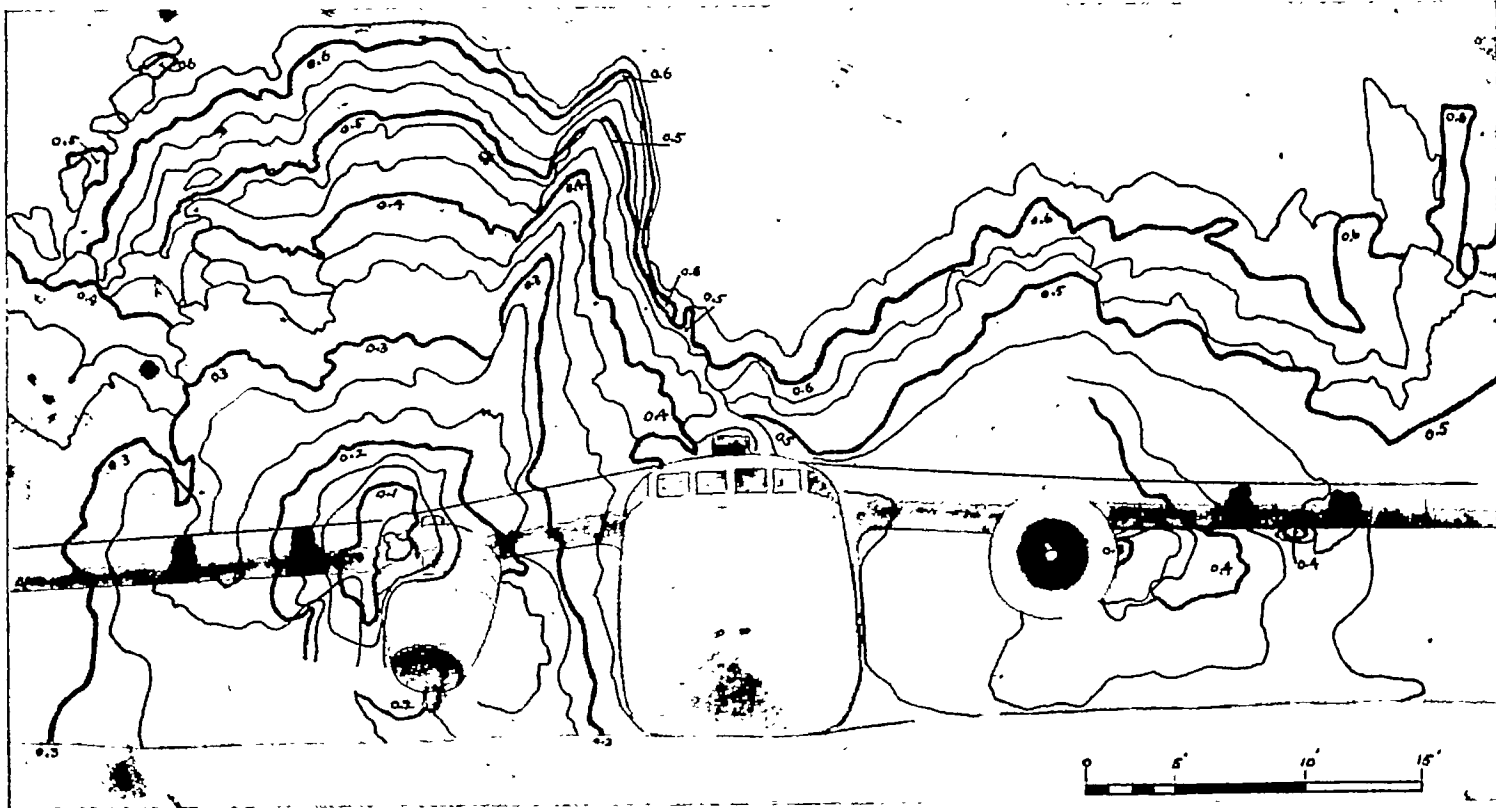

FIGURE 65.—Map of progress of fire following ignition as it appears to camera viewing airplane head-on. (Numbers refer to time after ignition in seconds.)

temperature in the airplane zone, and differences in fuel volatility measured at normal atmospheric temperature were no longer significant in this high-temperature environment. In crash fires with fuels of low volatility in which large masses of burning fuel mist are not involved, some advantage in the rate of fire spread may be gained in the early phase of the fire. Once the fire propagates back to the source of the fuel and ignites the fuel as it is released from the fuel system, the rate of fire development depends primarily on the fuel-spillage rate, with fuel volatility being of secondary importance.

The course of the crash fire described is related to those fires involving fuel spilled in the manner imposed in these full-scale studies. Except for the early fire through the fuel mist and fuel on the ground in the skid path of the crashed airplane, however, the development of the fire described is similar in main events to transport crash fires recently observed in which little fuel spillage preceded ignition.

CONCLUDING REMARKS

It is evident from the manner in which these full-scale crash studies were conducted that no evaluation can be made of the relative frequency with which the various ignition sources will initiate fires in crashes that occur in civil and military operations. Such information must come from airplane operational experience, with great doubt always pres-

ent because of the inaccuracy of observations on the initiation of the crash fire. In view of the diversity of ignition sources revealed by this crash study with a given airplane and fixed experimental crash conditions, it is difficult to make such a comparative evaluation even if the obstacles and nature of the terrain involved in the airplane crash are specified. If a detailed description of the airplane damage could be specified, however, along with the order in which the damage was imposed, the state of the airplane motions, the wind, and the contour of the crash site, some approximation of the relative likelihood of fire initiation by a particular ignition source could be made on the basis of the information obtained from this crash study.

The same observations apply to an evaluation of the margin of crash-fire safety that the use of fuels of low volatility will provide as compared with the use of gasoline in the airplane. These crash-fire studies demonstrated only some of the circumstances under which fuel volatility does not matter in fire initiation and indicated the possibility of other conditions for ignition that would not be influenced by fuel volatility. The relative frequency with which these circumstances appear in actual crashes cannot be estimated on the basis of this work with a sufficient order of accuracy to obtain a meaningful estimate of the value of fuels of low volatility in reducing the crash-fire hazard. Some little significance may be attached to the fact that, of four airplanes crashed with low-volatility fuel, two did not burn; whereas, fires

were obtained with almost all (six out of seven) airplanes crashed with gasoline when ignition-source inerting was not employed. However, in one of the crashes with low-volatility fuel in which no fire occurred, both engines were ripped from their mounts at the crash barrier and did not spend a sufficient time in the fuel mist behind the airplane to provide an ignition on the exposed hot exhaust-collector rings. The low-volatility fuel has a spontaneous-ignition temperature equal to, or slightly less than, aviation-grade gasoline. A surface hot enough to ignite gasoline in a given contact time could certainly ignite the low-volatility fuel in the same time. It is believed that fuel volatility was not the factor determining whether or not fire did occur in this case.

In the second of the crashes with low-volatility fuel in which no fire occurred, the engine ignition was cut while the airplane was in its full-power taxi run 2 seconds before reaching the crash barrier. Little nacelle damage occurred, because the propellers struck the barrier at reduced speed and no engine power. A small oil fire appeared in the left nacelle from lubricating oil burning on the exhaust-collector ring. No other combustible spillage occurred within the nacelle. The nacelle cowl was intact. The quantity of oil involved in the fire was quite small, and the fire did not appear outside the nacelle except for a brief flash $1\frac{1}{3}$ seconds after crash on the inboard side of the left nacelle. At this time, the airplane was moving too fast for the fuel to extend from the wing-tank rupture to the inboard side of the nacelles. Because it is difficult to determine from the motion pictures whether or not the fuel ever did extend to the nacelle and because the fuel does not have sufficient vapor pressure to be detected by the combustible-vapor detectors, it cannot be stated with certainty that no fire would have occurred if gasoline had been used in this crash. Some advantage from the use of low-volatility fuel may be indicated in this case. The results obtained in this crash study indicate that the use of low-volatility fuel does not in itself represent a wholly acceptable solution to the crash-fire problem.

The modes of fuel distribution to ignition sources in a crash revealed in this study indicate that, with regard to fuel spillage in liquid form, some crash-fire safety can be provided in airplane design. Any feature of wing design promotes crash-fire safety that effectively impedes the flow of wing-spilled fuel toward the engine nacelle and wheel well and provides for the drainage of this fuel at some relatively safe location at the trailing edge. Fuel running by wetting conduction likewise is effectively intercepted by any pronounced chordwise ridge or crease in the lower wing skin that serves as a drip fence (fig. 67). This drip fence is particularly desirable for intercepting fuel flowing by wetting conduction to the engine exhaust (see fig. 27). It is unfortunate with respect to crash-fire safety that such discontinuities in the wing surface do not appear in normal wing construction. Wing tanks currently under development, which do not burst under the hydraulic loading experienced in a crash, will obviously reduce the probability of crash fire by fuel spillage within the wing.

In crashes in which the wing tanks are pierced by posts or equivalent objects, however, fuel spillage will occur regardless of the material or construction of the fuel tank and the method of its support. Because the fuel mist generated when this type of fuel-system damage is imposed represents such a serious fire hazard, any measure that impedes the flow of the fuel through the tank breach lessens the fire danger. The fuel-flow impeding action desired should be equivalent to that which would be obtained if the fuel tanks were divided into small interconnected cells. In regard to the hazard of fuel-mist ignition, the greater the distance spanwise, aft, and down the fuel is stored with respect to the engine, the lower the likelihood of contact between fuel mist and ignition sources at the nacelle. The total storage of fuel in pod tanks suspended below the wing at a station 10 feet or more spanwise from the engine nacelle would lessen the likelihood of fuel-mist spread to the nacelle in a crash. Flow of the liquid fuel through the wing structure or by wetting conduction is avoided with this type of fuel storage.

The role that electrostatic charge accumulated on parts of a crash airplane plays in setting a fire, as revealed in this study, may explain the origin of some of the fires started in the wake of crashed airplanes on airport runways. Reports of such fires attributed them to friction sparks. Electrostatic discharge from debris trailing the airplane may represent another ignition means for these fires. Currently available paints that give some protection against electrostatic sparks may provide effective control of this fire hazard when applied to those lower members of the airplane likely to be separated in a crash. Because little electrostatic charge is accumulated by blowing dust when the relative humidity is above 70 percent, fire from this source is more likely to occur on clear dry days than on humid days. Crash landings on damp ground or ground well covered by green vegetation where little dust is raised around the skidding airplane should be relatively safe from ignition by dust-generated

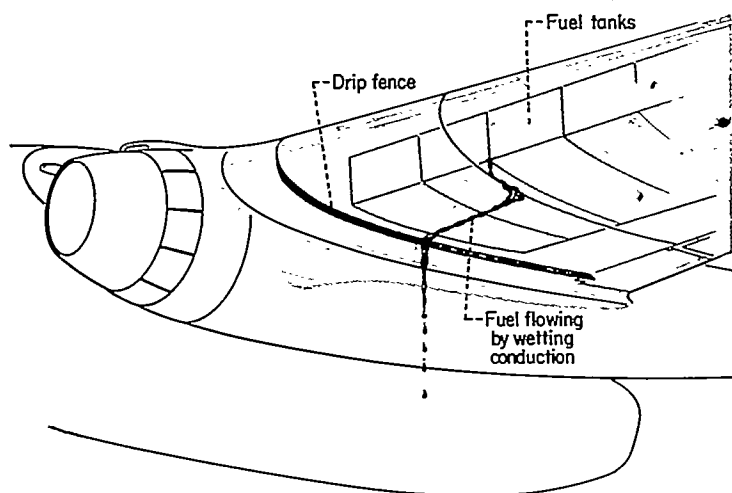

FIGURE 67.—Drip fence to prevent spanwise flow of fuel from fuel tanks to nacelle by wetting conduction on lower surface of wing.

electrostatic discharge. When sufficient time is available, light wetting down of an airfield site where a difficult landing is to be made is a good precautionary measure. Friction sparks of sufficient size and temperature to ignite fuel can be obtained from steel or magnesium airplane parts abraded under high contact pressure with stony ground or concrete paving. It is desirable in regard to crash fire that, whenever possible, these metals be in areas of the airplane not likely to scrape along the ground in a crash. The use of non-sparking materials for nuts, bolts, pitot tubes, drains, etc., that may be in ground contact in a crash would be advantageous.

These studies show how readily any combustibles spilled within the nacelle are ignited; therefore, it is desirable that the components of the fuel, lubricating, and hydraulic systems be located high in the nacelle where crash damage to these components is least likely. Oil coolers and fuel strainers often have vulnerable positions in the nacelle. Tubing containing combustibles should be arranged to accommodate the nacelle distortions produced in crash.

The action a pilot may take just previous to crash to lessen the likelihood of fire depends on the circumstances of the pending crash. Certainly, the less fuel carried by the airplane into the crash, the smaller the probability of fire. Experience gained in this crash-fire study indicates that in the event that a crash is likely, the engine fuel valve should be closed rather than the engine ignition turned off. There is no assurance that fuel flowing through an engine will not ignite if the engine ignition system is turned off. Hot cylinder-valve components or the exhaust-disposal system can provide the ignition that may result in a flame from the engine induction-system inlet or exhaust-system tail pipe. Evidence that such ignition does occur appeared in the crash previously described in which the engine switch was turned off 2 seconds before crash impact. Immediately after the ignition switches were turned off, a sequence of exhaust flames appeared, one of which is shown in figure 7 (c). At 2.2 seconds after impact the flames shown in figure 7 (b) were observed at the engine induction-system inlet. It appears more desirable, rather, to close the engine fuel valve before crash with the engine ignition system operative. By these arrangements, the fuel that dribbles into the engine burns in the normal way in the engine cylinder with less chance for producing undesirable exhaust or engine inlet flames. Several revolutions of the engine usually suffice to exhaust the fuel in the engine induction system, and, from then on, the engine ingests only air. If time permits after the available engine fuel is exhausted, engine ignition shut-off may provide an extra margin of safety. Modern aircraft ignition systems are so well protected by the engine parts that damage to the system while the engine is rotating and driving the magnetos does not appear very probable. When fuel shut-off cannot be achieved prior to crash, then turning off the engine ignition may be desirable in order that the propeller impact with the ground take place at reduced engine speed and power. In this way extensive de-

struction of the engine nacelle may be prevented, and a corresponding reduction in the number of exposed ignition sources may be realized. The likelihood of broken fuel and oil lines within the nacelle is also lessened.

The approach to a hazardous landing should be made with only those portions of the electric circuit energized that are required for airplane operation. In order to maintain the exhaust system below the ignition temperature of fuel and oil, the approach should be made at as low an engine power as possible consistent with other safety considerations and with the cowl flaps open wide. The hazard of fuel ignition by electrostatic or friction sparks is lessened if the landing can be made along a well-developed grass-covered strip parallel and adjacent to a paved runway. Greater damage to the airplane structure is sometimes obtained by landing on the turf with wheels up than on the runway because of the plowing and scooping of the ground by the deformed fuselage and nacelles. Midwing or high-wing airplanes with a solid fuselage belly structure unbroken by hatches of bomb-bays could land on turf without significant plowing. Freedom from friction and electrostatic sparks would be gained for these airplanes without increasing the likelihood of severe fuel spillage produced by the structural deformation that sometimes accompanies ground plowing. Airport crash-accident equipment can move to the airplane along the adjacent paved runway. The flight fire system should be discharged into the nacelle a few seconds after touchdown to provide a small additional margin of safety. Less damage to the nacelle will occur if the propellers are left in the unfeathered rather than in the feathered position.

In view of the effective protection provided by the water spray on the hot components of the exhaust system, the question naturally arises concerning the value of employing the fire-extinguishing agents, carried for flight fires, to reduce the likelihood of fire in a crash. Preliminary estimates indicate that the quantities of extinguishing agent carried in flight fire systems can provide a significant measure of protection in a crash, when properly employed. As in the case of the water spray, the fire-extinguishing agent should be applied directly to the hot metal parts by means of a distribution system comparable with that used in the water-spray system. In this way, cooling of the exhaust system by evaporation and decomposition of the agent is promoted, and effective inerting of the adjacent atmosphere is accomplished. The quantity of agent from the flight fire system would be adequate to inert the exhaust system for the time period that is most hazardous if a distribution system could be designed that would confine the agent to a layer around the collector ring approximately $\frac{1}{8}$ inch thick. Such a distribution system would probably have the general appearance of that employed by the water system. The extinguishing agent should be metered to give a continuous flow for 25 seconds from the moment of crash impact. The 25-second interval covers the hazardous period when the airplane is in motion following crash and fuel is spread by the methods discussed, and the brief period after the airplane comes to rest when the fuel mist is being cleared by the wind. Un-

less the fire-extinguishing agent has a sufficient heat of vaporization to cool the hot surfaces to safe temperatures, however, a residual ignition hazard exists with the fuel flowing through the airplane structure and by wetting conduction and accumulated fuel vapors. A modest amount of water, carried separately, discharged with the extinguishing agent through the same distribution system may provide the necessary additional cooling. Further study is required to establish effective combinations of extinguishing agent and water, or other liquids, that may be employed. Highly water-soluble materials, like salts and ammonia, or engine heat may be employed to keep the water in liquid form at low atmospheric temperatures. Because the experimental ignition-source inerting system proved so effective in preventing crash fires in this investigation, its further study and development for special airplane applications is desirable.

LEWIS FLIGHT PROPULSION LABORATORY
 NATIONAL ADVISORY COMMITTEE FOR AERONAUTICS
 CLEVELAND, OHIO, August 1, 1952

REFERENCES

1. Pesman, Gerard J.: Analysis of Multiengine Transport Airplane Fire Records. NACA RM E9J19, 1950.
2. Black, Dugald O.: Facilities and Methods Used in Full-Scale Airplane Crash-Fire Investigation. NACA RM E51L06, 1952.
3. Scull, Wilfred E.: Relation Between Inflammables and Ignition Sources in Aircraft Environments. NACA Rep. 1019, 1951. (Supersedes NACA TN 2227.)
4. Glendinning, W. G.: Possible Cause of Aircraft Fires on Crash. R. & M. No. 1375, British A. R. C., Jan. 1930.
5. Jackson, Joseph L.: Spontaneous Ignition Temperatures of Pure Hydrocarbons and Commercial Fluids. NACA RM E50J10, 1950.
6. Anon.: Research on Flammability Characteristics of Aircraft Fuels. Prog. Rep. No. 1, U. S. Dept. of Interior, Bur. Mines, Feb. 19 to Mar. 31, 1950. (Contract (33-038) 50-1293E.)
7. Clark, H. H., and Elsley, L. C.: Ignition of Mine Gases by the Filaments of Incandescent Lamps. Bull. No. 52, Bur. Mines, Jan. 1913.
8. Guest, P. G.: Ignition of Natural Gas-Air Mixtures by Heated Surfaces. Tech. Paper 475, Bur. Mines, 1930.
9. Lewis, Bernard, and von Elbe, Guenther: Combustion, Flames and Explosion of Gases. Academic Press, Inc. (New York), 1951. Tables on pages 408-412.
10. Swett, Clyde C., Jr.: Spark Ignition of Flowing Gases. II—Effect of Electrode Parameters on Energy Required to Ignite a Propane-Air Mixture. NACA RM E51J12, 1951.
11. Swett, Clyde C., Jr.: Spark Ignition of Flowing Gases. I—Energies To Ignite Propane—Air Mixtures in Pressure Range of 2 to 4 Inches Mercury Absolute. NACA RM E9E17, 1949.
12. Hutton, J. G., and Bogiages, P. C.: Electric Power Supply Protection on Aircraft. Gen. Elec. Rev., vol. 51, no. 4, Apr. 1948, pp. 27-32.
13. Anon.: Inflammability of Low Volatility Fuels. Tech. and Res. Div., Beacon Labs., The Texas Co., Oct. 10, 1946.

TABLE I.—FUEL ANALYSES

	Aviation gasoline, 100/130 grade	Low-volatility fuel
Distillation, °F		
Initial boiling point.....	104	295
Percentage evaporated:		
5	135	330
10	149	335
20	168	340
30	185	343
40	201	345
50	214	348
60	223	350
70	232	354
80	241	357
90	257	364
95	282	369
Final boiling point.....	330	378
Residue, percent.....	0.6	1.0
Loss, percent.....	0.9	0
Reid vapor pressure, lb/sq in.....	6.1	0.1
Specific gravity at 60° F/60° F.....	0.700	0.781
Refractive index.....	1.3934	1.4374

TABLE II.—FUNCTIONING TIME OF INERTING SYSTEM

Ignition source	Time after crash impact ignitions observed, sec	Inerting-system compo- nents protecting igni- tion source	Function time of inerting- system component, sec
Hot surfaces:			
Exhaust system.....	1.3 .7 1.9 3.8	Water spray.....	0.19
Heat exchanger.....	12.1	Water spray.....	.19
Exhaust flame:			
Torching.....	4.1 1.3 2.0 3.5 1.9	CO ₂ and water and fuel shut-off	0.34
Exhaust gases.....	.1	CO ₂ and water and fuel shut-off	.34
Electrical system:			
Arcs.....	1.0	Electric shut-off...	0.10
Filaments.....	.6 .6	None.....	----
Induction-system flames	2.2 3.5 7.7	CO ₂	0.06
Chemical agents.....	4.4 3.5 3.5	All.....	----
Electrostatic sparks.....	2.4	None.....	----

SYNOPSIS

A review of the literature and accident records on aircraft crash fires indicated the need for experimental work in this field with modern fuels and aircraft powered with reciprocating and turbine engines. Because human survival of crash impact is most likely in landing and take-off accidents, the study of the fire that often follows such accidents was assumed to be the most fruitful area of research in this field.

The information obtained in this study on the mechanism of the crash fire is intended to serve as a factual background on which improvement in airplane crashworthiness may be based. The crash-fire problem was studied by conducting full-scale crashes with twin-engine cargo aircraft provided by the U. S. Air Force (figs. 1 and 2). The aircraft were fully instrumented to record significant data in the crash and fire that follows regarding fuel spillage, combustible-vapor distribution in areas adjacent to potential ignition sources, locations and timing of electrical-system ignition sources, fire incidence and progression, temperatures and toxic-gas concentrations in personnel compartments, and the decelerations the several main components of the airplane undergo in the crash. High-speed motion pictures of the crash were obtained that revealed many of the details of the mechanism of crash fire. Several of the factors observed to be significant in the full-scale crash phase of this work were studied in detail under simulated crash circumstances. Only the work done on aircraft with reciprocating engines is sufficiently complete at this time to be reported herein.

The arrangements for conducting the full-scale crash study are shown in figure 4 (a). The monorail in the foreground guided the airplane, which was accelerated from rest under its own power, to the obstructions shown in the middle of the figure. Airplane speed upon impact with these obstructions ranged from 80 to 105 miles per hour. The abutments in the path of the landing wheels stripped the landing gear from the airplane. The height of the abutments was adjusted to permit the striking airplane propellers to produce extensive nacelle damage short of breaking out the engine. In this way the generation of ignition sources by the engine was promoted. Poles arranged to rip into the wing leading edges and wing fuel tanks about 5 feet outboard of the nacelles produced fuel spillage that was distributed extensively around the crashed airplane. The progressive damage to the airplane at the crash barrier is illustrated schematically in figures 4 (b) to (d). Each airplane carried 1050 gallons of gasoline or low-volatility fuel described in table I. The fuel was usually dyed red to improve its photography in color.

Inquiry into the mechanism of the crash fire centers on the answers to two questions: How and when do ignition sources appear in the airplane crash, and How does the fuel come into contact with the ignition sources? The ignition sources revealed in this study are those that are familiar from experience in normal airplane operations and other technical fields. These ignition sources are listed in table II (col-

umn 1) along with the time of their appearance after crash impact (column 2).

In these crashes the fuel was observed to spill in liquid form from broken fuel lines and tanks, as premixed fuel vapor and air from the damaged engine induction systems, and as fuel mist around the airplane when the spillage appears on the outside of the airplane while it is in motion. In the last case, the pressure and viscous forces of the air on the fuel rip it to mist that moves with air around the airplane. In the crash arrangements employed in this study, liquid and mist spillage occurred in every crash, and carbureted fuel spillage from the engine induction system in only a few cases. These latter instances, however, were sufficient to reveal how such spillage initiates a fire.

The fuel that spills to the open air through the breach in the leading edge of the wing can attain appreciable spanwise spread as mist forward of the leading edge of the wing and reach ignition sources located around the nacelle. As the airplane decelerates in the crash, the fuel opposite the breach in the tank has a speed that is greater than the existing airplane speed. The fuel surges forward through the breach in the tank and is atomized by the air. The air forces that atomize the fuel to mist also impart a spanwise velocity component to the fuel droplets. As this spanwise velocity component is acquired, the forward velocity declines. If the airplane is moving rapidly, it moves by the spreading pattern of fuel mist before the mist has an appreciable time to spread spanwise. If the airplane moves slowly, the fuel mist attains significant spanwise extension around the forward portions of the airplane, and contact with ignition sources at the nacelle is likely.

The combination of reduced airplane speed and high airplane deceleration represents the condition of airplane motion most hazardous with respect to fuel-mist ignition at the nacelle. A comparison of the small spanwise distribution of the fuel obtained when the airplane speed is high and the deceleration is low (fig. 17 (a)) with the large fuel-mist spanwise development forward of the wing leading edge obtained at low airplane speed and high deceleration (fig. 16) shows these effects clearly.

Because a few seconds are required for the airplane to slow from its high speed at crash impact, contact between the fuel mist and ignition sources of the nacelle occurs several seconds after impact. An example of this time delay required for fuel-mist contact is given in figure 12, which shows a series of exhaust flames issuing from the engine tail pipe during the airplane slide from the crash barrier to near rest, when ignition of the gasoline mist occurred at the engine tail pipe (fig. 12 (d)). Ignition of the gasoline mist by the hot exhaust-collector ring, involving a similar time delay, is shown in figure 38 (d).

The substitution of low-volatility fuel for gasoline does not materially reduce the likelihood of ignition when contact between the fuel mist and a potent ignition source occurs. The ignition of the mist of low-volatility fuel at the engine tail pipe is shown in figure 19. The large fuel-mist fire on the

left side of the airplane (fig. 19 (b)) followed the ignition $1\frac{1}{2}$ seconds earlier in figure 19 (a). These results indicate that fuels of low volatility will ignite and burn readily when dispersed as mist, and their adoption for reciprocating engines would not alone represent an acceptable solution to the crash-fire problem.

Because the fuel mists are air-borne, they persist in the air around the crashed airplane for a time that varies inversely with the wind speed (fig. 11). Fuel mists in ignitable concentrations seldom persist around the airplane for more than 17 seconds after the airplane comes to rest. If a tail wind sweeps the mist from the crash area, the likelihood of ignition is momentarily increased as the dense portions of the fuel mist are swept over the nacelle by the wind. Because of the large error inherent in making a visual estimate of the persistence time of the fuel mist in the neighborhood of the airplane, it was not possible to evaluate the effect of fuel volatility on this persistence time. Fuel vapors associated with the mist will move with the wind approximately as the smaller mist droplets and may have a persistence time a few seconds greater than the bulk mist.

Transition from fuel-mist spillage to spillage in liquid form in the open air takes place as the airplane slows to rest. Because of the high rate of air dilution provided by normal air movement in the open, combustible concentrations of gasoline vapors coming from the liquid gasoline on the ground appear only close to the fuel spillage in strata that lie close to the ground. Where protection from wind is obtained by vegetation, ground channels or ditches, or components of the crashed airplane, a marked increase exists in ignition hazard distance from the liquid spillage. In general, however, the likelihood of ignition of vapors from liquid pools of gasoline in the open air does not appear significant unless the ignition source lies within a few inches of the ground. Except for burning droplets of oil dripping from the nacelle, broken elements of the exhaust-disposal system falling to the ground, or friction sparks, the ignition sources can be expected to lie above this combustible layer of vapor.

Gasoline spilled within the enclosed cavities of the airplane, where low air-ventilation rates exist, can generate large volumes of combustible concentrations of vapor that can move through the channels provided by the airplane structure. Fuel in both liquid and vapor form can flow through these channels by gravity and achieve a considerable displacement away from the fuel-spillage point. Hot-gas ducts of the icing-protection systems or cabin air-conditioning, for example, lead to heat exchangers that are often at temperatures above the fuel-ignition temperature. In figure 25 (c) is shown the fire that follows the movement of wing-spilled fuel through the icing-system hot-air distribution duct that runs along the wing leading edge to the engine exhaust-gas heat exchanger on the engine tail pipe below the wing (fig. 25 (b)). Propagation of the fire into the wing along the path of fuel produced the wing explosion shown in figure 25 (c). Because of the time required for fuel to

move to the ignition source, this fire occurred 12 seconds after crash impact.

Ignition sources within the wing belong to the wing electrical system. Damage to this electrical system during crash impact can produce ignition sources close to the wing fuel spillage, and fire follows almost immediately. In figure 24 (c) is shown the fire produced by operating landing lights that were smashed and driven into the wings by the poles at the crash barrier. The wing fire appeared 0.60 second after crash impact.

Distribution of fuel in liquid form from the spillage point to remote areas can take place on the lower surfaces of inclined elements of the airplane structure. The liquid fuel wets and clings to these surfaces, such as the lower wing skin, and flows by gravity. This so-called "wetting conduction" of the fuel is shown in figure 27 on the wing and nacelle and in figure 26 on the elements of the wheel well and landing-gear strut. The red-dye trails left by the fuel show the wetted path of the fuel. Because of the wing dihedral, the fuel tends to move to the nacelle where many ignition sources are located, if the wing position is not altered from normal in the crash.

The fuel that is spilled as carbureted mixture of fuel and air from the damaged engine induction system is generally released in zones adjacent to the hot exhaust-disposal system and the electrical elements in the engine accessory sections. A variety of ignition sources are available, therefore, to ignite this fuel. The quantity of fuel in the engine induction system is too small to produce a serious fire unless the flash fire of this fuel extends to other fuel spillage. In figure 30 is shown the propagation of the engine induction-system fuel fire out of the nacelle to the fuel spillage from the wing.

In an effort to reveal mechanisms of crash-fire initiation that may have been obscured by the early fires set by the known ignition sources, an ignition-source inerting system was installed in nacelles of several aircraft crashed in this program. A schematic view of the inerting-system arrangements is given in figure 31. The four-component inerting system includes a fuel shut-off valve at the carburetor and fire wall that brings the engine to rest, a 3-pound charge of fire-extinguishing agent injected into the engine inlet to inert the engine interior, an electrical system cut-off switch on the battery and generator circuits to prevent the development of hot wires and electric arcs, and a water-spray system arranged to distribute water to all parts of the hot metal of the engine exhaust-disposal system. The steam generated on the hot metal surfaces of the exhaust system provided protection from fuel or oil ignition while the metal cooled to temperatures below the ignition point of fuel and oil. All components of the system were arranged to be actuated as soon after crash as possible.

The only new mechanisms of crash fire revealed in this phase of the work with the ignition-source inerting system installed in the airplane nacelles is shown in the crash illustrated in figure 44. The landing wheel and strut, which were stripped from the airplane at the crash barrier, followed in

the wake of the airplane sliding along the ground. In its passage through the soil dust and fuel mist in the wake of the airplane, the wheel and strut accumulated electrostatic charge that ignited the fuel behind the airplane when the wheel strut approached the ground and discharged (fig. 44 (b)). The fuel fire propagated through the fuel in the wake to the crashed airplane.

Five of the airplanes that were equipped with the inerting system and did not burn are shown in the photographs of figure 40, taken when the airplanes came to rest after crash. A sixth airplane, likewise equipped, which was subjected to a ground loop (fig. 41), did not burn either.

This report contains a section devoted to the description of the progress of an aircraft fire. Because the section on the progress of aircraft fires cannot be given in brief form without misinterpretation, its inclusion in this synopsis is not attempted.

The results of this work indicate that significant reductions in crash-fire hazard can be realized by any design measure that increases the forward and spanwise distance and the elevation of the engine with respect to the fuel storage. This trend in airplane component arrangement will reduce the likelihood of contact between fuel in mist form with the many ignition sources at the nacelle. Devices or design features that act to intercept spilled fuel flowing within the

channels provided by the airplane structure are also valuable. Provisions for drainage of the intercepted fuel to spillage points in the open air away from the nacelles would enhance the effectiveness of these arrangements. Location of landing lights away from chordwise positions in front of the fuel storage is indicated as well. Preliminary data suggest the value of employing paints that have a reduced tendency to accumulate electrostatic charge by friction with dust and fuel on the parts of the airplane likely to be detached in a crash and trail the airplane.

In an approach to an indicated crash landing, the pilot should de-energize all of the electrical system not required for landing. Engine operation that provides the coolest exhaust-disposal-system temperature should be practiced. Just before touchdown, the fuel flow to the engines should be cut off to allow the engine to purge itself with air before crash impact.

In view of the effectiveness of the experimental ignition-source inerting system in preventing crash fires experienced in this study, the desirability of further study of this system for special airplane applications is indicated. A combined system for both crash and flight fires may be particularly attractive, because protection for crash and flight fires may prove to be possible without serious increases in weight over the flight fire system alone.