

REPORT 1203

WIND-TUNNEL INVESTIGATION AT LOW SPEED OF THE EFFECTS OF CHORDWISE WING FENCES AND HORIZONTAL-TAIL POSITION ON THE STATIC LONGITUDINAL STABILITY CHARACTERISTICS OF AN AIRPLANE MODEL WITH A 35° SWEEPBACK WING ¹

By M. J. QUEIJO, BYRON M. JAQUET, and WALTER D. WOLHART

SUMMARY

Low-speed tests of a model with a wing swept back 35° at the 0.33-chord line and a horizontal tail located well above the extended wing-chord plane indicated static longitudinal instability at moderate angles of attack for all configurations tested. An investigation therefore was made to determine whether the longitudinal stability could be improved by the use of chordwise wing fences, by lowering the horizontal tail, or by a combination of both. Experience with fences on other models has indicated that fence effectiveness in improving static longitudinal stability can be modified by variations in Mach number and Reynolds number; hence, the low Mach number and Reynolds number of the present investigation should be kept in mind in considering the data obtained in this study.

The results of the investigation showed that the longitudinal stability characteristics of the model with slats retracted could be improved at moderate angles of attack by placing chordwise wing fences at a spanwise station of about 73 percent of the wing semispan from the plane of symmetry provided the nose of the fence extended slightly beyond or around the wing leading edge. The static longitudinal stability characteristics of the model with slats extended could be appreciably improved by placing chordwise fences at a spanwise position of approximately 36 percent of the wing semispan from the plane of symmetry. This conclusion confirmed the results of an earlier unpublished investigation made by Douglas Aircraft Co., Inc. No single fence position was found which would cause an appreciable improvement of the model longitudinal stability characteristics for all model configurations; however, use of fences at both 36 percent and 73 percent of the wing semispan from the plane of symmetry caused a large improvement in the longitudinal stability characteristics for all model configurations investigated. Lowering the horizontal tail from the high position to the fuselage center line improved the longitudinal stability characteristics of all model configurations tested, so that all configurations tested were longitudinally stable in the angle-of-attack range from 0° to about 20°.

INTRODUCTION

A low-speed investigation made by Douglas Aircraft Co., Inc. (unpublished) of the static longitudinal stability characteristics of an airplane model with a wing swept back 35° at

the 0.33-chord line and a horizontal tail located well above the extended wing-chord plane has indicated longitudinal instability at moderate angles of attack (near 12°) for both the clean and landing configurations. During the investigation a fence arrangement was developed which appeared to provide satisfactory longitudinal stability characteristics in the landing configuration with slats extended. No attempt was made to eliminate the instability of the model in the clean condition (slats, flaps, and landing gear retracted) because the instability occurred at an attitude normally associated with the landing configuration.

Since this previous investigation, however, there has been increased interest in obtaining satisfactory longitudinal stability characteristics of airplanes, similar to the model tested, for all probable flight configurations.

The purpose of the present investigation is to explore the possibility of improving the longitudinal stability at low speed of the same model (with a 35° sweptback wing) in various configurations by use of chordwise wing fences, by lowering the horizontal tail, and by a combination of the two. The use of fences for this particular configuration was of course suggested by the results of the unpublished investigation referred to previously, whereas lowering of the horizontal tail is a method which has been found to be effective in investigation with other models. (See ref. 1, for example.)

SYMBOLS

The data presented herein are in the form of standard NACA coefficients of forces and moments, which are referred to the stability axes with the origin at the projection of the quarter-chord point of the wing mean aerodynamic chord on the plane of symmetry. Positive directions of the forces, moments, and displacements are shown in figure 1. The symbols and coefficients used are defined as follows:

- b wing span, ft
- c wing chord parallel to plane of symmetry, ft
- \bar{c} wing mean aerodynamic chord, $\frac{2}{S} \int_0^{b/2} c^2 dy$, ft
- q dynamic pressure, $\frac{1}{2} \rho V^2$, lb/sq ft
- S wing area, sq ft

¹ Supersedes recently declassified NACA RM's L50K07 by M. J. Queijo and Byron M. Jaquet, 1950, and L51H17 by M. J. Queijo and Walter D. Wolhart, 1951.

- V free-stream velocity, ft/sec
- y spanwise distance from plane of symmetry, ft
- α angle of attack of fuselage center line, deg
- ρ mass density of air, slugs/cu ft
- D drag, lb
- C_D drag coefficient, $\frac{D}{qS}$
- C_L lift coefficient, $\frac{L}{qS}$
- C_m pitching-moment coefficient, $\frac{M}{qS\bar{c}}$
- L lift, lb
- M pitching moment, ft-lb

MODEL-COMPONENT DESIGNATIONS

- F fuselage
- W wing
- V vertical tail
- H horizontal tail
- Subscripts:
- H high
- M middle
- L low

APPARATUS, MODELS, AND TESTS

The tests of the present investigation were made in the Langley stability tunnel. The models were mounted on a single-strut support which was rigidly fastened to a six-component balance system.

Two models of an airplane were used during the course of the investigation and are designated herein as model 1 and model 2. The first model available for testing (model 1) was not equipped with flaps, slats, or landing gear. This model was a rocket-propelled test vehicle and was constructed primarily of balsa wood and pine with mahogany and aluminum bulkheads and reinforcements. Model 2, built specifically for this investigation, was made of mahogany and incorporated removable flaps, slats, and landing gear. Both models were of the same dimensions (fig. 2 and table I) and were the same in all details except that the horizontal-tail incidence was -1.42° for model 1 and 0° for model 2. Details of the slats and flaps used on model 2 are shown in figure 3. Photographs of the two models are given as figure 4.

The tests made with model 1 were exploratory in nature, the purpose being to determine the effects of fence shape, size, and position on the static longitudinal stability characteristics of the complete model in the clean configuration (slats, flaps, and landing gear retracted). The fences used in this part of the investigation are shown in figure 5.

The tests made with model 2 were divided into two series. The first series was concerned with the evaluation of the effects of a few selected fence shapes (determined from consideration of the results of the tests of model 1) on the four model configurations listed below:

	Configuration
Slats, flaps, and landing gear retracted (clean condition)-----	a
Slats retracted and flaps and landing gear extended.....	b
Slats extended and flaps and landing gear retracted.....	c
Slats, flaps, and landing gear extended (landing condition)----	d

The fences used in this series of tests are shown in figure 6.

The second series of tests made with model 2 was to determine the effect of lowering the horizontal tail of the model. In this series, several complete-model configurations (previously listed) and certain model components were tested without and with fences found to be beneficial from the results of preceding tests. The fences used were fence A and the combination of fence A with fence N_2M_1 . (See figs. 7 and 8.) The model in its various configurations was tested with the horizontal tail in each of the three positions (fig. 9) designated as the high or original position ($0.59\bar{c}$ above fuselage center line), the middle position ($0.29\bar{c}$ above the fuselage center line), and the low position (on fuselage center line). The horizontal tail was moved forward as it was lowered. The locations of the calculated aerodynamic center of the horizontal tail $\bar{c}_{tail}/4$ relative to the fuselage center line and to the calculated aerodynamic center of the wing $\bar{c}_{wing}/4$ are given in figure 9 for the three horizontal-tail positions.

All fences used in the tests were made from $\frac{1}{16}$ -inch sheet brass and were mounted normal to the wing surface. Fence N_2M_1 was made in two segments, N_2 and M_1 (figs. 7 and 8). Segment N_2 was attached to the slat, whereas segment M_1 was attached to the wing.

When the slats were extended, they were moved in a direction normal to the wing leading edge and, therefore, had a lateral displacement of about $0.021b/2$ in the extended position (fig. 8).

All tests were made at a dynamic pressure of 39.7 pounds per square foot, which corresponds to a Mach number of 0.17 and a Reynolds number of 1.1×10^6 based on the wing mean aerodynamic chord of 0.94 foot.

CORRECTIONS

Approximate corrections for the effects of jet boundaries were applied to the angle of attack by the methods of reference 2. Effects of jet boundaries on the pitching moment due to the horizontal tail were accounted for by the methods of reference 3. Blockage corrections were determined by use of reference 4 and were applied to all force and moment coefficients.

RESULTS AND DISCUSSION

BASIC MODEL CHARACTERISTICS FOR CLEAN CONFIGURATION

The lift and pitching-moment characteristics of the basic complete model (without fences and with the high horizontal-tail position) and a breakdown of several of its components are shown in figure 10. The lift curve of the fuselage-tail combination was very nearly linear throughout the angle-of-attack range of the investigation. The fuselage alone produced no appreciable lift up to an angle of attack of about 12° ; however, above 12° the lift-curve slope of the fuselage was fairly large relative to that of the fuselage-tail combination. This fact indicated that, above an angle of attack of 12° , the increase in C_L with α for the fuselage—horizontal-tail combination was due partly to the fuselage and that the horizontal tail loses lift effectiveness above an angle of attack of 12° . (See the pitching-moment data of fig. 10.) These data show a decrease in the stability of the fuselage—horizontal-tail configuration at angles of attack above about 12° . No tests were made with only the horizontal tail; how-

ever, the wing is about the same plan form as the horizontal tail, and the wing lift characteristics indicated that the wing began to stall at a wing angle of attack of about 13° (fuselage angle of attack of 10° .) Therefore, at least part of the loss of effectiveness of the horizontal tail above $\alpha=13^\circ$ appeared to be caused by stalling.

The most noticeable effect of adding the wing to the fuselage-tail combination is the nonlinearity of the resulting pitching-moment curve. This nonlinearity (and resulting instability) was apparently attributable to a loss in dynamic pressure and the rate of change of downwash with α in the wing wake acting on the horizontal tail. Subsequent downwash measurements in the vicinity of the horizontal tail have further substantiated this conclusion. The pitching-moment data of the complete model show that the model was longitudinally unstable at lift coefficients from about 0.69 to 0.85 (angle-of-attack range from about 8° to 15°); hence, the maximum usable lift coefficient was only about 0.68.

EFFECTS OF FENCE GEOMETRY ON THE BASIC MODEL CHARACTERISTICS FOR CLEAN CONFIGURATION

The tests of this group were made to determine the effects of changes in shape, size, and position of the fences on the static longitudinal stability characteristics of the model in the clean condition (flaps, slats, and landing gear retracted) with the horizontal tail in the high position. All the tests of this group were made with model 1 and the fences shown in figure 5.

Effect of fences at spanwise station $y=0.36b/2$.—The addition of fence A on the upper surface of each wing semi-span at a spanwise station $y=0.36b/2$ caused no appreciable change in the model pitching-moment characteristics for the clean condition (fig. 11). A previous investigation has shown that fence A at this particular position was very beneficial for the landing condition. Previous experience with fences on other models has shown that, for some cases, the effectiveness of a fence was improved when the leading edge of the fence extended close to or actually ahead of and around the wing leading edge. A nose extension, therefore, was added to fence A to form fence B. The results of the modification were almost negligible (fig. 11).

Effects of fence B at various spanwise stations.—The data of figure 12 show the effects of varying the spanwise position of fence B from $0.65b/2$ to $0.76b/2$ on the lift and pitching-moment characteristics of the model. Fence B at any of these stations caused an appreciable increase in lift coefficient at angles of attack greater than about 10° (compare figs. 11 and 12) by delaying the lift break to higher angles of attack. Fence B also improved the static longitudinal stability of the model by reducing the instability which occurred in the angle-of-attack range from about 8° to 15° for the basic model. The fence at spanwise station $0.65b/2$ caused the largest improvement in stability in the angle-of-attack range from 8° to 15° and delayed the model longitudinal instability to an angle of attack of about 16° . Moving the fence outboard from $0.65b/2$ to $0.76b/2$ caused a gradual reduction in stability in the angle-of-attack range from 8° to 15° but delayed the lift break and the unstable break in the pitching-moment curve to higher angles of attack. A

spanwise position of $0.73b/2$ appeared to give a reasonably good compromise of pitching-moment and lift characteristics throughout the angle-of-attack range and hence was used for most of the subsequent tests.

Effects of fence shape at $y=0.73b/2$.—In a practical application of fences it would probably be desirable to use the smallest size fence which would result in acceptable aerodynamic characteristics. In this investigation fence B appeared to produce an appreciable improvement in static longitudinal stability; hence, a series of tests were made to determine the effects of variation in shape (and size) of fence B. The variations included changes in fence height, reduction in length by removal of rearward portions of the fences, and by changes in overall shape. When the effects of fence height were determined, two new fences were formed and are designated as fences C and D. Fence C was constructed so that its ordinates were 1.5 times those of fence B; and the ordinates of fence D were 0.5 times those of fence B. When the effects of overall shape were determined, a group of fences were made which incorporated changes in nose and rear shape.

The effects of fence length are shown in figures 13, 14, and 15 for fences B, C, and D, respectively. These data show that removal of as much as the rear two-thirds of fences B, C, or D (reduction in length from about $0.80\bar{c}$ to $0.26\bar{c}$) to form fences B_2 , C_2 , and D_2 caused little reduction in fence effectiveness. A further reduction in fence length (fences shorter than B_2 , C_2 , and D_2) caused a decrease in fence effectiveness by permitting unstable breaks in the pitching-moment curve at lower angles of attack than had occurred with the longer fences.

The effects of fence height can be evaluated by comparing corresponding curves of figures 13, 14, and 15. The data show that variations in fence height caused little change in fence effectiveness except for very short fences. In this case, increased fence height was of some benefit.

The effects of overall shape are shown in figure 16. The results show that at this spanwise station ($0.73b/2$) fence effectiveness was increased by extending the nose beyond or around the wing leading edge. The shape of the rear part of the fence did not appear to be important if there was sufficient nose overhang and fence length. Results of more recent fence tests have indicated that nose overhang may be of no consequence or even undesirable for models incorporating wings with sharp leading edges.

Effect of combinations of fences.—It has been stated previously that fence A had been found to be beneficial for the model in the landing condition. It was not known whether the fences which were satisfactory for the landing condition would influence the effectiveness of the fences which were beneficial for the clean condition. Tests, therefore, were made with one of the better fences (fence K) at various spanwise stations in conjunction with fence A at $y=0.36b/2$. The results (fig. 17) show that the addition of fence A did not reduce the effectiveness of fence K; also, the variation of the effectiveness of fence K with spanwise position was about the same as had been noted previously with fence B alone (fig. 12). Results obtained with fence K divided into two or three segments (fig. 18) showed only

small differences from the results obtained with fence K as a unit.

EFFECTS OF FENCES ON VARIOUS COMPLETE-MODEL CONFIGURATIONS

The results of the exploratory tests with model 1 were used as a guide in determining other fence shapes (fig. 6) to be tested on model 2 (with the high horizontal tail) for the model configurations given in the section entitled "Apparatus, Models, and Tests." Two types of fence designs were used. One design was such that the fence was made in two segments, one attached to the slat and the other to the wing. The other design consisted of a one-piece fence which was attached only to the wing and extended only to the wing leading edge.

Effects of fence A or N_2M_1 or both together.—The data of figure 19 show the effects of fence A or N_2M_1 or both together on the longitudinal stability characteristics of the four configurations previously listed. The data for each configuration without fences show that the model became longitudinally unstable at moderate angles of attack. The addition of fence A alone at spanwise station $y=0.36b/2$ improved the pitching-moment characteristics of the configurations with slats extended but had no appreciable effects on configurations with slats retracted. The addition of fence N_2M_1 alone caused an improvement in the longitudinal stability of the configurations with slats retracted but had no appreciable effects on the configurations with slats extended. When fences A and N_2M_1 were added to the model, the longitudinal characteristics of all four model configurations were improved appreciably at moderate and high angles of attack.

Effect of length of fence N_2M_1 .—Removal of segment M_1 from fence N_2M_1 had no appreciable effect on the longitudinal stability characteristics of the various configurations with fence A in its normal position (fig. 20) except at high angles of attack (above about 20°). There, the section M_1 either tended to eliminate any erratic variation of C_m with α or to delay the erratic variation to higher angles of attack.

Effect of lateral displacement of segment N_2 relative to M_1 with fence A in its normal position.—A lateral displacement of segment N_2 by an amount $0.021b/2$ inboard or outboard relative to M_1 caused no appreciable change in the effectiveness of fence N_2M_1 for any of the four configurations investigated (fig. 21).

Effects of miscellaneous fences.—The miscellaneous fences used were NM, $N'M$, and a combination of NM and N_2 . Fence $N'M$ was like NM except for a thin slit cut under the lower forward part of fence $N'M$. As stated previously, the slat of the model was extended normal to the wing leading edge; hence, with the slat in the extended position, there was a spanwise and chordwise gap between the forward and rear parts of any fence made up of separate nose and rear parts. The combination $NM+N_2$ was used to eliminate the chordwise gap. With slats retracted, fence NM overlapped N_2 . With slats extended the chordwise gap was eliminated by

the forward part of fence NM. Each of the miscellaneous fences mentioned was tested with fence A at a spanwise station of 36 percent of the wing semispan. Fences NM and $N'M$ were attached only to the wing; therefore, no part of the fence moved forward when the slat was extended. The slit cut into fence $N'M$ was to determine whether the fence effectiveness would be reduced if a slit had to be made to permit easy operation of the nose slat. The data of figure 22 show that fences NM and $N'M$ were about equally effective, but both permitted the pitching moment to vary erratically with angle of attack at high angles of attack. The combination $NM+N_2$ was about as effective as fence N_2M_1 for configurations with slats extended (compare figs. 20 and 22); thus, the chordwise gap between N_2 and M_1 (which occurs when the slats are extended) was of small consequence.

EFFECTS OF HORIZONTAL-TAIL POSITION ON VARIOUS COMPLETE-MODEL CONFIGURATIONS

The tests of this group (figs. 23 to 27) were made to determine the effects of horizontal-tail position on the static longitudinal stability characteristics of the model and some of its components in the four configurations previously listed. The model was tested with fence A alone and fence A with N_2M_1 . The set of fences used in the tests, fences A and N_2M_1 , were selected as being equally as effective as any group used during the tests and were smaller than most of the other configurations of equal effectiveness.

The position of the horizontal tail had no appreciable effects on the lift characteristics of the configurations investigated, and the effects of fences on the lift characteristics of the complete model have already been discussed. Therefore, the lift characteristics are presented herein primarily to relate the pitching-moment characteristics to the lift and are not discussed further. The drag data are given for the sake of completeness but are not discussed since they show no significant effects of horizontal-tail position. The drag data are presented for the various configurations with fence A but are not given for configurations with fences A and N_2M_1 because the addition of fence N_2M_1 caused no appreciable change in the drag of the models.

Configurations with wing off.—The data of figure 23 show that the variation in slope of the pitching-moment coefficient for the fuselage-tail configuration with angle of attack is reduced by lowering the horizontal tail from its original (or high) position.

Configurations with slats, flaps, and landing gear retracted.—When the slats, flaps, and landing gear were retracted (fig. 24), the complete model with the horizontal tail in the high position was longitudinally unstable at angles of attack from about 10° to 14° with both fence combinations (fence A alone and fence A with fence N_2M_1). The instability was greater for the model with fence A than it was for the model with fences A and N_2M_1 .

Lowering the horizontal tail improved the longitudinal stability in the angle-of-attack range from 10° to 14° . With the horizontal tail in the low position, the model with fences A and N_2M_1 was longitudinally stable throughout the angle-of-attack range. The model with fence A was neutrally stable near an angle of attack of 12° but was stable at all other angles. The longitudinal stability of the models was about the same for both fence configurations at all angles of attack except in the range from 10° to 14° where the model with fences A and N_2M_1 showed more stability than it did with only fence A.

Configurations with slats retracted and flaps and landing gear extended.—When the slats were retracted and the flaps and landing gear were extended (fig. 25), the complete model with the horizontal tail in the high position was longitudinally unstable at angles of attack from 8° to 13° with fence A but was about neutrally stable in the same angle-of-attack range with fences A and N_2M_1 . Lowering the position of the horizontal tail caused a large improvement in the longitudinal stability of the model in the angle-of-attack range from 8° to 13° . The model was longitudinally stable at all angles of attack and for both fence configurations when the horizontal tail was located on the fuselage center line.

Configurations with slats extended and flaps and landing gear retracted.—The longitudinal stability characteristics of the model with slats extended and flaps and landing gear retracted (fig. 26) were about the same with fence A on the wing as with the combination of fences A and N_2M_1 . The model with the horizontal tail in the high position was approximately neutrally stable at angles of attack from 11° to 14° , but this region of neutral stability was made stable by lowering the horizontal tail to the fuselage center line. The incremental changes in pitching-moment characteristics obtained by lowering the horizontal tail were greater for configurations with slats retracted than for configurations with slats extended. (Compare figs. 24 and 26, for example.) At high angles of attack (above 20°) the pitching-moment curve of the models with fence A varied erratically with a change in angle of attack and showed some regions of instability. These regions of instability were eliminated by the addition of fence N_2M_1 .

Configurations with slats, flaps, and landing gear extended.—The complete model was neutrally or only slightly stable at angles of attack near 12° when the slats, flaps, and landing gear were extended (fig. 27). Lowering the horizontal tail caused some improvement in the longitudinal stability of the model. The characteristics of the model were about the same with fence A on the wing as with fences A and N_2M_1 except that, at high angles of attack (above 20°),

the addition of fence N_2M_1 eliminated some unstable breaks which occurred in the pitching-moment curves of the model with fence A.

CONCLUSIONS

Low-speed tests of a model with a wing swept back 35° at the 0.33-chord line and a horizontal tail located well above the extended wing-chord plane indicated static longitudinal instability at moderate angles of attack for all configurations tested. An investigation, therefore, was made to determine whether the longitudinal stability could be improved by the use of chordwise wing fences, by lowering the horizontal tail, or by a combination of both. Experience with fences on other models has indicated that fence effectiveness in improving static longitudinal stability can be modified by variations in Mach number and Reynolds number; hence, the low Mach number and Reynolds number of the present investigation should be kept in mind in considering the following conclusions, which are based on the results of the present investigation:

1. The longitudinal stability characteristics of the model with slats retracted could be improved at moderate and high angles of attack by placing chordwise wing fences at a spanwise station of about 73 percent of the wing semispan from the plane of symmetry provided the nose of the fence extended slightly beyond or around the wing leading edge.

2. The static longitudinal stability characteristics of the model with slats extended could be appreciably improved by placing chordwise fences at a spanwise position of approximately 36 percent of the wing semispan from the plane of symmetry. This conclusion confirmed the results of an earlier unpublished investigation made by Douglas Aircraft Co., Inc.

3. No single fence position was found which would cause an appreciable improvement of the model longitudinal stability characteristics for all model configurations; however, use of fences at both 36 percent and 73 percent of the wing semispan from the plane of symmetry caused a large improvement in the longitudinal stability characteristics for all model configurations investigated.

4. Lowering the horizontal tail from the high position to the fuselage center line improved the longitudinal stability characteristics of all complete model configurations tested, so that all the configurations tested were longitudinally stable in the angle-of-attack range from 0° to about 20° .

LANGLEY AERONAUTICAL LABORATORY,
 NATIONAL ADVISORY COMMITTEE FOR AERONAUTICS,
 LANGLEY FIELD, VA., November 24, 1954.

REFERENCES

1. Lichtenstein, Jacob H.: Experimental Determination of the Effect of Horizontal-Tail Size, Tail Length, and Vertical Location on Low-Speed Static Longitudinal Stability and Damping in Pitch of a Model Having 45° Sweptback Wing and Tail Surfaces. NACA Rep. 1096, 1952. (Supersedes NACA TN's 2381 and 2382.)
2. Silverstein, Abe, and White, James A.: Wind-Tunnel Interference With Particular Reference to Off-Center Positions of the Wing and to the Downwash at the Tail. NACA Rep. 547, 1936.
3. Gillis, Clarence L., Polhamus, Edward C., and Gray, Joseph L., Jr.: Charts for Determining Jet-Boundary Corrections for Complete Models in 7- by 10-Foot Closed Rectangular Wind Tunnels. NACA WR L-123, 1945. (Formerly NACA ARR L5G31.)
4. Herriot, John G.: Blockage Corrections for Three-Dimensional-Flow Closed-Throat Wind Tunnels, With Consideration of the Effect of Compressibility. NACA Rep. 995, 1950. (Supersedes NACA RM A7B28.)

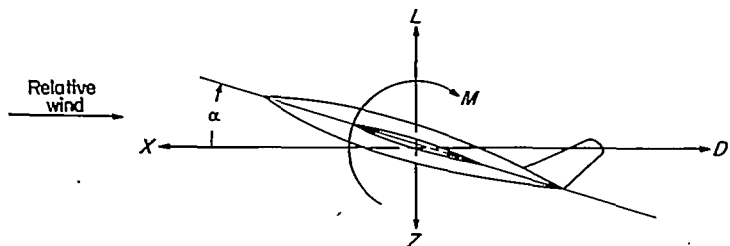

FIGURE 1.—System of stability axes. Arrows indicate positive direction of angles, forces, and moment.

TABLE I.—DIMENSIONS AND CHARACTERISTICS OF MODEL

Wing:	
Root airfoil section (normal to 0.33-chord line).....	NACA 63-010
Tip airfoil section (normal to 0.33-chord line).....	NACA 63-012
Total area, sq in.....	428
Span, in.....	38.84
Mean aerodynamic chord, in.....	11.30
Root chord (parallel to plane of symmetry), in.....	14.10
Tip chord (parallel to plane of symmetry), in.....	7.95
Taper ratio.....	0.565
Aspect ratio.....	3.57
Sweep at 0.33-chord line, deg.....	35.0
Incidence, deg.....	3.0
Dihedral, deg.....	-3.0
Total flap area, sq in.....	31.50
Horizontal Tail:	
Airfoil section (normal to 0.35-chord line).....	NACA 63-010
Total area, sq in.....	97.50
Span, in.....	18.66
Mean aerodynamic chord, in.....	5.42
Root chord (parallel to plane of symmetry), in.....	6.97
Tip chord (parallel to plane of symmetry), in.....	3.48
Taper ratio.....	0.50
Aspect ratio.....	3.50
Sweep at 0.35-chord line, deg.....	40.0
Incidence (from fuselage center line), deg.....	0 or -1.42
Tail length (from $\bar{c}/4$ of wing to $\bar{c}/4$ of tail)	
High tail, in.....	30.58
Middle tail, in.....	29.05
Low tail, in.....	27.50
Tail height (from fuselage center line)	
High tail, in.....	6.60
Middle tail, in.....	3.30
Low tail, in.....	0.0
Vertical Tail:	
Airfoil section (normal to 0.45 chord).....	NACA 63-010
Root chord (parallel to fuselage center line), in.....	18.90
Height, from fuselage center line, in.....	12.68
Sweep at 0.45-chord line, deg.....	40.0
Fuselage:	
Length, in.....	65.52
Maximum diameter.....	7.80
Fineness ratio.....	8.40

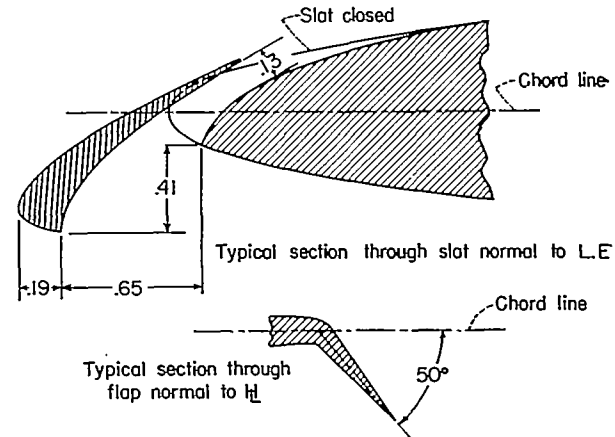
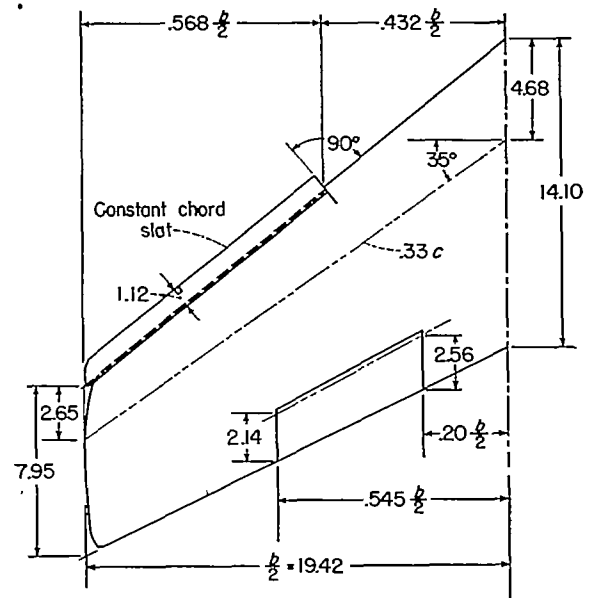
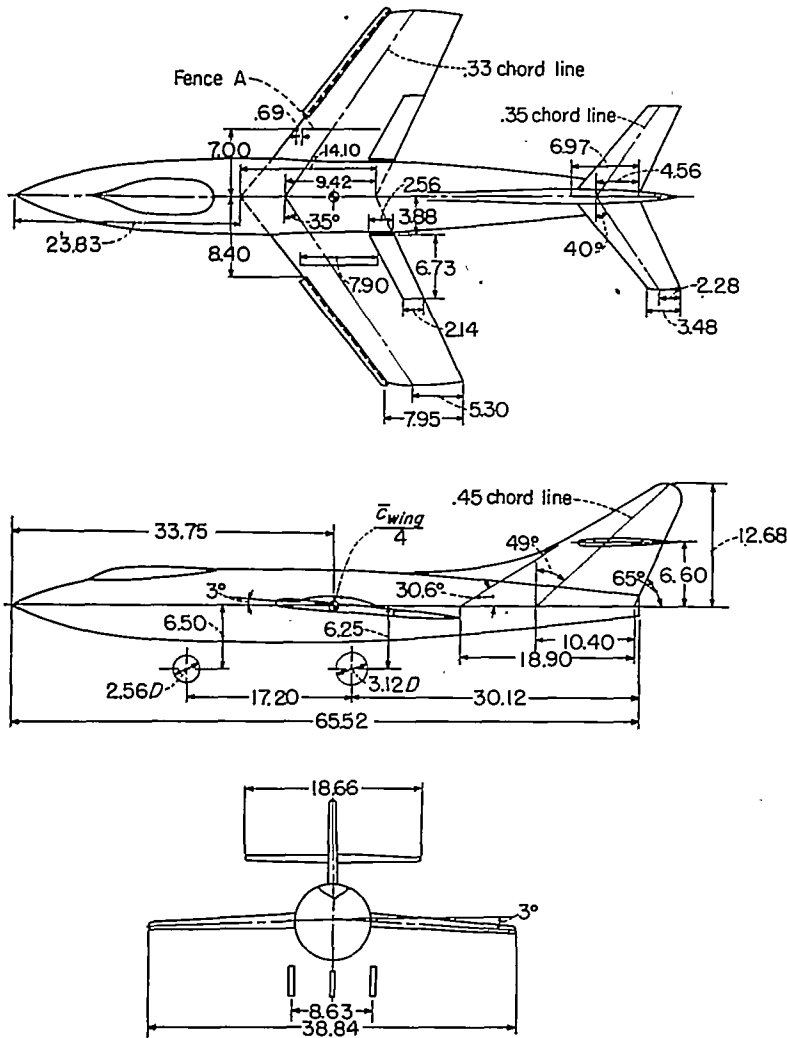
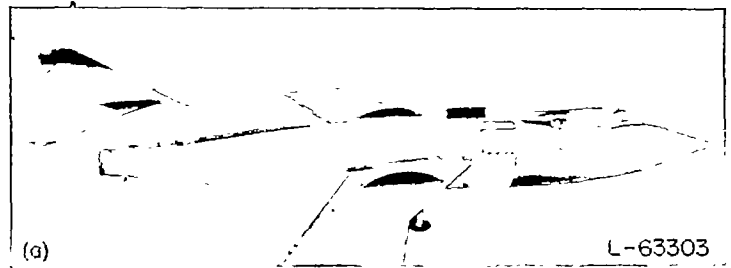
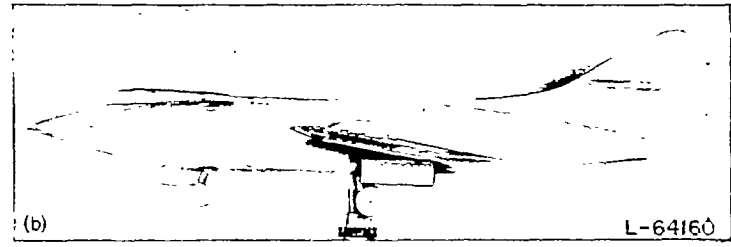

FIGURE 2.—Drawing of model used in the investigation. All dimensions are in inches.

FIGURE 3.—Details of slats and plain flaps. All dimensions are in inches.



(a) Model 1 in the 6-foot-diameter test section of the Langley stability tunnel.



(b) Model 2 ready for installation in the Langley stability tunnel.

FIGURE 4.—Models used during the investigation.

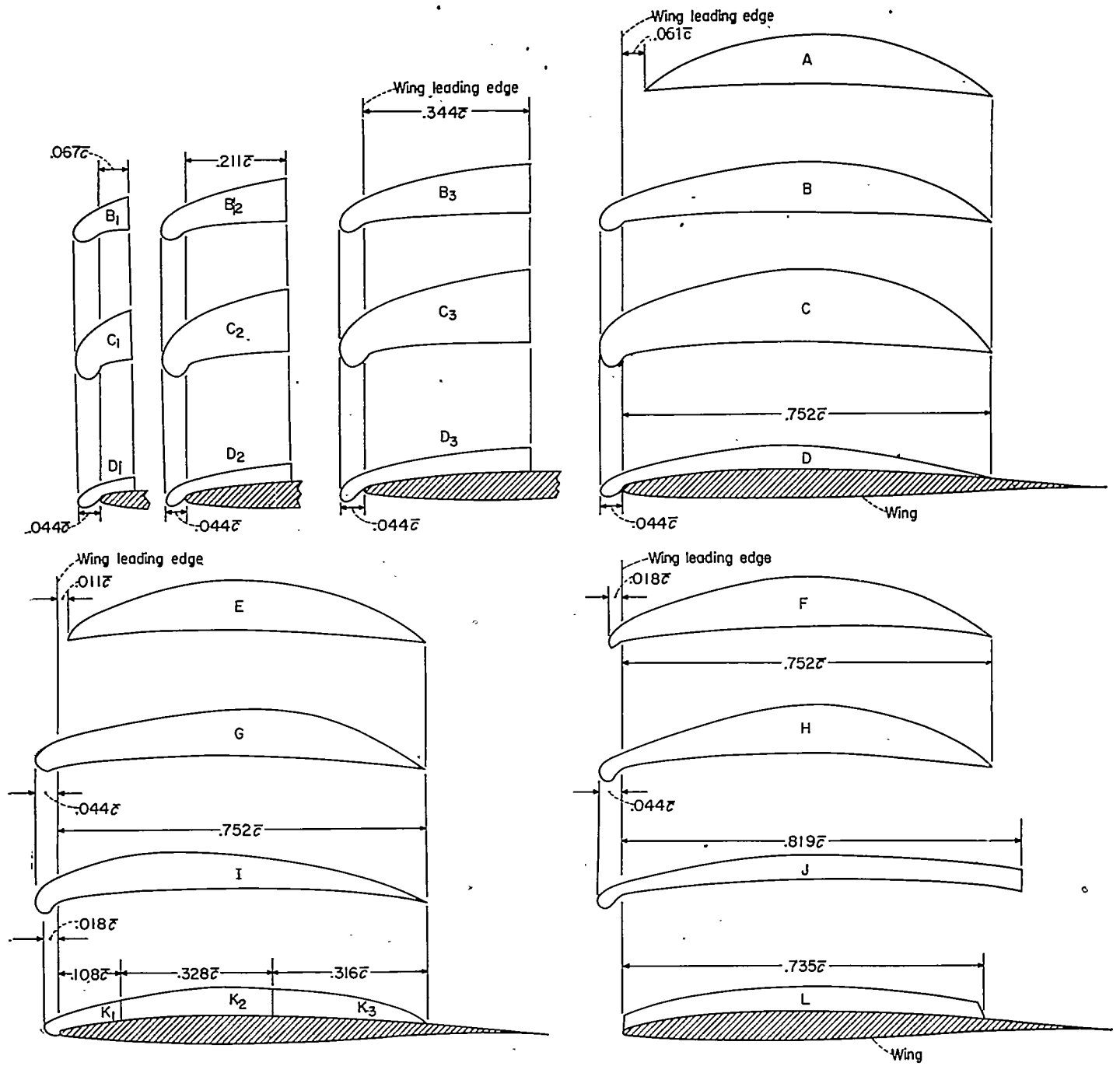

FIGURE 5.—Profiles of fences tested with model 1 drawn to scale.

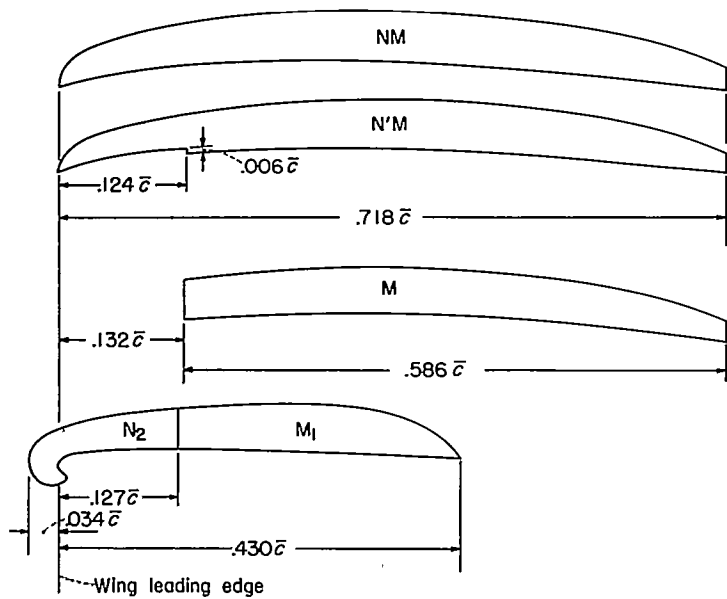

FIGURE 6.—Profiles of fences tested with model 2 drawn to scale.

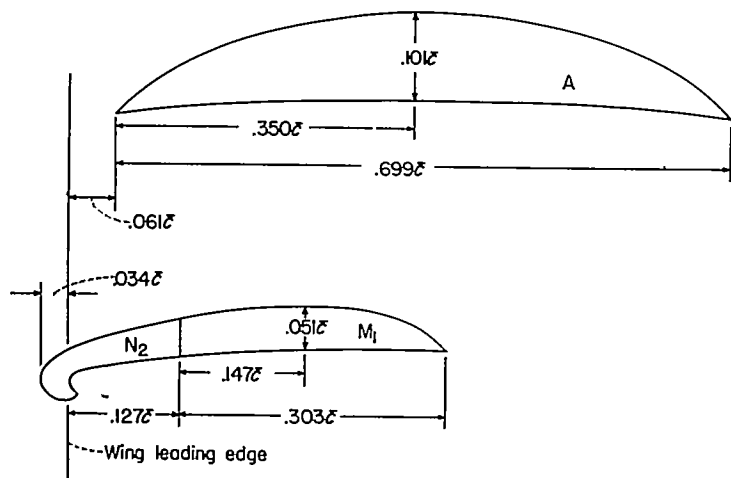

FIGURE 7.—Profiles of fences used for tests with model 2 in which horizontal-tail position was varied.

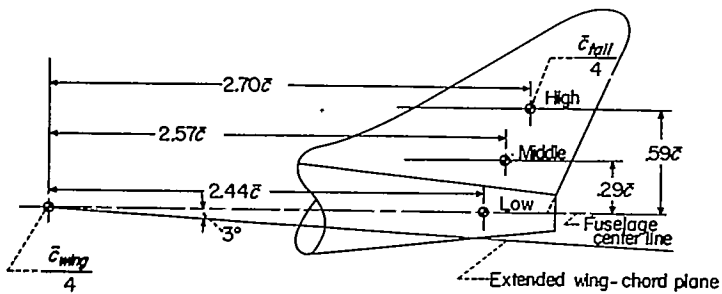
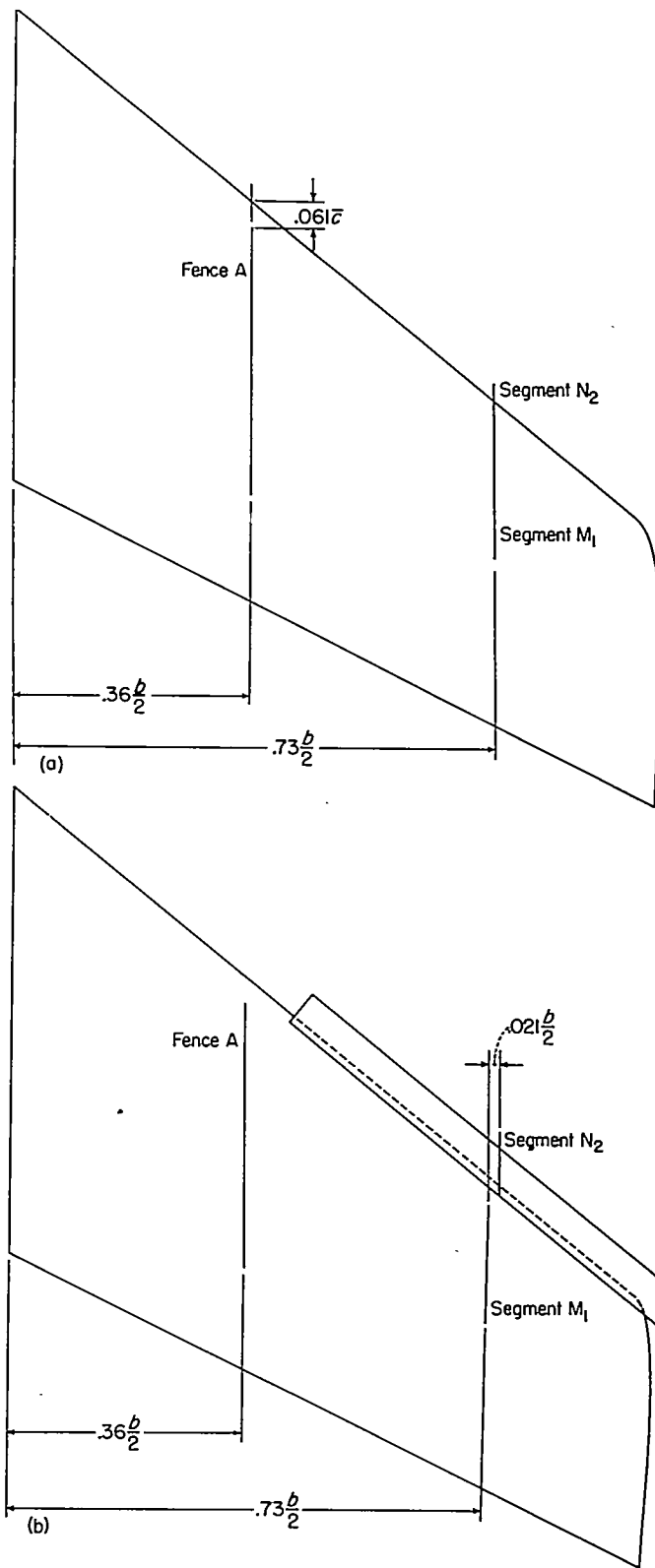

FIGURE 9.—Position of horizontal tail used during the investigation.



(a) Slats retracted.
 (b) Slats extended.

FIGURE 8.—Position of fences on model for tests in which horizontal-tail position was varied.

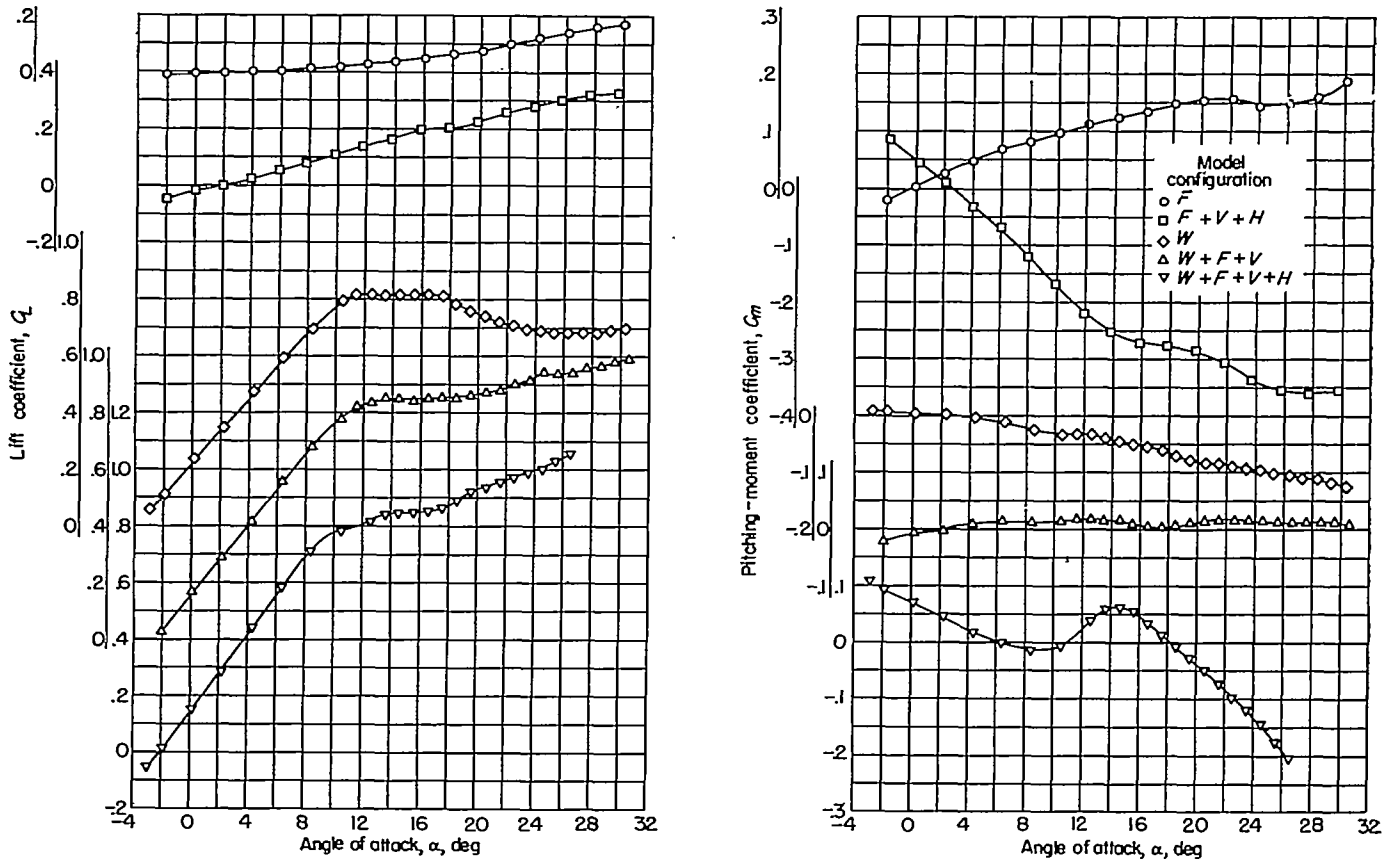

FIGURE 10.—Static longitudinal stability characteristics of various components of model 2. No fences; high horizontal tail.

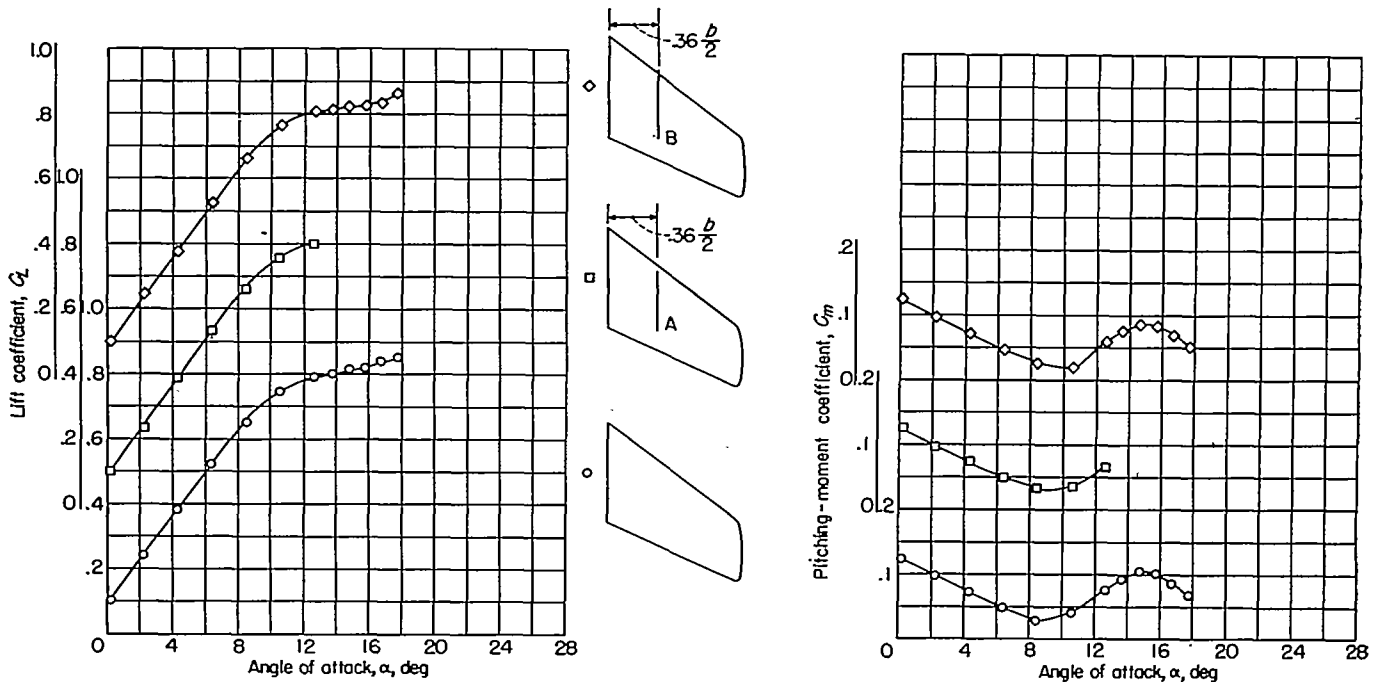

FIGURE 11.—Effect of fences at spanwise station $y=0.36b/2$ on the longitudinal stability characteristics of model 1. Slats, flaps, and landing gear retracted; high horizontal tail.

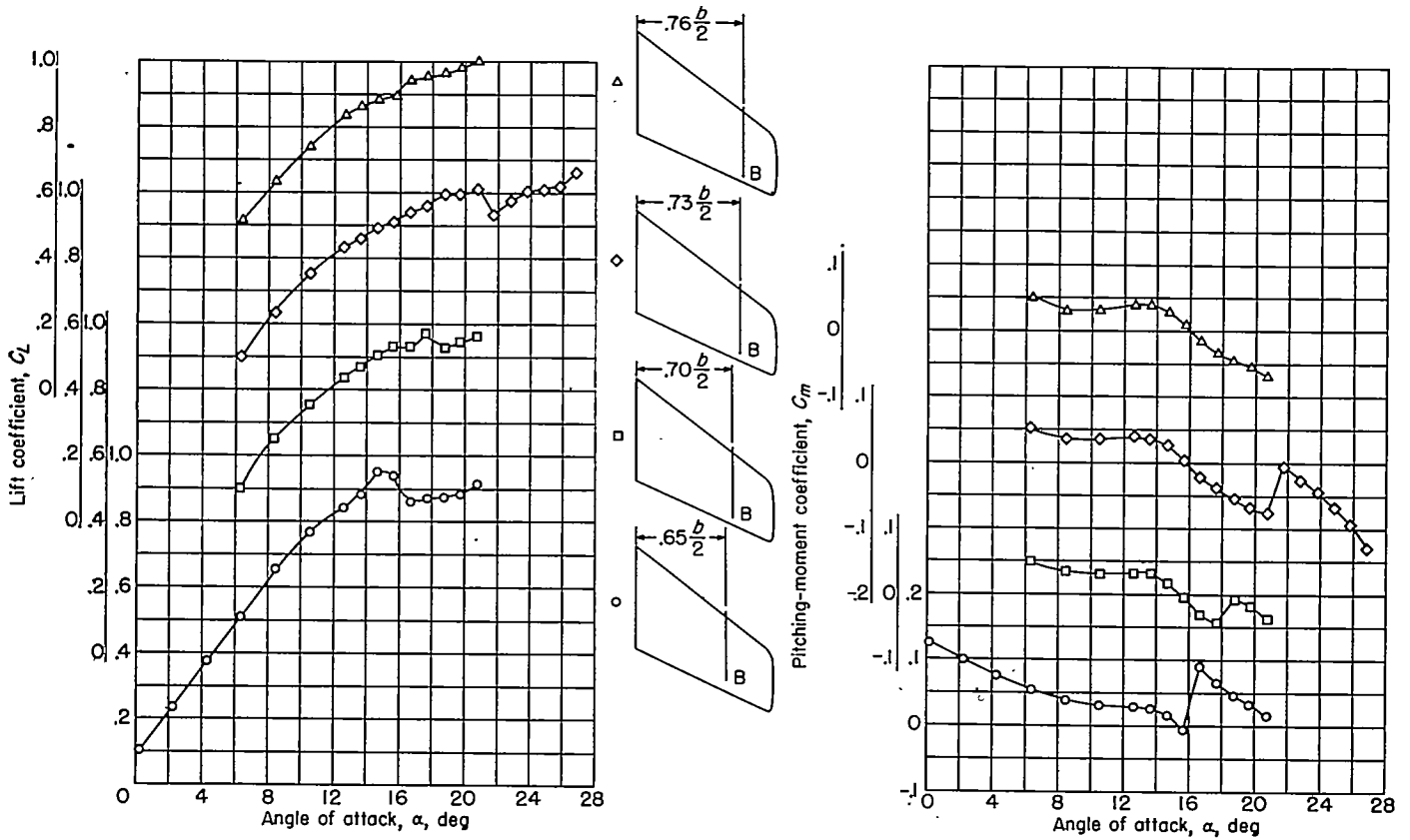

FIGURE 12.—Effect of spanwise position of fence B on the longitudinal stability characteristics of model 1. Slats, flaps, and landing gear retracted; high horizontal tail.

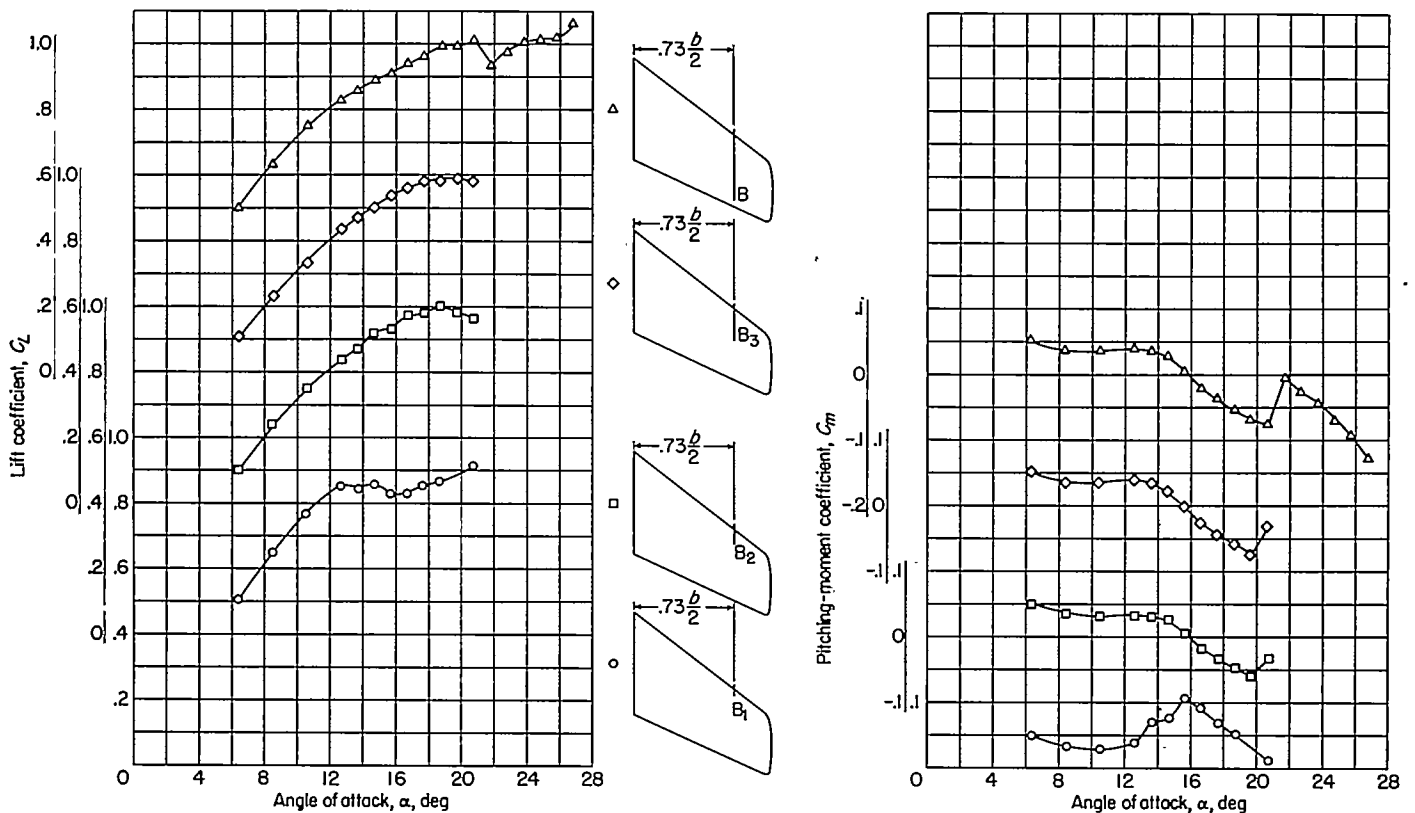

FIGURE 13.—Effect of length of fence B on the longitudinal stability characteristics of model 1. Slats, flaps, and landing gear retracted; high horizontal tail.

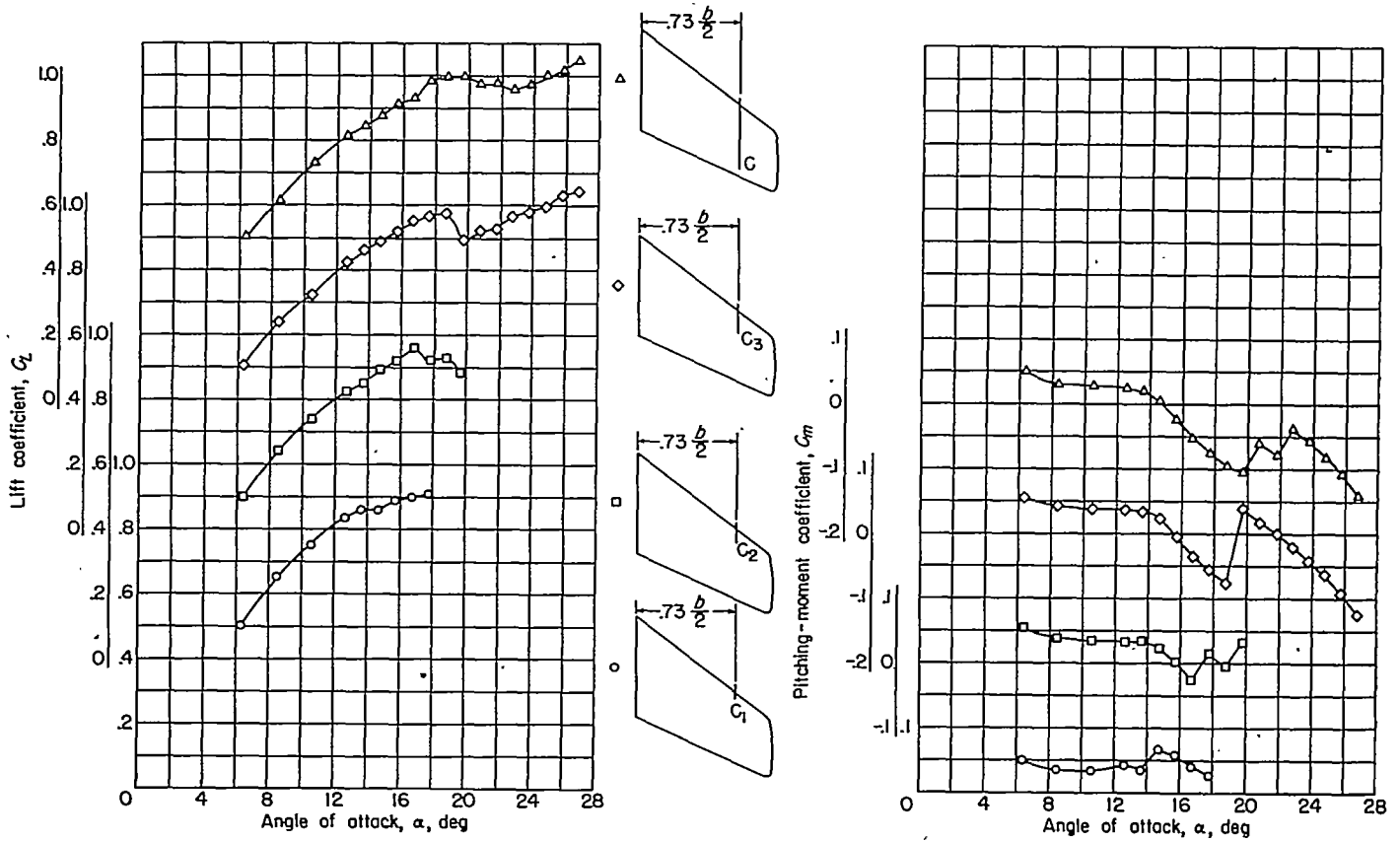

FIGURE 14.—Effect of length of fence C on the longitudinal stability characteristics of model 1. Slats, flaps, and landing gear retracted; high horizontal tail.

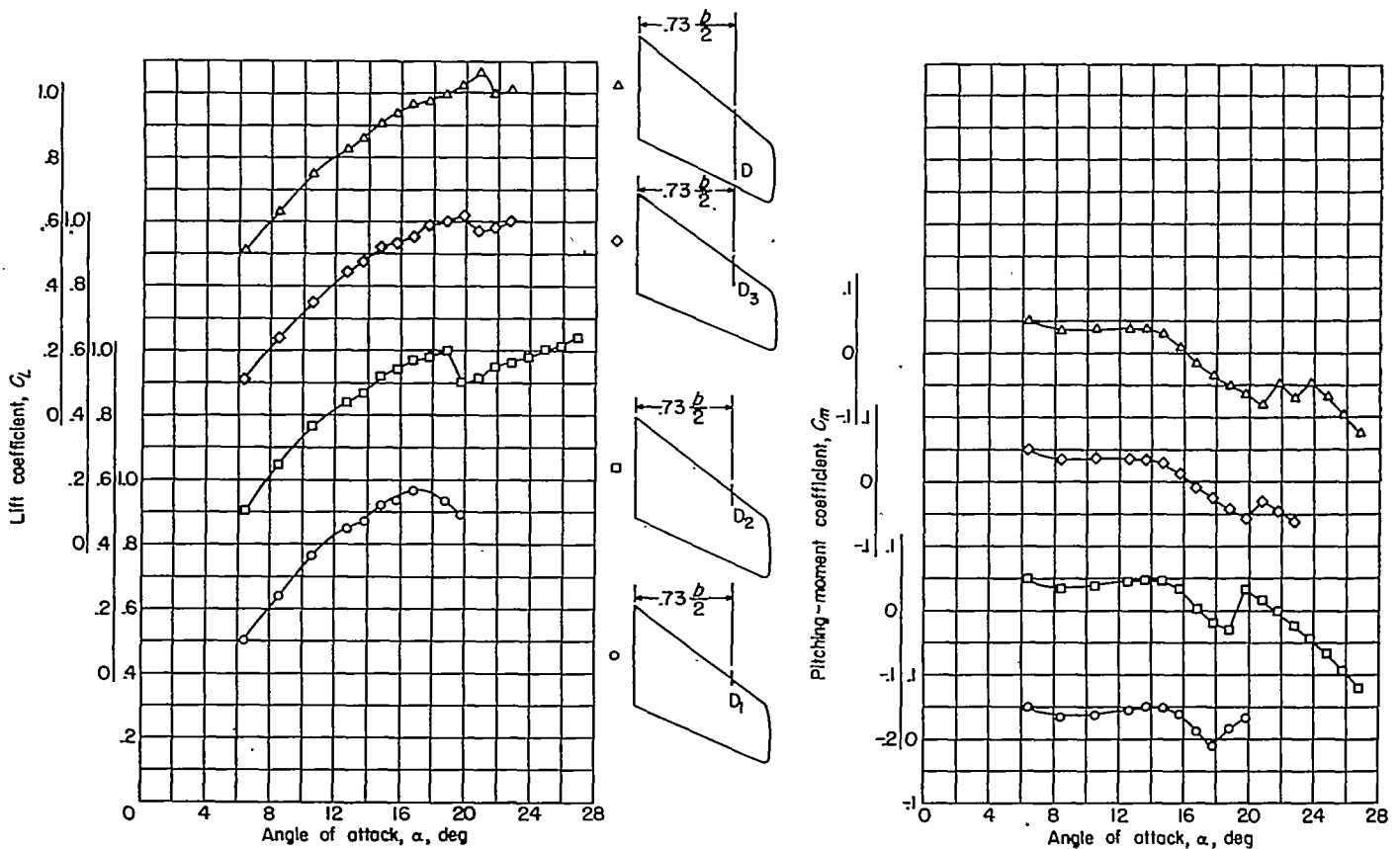

FIGURE 15.—Effect of length of fence D on the longitudinal stability characteristics of model 1. Slats, flaps, and landing gear retracted; high horizontal tail.

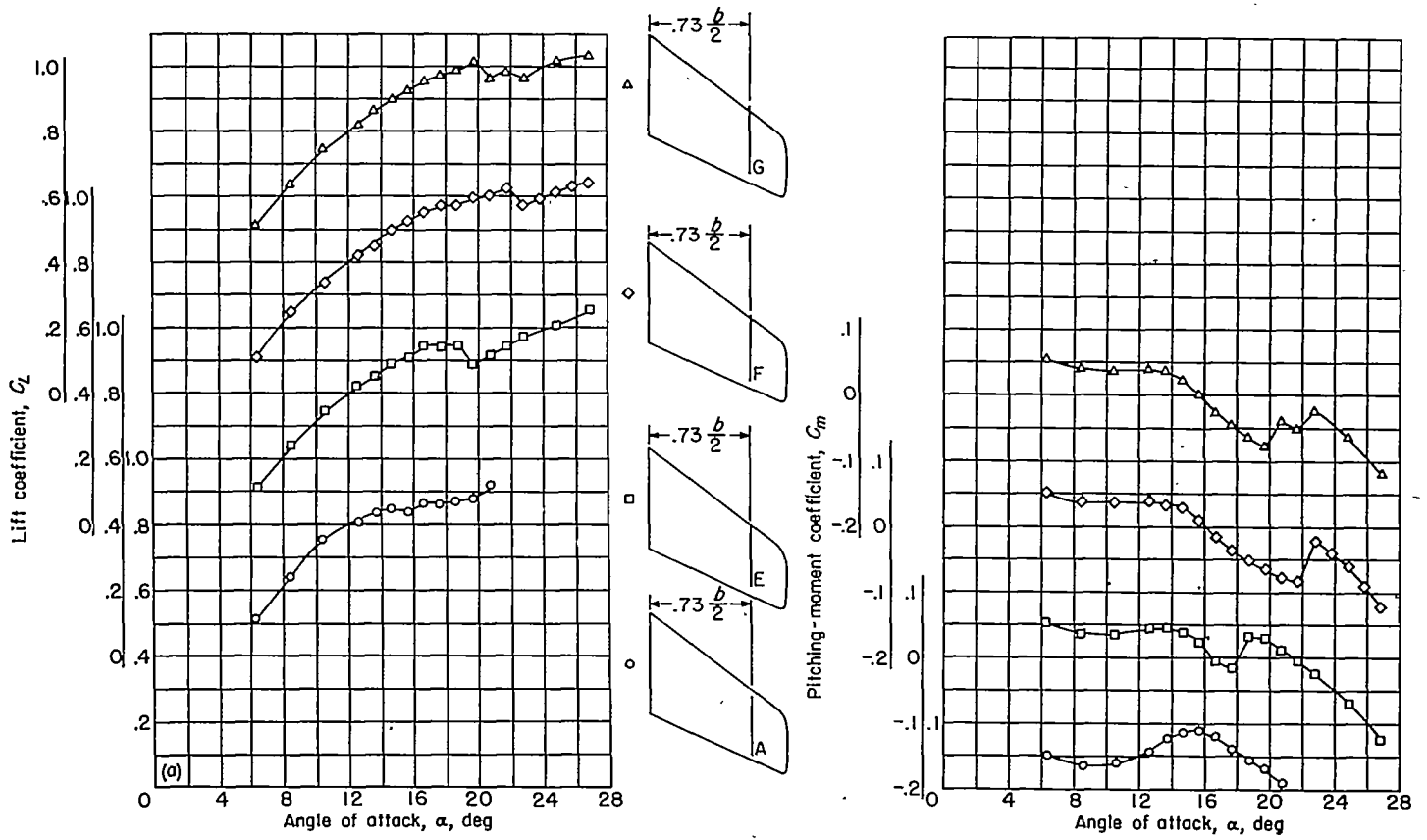

FIGURE 16.—Effect of fence shape on the longitudinal stability characteristics of model 1. Slats, flaps, and landing gear retracted; high horizontal tail.

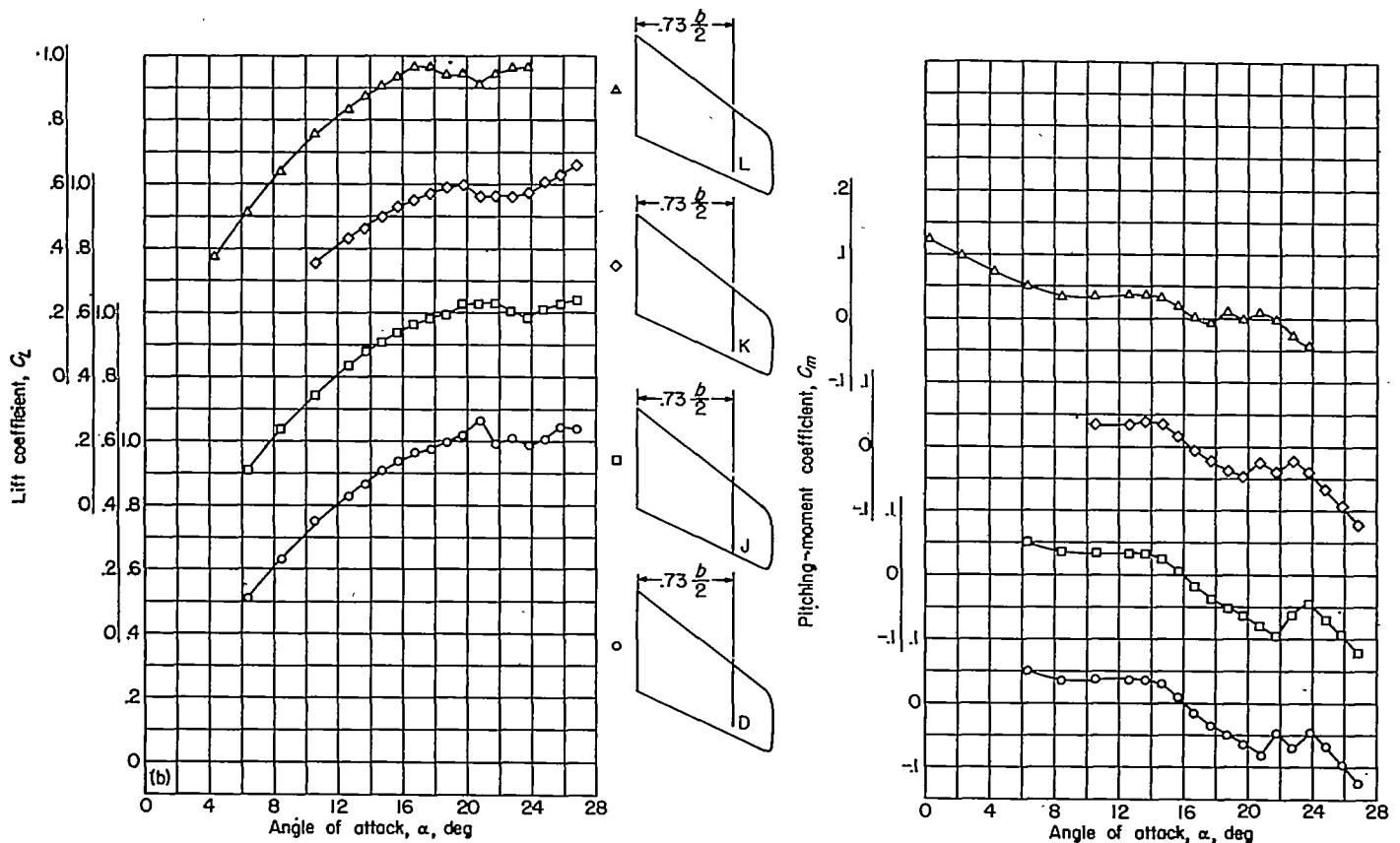

FIGURE 16.—Continued.

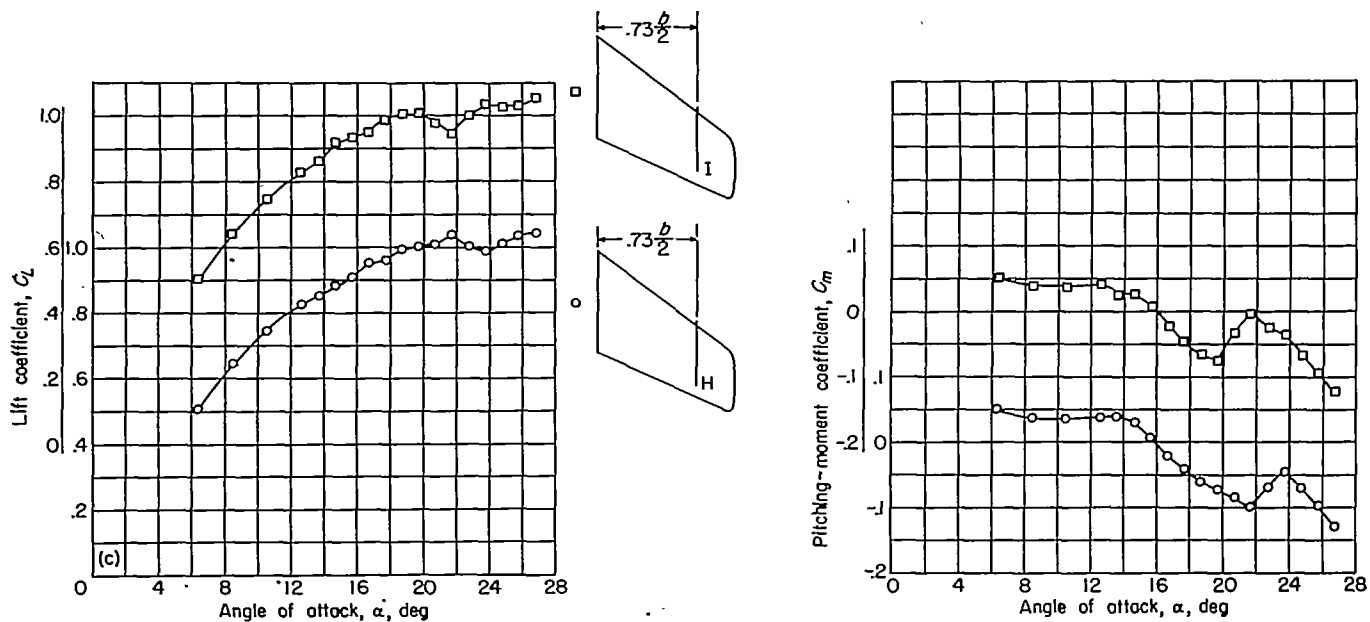

FIGURE 16.—Concluded.

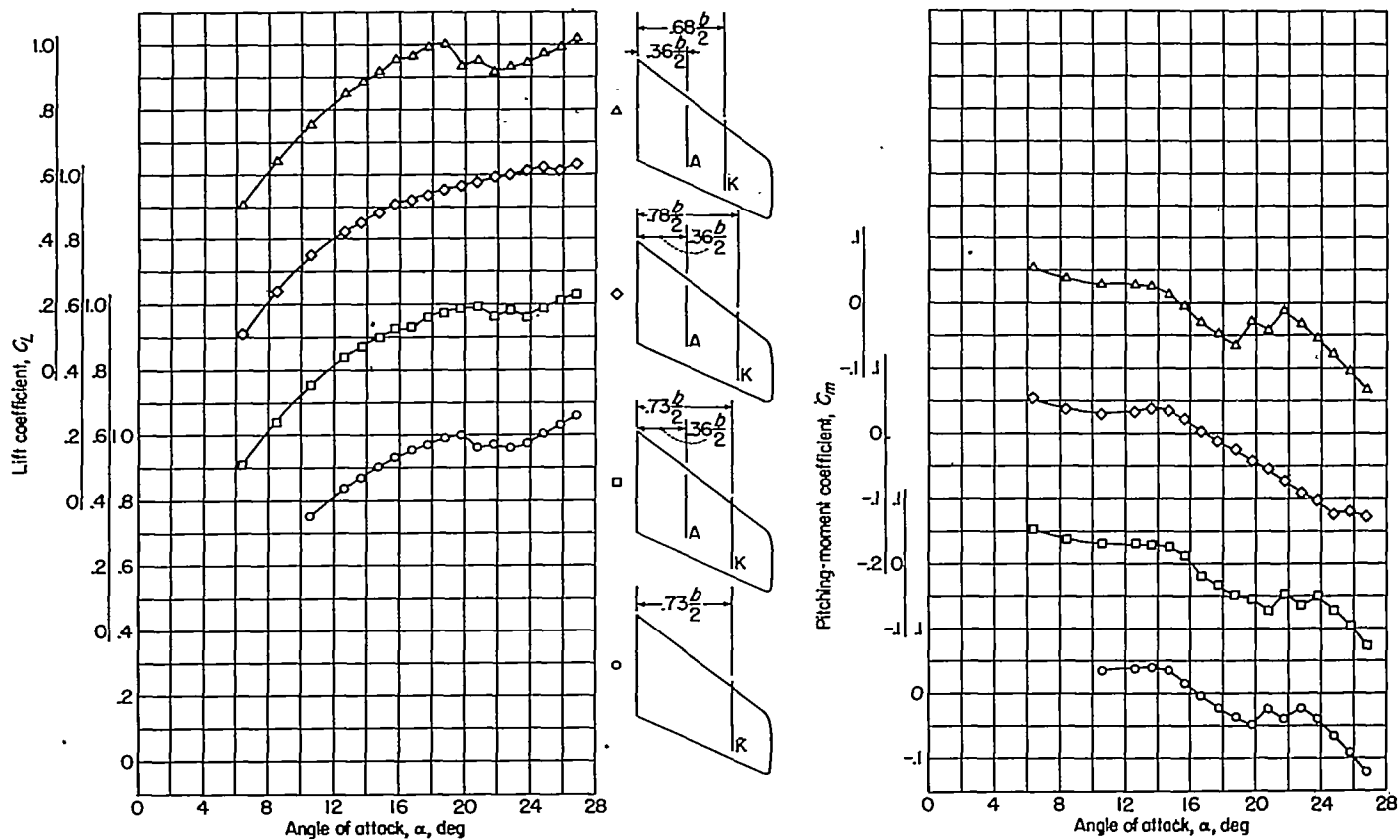

FIGURE 17.—Effect of various combinations of fences on the longitudinal stability characteristics of model 1. Slats, flaps, and landing gear retracted; high horizontal tail.

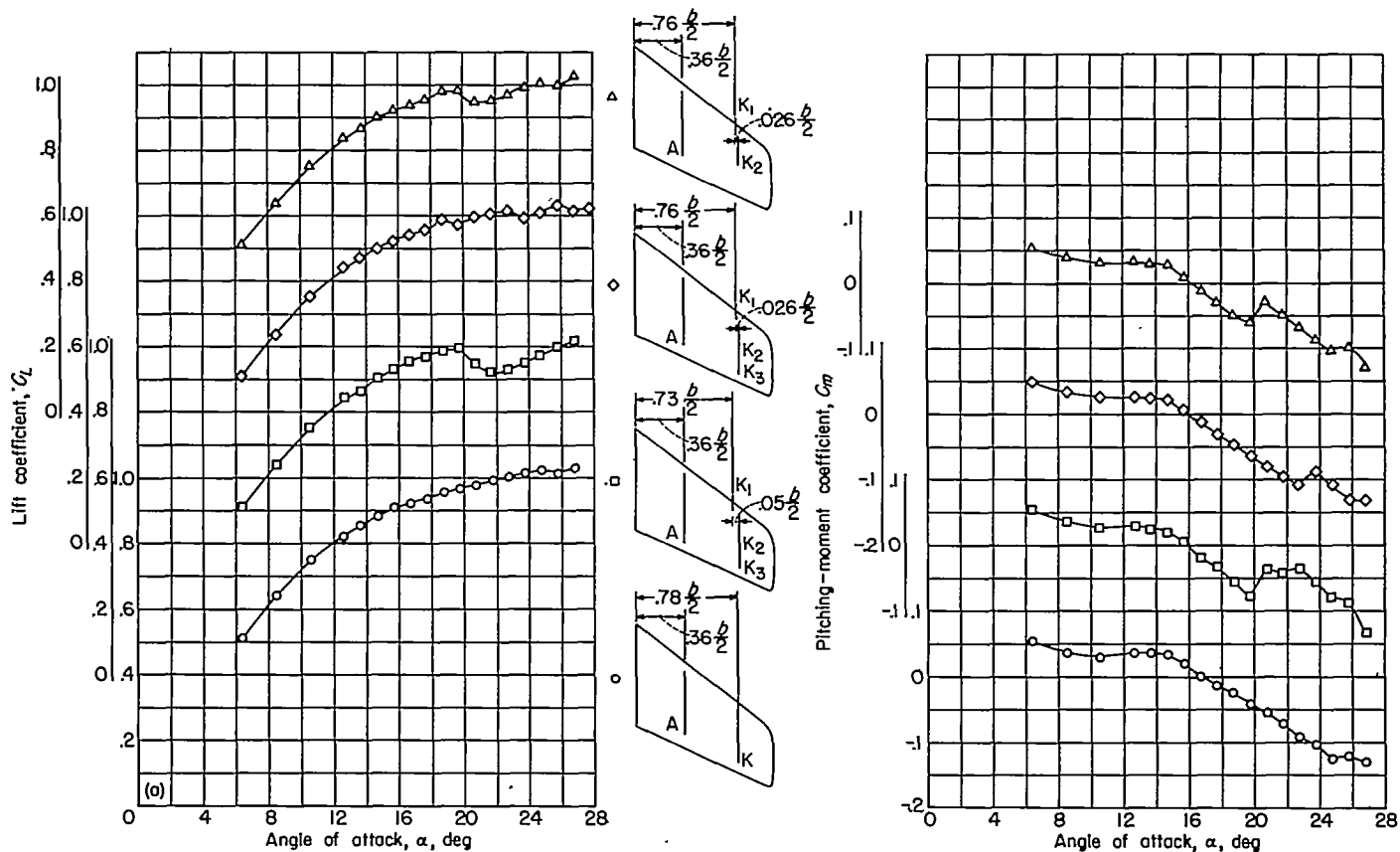

FIGURE 18.—Effect of fence A in combination with segments of fence K on the longitudinal stability characteristics of model 1. Slats, flaps, and landing gear retracted; high horizontal tail.

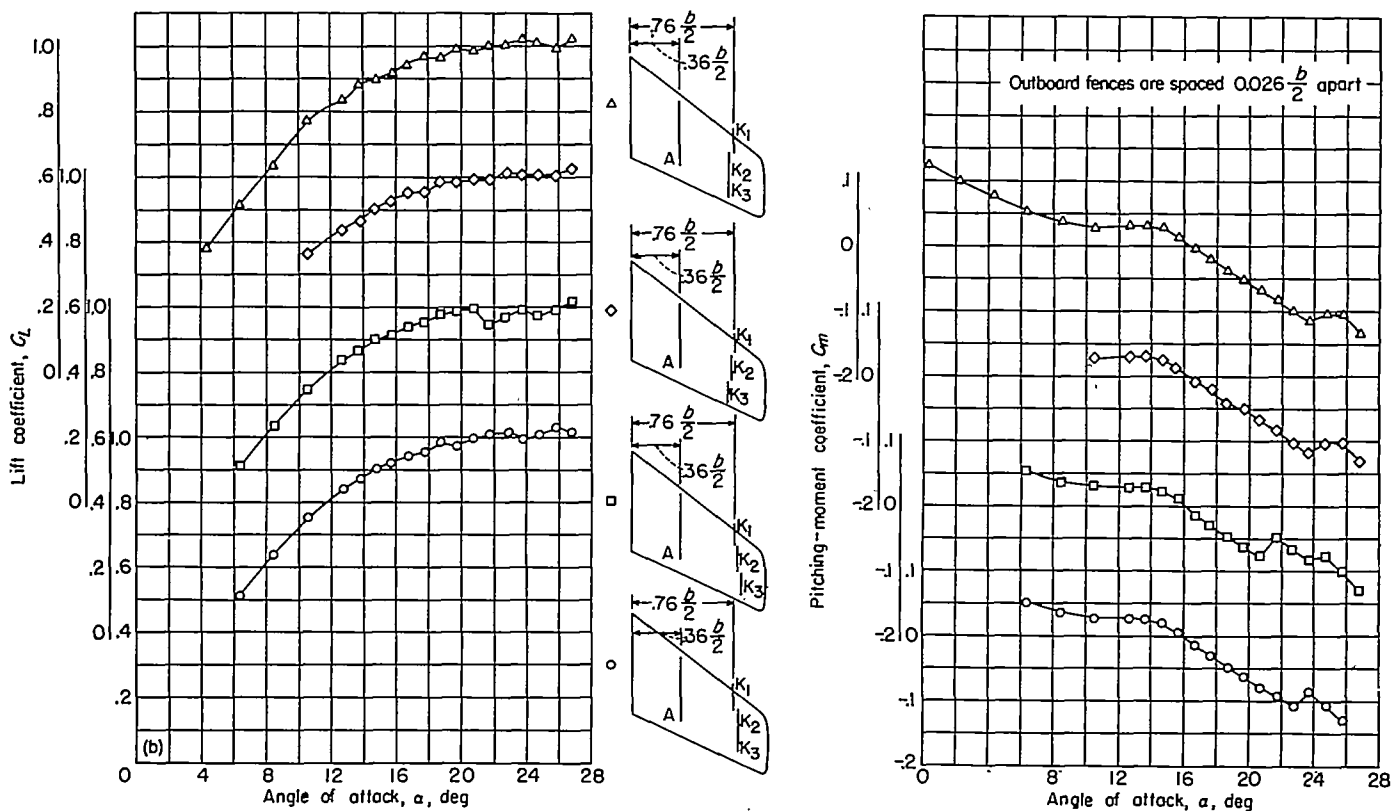
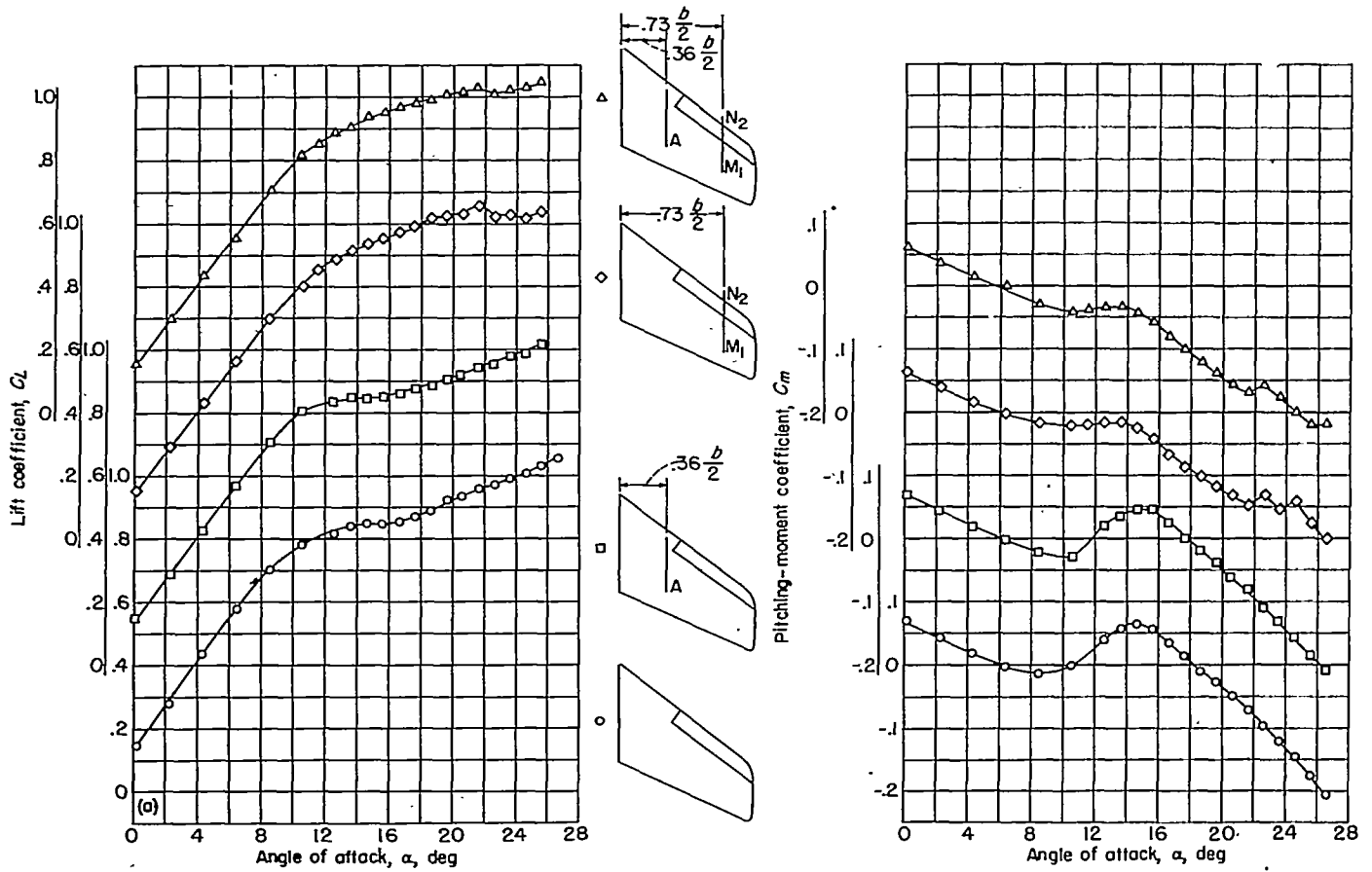
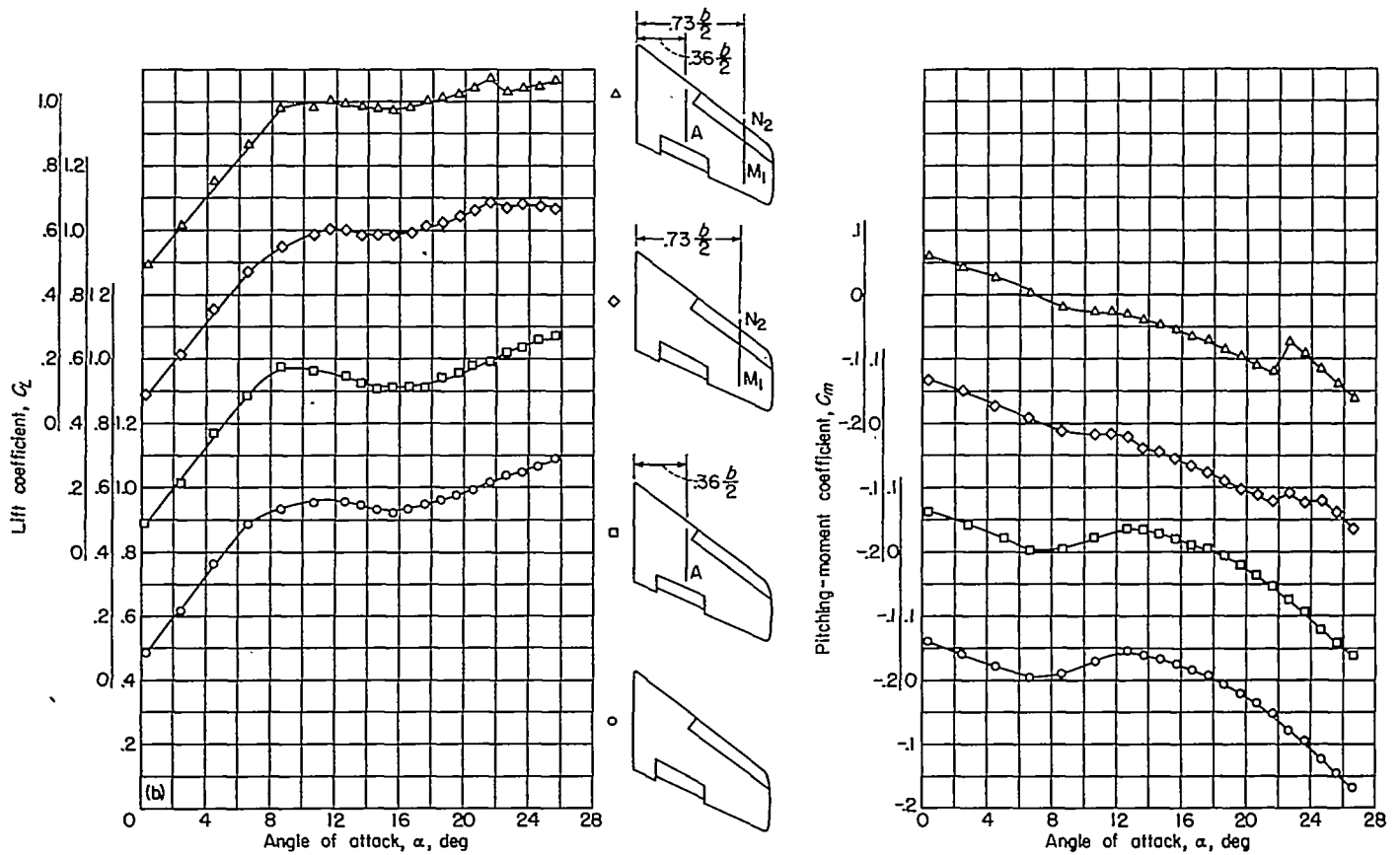

FIGURE 18.—Concluded.



(a) Slats, flaps, and landing gear retracted.

FIGURE 19.—Effect of fence A or N_2M_1 or both together on the longitudinal stability characteristics of model 2. High horizontal tail.



(b) Slats retracted and flaps and landing gear extended.

FIGURE 19.—Continued.

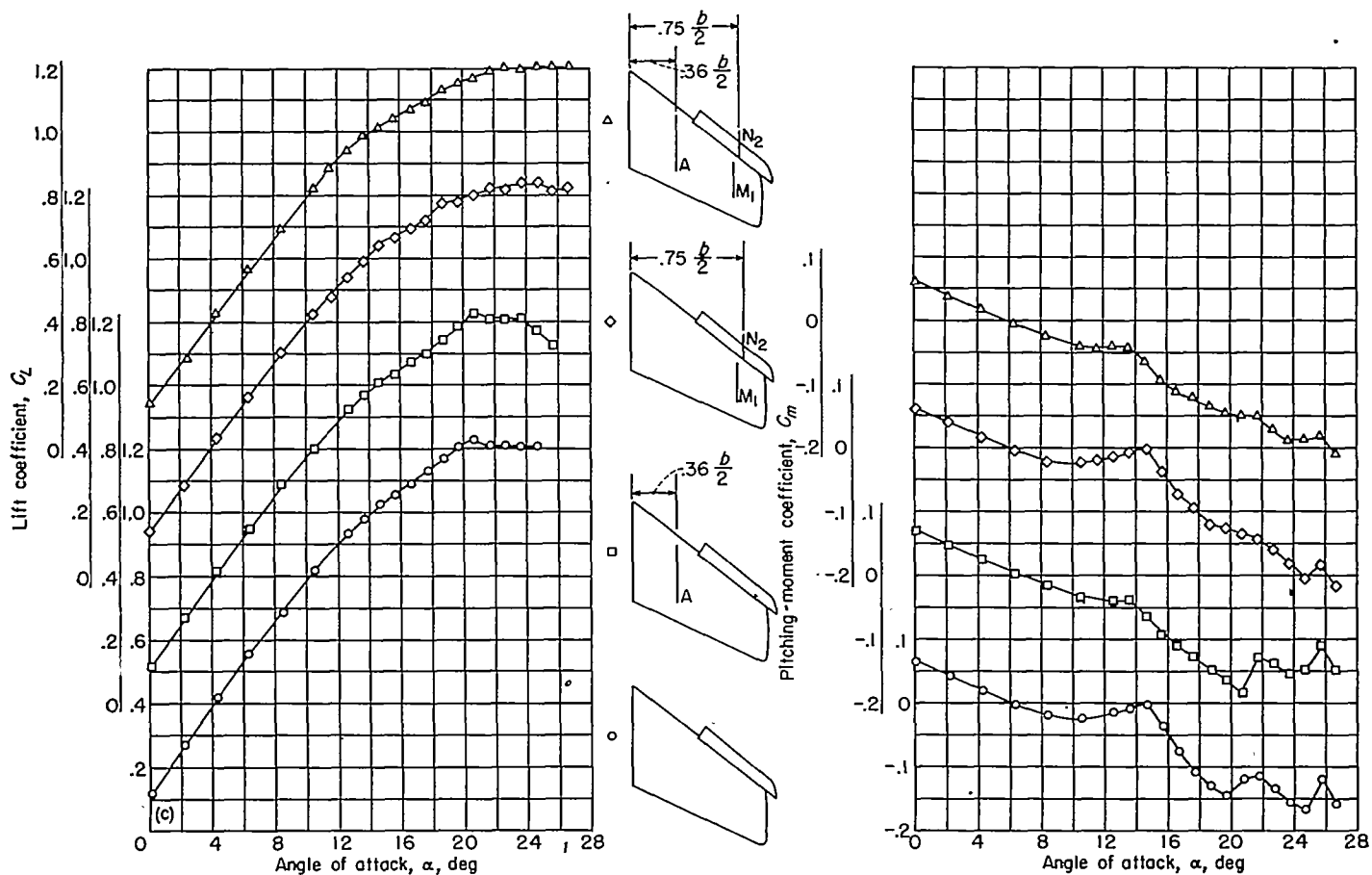

(c) Slats extended and flaps and landing gear retracted.

FIGURE 19.—Continued.

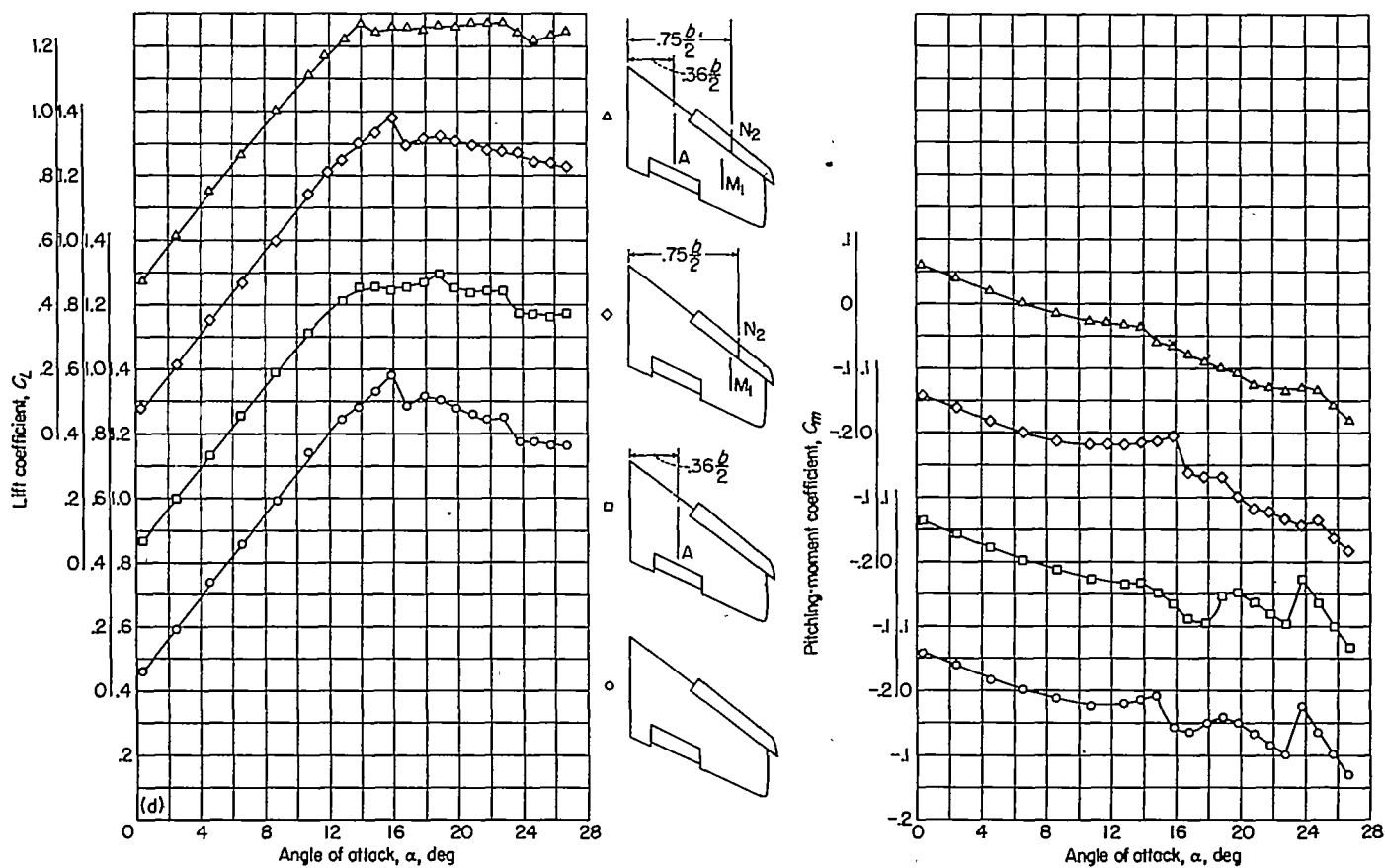

(d) Slats, flaps, and landing gear extended.

FIGURE 19.—Concluded.

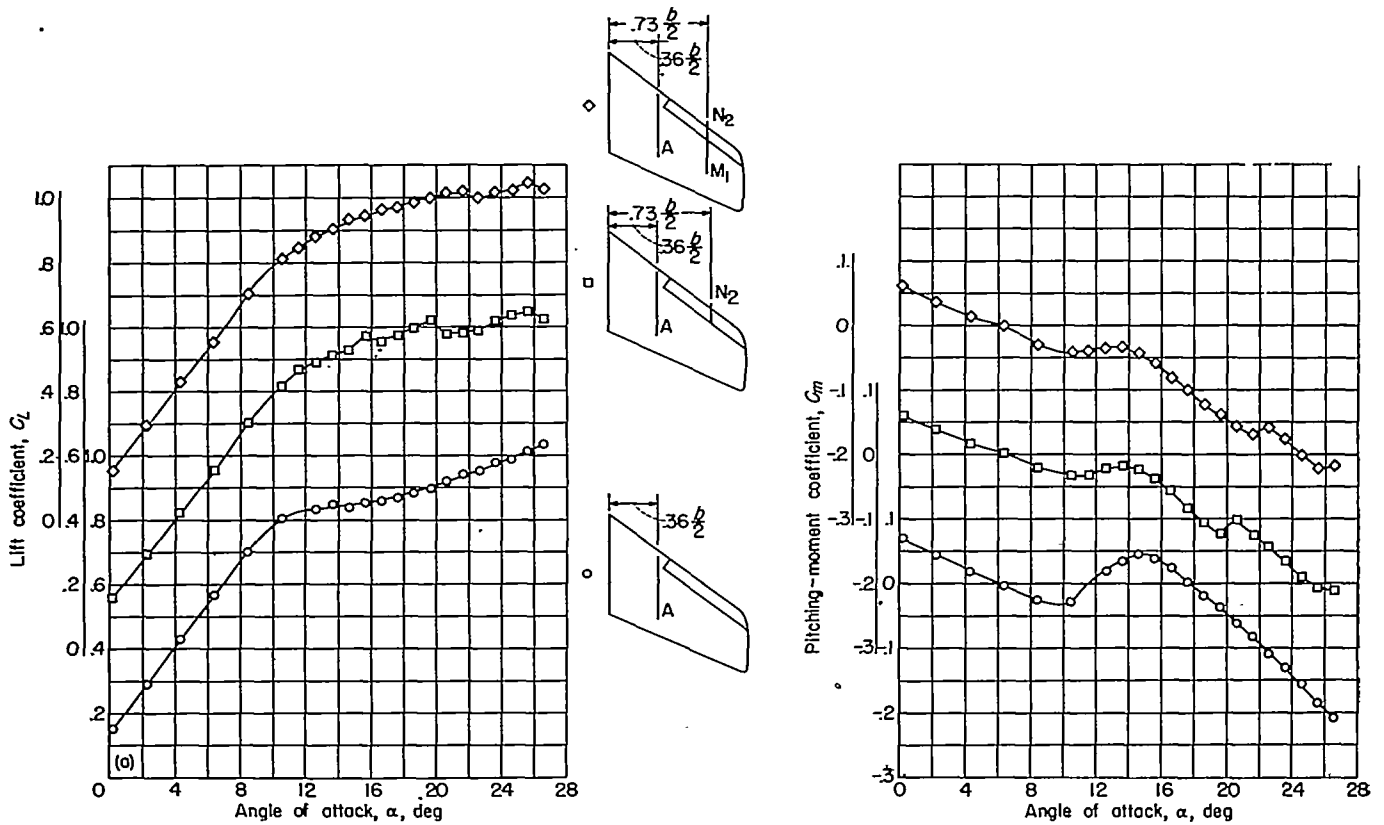

(a) Slats, flaps, and landing gear retracted.

FIGURE 20.—Effect of length of fence N_2M_1 on the longitudinal stability characteristics of model 2. High horizontal tail.

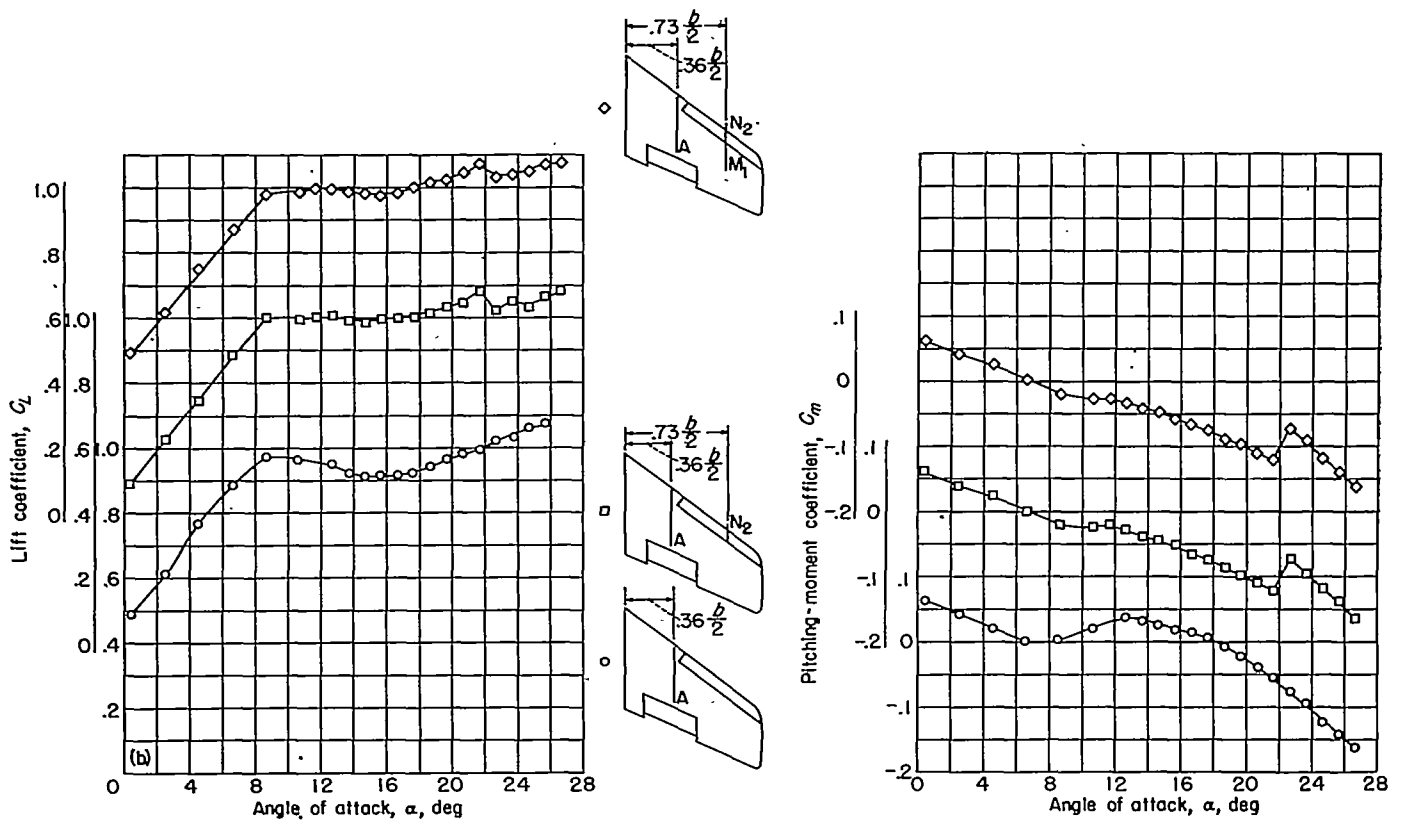

(b) Slats retracted and flaps and landing gear extended.

FIGURE 20.—Continued.

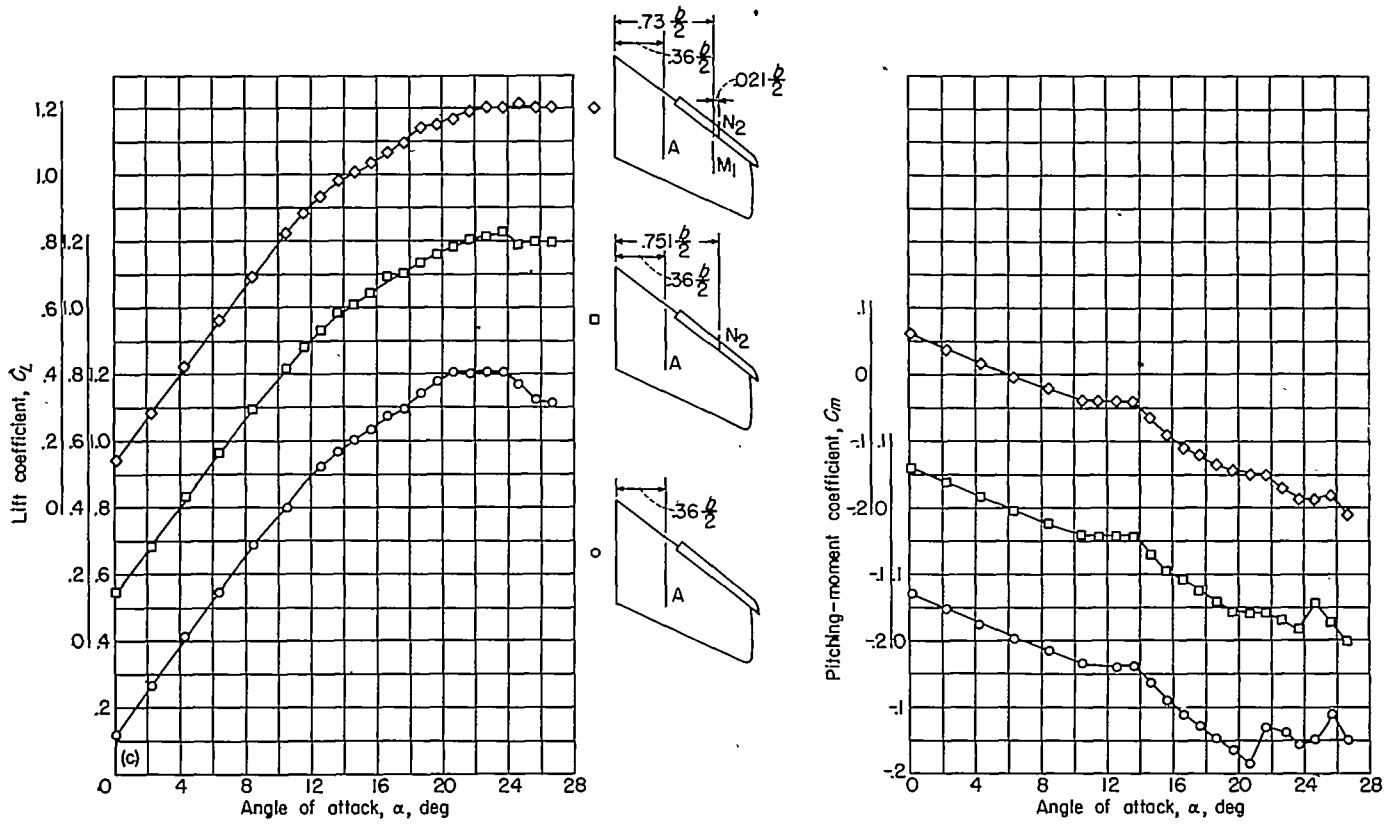

(c) Slats extended and flaps and landing gear retracted

FIGURE 20.—Continued.

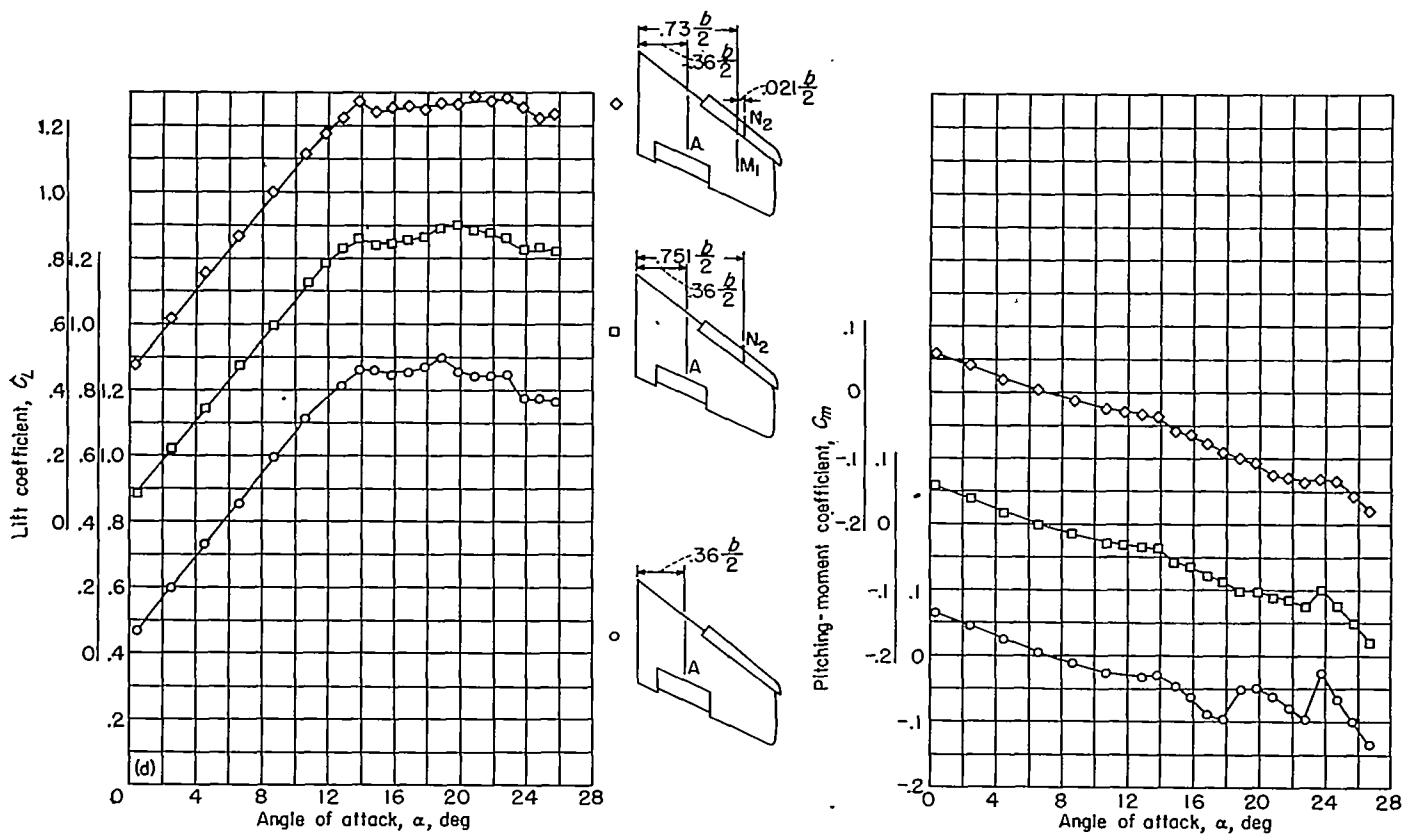

(d) Slats, flaps, and landing gear extended.

FIGURE 20—Concluded.

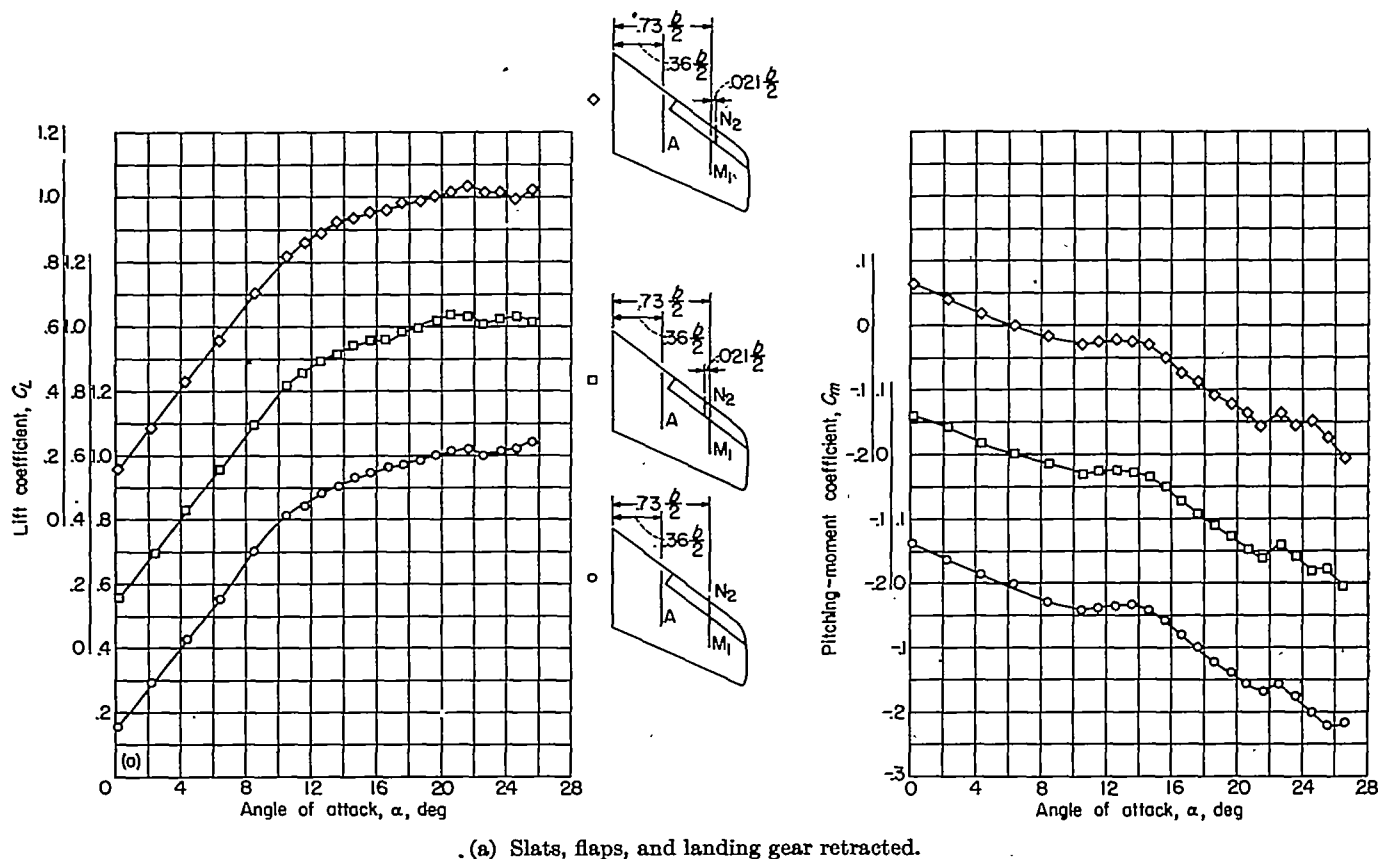

(a) Slats, flaps, and landing gear retracted.

FIGURE 21.—Effect of lateral displacement of segment N_2 relative to M_1 on the longitudinal stability characteristics of model 2. High horizontal tail.

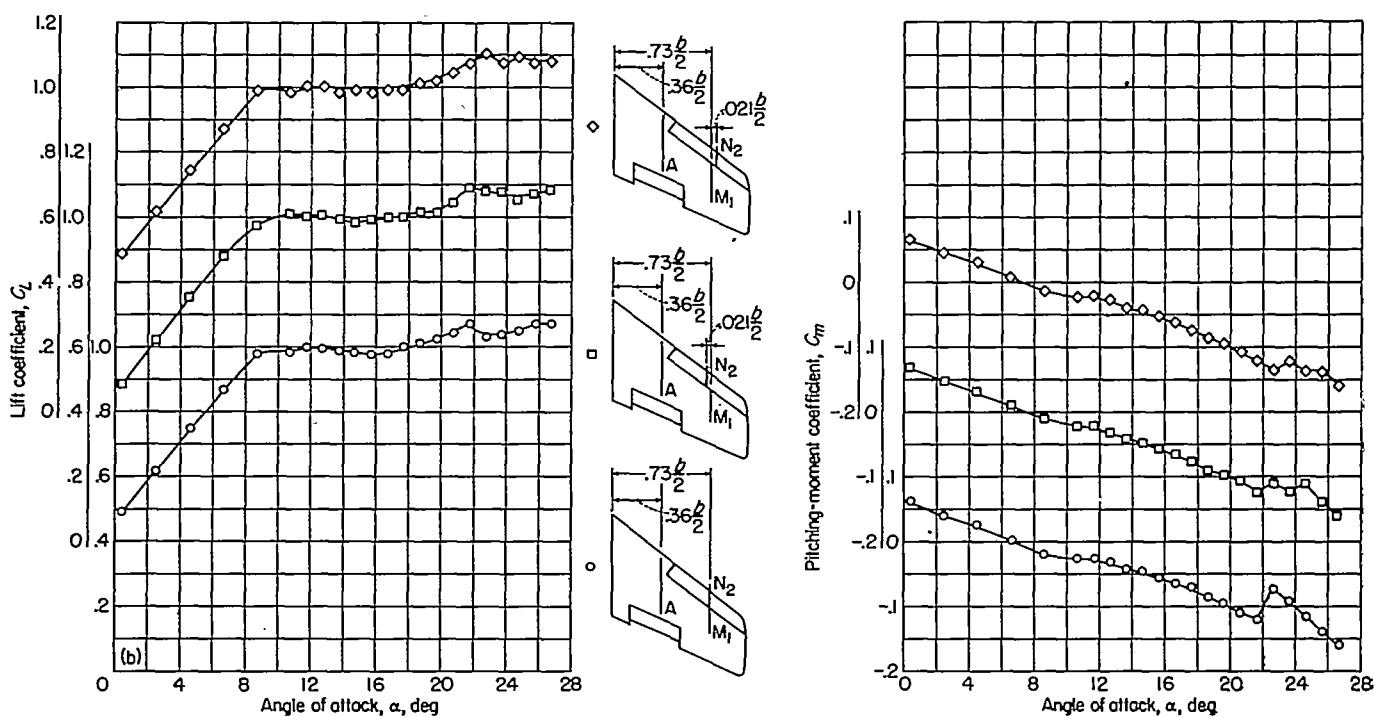

(b) Slats retracted and flaps and landing gear extended.

FIGURE 21.—Continued.

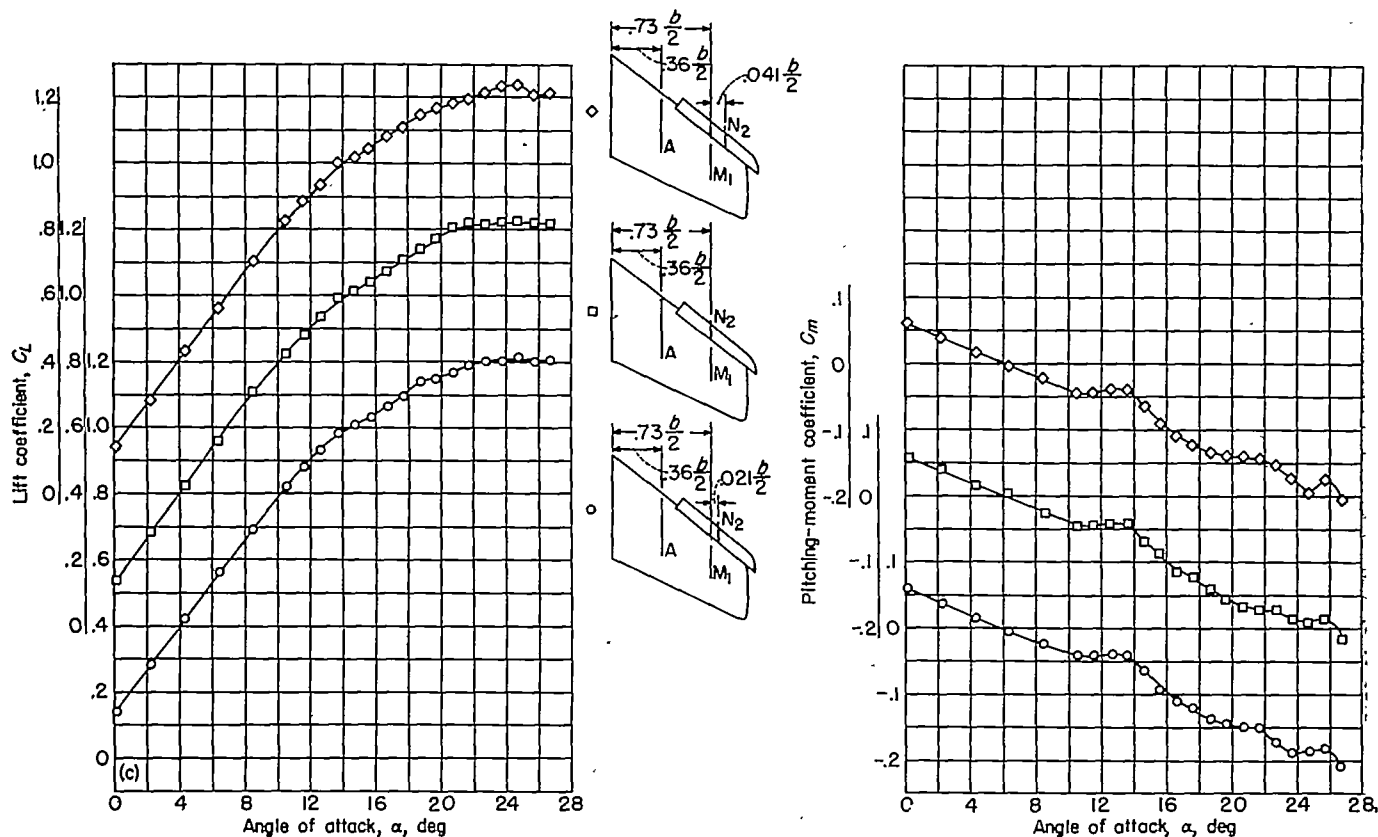

(c) Slats extended and flaps and landing gear retracted.

FIGURE 21.—Continued.

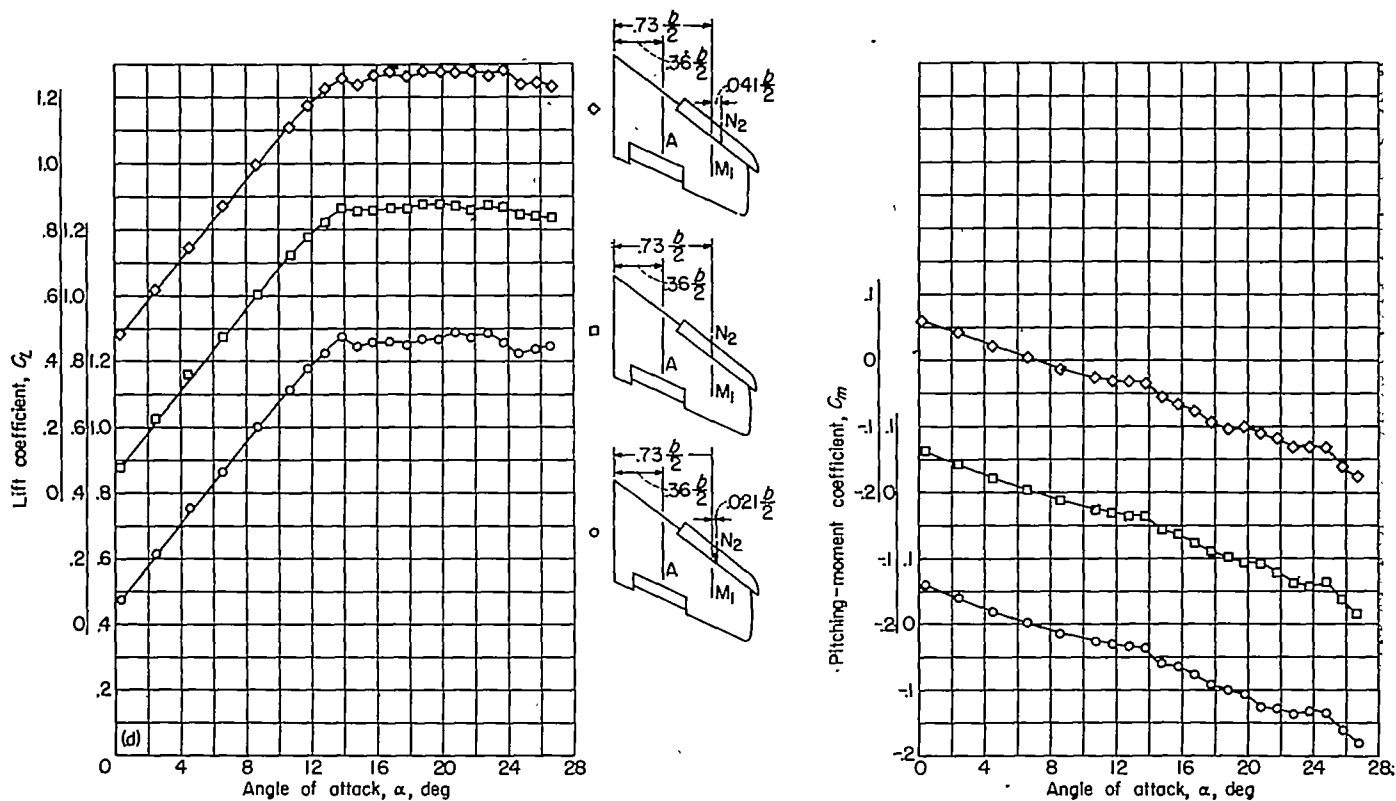

(d) Slats, flaps, and landing gear extended.

FIGURE 21.—Concluded.

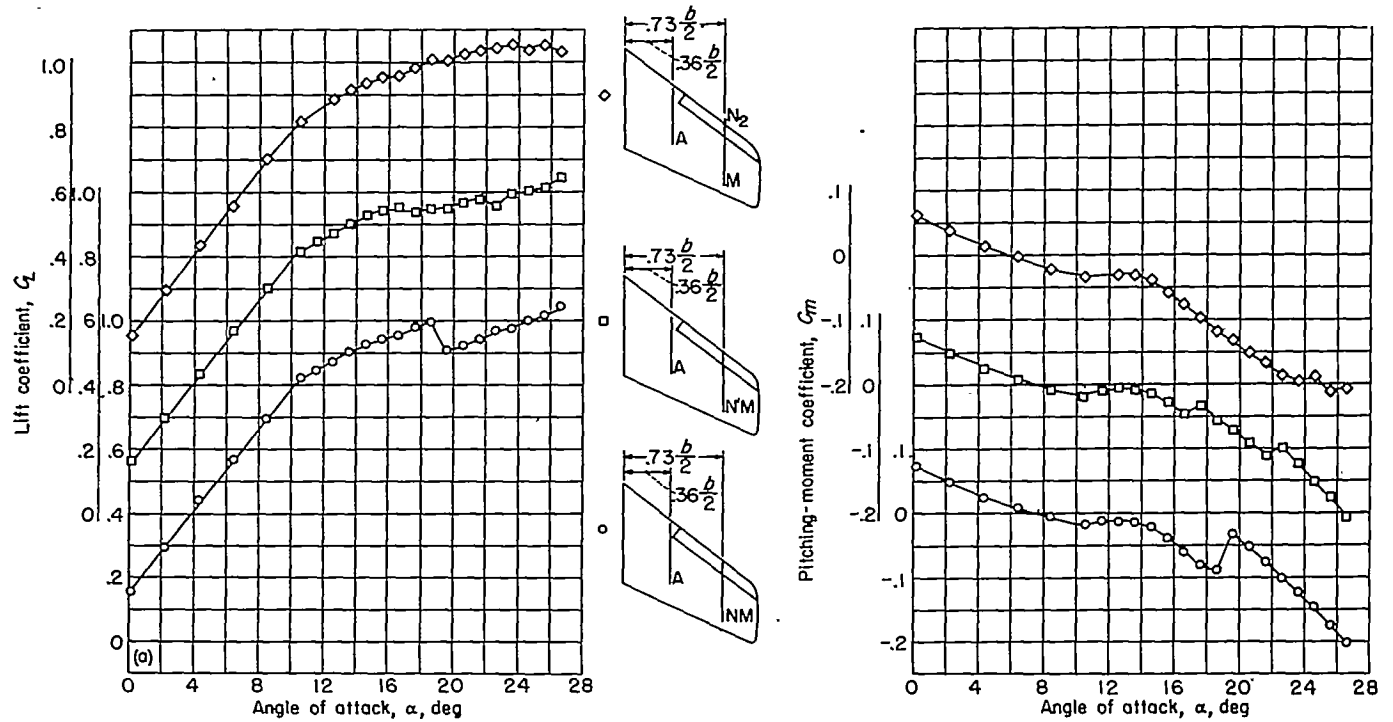

(a) Slats, flaps, and landing gear retracted.

FIGURE 22.—Effect of fences NM , $N'M$, and $NM+N_2$, on the longitudinal stability characteristics of model 2. High horizontal tail.

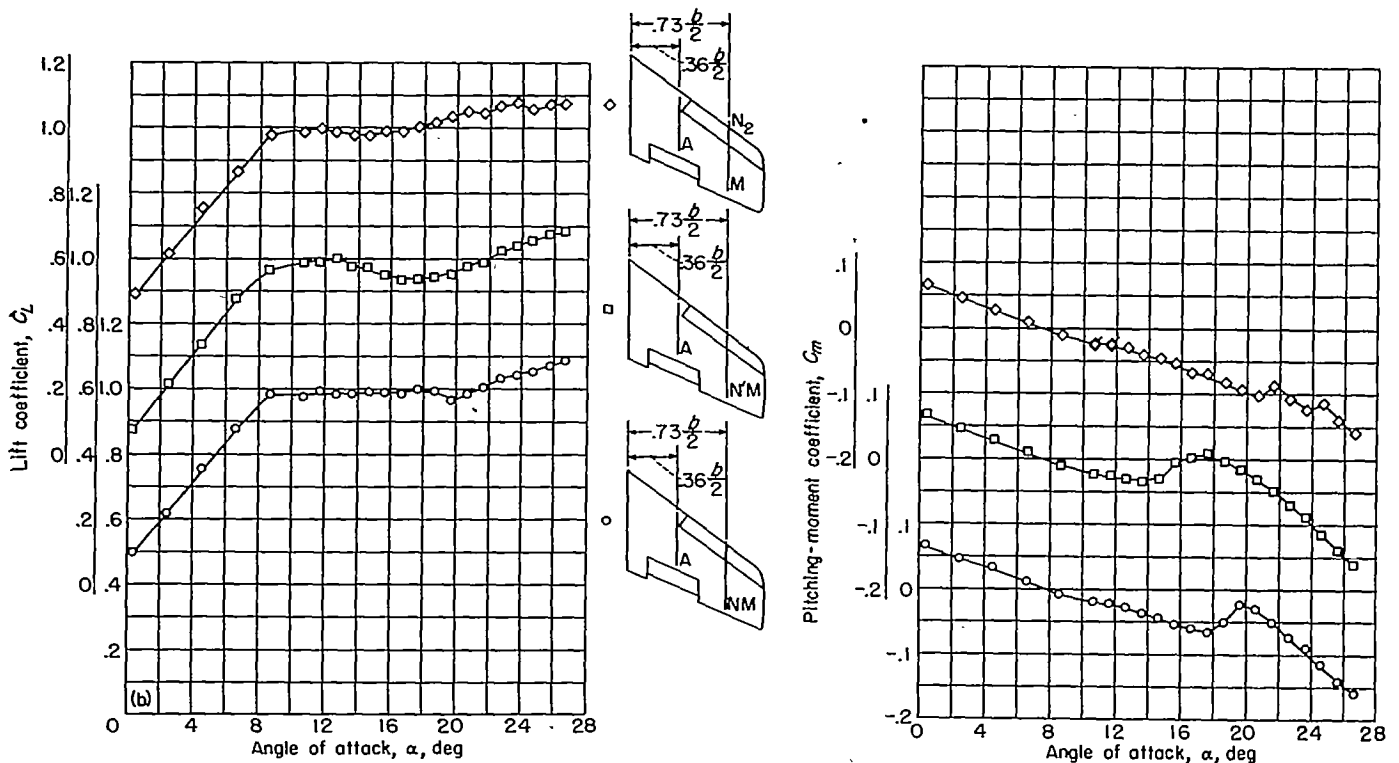

(b) Slats retracted and flaps and landing gear extended.

FIGURE 22.—Continued.

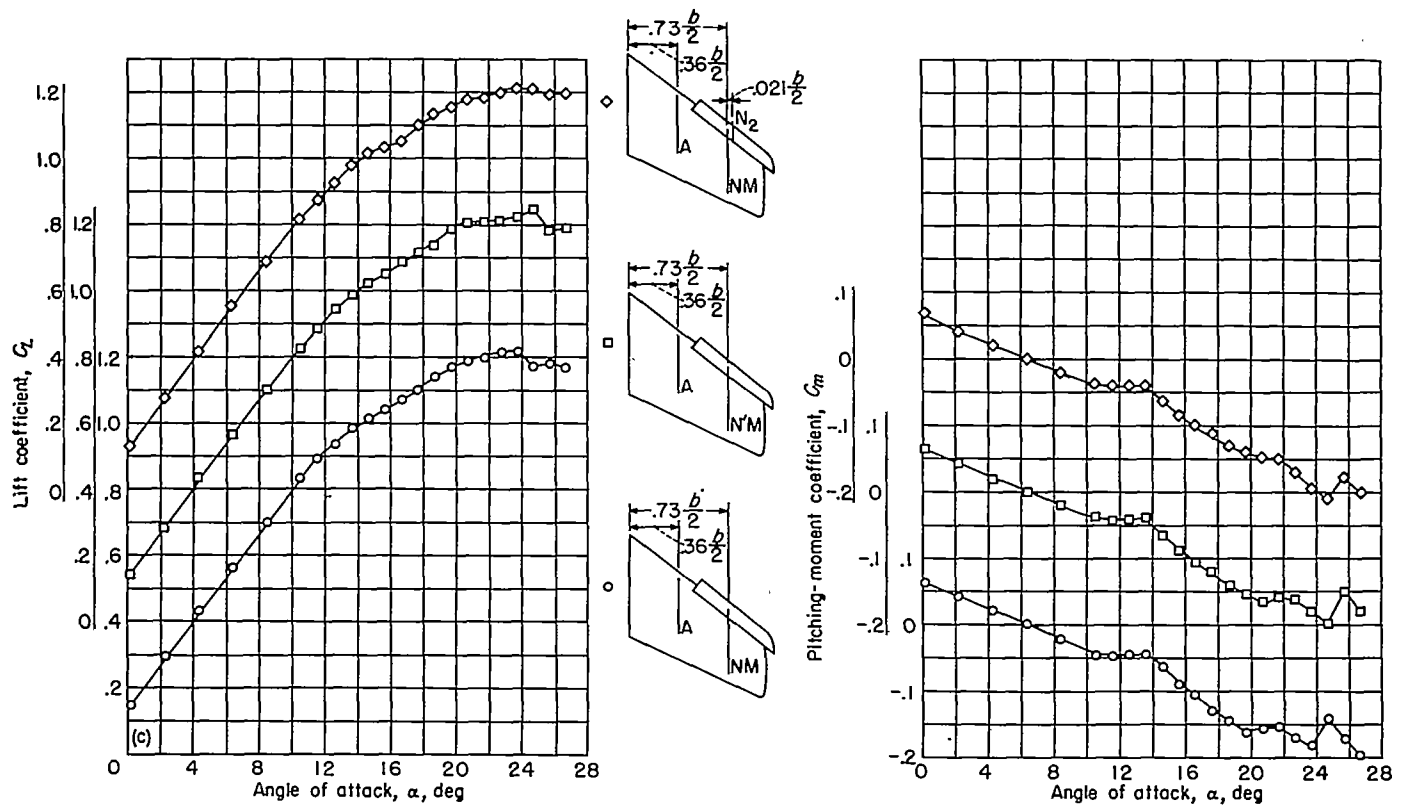

(c) Slats extended and flaps and landing gear retracted.

FIGURE 22.—Continued.

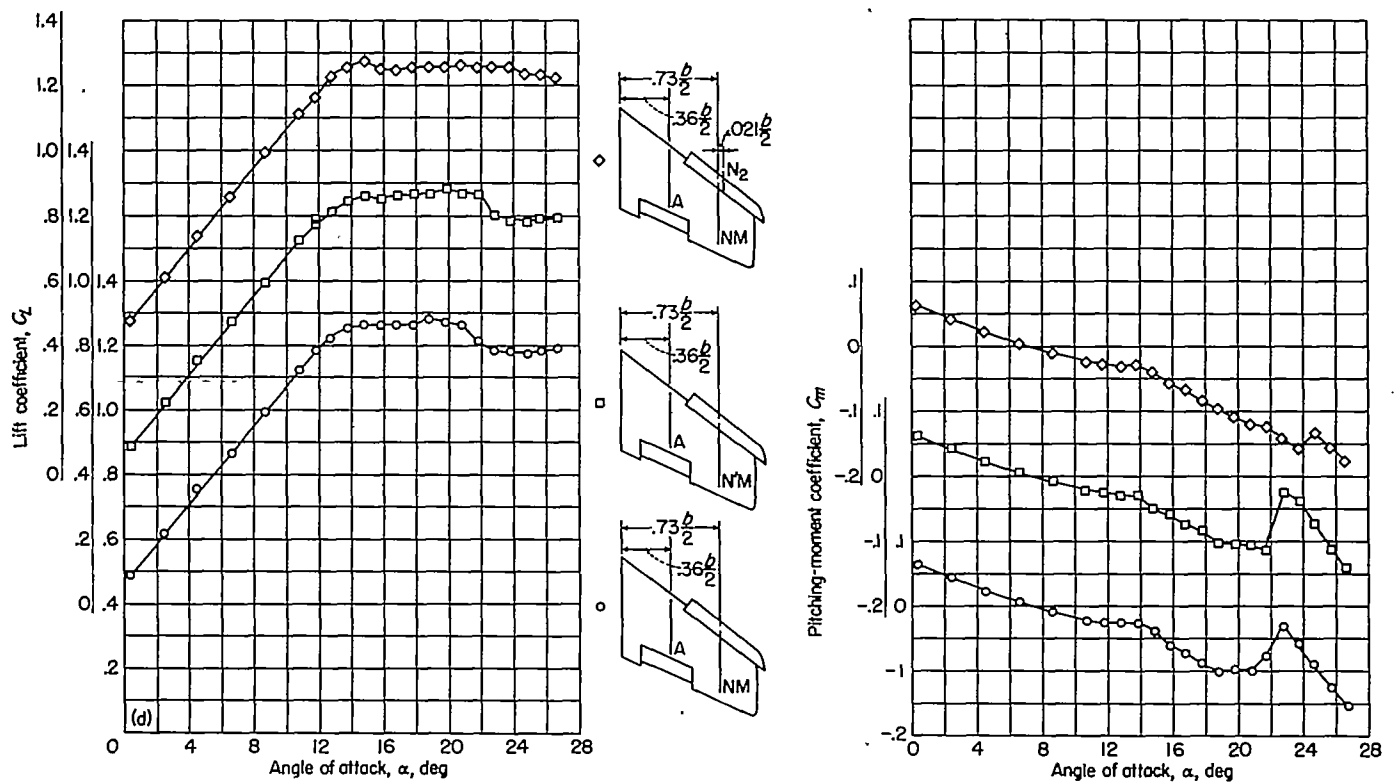

(d) Slats, flaps, and landing gear extended.

FIGURE 22.—Concluded.

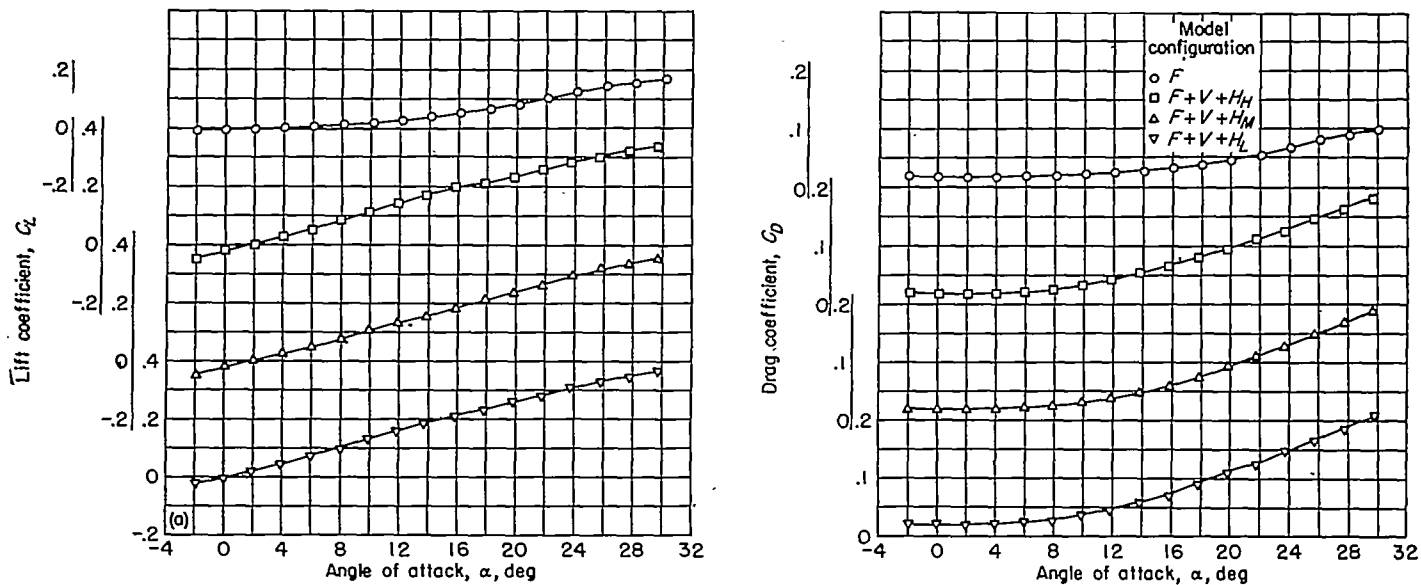

(a) Lift and drag characteristics.

FIGURE 23.—Longitudinal aerodynamic characteristics of various model configurations with wing off. Model 2.

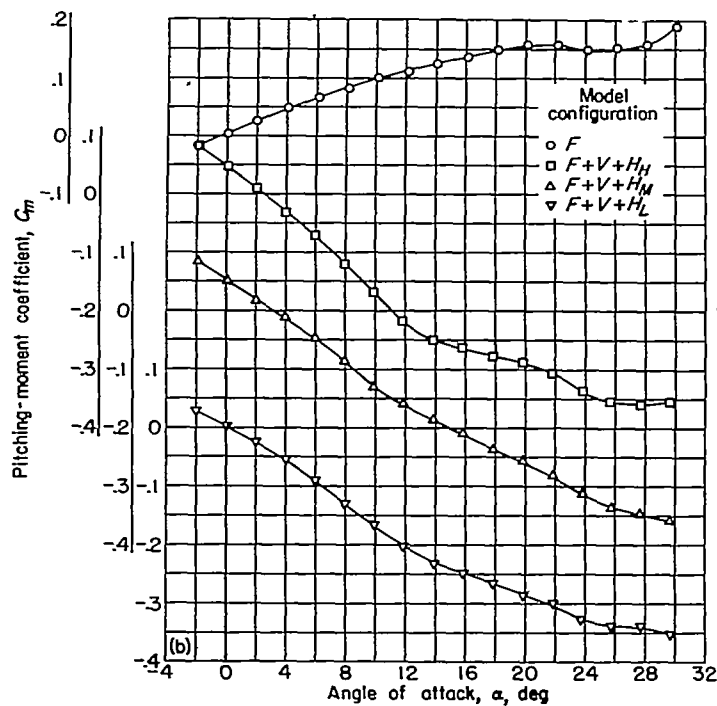

(b) Pitching-moment characteristics.

FIGURE 23.—Concluded.

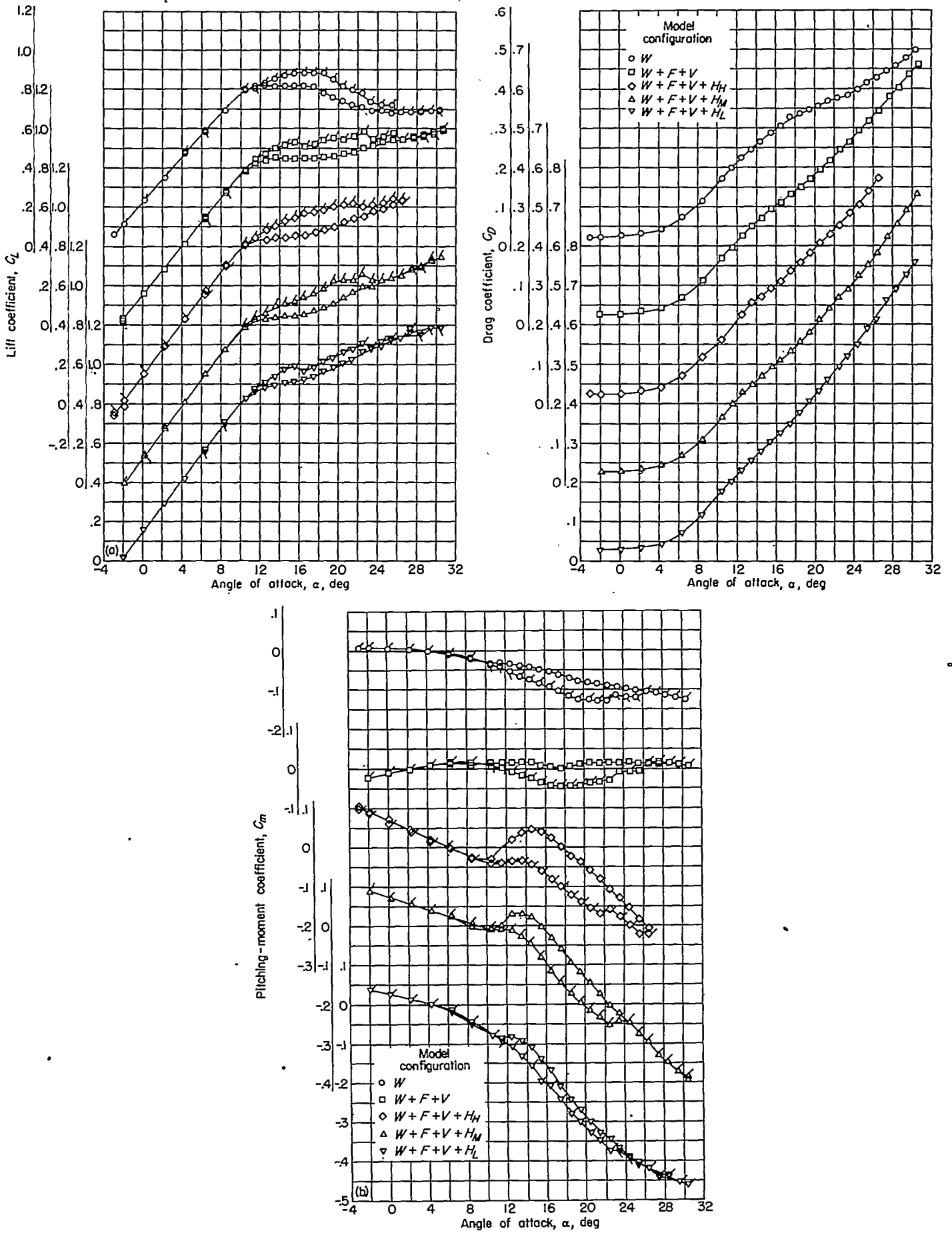

(a) Lift and drag characteristics. (b) Pitching-moment characteristics.

FIGURE 24.—Longitudinal aerodynamic characteristics of various model configurations with slats, flaps, and landing gear retracted. Model 2. Plain symbols indicate fence A on model and flagged symbols indicate fences A and N₂M₁ on model.

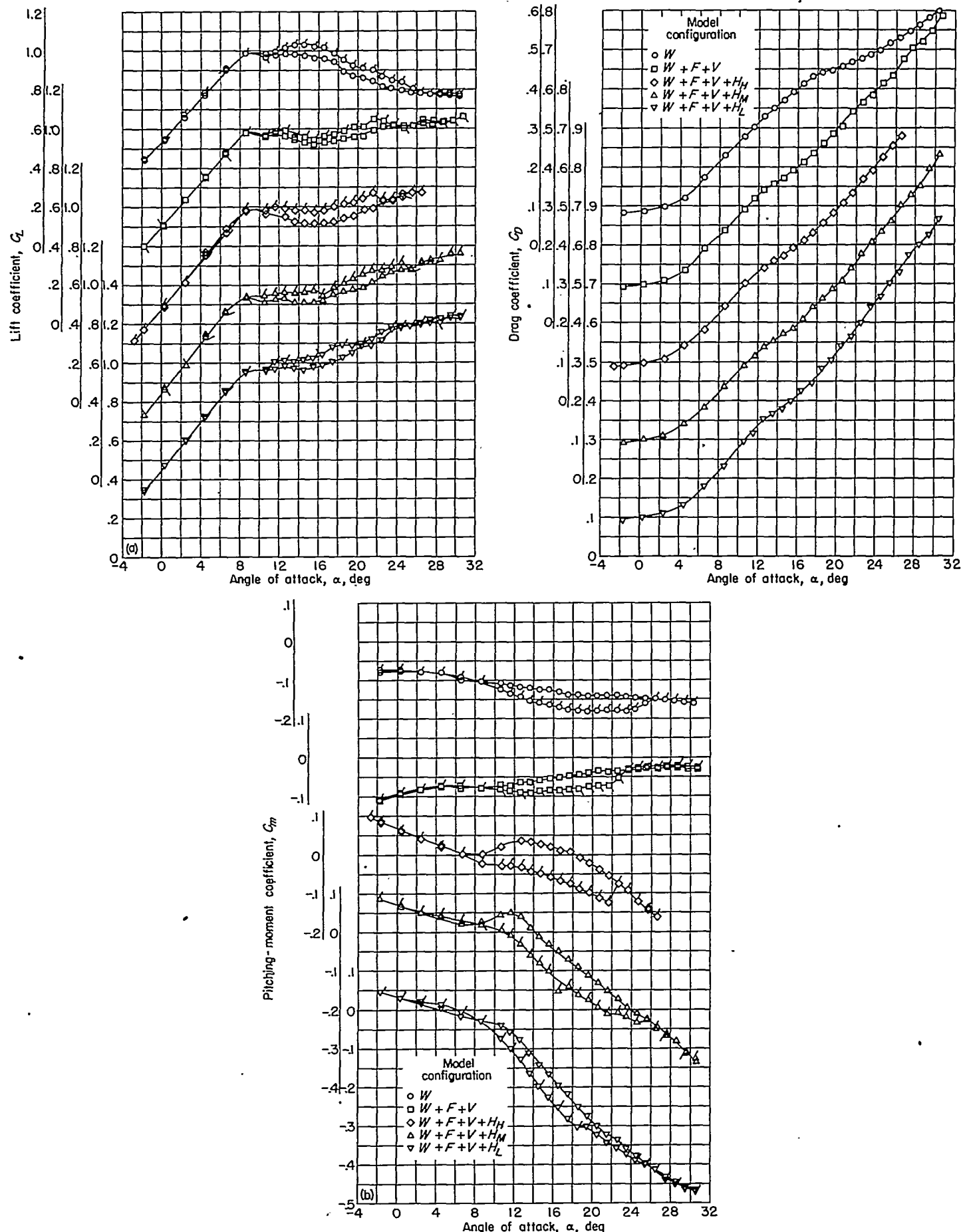

(a) Lift and drag characteristics. (b) Pitching-moment characteristics.

FIGURE 25.—Longitudinal aerodynamic characteristics of various model configurations with slats retracted, flaps and landing gear extended. Model 12. Pl-in symbols indicate fence A on model and flagged symbols indicate fences A and N_2M_1 on model.

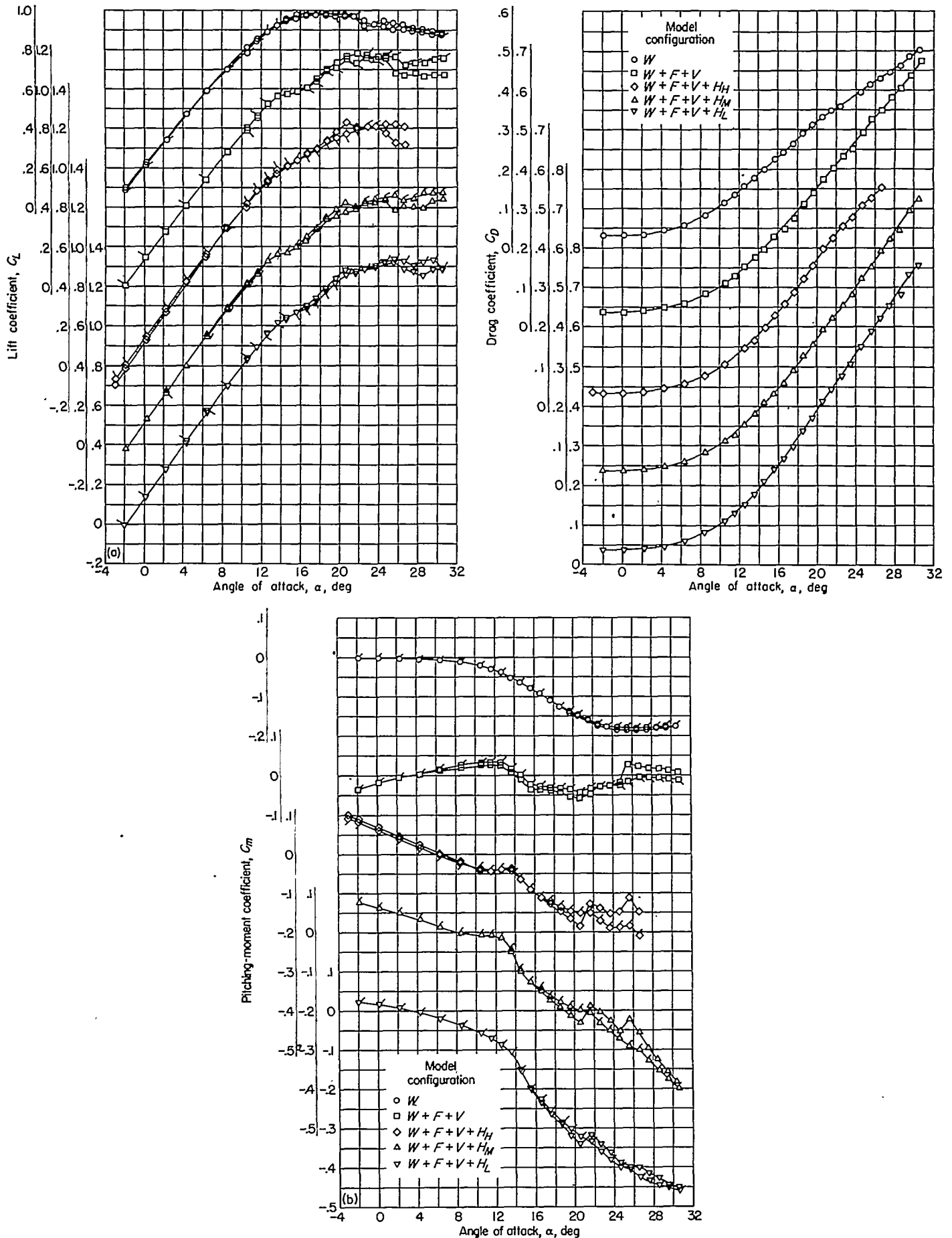

(a) Lift and drag characteristics. (b) Pitching-moment characteristics.

FIGURE 26.—Longitudinal aerodynamic characteristics of various model configurations with slats extended, flaps and landing gear retracted. Model 2. Plain symbols indicate fence A on model and flagged symbols indicate fences A and N_2M_1 on model.

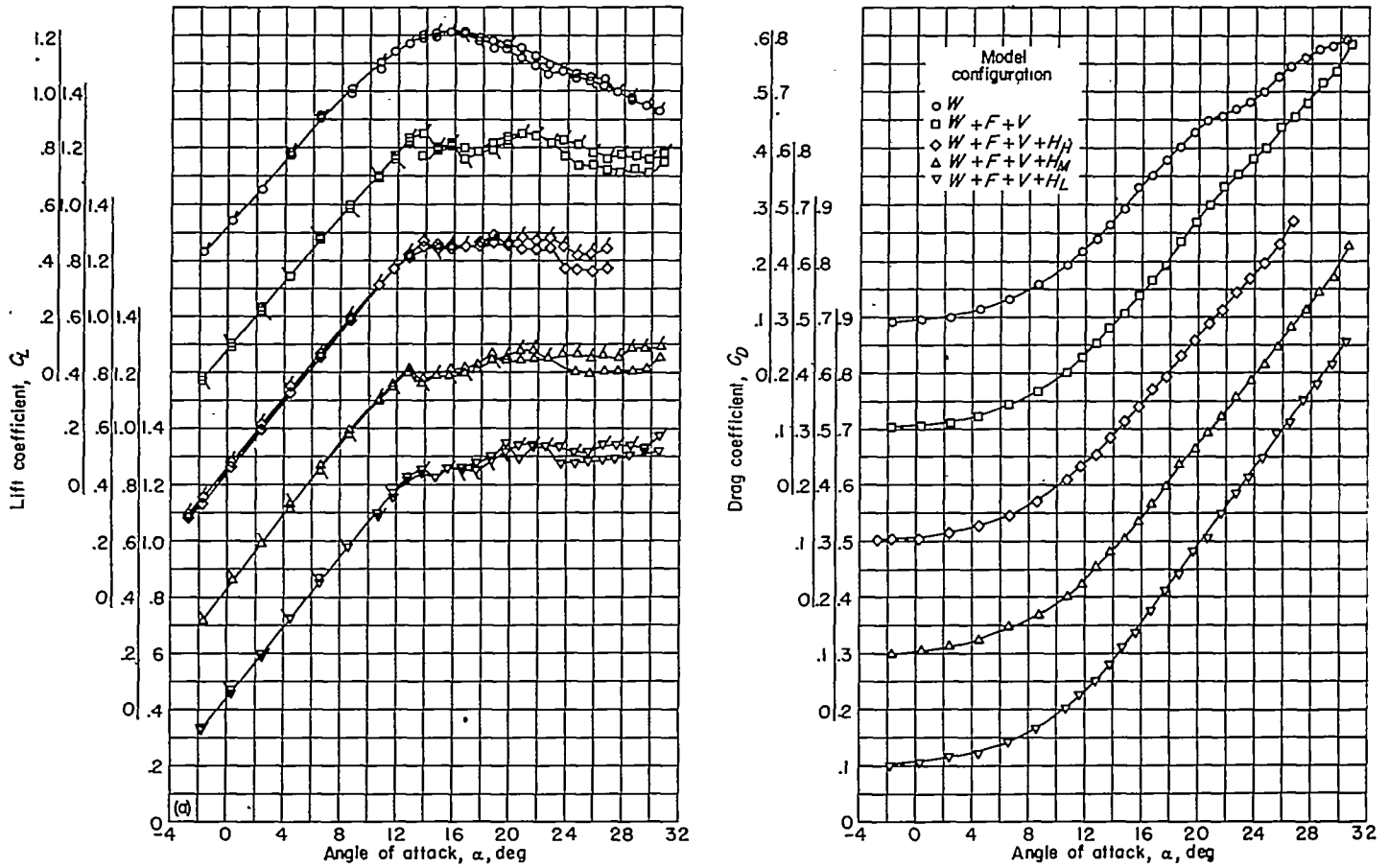

(a) Lift and drag characteristics.

FIGURE 27.—Longitudinal aerodynamic characteristics of various model configurations with slats, flaps, and landing gear extended. Model 2. Plain symbols indicate fence A on model and flagged symbols indicate fences A and N_2M_1 on model.

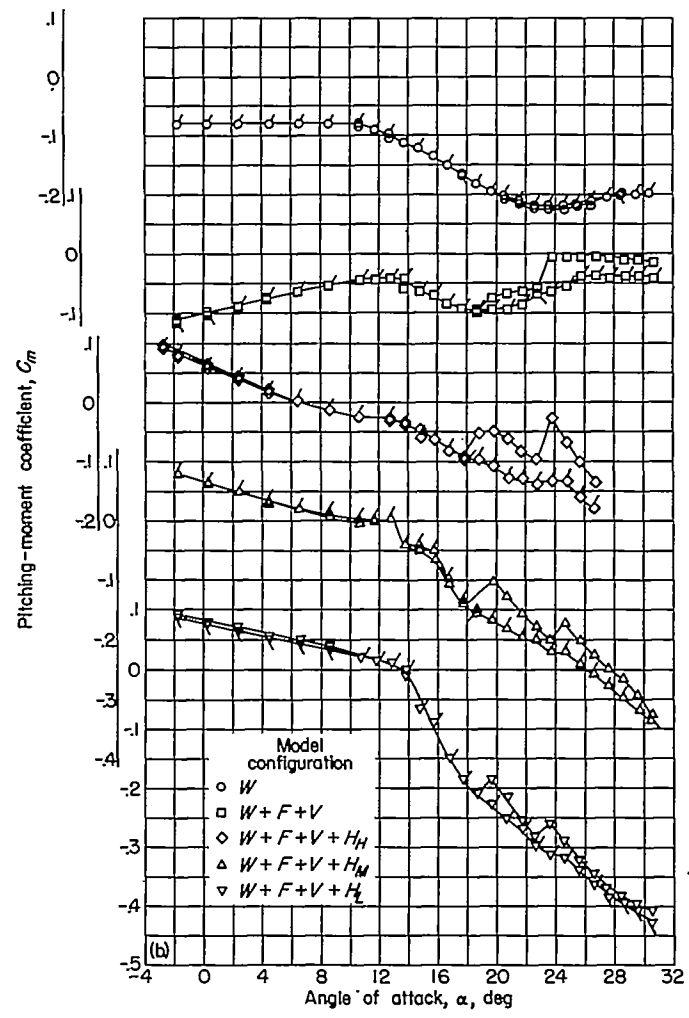

(b) Pitching-moment characteristics.

FIGURE 27.—Concluded.

