

REPORT 1298

AN ANALYSIS OF THE EFFECTS OF AEROELASTICITY ON STATIC LONGITUDINAL STABILITY AND CONTROL OF A SWEEP-WING AIRPLANE ¹

By RICHARD B. SKOOG

SUMMARY

A theoretical analysis has been made of the effects of aeroelasticity on the stick-fixed static longitudinal stability and elevator angle required for balance of an airplane. The analysis is based on the familiar stability equation expressing the contribution of wing and tail to longitudinal stability. Effects of wing, tail, and fuselage flexibility are considered. Calculated effects are shown for a swept-wing bomber of relatively high flexibility.

Although large changes in stability due to certain parameters are indicated for the example airplane, the over-all stability change was quite small, compared to the individual effects, due to the counterbalancing of wing and tail contributions. The effect of flexibility on longitudinal control for the example airplane was found to be of little real importance in lg flight, although in turning flight the effect was found to be commensurate with the stability loss.

INTRODUCTION

In the past, airplane configurations and operating speeds have been such that prediction of longitudinal-stability and -control characteristics usually could be handled without regard to aeroelastic effects. With higher flight speeds and the use of swept wings, aeroelastic effects are sufficiently important to pose major problems in airplane design. Although flexibility of swept wings has introduced the major problems to date, the flexibility of fuselage and swept-tail surfaces may introduce problems approaching equal importance as speeds continue to increase. Much of the initial published work on predicting these effects appears to have been done by the British (refs. 1, 2, 3, 4, and 5).

The object of the present study was to determine the magnitude of the stability loss likely to be encountered on swept-wing aircraft of conventional configuration. To gain this end, it was decided to evaluate the aeroelastic effects for an airplane of relatively high flexibility. It was decided, further, to employ a simple method of stability analysis in order to seek a physical appreciation of the factors involved in the net stability change for the airplane.

The results of the aforementioned study are presented in this report together with the method of analysis employed. The net stability change is shown together with the individual contributions due to flexibility of wing, tail, and fuselage,

both including and neglecting the effect of inertial loads. The method of analysis is based on the familiar stability equation expressing the contribution of wing and tail to longitudinal stability. The reader interested solely in the calculated results can turn directly to the section titled "Application to Example Airplane."

NOTATION

A	wing aspect ratio, $\frac{b^2}{S}$
A_x	ratio of net aerodynamic force along the airplane Z axis (positive when directed upward) to the weight of the airplane
a. c.	aerodynamic-center position, percent \bar{c} behind leading edge
b	wing span measured normal to the plane of symmetry, ft
c	section chord parallel to the plane of symmetry, ft
c_a	average section chord parallel to the plane of symmetry, ft
\bar{c}	mean aerodynamic chord of wing, $\int_0^{b/2} \frac{c^2 dy}{\int_0^{b/2} c dy}$, ft
c_l	section lift coefficient
C_L	lift coefficient, $\frac{\text{lift}}{qS}$
C_{L_t}	tail contribution to lift coefficient, $\frac{\text{tail lift}}{q_t S_t}$
C_{L_α}	wing lift-curve slope, per radian
$C_{L_{\alpha_t}}$	tail lift-curve slope, per radian
C_m	pitching-moment coefficient, positive for nose-up moment, $\frac{\text{moment}}{qS\bar{c}}$
C_{m_0}	pitching-moment coefficient at zero lift
$\frac{\partial C_m}{\partial C_L}$	rate of change of pitching-moment coefficient with lift coefficient
$\Delta\left(\frac{\partial C_m}{\partial C_L}\right)$	change in static stability parameter $\frac{\partial C_m}{\partial C_L}$ due to flexibility (positive when stability is decreased by flexibility)

¹ Supersedes recently declassified NACA RM A51C19 entitled "An Analysis of the Effects of Aeroelasticity on Static Longitudinal Stability and Control of a Swept-Back-Wing Airplane," by Richard B. Skoog, 1951.

i_t	tail incidence, $i_t(L_t, A_z) + \text{constant}$, (positive in same sense as α and also relative to thrust axis of the rigid airplane), radians
$\left(\frac{\partial i_t}{\partial \alpha}\right)_{A_z}$	rate of change of tail incidence with wing angle of attack at constant A_z (due to fuselage bending under the aerodynamic load, L_t)
$\left(\frac{\partial i_t}{\partial \alpha}\right)_{L_t}$	rate of change of tail incidence with wing angle of attack at constant L_t (due to fuselage bending under the loads imposed by the reaction of rear portion of fuselage and empennage masses to normal acceleration)
$\left(\frac{\partial i_t}{\partial \alpha_t}\right)_{A_z}$	rate of change of tail incidence with tail angle of attack at constant A_z (due to fuselage bending under the aerodynamic load, L_t)
$\left(\frac{\partial i_t}{\partial A_z}\right)_{L_t}$	fuselage structural influence coefficient expressing change in tail incidence per unit normal acceleration, radians/g
$\left(\frac{\partial i_t}{\partial L_t}\right)_{A_z}$	fuselage structural influence coefficient expressing change in tail incidence per unit tail load, radians/lb
L_t	aerodynamic load on horizontal tail (positive when directed upward), lb
l_t	tail length (from airplane center of gravity to aerodynamic center of horizontal tail), ft
q	free-stream dynamic pressure, lb/sq ft
q_t	tail dynamic pressure, lb/sq ft
S	wing area (including portion covered by fuselage), sq ft
S_t	horizontal-tail area, sq ft
V	true airspeed, ft/sec
\bar{V}	tail volume, $\frac{l_t S_t}{\bar{c} S}$
W	airplane weight, lb
x	distance from wing aerodynamic center to airplane center of gravity (positive when measured forward of center of gravity), ft
y	spanwise coordinate perpendicular to plane of symmetry, ft
α	angle of attack of wing root chord, radians
α_t	angle of attack of tail root chord, radians
α_s	elevator-effectiveness parameter, $\frac{\partial \alpha_t}{\partial \delta_e}$
$\frac{\partial C_{L_t}}{\partial \delta_e}$	lift effectiveness of elevator, per deg
$\frac{\partial C_m}{\partial \delta_e}$	pitching effectiveness of elevator, per deg
δ_e	elevator angle (positive for down deflection), deg
ϵ	downwash angle at the tail, radians
$\frac{\partial \epsilon}{\partial \alpha}$	rate of change of downwash angle at the tail with angle of attack
θ	pitching velocity, radians/sec
η	nondimensional spanwise coordinate, $\frac{y}{b/2}$
$\Delta \eta$	spanwise shift in aerodynamic-center position for each wing panel, $\frac{\Delta y}{b/2}$

$\Lambda_{c/4}$ sweep angle of wing quarter-chord line (positive for sweepback), deg

SUBSCRIPTS

R rigid airplane
 F flexible airplane

FUNDAMENTAL CONSIDERATIONS

The purpose of this section of the report is to present the method of analysis used in obtaining the calculated results for the example airplane. The material is presented in three main subsections. In the first subsection, titled "Stability Equation," the familiar stability equation expressing the contribution of wing and tail to static longitudinal stability is presented in a modified form to include factors which account for the airplane flexibility. In the second subsection, titled "Effect of Flexibility on the Stability Parameters," methods are indicated and references are given to aid in evaluating the effects of flexibility on the factors appearing in the stability equation. In the third subsection the effect of flexibility on longitudinal control is discussed.

STABILITY EQUATION

As is usually done, the present report considers the index of static longitudinal stability to be the partial derivative $\partial C_m / \partial C_L$. In free flight, changes in lift coefficient at constant forward speed must always involve a curved flight path and hence must always involve pitching velocity. Further, in the case of a flexible airplane, the normal acceleration associated with a curved flight path will introduce deformations due to the loads imposed by the reaction of point masses to normal acceleration. It should be noted that, in general, the effects of such deformations will be in opposition to the effects associated with deformations caused by increase in the aerodynamic loads only. In particular, the over-all effect of the mass reactions referred to is to produce loads acting normal to the airplane plan form which are distributed over the wing and tail spans and along the fuselage. In the discussion to follow, for brevity, these mass effects are referred to as inertial effects but should not be confused with the effect of body inertia on dynamic longitudinal stability where the inertia of the airplane as a whole is considered. The sign convention for the present analysis is shown in figure 1.

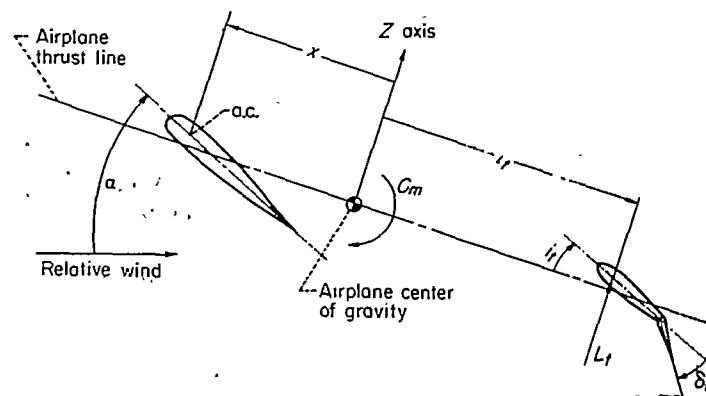

FIGURE 1.—Schematic diagram defining positive directions for the notation of the present analysis.

For a rigid airplane, the stability equation expressing the contribution of wing and tail to $\partial C_m / \partial C_L$ is usually written as

$$\left(\frac{\partial C_m}{\partial C_L}\right)_R = \left(\frac{x}{c}\right)_R - \frac{(C_{L\alpha_t})_R}{(C_{L\alpha})_R} \left[1 - \left(\frac{\partial \epsilon}{\partial \alpha}\right)_R\right] \bar{V} \frac{q_t}{q} \quad (1)$$

The additional effect of pitching velocity on C_m results in

$$\Delta \left(\frac{\partial C_m}{\partial C_L}\right)_R = -\frac{l_t}{\bar{V}} (C_{L\alpha_t})_R \bar{V} \frac{q_t}{q} \frac{\partial \theta}{\partial C_L} \quad (2)$$

If equations (1) and (2) are modified to include effects of wing, tail, and fuselage flexibility and are then combined, the following equation can be written (see Appendix A)

$$\begin{aligned} \left(\frac{\partial C_m}{\partial C_L}\right)_F = & \left(\frac{x}{c}\right)_F - \frac{(C_{L\alpha_t})_F}{(C_{L\alpha})_F} \left[1 - \left(\frac{\partial \epsilon}{\partial \alpha}\right)_F + \left(\frac{\partial i_t}{\partial \alpha}\right)_{A_Z} + \right. \\ & \left. \left(\frac{\partial i_t}{\partial \alpha}\right)_{L_t}\right] \bar{V} \frac{q_t}{q} - \frac{l_t}{\bar{V}} (C_{L\alpha_t})_F \left[1 + \left(\frac{\partial i_t}{\partial \alpha}\right)_{A_Z}\right] \bar{V} \frac{q_t}{q} \frac{\partial \theta}{\partial C_L} \quad (3) \end{aligned}$$

As can be seen from these equations, flexibility of the airplane structure is assumed to affect the following parameters:

1. Wing aerodynamic center position $\frac{x}{c}$
2. Wing lift-curve slope $C_{L\alpha}$
3. Tail lift-curve slope $C_{L\alpha_t}$
4. Rate of change of downwash at the tail $\frac{\partial \epsilon}{\partial \alpha}$

Also, additional parameters are introduced because of fuselage flexibility. Of the parameters listed, items 1, 2, and 4 are influenced by wing flexibility with item 3 being influenced by tail flexibility. The effect of flexibility on these parameters is discussed in detail later in this report.

It is of some interest to note that the third term of the right-hand side of equation (3) and also the additional parameter $(\partial i_t / \partial \alpha)_{L_t}$ in the second term of that equation do not appear in the evaluation of stability for a model in a wind tunnel where the model is physically restrained by the support system from developing any accelerations or angular velocities. However, since the former term is usually of small magnitude in comparison with the others in equation (3), it will be neglected in the present analysis. It should be noted, also, that the inertia of wing and tail has not been neglected in developing equation (3), although only the effect of fuselage inertia is shown explicitly. Actually, the direct effects of wing and tail inertia are considered to be contained implicitly in $(C_{L\alpha})_F$ and $(C_{L\alpha_t})_F$. Details of this modification also will be referred to later in this report.

EFFECT OF FLEXIBILITY ON THE STABILITY PARAMETERS

Wing aerodynamic center.—On a sweptback wing of even moderate sweep, wing bending exerts the predominant influence on the aerodynamic span load distribution, resulting in an inboard shift in center of load for each wing panel. Due to this inboard shift in center of load, the aerodynamic-center position for a flexible wing will be ahead of that for the rigid wing. As is well known, any forward shift in

aerodynamic center will cause a decrease in longitudinal stability. The geometric relation between any given spanwise shift and the associated chordwise shift along the mean aerodynamic chord is given by the following relation:

$$\Delta \left(\frac{x}{c}\right) = -\frac{\Delta \eta}{2} A \frac{c_{av}}{c} \tan \Lambda_{eff} \quad (4)$$

It is apparent from this expression that the aerodynamic-center shift along the chord is most severe at high aspect ratios and high sweep angles for a given spanwise shift. A method for determining the span load distribution of a flexible sweptback wing, from which the aerodynamic-center position of the flexible wing can be determined, is given in reference 6. The shift in aerodynamic-center position for the tail is neglected since it only affects the value of l_t used in the calculation of \bar{V} .

Wing lift-curve slope.—On a sweptback wing, the lift-curve slope for the flexible wing is usually less than that for a rigid wing. As a result, the angle of attack required to reach a given lift coefficient is higher for a flexible wing than for a rigid wing. For this reason, the tail also is subjected to a higher angle of attack (neglecting downwash considerations) so that the stability contribution of a rigid tail will be higher on an airplane with a flexible wing than on an airplane with a rigid wing. Consequently, the effect of reduction of wing lift-curve slope on the stability contribution of the tail is such as to increase the stability for an airplane with sweptback wings.

A method for determining the lift-curve slope for a flexible sweptback wing also is given in reference 6.

Rate of change of downwash at the tail ($\partial \epsilon / \partial \alpha$).—The rate of change of downwash at the tail is dependent upon the span load distribution associated with changing angle of attack so that changes in span load distribution due to flexibility may have an influence on the average downwash at the tail. The rate of change of downwash at the tail also depends upon the lift-curve slope of the wing, however, so that the over-all effect of wing flexibility on $\partial \epsilon / \partial \alpha$ cannot be stated even qualitatively for a general case without further analysis.

Methods for predicting the downwash in the plane of the vortex sheet for low lift coefficients for any arbitrary continuous span load distribution are given in references 7 and 8. Although the value of $\partial \epsilon / \partial \alpha$ may vary considerably in a direction perpendicular to the vortex sheet, it was felt that application of such methods to an estimation of changes in downwash was at least approximately correct.

In the method of reference 7 (which is believed to be the simpler), the downwash variation of $\partial \epsilon / \partial C_L$ is calculated from a relation which is essentially

$$\frac{\partial \epsilon}{\partial C_L} = \frac{1}{2A} \sum_{n=1}^{n=4} a_{rn} \left(\frac{c_i c}{C_L c_{av}}\right)_n \quad (5)$$

where the terms a_{rn} are influence coefficients given in reference 7, and $(c_i c / C_L c_{av})_n$ are loading coefficients corresponding to given spanwise stations as obtained from the span load distribution for the flexible wing. The span load distribution for the flexible wing can be found from the method of reference 6.

To determine the stability parameter $\partial\epsilon/\partial\alpha$, equation (5) is modified by introducing $(C_{L\alpha})_F$. The resulting expression is

$$\frac{\partial\epsilon}{\partial\alpha} = \frac{(C_{L\alpha})_F}{2A} \sum_{n=1}^{n=4} a_{rn} \left(\frac{c_i c}{C_L c_{\alpha n}} \right) \quad (6)$$

Tail lift-curve slope.—The effect of flexibility on the lift-curve slope of a swept tail shows the same qualitative effects as for a swept wing. On a sweptback tail, the effect of aeroelasticity will be to cause a reduction in lift-curve slope so that the tail lift (and, consequently, the pitching moment) will be reduced at a given angle of attack. The effect of reduction in tail lift-curve slope on the stability of the airplane, therefore, is to reduce the stability, whereas the effect of reduction in wing lift-curve slope was shown to increase the stability.

Tail lift-curve slope can be determined by the same method as for the wing as given in reference 6.

Change in tail incidence due to fuselage bending.—From equation (3) it can be seen that fuselage flexibility affects the stability in general by the introduction of three additional terms giving the change in tail incidence due to fuselage bending. These terms are $(\partial i_t/\partial\alpha)_{AZ}$, $(\partial i_t/\partial\alpha)_{L_t}$, and $(\partial i_t/\partial\alpha)_{AZ}$. Expressions for these terms are developed in Appendix A but are shown below for convenience.

$$\left(\frac{\partial i_t}{\partial\alpha} \right)_{AZ} = \frac{[1 - (\partial\epsilon/\partial\alpha)_F] (C_{L\alpha})_F q_i S_i (\partial i_t/\partial L_t)_{AZ}}{1 - (C_{L\alpha})_F q_i S_i (\partial i_t/\partial L_t)_{AZ}} \quad (7)$$

$$\left(\frac{\partial i_t}{\partial\alpha} \right)_{L_t} = \frac{(\partial i_t/\partial A Z)_{L_t} [(C_{L\alpha})_F q_i (W/S)]}{1 - (C_{L\alpha})_F q_i S_i (\partial i_t/\partial L_t)_{AZ}} \quad (8)$$

$$\left(\frac{\partial i_t}{\partial\alpha} \right)_{AZ} = \frac{(C_{L\alpha})_F q_i S_i (\partial i_t/\partial L_t)_{AZ}}{1 - (C_{L\alpha})_F q_i S_i (\partial i_t/\partial L_t)_{AZ}} \quad (9)$$

EFFECT OF FLEXIBILITY ON LONGITUDINAL CONTROL

In the preceding sections of this report, the change in static longitudinal stability due to aeroelasticity has been discussed in some detail. It is also of interest, however, to consider the effect of flexibility on elevator angle required for balance ($C_m=0$). There are two effects which must be considered:

1. The primary effect of the stability changes just discussed.
2. The secondary effect of elevator deflection in the absence of any stability changes.

The second effect is introduced by the deflection of horizontal tail and fuselage under the load produced by elevator deflection.

The first effect can be evaluated graphically by plotting the stability curve (C_m vs. C_L) for the rigid airplane and also the family of stability curves for the flexible airplane as calculated at several values of dynamic pressure. In turning flight, the elevator angle for balance, then, can be calculated from the individual stability curves directly. In straight flight, where the dynamic pressure changes with lift coefficient, the elevator angle variation can be found from the variation of C_m with C_L given by plotting the flight variation of C_L with q across the family of curves for the flexible airplane.

The second effect can be evaluated by means of the following equation derived in Appendix B.

$$\delta_\epsilon = \delta_{\epsilon_0} \frac{(\partial C_{L_i}/\partial\delta_\epsilon)_R}{(\partial C_{L_i}/\partial\delta_\epsilon)_F} \left[1 - \left(\frac{\partial i_t}{\partial L_t} \right)_{AZ} (C_{L\alpha})_F q_i S_i \right] \quad (10)$$

In this equation δ_ϵ represents the elevator angle required (with flexibility of the horizontal tail and fuselage present) to maintain the same lift on the tail as that produced by an arbitrary elevator deflection (δ_{ϵ_0}) on the rigid airplane. The ratio of elevator effectiveness for the rigid tail $(\partial C_{L_i}/\partial\delta_\epsilon)_R$ to the elevator effectiveness for the flexible tail $(\partial C_{L_i}/\partial\delta_\epsilon)_F$ can be found by the relation which is derived in Appendix C.

$$\frac{(\partial C_{L_i}/\partial\delta_\epsilon)_F}{(\partial C_{L_i}/\partial\delta_\epsilon)_R} = 1 - \frac{\Delta C_{L_i}}{C_{L_iR}} \frac{q_i}{1+kq_i} \quad (11)$$

where k and $\Delta C_{L_i}/C_{L_iR}$ are constants with magnitude dependent on the structural rigidity of the tail. Evaluation of k and $\Delta C_{L_i}/C_{L_iR}$ (defined in Appendix C) involves a knowledge of the span load distribution due to elevator deflection and the span load distribution due to symmetric twist distribution. Span load distributions for wings and flaps of arbitrary plan form are given in reference 7 for symmetric flap deflection. Span load distributions due to symmetric, continuous twist distribution are given in reference 9. The calculation procedure is similar to that contained in reference 6.

The procedure used to calculate the elevator angle required for balance may be summarized as follows:

- (1) Determine the stability curve for the rigid airplane for a given center-of-gravity position.
- (2) Using the stability given by (1) and the stability change given by equation (3), determine the slope of the stability curve for the flexible airplane. Determine the change in C_{m_0} by integrating the aeroelastic loadings caused by built-in twist and camber as found by the method of reference 6. Note that the effect of dead weight on C_{m_0} is accounted for by using stability curves which include the effects of inertia. With the slope and intercept thus determined, plot stability curves for the flexible airplane at several values of dynamic pressure.
- (3) Plot the flight variation of C_L with q across the family of curves so obtained.
- (4) Determine the elevator angle required for balance δ_{ϵ_0} corresponding to the variation in C_m with C_L so determined.
- (5) Obtain the final elevator angle required for balance by means of equation (10).

APPLICATION TO EXAMPLE AIRPLANE

The method of analysis indicated in the preceding section of the report has been applied to an example swept-wing airplane known to have a relatively flexible structure. Compressibility considerations in regard to the effect on span load distribution were neglected in evaluating the aeroelastic effects since a preliminary estimate showed them to be of second order (compared to the primary effect of dynamic pressure) for the particular configuration studied. The ratio of tail dynamic pressure to free-stream dynamic pressure was assumed to be equal to 1.0. The airplane con-

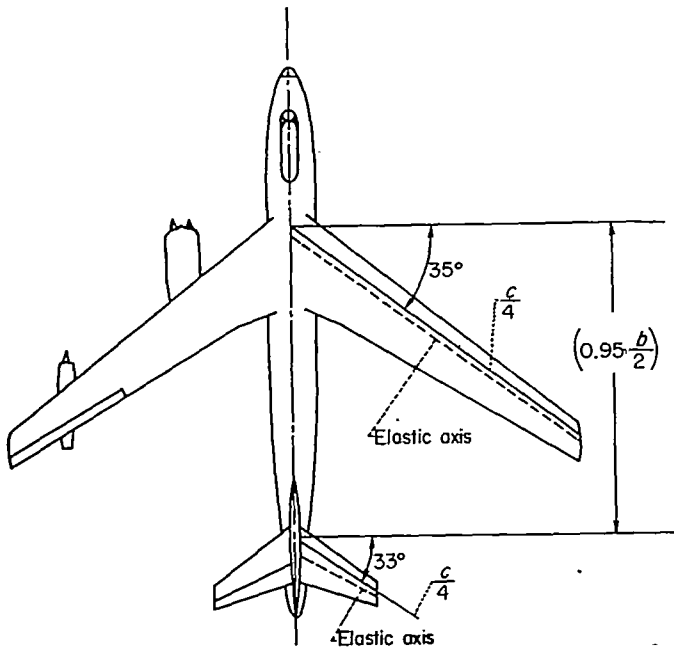

FIGURE 2.—Geometric characteristics of example airplane.

figuration is shown in figure 2 with the pertinent geometric parameters indicated. The sweep angles of wing and tail are 35° and 33°, respectively; the wing aspect ratio is 9.43, wing taper ratio 0.42; tail aspect ratio 4.06, tail taper ratio 0.423; and tail volume 0.672. The effect of the engine nacelles on the aerodynamic span load distribution was neglected as was the effect of the fuselage. The elastic axis for the wing is located at the 38-percent-chord line and for the tail is located at the 50-percent-chord line. The variation of pertinent structural characteristics across the semispan of wing and horizontal tail is presented in figure 3. The structural influence coefficients associated with fuselage flexibility are defined by the following data:

$$\left(\frac{\partial i_i}{\partial L_i}\right)_{A_z} = -0.0000342, \text{ deg/lb}$$

$$\left(\frac{\partial i_i}{\partial A_z}\right)_{L_i} = 0.45, \text{ deg/g}$$

EFFECT OF FLEXIBILITY ON STABILITY

In the discussion to follow, the material is presented in the following order: first, an evaluation of the effects of flexibility on each of the parameters appearing in the static-longitudinal-stability equation, and second, an evaluation of the over-all effect of flexibility for the airplane as a whole. The individual effects are presented in figures 4 through 9 and are summarized in figure 10. The over-all effect is presented in figure 11.

The effect of changes in the stability parameters on the stability of the example airplane has been evaluated by assuming that only the parameter under consideration is affected by flexibility. In this way, the effect of changes in each parameter can be assessed individually. In the discussion of each parameter which follows, effects due to the action of aerodynamic loads only are considered first, followed by consideration of the modifying influence of inertia.

Wing aerodynamic center.—The shift in wing aerodynamic-center position due to wing flexibility is shown in figure 4 together with the associated stability change. Inasmuch as the discussion is being restricted for the moment to effects due to aerodynamic loads only, merely the curves shown for the weightless wing need be considered, since these curves are for zero inertial effect. As can be seen, the aerodynamic center with inertia absent moves forward from the rigid-wing value of 32 percent of the mean aerodynamic chord until at a dynamic pressure of about 800 pounds per square foot the aerodynamic center is almost at the leading edge of the mean aerodynamic chord. As can be seen from the values of stability change, the effect of aerodynamic-center shift in itself is very large. For example, at a dynamic pressure of 500 pounds per square foot, the neutral point of the wing has shifted forward by 20-percent chord, which of itself would introduce a serious stability problem.

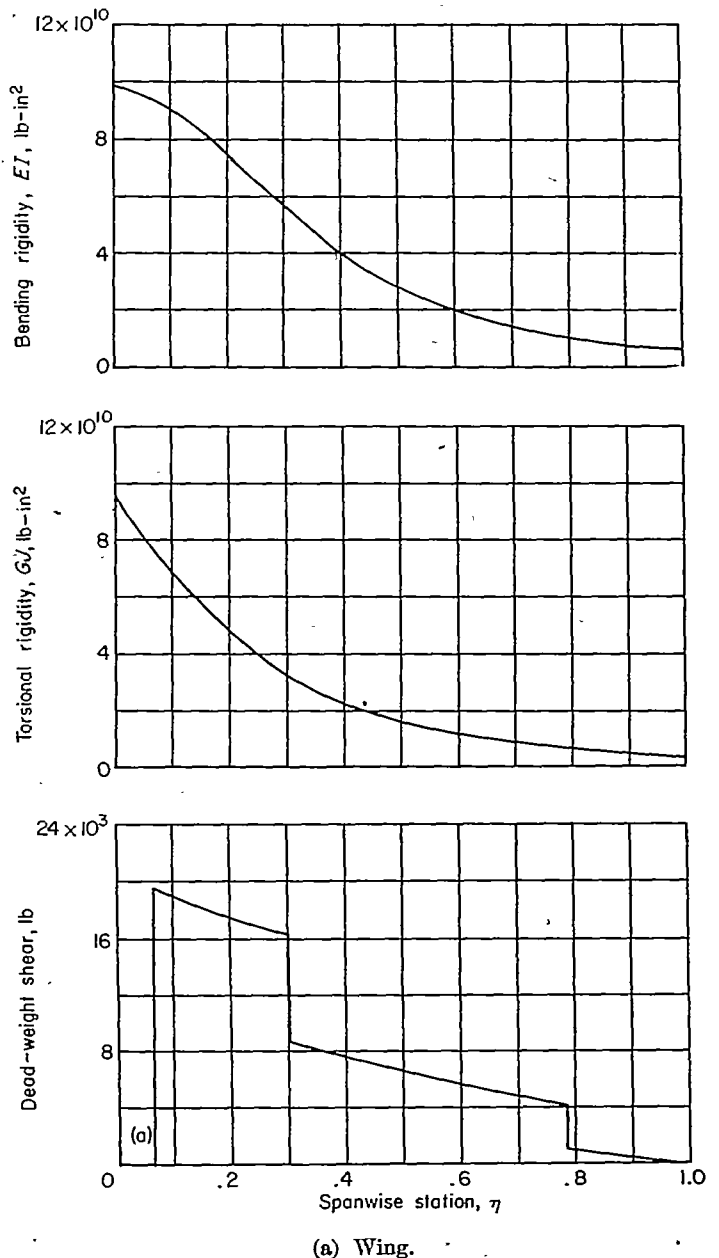
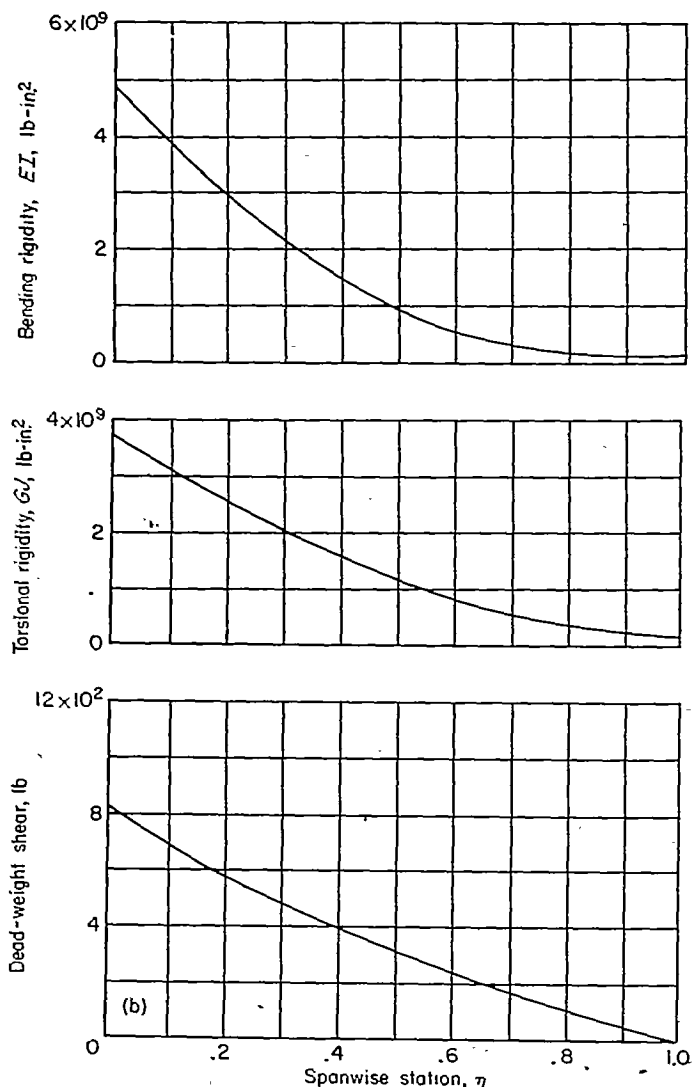

FIGURE 3.—Variation in pertinent structural characteristics across the semispan for the wing and horizontal tail of the example airplane.



(b) Horizontal tail.

FIGURE 3.—Concluded.

It is of some interest to know how much of the stability change with inertia absent is due to bending deformations and how much is due to torsional deformations. In order to aid in this comparison, a curve has been included in figure 4 showing the contribution of torsion alone. As can be seen, torsional deflections are stabilizing, while bending deflections are destabilizing. The contribution due to torsion is seen to be much smaller than that due to bending. The relative importance of torsion and bending, however, depends on the ratio of torsional to bending rigidities and location of the elastic axis, and hence would not necessarily be the same for all airplanes. An equally important factor to consider is the effect of sweep angle. The extremes of zero sweep and 90° sweep best illustrate the point, since for zero sweep only torsion is a factor, while for 90° sweep only bending is a factor.

The effect of inertia on the location of the aerodynamic center for the example wing also is included in figure 4 for airplane wing loadings of 70 pounds per square foot and 100 pounds per square foot. As can be seen from the figure, the effect of wing inertia is only mildly alleviating. Although the relieving effect in this case is shown to be rather small,

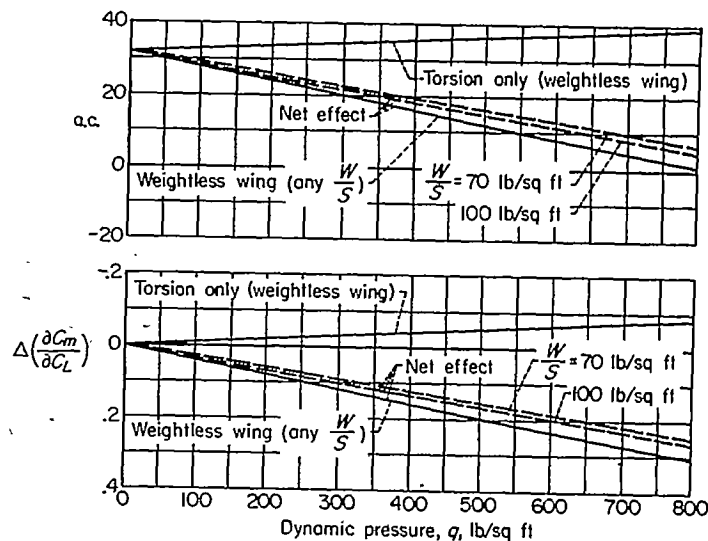

FIGURE 4.—Variation of wing aerodynamic center with dynamic pressure for the example airplane.

the effect for other airplanes may not be of similar magnitude, since the inertia effect depends upon the ratio of wing weight to total airplane weight in addition to the spanwise weight distribution previously mentioned. By reference once more to the case of a tailless airplane, it would appear that wing inertia would have a much greater relieving effect in that case, since more of the total airplane weight is in the wings than for conventional airplanes.

Wing lift-curve slope.—The ratio of flexible to rigid wing lift-curve slope and the associated increase in tail contribution to longitudinal stability is presented in figure 5 as a function of dynamic pressure. As before, the curves for the weightless wing represent the case of zero inertia effect. At a dynamic pressure of 500 pounds per square foot the lift-curve slope with inertia absent is reduced to 64 percent of the rigid-wing value. The associated increase in tail stability contribution amounts to a rearward neutral-point shift of 25 percent. At this same dynamic pressure, the stability contribution of the wing aerodynamic-center shift (with inertia absent) was shown to be a forward shift of 20 percent, or almost the same magnitude, so that the two wing factors so far discussed would appear to be largely canceling. Whether canceling of these effects will exist in general for all configurations cannot be determined at this time. Calculations for a fighter configuration of markedly different geometric and structural characteristics, however, resulted in essentially the same relation between these wing factors. An interesting extreme to consider is the case of the tailless airplane for which the second term of the static-longitudinal-stability equation does not exist. In this case no canceling of these effects will be possible so that the net stability change will be due solely to wing aerodynamic-center shift.

Since the effect on stability of reduction in wing lift-curve slope is large with inertia absent, it is of interest to consider the relative contribution of bending and torsion. For this purpose a curve is included in figure 5 showing the contribution of torsion alone. As can be seen, the contribution of torsion to the lift-curve slope is an increase, while the larger effect of bending is a decrease. The associated

stability changes are shown to be a decrease due to torsion and a much larger increase due to bending.

The effect of inertia on the wing lift-curve slope also is included in figure 5 for airplane wing loadings of 70 and 100 pounds per square foot. As can be seen, the effect of wing inertia is much the same as was stated for aerodynamic center (i. e., mildly alleviating).

Rate of change of downwash at the tail.—The variation along the swept-tail span of the rate of change of downwash in the plane of the vortex sheet with inertial effects absent is presented in figure 6 for several values of dynamic pressure. As indicated earlier in this report, the curves are based on a method which is applicable only at low lift coefficients. The location of the tip of the horizontal tail is indicated in the figure. As can be seen, large changes in downwash are indicated behind the outer sections of the wing and in the plane of symmetry; however, the average downwash over the tail is changed only slightly. The change in average downwash depends on the ratio of tail span to wing span. The downwash factor, $1 - (d\epsilon/d\alpha)$, based on the average downwash over the tail is presented in figure 7 as a function of dynamic pressure along with the associated change in stability contribution of the tail. As can be seen from the figure, the change in downwash factor is very slight, being of the order of 5 percent at the highest dynamic pressure considered. The stability change, as would be expected, is correspondingly small and relatively unimportant compared to the other stability factors so far discussed.

The effect of inertia on downwash at the tail is not shown, since the relatively larger downwash changes associated with the aeroelastic effects due to aerodynamic loads only were shown to be unimportant.

Tail lift-curve slope.—The ratio of flexible to rigid tail lift-curve slope and the associated decrease in tail stability contribution is shown in figure 8 with similar curves for the wing shown for comparison. As can be seen from the figure, the effect of flexibility on tail lift-curve slope is not so pronounced as that for the wing, and, as a consequence, the effect on the stability contribution of the tail is also correspondingly less. As can also be seen from the figure, the inertial effect on the tail is similar to that for the wing.²

Tail incidence change due to fuselage bending.—The variation with dynamic pressure of an over-all stability term expressing the change in tail incidence due to fuselage bending is shown in figure 9. The curves showing the contribution of aerodynamic loads only are indicated by $(\partial i_t / \partial \alpha)_{L_i} = 0$. Curves are presented considering the effect of fuselage flexibility alone and also including the effects of wing and tail flexibility. For comparison, curves of average downwash and stability change due to downwash change are also presented. At the higher values of dynamic pressure the fuselage factor becomes of the same order of magnitude as

² The figure also indicates the extent to which the inertial effect varies with wing loading, since the curve for the weightless wing could just as well be labeled $W/S = \infty$. A physical explanation here is that an airplane of infinite mass will experience zero A_x under lifting loads, so that the effect of flexibility for $W/S = \infty$ is the same as if the airplane were physically restrained and merely pivoted about the center of gravity. An airplane having finite mass, however, will experience a normal acceleration so that the wing inertial loads will affect the wing deflection and hence C_{L_a} .

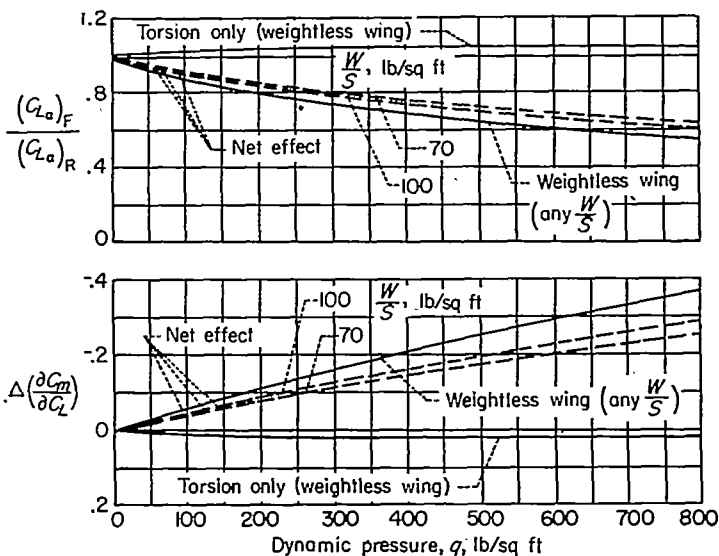

FIGURE 5.—Variation of the ratio of flexible to rigid wing lift-curve slope with dynamic pressure for the example airplane.

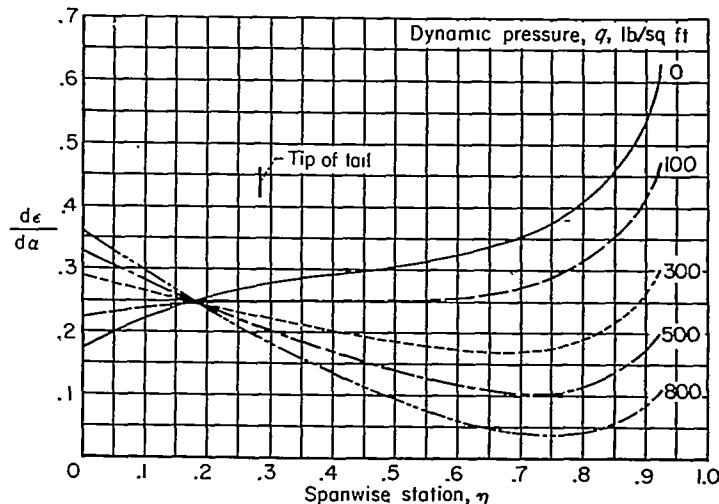

FIGURE 6.—Variation along the swept-tail span of the rate of change of downwash in the plane of the vortex sheet for several values of dynamic pressure for the example airplane as affected by aerodynamic loads only.

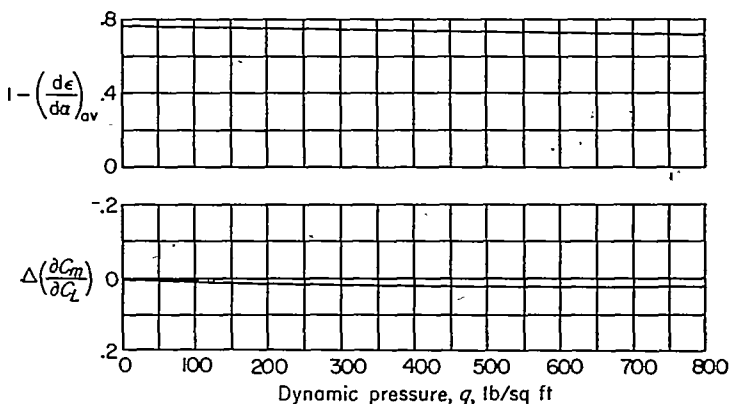

FIGURE 7.—Variation of the downwash factor $[1 - (d\epsilon/d\alpha)_{av}]$ and the associated stability change with dynamic pressure for the example airplane as affected by aerodynamic loads only.

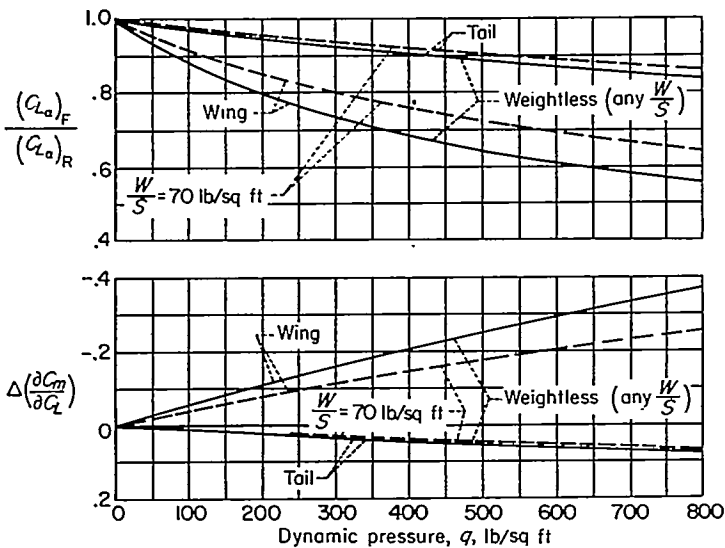

FIGURE 8.—Variation of the ratio of flexible to rigid tail lift-curve slope and associated stability change with dynamic pressure for the example airplane, with similar curves for the wing shown for comparison.

the average rate of change of downwash at the tail and therefore is seen to be of comparable importance. The effect of including wing and tail flexibility in the fuselage factor is to lower the factor slightly as shown. By reference to the stability curves, it can be seen that the stability change due to fuselage bending is of much greater importance than that due to downwash change, as would be expected from the comparison shown on the upper part of the figure. It can also be seen that the effect of wing and tail flexibility is to alleviate the stability decrease due to fuselage flexibility.

As can be seen from the figure, the effect of inertia on the fuselage factor is very large and consequently of considerable importance. It will be remembered that the effect of inertia on the wing and tail factors was only slight by comparison. It is interesting to note that consideration of inertia and of all the flexibilities involved results (for the example airplane) in a fuselage factor equal essentially to zero even though the aerodynamic contribution is large. In these estimates of inertial effects, the influence on fuselage factor of wing and tail inertia has been neglected, since these effects are of higher order for this airplane.

Summary of effects.—The effects of wing, tail, and fuselage flexibility on the longitudinal-stability index $\partial C_m / \partial C_L$ of the example airplane are summarized in figure 10, showing the important individual effects which have been discussed. The upper set of curves presents the effects due to aerodynamic load only while the lower set of curves also includes the effects due to inertial loads for an airplane wing loading of 70 pounds per square foot. As can be seen from the figure, all the effects are destabilizing except the effect of reduction in wing lift-curve slope on the stability contribution of the tail. The stability changes due to wing aerodynamic-center shift and reduction in wing lift-curve slope are shown to be by far the largest effects of those shown. Both these results are shown to be true whether inertial effects are included or not.

The over-all effect of flexibility on the static-stability index $\partial C_m / \partial C_L$ for the example airplane is shown in figure 11.

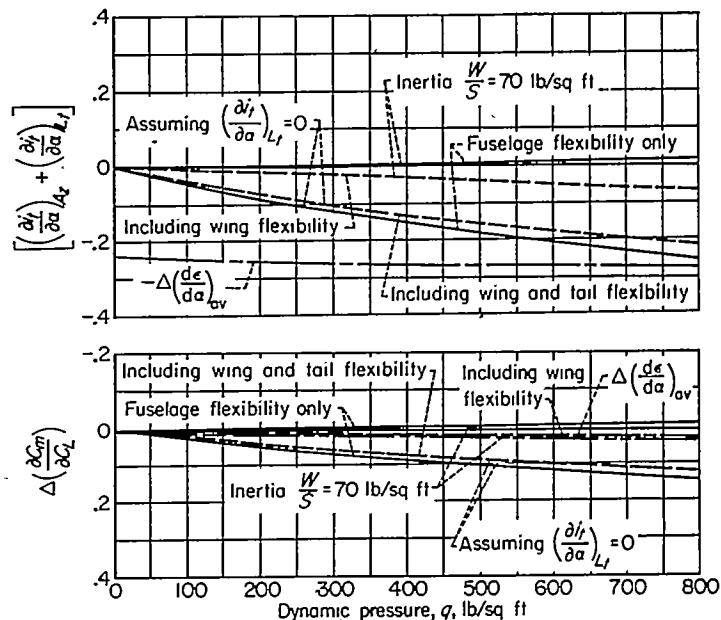

FIGURE 9.—Variation with dynamic pressure, q , lb/sq ft of the factors associated with fuselage flexibility and the stability change due to these factors for the example airplane.

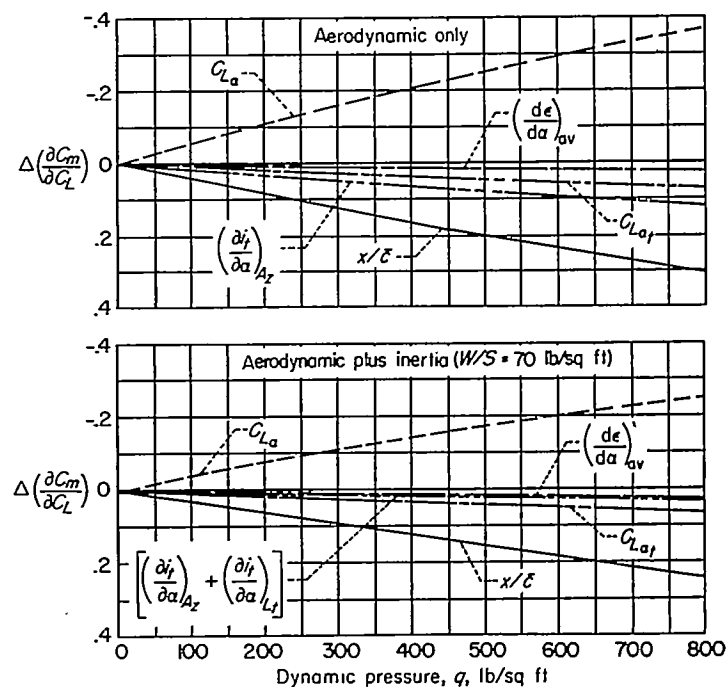

FIGURE 10.—Summary of the individual effects of the various parameters involved on stability of the example airplane as affected by aerodynamic loads only and also as affected by both aerodynamic and inertial loads.

The curves presented show the changes due to aerodynamic loads only and also include the effects of inertial loads for an airplane wing loading of 70 pounds per square foot. Due to the nature of the second term of the stability equation, the effects shown in figure 10 are not all additive algebraically; therefore, the curves of figure 11 were obtained by allowing all the factors in the equation to vary simultaneously. As can be seen from the figure, inertial effects reduce considerably the stability change which would otherwise occur

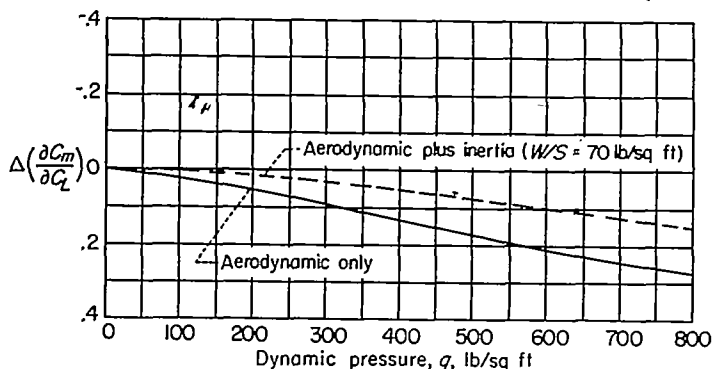

FIGURE 11.—Over-all effect of flexibility on the static-stability index $\partial C_m/\partial C_L$ for the example airplane as affected by aerodynamic loads only and also by both aerodynamic and inertial loads.

for this airplane. For example, the stability change at a dynamic pressure of 500 pounds per square foot is reduced, due to inertia, from a neutral-point shift of about 17 percent to about 7 percent. When the large individual effects are remembered, the over-all change due to flexibility for the airplane (as shown by the inertial curve) is seen to be relatively small.

It is of interest to consider the effect of flexibility on the flight test index $\partial \delta_e/\partial C_L$ (which is associated with $\partial C_m/\partial C_L$), since³

$$\left(\frac{\partial \delta_e}{\partial C_L}\right)_F = \frac{(\partial C_m/\partial C_L)_F}{(\partial C_m/\partial \delta_e)_F}$$

Consideration of the above relation alone leads to the possibility of counter-balancing between the effects of aeroelasticity on $\partial C_m/\partial C_L$ and on $\partial C_m/\partial \delta_e$; therefore, figure 12 is presented to show the over-all change in $\partial \delta_e/\partial C_L$ as a function of q for an assumed static margin for the rigid airplane of 0.10. Curves are presented for $\partial C_m/\partial \delta_e = (\partial C_m/\partial \delta_e)_R$ and for $\partial C_m/\partial \delta_e = (\partial C_m/\partial \delta_e)_F$ to show the influence of that parameter on $\Delta(\partial \delta_e/\partial C_L)$. As can be seen from the figure, the variation of $\Delta(\partial \delta_e/\partial C_L)$ with q for the example airplane is governed primarily by the stability change rather than by loss in control effectiveness. That this conclusion will be true, in general, for airplanes which suffer loss in stability with increase in q perhaps is not immediately obvious, but can be seen quite readily from recognition of the fact that the intersection of the two curves shown in figure 12 at a dynamic pressure of about 600 pounds per square foot is due to the flexible airplane having become neutrally stable. It is apparent that the parameter $\partial C_m/\partial \delta_e$ can have no effect on $\partial \delta_e/\partial C_L$ when an airplane has neutral stability since $\partial \delta_e/\partial C_L = 0$.

EFFECT OF FLEXIBILITY ON LONGITUDINAL CONTROL

The effect of flexibility on the elevator angle required for balance in lg flight has been evaluated for the example airplane for a static margin of the rigid airplane of 0.10. The semigraphical analysis described earlier was used. The case

³ The parameter $(\partial C_m/\partial C_L)_F$ is given by equation (3) of this report. The parameter $(\partial C_m/\partial \delta_e)_F$ can be found from equation (10) since, from the nature of the analysis leading to that equation, it is clear that

$$\frac{(\partial C_m/\partial \delta_e)_F}{(\partial C_m/\partial \delta_e)_R} = \frac{\delta_{e0}}{\delta_e}$$

of turning flight is not considered here since the results for that case are believed to be sufficiently summarized in figure 12 just discussed. The variation of elevator angle with dynamic pressure for steady level flight is presented in figure 13 (a) for the case where up-elevator only is required and in figure 13 (b) for the case where both up- and down-elevator are required.⁴ Curves are shown for both the rigid and flexible airplane. As can be seen from the figure, the effect of aeroelasticity for the case of up-elevator only is quite small. This results from the counteracting effects of

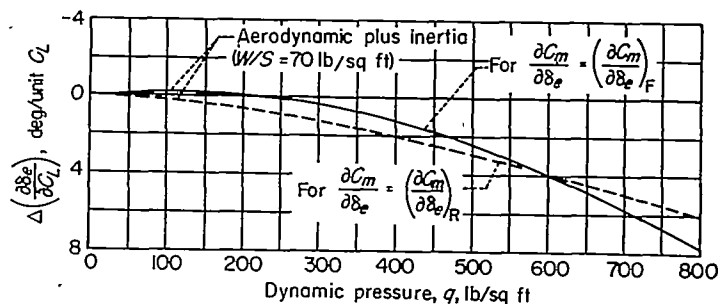
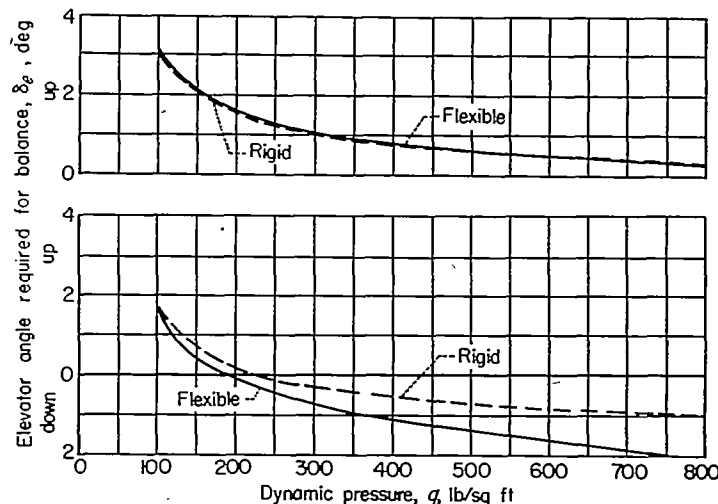

FIGURE 12.—Over-all effect of flexibility on the rate of change of elevator angle with lift coefficient in turning flight for the example airplane assuming static margin for the rigid airplane of 0.10.



(a) With only up-elevator angle required ($C_{m_0} = 0$).

(b) With both up- and down-elevator angle required ($C_{m_0} = +0.03$).

FIGURE 13.—Variation in elevator angle for balance with dynamic pressure in steady level flight for the example airplane when considered to be both rigid and flexible assuming static margin for the rigid airplane of 0.10.

flexibility on the slope of the stability curve, the change in C_{m_0} due to camber and twist, and the loss in elevator effectiveness. For the case where both up- and down-elevator are required, the more positive value of C_{m_0} causes a more downward increment of elevator deflection for the flexible case than for the rigid because of the loss in elevator effectiveness due to flexibility.

⁴ The determining factor in each case is the value of C_{m_0} for the rigid airplane. In case 1 C_{m_0} was assumed equal to zero, while for case 2, C_{m_0} was assumed equal to +0.03. In calculating the change in C_{m_0} due to flexibility for both cases, values of 1° washout and $c_{m_0} = -0.010$ (section pitching moment due to camber) were used.

The effect of flexibility of horizontal tail and fuselage in modifying the elevator angle required for balance is shown in figure 14 as calculated for the example airplane. The effect shown in this figure is included in the curves of figure 13. The elevator-angle ratio increases almost linearly reaching a value of about 1.9 at a dynamic pressure of 800 pounds per square foot.

In all of these calculations, torsion of the elevator has been neglected; that is, the surface is assumed to be infinitely rigid to hinge moments.

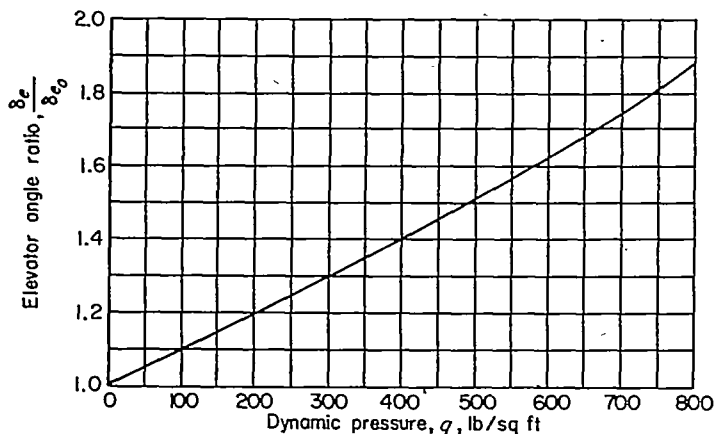

FIGURE 14.—Variation of the elevator angle ratio δ_e/δ_0 with dynamic pressure for the example airplane.

CONCLUDING REMARKS

The effect of flexibility on static longitudinal stability and control of an airplane is such as to preclude any real general-

izations of the results presented herein. Although the overall aeroelastic effect on stability for the example airplane was found to be small compared to the individual effects, it cannot be said that like calculations for any airplane will also yield a small effect. It can be said, however, that, for any practical swept-wing airplane with a tail, the stability change due to a shift in wing aerodynamic center will be destabilizing, while the change in wing lift-curve slope will be stabilizing, so that a certain amount of counterbalancing between these major effects will always be present. As can be seen from the simple stability equation employed in this analysis, the degree of completeness of the counterbalancing depends directly on the size, plan form, and location of the tail as they affect the stability contributed by the tail. Therefore, in the design of airplanes for which wing flexibility would be expected to exert a large influence on stability, it would appear that a minimum over-all aeroelastic effect may be accomplished more advantageously by design changes to the horizontal tail than by such changes to the wing.

The calculations presented herein with regard to the effect of flexibility on longitudinal control show the effect to be of little real importance for the example airplane in lg flight, although in turning flight the effect is shown to be commensurate with the stability loss.

AMES AERONAUTICAL LABORATORY
 NATIONAL ADVISORY COMMITTEE FOR AERONAUTICS
 MOFFETT FIELD, CALIF., Mar. 19, 1951

APPENDIX A

EVALUATION OF PARAMETERS ASSOCIATED WITH FUSELAGE FLEXIBILITY

In order to show how the parameters associated with fuselage flexibility enter the longitudinal-stability equation, equation (3) of the text will be derived here. If the pitching-moment contribution of wing and tail are considered in nondimensional form (i. e., in terms of C_L , C_{L_p} , etc.), the pitching-moment coefficient of the combination can be written as:

$$(C_m)_F = (C_L)_F \left(\frac{x}{c}\right)_F - (C_{L_t})_F \bar{V} \frac{q_t}{g} \quad (A1)$$

Since a flexible airplane is being considered, $(C_L)_F$ and $(C_{L_t})_F$ should be expressed in terms of parameters applying to a flexible structure, so that

$$(C_L)_F = (C_{L\alpha})_F \alpha \quad (A2)$$

$$(C_{L_t})_F = (C_{L\alpha_t})_F \alpha_t \quad (A3)$$

where

$$\alpha_t = \alpha_F - \epsilon_F + i_t + l_t \frac{\theta}{\bar{V}} \quad (A4)$$

In equation (A4), it should be recognized that the downwash angle ϵ_F may be affected by the changes in span load distribution associated with flexibility and also that the tail incidence i_t is affected by fuselage flexibility. Substituting equation (A4) into equation (A3) followed by substitution of the modified equation (A3) into equation (A1),

$$(C_m)_F = (C_L)_F \left(\frac{x}{c}\right)_F - (C_{L\alpha_t})_F (\alpha_F - \epsilon_F + i_t + \frac{l_t \theta}{\bar{V}}) \bar{V} \frac{q_t}{g} \quad (A5)$$

Differentiating with respect to C_L and factoring $(C_{L\alpha})_F$ from the second term, equation (A5) becomes

$$\left(\frac{\partial C_m}{\partial C_L}\right)_F = \left(\frac{x}{c}\right)_F - \frac{(C_{L\alpha_t})_F}{(C_{L\alpha})_F} \left[1 - \left(\frac{\partial \epsilon}{\partial \alpha}\right)_F + \frac{\partial i_t}{\partial \alpha_F} + \frac{l_t}{\bar{V}} \frac{\partial \theta}{\partial \alpha_F} \right] \bar{V} \frac{q_t}{g} \quad (A6)$$

Before proceeding further, it is necessary to evaluate $\partial i_t / \partial \alpha$. To do this, the tail incidence (i_t) can be written

$$i_t = i_{tR} + \left(\frac{\partial i_t}{\partial L_t}\right)_{A_Z} L_t + \left(\frac{\partial i_t}{\partial A_Z}\right)_{L_t} A_Z \quad (A7)$$

where $(\partial i_t / \partial L_t)_{A_Z}$ and $(\partial i_t / \partial A_Z)_{L_t}$ are structural influence coefficients associated with fuselage bending. Differentiating equation (A7) with respect to α_F ,

$$\frac{d i_t}{d \alpha_F} = 0 + \left(\frac{\partial i_t}{\partial L_t}\right)_{A_Z} \frac{d L_t}{d \alpha_F} + \left(\frac{\partial i_t}{\partial A_Z}\right)_{L_t} \frac{d A_Z}{d \alpha_F} \quad (A8)$$

It should be noted here that, although equation (A6) contains the partial derivative $\partial i_t / \partial \alpha_F$, the total derivative of equation (A7) must be taken because of the dependence of

ϵ , i_t , and θ on α_F in the expression for L_t which can be written as

$$L_t = (C_{L\alpha_t})_F \left(\alpha_F - \epsilon_F + i_t + \frac{l_t}{V} \theta \right) q_t S_t \quad (A9)$$

The derivative of equation (A9) with respect to α_F is then

$$\frac{dL_t}{d\alpha_F} = (C_{L\alpha_t})_F \left[1 - \left(\frac{d\epsilon}{d\alpha} \right)_F + \frac{di_t}{d\alpha_F} + \frac{l_t}{V} \frac{d\theta}{d\alpha_F} \right] q_t S_t \quad (A10)$$

For notational consistency with equation (A7), $d\epsilon/d\alpha_F$ and $d\theta/d\alpha_F$ can be written as $\partial\epsilon/\partial\alpha_F$ and $\partial\theta/\partial\alpha_F$, since at constant q the quantities ϵ and θ are functions of α_F only. With these substitutions in equation (A10) and knowing that

$$\frac{dA_z}{d\alpha_F} = \frac{(C_{L\alpha})_F q}{W/S} \quad (A11)$$

from differentiation of

$$A_z = \frac{(C_L)_F q}{W/S} = \frac{(C_{L\alpha})_F \alpha_F q}{W/S} \quad (A12)$$

equation (A8) can be written after some rearrangement as

$$\frac{di_t}{d\alpha_F} = \left(\frac{\partial i_t}{\partial \alpha} \right)_{A_Z} + \left(\frac{\partial i_t}{\partial \alpha} \right)_{A_Z} \frac{l_t}{V} \frac{\partial \theta}{\partial \alpha} + \left(\frac{\partial i_t}{\partial \alpha} \right)_{L_t} \quad (A13)$$

where

$$\left(\frac{\partial i_t}{\partial \alpha} \right)_{A_Z} = \frac{[1 - (\partial\epsilon/\partial\alpha)_F] (C_{L\alpha_t})_F q_t S_t (\partial i_t / \partial L_t)_{A_Z}}{1 - (C_{L\alpha_t})_F q_t S_t (\partial i_t / \partial L_t)_{A_Z}}$$

$$\left(\frac{\partial i_t}{\partial \alpha} \right)_{A_Z} = \frac{(C_{L\alpha_t})_F q_t S_t (\partial i_t / \partial L_t)_{A_Z}}{1 - (C_{L\alpha_t})_F q_t S_t (\partial i_t / \partial L_t)_{A_Z}}$$

$$\left(\frac{\partial i_t}{\partial \alpha} \right)_{L_t} = \frac{(\partial i_t / \partial A_z)_{L_t} [(C_{L\alpha})_F q / (W/S)]}{1 - (C_{L\alpha_t})_F q_t S_t (\partial i_t / \partial L_t)_{A_Z}}$$

By substitution of equation (A13) into equation (A6) and after rearrangement, a final expression for $\partial C_m / \partial C_L$ may be written as

$$\left(\frac{\partial C_m}{\partial C_L} \right)_F = \left(\frac{x}{\bar{c}} \right)_F - \frac{(C_{L\alpha_t})_F}{(C_{L\alpha})_F} \left[1 - \left(\frac{\partial \epsilon}{\partial \alpha} \right)_F + \left(\frac{\partial i_t}{\partial \alpha} \right)_{A_Z} + \left(\frac{\partial i_t}{\partial \alpha} \right)_{L_t} \right] \bar{V} \frac{q_t}{q} - \frac{l_t}{V} (C_{L\alpha_t})_F \left[1 + \left(\frac{\partial i_t}{\partial \alpha} \right)_{A_Z} \right] \bar{V} \frac{q_t}{q} \frac{\partial \theta}{\partial C_L} \quad (A14)$$

APPENDIX B

EVALUATION OF ELEVATOR ANGLE REQUIRED FOR BALANCE

In evaluating the elevator angle required for balance ($C_m=0$) for a flexible airplane, it is necessary to consider the effect that elevator deflection will have on aeroelastic distortion of the horizontal tail and fuselage since such distortion will change the elevator angle required to balance the pitching moment existing with elevator neutral. If the elevator is assumed to be deflected by an arbitrary angle δ_{e0} with the fuselage and horizontal tail fixed in position, the lift coefficient on the tail due to elevator deflection may be written as

$$C_{L_t} = \left(\frac{\partial C_{L_t}}{\partial \delta_e} \right)_R \delta_{e0} \quad (B1)$$

If the horizontal tail is now allowed to relax (with the fuselage still fixed in position), the lift on the tail will change due to distortion of the structure. The elevator angle required to maintain the same lift on the tail as that given by equation (B1) is defined by

$$\left(\frac{\partial C_{L_t}}{\partial \delta_e} \right)_F \delta_{e1} = C_{L_t} = \left(\frac{\partial C_{L_t}}{\partial \delta_e} \right)_R \delta_{e0} \quad (B2)$$

so that

$$\delta_{e1} = \delta_{e0} \frac{(\partial C_{L_t} / \partial \delta_e)_R}{(\partial C_{L_t} / \partial \delta_e)_F} \quad (B3)$$

If the fuselage now is allowed to relax, the lift on the tail will change due to a change in tail incidence. The additional elevator angle required to maintain the lift at the value given by equation (B1) can be written as

$$\delta_{e2} = - \frac{\Delta i_t}{(\alpha_{\delta_e})_F} \quad (B4)$$

where

$$\begin{aligned} \Delta i_t &= \left(\frac{\partial i_t}{\partial L_t} \right)_{A_Z} C_{L_t} q_t S_t \\ &= \left(\frac{\partial i_t}{\partial L_t} \right)_{A_Z} \left(\frac{\partial C_{L_t}}{\partial \delta_e} \right)_R \delta_{e0} q_t S_t \end{aligned} \quad (B5)$$

The final elevator angle required is then

$$\delta_e = \delta_{e1} + \delta_{e2} \quad (B6)$$

By substitution in equation (B6), the following expression is obtained for the elevator angle required on a flexible airplane to maintain the same lift on the tail produced by an arbitrary elevator deflection on a rigid airplane

$$\delta_e = \delta_{e0} \left[\frac{(\partial C_{L_t} / \partial \delta_e)_R}{(\partial C_{L_t} / \partial \delta_e)_F} - \left(\frac{\partial i_t}{\partial L_t} \right)_{A_Z} \frac{(\partial C_{L_t} / \partial \delta_e)_R q_t S_t}{(\alpha_{\delta_e})_F} \right] \quad (B7)$$

Since

$$(\alpha_{\delta_e})_F = \frac{(\partial C_{L_t} / \partial \delta_e)_F}{(\partial C_{L_t} / \partial \alpha_t)_F} \quad (B8)$$

equation (B7) can be written more conveniently as

$$\delta_e = \delta_{e0} \frac{(\partial C_{L_t} / \partial \delta_e)_R}{(\partial C_{L_t} / \partial \delta_e)_F} \left[1 - \left(\frac{\partial i_t}{\partial L_t} \right)_{A_Z} (C_{L\alpha_t})_F q_t S_t \right] \quad (B9)$$

APPENDIX C

EVALUATION OF LIFT EFFECTIVENESS FOR FLEXIBLE TAIL

The lift effectiveness of an elevator ($\partial C_{L_i}/\partial \delta_e$) for the case of a flexible horizontal tail will differ from that for a rigid tail due to distortion of the structure.¹ The streamwise twist of the structure can be found in reference 6 by applying a relaxation approach to the problem. Using this approach, the twist distribution for a sweptback tail can be written in series form as

$$\epsilon(\eta) = \epsilon_0(\eta) - \Delta\epsilon_1(\eta) + \Delta\epsilon_2(\eta) + \dots \quad (C1)$$

where

- $\epsilon(\eta)$ twist of the flexible wing
- $\epsilon_0(\eta)$ twist produced by the loading for the rigid wing
- $\Delta\epsilon_1(\eta)$ twist produced by the loading associated with $\epsilon_0(\eta)$
- $\Delta\epsilon_2(\eta)$ twist produced by the loading associated with $\Delta\epsilon_1(\eta)$ etc.

Since $\epsilon(\eta)$ can be written in series form, it is apparent that a similar expression can be written for the lift coefficient produced by a given elevator deflection for the flexible wing, so that

$$C_{L_{iF}} = C_{L_{iR}} - \Delta C_{L_{i1}} + \Delta C_{L_{i2}} \dots \quad (C2)$$

where

- $C_{L_{iF}}$ lift coefficient for the flexible tail
- $C_{L_{iR}}$ lift coefficient for the rigid tail
- $\Delta C_{L_{i1}}$ lift coefficient obtained by integrating the loading associated with $\epsilon_0(\eta)$
- $\Delta C_{L_{i2}}$ lift coefficient obtained by integrating the loading associated with $\Delta\epsilon_1(\eta)$ etc.

If the terms of equation (C1) are related by a constant of

¹ Elevator distortion is neglected in this analysis.

proportionality (which is the usual case),² equation (C2) can be written as

$$C_{L_{iF}} = C_{L_{iR}} - \Delta C_{L_{i1}}(1 - K + K^2 \dots) \quad (C3)$$

where

$$K = \frac{\Delta C_{L_{i2}}}{\Delta C_{L_{i1}}}$$

Equation (C3) simplifies to

$$C_{L_{iF}} = C_{L_{iR}} - \Delta C_{L_{i1}} \left(\frac{1}{1+K} \right) \quad (C4)$$

since the series $1 - K + K^2 \dots$ is merely an expansion of $1/1+K$. The ratio of the lift effectiveness for the flexible tail to that for the rigid tail can be obtained from equation (C4) by dividing by $C_{L_{iR}}$. The equation becomes

$$\frac{(\partial C_{L_i}/\partial \delta_e)_F}{(\partial C_{L_i}/\partial \delta_e)_R} = \frac{C_{L_{iF}}}{C_{L_{iR}}} = 1 - \frac{\Delta C_{L_{i1}}}{\Delta C_{L_{iR}}} \frac{1}{1+K} \quad (C5)$$

Equation (C5) can be simplified since K and $\Delta C_{L_{i1}}$ are proportional to q_t and becomes

$$\frac{(\partial C_{L_i}/\partial \delta_e)_F}{(\partial C_{L_i}/\partial \delta_e)_R} = 1 - \frac{\Delta C_{L_{i1}}/q_t}{C_{L_{iR}}} \frac{q_t}{1+(K/q_t)q_t} = 1 - \frac{\Delta C_{L_{i1}}}{C_{L_{iR}}} \frac{q_t}{1+kq_t} \quad (C6)$$

where $\Delta C_{L_{i1}}$ and k are evaluated for unit dynamic pressure at the tail.

² The line of load application for the first term $\epsilon_0(\eta)$ is the centroid of the chordwise loading produced by elevator deflection while the line of load application for the remaining terms is the aerodynamic center of the section. The relative contribution of bending and torsion, therefore, is not the same in $\epsilon_0(\eta)$ as in succeeding terms. Calculations made to date, however, have shown the constant of proportionality to apply to the relation between $\epsilon_0(\eta)$ and $\Delta\epsilon_1(\eta)$ as well as to the terms beyond $\Delta\epsilon_1(\eta)$. There may be some configurations for which the proportionality will be limited to $\Delta\epsilon_1(\eta)$ and succeeding terms, however.

REFERENCES

1. Collar, A. R.: The Expanding Domain of Aeroelasticity. British A. R. C. 9701, S. & C. 2022, June 11, 1946.
2. Collar, A. R., and Grinstead, F.: The Effects of Structural Flexibility of Tailplane, Elevator, and Fuselage on Longitudinal Control and Stability. R. & M. 2010, British A. R. C., Sept. 1942.
3. Lyon, H. M.: A Method of Estimating the Effect of Aero-Elastic Distortion of a Sweptback Wing on Stability and Control Derivatives. British R. A. E. TN Aero. 1813, July 1946.
4. Lyon, H. M., and Ripley, J.: A General Survey of the Effects of Flexibility of the Fuselage, Tail Unit, and Control Systems on Longitudinal Stability and Control. Rep. No. Aero. 2065, R. A. E. British, July 1945.
5. Pugsley, A. G.: Influence of Wing Elasticity Upon the Longitudinal Stability of an Aeroplane. R. & M. 1548, British A. R. C., 1933.
6. Skoog, R. B., and Brown, Harvey: A Method for the Determination of the Spanwise Load Distribution of a Flexible Swept Wing at Subsonic Speeds. NACA TN 2222, 1951.
7. DeYoung, John: Theoretical Symmetric Span Loading Due to Flap Deflection for Wings of Arbitrary Plan Form at Subsonic Speeds. NACA Rep. 1071, 1952. (Formerly NACA TN 2278).
8. Diederich, F. W.: Charts and Tables for Use in Calculations of Downwash of Wings of Arbitrary Plan Form. NACA TN 2353, 1951.
9. DeYoung, John, and Harper, C. W.: Theoretical Symmetric Span Loading at Subsonic Speeds for Wings Having Arbitrary Plan Form. NACA Rep. 921, 1948. (Formerly NACA TN's 1476, 1491, and 1772).