

REPORT 1363

ORIGIN AND PREVENTION OF CRASH FIRES IN TURBOJET AIRCRAFT ¹

By I. IRVING PINKEL, SOLOMON WEISS, G. MERRITT PRESTON, and GERARD J. PESMAN

SUMMARY

The tendency for the jet engine rotor to continue to rotate after crash presents the probability that crash-spilled combustibles suspended in the air or puddled on the ground at the engine inlet may be sucked into the engine. Studies with jet engines operating on a test stand and full-scale crashes of turbojet-powered airplanes showed that combustibles drawn into the engine in this way ignite explosively within the engine. Flames that could set the major fire appear at the engine tailpipe and often at the inlet when this explosive ignition occurs. This ignition may occur on the hot metal of the engine interior even after the combustor flame is extinguished and the engine rotor is coasting to rest.

Experiment showed that the gas flow through the engine is too rapid to permit the ignition of ingested combustibles on the hot metal in contact with the main gas stream. Ignition will occur on those hot surfaces not in the main gas stream. A portion of the engine airflow is diverted for cooling and ventilation to these zones where the gas moves slowly enough for ignition to occur.

The limited extent of the hot-metal zones that may start a fire permitted an approach to inerting the engine that involved the simultaneous initiation of the following actions immediately upon crash impact: (1) Shut off fuel flow to engine; (2) spray coolant (water) on those hot surfaces found to be ignition sources; (3) disconnect airplane electrical system at the battery and generator.

The effectiveness of this approach was evaluated by crashing airplanes powered by jet engines. Pylon-mounted engines attached to the wings were used to simulate airplanes with exposed pod nacelles. Fighters represented airplane types whose engines are contained within the main airplane structure. The quantity of water required as a coolant ranged from 9 to 12 gallons for each engine, depending on the engine and the length of the attached tailpipe. No fires occurred in six crashes in which the inerting system was used. Two airplanes crashed without protection caught fire.

INTRODUCTION

NACA research on the origin of crash fires, begun in 1949, has been extended to include jet aircraft. The work performed with jet aircraft followed an extensive program with piston-engine airplanes (ref. 1) which was documented with motion pictures (ref. 2). The objective of this work is to learn how turbojet crash fires start and to study means for reducing their likelihood. This report discusses the results

of the study and describes a method developed to reduce the probability of such crash fires.

Since jet airplanes have the same gross configuration and assortment of components as piston-engine airplanes, much of what was learned about the start of crash fires in piston-engine airplanes applies to the turbojet. In the jet phase of the research new elements of the problem, peculiar to the jet airplane, were emphasized. These include the jet engine, jet fuel, increased fuel quantity, and differences in fuel location. Of these new elements, the jet engine is most important. Ignition hazards presented by friction and electrostatic sparks, electrical arcs and sparks, and air heaters remain substantially the same for piston-engine and jet airplanes. Some safety advantage is obtained from the lower volatility of jet fuels, but some of this advantage is counteracted by the increased quantity of fuel and its broader distribution on the airplane.

In this report interest is centered on the part the turbojet engine plays in setting crash fires. Because of the knowledge gained about combustible spillage and movement in crashes with piston-engine airplanes, this combustible spillage could be simulated for a jet engine on a test stand. Therefore, the crash-fire hazard presented by the jet engine could be assessed by test-stand studies. At appropriate times, airplanes with jet engines were crashed to verify important results obtained on the test stand.

MECHANISM OF TURBOJET-AIRCRAFT CRASH FIRE

The start of a crash fire involves three major steps: movement of the crash-spilled combustibles to an ignition source, ignition of the combustible at the source, and spread of fire to the main body of fuel on the airplane. The movement of crash-spilled fuel to ignition zones and the spread of the fire were observed in the work with piston engines and are reported in detail in reference 1. There remains, then, the matter of understanding how the turbojet acts as an ignition source.

In order to observe how crash fires start with jet aircraft, two experimental full-scale crashes were conducted with turbojet aircraft having different engine installations. One of the aircraft was a C-82 airplane. The piston engines normally carried were replaced with either J35 or J47 engines, pylon-mounted to each wing to simulate a bomber-type engine installation. The airplane with turbojets is shown in figure 1. A fighter-type engine installation was

¹ Supersedes NACA Technical Note 3973 by I. Irving Pinkel, Solomon Weiss, G. Merritt Preston, and Gerard J. Pesman, 1957.

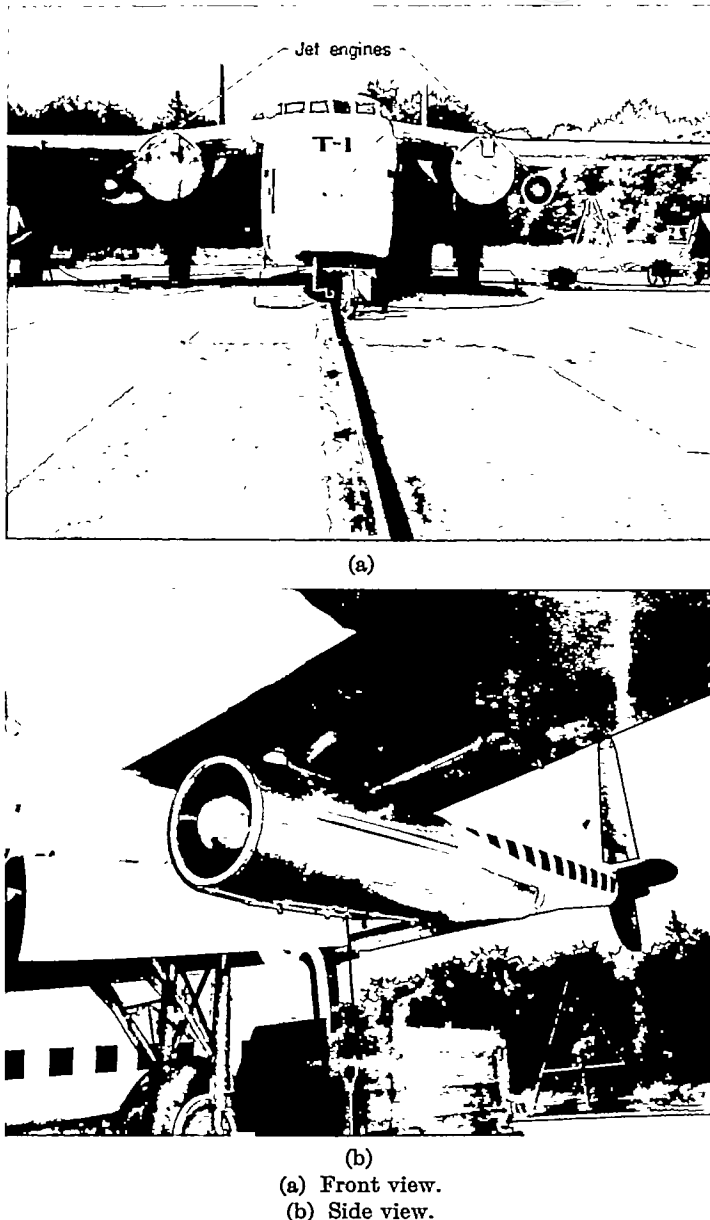

FIGURE 1.—Jet engines pylon-mounted to wing of cargo airplane.

represented by an F-84 airplane whose J35 engine is submerged in its fuselage.

These crashes simulated takeoff or landing accidents, which occur at low airplane speed where the chance for human survival of the crash impact is high. In the experimental C-82 crash, turbojets accelerated the airplane from rest to a speed of about 90 miles per hour along a 1700-foot runway. A crash abutment (ref. 3) at the end of the runway was arranged to rip off the landing gear, while a pair of poles on each side of the wing tore open the fuel tanks containing 1000 gallons of JP-4 fuel.

The airplane as it struck the barrier is shown in figure 2(a). The cloud of fuel mist (liquid droplets suspended in air) that appeared when fuel spillage occurred while the airplane was in motion is evident at the breach in both wings (fig. 2(b)). Red dye in the fuel accounts for the bright color of the fuel cloud. As the crashed airplane slowed, the fuel mist moved forward of the wing and reached the air inlet on the left engine (fig. 2(c)). A strong cross

wind swept the fuel mist away from the engine on the right wing.

Fuel mist ingested by the left engine was ignited some where within the engine. The ignited fuel mist produced the flames at the tailpipe and inlet shown in figure 2(d). These exposed engine flames ignited the fuel spilling from the wing (fig. 2(e)). The flame spread through this fuel to the wing to produce the stable fire shown in figure 2(f).

The F-84 fighter (fig. 3), carrying its turbojet submerged in the fuselage structure, caught fire in a similar crash. In this crash the fuel that entered the engine inlet was spilled from a fuselage fuel tank adjacent to the engine-inlet duct. Arrangements for ensuring the failure of this tank in the crash are shown in figure 4. A driving strut was attached at one end to the nose wheel strut. The free end of the driving strut carried a spear-like tank cutter aimed at the fuselage fuel tank, whose wall is adjacent to that of the air duct. When the nose wheel strut failed rearward in crash, the driving strut cut the duct and tank walls. Fuel in liquid form poured into the air duct and was drawn into the engine.

A crash of the F-84 is shown in the sequence in figure 5. Upon passing through the crash barrier the airplane flew over a ditch toward rising ground. The fuel spilled from the damaged wing tanks in mist form and moved to the rear of the airplane (fig. 5(a)), which was traveling about 100 miles per hour. When the nose gear collapsed upon contact with the ground, the fuselage fuel tank was pierced. Fuel poured from this tank into the engine-inlet duct. Ignition of this fuel within the engine provided a succession of flame puffs issuing from the tailpipe, one of which is shown in figure 5(b). These flame puffs moved into the wake of the airplane and continued to burn as isolated masses. Fuel spilling from the wing was ignited by these flames at the rear of the airplane (fig. 5(c)). The resulting fire moved forward through the fuel spilling from the wing and reached the slowing airplane to produce the fire shown in figure 5(d).

The fire that occurred in these crashes of the cargo airplane with externally mounted engines and the fighter with a submerged engine showed that fuel ingested with the engine air can ignite within the engine. The flames produced may reach out of the engine tailpipe and inlet to ignite combustibles spilled around the crashed airplane.

ROLE OF TURBOJET ENGINE IN SETTING CRASH FIRES

The crash fires just described show that the turbojet plays a threefold role in setting the crash fires. First, because the turbojet has no propeller to strike the ground and stop the compressor and turbine rotation when crash occurs, the engine continues to operate. The large air mass flow into the engine is drawn from a broad zone ahead of the engine inlet. Combustibles spilled into this zone are sucked into the engine with this air. This ingestion of combustibles is the first step leading to the start of fire by the engine. Second, combustibles drawn into the engine as liquid are well mixed with air by the compressor. Wetting of the compressor blades, particularly those of the rotor, promotes the evaporation of the liquid combustible in the air. Evaporation is further promoted by the heating of the

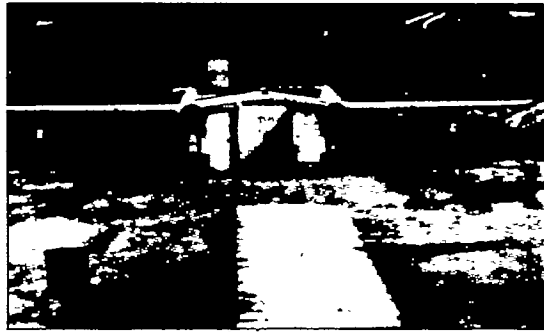

(a) Airplane contacting barrier.



(b) Fuel-mist cloud, 0.8 second after initial impact.

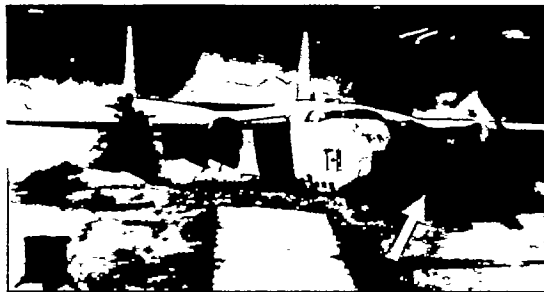

(c) Fuel mist entering left engine, 2.5 seconds after initial impact.



(d) Fire at engine inlet and tailpipe of left engine, 2.6 seconds after initial impact.

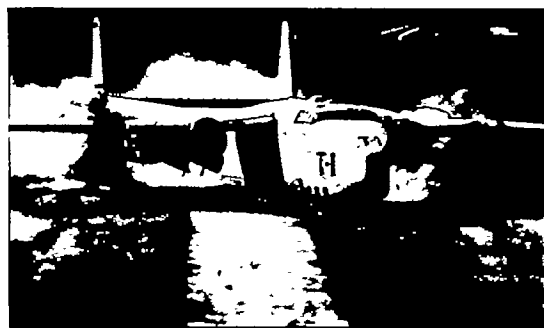

(e) Fire spread to fuel mist issuing from left wing, 2.8 seconds after initial impact.



(f) Spread of fire, 4.0 seconds after initial impact.

FIGURE 2.—Development of crash fire in simulated jet bomber.

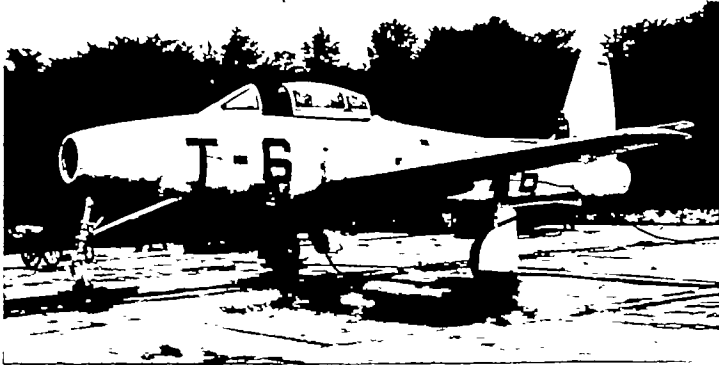

FIGURE 3.—F-84 Fighter airplane used in crash-fire investigation.

air in the compressor. The ingested fuel, favorably conditioned for ignition, then moves into zones in the hot end of the engine containing combustor flame and metal above the ignition temperature of petroleum fuels where ignition occurs. Third, the resulting flame propagates out of the engine to spread the fire.

Even if a pylon-mounted engine is torn free in a crash, its essential role in setting fires is unchanged. The normal fuel flow to the combustor is cut off upon engine separation, but the kinetic energy stored in the rotor maintains the compressor airflow. The inlet air velocity remains high enough for about 5 seconds after combustor fuel cutoff for appreciable entrainment of spilled combustibles with the inlet air. The probability of fuel ingestion is increased when the engine tumbles into the fuel deposited under or

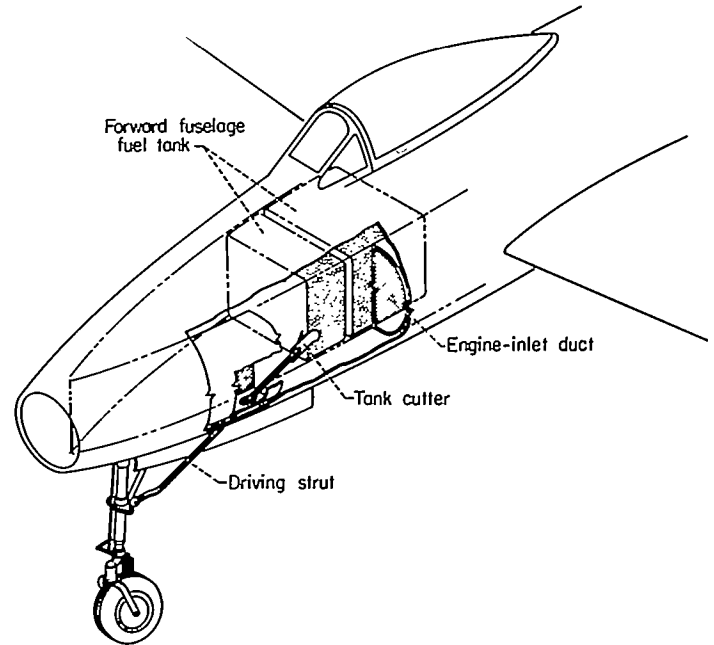

FIGURE 4.—Schematic diagram of F-84 tank-cutting mechanism.

behind the airplane.

A turbojet disintegrating in a crash could scatter hot-metal parts and burning combustor fuel into fuel-wetted areas. The resulting fire hazard is obvious and is not considered a subject for research. Experience gained in experimental crashes of turbojet aircraft in this and related programs has shown that there is little likelihood that the engine will come apart in a crash impact that is survivable. In no case did the engine break in crashes involving a total



(a) Wing-tank fuel spillage, 0.35 second after initial impact.



(b) Flames at engine tailpipe, 0.75 second after initial impact.



(c) Wing-tank fuel mist, 1.10 seconds after initial impact.



(d) Spread of fire, 2.15 seconds after initial impact.

FIGURE 5.—Development of crash fire in jet fighter.

of 23 engines, yet some of these crashes produced airplane decelerations well beyond human endurance.

The characteristics of the engine as a source of ignition received the most attention in this work. Understanding the ignition process within the engine was considered the key to any useful approach to reducing this crash-fire hazard.

FUEL INGESTION

An operating turbojet draws its air from a stream tube of diameter less than that of the engine inlet when the airplane is flying. When the engine is moving with low forward speed on the ground, the static pressure at the inlet is less than atmospheric and the stream-tube diameter is greater than the engine-inlet diameter. This condition exists when the airplane slows in crash. This stream tube broadens further if the engine comes close to the ground as the airplane breaks up.

Liquid combustibles sprayed into areas of low velocity in the inlet stream tube may drop to the ground before they reach the engine inlet. Liquid suspended in air (mist) entering the same zones is drawn into the inlet. Streams or jets of liquid combustibles projected into the high-velocity air within a few inlet diameters of the engine are also drawn into the inlet. As the velocity of the inlet air decreases with engine rotor speed, the distance at which ingestion of these streams or jets occurs shortens correspondingly.

Liquid fuel may be sucked into the engine from pools of fuel on the ground in front of the inlet. If the engine is on the ground, this fuel is drawn into the engine with the inlet air. If the engine is above the ground, a vortex that sometimes develops at the inlet and extends to the ground may raise liquid fuel from the ground into the intake airstream (ref. 4). Also, fuel stored in tanks adjacent to engine air-intake ducts could pour into the duct when walls separating them are breached.

Evaporation of liquid pools of fuel or fuel from wetted surfaces is a relatively slow process. This is particularly true for jet fuels with volatilities lower than aviation gasoline. Therefore, the vapors emanating from liquid fuel, spilled in the zone of influence of the inlet stream tube, rarely will be sufficient to produce a combustible mixture with the large mass airflow into the engine. Usually, ignitable concentrations of combustibles will enter the engine only when liquids are ingested. These liquids may be in solid streams or mist form.

ENGINE IGNITION SOURCES

The two principal engine ignition sources, combustor flames and hot-metal surfaces, are sufficiently different in their behavior to merit separate discussion. These differences relate to the time these sources persist after crash, the manner in which ignition occurs, and the mode of propagation of the resulting fire out of the engine.

Combustor flames.—If normal combustor fuel flow continues after crash, the combustor flame persists as long as fuel remains in the tank. Combustibles ingested with the engine intake air are ignited immediately upon contact with this flame. Since this ingested fuel enters the combustor through air openings in its liner, which extend to the

downstream end of the combustor, the burning of this fuel is not completed in the combustor. The fuel continues to burn in the tailpipe downstream of the turbine. Exposed flames that could start the crash fire might appear at the tailpipe exit, particularly if the tailpipe is short. Ignition of the ingested fuel-air mixture will occur even if it is somewhat leaner than the conventional lower combustible limit, because it is intimately mixed with the combustor flame.

If the fuel flow to the combustor is cut off by intent or accident, the main combustor flame is extinguished at once. However, the fuel manifold continues to drain slowly through the lower fuel nozzles to support small adjacent residual fires. These fires were observed in test-stand engine studies through windows in the combustor. The flames were visible up to 8 seconds after combustor fuel shutoff when the engine was operated at rated sea-level conditions. The ignition hazard provided by these residual flames compares with that of the full combustor flame. However, the ingested fuel would have to produce mixtures within the conventional combustible limits for the small residual flames to produce ignition.

Flames originating within the engine may also appear at the engine inlet as observed in figure 2(d). The appearance of this inlet flame may be explained in the following way. Burning of ingested fuel in the combustor flame reduces the turbine-inlet gas density. A higher pressure in the combustor is required to pass the gas through the turbine. When an abrupt change in over-all combustor fuel-air ratio is provided by the ingested fuel, the pressure in the combustor required to pass the combustor gas through the turbine may exceed the capability of the compressor at the existing rotor speed. The compressor flow may stall before the turbine can accelerate the rotor to a speed that will provide the necessary pressure. At this moment the combustor flame may propagate upstream through the ingested combustible mixture that fills the stalled compressor and exit at the engine inlet.

Hot-metal surfaces.—If combustor fuel shutoff is provided upon crash and residual flames are avoided, the hot engine metal may be a potential ignitor. Consequently, the temperatures of characteristic engine parts downstream of the compressor were measured on test-stand engines at locations shown in figure 6 for a period following combustor fuel shutoff. Thermocouples reading temperatures on rotating engine

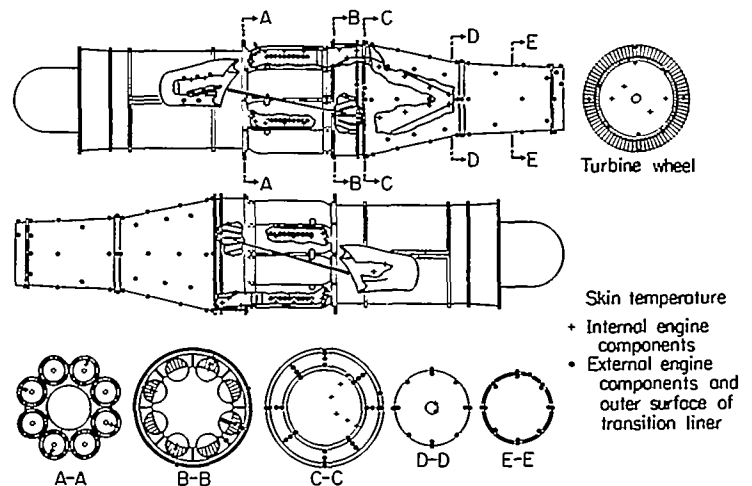

FIGURE 6.—Thermocouple locations on J47 engine.

parts were connected to recorders through slip rings on the engine shaft.

Maximum temperatures obtained with the J47 and J35 engines running on the test stand were comparable (fig. 7). Temperatures of similar locations in the J30 engine, which are not given here, were also comparable to those recorded on the J47 and J35 engines.

The engine metal temperatures aft of the compressor are discussed in detail in appendix A. These temperature measurements showed that all the metal downstream of the compressor was above the laboratory measured ignition temperature of jet fuels and lubricants. These parts were at dangerous temperatures for varying periods of time after the combustor fuel was shut off. However, temperature alone is an insufficient measure of the ignition potential of a hot surface.

In contrast with flame ignition, which is instantaneous in terms of time intervals significant in this problem, ignition of combustible atmospheres by hot surfaces is not instantaneous. An appreciable contact time is required between the combustible atmosphere and the hot surface in order for ignition to occur. The contact time required for ignition on hot surfaces has been the subject of some recent experiments. Unfortunately, much of the experimental data on ignition of combustible atmospheres flowing over hot surfaces was obtained with single-constituent hydrocarbon fuels under conditions that hardly approximate those in a jet engine. Some data obtained with jet fuels, however, show the important trends and the orders of magnitude involved.

The relation between surface temperature and contact time required for ignition is shown by data given in figure 8(a) for JP-4 fuel (refs. 5 and 6 and unpublished NACA data). Two main trends are evident. (1) The required contact time decreases with increasing surface temperature. (2) When the combustible atmosphere is at high pressure, which exists within an engine during the initial stages of a crash, ignition is possible at a lower surface temperature for a given contact time. As the pressure decreases to atmos-

pheric, ignition occurs at higher temperatures for a particular contact time.

The corresponding curves for kerosene and 115/145 and 100/130 aviation gasolines (refs. 7 and 8) show the same trends as the curves for JP-4 fuel (fig. 8(b)). The fact that a contact time of more than 0.1 second is required to ignite a combustible atmosphere of JP-4 fuel on a 1000° F surface and a combustible atmosphere of gasoline on a 1400° F surface is important in the problem being investigated herein.

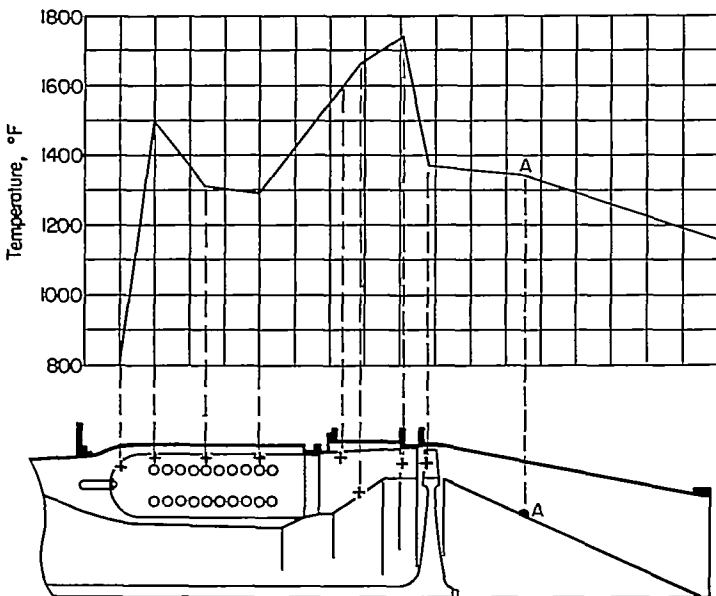
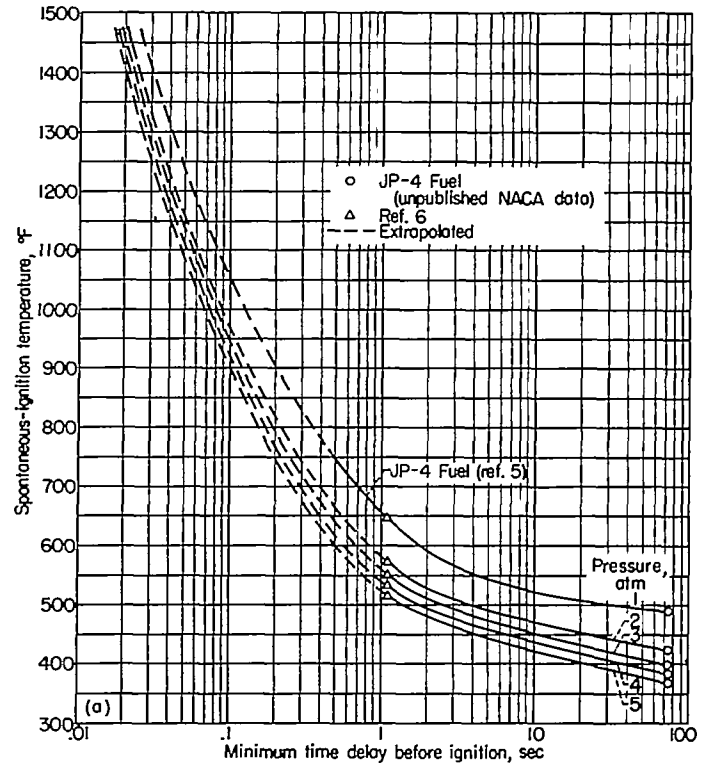
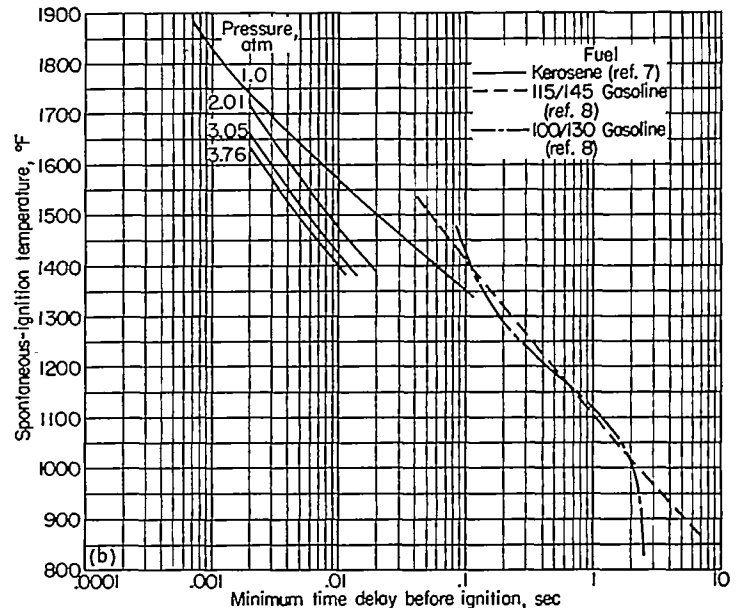

FIGURE 7.—Maximum temperatures of metal components in main gas stream of J47 and J35 engines.



(a) JP-4 Fuel.



(b) Kerosene and 115/145 and 100/130 aviation gasolines.

FIGURE 8.—Ignition characteristics of aviation fuels.

A study of the gas velocity through the hot zones of the engine in the main gas stream showed that combustibles pass through these zones too rapidly to ignite. This is true for approximately 20 seconds following engine combustor fuel shutoff. After this period, the probability of fuel ingestion is quite low. The engine temperature and velocity data used in this study are discussed in appendix B for the J35 engine. In these studies the engine temperature and air velocity data provided in figures 9 and 10 were used. Similar studies which led to the same result were made for the J30 and J47 engines. The method of analysis discussed in appendix B provides a first appraisal of the possibility of ignition of ingested combustibles by components in the main gas stream.

While the analysis showed the J30, J35, and J47 engines safe in this regard, it is conceivable that, with larger engines, ignition on the hot metal in the main gas stream may be possible. The longer components of the larger engines provide a longer transit time for the combustible atmosphere moving by. Minimum contact times for ignition may then exist for components in the main gas stream. The method discussed in appendix B is useful in determining when this may occur.

While ignition by hot surfaces is unlikely in the main gas streams of the engines studied, there are other zones in the engine where hot-metal ignition is likely. The hot-metal ignition zones within the engines studied were found to be in those areas where the gas velocity is less than that of the main gas stream. A small portion of the engine gas flow is diverted to hot zones in the engine where sufficient contact

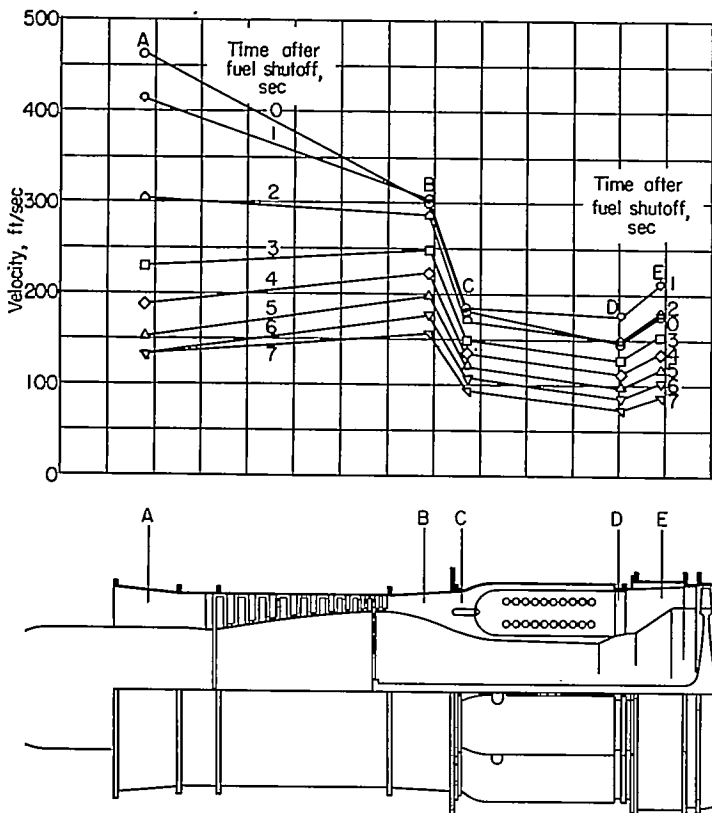

FIGURE 9.—Air velocity through J35 engine after combustor fuel shutoff.

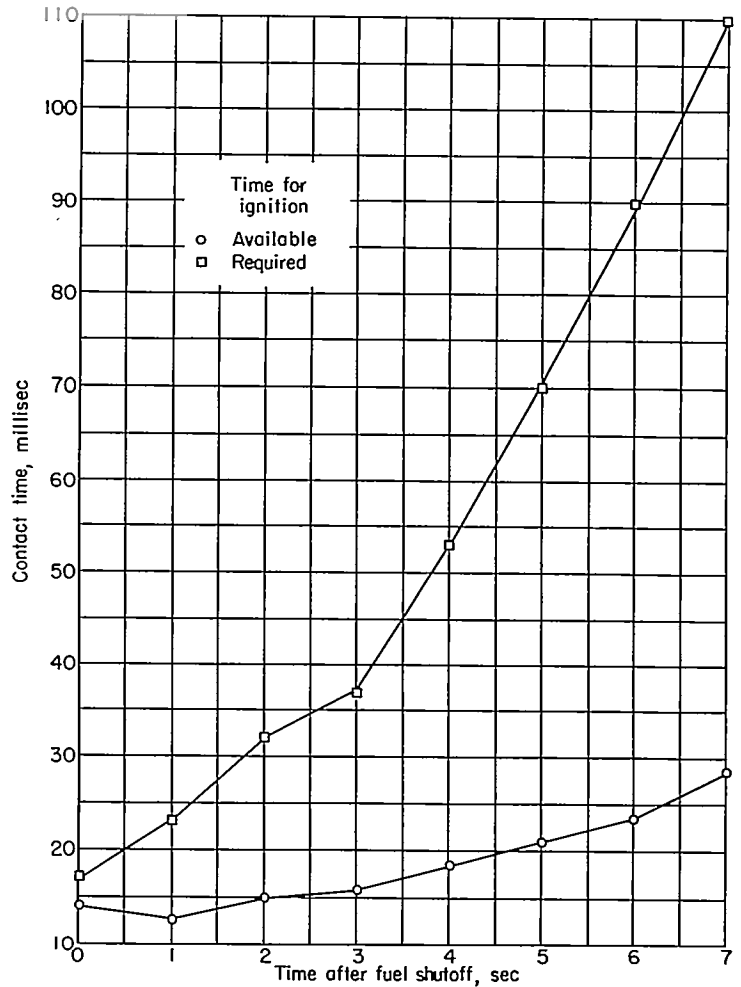

FIGURE 10.—Analysis of ignition probability in J35 combustor.

time for ignition exists. The quantity of gas diverted is sometimes unknown, and the geometry of the flow in the diversion zones is uncertain. For these reasons the period over which these diversion zones were hazardous was difficult to define based upon an analysis involving surface temperature and contact time.

The ignition zones were identified in test-stand engines by the method discussed in detail in appendix C. The technique employed involved the use of fuel sprays local to the engine zone suspected as an ignition source. Following engine operation at rated conditions for a time sufficient to establish temperature equilibrium, the fuel flow to the combustor was turned off and the fuel spray was turned on local to the zone under study. The fuel flow was programmed to maintain a combustible atmosphere in the zone. If ignition occurred, inerting means were installed to prevent the ignition in subsequent tests of upstream zones. By starting at the downstream end of the engine and proceeding upstream in this way, each ignition zone was identified and inerted in turn. As a final check after all the zones were inerted, fuel was injected into the main gas stream to determine whether ignition would occur. In this manner, ignition zones were found on the combustor liner, transition liner, turbine, inner cone, and tailcone and tailpipe (fig. 11).

Combustor liner: The ignition zone found on the combustor liner was the dome, which lies close to the primary

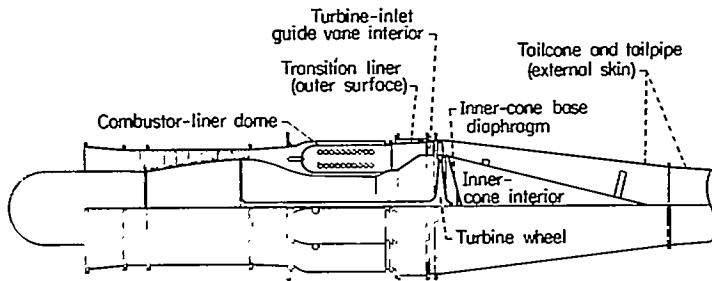

FIGURE 11.—Hot-metal ignition sources found in J35 engine.

combustion zone. The metal adjacent to the dome is heated by the combustor flame and attains unsafe temperatures in spite of the cooling provided by the adjacent air. Also, in this region the engine air is caused to recirculate by design to provide a zone of low transitional speed and promote good combustion. Both the hot metal of the combustor liner adjacent to the dome and the residual flames previously discussed make this zone particularly hazardous. The size of this zone is difficult to define, since it depends on the air temperature at the compressor outlet, the combustor design, and the ignition characteristics of the combustibles sucked into the engine.

Transition liner: The outside surface of the transition liner, which joins the combustor to the turbine, is another ignition zone. A small quantity of air flows continuously from the combustor over the outer surface of the transition liner. Combustibles sucked into the engine inlet are brought to the outside surface of the liner with this air. In some engines this air is drawn through the hollow turbine-inlet guide vanes for cooling. These vanes are at the same high temperature as the transition liner and must be counted as an ignition source in this engine zone.

Turbine: The cavity containing the turbine wheel is a zone of low gas velocity. The combustibles sucked into the engine inlet are delivered to each face of the turbine wheel with the cooling air drawn from the higher compressor stages. This air moves slowly enough for ignition to occur on the turbine-wheel faces and on the inner-cone base diaphragm.

Inner cone: Combustible atmospheres delivered to the turbine wheel from the compressor can enter the interior of the inner cone through vent holes. In some engines these vent holes are located at the base of the tailcone as shown

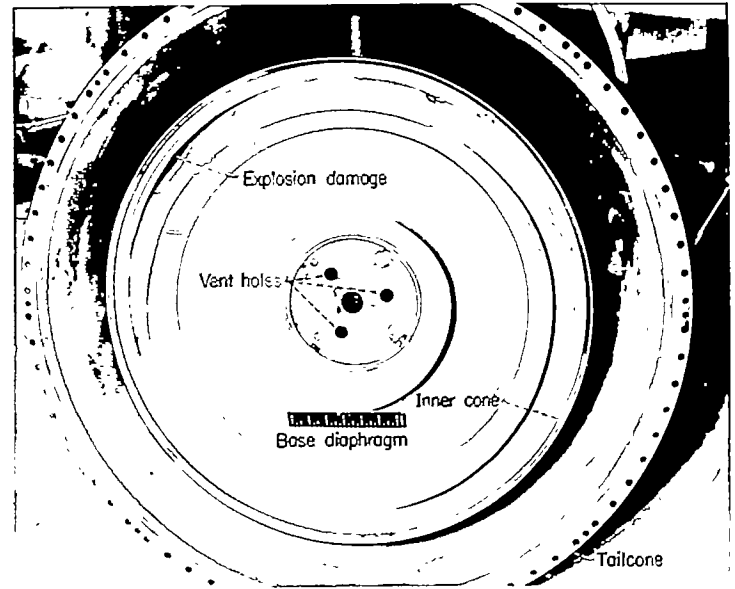

FIGURE 12.—J35 Inner-cone base diaphragm.

in figure 12. The plane of the inner-cone base is parallel to the turbine wheel. Combustibles entering the cone could ignite on the hot walls of its quiescent interior. The slight damage to the base diaphragm, indicated in the figure, followed ignition in the interior. The resulting flame might ignite the combustible atmosphere streaming through the engine to produce the dangerous flames at the engine inlet and tailpipe shown in figure 13.

Tailcone and tailpipe: The ignition zones discussed previously were all that were found within these engines. Experiments showed that fires could also be obtained when fuels or lubricants contacted the outside surface of the tailcone and tailpipe. The fire produced by jet fuel on an engine tailpipe is shown in figure 14. For engines having a pressure ratio of 5 or less, the unsafe exterior surfaces were confined to the tailcone and tailpipe.

CRASH-FIRE INERTING SYSTEM FOR TURBOJET AIRPLANES

If fuel ingestion could be prevented, a study of the engine ignition would not be necessary. A review of possible methods and means for employing closures at the inlet, outlet, or within the engine to prevent fuel ingestion on crash indicated little hope for this approach. Unacceptable



(a) Tailpipe



(b) Inlet.

FIGURE 13.—Flames issuing from engine following explosive ignition of fuel within engine.



FIGURE 14.—Fuel ignition on tailcone surface.

weight and complexity were required in the closure equipment necessary to meet the stringent specifications of fast actuation and strength to support the pressure differences developed by the compressor.

Previous crash research with piston-engine airplanes showed that a marked reduction in the crash-fire hazard could be realized by controlling potential ignition sources (ref. 1). Most of the ignition sources carried on the airplane are associated with the electrical system and the engine. By de-energizing the electrical system and inerting the engine ignition zones upon crash, most of the fire hazard is overcome.

The electrical system can be de-energized by opening the generator and battery circuits. The armatures of main electrical components likely to generate dangerous voltages as they coast to a stop are grounded close to these com-

ponents. In this way these armatures are brought to a rapid stop, and the length of electrical wiring at dangerous voltages is shortened considerably. Ignition sources associated with the engine consist of combustor flames and hot engine metal discussed previously.

COMBUSTOR FLAMES

In crash the combustor flame can be put out by shutting off the combustor fuel flow. Residual combustor flames can be avoided if the fuel manifold can be vented to an overboard drain at the time the main fuel valve is closed. Dribbling of fuel from the nozzles into the combustors is avoided in this way.

HOT ENGINE METAL

The problem of inerting the hot engine metal was solved during the search for these dangerous zones. The method employed for locating ignition zones within the engine, described in appendix C, involved the inerting of known ignition zones as the search for others proceeded. Water, applied to the dangerous hot surfaces, was chosen as the inerting agent because its high heat of vaporization made possible the cooling of ignition zones with small quantities. A blanket of steam generated by the water evaporating from the hot surfaces inerted these zones, thus preventing ignition while the surfaces cooled to safe temperatures.

The quantities of water required to inert the separate ignition zones within the J30, J35, and J47 engines are shown in table I. These quantities do not represent mini-

TABLE I.—WATER QUANTITIES USED FOR INERTING ENGINE COMPONENTS

Internal engine components	Engine					
	J30		J35		J47	
	Water quantity, gal	Duration of flow, sec	Water quantity, gal	Duration of flow, sec	Water quantity, gal	Duration of flow, sec
Combustor domes.....	0. 25	0. 5-1. 8	3	3	3	3
Transition liners and hollow turbine-inlet guide vanes.....	0. 03	0. 5-1. 8	1	14	1	14
Turbine wheel and inner-cone base diaphragm:						
Rapid flow.....	None	None	1	5	1	5
Slow flow.....	0. 89	2. 5	2	30	2	30
Inner-cone interior.....	0. 2	2. 5	0. 35	39	None	None
External engine components	Engine (airplane installation)					
	J30		J35 (F-84)		J47 Pylon installation (C-82)	
	Water quantity, gal	Duration of flow, sec	Water quantity, gal	Duration of flow, sec	Water quantity, gal	Duration of flow, sec
Tailcone and tailpipe.....	0. 7	6	^a 2 ^b 2. 5	^a 7 ^b 3. 6	2	5
Total water required, gal.....	2. 07	-----	11. 85	-----	9	-----

^aTailcone. ^bTailpipe.

mums but provide for a margin of safety. The water quantities listed cover all of a given class of components. For example, the 3 gallons of water for the J35 combustor include the eight combustors carried on each engine. The time duration of the water flow is given as well.

Combustor liner.—The method of introducing the water into each J47 combustor is shown in figure 15. A toroidal

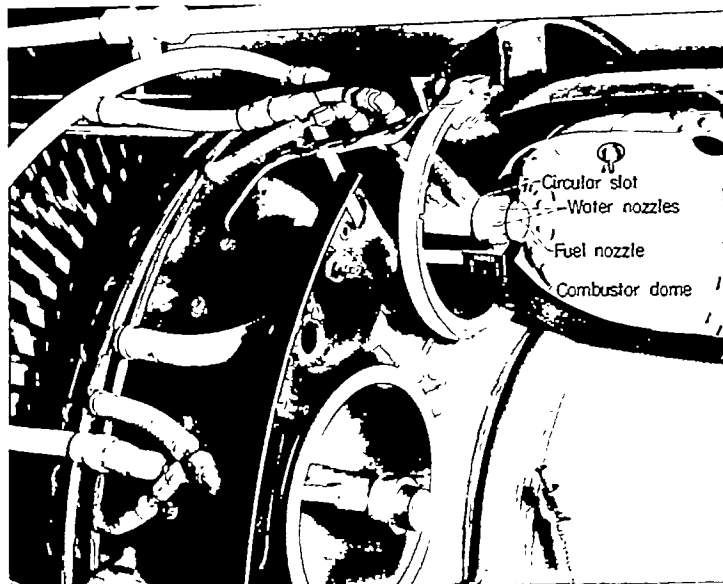

FIGURE 15.—Combustion-chamber water spray nozzle (J47 engine).

water manifold surrounded each fuel nozzle. Eight 0.082-inch holes on the downstream face of the manifold directed water at the combustor dome and its louvers leading into the combustion space. A continuous circumferential slot, 0.020-inch wide, on the perimeter of the manifold provided a sheet of water spreading radially. This water was directed downstream by the airflow to impinge and wash along the outside surfaces of the combustor liner. The 3 gallons of water delivered to the combustors of the J35 and J47 engines were divided equally among the combustors. The water discharge lasted for 3 seconds.

Transition liner.—Water was delivered to each transition liner in a fan-shaped sheet from nozzles arranged as shown in figure 16. Adequate cooling was obtained with three nozzles for each liner by directing the water at glancing incidence to the outside surfaces of the transition liner. One pint of water was discharged onto each transition liner of the J35 and J47 engines.

The water applied to the transition liner was sufficient to fill the hollow turbine-inlet guide vanes with steam for the 14 seconds the water flowed. During this period the space was inerted with steam. No additional water for the turbine-inlet guide vanes was required, since the main gas stream through the engine cooled the vanes to safe temperature in this time.

Turbine.—Cooling water to the turbine was applied as shown in figure 17. Several streams of water issued from the ring-type water manifold at the hub and spread centrifugally over the rotating wheel. The J35 and J47 engines contained an inner-cone base diaphragm that was hot enough to be dangerous. Cooling was effected by discharg-

ing an additional gallon of water over a 5-second period on the downstream face of the turbine wheel through the turbine cooling-air tube (fig. 17). A portion of this water rebounded from the spinning wheel and sprayed onto the base diaphragm.

Because the turbine wheel had large mass and thickness, reheating of the wheel surface to unsafe temperatures occurred after the applied cooling water was expended. An example of the reheating of the hottest part of the wheel is shown in figure 18. In early experiments, when 2 gallons of water were sprayed over a 2-second period onto the aft

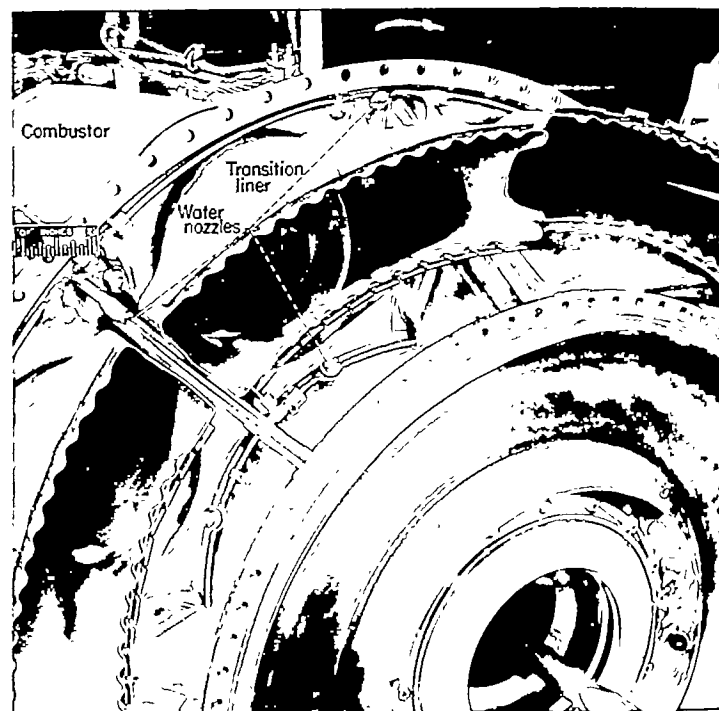

FIGURE 16.—Transition-liner water spray system (J35 and J47 engines).

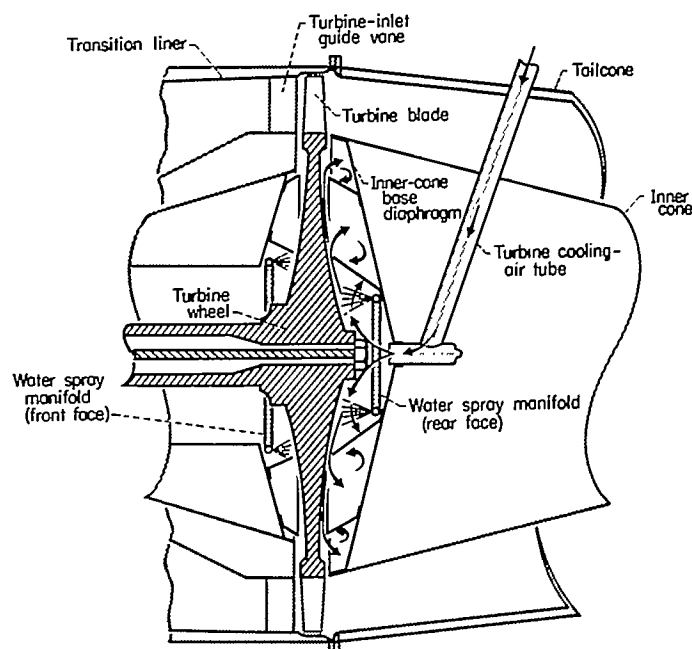

FIGURE 17.—Schematic diagram of turbine-cooling system.

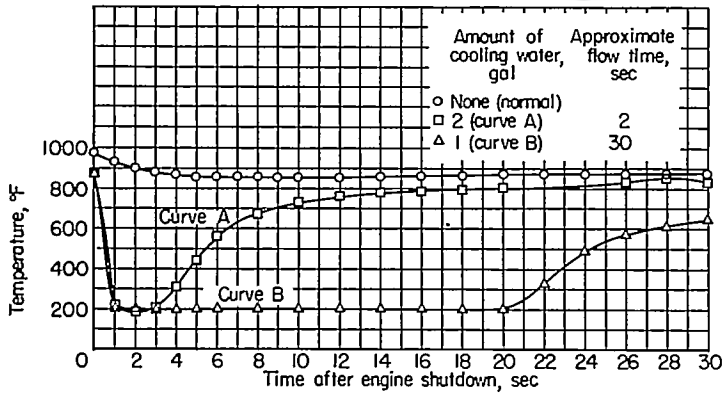

FIGURE 18.—Comparison of turbine-wheel cooling with short- and long-duration water sprays.

face of the turbine at the hub, the surface temperature dropped rapidly to the boiling temperature of water (curve A, fig. 18). Shortly after the water was expended, the surface of the wheel reheated by conduction from the hot interior. Unsafe temperatures above 600° F were established in less than 7 seconds. In order to avoid reheating to unsafe temperatures, the water discharge period was extended to 30 seconds. Experiments indicated that the quantity of water necessary could be reduced from 2 to 1 gallon for each face of the turbine disk. The wheel temperatures obtained are shown by curve B in figure 18. The time interval before reheating began was increased from 3 to 20 seconds. Reheating to temperatures above 600° F occurred after 27 seconds, at which time, however, the chance for fuel ingestion was remote.

This problem of reheating must always be considered in the use of water for cooling unsafe zones. The chance for fuel ingestion by the engine is greatest just before the airplane comes to rest in the first 5 seconds after crash impact. At this time fuel spilling from torn tanks has its broadest distribution forward of the wings in areas adjacent to the engines. Reheating after this time is not as serious within the engine as it would be on the outside surfaces which could be wetted by fuel that continues to drip and flow around the engine after the airplane comes to rest.

Inner cone.—The cavity of the inner cone was inerted by diluting the air with steam produced by the evaporation of water from spray nozzles within the inner cone. The initial water flow rate to the inner-cone cavity should be rapid enough to reduce the oxygen concentration within the cavity below 10 percent in 1 second. This was the approximate time latitude that existed between the start of fuel ingestion in the engine inlet and the entrance of dangerous amounts of fuel into the tailcone. The effectiveness of these arrangements was enhanced by directing the water sprays at the openings through which the fuel could enter. In this way the steam diluted the air local to the fuel entering the inner cone and provided protection, while the steam concentration developed throughout the cavity. The chamber was maintained inert until its walls were cooled to safe temperatures by the main gas stream. For engine cavities having the low ventilation rates found in the inner tailcone, the quantity of water required for protection could be calculated from the

volume of the cavity and volumes of steam generated per unit mass of water. Allowance was made, of course, for steam loss due to ventilation.

For the J35 engine, which has an inner-cone volume of 5.8 cubic feet, 0.35 gallon of water was required to provide an inert atmosphere. In contrast, the inner cone of the J30 engine, which has no base diaphragm and contains a volume of only approximately 0.7 cubic foot, required 0.2 gallon of water to achieve an inert atmosphere. This relatively larger amount of water was necessary because of the higher ventilation rates existing in the open-base inner cone of the J30 engine.

Tailcone and tailpipe.—The uniform distribution and efficient utilization of the cooling water on the tailcone and tailpipe posed some problems. Because the tailcone and tailpipe were circular in section and mounted with the axis horizontal, an unduly large number of water sprays had to be used to obtain complete wetting of the outside surface. The tendency of the water sprayed on the tailpipe to form thin rivulets reduced the area wetted by each spray. Water sprayed on the tailpipe above the equator provided rivulets that ran by gravity to the equator where they dripped off. Water sprayed on the tailpipe below the equator dripped off the tailpipe a short distance from the impingement area.

Effective water distribution and wetting were promoted by wrapping a 100-mesh stainless-steel screen around the entire exhaust system. This screen was spotwelded to the tailcone and tailpipe. Water sprayed on the screen penetrated to the surface of the tailpipe and tailcone. The screen promoted wetting and discouraged the formation of rivulets.

Water distribution over the screen-covered exhaust system was provided by a network of flattened tubes mounted axially in contact with the screen. Water sprayed through orifices drilled into the flattened side of the manifold facing the tailcone and tailpipe. The discharge orifices were 0.040 inch in diameter and spaced so that each would distribute water over approximately 50 square inches. Additional holes were drilled where experiment showed them to be necessary to provide uniform wetting. The tubes were also covered with ribbons of stainless-steel screen and spaced around the tailcone and tailpipe in order to provide a uniform water distribution. Three circular water manifolds connected the tubes to form a single interconnected unit. This water system is shown partially installed on the J35 tailpipe in figure 19. Some of the flattened manifolds, which are uncovered,

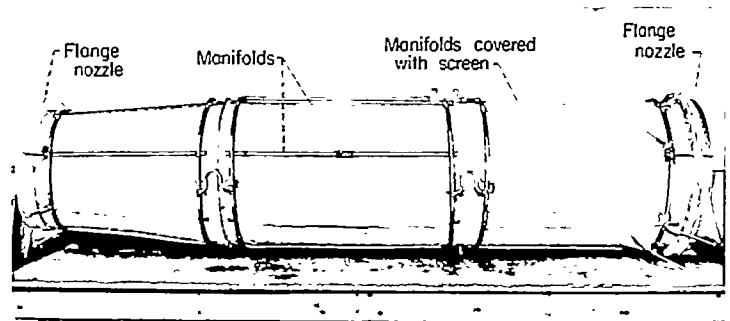

FIGURE 19.—Typical water distribution system for F-84 tailpipe.

are visible. The waffled appearance of the screen was produced by two sets of mutually perpendicular grooves that were rolled into the screen. These grooves permitted the screen to be tightly wound to the tailpipe and yet allowed water to flow under the screen.

Direct water sprays were provided through orifices and nozzles placed on the local circular manifolds in order to provide cooling of the massive flanges joining the tailcone to the engine and the tailpipe to the tailcone.

The quantity of water required for cooling the tailcone and tailpipe (table I) depended upon its diameter and length and the thickness of the metal. For the J35 engine with a long tailcone and tailpipe (157 in.) sized for the F-84 airplane, 4½ gallons of water were required. Two gallons of water were required for cooling the corresponding parts in a pod-mounted nacelle with a short tailcone and tailpipe (83 in.).

The total water requirement for protecting J35 and J47 engines ranged from 9 to approximately 12 gallons depending on the size of the tail sections. The J30 engine required approximately 2 gallons of water.

CRASH STUDY OF INERTING SYSTEMS FOR JET AIRPLANES

Two types of airplanes were used in the study of the use of water for reducing the likelihood of crash fires. Cargo airplanes (C-82) were fitted with pylon-mounted engine nacelles to simulate a jet bomber with pod-installed engines as shown in figure 1. Fighters (F-84) were used to represent airplanes having engines submerged within their structures (fig. 3).

INSTALLATION OF CRASH-FIRE SYSTEM

The complete crash-fire protection system used in this crash study is shown schematically in figure 20. The system comprised a water storage and distribution system, a shutoff valve for the combustor fuel, an electric switch for de-energizing the battery and generator circuits, and a crash-actuated switch for turning on the protection system. In these tests this switch was exposed on the airplane. The switch struck a target at the crash barrier which operated

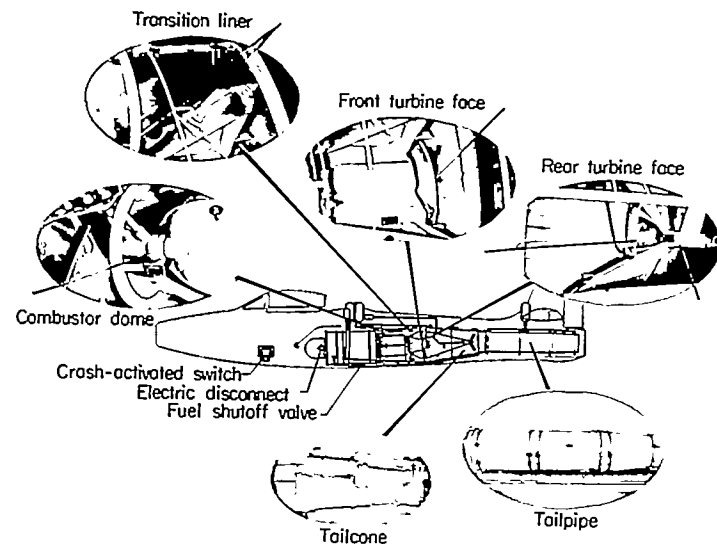
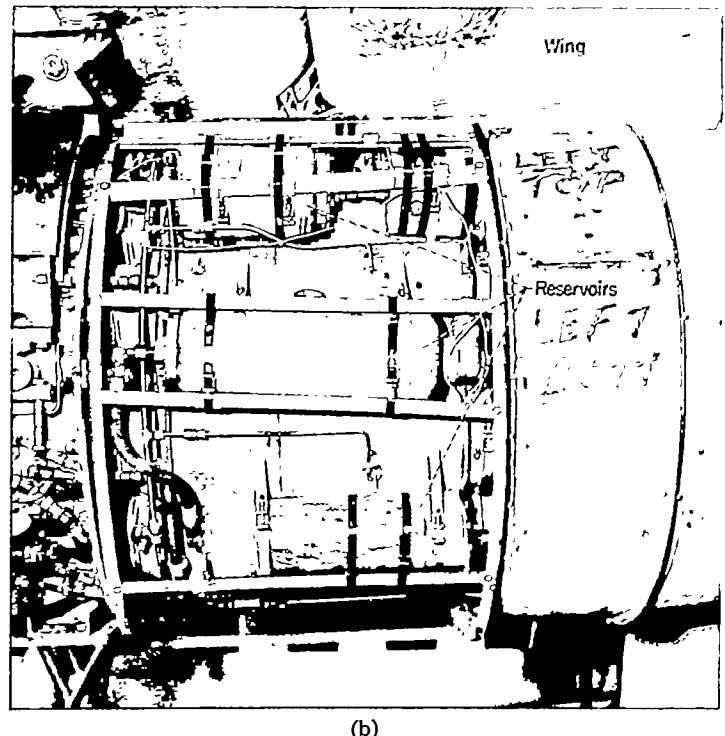
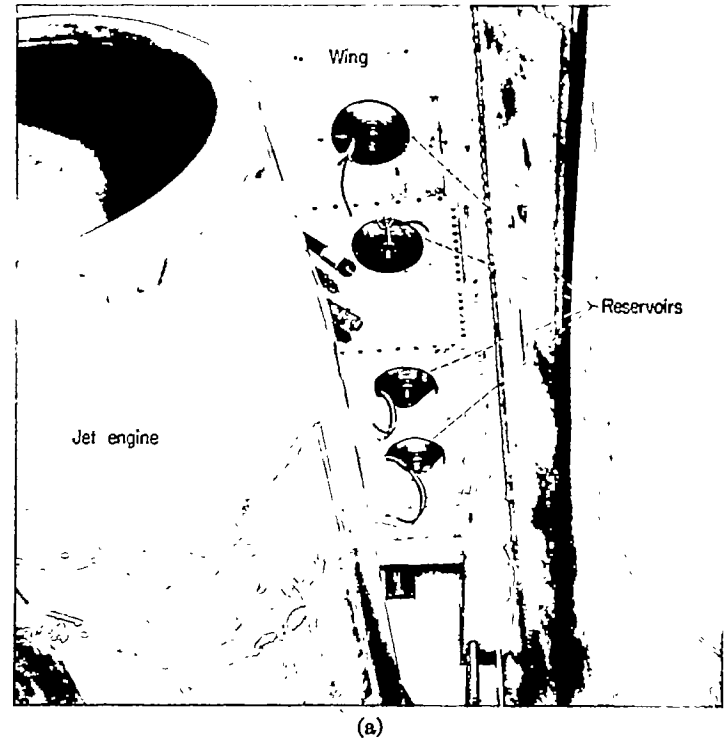

FIGURE 20.—Complete inerting system installed in F-84 airplane.

the switch shortly after major airplane damage had begun. While this arrangement was suited for these experiments, more elaborate means would be required for actual airplane installations. A comprehensive discussion of initiating systems for actuating crash-fire inerting systems is presented in reference 9.

In order to ensure that known quantities of water were applied at each engine ignition zone, the water for each zone was carried in a separate reservoir. Compressed gas for



(a) Located in wing root of C-82 cargo airplane.
 (b) Secured to J47 engine.

FIGURE 21.—Water reservoirs.

propelling the water was contained in the reservoir. The gas space and pressure were designed to give an initial water flow rate with a subsequent decline in the flow rate that was found experimentally to provide effective use of the water. Design compromises involving reservoir location, length of water distribution lines, reservoir pressure, and required quantity of water were made in order to stay within a 0.2-second time limit (after crash impact) for the application of the water at the ignition zones. This time limit was dictated by the normal lag involved in the functioning of the hardware components of the inerting system. Considerations of rate of fuel spread in the crash indicate that it is unlikely that combustible atmospheres will contact the engine ignition zones within this short interval of time.

In three of the crashes of cargo airplanes fitted with J47 engines, the water reservoirs were carried in the wing root as shown in figure 21(a). Flexible lines joined these reservoirs to the engines. In one crash in which arrangements were made to rip the engine from the wing, the water reservoirs were strapped between the engine combustors as shown in figure 21(b).

FULL-SCALE CRASHES

The first crash in which this inerting system was evaluated was conducted with a C-82 equipped with J47 engines. Shortly after the airplane passed through the crash barrier, the right wing tore free to produce the large volume of fuel

mist shown in figure 22(a). Entry of fuel mist into the left engine occurred 3.0 seconds after barrier impact just as the airplane began to ground-loop (fig. 22(b)). The condensed water vapor pouring from the engine tailpipe indicated that the fire-prevention system was working. The pool of fuel at the inlet lips of the left engine (shown in fig. 22(c)) represents some of the fuel that entered the engine inlet and then drained forward when the engine stopped. In spite of the fuel that entered the engines and that which poured over the nacelles (fig. 22(d)), no fire occurred. No fires occurred in two additional crashes conducted under the same circumstances.

It is evident that pylon-mounted engines on jet airplanes may part from the supporting wings in a crash. To determine whether fire protection could be provided to the engine after separation, a crash was arranged in which the left engine nacelle was torn free. The entire nacelle inerting system was built into the nacelle and designed to function regardless of the attitude assumed by the nacelle after separation from the airplane.

For this crash special water reservoirs were made that would fit in the spaces between the combustors on the J47 engines. Some of the water reservoirs held to the combustors by metal bands are shown in figure 21(b). To ensure complete expulsion of the water regardless of the nacelle orientation, reservoirs of the type shown in figure 23 were employed. Each consisted of a steel cylinder with a



(a) Fuel mist discharging from torn wing, 0.9 second after initial impact.



(b) Entry of fuel mist into left engine, 3.0 seconds after initial impact.



(c) Pool of fuel left in inlet cowl indicating fuel entry into engine.

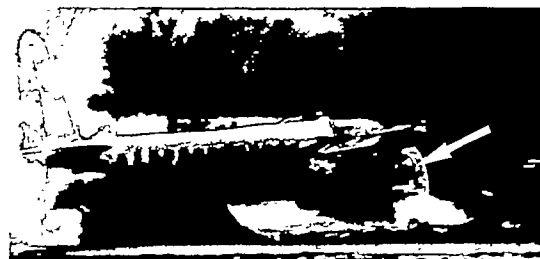

(d) Fuel spillage on nacelle.

FIGURE 22.—Crash of C-82 with jet engines equipped with inerting system.

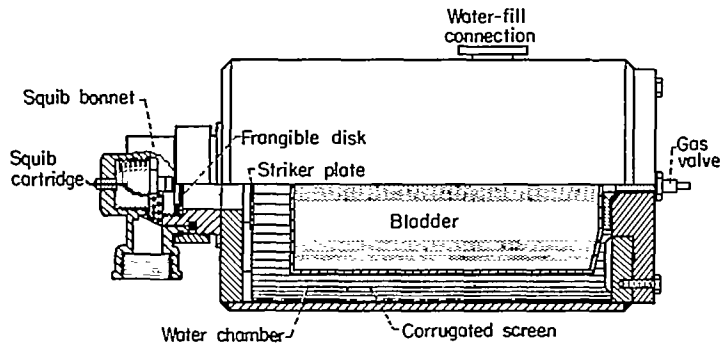

FIGURE 23.—Bladder-type water reservoir.

neoprene-fabric bladder insert. Water was retained in the steel cylinder while the volume of the bladder was filled with nitrogen gas at a pressure necessary to give the desired water discharge rate. When the outlet valve was opened, the bladder expanded, forcing the water to flow.

The airplane used in the crash in which engine separation was to occur differed from the previous airplanes only in the changes in the water system, just described, for the left engine. A blade rigidly attached to the bottom of the left nacelle was arranged to drag through an earth mound at the crash barrier and pull the engine from the wing.

Separation of the engine from the wing is shown in the picture sequence of the crash in figure 24. After separation (fig. 24(a)) the engine tumbled in the fuel spraying into the

wake of the damaged wing (figs. 24(b) and (c)) and came to rest in the fuel-wetted slide path of the airplane (fig. 24(d)). The plume of condensed water vapor at the tailpipe (fig. 24(b)) shows that the water inerting system was actuated. No fire occurred.

The crash technique for the F-84 with protected engines was identical with that used in the crash with the unprotected engine discussed in connection with figure 5. The crash-fire protection system for the engine was the same as that for the cargo airplanes fitted with jet pods.

The sequence of events following crash was the same for the F-84 as for the cargo airplanes. Poles at the crash barrier ripped open the wing fuel tanks and produced the fuel mist shown in figure 25(a). Collapse of the nose gear allowed fuel from the torn forward fuselage tank to enter the engine inlet. Vapor issuing from the tailpipe (fig. 25(b)) was provided in part by the fuel that passed through the engine from the damaged fuel tank adjacent to the engine inlet. Evaporation of water from the fire protection system contributed a large part of the vapors formed (fig. 25(b)). Inspection of the engine after crash showed the telltale dye stains left by the red-dyed fuel flowing through the compressor (fig. 26). No fire occurred.

A second crash of an F-84 airplane equipped with the fire protection system was conducted, again with no fire occurring. When the airplane came to rest beyond the crash barrier, complete wetting of the airplane by the red-dyed fuel was observed (fig. 27).



(a) 1.3 Seconds after initial impact.



(b) 1.8 Seconds after initial impact.



(c) 3.1 Seconds after initial impact.

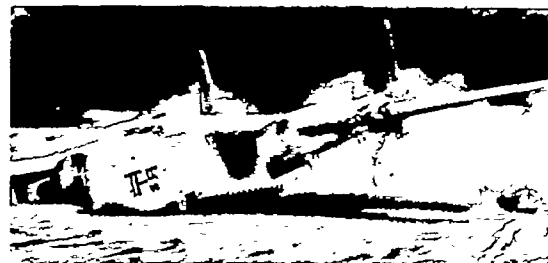

(d) 4.4 Seconds after initial impact.

FIGURE 24.—Separation of J47 engine from C-82 wing in crash.

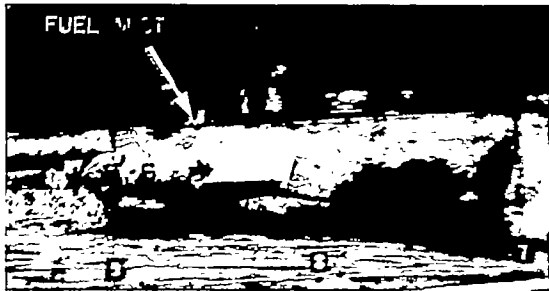

(a) Fuel mist, 1.1 seconds after initial impact.



(b) Water and fuel vapors issuing from tailpipe, 3.6 seconds after initial impact.

FIGURE 25.—Crash of F-84 with J35 inerting system installed.

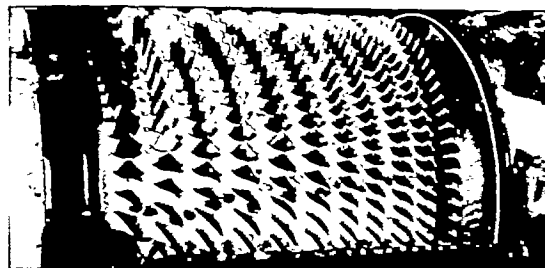

FIGURE 26.—Fuel-dye stains on J35-engine compressor following F-84 crash.



FIGURE 27.—Extensive fuel wetting of F-84 following crash with inerting system.

SUMMARY OF RESULTS

A study of the ignition of combustibles sucked into the inlets of turbojet engines having a size and compression ratio of the J35, J47, and J30 engines gave the following results:

1. The main gas stream through the engine moved too rapidly for ignition to occur on the hot metal within the engine.

2. Ignition may occur on the hot surfaces within the engine downstream of the compressor in those zones not in the main gas stream. For the engines studied, these zones included the combustor-liner dome, the transition-liner outer surfaces, the turbine-inlet guide vane interior, both faces of the turbine wheel, the inner-cone base diaphragm, and the interior of the inner cone.

3. Outside surfaces of the tailcone and tailpipe can ignite jet-engine fuels and lubricants.

4. A crash-fire protection system which de-energizes the electrical system, shuts off the fuel flow to the engine, and sprays coolant (water) over these hot surfaces proved effective in preventing fires. Fighter aircraft with submerged engines and simulated bomber configurations with pylon-mounted nacelles were used in these studies. No fire occurred in the six crashes when the engine fire-prevention system was used. Fires did occur in the two crashes in which no engine protection was provided. Coolant requirements ranged from about 9 to approximately 12 gallons of water per engine (J35 and J47 engines) depending on the length of tailpipe to be cooled.

LEWIS FLIGHT PROPULSION LABORATORY
 NATIONAL ADVISORY COMMITTEE FOR AERONAUTICS
 CLEVELAND, OHIO, *January 18, 1957*

APPENDIX A

ENGINE TEMPERATURE SURVEY

A first appraisal of the ignition potential of a surface is its temperature. Therefore, a complete temperature survey of the engine was made in order to determine where temperatures were high enough to cause ignition of aircraft-type combustibles.

The hottest parts of the engine, when operated at rated conditions, were those which lay in the main gas stream downstream of the compressor. The highest temperatures (fig. 7) were measured on the primary zone of the combustor liner, on the bend in the transition liner where the hot gases leaving the combustor impinge, and on the turbine-inlet guide vanes. Temperatures as high as 1660° and 1740° F were found on the transition liner and the adjacent turbine-inlet guide vanes, respectively. The stagnation gas temperature at the moving turbine blades was less than the stagnation temperature at stationary engine members in the same gas stream. The temperature of the blades was correspondingly lower, being about 1370° F for the hottest parts of the blade. The gases leaving the turbine were reduced in temperature because of the turbine work that had been done. Therefore, the temperature of the inner tailcone at location A in figure 7 was about 400° cooler than the turbine-inlet guide vanes. The temperature was about 1350° F at the hottest point of the inner cone and about 1150° F at its coolest point.

The largest temperature gradients occurred within the combustor (fig. 7) where some metal was in contact with the relatively cool combustor-inlet air and other metal was heated by the combustor flame. The maximum temperatures recorded were about 800° F on the dome, about 1500° F on the primary section of the combustor liner, and about 1300° F at the outlet. The lower temperatures at the combustor-liner outlet were produced by the cooler secondary combustor air.

Engine parts not in the main gas stream were heated mostly by conduction. The turbine wheel was the most massive engine part heated this way. The radial variation in temperature on the surface of the turbine wheel, shown in figure 28, resulted from the fact that the heat conduction was from the wheel rim to the relatively cool hub. The data shown were obtained with the engine operating at rated sea-level conditions. The turbine-wheel surface temperature varied from approximately 980° F at the rim to about 605° F at a point midway between the rim and hub. Cooling air from the compressor applied to the hub to protect the engine bearings maintained this temperature pattern.

The inner-cone base diaphragm, lying opposite the turbine, was also heated by conduction. In general, the temperature decreased from the rim toward the diaphragm center, which also received some cooling by the air applied to the turbine hub.

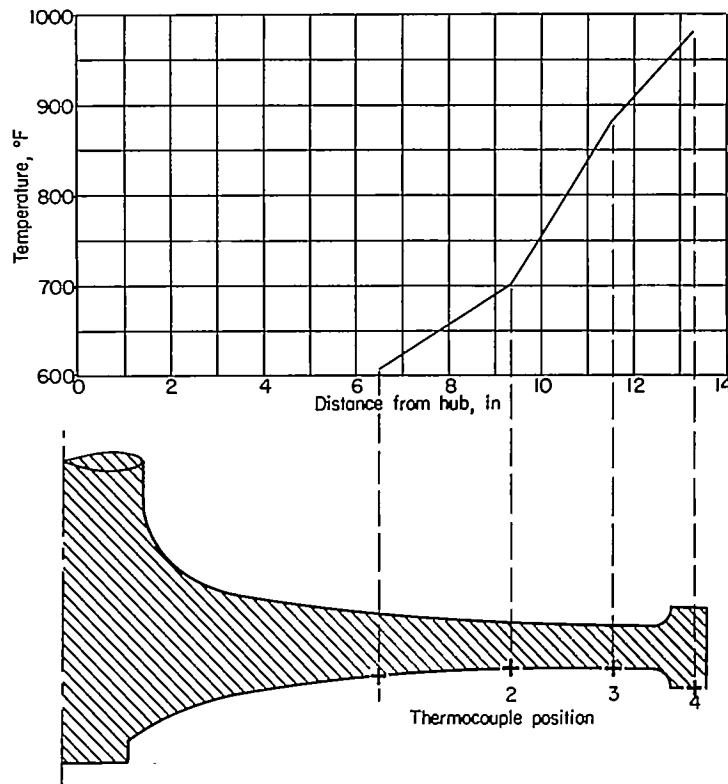

FIGURE 28.—Maximum temperatures recorded on J47-engine turbine wheel.

When the fuel flow to the operating engine combustor was shut off, the engine parts declined in temperature. Those components which lay in the main gas stream cooled more rapidly than those which did not. This rapid decline in temperature was due to the cooler air now flowing through the engine and the generally low heat capacity of these parts.

A history of the temperature of engine parts lying in the main gas stream is shown in figure 29. Fuel shutoff occurred at zero second, and the temperatures indicated were the maximum recorded anywhere on the component at the time noted. The hottest section of the combustion-chamber liner cooled from 1500° to 600° F in 24¼ seconds. It took over 30 seconds for the transition-liner temperature to decline from 1660° to 600° F. In 30 seconds the turbine-inlet guide vane temperature dropped from a maximum temperature of 1750° to 645° F. The rotating turbine blade temperature fell from 1370° to 600° F in 16 seconds. Inner-cone skin temperatures declined from 1350° to 640° F in 30 seconds.

Engine parts not located in the main gas stream declined in temperature at much slower rates (fig. 30). The hottest part of the turbine wheel was initially at 980° F and dropped only 100° F in 30 seconds after fuel flow to the engine had stopped. The turbine wheel remained above the ignition

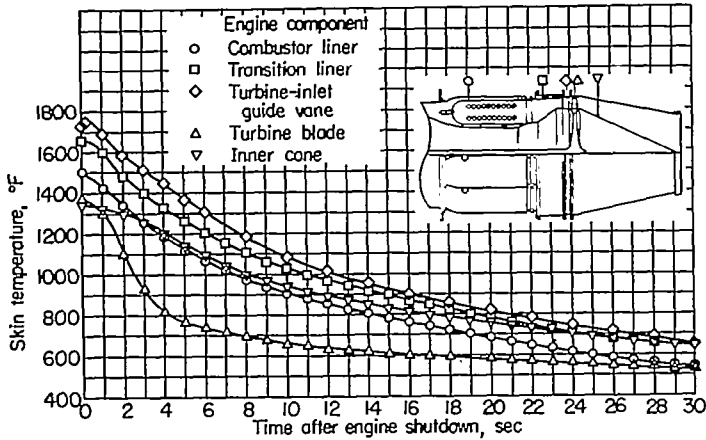

FIGURE 29.—History of maximum skin temperatures on engine components in main gas streams.

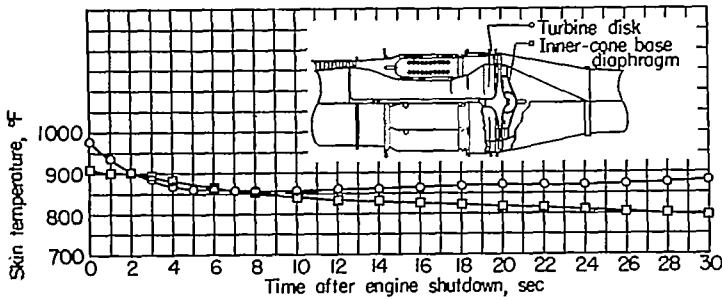

FIGURE 30.—History of maximum skin temperatures on turbine disk and inner-cone base diaphragm.

temperature of JP-4 fuel for 30 minutes after the engine was shut down. The large mass of the turbine disk contributed to its slow cooling rate. The inner-cone base diaphragm exhibited the same slow rate of cooling. Its maximum temperature was 910° F and cooled only approximately 115° F in 30 seconds.

Experimental crashes conducted with piston- and jet-engine airplanes showed that fuel mists that might be drawn into the engine inlet exist during the first 15 seconds after impact with the barrier. In this time the airplane decelerates to a stop and the wind clears the fuel mist from the crash zone. During this hazardous period these engine tem-

perature data show that practically all the metal downstream of the combustor inlet is above the laboratory measured ignition temperature of jet fuels and hydrocarbon lubricants.

External surfaces of the tailcone and tailpipe were the only unsafe zones found in engines with compression ratios of 5 or less. Airplane combustibles that contact this section of the engine can ignite. In engines of higher compression ratios unsafe engine case temperatures may extend downstream from the last compressor stages. Temperatures must exceed 600° F for ignition to occur readily on the engine case, because it is moderately ventilated. This fact was established by many ignition trials on the external engine surfaces.

Temperature measurements made on the external skin of the J47 engine (fig. 31) indicated that the tailcone and tailpipe temperatures remained above 600° F for more than 30 seconds after the fuel to the combustor was shut off. Temperatures of the engine case upstream of the tailcone and tailpipe were usually below 600° F (fig. 32). Although the turbine case reached a maximum temperature of 600° F and remained so for 10 seconds after the fuel was shut off (fig. 31), no ignitions were experienced here.

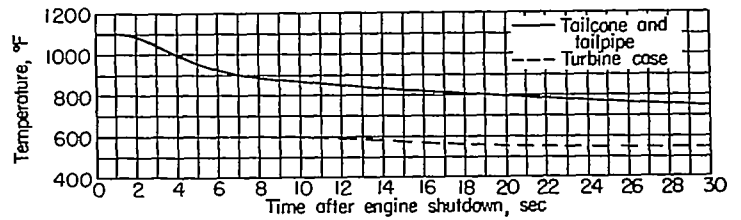

FIGURE 31.—History of maximum external skin temperatures on J47 turbine case and tailcone and tailpipe.

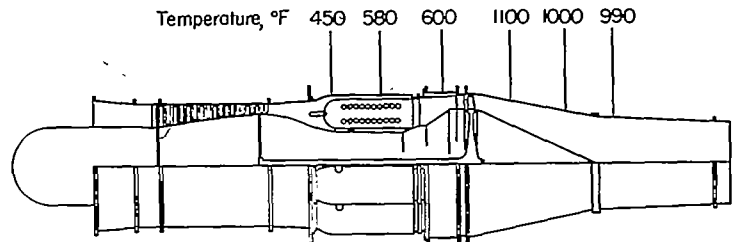

FIGURE 32.—Maximum external skin temperatures on J47 engine.

APPENDIX B

PRELIMINARY EVALUATION OF PROBABILITY OF HOT-SURFACE IGNITION

The data on contact time required for ignition (fig. 8) can be used to obtain an approximation of the probability of hot-metal ignition of combustibles sucked into the engine inlet. The engine metal temperatures are known from the measurements given in figures 29 and 30. The contact time can be computed from the known mass airflow through the engine (fig. 33). From the airflow data for the J35

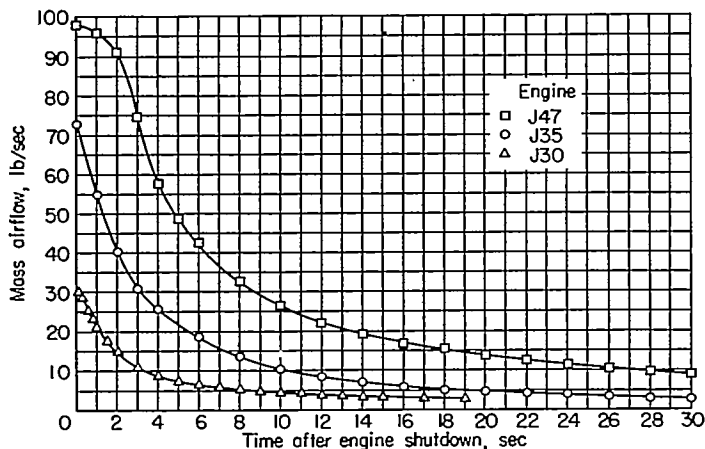

FIGURE 33.—Mass airflow after combustor fuel has been stopped.

engine and the engine geometry, the local air velocity through the engine upstream of the turbine inlet was plotted and appears in figure 9. Velocities were calculated only at the engine stations marked on the sketch. Each line connecting the symbols provides the velocity distribution through the

engine at the time indicated. It is interesting to note that at 3 seconds after fuel shutoff the velocity at the compressor exit was slightly higher than at the compressor inlet. This was due to the fact that the turbine-inlet total temperature had fallen to the point where it caused a large drop in compressor-exit static pressure. The lower static pressure was the dominant influence on the speedup in airflow.

This analysis does not consider the increase in contact time resulting from recirculation of gases in the combustor-dome area or approximately the first 30 percent of the combustor. However, the contact time available in the aft 70 percent of the combustor might be considered conservative, since the indicated contact time was based on the total length of the combustor. A required contact time may be picked from the data in figure 8(a), if the entire combustor liner is considered to be at the maximum temperature shown in figure 29. A crude analysis of this type for the first 7 seconds after fuel shutoff is shown in figure 10, which indicates that the gas stream moved through the combustor liner too quickly to allow a sufficient contact time for ignition from the hot metal. Ignition is considered likely when the available contact time equals or exceeds the required contact time.

A similar analysis for the other engine components showed that the contact time of the main gas stream in each component was too short for ignition to occur. This analysis by components was based on the assumption that the fuel-air mixture in contact with the hot metal in passage through one component is no longer in contact in passage through the next.

APPENDIX C

METHOD OF LOCATING IGNITION ZONES WITHIN ENGINE

Inspection of most turbojets shows that the engine interior is divided into well-defined cavities, some of which are in flow communication. The airflow direction through these cavities is also well defined, so that they can be considered to be arranged in order. Each can be recognized to be upstream or downstream with respect to another. For this reason each of the cavities could be explored separately by the following technique for the ignition hazard it presents.

The ignition hazard presented by each cavity was studied by installing a fuel spray system in each cavity to produce a combustible atmosphere as desired. A separate system was also installed to apply cooling water to the hot surfaces in the cavity or to provide a water spray in the cavity space.

The engine cavity farthest downstream, the inner cone, was studied first. The arrangements used for the J30 tailcone are shown schematically in figure 34. A fuel system,

was arranged to spray water on the turbine wheel to avoid ignition from this source.

In this study of internal ignition zones the engine was run at rated conditions until temperature equilibrium was established. The fuel flow to the combustor was stopped, and 0.2 second later the fuel spray in the inner-cone cavity was turned on. Ignition of this fuel occurred. The process was repeated with increasing intervals between engine combustor fuel shutoff and the beginning of fuel spray into the inner-cone cavity. Ignitions were obtained up to 20 seconds after the combustor fuel was shut off.

Following this evaluation of the inner-cone interior as an ignition hazard the runs were repeated, but this time the water sprays were also turned on with the fuel spray in the inner cone. Initially, sufficient water was used to ensure absence of ignition. By progressively reducing the water quantity in repeated runs a minimum water requirement was established below which ignition would sometimes occur.

The next upstream ignition zone is the cavity of the engine containing the turbine wheel. In order to provide positive identification of the ignition surfaces in the turbine-wheel cavity, a fuel spray was installed to fill the cavity with a combustible atmosphere. Runs were made similar to those described for studying the inner cone. The water spray system in the inner cone was always used to ensure that no ignition would occur in this zone. Repeated runs were made in which fuel was sprayed into the turbine-wheel cavity following fuel shutoff to the engine combustor. Evaluation of the smallest quantity of cooling water for the turbine that was required to prevent ignition was obtained in the manner described for the inner cone. These quantities may be influenced by the method of water distribution employed. In order to provide a margin of safety for crash experiments, quantities of water above the minimum were used. These are tabulated in table I.

Each of the engine cavities was studied in turn by proceeding upstream in this way. The zones that presented ignition potential were identified and inerted.

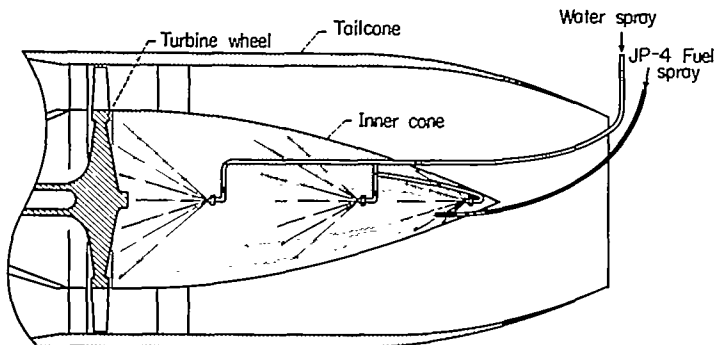

FIGURE 34.—Typical equipment used to study ignition hazard (J30 inner tailcone).

consisting of a single tube and nozzle, was arranged to spray fuel in measured quantities into the cavity of the inner cone to produce a combustible atmosphere. In addition, three water spray nozzles were installed facing the upstream direction. Since the J30 engine has no base diaphragm, the downstream face of the turbine wheel must be taken as a bounding surface of this cavity. The upstream water nozzle

REFERENCES

1. Pinkel, I. Irving, Preston, G. Merritt, and Pesman, Gerard J.: Mechanism of Start and Development of Aircraft Crash Fires. NACA Rep. 1133, 1953. (Supersedes NACA RM E52F06.)
2. Pinkel, I. Irving, and Preston, G. Merritt: NACA Crash Fire Research. NACA Tech. Film 26, May 1953.
3. Black, Dugald O.: Facilities and Methods Used in Full-Scale Airplane Crash-Fire Investigation. NACA RM E51L06, 1952.
4. Rodert, Lewis A., and Garrett, Floyd B.: Ingestion of Foreign Objects into Turbine Engines by Vortices. NACA TN 3330, 1955.
5. Jones, G. W., Zabetakis, M. G., Scott, G. S., and Furno, A. L.: Research on the Flammability Characteristics of Aircraft Fuels. WADC Tech. Rep. 52-35, Supp. 1, Feb. 1, 1952-Feb. 1, 1953, Wright Air Dev. Center, Wright-Patterson Air Force Base, Jan. 1954. (Contract AF-18(600)-151.)
6. Smith, Maxwell: Technical Curiosities: "Oleodieseling." Shell Aviation News, no. 183, Sept. 1953, pp. 8-9.
7. Mullins, B. P.: Studies on the Spontaneous Ignition of Fuels Injected Into a Hot Air Stream: Pt. II—The Effect of Physical Factors upon the Ignition Delay of Kerosine-Air Mixtures. Rep. No. R.90, British N.G.T.E., Sept. 1951.
8. Jones, G. W., Zabetakis, M. G., Scott, G. S., and Furno, A. L.: Research on the Flammability Characteristics of Aircraft Fuels. WADC Tech. Rep. 52-35, Supp. 2, Feb. 1, 1953-Feb. 1, 1954, Wright Air Dev. Center, Wright-Patterson Air Force Base, Aug. 1954. (Contract AF-18(600)-151.)
9. Moser, Jacob C., and Black, Dugald O.: Proposed Initiating System for Crash-Fire Prevention Systems. NACA TN 3774, 1956.

