REPORT No. 155

**A STUDY OF AIRPLANE MANEUVERS WITH SPECIAL
REFERENCE TO ANGULAR VELOCITIES**

By H. J. E. REID
Langley Memorial Aeronautical Laboratory

REPORT No. 155.

A STUDY OF AIRPLANE MANEUVERS WITH SPECIAL REFERENCE TO ANGULAR VELOCITIES.

By H. J. E. REID.

SUMMARY.

This investigation was undertaken by the National Advisory Committee for Aeronautics for the purpose of increasing our knowledge on the behavior of the airplane during various maneuvers and to obtain values of the maximum angular velocities and accelerations in flight. The method consisted in flying a JN4h airplane through various maneuvers while records were being taken of the control position, the air speed, the angular velocity and the acceleration along the Z axis. The results showed that the maximum angular velocity about the X axis occurred in a spin and amounted to 2.43 radians per second, while about the Y axis the maximum was 0.96 radians per second in a barrel roll. The maximum angular acceleration about the X axis of -2.10 radians per (second)² occurred in a spin, while the maximum about the Y axis was 1.40 radians per (second)² when pulling suddenly out of a dive. These results have direct application to the design of airplane parts, such as propeller shaft and instruments.

INTRODUCTION.

Up to the present time there seems to have been no systematic attempt made to study the movements of an airplane while it is maneuvering or to record directly the angular velocity. The work which has been done to obtain data of this kind has been either entirely based upon theoretical deduction or made use of the observed length of time required by an airplane to perform a given evolution. References to the principal literature on the subject are given below:

1. Controllability and Maneuverability of Airplanes. N. A. C. A. Report No. 153.
2. The Pressure Distribution over the Horizontal Tail Surface of an Airplane. N. A. C. A. Report No. 148.
3. The Angles of Attack and Air Speeds during Maneuvers. N. A. C. A. Report No. 105.
4. The Maximum Angular Velocity of an Airplane. R. & M. No. 670.
5. The Investigation of the Spin of the Airplane. R. & M. No. 618.
6. The Experimental and Mathematical Investigation of Spinning. R. & M. No. 411.
7. Lateral Control with Different Types of Wing Flaps. R. & M. No. 413.
8. Forces in Diving and Looping. McCook Field Bulletin, June, 1918.
9. On the Possible Loading on the Wings and Body of an Airplane in Flight. R. & M. No. 496.

For the purpose of obtaining actual data on angular velocities from an airplane in flight an instrument was designed and constructed to record directly the angular velocity about a single axis. This instrument in connection with several other recording instruments was installed in a JN4h airplane and records were taken during a loop, spin, roll and when pulling sharply out of a dive. Complete records from these instruments are shown in this report and should furnish valuable information both to the pilot and to the designer.

METHODS AND APPARATUS.

The instruments used in this investigation were the N. A. C. A. air speed meter,¹ the control position recorder,² and an accelerometer³ together with the angular velocity recorder developed especially for this investigation. The installation of these instruments is shown in Figure 1. The

¹N. A. C. A. Technical Note No. 64.

²N. A. C. A. Technical Note No. 97.

³N. A. C. A. Reports Nos. 99 and 100.

accelerometer is not in view as it was necessary to place this instrument as near to the center of gravity of the machine as possible. All of these instruments have been more or less fully described before except the angular velocity recorder.

A photograph of this latter instrument is shown in Figures 2, 3 and 4 with the cover removed. As with the other N. A. C. A. recording instruments a record is made on a standardized

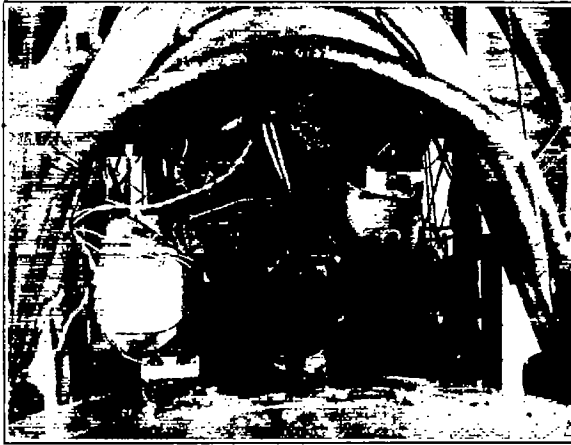

FIG. 1.—Installation of instruments in the cockpit.

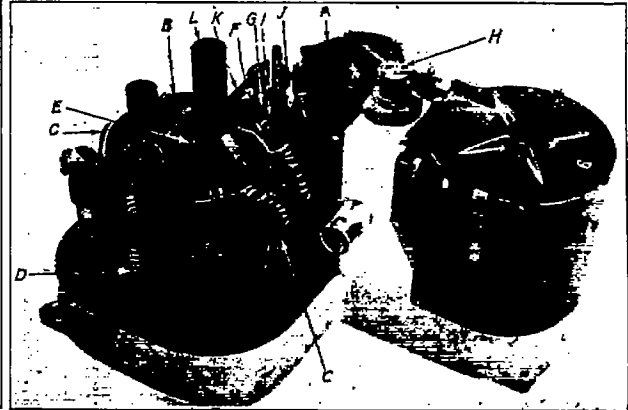

FIG. 2.—Angular velocity recorder.

film drum which is rotated at a speed of about 1 turn per minute by a constant speed motor (A) driving through a pair of worm and gears beneath the base. The angular velocity about an axis in a horizontal plane and at right angles to the pivot axis is measured by measuring the precessional force exerted by the gyroscope (B) mounted in pivots (C) and restrained in a neutral position by the springs (D). The gyroscope itself consists of a direct current motor mounted inside of an aluminum case which is kept at constant speed of 10,000 r. p. m. by means of the

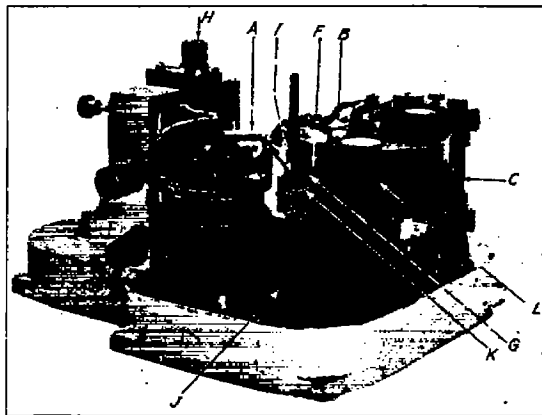

FIG. 3.—Angular velocity recorder.

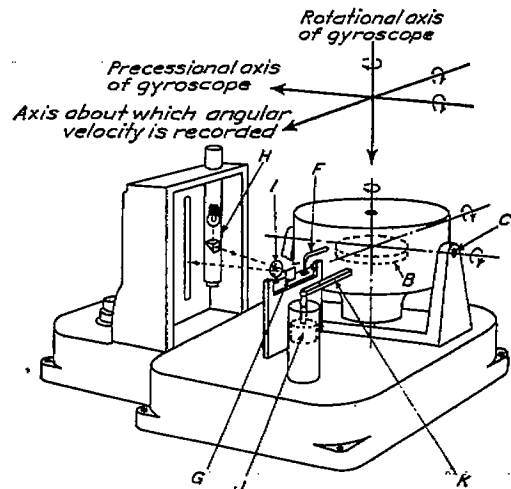

FIG. 4.—Diagrammatic sketch of angular velocity recorder.

governor (E). The motion of the gyroscope case about its pivots, due to the precessional moment of the gyroscope, is transmitted by means of the arm (F) and stylus to a small mirror (G) not in view. In the same way as with the other N. A. C. A. recording instruments a beam of light from the light holder (H) is reflected from this mirror through a lens (I) (not in view) onto the film. In order to prevent the gyroscope from vibrating the dashpot (J) is attached to the end of the arm (K).

The gyroscope case is carefully balanced about its pivots so that linear accelerations from any direction will be ineffective in producing rotation. It can be seen that an angular accelera-

tion about the axis of the pivot will produce a deflection in the springs and thus introduce an error into the reading of the instrument. By keeping the speed of the gyroscope high, however, the springs may be made very stiff so that the error from this cause is only a few per cent in the worst cases.

When records are being taken on a number of recording instruments it is quite necessary that a strict synchronization be obtained between them. This has been accomplished in the present test by setting in the case of each instrument small lamps (shown at L) which are connected by a common circuit to an electric chronometer which closes the circuit at 3 seconds intervals, thus making a sharp black line across each record simultaneously. A set of records taken from the recording instruments used in this test are shown in Figure 5 and the synchronizing lines are quite evident.

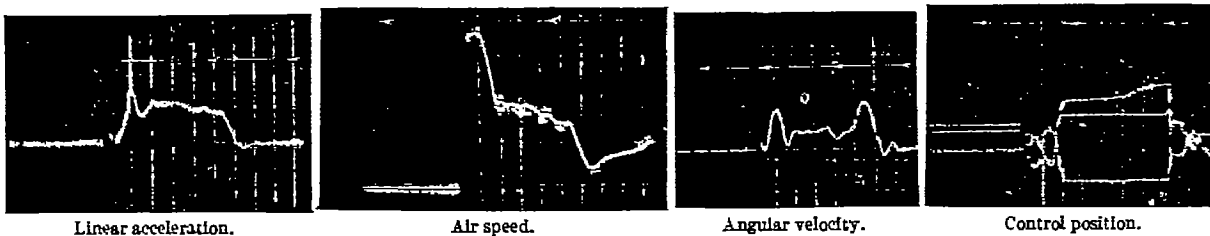

Fig. 5.—A set of records obtained with N. A. C. A. instruments. (Tall spin.)

In making these records the observer merely placed the recording drum on the instrument, all the electrical circuits being closed and opened by a common switch which was convenient for the pilot. Just before each maneuver began the pilot would close this switch, fly through it, and, at the end, open the switch, all of the instruments automatically recording during this time. The deflections on the records were multiplied by the proper calibration factor and replotted in the figures of this report. The angular acceleration was directly obtained from the angular velocity by differentiating it graphically, while the angular displacement of the machine was obtained by means of the integrator.

PRECISION.

The control position recorder was calibrated for every record by holding the controls in neutral and turning on the light for an instant. Care was taken to see that there was little backlash in any of the connecting wires. The precision of the control angles should in all cases be good to $\pm 1^\circ$. The air speed instruments were calibrated over a speed course within the range of level flying speeds and should therefore be correct to ± 2 miles per hour excepting at the very high or very low speeds which may be off considerably more than this. The accelerometer is easily calibrated and should give results good to $\pm .05$ g. The angular velocity recorder was frequently calibrated by placing it on a revolving table, so the results from this instrument can be relied upon to $\pm .01$ radians per second.

RESULTS.

LOOPS.

In performing a loop the elevator is pulled steadily back until the machine has reached a little more than a vertical position, and then it is held clear back until the machine has passed slightly over the top of the loop. From this point it is gradually eased forward until the maneuver is completed. The rudder and ailerons are used slightly at the top of the loop. (See Fig. 6.)

The air speed which is approximately 90 miles an hour at the beginning of the loop lags behind the movement of the elevator by nearly 2 seconds; gradually decreases to a minimum of about 25 miles per hour at the top of the loop, then increases rapidly again to 90 miles an hour at the end.

The sum of linear acceleration and gravity, which is, of course, 1 g. up to the time the elevator is moved, increases steadily to slightly over 3 g. when the machine has nosed up approximately 50° . After this the loading falls quite rapidly to a minimum of 0 g. when the machine has rotated

through 180°. After this, however, it increases to a maximum of 2.5 g. when the machine has completed an angle of about 320°; then it falls off to normal values at the end of the maneuver. The angular velocity begins to increase quite rapidly as soon as the elevator is moved, reaching a nearly steady value when the machine has rotated through approximately 45°. This steady value with slight fluctuations continues until the machine has reached about 270° and then it falls rather rapidly to 0 at the end of the maneuver. The angular acceleration is quite irregular due to small bumps in the curve, but is constant at about 0.20 radians per (second)² during the first 45° of a loop, then is approximately 0 until 270°, where it then has a nearly constant negative value of 0.20 radians per (second)² for the remainder of the loop. The curve of angular displacement starts in rather slowly, then remains a straight line until nearly the end of the maneuver, where its slope decreases gradually to 0.

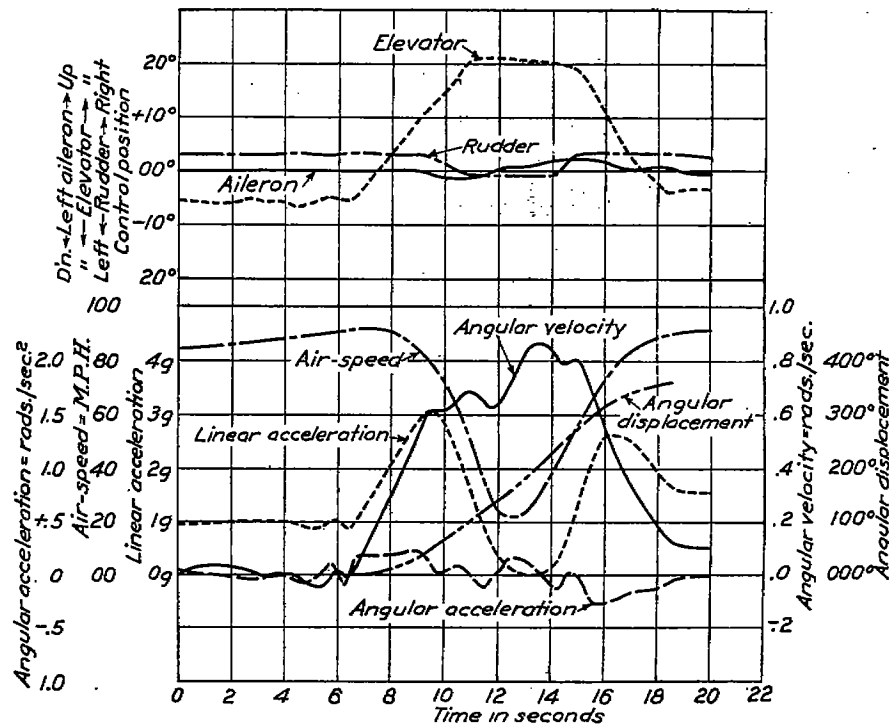

FIG. 6.—Loop. Angular velocity about Y axis.

FLATTENING OUT OF A DRIVE.

In this maneuver the machine was held steadily at 80 miles an hour with the throttle fairly well closed; then the elevator was pulled back as sharply as possible and the machine allowed to start into a loop, but when nearly 90° of rotation had been reached the machine was rolled out. (See Fig. 7.) The elevator curve shows that this member was pulled back to the full extent in approximately .02 of a second and was held way back until the machine had rotated through more than 90°. The aileron and rudder curves show no changes until the machine is rolled out at the end of the maneuver. The air speed lags behind the movement of the elevator by considerably over 1 second, decreasing from 80 miles an hour to 40 miles an hour when the machine has rotated through 90° and then increases again as the machine is rolled out. Immediately after the elevator is pulled back the linear acceleration increases rapidly to about 2.9 g., decreasing again to a minimum of about .03 g. at a little over 90° rotation of the machine. The angular velocity increases very rapidly as soon as the elevator starts to move, reaching a maximum of .84 radians per second when the machine has rotated through only 30°. After this it falls very rapidly to a minimum of nearly 0 and then rises again to a

second maximum. The angular acceleration reaches the high value of 1.40 radians per (second)² when the machine is rotated through only 10°, after which it falls suddenly to nearly zero value or the rest of the maneuver.

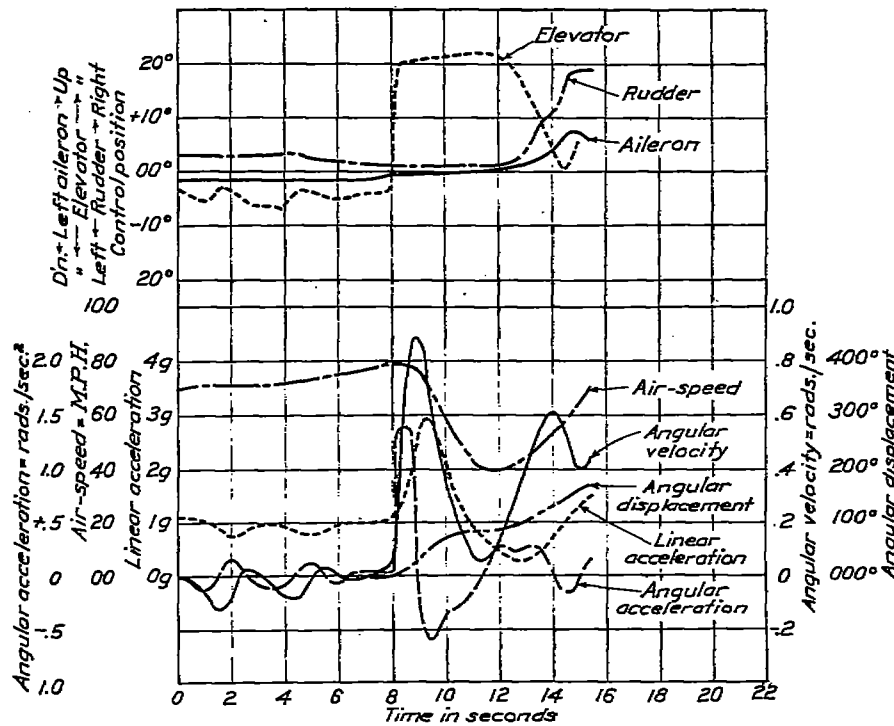

FIG. 7.—Sudden flattening out of a dive. Angular velocity about Y axis.

TAIL SPIN.

In this maneuver the elevator was pulled hard back and held in this position for the whole of the spin. The rudder was kicked hard over to the right at the beginning and held there, while the ailerons were held a few degrees to the right. (See Figs. 8 and 9.) The air speed, which was 60 miles an hour at the beginning of the record, fell to about 40 just before the spin began, then increased to about 80 miles an hour, which was maintained until the end of the spin, where it rose to over 90 miles an hour in the resultant dive. The linear acceleration increased as soon as the spin began from 1 to about 3 g. and kept at this value for the full spin. The angular velocity about the Y axis increased at the beginning of the spin to a maximum of .80 radians per second and then decreased during the spin to the small value of .20 radians per second, but increased again at the end of the spin due to pulling out of the resultant dive. The angular velocity about the X axis, however, was quite different. This value began to increase as soon as the controls were moved and rose with increasing rapidity to a maximum of 2.43, when the machine had made approximately 1 complete turn, after which it maintained a value which was nearly constant, but which showed a regular variation corresponding to the oscillation in the acceleration curve, until the spin was stopped with the controls, where it fell suddenly to a zero value after the machine had made approximately 4½ complete turns. The angular acceleration about the Y axis shows no considerable magnitude during the spin itself, but when stopping the spin a maximum of 1.1 radians per (second)² is reached. The angular acceleration about the X axis has, of course, a high positive value at the beginning of the spin, which amounts to 1.2 radians per (second)², and at the end of the spin it has a negative value of 2.1. It is necessary to make two complete runs for the spin in order to obtain the angular velocity about the X and Y axes. It will be observed from the curves how nearly alike the two maneuvers were carried out both in regard to the movement of the controls and to the performance of the machine itself.

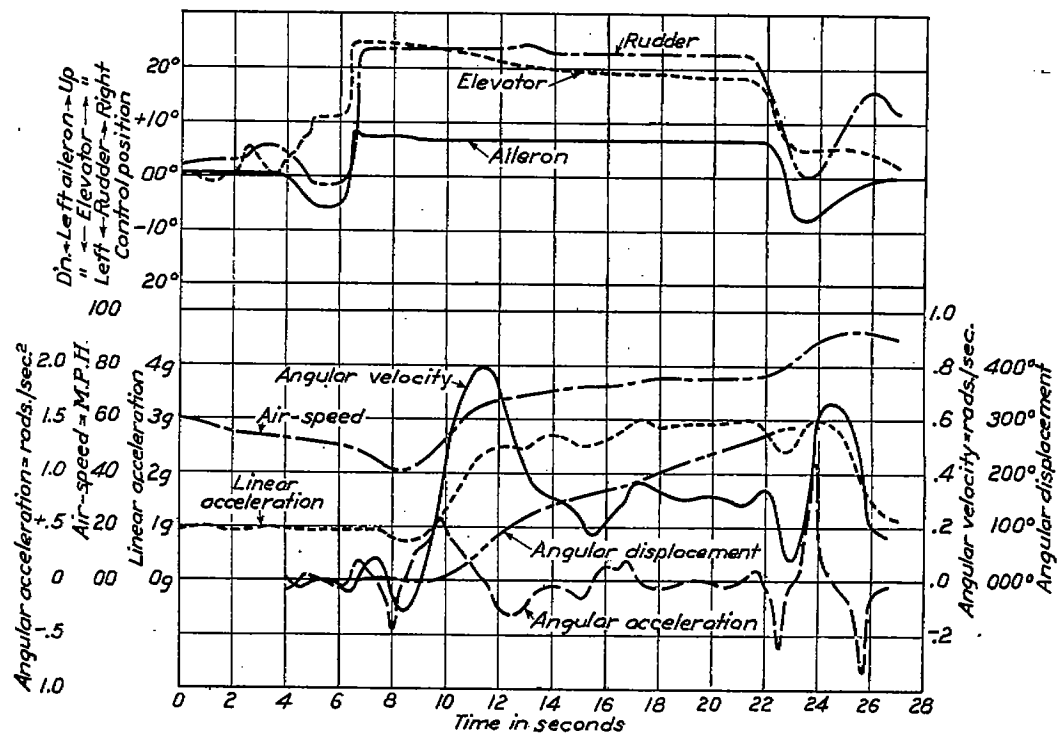

Fig. 8.—Tail spin to the right. Angular velocity about Y axis.

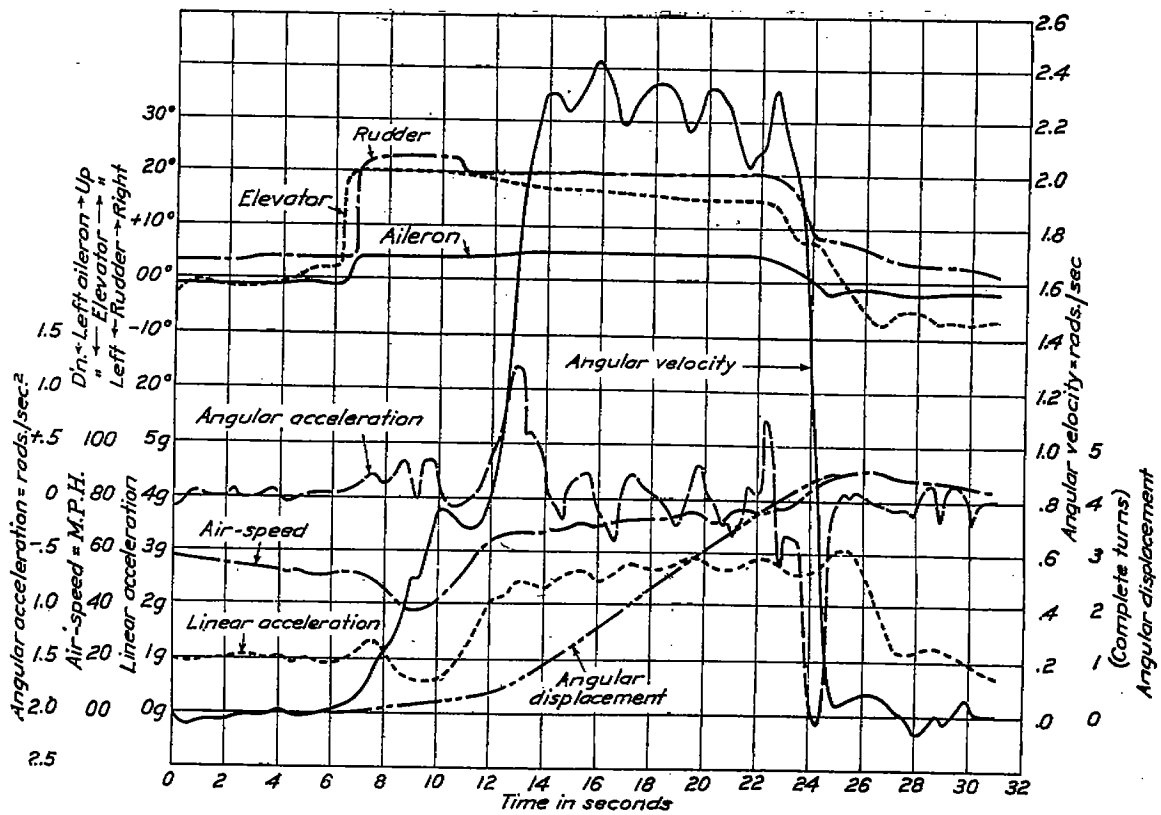

Fig. 9.—Tail spin to the right. Angular velocity about X axis.

A STUDY OF AIRPLANE MANEUVERS.

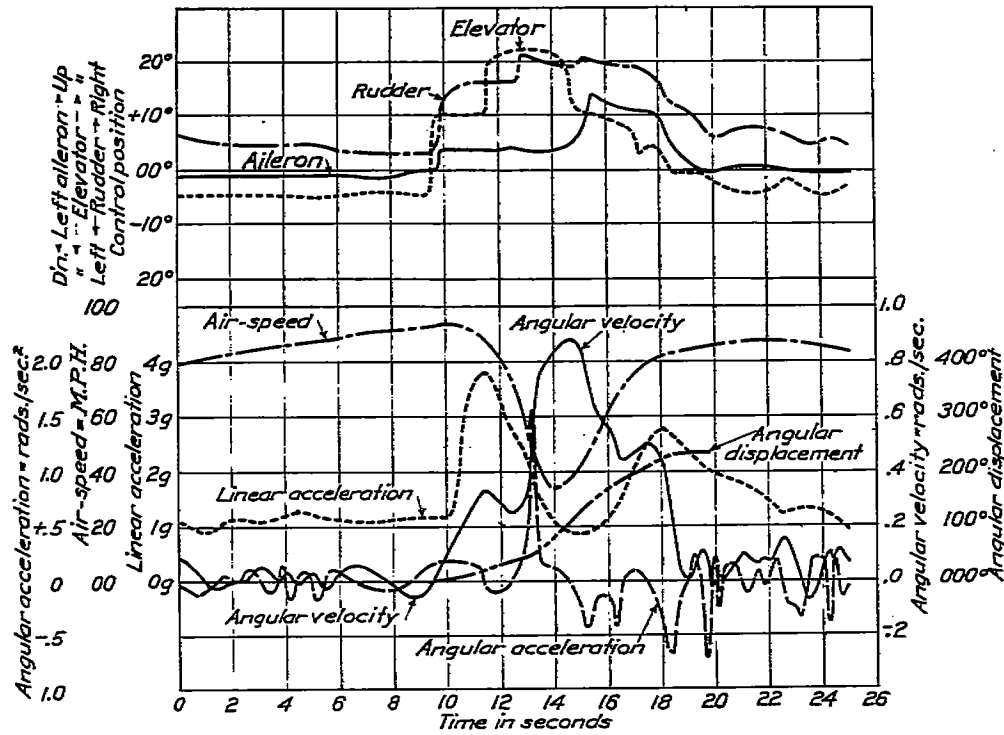

FIG. 10.—Barrel roll to right. Angular velocity about X axis.

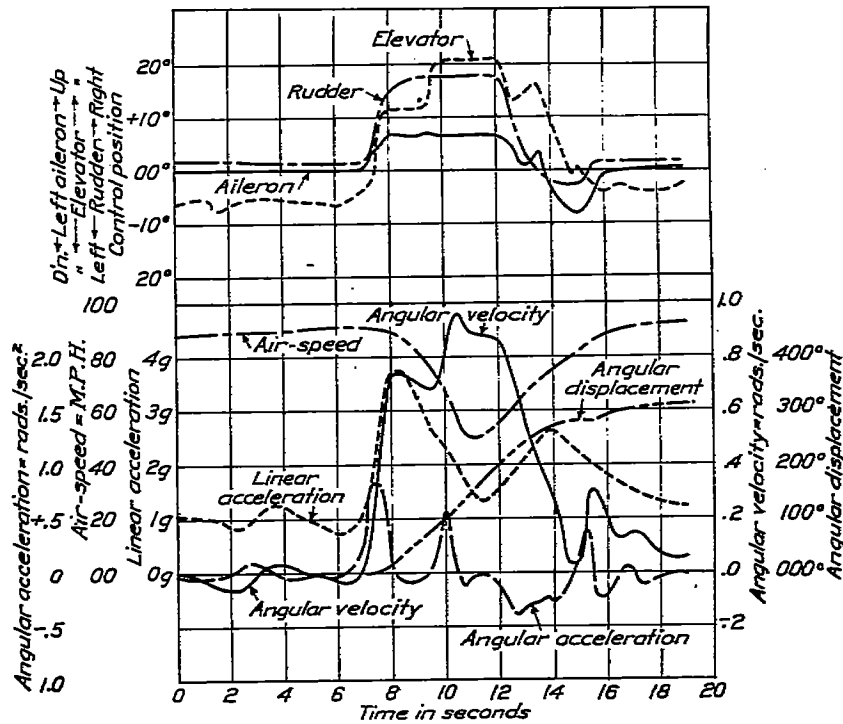

FIG. 11.—Barrel roll to right. Angular velocity about Y axis.

BARREL ROLL.

In this maneuver the elevator is moved back to about 10° and held there for about 2 seconds. In the meantime the rudder is kicked hard over and is held there for nearly the full maneuver. The elevator, after the rudder has been kicked over is then pulled clear back to over 20° and held there for some time. (See Figs. 10 and 11.) It is also interesting to notice that the ailerons are scarcely used at all. It should be remembered in connection with this maneuver that this type of machine is difficult to roll smoothly and that therefore the results obtained here would not be applicable to a single seater machine which rolls with much greater smoothness. The air speed, which had a value of somewhat over 90 miles an hour at the beginning of the roll, fell rapidly to a minimum of 35 miles an hour after about 6 seconds, then rose again to about 85 miles an hour at the end. The linear acceleration rose very rapidly to a maximum of 3.7 g. after the elevator had been pulled back. It then fell to a minimum value when the machine had nearly turned over on its back, then increasing again to a second maximum value at about 220° of rotation. The angular velocity about the X axis increases quite rapidly after the controls are moved, then is nearly constant for about 1 second, then starts rapidly upward again corresponding to the point where the elevator is moved from 10° to 20°. The maximum value, which comes after the machine has rotated through about 100°, is 0.84 radians per second. After this point the curve decreases with one slight interruption to a zero value at the end of the record. The angular velocity about the Y axis increases very rapidly as soon as the controls are moved, with the same interruption at 1 second as was shown about the other axis, until a maximum value of .880 radians per second is reached at a time when the machine has rotated only 45° about the X axis. After this the angular velocity decreases rather rapidly to a zero value. The angular acceleration about the X axis reaches a very sharp maximum of 1.55 radians per (second)² when the machine has rotated about 45°. At the end of the record there are several negative peaks of about half this magnitude. The angular acceleration about the Y axis shows only small values, the highest being 0.80 radians per (second)² at the beginning of the record.

CONCLUSIONS.

The results from these tests are summarized in the following table:

TABLE I.

Maneuver.	Max. acceleration along Z axis.	Time to reach this value, in seconds.	Max. angular velocity, in rad./sec., about		Time to reach this value, in seconds.		Max. angular acceleration, in rad./sec. ² about		Time to reach this value, in seconds.	
			X axis.	Y axis.	X axis.	Y axis.	X axis.	Y axis.	X axis.	Y axis.
Loop.....	3.1 g.	2.9	0	0.88	7.1	0	-0.27	9.2
Pulling suddenly out of an 80 m. p. h. dive....	2.9	1.4	0	.88	1.0	0	1.406
Tail spin.....	3.0	13.5	2.43	.79	10.0	7.4	{ -2.10 1.20 }	.60	6.5 5.7
Barrel roll.....	3.7	2.2	.84	.96	5.0	4.5	1.55	.83	3.6 1.3

All times are measured from the instant the controls are first moved.

It will be noticed that the greatest angular velocity is 2.43 radians per second and occurs about the X axis in the tail spin. The greatest angular acceleration, 2.10 radians per (second)², occurs under the same conditions, as might be expected.

In a continuation of this work it would be of value to repeat the present tests upon various types of airplanes. It would also be of value to have instruments which would record the linear acceleration as well as the angular velocity simultaneously along three axes. Instruments to do this are now being constructed by the National Advisory Committee and will be ready to be put into the air in a few months. These two instruments in conjunction with the recording air speed meter and the recording control position instrument should give us a very complete analysis of the performance of the machine.

It may be concluded from these tests that no conventional airplane of the JN4h type can have a greater angular velocity about the X axis than 3 radians per second or about the Y axis greater than 1 radian per second; and the angular acceleration about the X axis will not exceed 2.5 radians per (second)² or about the Y axis of 2 radians per (second)².