REPORT No. 248

**THE CORROSION OF MAGNESIUM AND OF THE
MAGNESIUM ALUMINUM ALLOYS
CONTAINING MANGANESE**

By J. A. BOYER
American Magnesium Corporation

REPORT No. 248

THE CORROSION OF MAGNESIUM AND OF THE MAGNESIUM ALUMINUM ALLOYS CONTAINING MANGANESE

By J. A. BOYER¹

SUMMARY

The extensive use of magnesium and its alloys in aircraft has been seriously handicapped by the uncertainties surrounding their resistance to corrosion. This problem has been given intense study by the American Magnesium Corporation and at the request of the Subcommittee on Materials for Aircraft of the National Advisory Committee for Aeronautics, Mr. J. A. Boyer, of the American Magnesium Corporation, has prepared the following report on the corrosion of magnesium.

INTRODUCTION

Although considerable progress has been made in the development of strong magnesium alloys, the corrosion of these alloys has received very little study. For that reason the corrodibility of the metal itself has been the subject of considerable misunderstanding. Magnesium of inferior quality has often been placed on the market; this metal usually contained chloride and corroded badly when subject to even ordinary atmospheric conditions. Alloys have been prepared more or less indiscriminately from the standpoint of physical properties alone, and their rapid corrosion has been attributed to the tendency of magnesium itself to corrode rather than to the nature and proportion of the alloying ingredients.

Contrary to popular belief, pure magnesium is quite resistant to corrosion. However, the physical properties of the pure metal make it unfit for most structural purposes, and the alloys having desirable physical properties are usually not resistant to corrosion. The present investigation deals with the development of a resistant magnesium alloy by a variation in composition.

The natural alloying element for magnesium is aluminum. The latter, like magnesium, has a very low density and the addition required does not cause any appreciable increase in the density of the alloy over that of the pure metal. Aluminum is soluble in solid magnesium up to at least 10 per cent at the eutectic temperature, and the alloys may be subject to heat treatment and artificial aging. An exhaustive survey of the alloy field has not shown any alloying ingredient as satisfactory from the physical standpoint as aluminum, and for that reason the study of corrosion has been chiefly confined to the magnesium-aluminum series. The corrosion resistance of these alloys has been increased approximately 50 times without any sacrifice in physical properties.

Preliminary corrosion tests showed that the addition of small amounts of manganese greatly increased the resistance to corrosion of the magnesium alloys containing aluminum. It was known that the higher aluminum alloys corroded rapidly, supposedly owing to the presence of undissolved aluminum constituent. The results with the addition of manganese were very hard to duplicate, and occasionally two alloys of practically the same analysis would show very different corrosive properties. A study was undertaken to investigate the function of manganese in preventing corrosion, and to determine if possible the reason for the frequently anomalous results. The work was carried out along two different lines: Microscopic and metallographic examination, and potential measurements.

¹ Chief chemist, American Magnesium Corporation.

GENERAL NATURE OF CORROSIVE ACTION

It is generally accepted that the corrosion of metals in salt solutions is due to a displacement of hydrogen from the water. The less reactive metals do not have a high enough solution potential to displace hydrogen as a gas on the surface of the metal and the film of hydrogen formed must be removed by oxidation with atmospheric oxygen before further solution can take place. For this reason the corrosion of iron and steel in neutral solutions depends almost entirely on the amount of atmospheric oxygen which reaches the metal surface per unit time. If oxygen is excluded, corrosion practically ceases. In the case of magnesium, however, the solution potential is sufficiently high to displace hydrogen as a gas, so that corrosion takes place continuously and is practically independent of oxygen diffusion. As the latter is a comparatively slow process, the rate of corrosion in salt solutions increases enormously when the diffusion of oxygen ceases to be the controlling factor, and rapid corrosion continues until stopped by the formation of a film of corrosion product.

The corrosion of magnesium by immersion in salt solutions is a much more accelerated test than is the case with any other metal, owing to this direct displacement of hydrogen. Thus an alloy containing 4 per cent aluminum, while as resistant as iron when subjected to atmospheric corrosion or weathering, will be completely disintegrated by salt water in four or five days unless some alloying ingredient is added to inhibit corrosion. In comparison, an alloy which remains intact when immersed in salt water for a period of one or two weeks would be considered quite resistant. Specimens of such an alloy have been subjected to very severe atmospheric conditions, including exposure to both rain and acid fumes for a period of a year, and the results are comparable to that shown by the aluminum-base alloys in common use.

COMPARATIVE CORROSION RATE OF PURE METAL AND THE MAGNESIUM-ALUMINUM ALLOYS

Corrosion tests of more than 50 specimens of magnesium ingot taken at random from stock have shown that pure magnesium is quite resistant to corrosion. Machined specimens immersed in salt solutions of various concentrations for a period of two months remained intact and usually showed very little pitting. Four pieces of magnesium after two months' immersion in salt solution are shown in Figure 1. The specimens were acid cleaned after removal from the corroding medium.

With the addition of aluminum to magnesium the rate of corrosion increases enormously. A 4 per cent alloy of even half-inch thickness will be completely disintegrated in less than a week; the 8 per cent alloy corrodes even more rapidly. The effect of aluminum on corrosion is shown in Figure 2, which represents the result of a 48-hour intermittent immersion test, using 2 per cent sodium chloride solution.

The test pieces were $3 \times 1\frac{1}{8}$ inches $\times \frac{3}{16}$ inch and weighed approximately 20 grams. They were not cleaned except to be rubbed down with a dry cloth, and the surface was that of ordinary extruded metal.

The loss in weight of each specimen after completion of the test is given in the following table:

Alloy	Loss in weight
<i>Per cent Al</i>	<i>Grams</i>
2.....	2.8
3.....	6.7
4.....	10.9
5.....	9.7
6.....	11.2
8.....	16.3

As this loss in weight occurred in only 48 hours, the accelerated nature of the intermittent immersion test is evident.

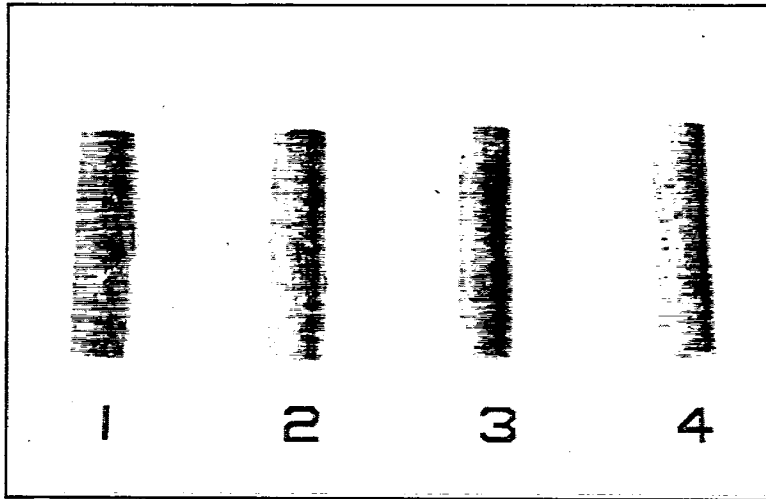

FIG. 1.—Machined pieces of magnesium after two months' immersion in salt solution. Specimens 1 and 2 immersed in 2 per cent NaCl solution. Specimens 3 and 4 immersed in 10 per cent NaCl solution



FIG. 2.—From left to right, 2, 3, 4, 5, 6, and 8 per cent aluminum, intermittent immersion, 2 per cent NaCl solution, 48 hours

INHIBITING EFFECT OF SMALL AMOUNTS OF MANGANESE

Quantitative data were next obtained on the effect of manganese in preventing the corrosion of the aluminum alloys. Seven alloys were specially prepared using different qualities of raw material. The composition of the alloys is given below:

COMPOSITION OF CORROSION ALLOYS

Alloy	Composition		Raw materials and preparation
No.	Al	Mn	
1.....	4.46	99.98 per cent aluminum, 99.99 per cent Mg, melted under argon.
2.....	4.39	Same as No. 1.
3.....	4.11	Commercial aluminum, 99.85 per cent Mg, air cast (chill).
4.....	4.61	0.29	99.98 per cent aluminum, 99.99 per cent Mg, specially pure Mn-Mg alloy, melted under argon.
5.....	4.48	.29	Commercial manganese-aluminum alloy, 99.99 per cent Mg, melted under argon.
6.....	4.23	.27	Same as No. 4.
7.....	3.82	.22	Commercial manganese-aluminum alloy, 99.99 per cent Mg, air cast (chill).

The test specimens were of the same dimensions as in the previous test, 3 x 1 1/8 inches x 3/16 inch. They were cleaned by rubbing down with a dry cloth and subjected to the 48-hour intermittent immersion test, using 2 per cent sodium chloride solution. Duplicate tests were run; the specimens were scoured with a stiff brush after removal from the corroding medium, and were cleaned by dipping in 10 per cent nitric acid for 20 seconds. There was some unavoidable loss in weight due to acid cleaning, but the loss was small and the results are more accurate than if the specimens had been weighed before cleaning. The loss in weight of the corroded specimens is given in the following table. As the test pieces were all of the same size, the loss was not reduced to grams per unit area.

LOSS IN WEIGHT OF CORRODED SPECIMENS

Alloy	Approximate composition	Loss in weight	
		Test No. 1	Test No. 2
1.....	4 per cent Al.....	8.	7.5
2.....	4 per cent Al.....	10.9	10.1
3.....	4 per cent Al.....	6.4	5.4
4.....	4 per cent Al 0.3 per cent Mn.....	.3	.4
5.....	4 per cent Al 0.3 per cent Mn.....	.4	.4
6.....	4 per cent Al 0.3 per cent Mn.....	.5	.5
7.....	4 per cent Al 0.3 per cent Mn (air cast).....	5.4	3.9

It will be observed that the loss in weight of the aluminum alloys containing no manganese is from 20 to 30 times as great as with specimens 4, 5, and 6, which contain approximately three-tenths per cent manganese. The abnormal loss of the air cast specimen presented a problem for further investigation.

A more striking illustration of the effect of manganese on the corrosion of the magnesium-aluminum alloys is shown in specimens 8 and 9 of Figure 4. The former is a 4 per cent aluminum alloy containing three-tenths per cent manganese, which has been immersed in a 10 per cent salt solution for four days. The specimen is scarcely pitted. Specimen No. 9 of the same composition except for the manganese, and immersed in the same strength salt solution for the same length of time, is almost completely disintegrated.

METALLOGRAPHIC STUDY OF CORROSION

The rapid corrosion of magnesium alloys in comparison with pure metal is usually explained by the assumption that the undissolved constituents in the alloy act as cathodic elements of a galvanic couple, and corrosion is caused by the difference in potential thus established. If the magnesium-aluminum alloys corrode rapidly, owing to the introduction of undissolved constituents, and if manganese almost completely counteracts this accelerated corrosion, it would be reasonable to assume that manganese might bring about some change in the microstructure of the alloy. It is generally believed that pitting of the more reactive metals is associated with the presence or segregation of some impurity, although this is not the case in the oxygen diffusion



FIG. 3.—Specimens from left to right are numbers 1 to 7 of preceding table

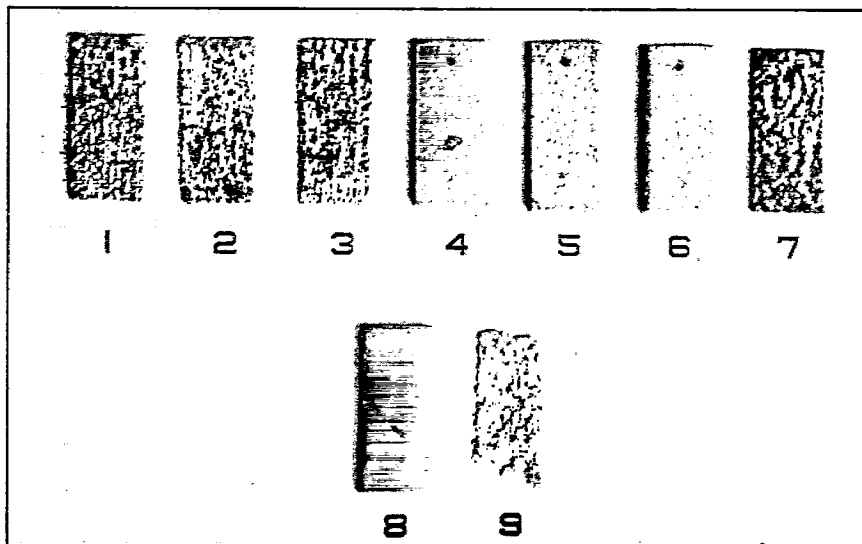

FIG. 4.—Specimens 1-7, same test as in Figure 3. Specimen 8, 4 per cent Al, 3 per cent Mn, and 9, 4 per cent Al in 10 per cent salt solution four days

type of corrosion. A metallographic examination was made of a large number of corroded specimens, with the twofold purpose of establishing a relation between the corrodibility of the alloy and the constituents present, and also to determine the relation, if any, between pitting and the segregation of impurities. The results showed that the rate of corrosion was practically independent of the microstructure of the alloy as revealed by ordinary methods of polishing and etching.

Figure 5 shows the microstructure of an alloy which was comparatively resistant to corrosion. A considerable quantity of magnesium silicide was present and also a large number of small hard particles not definitely identified. These hard particles are usually present in the aluminum alloys and are believed to be due to iron.

Figure 6 shows the structure of an alloy which corroded rapidly and was completely disintegrated by salt water. It is more nearly homogeneous than the resistant alloy shown in Figure 5. The same hard particles are present but no appreciable amount of silicide was observed.

Silicide was not responsible for the inhibitive effect, as alloys having a microstructure almost identical with Figure 6 were also quite resistant.

These examples are typical of all the specimens examined. No segregation of impurities was observed either in or near the pits, and no cause of either general or localized corrosion was evident.

EXAMINATION OF POLISHED SPECIMENS DURING THE PROCESS OF CORROSION

As the corrosion of magnesium in the initial stage is very rapid, it is possible with the aid of the microscope to observe the actual progress of the corrosive attack while the specimen is immersed in salt water.

The microscope used for these experiments was the ordinary biological microscope, fitted with a vertical illuminator and a 16-mm. objective. The latter was kept just above the surface of the liquid. Much better resolution and brilliancy were obtained with a low-power objective than with a higher power objective immersed in the solution.

The first alloys examined were those containing aluminum but no manganese; examination was then made of the alloys containing both manganese and aluminum. The alloys containing from 3 to 4 per cent aluminum usually consist of a homogeneous solid solution. When a polished specimen of such an alloy is immersed in salt water the surface becomes tarnished almost immediately. Under the microscope this tarnish is light brown, and the usual appearance is shown in Figure 7. It will be noted that the tarnish does not completely cover the entire surface of the metal, but there is a network of light areas which are practically unaffected. That the pattern produced is due to an attack which dissolves the metal surface is shown by the fact that scratches and other imperfections which are smoothed over on final polishing are quickly revealed by the action of salt water. It appears that the slightly flowed surface due to the final polish is eaten off.

A casual observation of the tarnish pattern might not indicate any relation between tarnish and the structure of the metal. However, when alloys solidified under conditions favorable to the growth of dendrites were polished and immersed in salt water, it was found that the tarnish pattern was almost entirely dendritic. The brown areas corresponded to the primary magnesium-rich cores or dendrites, and the lighter areas were presumably richer in aluminum. In practically every case where a particle of undissolved aluminum constituent was observed, it was located in the lighter areas.

Hydrogen was liberated simultaneously with the development of the tarnish pattern. The first bubbles were quite large and were scattered irregularly over the surface; on removal by shaking they did not tend to form again in the same place. However, there were very small points scattered over the alloy from which a very fine stream of hydrogen bubbles came continuously. These points apparently acted as cathodes, as the magnesium immediately surrounding the point from which gas was evolved was unattacked. It was difficult to determine the nature of these cathode areas or particles, both because of the stream of bubbles coming

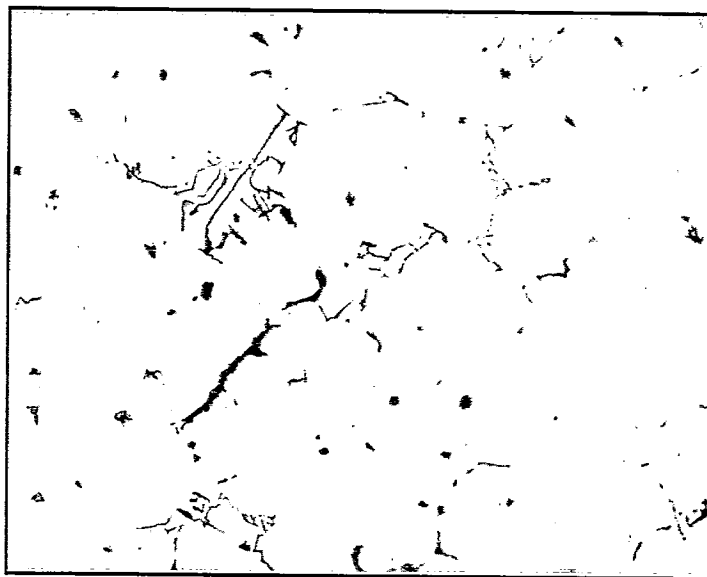

FIG. 5.—Mag. 100 X. Microstructure of an alloy fairly resistant to corrosion

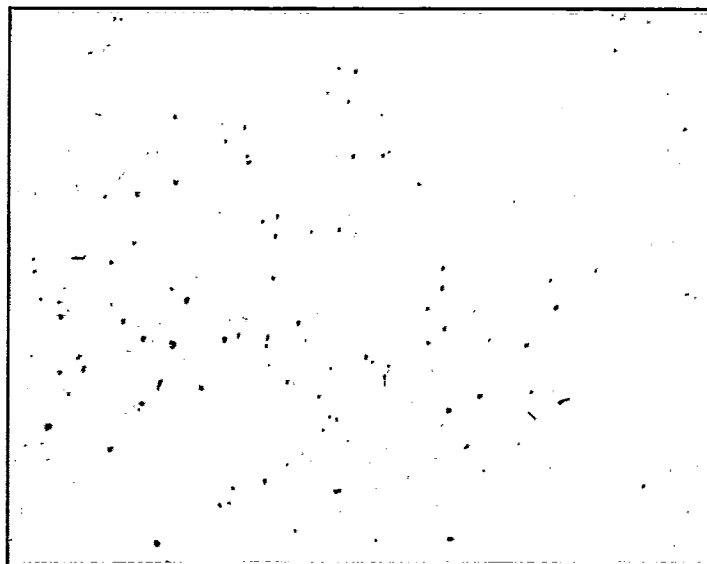

FIG. 6.—Mag. 100 X. Microstructure of an alloy which was completely disintegrated in a few days

from the point in question and because of the limit of magnification imposed by the fact that the specimen was immersed in salt water. If they were metallic constituents they were very small—much smaller than either the aluminum or silicide particles normally observed in the same alloy.

The microstructure of the alloys varied between that shown in Figure 5 and that of Figure 6. Silicide and aluminum constituents were present, usually in small amounts, and under the microscope these constituents were found to be absolutely inactive. The hard particles in Figure 6 which were scattered through the alloys were also inactive unless the cathode areas might possibly be an occasional one of these particles. However, if such was the case it is estimated that not more than one out of fifty or a hundred were active. During the examination of these alloys literally thousands of these particles have been observed from which no hydrogen was liberated.

When pitting commenced the pits followed the tarnish pattern and the magnesium-rich dendrites were eaten out. As the attack advanced along the surface of the tarnished dendrite a stream of hydrogen bubbles always came from the part being dissolved, and the hydrogen liberated from the direct attack of the dendrite was greater than that coming from the cathode areas. The way in which pitting follows the tarnished areas is shown in Figure 8. In the upper left-hand corner of this micrograph may be seen a hexagonal or six-pointed star; at the extreme right a similar figure is observed in which five of the points are eaten out and the sixth (pointing toward the center of the micrograph) is tarnished. These star-shaped corrosion patterns are characteristic in the alloys showing dendritic corrosion pits.

Figure 9 shows an almost perfect dendrite in a specimen which has been repolished to remove the tarnish pattern. The polishing was then carried further to see if any constituent would be found at the bottom of the pits from which hydrogen could be liberated, but none was found. A typical area is shown in Figure 10. During the eating out of the magnesium-rich dendrites both silicide and aluminum constituents were inactive, as had been previously observed in the formation of the tarnish pattern.

There was little doubt that the dendrites developed both by tarnish and by pitting were those of primary magnesium or, rather, magnesium-rich solid solution. Six-pointed stars are characteristic of both hexagonal and trigonal crystal systems, and are observed in substances known to be hexagonal. There was evidently a connection between the large number of six-pointed corrosion pits and the hexagonal crystal structure of magnesium.

The form of the primary magnesium dendrite is shown in Figure 11. Here the dendrite is surrounded by eutectic and two constituents are present in the alloy. In the solid solution alloys the aluminum is dissolved, but there is sufficient difference in composition between the magnesium-rich dendrites which solidify first and the remaining interstitial material which fills in between them for the cores to be first tarnished and then eaten out when the specimen is immersed in salt water. The hydrogen comes from the dendrite as if it were being dissolved by direct attack. A comparison of the tarnish pattern and corrosion pit in Figures 13 and 14 with the primary dendrite in Figure 11 will make evident the relation between coring and corrosion.

EFFECT OF UNDISSOLVED CONSTITUENTS ON CORROSION

The alloys examined in the preceding sections were practically homogeneous except for minor impurities and small amounts of undissolved constituents. Alloys having a more heterogeneous structure were next prepared to determine if any relation existed between segregation of undissolved constituents and pitting. The typical microstructure of such an alloy is shown in Figure 15. The cored magnesium-rich dendrites similar to the corrosion pits could be brought out by deep etching, as shown in Figure 16.

When these alloys were examined while immersed in salt water the type of corrosion was found to be identical with the purer magnesium-aluminum alloys containing only one constituent. There were numerous cathode areas, but the magnesium-rich dendrites were eaten out as before and the attack was practically independent of the distribution of undissolved constituents. This is shown in Figures 17 and 20. All specimens did not show perfectly formed dendrites, but there was usually a similarity between the form of the corrosion pit and that of primary magnesium, as illustrated in Figures 19 and 20.

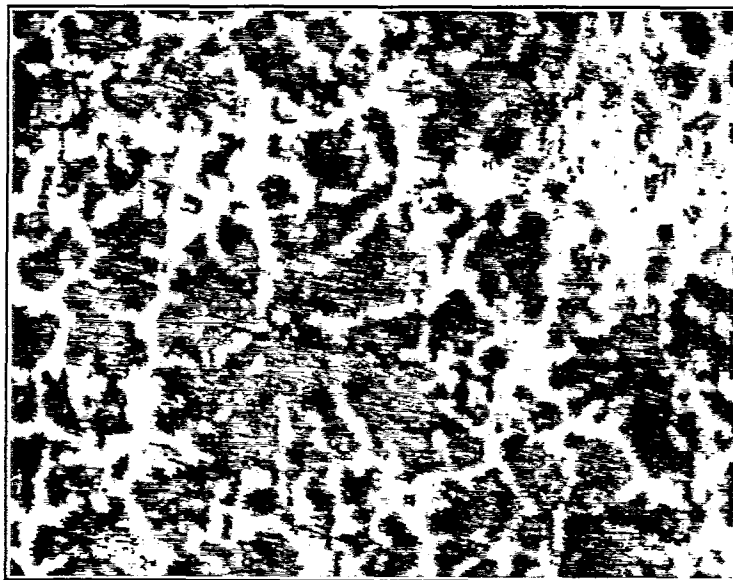

FIG. 7.—Mag. 100 X. Tarnish pattern on polished surface of magnesium-aluminum alloy after immersion in salt water



FIG. 8.—Mag. 100 X. Showing how corrosion pits follow the tarnish pattern. Note the two hexagonal stars, upper left corner and right center



FIG. 9.—Mag. 100 X. Dendritic corrosion pits in magnesium-aluminum alloy after repolishing



FIG. 10.—Mag. 100 X. Bottom of corrosion pits in a 3 per cent aluminum alloy showing the absence of undissolved constituent or segregated impurity

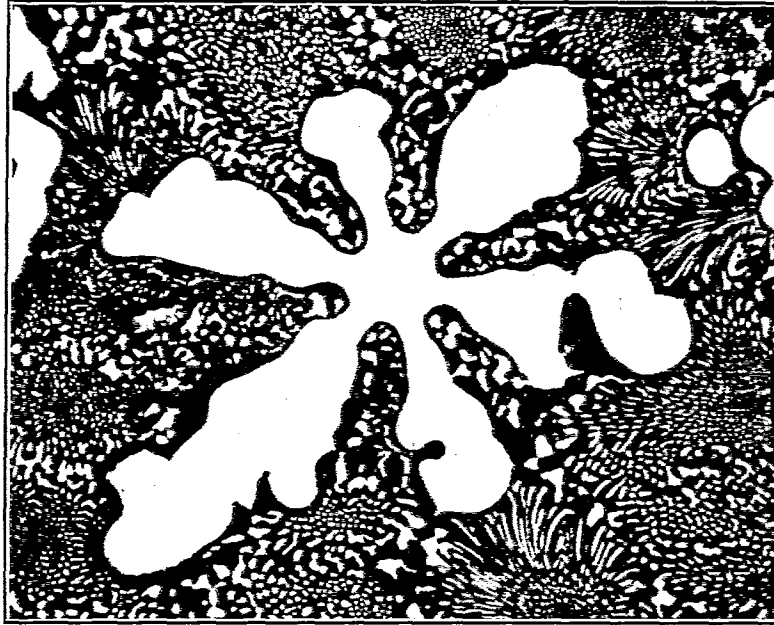

FIG. 11.—Mag. 100 X. Primary magnesium dendrite in an alloy containing 30 per cent aluminum

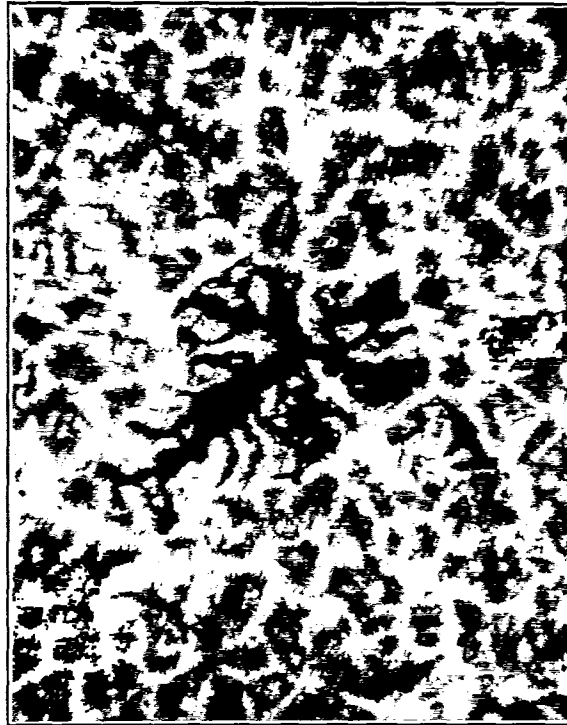

FIG. 12.—Mag. 75 X. Corrosion pit in 3 per cent aluminum alloy



FIG. 13.—Mag. 100 X. Tarnish pattern on polished surface of solid solution alloy (3 per cent aluminum) after immersion in salt water. Compare with Figure 11



FIG. 14.—Mag. 100 X. Corrosion pit in the alloy in Figure 13



FIG. 15.—Mag. 200 X. Microstructure of an alloy containing 5 per cent aluminum, 0.3 per cent silicon, balance magnesium

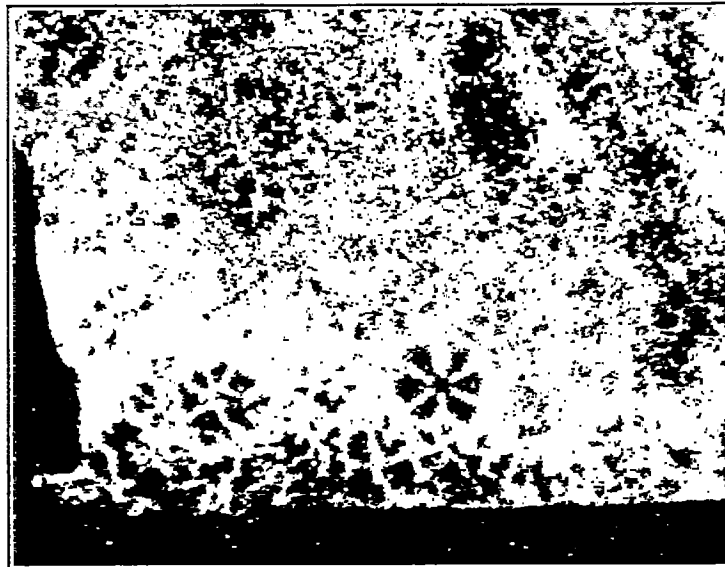

FIG. 16.—Mag. 50 X. Cored magnesium-rich dendrite in same alloy as Figure 17, brought out by deep etching

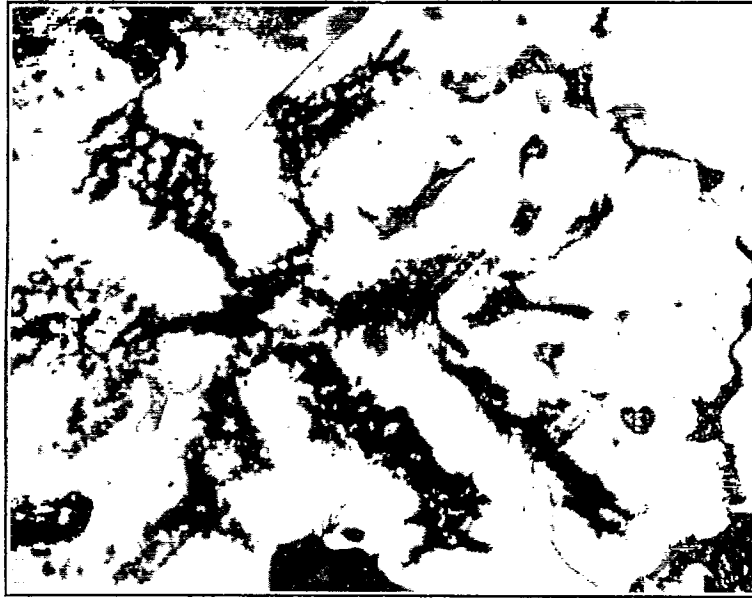

FIG. 17.—Mag. 200 X. Corrosion pit in the alloy containing 5 per cent aluminum and 0.3 per cent silicon. The cored magnesium-rich dendrite was eaten out, while both the silicide and aluminum constituents remained inactive

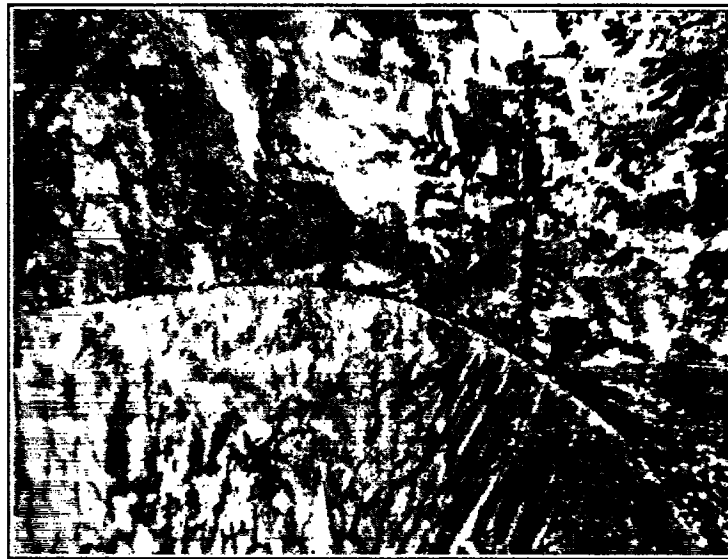

FIG. 18.—Mag. 50 X. Primary dendrite of magnesium in an alloy containing 3 per cent silicon. Note the identical form with corrosion pit of Figure 17

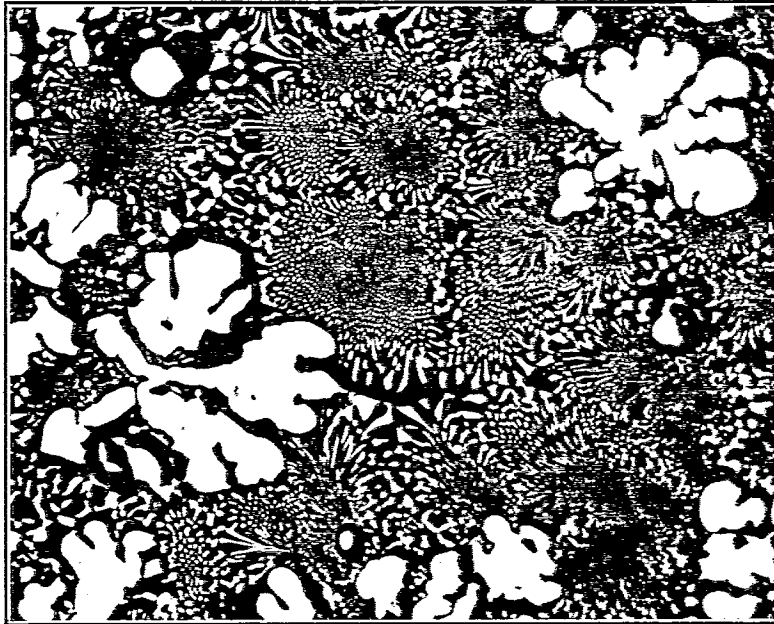

FIG. 19.—Mag. 100 X. Primary magnesium in an alloy containing 30 per cent aluminum

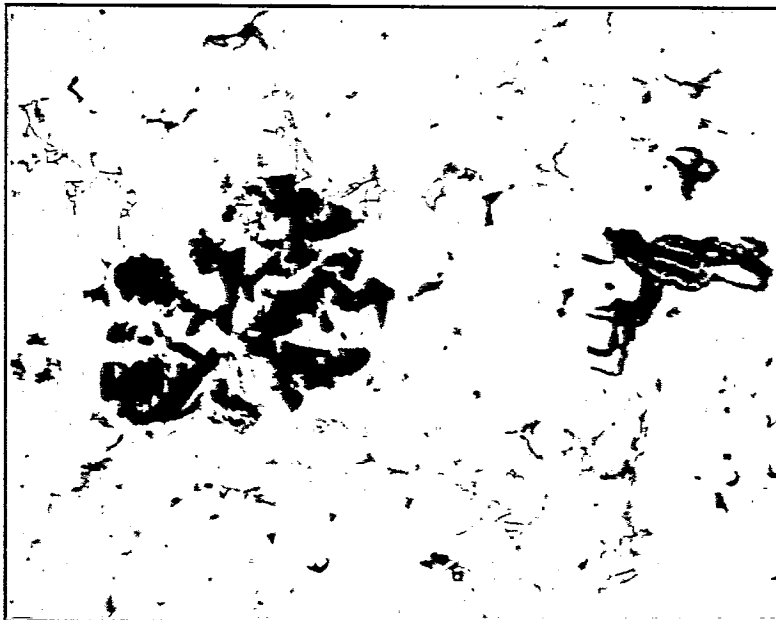

FIG. 20.—Mag. 100 X. Corrosion pits in an alloy containing 5 per cent aluminum and 0.3 per cent silicon, showing that corrosion attack is independent of the distribution of undissolved constituents and also similarity in form of pits to primary magnesium, Figure 19

THE CORROSION OF EXTRUDED METAL

The corrosion attack on the polished surface of extruded metal furnished additional evidence that the initial pitting bore a definite relation to the structure of the metal. The nature of the attack was almost identical with that of the cast alloys; the hydrogen came from the pits as they were being eaten out, and it was possible to observe the stream of hydrogen bubbles advance along the surface of the metal as the attack progressed. The amount of hydrogen liberated from the small cathode areas or particles was small in comparison.

In the longitudinal section the corrosion pits were all straight lines parallel to the direction of extrusion, as shown in Figure 21. The corrosion attack of the transverse section was irregular and did not have a directional tendency. The cored areas were presumably drawn out into a more or less fibrous structure and their original dendritic form was lost.

PROOF OF THE RELATION BETWEEN CORING AND CORROSION

After the metallographic study of corrosion had been practically completed, an etch was found which developed the cored structure of the alloys by tarnishing rather than by deep etching. In this way it was possible to bring out even the finer details of the cored dendrites. In a number of cases the etch was so sharp that the cores had the appearance of a second constituent, but this was rendered improbable by their disappearance on prolonged annealing. The size of the magnesium-rich areas depended to a considerable extent on the time of etching and the strength of the acid used, which would not be the case if the cores were a second constituent. Furthermore, the form of the cored dendrites was identical with that of the magnesium dendrites in the higher alloys containing eutectic.

When the specimens which had been corroded in salt water and then repolished to remove the tarnish film were etched to bring out the cored structure it was found that the corrosion pits were superimposed on the magnesium-rich cores, as shown in Figure 24.

The tarnish pattern brought out by the action of salt water showed that manganese did not change the dendritic structure of the magnesium-aluminum alloys (fig. 25). The type of corrosion was similar to that of the binary alloys without manganese, except that the tarnished dendrites did not have as great a tendency to be eaten out. The cored structure would also be developed by etching, as shown in Figure 26.

COMPARISON OF THE CORROSION OF CHILL-CAST AND SAND-CAST SPECIMENS

The metallographic study up to this point had established a definite relation between coring and the corrosion attack by salt water. It was not known whether coring actually caused corrosion by the establishment of differences in potential between the various parts of the alloy or whether the magnesium-rich dendrites were preferentially attacked merely because of their higher solution potential. The presence of manganese was necessary to keep the dendrites from being eaten out, and it was proposed to examine a chill cast aluminum alloy containing manganese which was not resistant to salt water, to determine if coring were the cause of its lack of resistance. If so, suitable heat treatment to eliminate differential composition should produce a favorable change in corrosive properties.

The alloy chosen was specimen No. 7 of the corrosion test shown in Figures 3 and 4. This alloy differed from the three resistant test specimens by being chill cast while the others were cooled fairly slowly; it was also air cast and contained included films, while the resistant alloys were vacuum cast; in addition, it was slightly low in manganese. It was believed that the examination to determine whether coring was the cause of corrosion would also determine the influence of the other two factors by a process of elimination.

On polishing a cross-section of half the ingot, it was found that chill casting had a marked effect on the distribution of the corrosion attack. The corroded specimen is shown in Figure 27. The specimen is slightly reduced in size and is shown by oblique illumination; the corroded areas appear light and the polished surface dark. The area around the chilled edge is corroded almost uniformly to an extent of about half an inch; the cut edge, which shows as a heavy



FIG. 21.—Mag. 100 X. Corrosion pits in alloy containing 4 per cent Al, 0.2 per cent Mn, extruded, longitudinal section. The cores have been drawn out into a fibrous structure

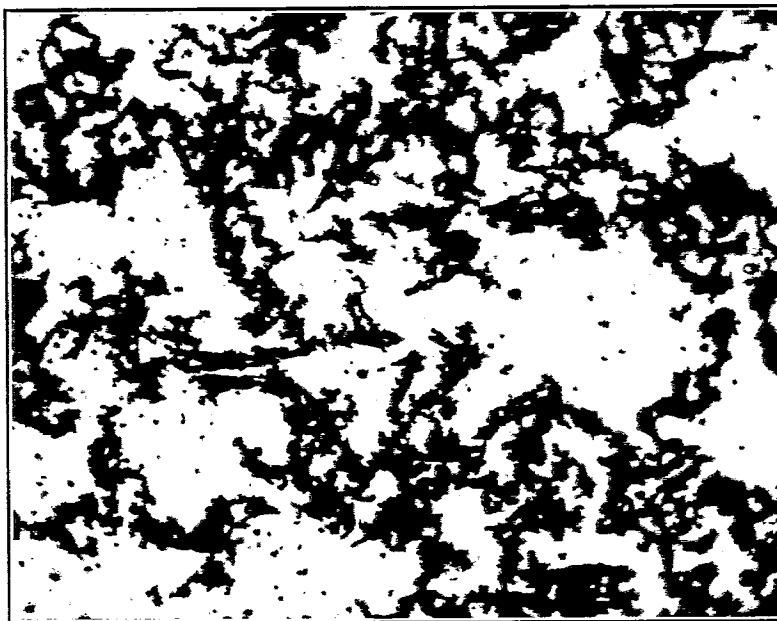

FIG. 22.—Corrosion pits in transverse section of extruded alloy. Note the absence of a directional tendency



FIG. 23.—Mag 100 X. Cored dendrite in 3 per cent aluminum alloy

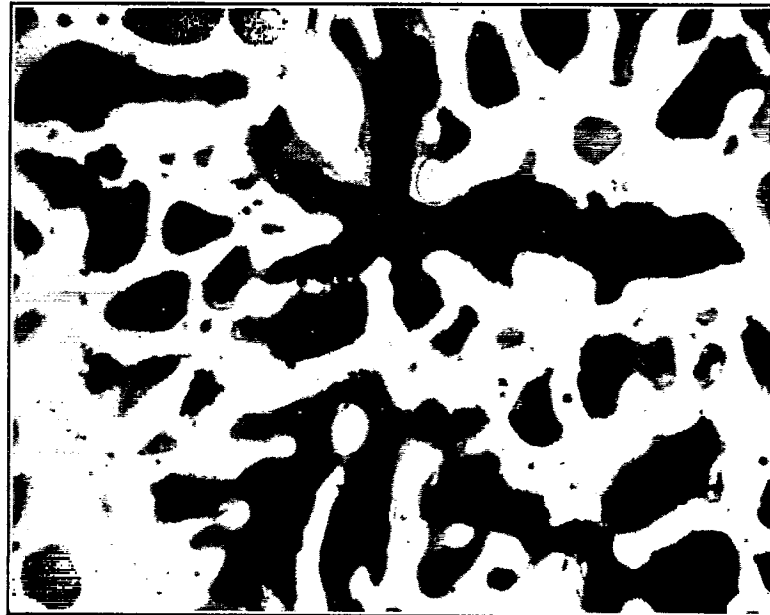

FIG. 24.—Mag. 100 X. Corrosion pits in the alloy of Figure 23. Specimen was repolished and etched after corrosion. Corrosion pits black; cored dendrites halftone



FIG. 25.—Mag. 100 X. Tarnish pattern of magnesium-aluminum alloy containing 0.3 per cent manganese



FIG. 26.—Mag. 100 X. Cored structure of magnesium-aluminum alloy containing 0.3 per cent manganese

white line because it catches the oblique illumination, is not pitted at all. Here again is a reproduction on a large scale of the corrosion attack observed microscopically; the first part of the alloy to solidify, in one case the chilled edge and in the other case the cored dendrite, is attacked preferentially and this attack is practically independent of the distribution of metallic constituents or nonmetallic inclusions. A sand-cast specimen, corroded at the same time for comparison, was uniformly pitted (fig. 29).

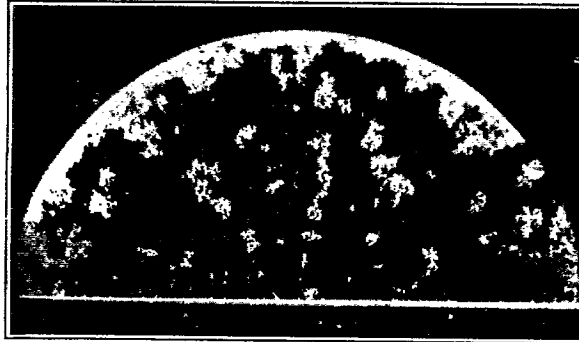

FIG. 27.—Corrosion of chill cast magnesium-aluminum alloy containing 0.2 per cent Mn .

Figure 28 shows the two halves of the specimen, the left half as cast and the right half annealed for five days at 400° C. In the heat-treated specimen the dendritic attack, running from the outer edge in tree-like fashion, was absent but it appeared that whole grains were eaten out. Resistance to corrosion was not bettered. When extruded pieces of the same alloy were given a similar heat treatment and tested quantitatively for corrosion they were found to even be worse than before heat treatment.

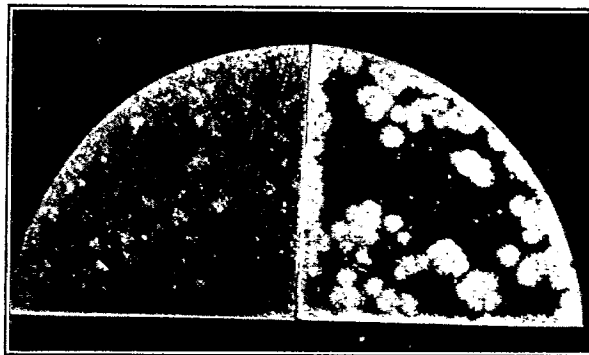

FIG. 28.—Same specimen as Figure 27. Left half as cast; right half annealed five days at 400° C.

Hence it could be concluded that coring was not the cause of corrosion. Observations made during this same experiment also indicated that included oxide films had little effect. The problem seemed to be narrowed down to the effect of the manganese content.

EFFECT OF NONMETALLIC INCLUSIONS ON CORROSION

Metallographic examination frequently indicated a relation between corrosion and non-metallic inclusions. The corrosion attack tended to follow along entrained films, and inclusions were frequently surrounded by corrosion pits. It seemed probable that the presence of non-metallic inclusions was responsible for the rapid corrosion of a number of nonresistant air cast alloys. However, when corrosion was observed under the microscope the inclusions were found to be inactive. In some cases no action occurred at or near the inclusions; in other instances the films were surrounded by corrosion pits, but the attack frequently started at some distance from the inclusion and corrosion did not proceed from the inclusion outward.

Etching to develop cored structure showed that the relation between films and inclusions and corrosion was only apparent. The inclusions act as nuclei for the solidification of the magnesium-rich cored centrites, as shown in Figure 30. As the inclusion becomes larger the

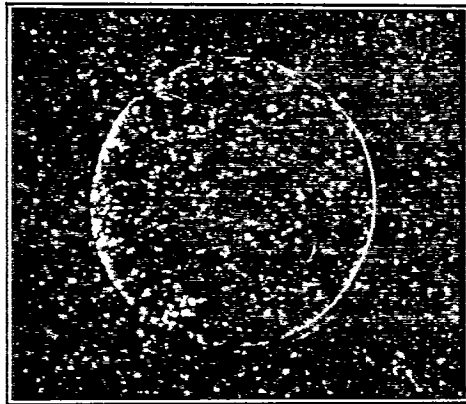

FIG. 29.—Corrosion pits in polished specimen of sand cast alloy containing 0.4 per cent manganese

dendrite loses its symmetry and tends to branch out at right angles from the edge of the inclusion to which it is attached. When the specimen is immersed in salt water the magnesium-rich cores are attacked, leaving the inclusion surrounded by a corrosion pit. This type of corrosive action is illustrated in Figure 31.



FIG. 30.—Mag. 100 X. Cored magnesium-rich dendrites surrounding nonmetallic inclusions

EFFECT OF VARYING THE MANGANESE CONTENT

A series of corrosion tests was made to determine the effect on corrosion of varying the manganese content of the 4 per cent aluminum alloy. The specimens were test bars which had been previously broken in tensile tests, and were machined to present a clean surface. A 2 per cent sodium chloride solution was used, and the results after five days' immersion are shown in Figure 32.

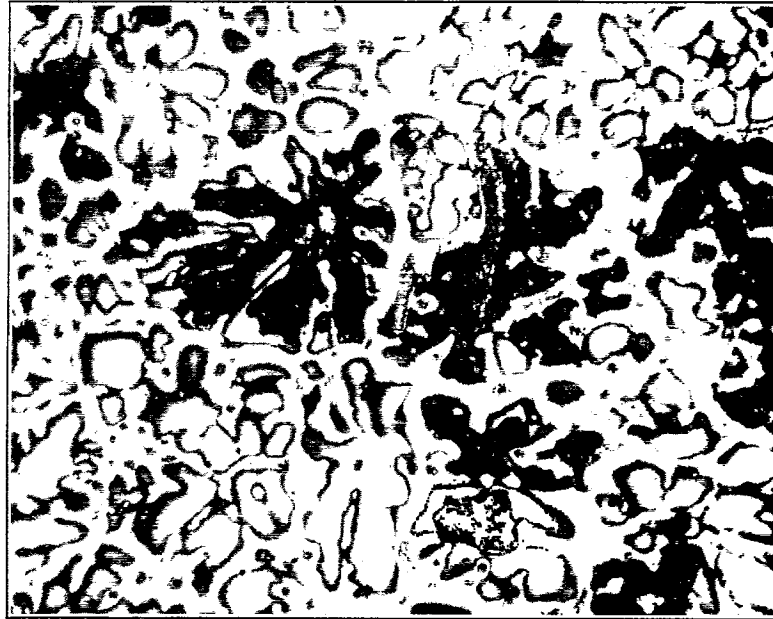

FIG. 31.—Mag. 100 X. Corrosion in area containing inclusions, showing relation between pitting and cored structure

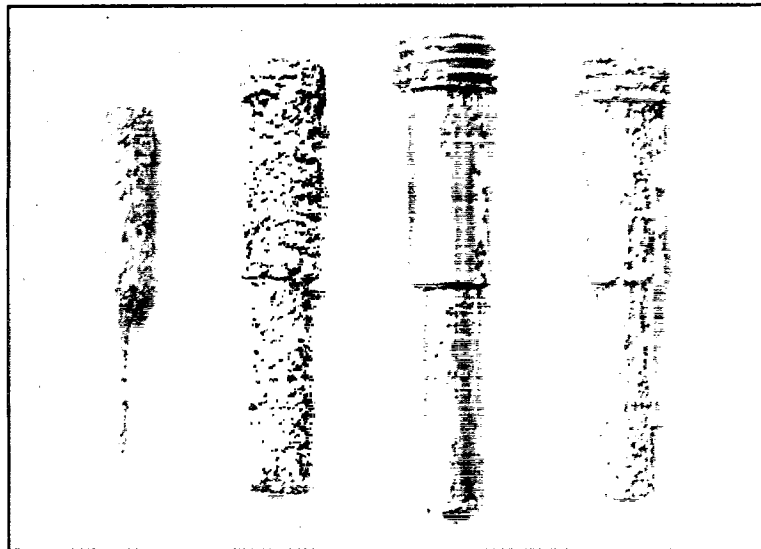

FIG. 32.—Effect of varying the manganese content of the 4 per cent aluminum alloy
1. 0.10 per cent Mn
2. 0.22 per cent Mn
3. 0.36 per cent Mn
4. 0.66 per cent Mn
All as extruded; five days' immersion, 2 per cent NaCl solution

It is evident from these tests that a critical amount of manganese is necessary to produce a maximum inhibiting effect. The alloys low in manganese were badly corroded. A few hundredths of a per cent will make all the difference between an alloy which corrodes rapidly and one which is resistant. In order to determine more accurately the effect of small variations, a series of alloys was made in which the manganese was varied by approximately .05 per cent intervals. The specimens were the standard corrosion test pieces, 3 x 1½ inches x ⅜ inch. After five days' immersion in 2 per cent sodium chloride solution the pieces were acid cleaned and weighed.

LOSS IN WEIGHT OF CORROSION TEST PIECES CONTAINING VARYING AMOUNTS OF MANGANESE

Composition	Loss in weight
Per cent	
.10 Mn (4 per cent Al).....	19.1
.15.....	14.4
.19.....	11.3
.23.....	8.9
.28.....	3.2
.32.....	2.2
.38.....	1.7
.40.....	1.9

These specimens were made under argon and were not cast in a cold chill mold but were cooled fairly slowly. When the specimens were heat treated and quenched those containing too little manganese corroded much more rapidly than before heat treatment. The difference in varying the amount of manganese was comparable to that obtained in chill cast foundry alloys having a slightly low manganese content as compared with the resistant vacuum-cast alloys. It seemed probable that the difficulty in obtaining a resistant foundry alloy was due to the presence of too little manganese, so that the manganese content was raised to 0.35 per cent. When this was done, the corrosion tests on the foundry alloys showed the metal to be practically as resistant as that made under vacuum or argon.

It may be concluded that the manganese content should be at least three-tenths per cent, and preferably four-tenths per cent, to allow for difference in thermal treatment and the small variation usually encountered in preparing the alloy.

CORROSION TESTS OF THE ENTIRE SERIES SHOWING THE EFFECT OF VARYING BOTH THE ALUMINUM AND MANGANESE

Tests similar to those made with the 4 per cent aluminum alloy were run with alloys containing 6, 8, and 12 per cent aluminum. The results are shown in Figures 33 to 35. The specimens were ends of broken test bars which were machined again to present a fresh surface, and all samples were immersed for 48 hours in 2 per cent sodium chloride solution. At the conclusion of the test the specimens were acid cleaned by dipping for 20 seconds in dilute nitric acid.

As the aluminum content was increased it was evident that the amount of manganese must also be increased to assure an inhibiting effect in all stages of thermal treatment. Even the 12 per cent alloy, which ordinarily corrodes very rapidly, could be made as resistant as any of the others by the addition of a sufficient amount of manganese.

The photographs of the 6 and 8 per cent series show the extent to which corrosion was inhibited in the specimens containing sufficient manganese. The effect is not brought out as well in the 12 per cent series because the latter are turned black on acid cleaning and do not present a polished surface. On visual examination after corrosion the 12 per cent alloy specimens 6, 12, and 18 were found to be unattacked by salt water except for a black surface discoloration.

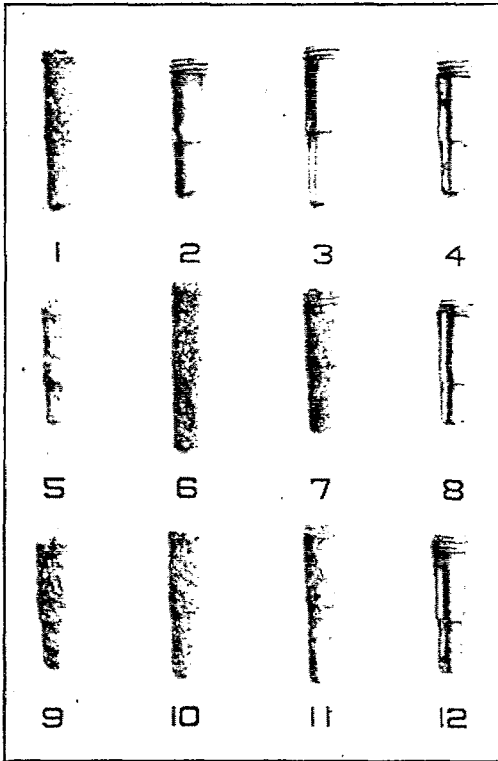

FIG. 33.—Corrosion tests of 6 per cent aluminum alloy containing varying amounts of manganese.

Spec. No.	Al	Mn
1	6.18	0.10
2	6.60	.20
3	5.91	.35
4	6.1	.57

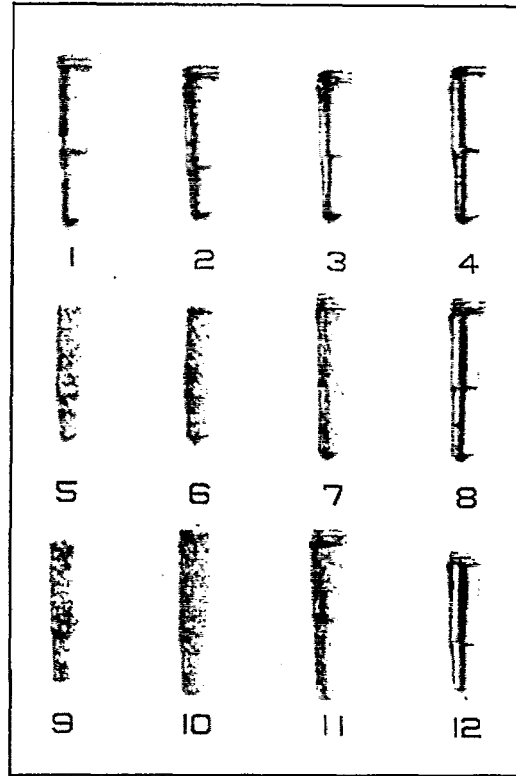

FIG. 34.—Corrosion tests of 8 per cent aluminum alloy containing varying amounts of manganese.

Spec. No.	Al	Mn
1	8.61	0.12
2	7.86	.17
3	8.49	.42
4	8.18	.55

Specimens 5, 6, 7, and 8 heat-treated and quenched. Specimens 9, 10, 11, and 12 heat-treated, quenched, and aged. Immersed 48 hours, 2 per cent NaCl solution

EFFECT OF HEAT TREATMENT ON THE CORROSION OF THE ALUMINUM ALLOYS CONTAINING MANGANESE

It is interesting to note in the preceding tests that in every case where insufficient manganese is present solution heat treatment makes the alloys much less resistant to corrosion. It is evident that corrosion is not a question of homogeneity, as has also been confirmed by microscopic examination. The amount of manganese necessary depends apparently on the amount of aluminum in solid solution and not on that present as undissolved constituent. When sufficient manganese is present, solution heat treatment has little or no effect. Perhaps the best test to determine the amount of manganese necessary to inhibit corrosion in a given alloy under all conditions would be to give each specimen of the series a prolonged solution heat

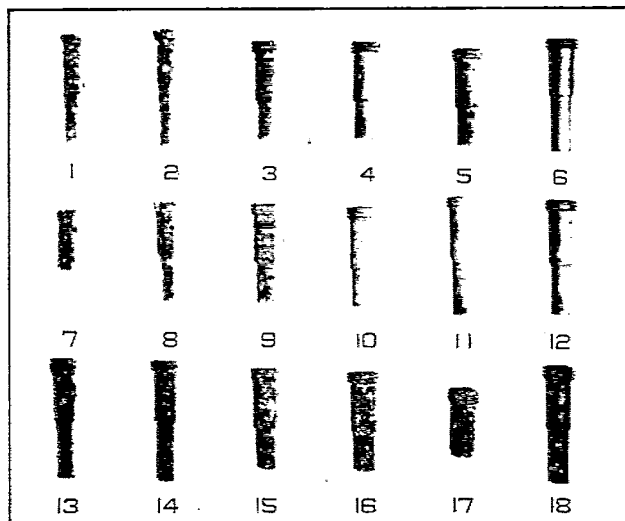

FIG. 35.—Corrosion tests of 12 per cent aluminum alloy containing varying amounts of manganese

Spec. No.	Al	Mn
1	12.05	0.08
2	12.54	.11
3	12.75	.20
4	12.76	.33
5	12.83	.51
6	12.38	.83

Specimens 7, 8, 9, 10, 11, and 12 heat-treated. Specimens 13, 14, 15, 16, 17, and 18 heat-treated and aged

treatment and determine the manganese content at which the alloy still retained its resistance to corrosion.

POTENTIOMETRIC INVESTIGATION

Metallographic examination showed the nature of the corrosion attack with the aluminum alloys, and that the increased corrosive action due to added aluminum was not caused by undissolved aluminum constituent. However, it did not show the mechanism whereby aluminum accelerated corrosion, or the function of manganese in counteracting the effect of the aluminum added.

The tendency of magnesium to corrode rapidly is due to its position in the electromotive series. It has been previously emphasized that the corrosion of magnesium in salt solutions is essentially a displacement of hydrogen, and unless the accelerated corrosion of the magnesium-aluminum alloys is caused by a galvanic couple between the magnesium and the undissolved constituents present, any influence which inhibits corrosion must tend either to hinder the magnesium from passing into the solution, or to make it more difficult for the hydrogen to plate out. Granting this assumption, it should be possible to summarize all the ways in which

manganese could inhibit corrosion, and to seek experimental evidence from potential measurements to prove the nature of the inhibitive action. The possible effects of manganese may be summarized as follows:

Lowering of the solution tendency of magnesium by:

- (1) Mechanical resistance due to a more protective insulating film.
- (2) Lowering the solution potential through solid solubility of the manganese.
- (3) Lowering the solution potential by the formation of a more protective but not necessarily insulating film.

Hindrance of the plating out of hydrogen by:

- (1) Raising the overvoltage of the metal.
- (2) Increasing the solid solubility of impurities of low overvoltage from which hydrogen could be easily liberated.
- (3) Changing the overvoltage of undissolved constituents.

It was therefore proposed to investigate the following factors by means of potential measurements:

- (1) Effect of alloying elements on solution potential.
- (2) Effect of the protective film on solution potential.
- (3) Nature of galvanic action.
- (4) Effect on overvoltage of alloying with aluminum and manganese.

The term "solution potential" will be used to denote the single potential of magnesium in salt solutions rather than the potential of the metal immersed in a normal solution of its ions. The magnesium electrode is highly irreversible and the magnesium ion concentration in the solution has little effect on the value of the potential as measured.

It was not expected that the potential measurements during the process of corrosion could be duplicated to within more than a millivolt, so that extreme precautions for accuracy and the use of an expensive potentiometer and sensitive galvanometer did not seem warranted. The instrument used was the Leeds-Northrup student potentiometer, with a range of 2.2 volts, accurate to 0.5 millivolt. A portable d'Arsonval galvanometer was used, and the sensitivity was found to be ample. The battery current was controlled by a four-dial Leeds-Northrup resistance box, variable in steps of 1 ohm. The potentiometer circuit was standardized against an Eppley standard cell.

The calomel electrode was of the Fales type, and both normal and tenth normal potassium chloride solutions were used. The calomel was electrolytic, specially prepared for calomel electrodes by the LaMotte Chemical Products Co. An intermediate liquid junction of normal potassium chloride solution was used between the calomel electrode and the corroding medium.

THE SOLUTION POTENTIAL OF PURE MAGNESIUM

The true solution potential of magnesium is difficult to measure, and the cause is usually attributed to the formation of an oxide or hydroxide film. In determining the true potential an amalgam is used, and the values are considerably higher than those obtained by measuring the potential of the metal itself against aqueous solutions. The most accurate determination of the true potential is probably that given by Beck (Reference 1) who obtained a value of -1.856 to -1.876 volts in neutral or acid solutions of $MgSO_4$, in comparison with the normal hydrogen electrode. If the potential is compared with the normal calomel electrode used in the experiments of this section, the true potential would be between -2.14 and -2.16 volts.

In the study of corrosion the true solution potential is of little practical importance, except that the great departure from the true value under corrosion conditions may give some indication of film formation. As rapid corrosion is due to the displacement and liberation of hydrogen, the important value is the *effective* potential, or that available under the actual conditions of corrosion to bring about the displacement of hydrogen.

The single electrode potential of pure magnesium was measured in salt solutions and was found to vary from -1.65 to -1.75 volts in comparison with the normal calomel electrode, depending on the time of immersion and the condition of the surface. The theoretical potential

necessary to liberate hydrogen from a solution saturated with magnesium hydroxide is approximately -1 volt on the same scale, so that the solution potential of magnesium greatly exceeds the theoretical potential necessary to plate out hydrogen, even when the solution is alkaline.

THE SOLUTION POTENTIAL OF THE ALUMINUM ALLOYS

It was assumed that aluminum owing to its solid solubility would reduce the solution potential of pure magnesium. To determine quantitatively the effect of potential of the addition of aluminum the series of alloys used in a previous corrosion test (p. 5) was employed. The extruded specimens were annealed at 400° C. for four days and quenched so as to assure a homogeneous structure. The pieces were subsequently machined to a considerable depth to remove surface oxidation, and were rubbed with No. 0 Hubert emery paper to obtain a fresh surface. The specimens were then cleaned with a dry cloth and immersed in a 2 per cent sodium chloride solution. Readings were taken immediately; also the maximum value obtained during immersion in the salt solution was recorded.

SOLUTION POTENTIAL OF THE ALUMINUM ALLOYS

Alloy	Immedi- ately after immersion	Solution potential	
		Maximum	Lowering due to aluminum
Pure metal.....	1.700	1.705	
<i>Per cent Al.</i>			<i>Millivolts</i>
2.....	1.640	1.648	60
3.....	1.619	1.619	81
4.....	1.617	1.617	83
5.....	1.614	1.615	86
6.....	1.605	1.611	94
8.....	1.601	1.624	99

EFFECT OF SMALL AMOUNTS OF MANGANESE ON SOLUTION POTENTIAL

The small amount of manganese necessary to inhibit the corrosion of the aluminum alloys was found to have a negligible effect on solution potential. Specimens of the 4 per cent aluminum alloy, both with and without manganese, showed single potentials indetical to within 1 or 2 millivolts. Hence the inhibiting effect of manganese could not be attributed to a lowering of solution potential. The aluminum present in the alloys lowered the solution potential to a much greater extent than would be possible with a comparatively small amount of manganese, and any counteracting effect of manganese in lowering the potential by approximately another millivolt would be negligible. A small variation in the aluminum content would cause as great or even greater difference in potential than could be produced by the addition of manganese.

NATURE OF THE PROTECTIVE FILM

It was planned at first to make a series of accurate resistance measurements with the films formed on various alloys to compare their degree of protectiveness, but these experiments have not been completed. Rough measurements have shown that the film formed on pure metal and the resistant alloys has a comparatively low electrical resistance, at least in the early stages of corrosion.

When a reactive metal becomes covered with an adherent film of corrosion product, so that it is protected from further corrosion, the effect is made evident in the measurement of solution potential. Thus aluminum is above zinc in the electromotive series, but when the solution potentials of the two metals are measured in salt solutions the potential of aluminum is usually lower than that of zinc by several tenths of a volt. The aluminum is made "passive" by the presence of the protective film. The active surface of iron is also anodic to the surface of the same metal covered with an oxide film. The phenomenon is quite general, and the low value obtained for the solution potential of magnesium compared with the true potential is probably

due to a similar cause, although here the liberation of hydrogen adds another complicating factor.

If the corrosion resistance of the magnesium-aluminum alloys containing manganese were due entirely to the formation of a protective film, the solution potential should be lowered to a greater extent than with the alloys containing only aluminum. After corrosion had proceeded for some time the alloys without manganese should be anodic to the more resistant alloys, owing to the former presenting an active surface. Potential measurements showed that in every case the reverse was true. The manganese alloys were always anodic to the aluminum alloys containing no manganese. As the corrosion product accumulated on the alloy which was rapidly corroding, the solution potential dropped off correspondingly, but the potential of the resistant alloys still retained its high value.

The effect of film on the solution potential of pure metal was also measured over a period of two weeks' immersion. The values of the single potential with respect to the normal calomel electrode are given in the following table:

EFFECT OF FILM ON THE POTENTIAL OF PURE MAGNESIUM

Time after immersion	Potential
Instantaneous reading.....	1.700 Rapid evolution
1 minute.....	1.703 of hydrogen
5 minutes.....	1.705
15 minutes.....	1.704
30 minutes.....	1.700
1 hour.....	1.697
2 hours.....	1.687
4 hours.....	1.687 Slight evolution
8 hours.....	1.683 of hydrogen
24 hours.....	1.675
2 days.....	1.670
1 week.....	1.668
2 weeks.....	1.663

Although all visible hydrogen evolution ceased after the first day, the potential was still much higher than that theoretically necessary to plate out hydrogen as a gas, namely, -1 volt. This could mean only one of two things: Either the film was sufficiently insulating to stop chemical action and the high potential was exerted merely through a few pores of high electrical resistance, or else the film had lowered the solution potential to the point where it no longer exceeded the theoretical hydrogen potential plus the overvoltage of the metal. Experiments were undertaken to determine which of these conditions obtained.

Two machined electrodes from the same piece of magnesium ingot were immersed in 2 per cent salt solution until covered by the protective film. After about 26 hours all visible evolution of hydrogen had ceased, and the potentials were the same to within a millivolt. An external E. M. F. of 0.2 volt was applied across the two electrodes; when the circuit was closed hydrogen was immediately liberated from the magnesium cathode, even though covered with the film which stopped further action in salt solution. Since the total E. M. F. applied was only 0.2 volt, the depression of the cathode potential below that which it normally had before application of the current was less than this, and probably less than a tenth of a volt. Hence by merely depressing the potential from the original value of -1.70 to that of -1.80 volts (making it "higher" in a negative sense) vigorous evolution of hydrogen resulted. The potential was already 0.7 volt higher than the theoretical value necessary to displace hydrogen, and yet no hydrogen was liberated until the additional tenth of a volt was applied. When the circuit was broken and the additional potential removed, the evolution of hydrogen ceased.

This leads to the assumption that the film reduces the solution potential to a critical value where it is no longer able to displace hydrogen. If so, the overvoltage of magnesium must be comparatively high.

Another evidence that the corroded specimen is able to function as cathode in spite of the protective film is shown by the current generated when it is merely connected to a piece of the same metal having a clean surface. Here the differences in potential are small, but a current of from 2 to 3 milliamperes may be obtained. The amount of hydrogen liberated

cathodically is negligible compared with that liberated from the fresh piece, but this is to be expected because of the small difference in potential and the high electrical resistance of the cell.

If the overvoltage of magnesium is high and the film is not protective in the sense that it is insulating, then hydrogen should be readily liberated by merely connecting with a metal of low overvoltage.

An electrode made from magnesium ingot was allowed to stand in 10 per cent salt solution for a week to assure the protective nature of the film, and all signs of hydrogen liberation had apparently ceased. The electrode was then connected to a platinum rod immersed in the same beaker. Hydrogen was liberated vigorously from the platinum, and a current of from 30 to 40 milliamperes was obtained. Thus the film was not protective in preventing anodic action when an area of low overvoltage was exposed for the liberation of hydrogen.

The preceding experiments show that magnesium when covered by a protective film can function either cathodically (liberating hydrogen) or anodically (passing into solution) when potential or overvoltage relations are altered. That the corrosion of the magnesium when in contact with platinum was due to the low overvoltage of the platinum and not to the difference in potential between the two metals owing to their position in the electromotive series will be proved in the following section.

The older ideas of corrosion involved the formation of a galvanic couple between the more reactive metal and noble impurities, and the driving force of corrosive action was supposedly the difference in potential between the two metals, which in turn depended on their position on the electromotive series. According to this view resistance to corrosion implied homogeneity; alloys possessing a heterogeneous structure and having phases or parts differing in solution potential from the remainder should function as galvanic cells, at least in the case when hydrogen is liberated. The following experiments show that galvanic action depends on overvoltage rather than a difference in solution potential between the two metals.

It has been emphasized that corrosion is essentially a displacement of hydrogen. If the solution potential of the metal is higher than the theoretical potential necessary to liberate hydrogen plus the overvoltage of the metal, hydrogen will be liberated on the surface of the metal irrespective of the presence of impurities. When this condition obtains with magnesium, an external connection to a piece of copper immersed in the same solution only slightly accelerates corrosion. The greater part of the hydrogen is still liberated from the magnesium surface, even in the case of very pure metal.

When the overvoltage is high and the solution potential is not sufficiently great to displace hydrogen on the surface of the metal, then the total hydrogen displacement will take place from such impurities of low overvoltage as the metal may happen to contain. If the impurities have an overvoltage as high or higher than that of the metal itself, then hydrogen can not be displaced as a gas no matter what difference in solution potential exists between the reactive metal and the impurity. As the cell is short circuited the magnesium merely imparts its high solution potential to the impurity; if the overvoltage of the impurity is low enough so that hydrogen can be liberated at this high potential, then gaseous evolution will take place and current will flow; if not, current will only flow momentarily until the electrode polarizes and acquires the same potential with respect to the solution as the surrounding magnesium, whereupon action will cease.

An experiment was made to quantitatively verify these assumptions. Platinum and mercury, which are close together in the electromotive series but differ greatly in overvoltage, were chosen as cathodes of a short-circuited corrosion cell which was set up as shown in Figure 36. A magnesium electrode was used as anode; the electrode had been previously immersed in 10 per cent salt solution for several days and all visible signs of hydrogen evolution had ceased. The metal was covered by the so-called protective film.

The overvoltage of mercury is higher than that of any other metal which has as yet been measured, while the overvoltage of platinum is known to be low. Hence, unless the protective film in the magnesium were insulating and prevented anodic action, we should expect a current to flow and the magnesium to dissolve when connected to platinum; on the other hand,

only a momentary current should be produced with mercury, and the magnesium anode should remain unattacked, even though there is a difference in potential between the two metals of nearly two volts when measured on open circuit.

The differences in potential between magnesium and the two cathode metals were measured on open circuit with the potentiometer and were found to be almost identical:

	Volts
Magnesium-platinum.....	1. 62
Magnesium-mercury.....	1. 64

The latter potential dropped to 1.59 volts merely due to polarization by the small current which flowed through the galvanometer.

When the cells were short-circuited through a milliammeter the one having a mercury cathode gave only a momentary current which soon dropped to zero. The platinum cell was still giving quite a high current after 48 hours when the experiment was discontinued.

Current		
Time	Mercury	Platinum
	<i>Milliamperes</i>	<i>Milliamperes</i>
Initial current.....	4	6
1 minute.....	2	25
2 minutes.....	1	30
5 minutes.....	0.5	30
10 minutes.....	.3	30
30 minutes.....	.3	34
2 hours.....		40
24 hours.....		40
48 hours.....		31

The platinum cathode was only a one-eighth inch rod and furnished much less area than the mercury, but after 10 minutes it produced nearly 90 times the current which flowed when mercury was used as cathode. The cell was carefully tested for external resistance, particularly with respect to the mercury column used for connection to the mercury cathode. When this column was introduced into the circuit while the magnesium was connected to the platinum no change in current resulted.

There was no evidence of hydrogen evolution from the mercury, but hydrogen was evolved vigorously from the platinum. At the end of 48 hours the electrode connected to the platinum was badly corroded and reduced to about two-thirds its original size, while the electrode connected to the mercury was unattacked except for the small amount of pitting due to the normal action of salt water. The two electrodes together with a reference electrode which had been immersed merely in the same depth of salt solution for the same length of time are shown in Figure 36.

The experiment showed that polarization is the controlling factor in galvanic action rather than difference in solution potential. This, in turn, depends almost entirely on overvoltage. The mechanism of the action may be pictured as follows:

The electrolytic corrosion cell is short circuited and there is practically no drop in potential through the metal. Thus the second metal or impurity tends to assume practically the same high potential as the magnesium. However, if the overvoltage is low, it can not keep this potential with respect to the solution, for hydrogen will plate out before the potential can be built up to this value. The impurity then functions not as a metal electrode but as a hydrogen electrode. If the impurity has no overvoltage it assumes practically the true hydrogen potential. If it has approximately two-tenths volt overvoltage it will assume a potential two-tenths volt higher than this. If the overvoltage equals or is greater than that of the reactive metal no current will flow unless the potential of the reactive metal is high enough to displace hydrogen on its own surface. Under any condition there is only a few tenths of a volt difference in *effective* potential between magnesium and the impurity. This effective potential difference may even be zero, whereas the difference in potential on open circuit may be from one to two volts.

THE CORROSION OF MAGNESIUM

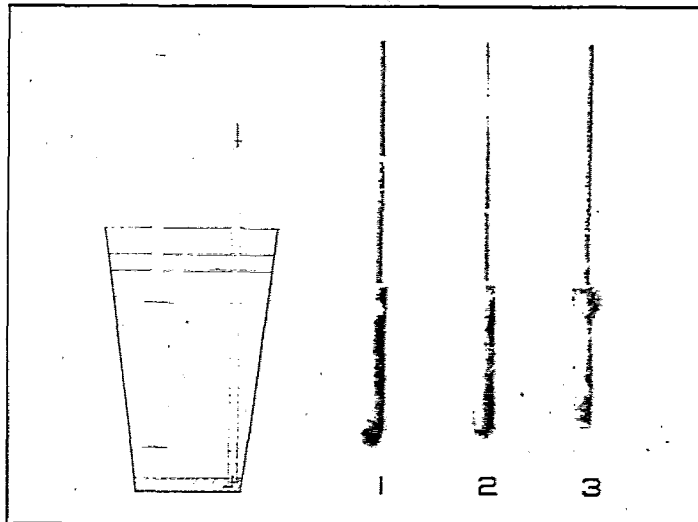

FIG. 36.—Electrolytic cell and electrodes used in overvoltage experiment. (1) Immersed in 10 per cent NaCl solution 7 days. (2) Connected to mercury 48 hours. (3) Connected to platinum 48 hours

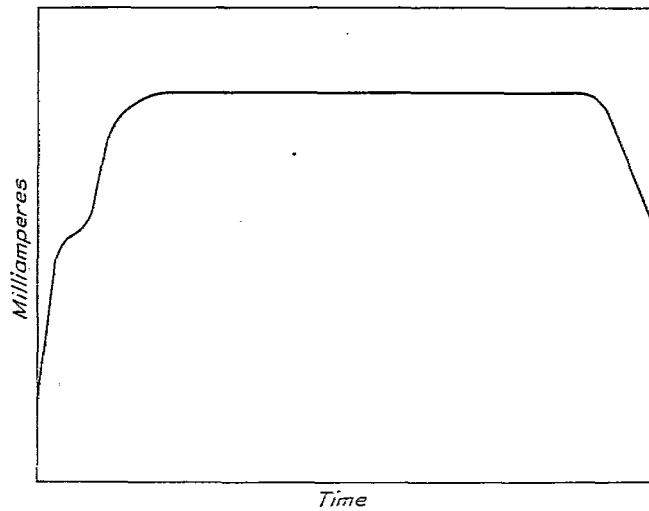

FIG. 37.—Current. Time curve for electrode connected to platinum

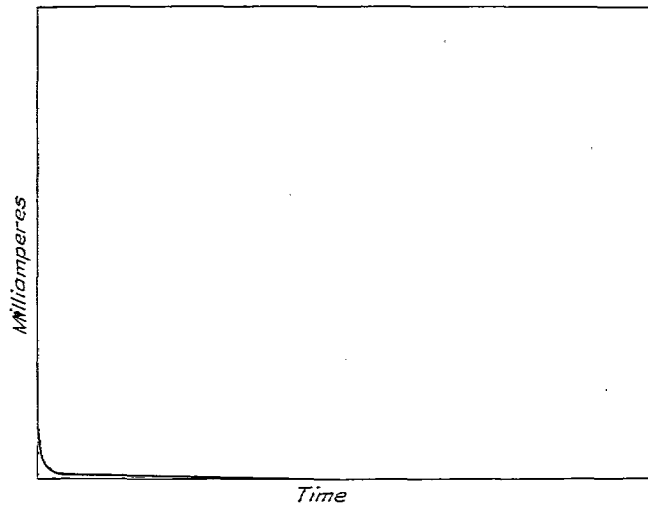

FIG. 38.—Current. Time curve for electrode connected to mercury

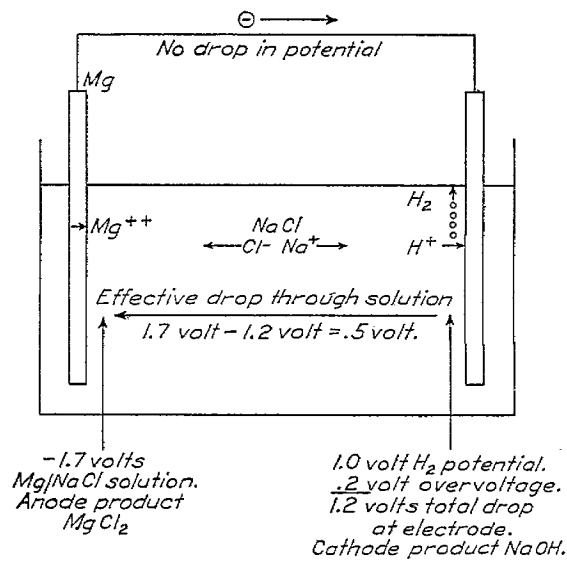

FIG. 39.—Diagrammatic representation of galvanic action with impurity of low overvoltage

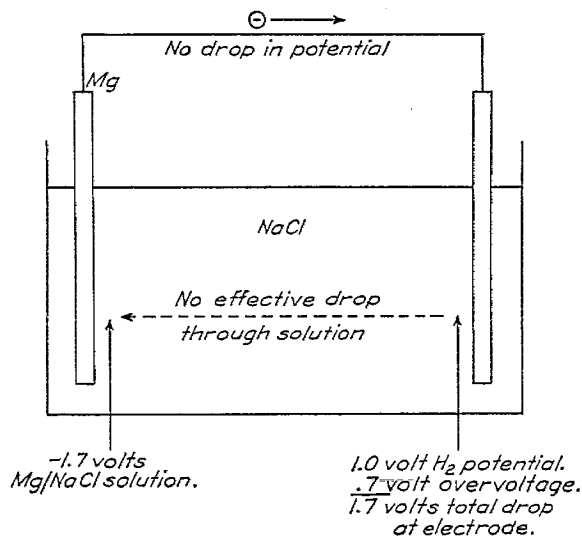

FIG. 40.—Diagrammatic representation of galvanic action with impurity of high overvoltage

ACTIVATION OF THE PROTECTIVE FILM THROUGH THE FORMATION OF A GALVANIC COUPLE

In the experiments on galvanic action in which magnesium was connected to platinum it was noted that some hydrogen came from the magnesium as well as from the platinum rod acting as cathode. All liberation of hydrogen from the corrosion specimen had ceased before the two metals were connected so that there was evidently some activation of the film by electrolysis.

In subsequent experiments using other metals than platinum an effort was made to decrease the resistance of the electrolytic cell by employing larger cathodes, and it was found that immediately on short circuiting these cells hydrogen was liberated vigorously from the magnesium anode as well as from the cathode. In some cases it seemed that more hydrogen was liberated from the magnesium than from the second metal employed in the galvanic couple. When the circuit was broken the rate of hydrogen evolution from the magnesium decreased rapidly and finally became inappreciable, but when the circuit was again closed the evolution of hydrogen immediately became vigorous. The phenomenon could apparently be repeated as often as desired.

These observations showed the presence of an unusual condition which is not present in the corrosion of less reactive metals. Although corrosion may be caused entirely by the electric current which is set up when magnesium is connected to an impurity of low overvoltage, the actual current which flows may account only for a small portion of the metal which dissolves. The film of corrosion product which would protect the anode unless current were passing is activated so that additional metal is dissolved owing to a displacement of hydrogen directly on the magnesium surface.

If the liberation of hydrogen were due to an activation of the protective film, this should make itself evident on measuring the solution potential immediately after the circuit is broken. Potential measurements showed a rise in potential of approximately 10 millivolts which dropped rapidly to the normal value, whereupon the liberation of hydrogen practically ceased.

In all electrolytic corrosion in chloride solutions where the anode and cathode are separated by an appreciable distance, the primary corrosion product is magnesium chloride and not magnesium hydroxide. Previous investigators have shown that magnesium chloride is more corrosive in its action toward magnesium than either sodium or potassium chlorides; Evans (Reference 2) has maintained that the peptization of the hydroxide film by alkali chlorides is due to the magnesium chloride formed during corrosion.

In addition to peptization, or the tendency of the magnesium chloride to cause the hydroxide film to pass into colloidal solution, there are a number of possible reasons for the activation of the film by electrolysis. One factor which may be of importance and which has never before been mentioned is the "acid effect" exerted by magnesium chloride. A saturated solution of magnesium hydroxide is slightly less alkaline when a large amount of magnesium chloride is present, as may be shown by electrometric titration curves.

When the hydrogen ion concentration is increased even slightly, the potential necessary to plate out hydrogen is lowered. Since the film on the magnesium is not insulating and the solution potential of the metal is now higher than the sum of the hydrogen potential plus the metal overvoltage, hydrogen will be displaced.

It has been shown by the work of Evans (Reference 3) and others that the pitting of iron and steel is due almost entirely to differential aeration, or unequal access of oxygen to different parts of the specimen. Evans succeeded in measuring the current between aerated and unaerated pieces of iron, and found that it accounted for nearly 80 per cent of the total corrosion. The corrosion of magnesium is entirely different in type but it seemed of interest to determine the effect of atmospheric oxygen on solution potential.

Two electrodes of pure metal were immersed in the same beaker and allowed to corrode until there was no visible liberation of hydrogen. The pieces were connected to a galvanometer; one of the pieces was removed from the solution for a moment and then immersed again in the salt solution. A current was indicated on the galvanometer. The other electrode was then

removed and reimmersed, and a current flowed in the opposite direction. Thus the aeration currents of Evans were detected, even when the magnesium was covered by a protective film.

Solution potentials were then measured, using the magnesium electrode in comparison with the normal calomel electrode. After aeration the potential dropped 5 to 10 millivolts, but on standing in the salt solution it soon returned to its normal value. This drop in potential due to aeration was observed even with pieces which had been previously immersed in salt water for a period of six weeks.

NATURE OF PITTING

Although it was believed that pitting of magnesium was due principally to surface condition and to factors external to the structure of the metal, it was at first very difficult to formulate a theory whereby the phenomena observed in localized corrosion could be satisfactorily explained. In the first place, hydrogen usually came from the pit. As the pit penetrated more deeply into the metal hydrogen continued to come from the bottom of the pit, even when the depth had advanced a measurable distance from the point of inception. This in itself made it difficult to believe that the action was due to an undissolved impurity, unless the entire area in the direction of pitting contained this impurity, for the seat of hydrogen liberation changed with advancing depth. Microscopic examination showed no segregation of impurities in the pitted areas to account for the facts observed.

The investigation with the potentiometer as outlined up to this point furnishes an explanation of pitting which is believed to be essentially correct.

When magnesium is immersed in a salt solution practically the entire outer surface is eaten away. During the formation of the film of corrosion product there are bound to be irregularities. Anode and cathode areas will consequently be set up. Even immediately on immersion these differential areas will be established owing to surface irregularities and oxidation films of varying thickness.

It has been shown that a measurable current could be obtained by merely connecting a piece of magnesium covered with a protective film to a clean electrode made from the same metal. In the overvoltage experiments it was found that electrolysis activated the film on the anode area, raised the solution potential, caused the liberation of hydrogen from the anode, and kept a protective film from forming as long as the current passed. At the bottom of a corrosion pit we have such a set of conditions. The film of flocculent precipitate protects the anodic area inside the pit from the action of oxygen which would tend to lower the solution potential. The entire piece may function as cathode, both through the liberation of hydrogen and through depolarization with atmospheric oxygen. The anode is centered on one point or at the most a small area at the bottom of the pit. The magnesium chloride content of the pit becomes high through electrolysis; this has a great activating tendency, probably both through peptization of the hydroxide film and through some slight change in hydrogen ion concentration. Hydrogen is liberated from this active surface within the pit, and the process is continuous. Metal dissolves both through electrolysis and by a direct displacement of hydrogen from the active surface, and the actual current flowing may account for only a small part of the metal dissolved.

This theory as outlined explains why pitting is continuous when once started and why hydrogen comes from the bottom of the pit. Cases have been observed where a pit has started from one side of the piece and eaten entirely through it, so that the specimen could be broken in two with little effort. The presence of impurities of low overvoltage is not necessary for pitting, for experiment has shown that the piece itself can act as a cathode even when covered with a protective film. The important point is that in corrosion by electrolysis the primary product of corrosion is magnesium chloride and not hydroxide. The activating effect of the magnesium chloride probably accounts for the extreme depth of the pits in comparison with the corrosion of the surrounding metal and the fact that pitting when once started is continuous.

The presence of impurities of low overvoltage will probably cause pitting if these impurities are segregated, but this is seldom the case. In the copper alloys where the constituent is evenly

distributed the attack, although rapid, is general over the surface, and the entire piece disintegrates without the formation of deep pits. If the overvoltage of the impurity is as high or higher than that of magnesium, the impurity will have little effect on either general or localized corrosion.

PROBABLE ACTION OF MANGANESE IN PREVENTING CORROSION

Although the experimental work of the corrosion investigation has not been carried to a point where conclusions can be drawn with certainty, the experimental facts seem to point to one explanation for the inhibiting action of manganese on the corrosion of the magnesium alloys containing aluminum. The explanation may be summarized as follows:

The overvoltage of pure magnesium is quite high. On immersion in salt water the metal corrodes with the liberation of hydrogen until the film of corrosion product lowers the potential to a critical value. When the potential reaches this value it no longer exceeds the theoretical hydrogen potential plus the overvoltage of the metal. Rapid corrosion consequently ceases. When aluminum is added, especially when in large amounts, the overvoltage is decreased and hydrogen plates out at a much lower potential than with pure magnesium. The addition of a small amount of manganese raises the overvoltage back to practically that of pure metal, and the film is again protective.

It is not maintained that the interfering action of the film due to mechanical resistance is negligible, as this factor is probably of considerable importance. The experimental evidence merely indicates that it is not sufficient in itself to stop corrosion at the point where visible action ceases. As long as potential and overvoltage relations are favorable for the liberation of hydrogen, corrosion will continue until the piece is disintegrated.

CONCLUSIONS

1. Pure magnesium of ordinary ingot grade is quite resistant to corrosion by salt water.
2. The addition of aluminum increases the rate of corrosion, but the presence of a small amount of manganese counteracts to a large extent the effect of the added aluminum.
3. No relation can be traced between the presence of undissolved constituents and the rate of corrosion of the magnesium-aluminum alloys.
4. There is a definite relation between cored structure and corrosion. The magnesium-rich dendrites are eaten out as if by direct attack.
5. Coring is not the cause of corrosion but is merely responsible for the dendritic nature of the attack.
6. Magnesium silicide is inactive during corrosion.
7. The aluminum constituent, at least when present in small amounts, is inactive.
8. Nonmetallic inclusions are inactive during the initial corrosion attack, but the inclusions may act as nuclei for the crystallization of the magnesium-rich dendrites. The latter are attacked by salt water and give the appearance in the corroded specimen of a relation between inclusions and corrosion.
9. A critical amount of manganese is necessary to inhibit the corrosion of the magnesium-aluminum alloys. The amount increases with the quantity of aluminum in solid solution. At least three-tenths per cent manganese should be present in the 4 per cent aluminum alloy.
10. Alloys which do not contain the critical amount of manganese corrode until completely disintegrated.
11. An excess of manganese over the critical amount slightly decreases the resistance to corrosion but does very little harm. It is better to have too much than too little manganese present.
12. Heat treatment of the aluminum alloys containing too little manganese makes them much less resistant to corrosion. If sufficient manganese is present, heat treatment has practically no effect.
13. The protective film formed on resistant corrosion specimens does not stop electrochemical action by actual insulation. A change in potential relations of less than one-tenth volt will cause the liberation of hydrogen.

14. The electrical resistance of the film is small and is of the order of magnitude of a few ohms.

15. When a specimen covered by a protective film is connected to a metal of low overvoltage the magnesium corrodes rapidly and the film is activated so that hydrogen comes from both the magnesium anode and the metal acting as cathode.

16. Overvoltage of impurities and not their position in the electromotive series is the factor which determines whether they are active or inactive during corrosion.

17. Pitting is probably due to the activation of the film on the anodic areas by the formation of magnesium chloride during electrolysis. As long as current flows the action will be continuous.

18. Aluminum apparently lowers the overvoltage of magnesium. Hydrogen is liberated at a much lower potential during corrosion than is the case with pure magnesium.

It is concluded that manganese raises the overvoltage of the aluminum alloys back to practically that of pure magnesium.

REFERENCES

1. BECK, R. P.----- Rec. Trav. Chem. 41 (1922), 353.
2. EVANS, U. R.----- Trans. Faraday Soc. 28 (1922), 1.
3. EVANS, U. R.----- J. Inst. Met. 30 (1923), 257.