REPORT No. 298

**EFFECT OF VARIATION OF CHORD AND SPAN OF
AILERONS ON ROLLING AND YAWING
MOMENTS IN LEVEL FLIGHT**

By R. H. HEALD and D. H. STROTHER
Bureau of Standards

REPORT No. 298

EFFECT OF VARIATION OF CHORD AND SPAN OF AILERONS ON ROLLING AND YAWING MOMENTS IN LEVEL FLIGHT

By R. H. HEALD and D. H. STROTHER

SUMMARY

This report presents the results of an investigation of the rolling and yawing moments due to ailerons of various chords and spans on two airfoils having the Clark Y and U. S. A. 27 wing sections. Some attention is devoted to a study of the effect of scale on rolling and yawing moments and to the effect of slightly rounding the wing tips.

The results apply to level flight with the wing chord set at an angle of attack of $+4^\circ$ and to conditions of zero pitch, zero yaw, and zero roll of the airplane. It is planned later to extend the investigation to other attitudes for monoplane and biplane combinations.

The work was conducted in the 10-foot wind tunnel of the Bureau of Standards (fig. 1) on models of 60-inch span and 10-inch chord.



FIG. 1

INTRODUCTION

The investigation was undertaken for the Aeronautics Branch of the Department of Commerce in cooperation with the National Advisory Committee for Aeronautics for the purpose of making available to the industry data relative to the rolling and yawing moments due to conventional ailerons on some representative American wing sections. But little systematic work has been done along this line, the outstanding contributions being those of Archer (Reference 1) and Irving, Ower, and Hankins (Reference 2).

DESCRIPTION OF APPARATUS AND MODELS

THE WIND TUNNEL

The air is drawn through the 10-foot wind tunnel by means of a four-blade 14-foot tractor propeller driven by a 200-HP. direct-current motor. The lower and upper limits of the speeds available are, respectively, 20 feet per second and 100 feet per second. A calibration of the tunnel for speed distribution, which was made in the area subsequently occupied by the model, showed the speed to be uniform within ± 1 per cent.

AIRFOILS

The wing models, 60 inches span and 10 inches chord, shown in Figures 2 and 3, were constructed of 3/4-inch mahogany strips and on completion showed a maximum deviation from the templates of ±0.02 inch. The metal templates were constructed accurately to the dimensions of the two sections as given in N. A. C. A. Technical Report No. 233. It was felt that this deviation was permissible in wooden models of this size. Two models of each wing were prepared, in order to permit tests in biplane combination.

Figure 3 illustrates the method adopted for obtaining a variation of aileron chord and span. The ailerons of varying chord were built into the right portion of the wing, those of varying span into the left portion of the wing. Thus a study of the characteristics of the individual ailerons was possible through a rather wide range of chord and span variation.

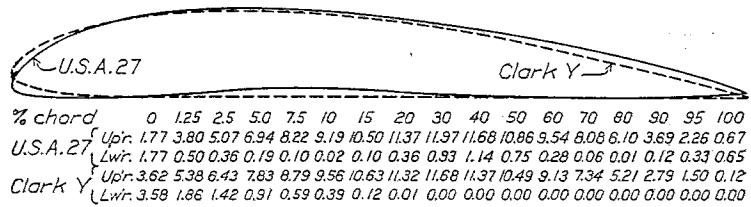

FIG. 2.—Dimensions of wing sections. Source, N. A. C. A. Technical Report No. 233

The ailerons were so mounted that their axes of rotation were midway between the upper and lower surfaces of the wing. When under test, all slots were filled with wax and smoothed. The section of the wing was constant along the span, there being no tapering or feathering.

FUSELAGE AND UNIVERSAL JOINT

The wings were mounted on a fuselage or fairing which formed the housing for a ball-bearing universal joint from which the whole system was supported by a 3/4-inch mast bolted and

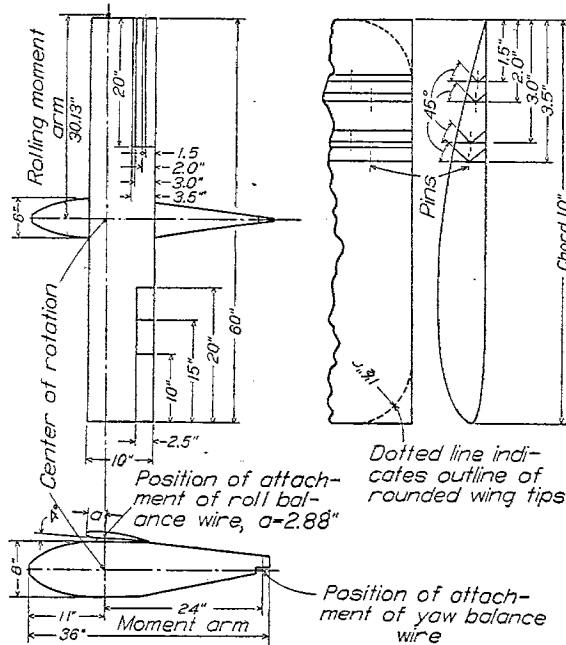

FIG. 3.—Varying aileron chord end of wing, Clark Y section, showing method of hinging ailerons. U. S. A. 27 similarly constructed

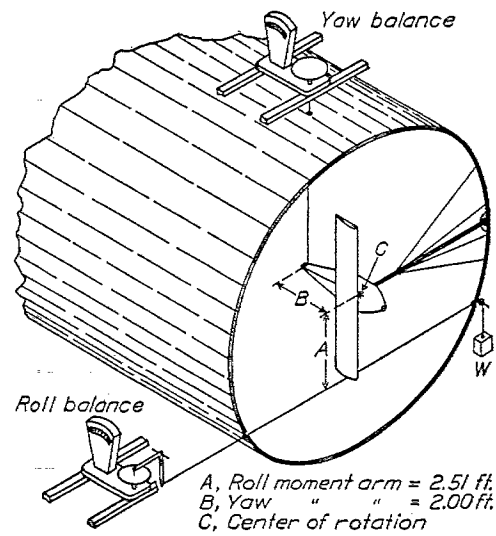

FIG. 4.—Arrangement of rolling and yawing moments

guyed by stay wires to the side of the tunnel. Provision was made for setting the wings at various angles to the axis of the fuselage. The general arrangement of the set-up is shown in Figures 4, 5, and 6.

ARRANGEMENT OF BALANCES

For convenience in observation, the model was mounted in the tunnel with the span of the wing vertical, and the rolling and yawing forces were read on balances of the pendulum type (fig. 4). Both balances were calibrated before making the observations. A further check was made on the precision of the complete system by applying known moments directly to the model.

METHOD OF MEASUREMENT

Simultaneous readings of the rolling and yawing moments were made at speeds of 40, 58.7, and 80 feet per second (respectively, 27.3, 40, and 54.5 miles per hour) with the axis of the fuselage parallel to the wind direction and with the angle of incidence of the wing set at +4°. This setting corresponds to 0.55 of the maximum lift coefficient of the Clark Y wing and 0.52 of the maximum lift coefficient of the U. S. A. 27 wing. (Reference 3.)

Observations were made with the ailerons set at angles of 8° and 16° to the wing chord and at 4° intervals thereafter up to 44°. The aileron angles were set by means of metal templates, but because of a slight warp along the trailing edge of the aileron the precision of setting was ± 1°, the values given being the mean of the inclinations at the tip and root of the aileron.

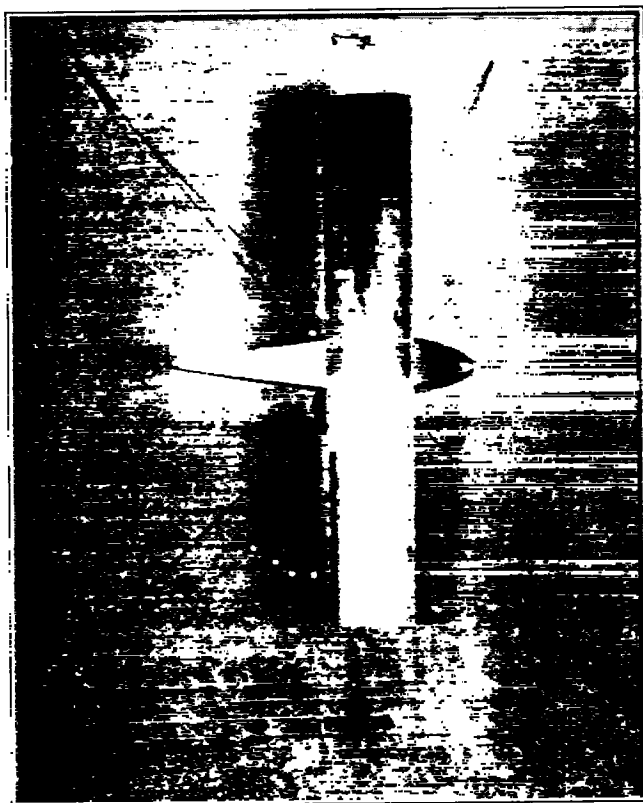

FIG. 5

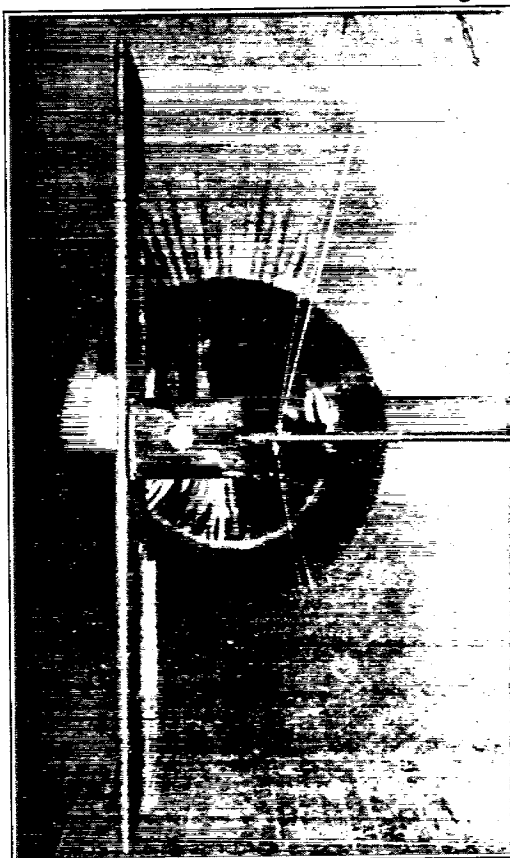

FIG. 6

Indication of unsteady flow about the ailerons was noted early in the investigation in the case of aileron angles greater than 16°. The effect of this burbling flow was so marked on the rolling moment balance that considerably heavier damping was necessary than was used for the yawing moment balance. The region of greatest unsteadiness occurred in the neighborhood of 24° aileron setting. The flow appeared to steady down somewhat for aileron angles greater than 32°.

REDUCTION OF OBSERVATIONS

Small rolling and yawing forces, which appeared to be due to the drag of the balance wires and possibly to a slight assymetry in the model, were noted at zero aileron angle in all cases. Correction was made for these forces in the reduction of observations.

The results are expressed in the usual N. A. C. A. form of absolute coefficients given below:¹

$$C_L = \frac{L}{qbS} \text{ and } C_N = \frac{N}{qfS}$$

where C_L and C_N are the absolute rolling and yawing moment coefficients for one aileron.

¹ Note that the coefficients are based on wing dimensions which are held constant throughout the investigation; i. e.—

$L = C_{Lq} \times \text{a constant} = C_{Lq} \times 20.83$
 and $N = C_{Nq} \times \text{a constant} = C_{Nq} \times 8.68$

L and N are respectively rolling and yawing moments in pounds-feet.

$$q = \frac{1}{2} \rho V^2 = 0.001189 V^2$$

b = wing span in feet.

f = distance from center of rotation of model to end of tail.

(Note: This distance was chosen as closely representing the distance from the center of gravity of the airplane to the leading edge of the elevator.)

S = wing area in square feet (chord length \times span.)

V = wind speed in feet per second.

ρ = 0.002378 slugs per cubic foot at 15° C. and 760 mm pressure.

The reference axes are body axes and the directions are conventional, a moment tending to produce clockwise rotation as viewed from the pilot's seat being considered positive. The values given in Tables I-IV and those plotted in Figures 7-20 refer to a single aileron on the right half of the wing.

RESULTS

REPRESENTATIVE CURVES

Figures 7 and 8 are representative of plots of the observed values, reduced to the coefficients C_L and C_N , for varying aileron angles. Since only a slight scale effect was noted within the range of speeds employed, a faired curve was drawn through all the points, and the values given in Tables I-VIII and subsequently plotted were read from these curves.

ROUNDED AND RECTANGULAR TIPS

The models were originally made with corners rounded to a radius equal to 15 per cent of the wing chord. These were afterwards filled in to form rectangular tips, as it seemed desirable to use a standard plan form for systematic tests. Some comparative observations were made, and the results are plotted in Figure 9.

The effect of rounding the tips is negligible on the rolling moment coefficient with the aileron up, but is somewhat more pronounced in the case of the yawing moment coefficient. Both rolling and yawing moment coefficients show slight increases when the rounded aileron is put down.

EFFECT OF VARYING AILERON CHORD AND SPAN

Figures 10-21 and Tables I-IV present the major results of the investigation. The values of C_L and C_N are plotted against aileron chord or aileron span expressed in per cent of the corresponding wing dimension. The coefficients due to various differential combinations are obtainable by the use of Tables I-IV, and direct combinations of the values are given in Tables V-VIII and plotted in Figures 23-25.

ROLLING MOMENT COEFFICIENTS

Comparison of the ratios of the rolling moment coefficients for ailerons in the up and down positions shows that for corresponding angles the rolling moment due to the aileron in the up position exceeds that due to the down aileron by from 2 to 85 per cent, depending on the wing section and the chord, span, and angle of the aileron. The larger ratios of $\frac{C_L \text{ up}}{C_L \text{ down}}$ occur in the case of the ailerons having a chord length 35 per cent of that of the wing. The increase of the ratio $\frac{C_L \text{ up}}{C_L \text{ down}}$ as the aileron angle is increased is not marked in the case of ailerons of short chord length, but becomes greater as the chord length is increased. For example, in the case of the aileron on the Clark Y wing whose chord length is 15 per cent of that of the wing the ratio of $\frac{C_L \text{ up}}{C_L \text{ down}}$ is 1.36 at 8° and 1.20 at 44°. For an aileron having the same span but with a chord length 35 per cent of that of the wing the ratio $\frac{C_L \text{ up}}{C_L \text{ down}}$ is 1.24 at 8° and 1.85 at 44°. Lengthening the

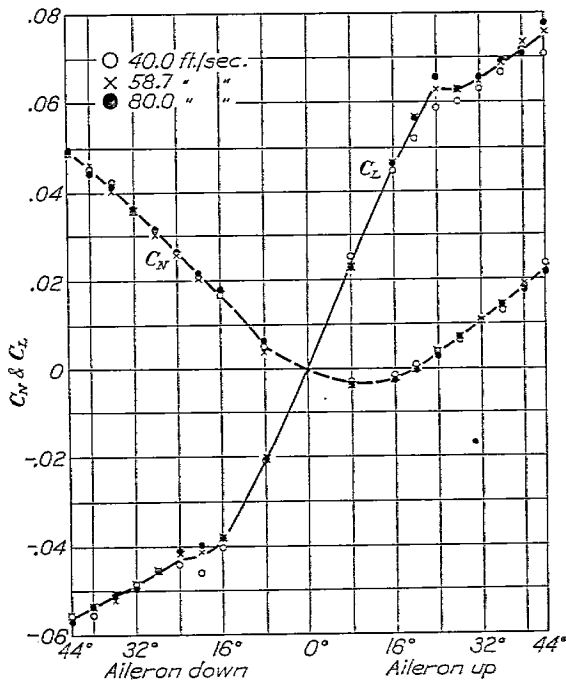

FIG. 7.—Clark Y wing. Aileron span 15 inches. Aileron chord 2.5 inches

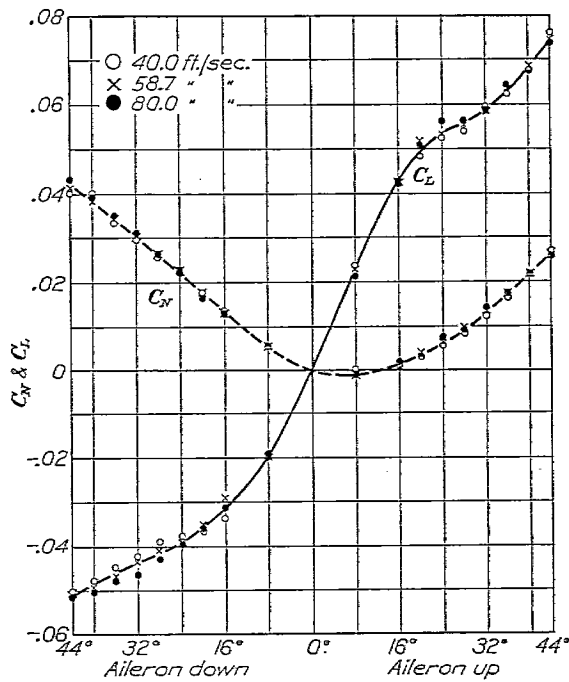

FIG. 8.—U. S. A. 27 wing. Aileron span 15 inches. Aileron chord 2.5 inches

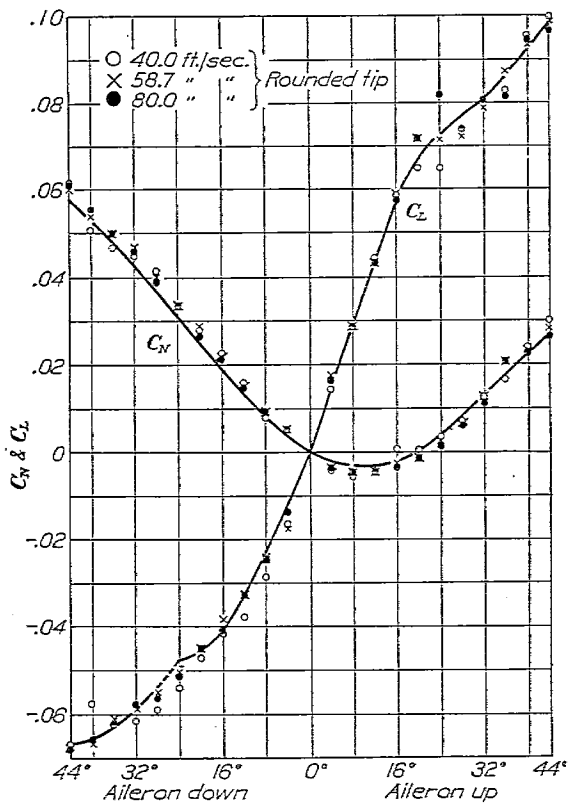

FIG. 9.—Clark Y wing. Aileron span 20 inches. Aileron chord 2.5 inches. Curva line represents rectangular tips—points not shown

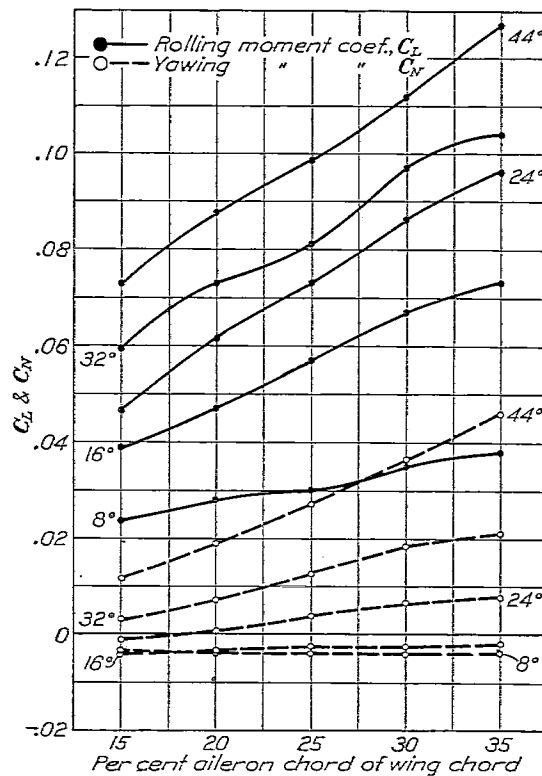

FIG. 10.—Clark Y wing. Aileron span 20 inches. Aileron chord varying. Aileron up

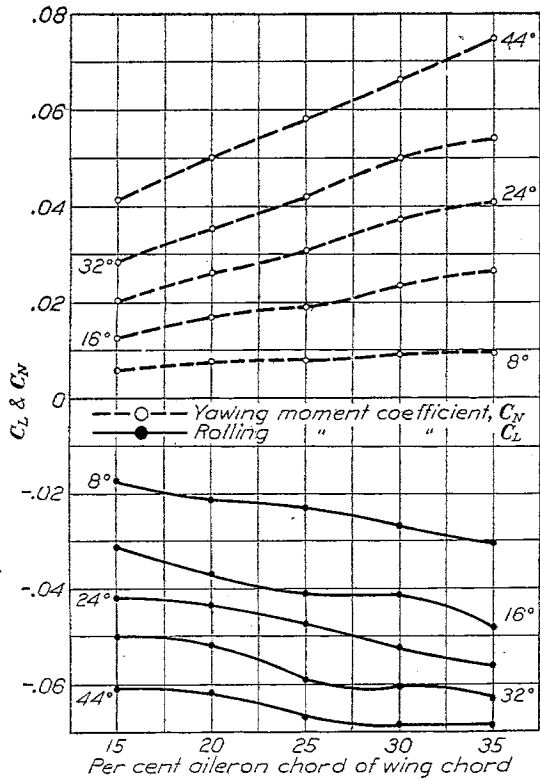

FIG. 11.—Clark Y wing. Aileron span 20 inches. Aileron chord varying. Aileron down

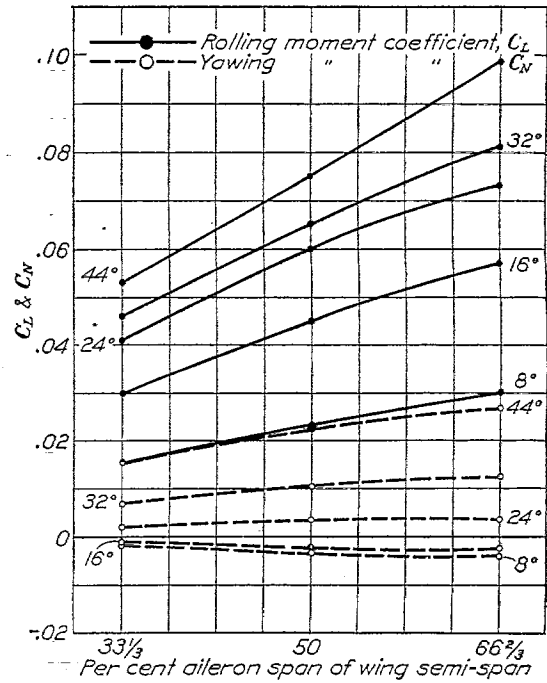

FIG. 12.—Clark Y wing. Aileron span varying. Aileron chord 2.5 inches. Aileron up

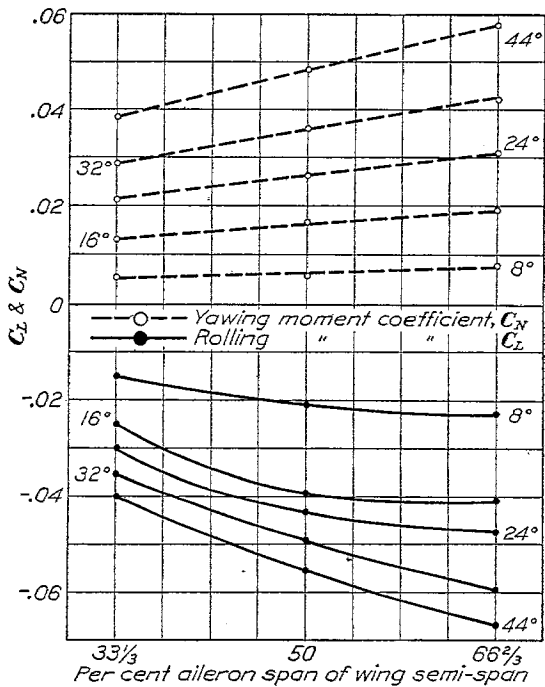

FIG. 13.—Clark Y wing. Aileron span varying. Aileron chord 2.5 inches. Aileron down

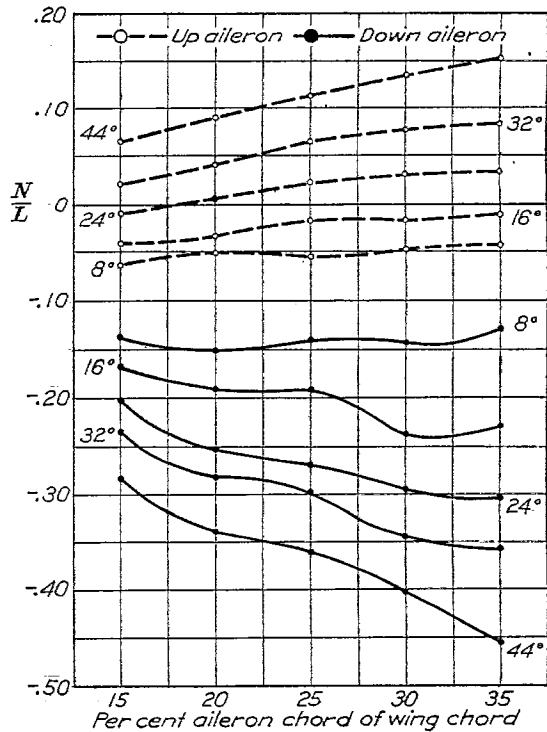

FIG. 14.—Clark Y wing. Aileron span 20 inches. $N/L = 0.417 C_N/C_L$

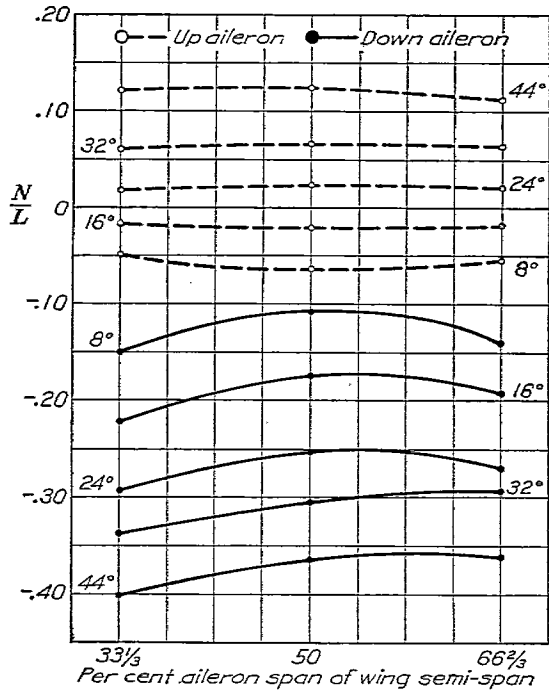

FIG. 15.—Clark Y wing. Aileron span varying. Aileron chord 2.5 inches. $N/L=0.417 C_N/C_L$

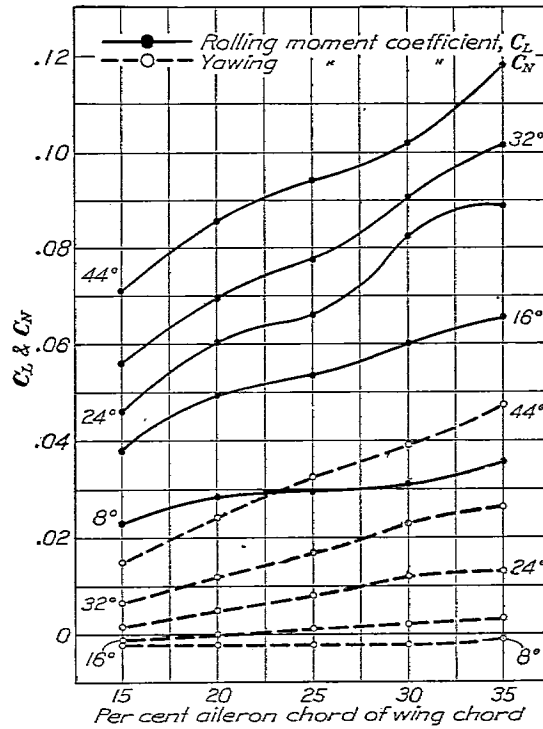

FIG. 16.—U. S. A. 27 wing. Aileron span 20 inches. Aileron chord varying. Aileron up

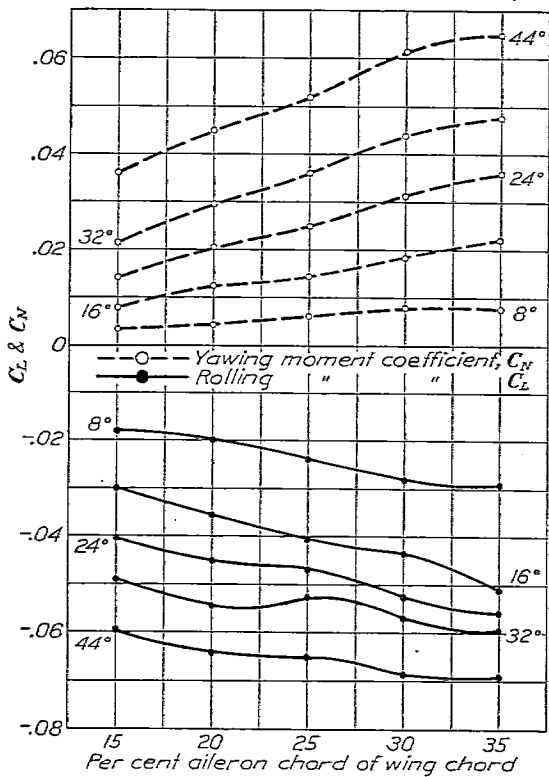

FIG. 17.—U. S. A. 27 wing. Aileron span 20 inches. Aileron chord varying. Aileron down

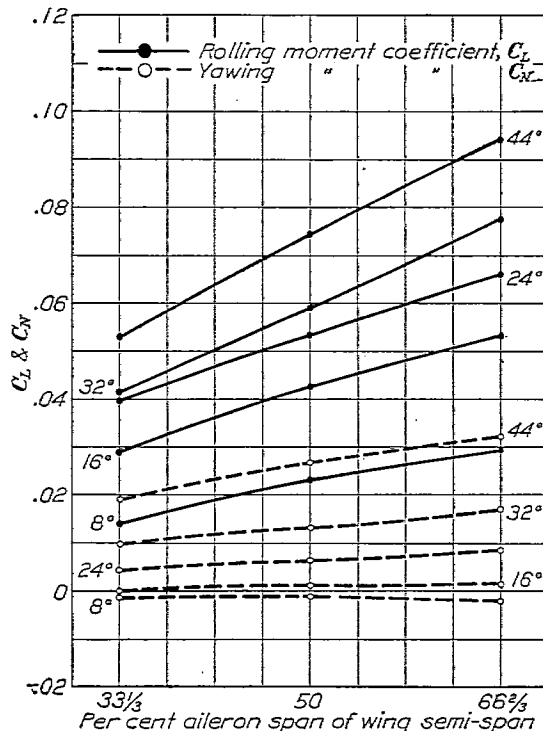

FIG. 18.—U. S. A. 27 wing. Aileron span 20 inches. Aileron chord varying. Aileron up

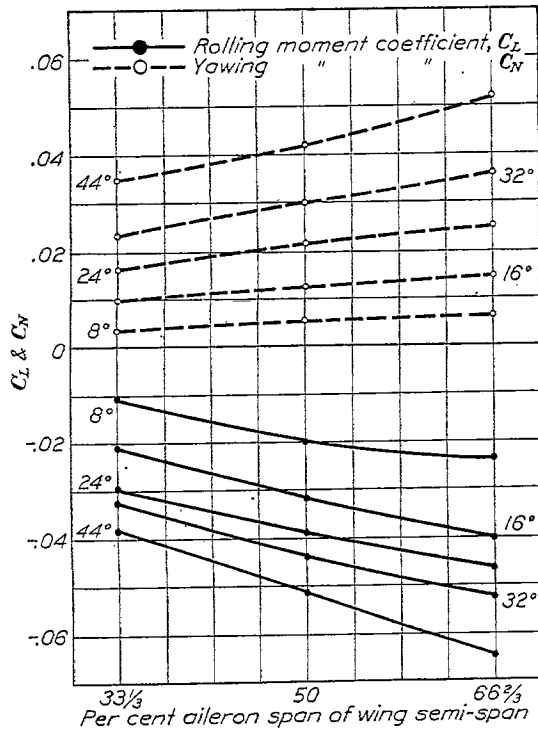

FIG. 19.—U. S. A. 27 wing. Aileron span varying. Aileron chord 2.5 inches. Aileron down

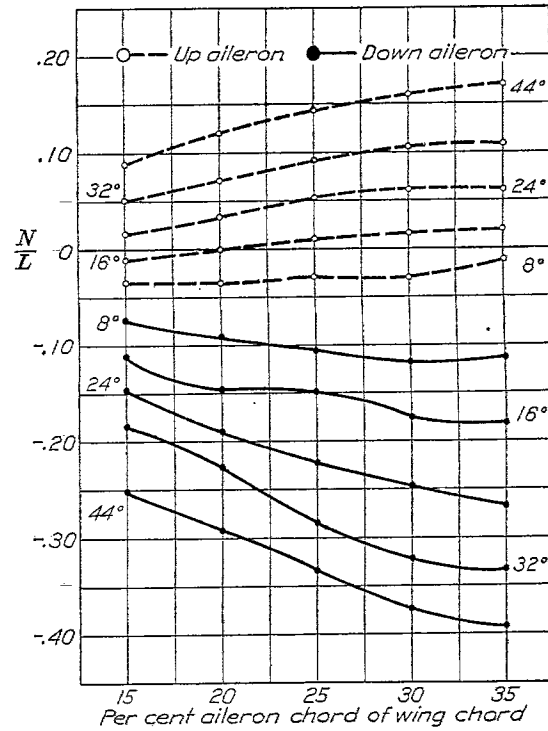

FIG. 20.—U. S. A. 27 wing. Aileron span 20 inches. Aileron chord varying. $N/L=0.417 C_N/C_L$

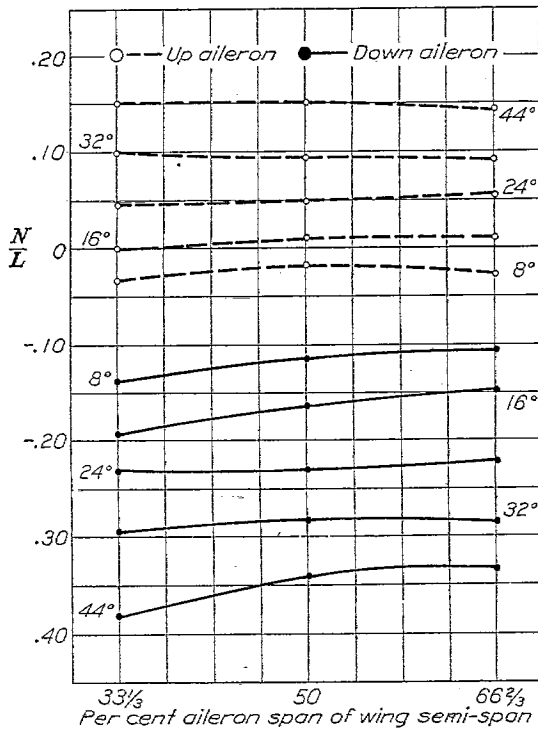

FIG. 21.—U. S. A. 27 wing. Aileron span varying. Aileron chord 2.5 inches. $N/L=0.417 C_N/C_L$

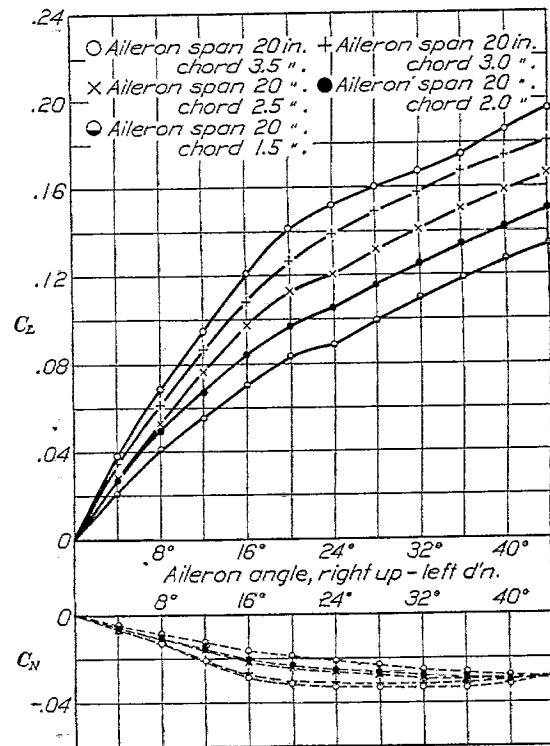

FIG. 22.—Clark Y wing. Combined rolling and yawing moment coefficients. $N/L=0.417 C_N/C_L$

span of the aileron results in relatively small changes in the ratio $\frac{C_L \text{ up}}{C_L \text{ down}}$ for corresponding aileron angles. Relationships of the same order occur in the case of the U. S. A. 27 wing.

Comparison of the curves and tables will show that the differences in the rolling moments produced by ailerons of the same size on the two wings are not great. In general, an aileron on the Clark Y wing shows slightly greater rolling moment than the corresponding aileron on the U. S. A. 27 wing for the same setting.

There appears to be no systematic relationship between aileron dimension and rolling moment except that an increased rolling moment accompanies an increase in aileron span or chord, the angle being held constant. In some cases an approximately linear relationship between the two quantities is indicated.

YAWING MOMENT COEFFICIENTS

Coincident with the increase of the rolling moment coefficient as the aileron chord is increased there is an increase in the yawing moment coefficient. In the case of the Clark Y wing with an aileron chord 15 per cent of the wing chord the ratio $\frac{C_N \text{ up}}{C_N \text{ down}}$ is 0.28 for an aileron angle of 44°. This ratio increases to 0.62 for the aileron whose chord is 35 per cent of the wing chord.

The ratio $\frac{C_N \text{ up}}{C_N \text{ down}}$ decreases in value as the aileron chord is increased, for small angles, and increases as the chord is increased, for large angles, the minimum value occurring in the neighborhood of 20°, depending on the wing section and the dimensions of the aileron.

In all cases a slightly negative yawing moment occurs in the case of both wings for aileron angles below 12°. The angle of zero yawing moment changes somewhat, decreasing as the aileron chord is increased. The effect is more marked in the case of the Clark Y wing, where the angle of the aileron for zero yawing moment is 26° when the aileron chord length is 15 per cent of the chord length of the wing. When the aileron chord length is increased to 35 per cent of that of the wing, the angle of zero yawing moment is decreased to 18°. For the same range of variation in aileron chord length on the U. S. A. 27 wing, the angle of the aileron for zero yawing moment decreases from 20° to 11°.

Within the limits of this investigation the ailerons on both wings show an approximately linear relationship between yawing moment coefficient and aileron chord. The relationship between yawing moment coefficient and aileron span is also approximately linear.

RATIO OF $\frac{\text{YAWING MOMENT}}{\text{ROLLING MOMENT}}$

Inspection of the curves² for $\frac{N}{L}$ (figs. 14, 15, 20, 21) shows that the down aileron is the greater contributing factor to the net yawing moment. The difference is most marked in the case of the Clark Y wing (fig. 14), where the maximum value for $\frac{N}{L}$ with the aileron up is 0.15, approximately the same as the minimum value with the aileron down.

There appears to be no systematic variation of $\frac{N}{L}$ with span. The magnitude of the variations in $\frac{N}{L}$ due to changes in span are small in comparison with those due to changes in chord length.

There is a more nearly linear relationship between $\frac{N}{L}$ and aileron chord or span for both wings in the case of the up aileron.

COMBINED COEFFICIENTS

The values given in Tables I-IV for one aileron in corresponding up and down positions have been combined in Tables V-VIII and are shown plotted in Figures 22-25.

² Note that $\frac{N}{L} = 0.417 \frac{C_N}{C_L}$ due to the differences in the factors *b* and *f* in the rolling and yawing moment equations.

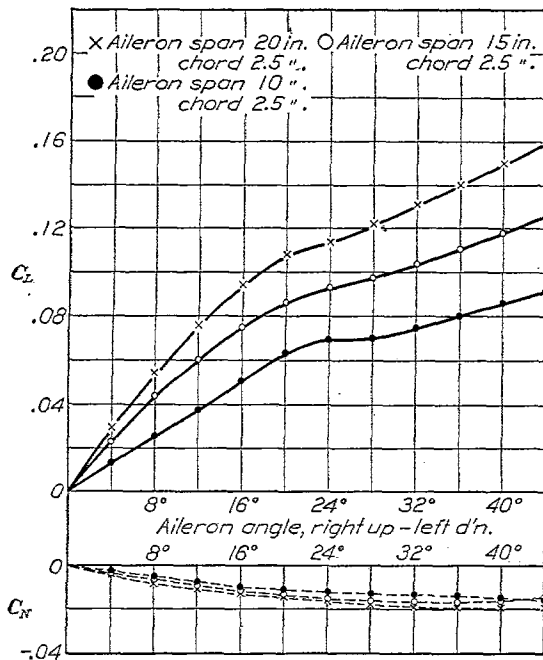

FIG. 23.—Clark Y wing. Combined rolling and yawing moment coefficients. $N/L=0.417 C_N/C_L$

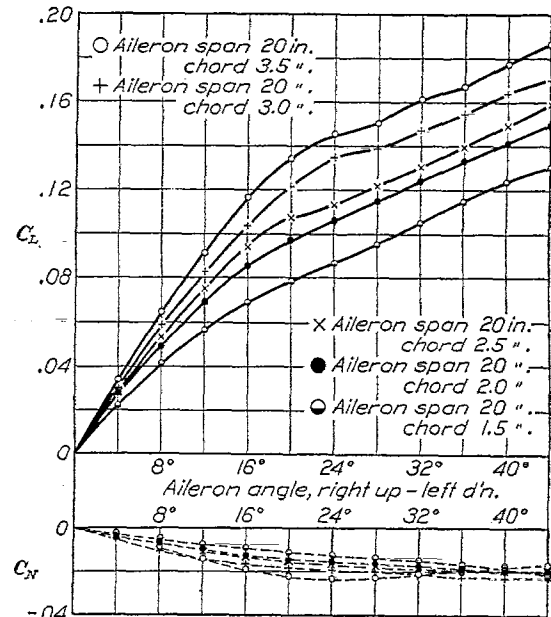

FIG. 24.—U. S. A. 27 wing. Combined rolling and yawing moment coefficients. $N/L=0.417 C_N/C_L$

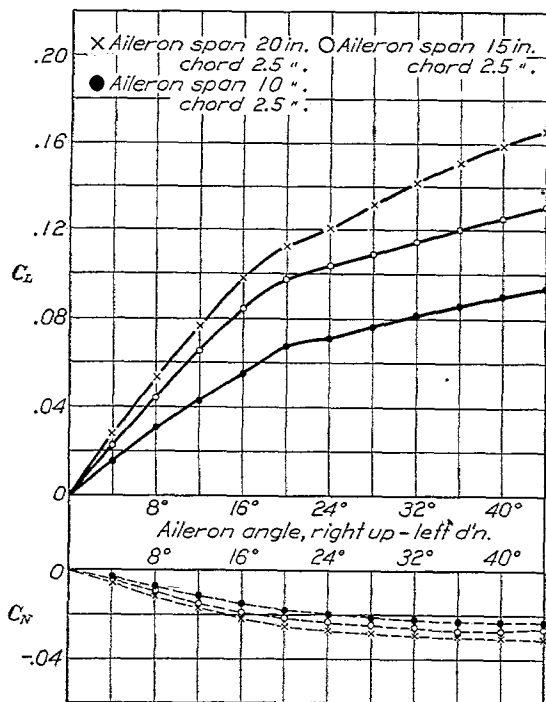

FIG. 25.—U. S. A. 27 wing. Combined rolling and yawing moment coefficients. $N/L=0.417 C_N/C_L$

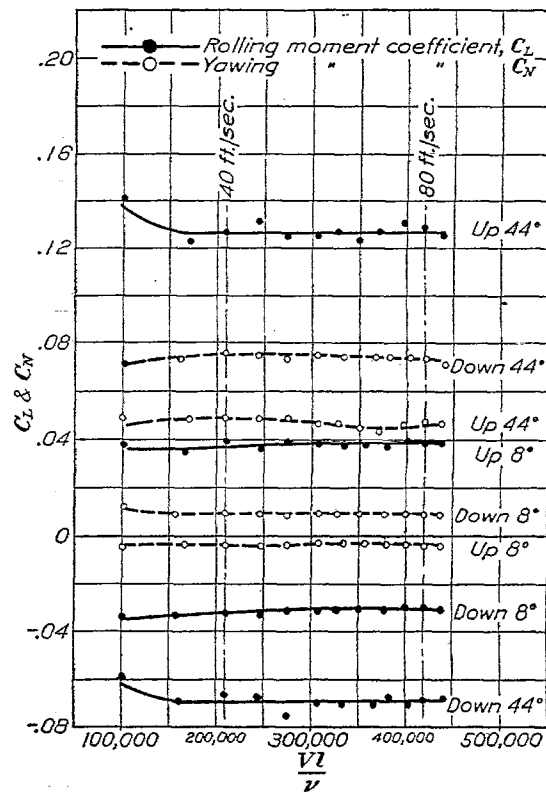

FIG. 26.—Clark Y wing. Aileron span 20 inches. Aileron chord 3.5 inches. Scale effect

There is a continued increase in the value of the combined rolling moment coefficient up to 44° aileron and a decrease in slope of the curves in the neighborhood of 20°.

The curves of combined yawing moment coefficients indicate a tendency toward a common value in the neighborhood of 44°.

SCALE EFFECT

Measurements were made for speeds ranging from 20 feet per second to slightly above 80 feet per second on both airfoils and for aileron settings of 8° and 44° up and down. The values of rolling and yawing moment coefficients are shown plotted against Reynolds Number in Figures 26 and 27. The scale effect is slight within the limits of this investigation, the maximum being of the order of 2 per cent.

CONCLUSIONS

The greater rolling moment is produced by the up aileron, the magnitude of the ratio $\frac{C_L \text{ up}}{C_L \text{ down}}$ varying from 1.02 to 1.85, depending on the wing section and the angle and dimensions of the aileron.

There is a slightly negative yawing moment due to the up aileron, which may persist to angles in the neighborhood of 24° (depending on the aileron dimensions and angle) before becoming positive.

The rolling and yawing moment coefficients due to one aileron show a fairly uniform increase with chord or span as the aileron angle is increased to 44°.

The effect of rounding the wing corners to a radius equal to 15 per cent of the chord length of the wing is slight in the cases of both rolling and yawing moments.

The effect of scale on rolling and yawing moments is small between Reynolds Numbers of 200,000 and 440,000.

There is a region of unstable flow set up about the ailerons when inclined at angles to the wing chord in the neighborhood of 20°. The effect is much more marked on the rolling moment than on the yawing moment and is usually more marked in the case of the up aileron.

The occurrence of larger rolling moments and smaller yawing moments in the case of the up aileron suggests the possibility of control by means of large ailerons working through a small range of angles in the up direction. Sufficient control could doubtless be obtained, but whether the proposition would be practicable from a structural standpoint is open to question.

We wish to point out in conclusion that the preceding statements apply only to level flight at a small angle of attack of the wing. The effect of increasing the angle of attack is to modify greatly the relations shown previously, especially in the neighborhood of the stalling angle, as will be shown in a subsequent report.

ACKNOWLEDGMENT

The authors wish to acknowledge with thanks the assistance of Messrs. B. H. Monish, W. Hunter Boyd, and P. S. Ballif in this investigation and to express appreciation to Mr. W. H. King for his painstaking workmanship on the exceptionally large models.

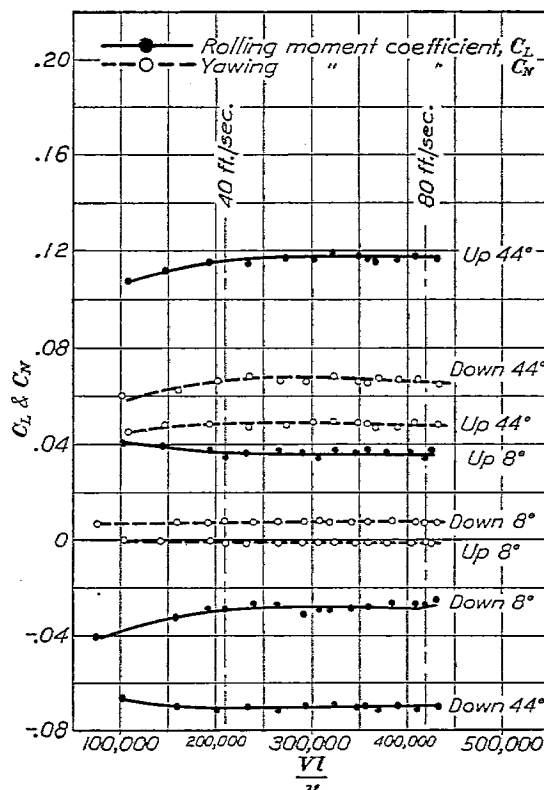

FIG. 27.—U. S. A. 27 wing. Aileron span 20 inches. Aileron chord 3.5 inches. Scale effect

BIBLIOGRAPHY

- Reference 1. Archer, Lieut. C. E.: Wind Tunnel Test of Aileron Characteristics as Affected by Design and by Airfoil Thickness. Air Corps Information Circular No. 535, Sept. 1, 1925.
- Reference 2. Irving, H. B., Ower, E., and Hankins, G. A.: An Investigation of the Aerodynamic Properties of Wing Ailerons. Part I.—The Effect of Variation of Plan Form of Wing Tip and of Span of Aileron. British Reports & Memoranda No. 550, October, 1918.
- Irving, H. B., and Ower, E.: An Investigation of the Aerodynamic Properties of Wing Ailerons. Part II.—The Effect of Variation of Chord of Aileron. The Effect of "Wash-Out" on Ailerons. Tests on Ailerons of the "Panther" Type in which the Ailerons Do Not Extend to the Wing Tips. Effect of Variation in Taper Toward the Tips for Wings of given Plan Form. British Reports & Memoranda No. 615, June, 1919.
- Reference 3. National Advisory Committee for Aeronautics: Aerodynamic Characteristics of Airfoils—IV. Technical Report No. 244. N. A. C. A. Sept. 1926.

TABLE I.—CLARK Y WING SECTION— C_L AND C_N FOR ONE AILERON

[Varying chord of aileron. Angle of attack of airplane, 0°; angle of attack of wing, +4°; angle of yaw, 0°; angle of roll, 0°]

NOTE.—The values apply to either right or left aileron; the signs refer to the right aileron

AILERON SPAN, 20 INCHES

1.5-inch chord					2.0-inch chord				
θ	Aileron up		Aileron down		θ	Aileron up		Aileron down	
	C_L	C_N	C_L	C_N		C_L	C_N	C_L	C_N
0°	0	0	0	0	0°	0	0	0	0
4°	+ .0115	— .0020	— .0090	+ .0028	4°	+ .0150	— .0024	— .0120	+ .0040
8°	+ .0235	— .0035	— .0173	+ .0057	8°	+ .0280	— .0035	— .0212	+ .0076
12°	+ .0305	— .0042	— .0249	+ .0090	12°	+ .0382	— .0040	— .0290	+ .0125
16°	+ .0390	— .0040	— .0313	+ .0125	16°	+ .0470	— .0038	— .0370	+ .0170
20°	+ .0465	— .0029	— .0370	+ .0163	20°	+ .0545	— .0020	— .0430	+ .0215
24°	+ .0465	— .0011	— .0420	+ .0203	24°	+ .0614	+ .0008	— .0436	+ .0262
28°	+ .0530	+ .0008	— .0465	+ .0243	28°	+ .0678	+ .0040	— .0479	+ .0307
32°	+ .0595	+ .0030	— .0503	+ .0285	32°	+ .0730	+ .0070	— .0519	+ .0353
36°	+ .0646	+ .0057	— .0538	+ .0328	36°	+ .0785	+ .0110	— .0555	+ .0400
40°	+ .0691	+ .0085	— .0580	+ .0371	40°	+ .0830	+ .0148	— .0589	+ .0450
44°	+ .0730	+ .0114	— .0610	+ .0415	44°	+ .0876	+ .0190	— .0618	+ .0500

3.0-inch chord					3.5-inch chord				
θ	Aileron up		Aileron down		θ	Aileron up		Aileron down	
	C_L	C_N	C_L	C_N		C_L	C_N	C_L	C_N
0°	0	0	0	0	0°	0	0	0	0
4°	+ .0185	— .0027	— .0160	+ .0038	4°	+ .0194	— .0025	— .0185	+ .0043
8°	+ .0350	— .0041	— .0270	+ .0092	8°	+ .0380	— .0040	— .0306	+ .0095
12°	+ .0520	— .0041	— .0350	+ .0165	12°	+ .0550	— .0038	— .0402	+ .0175
16°	+ .0670	— .0028	— .0413	+ .0235	16°	+ .0730	— .0020	— .0481	+ .0265
20°	+ .0800	+ .0003	— .0472	+ .0305	20°	+ .0890	+ .0023	— .0530	+ .0340
24°	+ .0860	+ .0062	— .0525	+ .0372	24°	+ .0960	+ .0078	— .0560	+ .0408
28°	+ .0920	+ .0121	— .0570	+ .0438	28°	+ .1000	+ .0139	— .0595	+ .0475
32°	+ .0970	+ .0182	— .0606	+ .0500	32°	+ .1040	+ .0210	— .0631	+ .0541
36°	+ .1030	+ .0244	— .0640	+ .0560	36°	+ .1090	+ .0273	— .0655	+ .0610
40°	+ .1080	+ .0304	— .0665	+ .0612	40°	+ .1180	+ .0363	— .0673	+ .0680
44°	+ .1120	+ .0365	— .0686	+ .0661	44°	+ .1270	+ .0460	— .0686	+ .0748

ROLLING AND YAWING MOMENTS IN LEVEL FLIGHT

TABLE II.—CLARK Y WING SECTION— C_L AND C_N FOR ONE AILERON

[Varying span of aileron. Angle of attack of airplane, 0° ; angle of attack of wing, $\pm 4^\circ$; angle of yaw, 0° ; angle of roll, 0°]

NOTE.—The values apply to either right or left aileron; the signs refer to the right aileron

AILERON CHORD, 2.5 INCHES

10-inch span					15-inch span				
θ	Aileron up		Aileron down		θ	Aileron up		Aileron down	
	C_L	C_N	C_L	C_N		C_L	C_N	C_L	C_N
0°	0	0	0	0	0°	0	0	0	0
4°	+.0080	-.0013	-.0078	+.0022	4°	+.0115	-.0021	-.0110	+.0020
8°	+.0153	-.0018	-.0150	+.0054	8°	+.0230	-.0035	-.0210	+.0055
12°	+.0226	-.0018	-.0204	+.0093	12°	+.0345	-.0033	-.0300	+.0111
16°	+.0300	-.0012	-.0250	+.0133	16°	+.0450	-.0022	-.0395	+.0165
20°	+.0390	-.0002	-.0286	+.0173	20°	+.0550	0	-.0425	+.0212
24°	+.0410	+.0018	-.0300	+.0211	24°	+.0600	+.0035	-.0432	+.0262
28°	+.0435	+.0041	-.0333	+.0250	28°	+.0625	+.0068	-.0461	+.0310
32°	+.0460	+.0068	-.0356	+.0288	32°	+.0650	+.0104	-.0492	+.0360
36°	+.0485	+.0096	-.0372	+.0320	36°	+.0680	+.0140	-.0520	+.0410
40°	+.0508	+.0125	-.0389	+.0356	40°	+.0710	+.0181	-.0541	+.0450
44°	+.0530	+.0155	-.0400	+.0385	44°	+.0750	+.0225	-.0556	+.0485

20-inch span				
θ	Aileron up		Aileron down	
	C_L	C_N	C_L	C_N
0°	0	0	0	0
4°	+.0150	-.0020	-.0125	+.0035
8°	+.0300	-.0040	-.0230	+.0078
12°	+.0440	-.0030	-.0325	+.0131
16°	+.0570	-.0025	-.0410	+.0190
20°	+.0675	-.0002	-.0450	+.0248
24°	+.0730	+.0038	-.0475	+.0308
28°	+.0775	+.0080	-.0540	+.0362
32°	+.0810	+.0126	-.0598	+.0420
36°	+.0870	+.0175	-.0632	+.0474
40°	+.0925	+.0220	-.0658	+.0528
44°	+.0985	+.0270	-.0670	+.0580

REPORT NATIONAL ADVISORY COMMITTEE FOR AERONAUTICS

TABLE III.—U. S. A. 27 WING SECTION— C_L AND C_N FOR ONE AILERON

[Varying chord of aileron. Angle of attack of airplane, 0° ; angle of attack of wing, $+4^\circ$; angle of yaw, 0° ; angle of roll, 0°]

NOTE.—The values apply to either right or left aileron; the signs refer to the right aileron

AILERON SPAN, 20 INCHES

1.5-inch chord					2.0-inch chord				
θ	Aileron up		Aileron down		θ	Aileron up		Aileron down	
	C_L	C_N	C_L	C_N		C_L	C_N	C_L	C_N
0°	0	0	0	0	0°	0	0	0	0
4°	+ .0126	- .0012	- .0098	+ .0015	4°	+ .0155	- .0015	- .0120	+ .0018
8°	+ .0230	- .0020	- .0180	+ .0032	8°	+ .0285	- .0024	- .0200	+ .0044
12°	+ .0320	- .0018	- .0242	+ .0055	12°	+ .0405	- .0012	- .0290	+ .0085
16°	+ .0390	- .0010	- .0300	+ .0080	16°	+ .0495	0	- .0355	+ .0125
20°	+ .0430	0	- .0355	+ .0110	20°	+ .0560	+ .0022	- .0405	+ .0165
24°	+ .0460	+ .0018	- .0402	+ .0142	24°	+ .0605	+ .0050	- .0450	+ .0205
28°	+ .0505	+ .0040	- .0450	+ .0180	28°	+ .0645	+ .0083	- .0500	+ .0247
32°	+ .0560	+ .0067	- .0490	+ .0217	32°	+ .0695	+ .0120	- .0542	+ .0295
36°	+ .0615	+ .0094	- .0530	+ .0262	36°	+ .0745	+ .0152	- .0584	+ .0342
40°	+ .0672	+ .0120	- .0565	+ .0311	40°	+ .0795	+ .0195	- .0614	+ .0395
44°	+ .0710	+ .0150	- .0595	+ .0360	44°	+ .0855	+ .0245	- .0640	+ .0450

3.0-inch chord					3.5-inch chord				
θ	Aileron up		Aileron down		θ	Aileron up		Aileron down	
	C_L	C_N	C_L	C_N		C_L	C_N	C_L	C_N
0°	0	0	0	0	0°	0	0	0	0
4°	+ .0155	- .0020	- .0145	+ .0035	4°	+ .0177	- .0010	- .0159	+ .0035
8°	+ .0310	- .0022	- .0280	+ .0080	8°	+ .0353	- .0010	- .0290	+ .0079
12°	+ .0460	- .0010	- .0368	+ .0130	12°	+ .0510	+ .0004	- .0405	+ .0149
16°	+ .0600	+ .0022	- .0435	+ .0185	16°	+ .0655	+ .0033	- .0510	+ .0222
20°	+ .0720	+ .0065	- .0495	+ .0250	20°	+ .0790	+ .0076	- .0553	+ .0298
24°	+ .0825	+ .0120	- .0525	+ .0312	24°	+ .0890	+ .0130	- .0560	+ .0360
28°	+ .0860	+ .0175	- .0530	+ .0372	28°	+ .0961	+ .0195	- .0545	+ .0419
32°	+ .0904	+ .0230	- .0568	+ .0440	32°	+ .1016	+ .0265	- .0595	+ .0476
36°	+ .0945	+ .0280	- .0608	+ .0500	36°	+ .1058	+ .0335	- .0617	+ .0533
40°	+ .0985	+ .0335	- .0660	+ .0558	40°	+ .1116	+ .0406	- .0660	+ .0592
44°	+ .1020	+ .0390	- .0685	+ .0615	44°	+ .1180	+ .0477	- .0690	+ .0650

ROLLING AND YAWING MOMENTS IN LEVEL FLIGHT

TABLE IV.—U. S. A. 27 WING SECTION— C_L AND— C_N FOR ONE AILERON

[Varying span of aileron. Angle of attack of airplane, 0° ; angle of attack of wing, $\pm 4^\circ$; angle of yaw, 0° ; angle of roll, 0°]

NOTE.—The values apply to either right or left aileron; the signs refer to the right aileron

AILERON CHORD 2.5 INCHES

10-inch span					15-inch span				
θ	Aileron up		Aileron down		θ	Aileron up		Aileron down	
	C_L	C_N	C_L	C_N		C_L	C_N	C_L	C_N
0°	0	0	0	0	0°	0	0	0	0
4°	+ .0069	- .0009	- .0055	+ .0015	4°	+ .0120	- .0010	- .0100	+ .0025
8°	+ .0140	- .0011	- .0108	+ .0036	8°	+ .0230	- .0010	- .0200	+ .0055
12°	+ .0211	- .0010	- .0161	+ .0065	12°	+ .0330	- .0004	- .0268	+ .0090
16°	+ .0290	0	- .0211	+ .0098	16°	+ .0426	+ .0010	- .0318	+ .0127
20°	+ .0375	+ .0021	- .0257	+ .0130	20°	+ .0500	+ .0036	- .0358	+ .0171
24°	+ .0397	+ .0044	- .0295	+ .0163	24°	+ .0534	+ .0063	- .0390	+ .0218
28°	+ .0385	+ .0069	- .0310	+ .0198	28°	+ .0557	+ .0095	- .0414	+ .0260
32°	+ .0412	+ .0098	- .0328	+ .0232	32°	+ .0590	+ .0131	- .0440	+ .0300
36°	+ .0450	+ .0128	- .0348	+ .0270	36°	+ .0630	+ .0172	- .0465	+ .0343
40°	+ .0490	+ .0159	- .0368	+ .0310	40°	+ .0685	+ .0219	- .0490	+ .0382
44°	+ .0530	+ .0191	- .0382	+ .0350	44°	+ .0745	+ .0269	- .0514	+ .0420

20-inch span				
θ	Aileron up		Aileron down	
	C_L	C_N	C_L	C_N
0°	0	0	0	0
4°	+ .0155	- .0018	- .0129	+ .0025
8°	+ .0296	- .0020	- .0238	+ .0061
12°	+ .0420	- .0010	- .0330	+ .0101
16°	+ .0535	+ .0013	- .0405	+ .0145
20°	+ .0630	+ .0049	- .0445	+ .0196
24°	+ .0660	+ .0085	- .0468	+ .0250
28°	+ .0720	+ .0124	- .0494	+ .0304
32°	+ .0775	+ .0170	- .0526	+ .0360
36°	+ .0830	+ .0217	- .0568	+ .0412
40°	+ .0886	+ .0270	- .0610	+ .0465
44°	+ .0940	+ .0322	- .0650	+ .0520

TABLE V.—CLARK Y WING SECT VALUES OF C_L AND C_N , RIGHT AILERON DOWN

[Varying chord of aileron. Angle of attack of airplane, 0° ; angle of attack of wing, $+4^\circ$; angle of yaw, 0° ; angle of roll, 0°]

AILERON SPAN, 20 INCHES

1.5-inch chord			2.0-inch chord			3.0-inch chord			3.5-inch chord		
θ	C_L	C_N	θ	C_L	C_N	θ	C_L	C_N	θ	C_L	C_N
0°	0	0	0°	0	0	0°	0	0	0°	0	0
4°	+ .0205	- .0048	4°	+ .0270	- .0064	4°	+ .0345	- .0065	4°	+ .0379	- .0068
8°	+ .0408	- .0092	8°	+ .0492	- .0111	8°	+ .0620	- .0133	8°	+ .0686	- .0135
12°	+ .0554	- .0132	12°	+ .0672	- .0165	12°	+ .0870	- .0206	12°	+ .0952	- .0213
16°	+ .0703	- .0165	16°	+ .0840	- .0208	16°	+ .1083	- .0263	16°	+ .1211	- .0285
20°	+ .0835	- .0192	20°	+ .0975	- .0235	20°	+ .1272	- .0302	20°	+ .1420	- .0317
24°	+ .0885	- .0214	24°	+ .1050	- .0254	24°	+ .1385	- .0310	24°	+ .1520	- .0330
28°	+ .0995	- .0235	28°	+ .1157	- .0267	28°	+ .1490	- .0317	28°	+ .1595	- .0336
32°	+ .1098	- .0255	32°	+ .1249	- .0283	32°	+ .1576	- .0318	32°	+ .1671	- .0331
36°	+ .1184	- .0271	36°	+ .1340	- .0290	36°	+ .1670	- .0316	36°	+ .1745	- .0337
40°	+ .1271	- .0286	40°	+ .1419	- .0302	40°	+ .1745	- .0308	40°	+ .1853	- .0317
44°	+ .1340	- .0301	44°	+ .1494	- .0310	44°	+ .1806	- .0296	44°	+ .1956	- .0288

TABLE VI.—CLARK Y WING SECTION—COMBINED VALUES OF C_L AND C_N , RIGHT AILERON UP, LEFT AILERON DOWN

[Varying span of aileron. Angle of attack of airplane, 0° ; angle of attack of wing, $+4^\circ$; angle of yaw, 0° ; angle of roll, 0°]

AILERON CHORD, 2.5 INCHES

10-inch span			15-inch span			20-inch span		
θ	C_L	C_N	θ	C_L	C_N	θ	C_L	C_N
0°	0	0	0°	0	0	0°	0	0
4°	+ .0158	- .0035	4°	+ .0225	- .0041	4°	+ .0275	- .0055
8°	+ .0303	- .0072	8°	+ .0440	- .0090	8°	+ .0530	- .0118
12°	+ .0430	- .0113	12°	+ .0645	- .0144	12°	+ .0765	- .0161
16°	+ .0550	- .0145	16°	+ .0845	- .0187	16°	+ .0980	- .0215
20°	+ .0676	- .0175	20°	+ .0975	- .0212	20°	+ .1125	- .0250
24°	+ .0710	- .0193	24°	+ .1032	- .0227	24°	+ .1205	- .0270
28°	+ .0765	- .0209	28°	+ .1086	- .0242	28°	+ .1315	- .0282
32°	+ .0816	- .0220	32°	+ .1142	- .0254	32°	+ .1408	- .0294
36°	+ .0857	- .0224	36°	+ .1200	- .0270	36°	+ .1502	- .0299
40°	+ .0897	- .0231	40°	+ .1251	- .0269	40°	+ .1583	- .0306
44°	+ .0930	- .0230	44°	+ .1306	- .0260	44°	+ .1655	- .0310

ROLLING AND YAWING MOMENTS IN LEVEL FLIGHT

TABLE VII.—U. S. A. 27 WING SECTION—COMBINED VALUES OF C_L AND C_N , RIGHT AILERON UP, LEFT AILERON DOWN

[Varying chord of aileron. Angle of attack of airplane, 0° ; angle of attack of wing, $+4^\circ$; angle of yaw, 0° ; angle of roll, 0°]
 AILERON SPAN, 20 INCHES

1.5-inch chord			2.0-inch chord			3.0-inch chord			3.5-inch chord		
θ	C_L	C_N	θ	C_L	C_N	θ	C_L	C_N	θ	C_L	C_N
0°	0	0	0°	0	0	0°	0	0	0°	0	0
4°	+ .0224	-. 0027	4°	+ .0275	-. 0033	4°	+ .0300	-. 0055	4°	+ .0336	-. 0045
8°	+ .0410	-. 0052	8°	+ .0485	-. 0068	8°	+ .0590	-. 0102	8°	+ .0643	-. 0089
12°	+ .0562	-. 0073	12°	+ .0695	-. 0097	12°	+ .0828	-. 0140	12°	+ .0915	-. 0145
16°	+ .0690	-. 0090	16°	+ .0850	-. 0125	16°	+ .1035	-. 0163	16°	+ .1165	-. 0189
20°	+ .0785	-. 0110	20°	+ .0965	-. 0143	20°	+ .1215	-. 0185	20°	+ .1343	-. 0222
24°	+ .0862	-. 0124	24°	+ .1055	-. 0155	24°	+ .1350	-. 0192	24°	+ .1450	-. 0230
28°	+ .0955	-. 0140	28°	+ .1145	-. 0164	28°	+ .1390	-. 0197	28°	+ .1506	-. 0224
32°	+ .1050	-. 0150	32°	+ .1237	-. 0175	32°	+ .1472	-. 0210	32°	+ .1611	-. 0211
36°	+ .1145	-. 0168	36°	+ .1329	-. 0190	36°	+ .1553	-. 0220	36°	+ .1675	-. 0198
40°	+ .1237	-. 0191	40°	+ .1409	-. 0200	40°	+ .1645	-. 0223	40°	+ .1776	-. 0186
44°	+ .1305	-. 0210	44°	+ .1495	-. 0205	44°	+ .1705	-. 0225	44°	+ .1870	-. 0173

TABLE VIII.—U. S. A. 27 WING SECTION—COMBINED VALUES OF C_L AND C_N , RIGHT AILERON UP, LEFT AILERON DOWN

[Varying span of aileron. Angle of attack of airplane, 0° ; angle of attack of wing, $+4^\circ$; angle of yaw, 0° ; angle of roll, 0°]
 AILERON CHORD, 2.5 INCHES

10-inch span			15-inch span			20-inch span		
θ	C_L	C_N	θ	C_L	C_N	θ	C_L	C_N
0°	0	0	0°	0	0	0°	0	0
4°	+ .0124	-. 0024	4°	+ .0220	-. 0035	4°	+ .0284	-. 0043
8°	+ .0248	-. 0047	8°	+ .0430	-. 0065	8°	+ .0533	-. 0081
12°	+ .0372	-. 0076	12°	+ .0598	-. 0094	12°	+ .0750	-. 0111
16°	+ .0501	-. 0098	16°	+ .0744	-. 0117	16°	+ .0940	-. 0132
20°	+ .0632	-. 0109	20°	+ .0858	-. 0135	20°	+ .1075	-. 0150
24°	+ .0692	-. 0119	24°	+ .0924	-. 0155	24°	+ .1128	-. 0165
28°	+ .0695	-. 0129	28°	+ .0971	-. 0165	28°	+ .1214	-. 0180
32°	+ .0740	-. 0134	32°	+ .1030	-. 0169	32°	+ .1301	-. 0190
36°	+ .0798	-. 0142	36°	+ .1095	-. 0171	36°	+ .1393	-. 0195
40°	+ .0858	-. 0151	40°	+ .1175	-. 0163	40°	+ .1496	-. 0195
44°	+ .0912	-. 0159	44°	+ .1259	-. 0151	44°	+ .1590	-. 0198