

REPORT No. 441

A FLIGHT INVESTIGATION OF THE SPINNING OF THE NY-1 AIRPLANE WITH VARIED MASS DISTRIBUTION AND OTHER MODIFICATIONS, AND AN ANALYSIS BASED ON WIND-TUNNEL TESTS

By NATHAN F. SCUDDER

SUMMARY

This report presents the results of an investigation of the spinning characteristics of the NY-1 naval training biplane. The results of flight tests and an analysis based on wind-tunnel test data are given and compared. The primary purpose of the investigation was the determination in flight of the effect of changes in mass distribution along the longitudinal axis, without change of mass quantity or centroid. Other effects were also investigated, such as those due to wing loading, center-of-gravity position, dihedral of wings, control setting, and the removal of a large portion of the fabric from the fin and rudder. The wind-tunnel test results used in the numerical analysis were obtained in the 7 by 10 foot wind tunnel through an angle-of-attack range of 90°.

The effect of varied mass distribution was to decrease the angle of attack and the linear and angular velocities, as ballast was moved from the center of gravity to the nose and tail of the airplane, without shift of centroid. Moderate changes in wing loading and dihedral of the wings and comparatively large changes in center-of-gravity position have small effects on the spin under the conditions of the tests. Different settings of ailerons and elevator altered the nature of the spin but did not bring about recovery, which was effected only by the rudder. The tests showed that full-down deflection of the elevator alone increased the rate of rotation, indicating that recoveries could best be made by using the rudder before moving the elevator down. Removal of a large portion of the fin and rudder covering (above the stabilizer and elevator) had no appreciable effect on the spin. A reasonable agreement was obtained between flight results and a numerical analysis, although the method of the analysis neglected many of the minor factors that us ally are thought to influence the spin.

INTRODUCTION

The control of the spinning of airplanes is one of the important unsolved problems of the general subject of safety in flying. It has been the subject of many

researches in recent years, some of which are listed in the bibliography appended to this report. In these investigations the problem has been attacked from several theoretical and experimental aspects. On the theoretical side, analyses of the conditions for equilibrium in the steady spin, stability in the spin, the effect of control forces, and the effect of several important airplane characteristics have been made. The experimental investigations include flight tests with airplanes, tests with free-flying models, and tests in wind tunnels of models of airplanes or airplane parts. During the course of the present investigation, results have appeared in the literature on spinning that effectively illuminate some of the important features of spinning; however, the problem will require much more quantitative and extensive data before a satisfactory solution can be evolved.

The National Advisory Committee for Aeronautics has been engaged for some time in a comprehensive investigation of spinning. One phase of the investigation has been a quantitative determination of the motion of airplanes during spins both in their normal conditions and after various significant changes in the properties of the airplane have been made. The first step in this work was the development of a satisfactorily accurate method of making measurements, which was reported in reference 1. The present report deals with the application of this method to a study of the spinning characteristics of the NY-1 airplane, the first to be studied extensively. The principal effect studied was that of changes in mass distribution along the longitudinal axis, but the effects of some minor aerodynamic changes were determined also.

In order to furnish a logical basis for studying the intricately related flight results, an analysis of the spin based on wind-tunnel measurements on a model was made. The wind-tunnel data employed were obtained with a stationary balance, and some of the moments were computed by the strip method. The method of analysis was the same as that followed in reference 2.

FLIGHT TESTS

APPARATUS AND METHOD

The airplane used in the investigation was that of reference 1—an NY-1 naval training biplane powered

was mounted at the center of gravity (actually slightly below it for reasons of convenience). The other two containers were mounted under the engine supports and in the tail of the fuselage, respectively. (Fig. 1.)

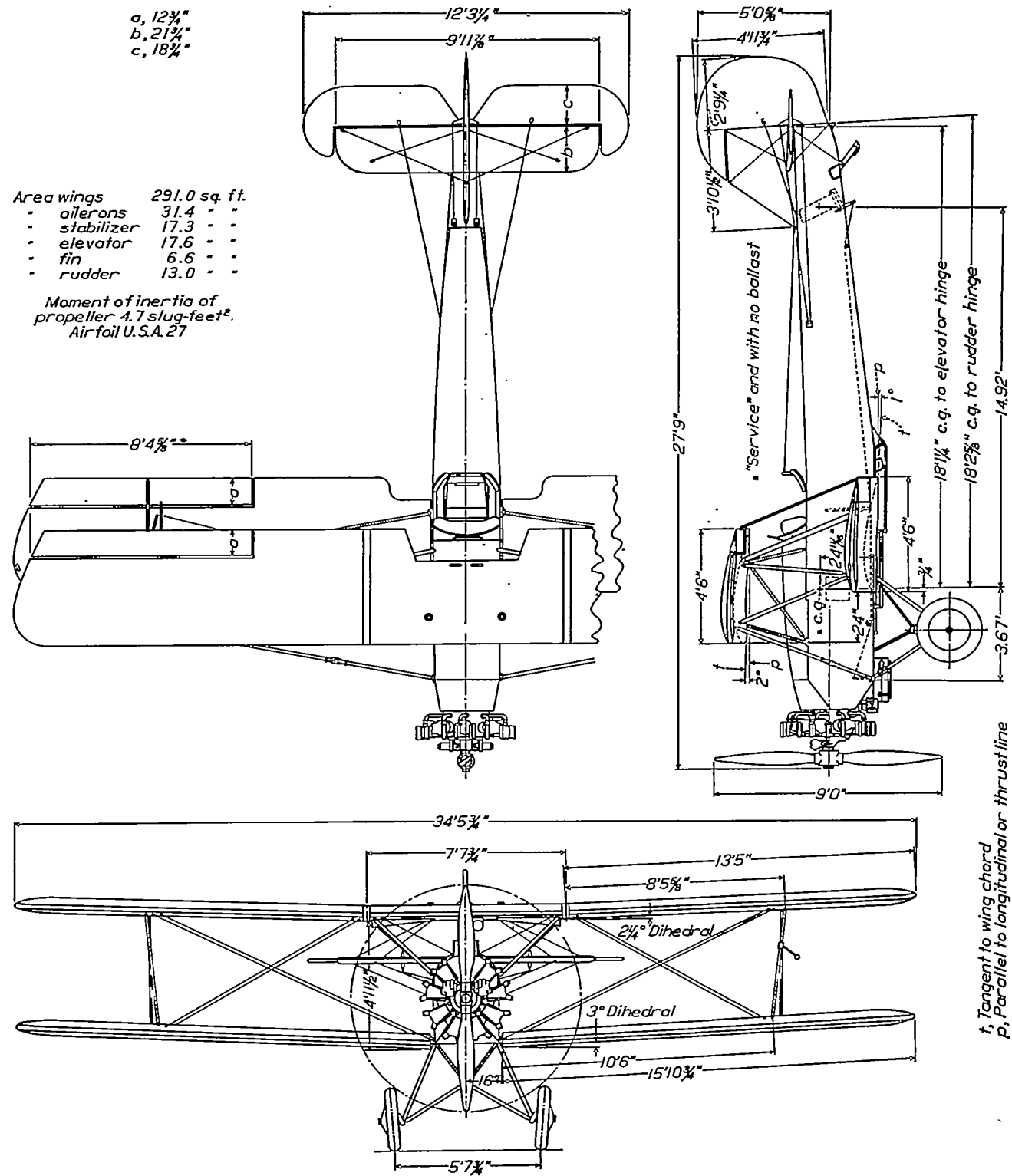

FIGURE 1.—Line drawing of the NY-1 airplane and arrangement of ballast containers and ballast-release gear

with a Wright J-5 engine. A line drawing giving its principal dimensions is shown in Figure 1.

Three ballast containers were required for the tests with varied mass distribution. The main container

The maximum capacity of the main container was 436 pounds of lead shot. The combined capacity of the other two containers was made equal to that of the container at the center of gravity and the capacities

of the individual containers were inversely proportional to their distances from the center of gravity. This arrangement made it possible to transfer ballast from the center of gravity to the nose and tail without altering the center-of-gravity position of the ballast. Latches and doors operated by a lever in the cockpit were provided on the front and rear containers so that their contents might be emptied quickly in a spin should an emergency requiring it arise. Such a necessity never occurred during the tests. Mass carried in these containers was used in determining the effect of different mass distributions with no change of center of gravity and for determining that of changes of center of gravity with changes of mass distribution.

The initial moments of inertia of the airplane with its test equipment installed were obtained by means of swinging tests. The virtual mass of the airplane under the conditions of the swinging tests was used in determining the moments of inertia, but no effort was made to compute the moments of inertia for the virtual mass corresponding to the air density and flow conditions of the spin, since the values thus computed would differ from the measured values by entirely negligible amounts.

Modifications were made to the airplane for the purpose of investigating the effect of changing the dihedral of the wings and the area of the empennage parts. The normal wing dihedral angles of 2.25° for the upper wing and 3.00° for the lower wing were changed to 0° for the upper and 1.25° for the lower, and to 4.17° for the upper and 4.60° for the lower wing. These modifications were accomplished by varying the lengths of the landing and the flying wires with no changes in the length of the struts. The resultant effect of these changes in the shape of the wing cellule can be readily appreciated by reference to Figure 1, in which the normal rigging is shown. The modifications to the empennage were accomplished by the removal of fabric covering to the extent shown in Figure 2. All of the fin covering and portions of the rudder and elevator covering were removed. The purpose of this modification to the empennage was to find to what degree the spinning characteristics of this airplane could be attributed to its unusually large tail surfaces.

Tests of the effect of control setting were made by recording steady spins with the ailerons fully deflected in each direction, in contrast to the neutral setting for all other tests, and with the elevator hard down instead of hard up. In making these tests, entry was effected in the usual manner, and after the spin had been started the control element was eased into the position for which the test was to be made. When steady motion had developed, the records were taken in the usual manner.

The instrument installation was essentially the same as that described in reference 1, consisting principally of three electrically driven gyroscopic angular-velocity

recorders, a 3-component accelerometer, and a sensitive altimeter. The quantities necessary for a complete determination of the motion of the airplane were measured with these instruments. For most of these tests the accelerometer was housed in an insulated box (all tests numbered higher than 40) that was held at constant temperature by a thermostatically controlled electric heater. Control of the operating temperature of this instrument eliminated temperature-effect errors and obviated the necessity for frequent changes of damping oil with changes of air temperature.

The accelerometer was placed as close to the center of gravity as possible, which was within a distance of 0.25 foot. Corrections to the accelerometer readings were not at first considered necessary, but after the flight tests had been completed it was thought advisable to make the correction to obtain forces acting at the center of gravity, especially because some of the tests

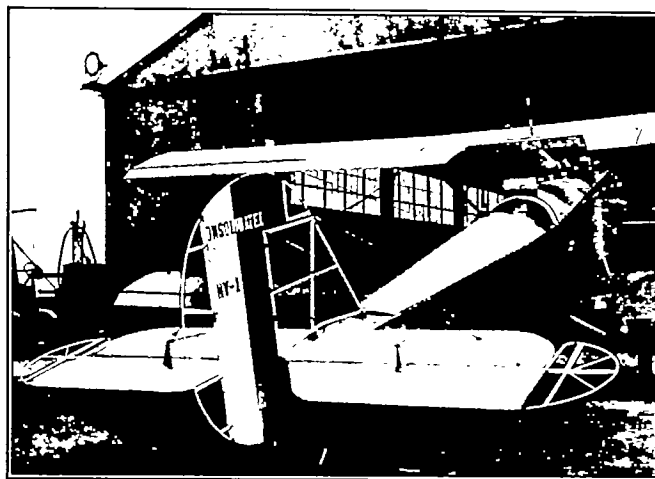

FIGURE 2.—Tail of the NY-1 airplane with fabric removed

involved changes in the center-of-gravity position. In order to make the correction, the coordinates of the accelerometer elements were needed, and in the absence of complete data the distances were estimated from partial data.

The method of making the flight tests and computing the results was the same as that described in reference 1 with the exception of the computation of the accelerometer-position correction just mentioned and that the virtual mass was used in computing the moments of inertia given in this report while it was not considered in the computations of reference 1.

RESULTS

Before presenting the results of the tests reported herein, a list of the symbols appearing in the text or tables which are not sufficiently defined on the covers of the report is given with definitions. A more extensive table of symbols and definitions may be found in the appendix of reference 1.

X'' , Y'' , Z'' , forces along ground axes.

p, q, r , components of angular velocity about airplane axes (based on the thrust line).

α , angle of attack referred to airplane X axis.

β , angle of sideslip (positive for outward sideslip).

ΔM , moment about airplane Y axis acting on propeller.

ΔN , moment about airplane Z axis acting on propeller.

$\Lambda = \frac{\Omega b}{2V}$ spin coefficient (Ω , resultant angular velocity).

C_x , tangential-force coefficient (airplane axes).

C_z , normal-force coefficient (airplane axes).

All the records were made at a mean standard altitude of 3,000 feet, hence the value of ρ used in computing the moment coefficients was 0.002176 slug per cubic foot. This value was used for all the other computations made in the investigation.

The data are presented completely in numerical form in Tables I, II, and III. Table I gives the results measured with instruments, Table II gives the condition of the airplane at the time of the spin, and Table III gives the results computed from records and the constants applying to the airplane.

Table II shows that for some flights ballast was placed in the rear ballast holder for the purpose of moving the center of gravity of the airplane rearward. This condition does not correspond to the ordinary condition for an airplane with its center of gravity farther aft than normal, because the stabilizer was not adjustable and changes in rigging were not made to balance the airplane "hands off." The external shape of the airplane was thus unaltered and the changes in the spin were the result of changes in center-of-gravity position and mass distribution only.

Pitching moments about the initial center-of-gravity position were used in computing all pitching-moment coefficients. This required adding the moment of the ballast (taking effect of accelerations into account) to the other moments (gyroscopic moment of the airplane and of the propeller) for the cases in which "tail-heavy" conditions of loading were used.

The center-of-gravity position is given as percentage mean chord in Table II. This mean chord was taken as the chord in the plane of symmetry midway between the upper and lower wing roots, with leading and trailing ends on lines joining the corresponding edges of the upper and lower wings, and having an incidence midway between that of the upper and lower wings.

PRECISION

The precision of the instrumental measurements was equivalent to that stated in reference 1 with the exception of the vertical-velocity measurements, in which the error may have been as much as 5 percent instead of 3 percent, the previously stated limit of error. This larger limit of error was indicated by the spread of measured vertical-velocity values and an occasional

evidence of sticking in the altimeter movement. Fluctuations of pressure in the cockpit may have been a contributory source of error.

Corrections for the distance of the accelerometer elements from the center of gravity were made as mentioned previously, using values for the coordinates of the elements estimated from partial data. The maximum error in these values was not in excess of 0.15 foot, and the resulting error in acceleration corrections was negligible.

The timer was tested on a turntable under conditions comparable to those of the spin and its operation and accuracy were found to be unaffected by rotation and acceleration.

A check on the accuracy of the angular-velocity recorders in most of the spins was obtained by timing 10 or 15 turns of the spin from the ground. The average angular velocity thus obtained agreed in general within 3 percent of the average angular velocity recorded by the instruments. This agreement is probably as close as the limits of accuracy of the timing.

The values in column 4 of Table III are indicative of the precision of the angular-velocity and acceleration records taken as a whole. These values (vertical force at the *c. g.*) should be 1 *g* in a steady spin, and it may be seen that the results deviate only slightly except in a few cases, notably for tests 51 and 52. The deviation in these latter tests was caused by lack of damping oil in the dashpot of the longitudinal element of the accelerometer, but since the maximum error of 0.1 *g* noted in the value of the longitudinal force causes only a small error in most of the results computed from the records, they were not discarded.

Moments of inertia of the airplane were not in error more than 1 percent, as stated in reference 3. This estimation of the precision is further supported by more recent tests to be reported soon. The determinations of weights of the airplane at the time of the spin were likewise not in error more than 1 percent.

The limits of error of the fundamental measurements may be summarized as follows: Angular velocity, 3 per cent for each component; acceleration, 0.05 *g*, except in a few extreme cases which fell within 0.1 *g*; interval of altitude, 5 percent; time, 2 percent; weight, 1 percent; moments of inertia, 1 percent.

DISCUSSION OF RESULTS

The tests were planned to show the effect of changes of single factors of the airplane properties on the spin, as far as this was physically possible without major modifications to the airplane. For instance, it was not practicable to move the center of gravity aft other than by placing ballast at the tail, and this was accompanied by a large change in the moments of inertia. The results are further complicated by incidental factors, such as asymmetry of rigging or shape of the airplane. These tests and experience with other airplanes indicated that right and left spins were not

comparable, even with the motor idling slowly or stopped. Tests such as those reported herein should therefore be made in one direction of spin only or in parallel series of tests in each direction of spin. In general, the former course was followed in these tests. One should bear in mind, therefore, that conclusions drawn from the results later discussed might have been slightly different if the spins had been made in both directions for each condition tested.

Angle of attack.—This airplane spins at moderately high angles of attack. Throughout the tests the angle of attack varied through a range of 10° (46°–56°) for the left spins. The range of angles of attack for the right spins was about 12° (39°–51°). In comparison, values have been observed with other airplanes that have shown the value of angle of attack to range from 30° to 70° in extreme cases.

Angle of sideslip.—The angle of sideslip for the normal left spins was zero or very small. For the normal right spins this angle was positive (outward) and of moderate magnitude (5° to 8°). Considering this in relation to the angle of attack, it is noted that relatively small angles of attack, as for the right spins, are associated with positive sideslip (outward), whereas the larger angles of attack of the left spins were associated with zero (or very small) angles of sideslip.

Effect of wing loading.—The only important changes in spin characteristics brought about by a change from 8.2 to 10.0 pounds per square foot wing loading were increases in linear velocity and angular velocity. The pertinent tests are tabulated for comparison in Table IV.

TABLE IV

Group	Test Nos.	$\frac{W}{S}$		V		Ω	
		Lb./ft. ²	Increase	Ft./sec.	Increase	Rad./sec.	Increase
			Per cent		Per cent		Per cent
A.....	16, 17, 18	8.2		80.4		2.46	
B.....	29, 30, 31	10.0	22.0	91.4	13.5	2.76	12.3
C.....	45, 46	10.0	22.0	83.6	4.0	2.65	7.7

Test groups A and B, when compared, show that the velocity along the flight path and the angular velocities both vary roughly as the square root of the wing loading. Reference to the simplified equations of motion given in the latter part of this report and consideration of the changes in angle of attack (see Table III) show that these results compare satisfactorily with the theory. The lack of agreement between the groups of tests B and C (Table IV) may be partly due to error in measurement of vertical velocity, but it is undoubtedly due in considerable measure to the difference in the spins, as shown by the fact that the angle of attack for the tests of group B was 50.6° and for group C it was 51.4°. The reason for this difference in spins is not known, other than that these groups of tests were separated in time by several months and some unno-

ticed changes in the airplane, such as changes in the condition of the fabric, may have occurred. Tests 45 and 46, therefore, should be omitted in the discussion of the effect of wing loading.

Effect of mass distribution.—Change in mass distribution produced by moving ballast from the center of gravity to the nose and tail caused a decrease in rate of rotation, decrease in angle of attack, negligible change in sideslip angle; and a decrease in glide-path angle. These effects are to be seen by comparing tests 29, 30, 31 with tests 19, 20, 21. The averages of the values mentioned above for the two groups of tests are tabulated in Table V with the values of the spin radii. (Table II gives ballast and moments of inertia for these tests.)

TABLE V

Test Nos.	Ballast position	Ω	α	β	γ	Radius
		Rad./sec.	°	°	°	Feet
29, 30, 31	At c. g.	2.76	50.6	-2.0	-83.2	3.5
19, 20, 21	At nose and tail	2.21	47.0	.4	-81.5	6.3

The effect of this mass distribution change on the ease of recovery was practically negligible. There were indications, however, that if any difference existed it was a tendency toward easier recovery for the spins with ballast at the nose and tail than for the spins with all ballast at the center of gravity, the same method of manipulating the controls being used in both cases.

Effect of moving the center of gravity aft.—The effect of a rearward position of the center of gravity with respect to its normal position can not be seen directly from these tests, because, on account of the limited ballast-carrying capacity of the airplane, appreciable displacement of the center of gravity could be accomplished only by putting ballast in the tail, and such procedure changes the moments of inertia more extensively than it changes the center-of-gravity position. The test results therefore show directly the effect of putting ballast in the rear end of the fuselage and indirectly the effect of the rearward position of the center of gravity. For the purpose of comparing results, the characteristics for the pertinent groups of tests are tabulated in Table VI. (Table II gives ballast and moments of inertia.)

TABLE VI

Group	Test Nos.	Ballast position	c. g., per cent mean chord	Ω	α	β	γ	Radius
				Rad./sec.	°	°	°	Feet
A	29, 30, 31	c. g.	25.8	2.76	50.6	-2.0	-83.2	3.5
B	19, 20, 21	Nose and tail	25.8	2.21	48.9	.4	-81.5	6.3
C	32, 33, 34	Tail and c. g.	34.5	2.18	48.6	.9	-80.8	6.2
D	35, 36, 37	Tail and c. g.	40.0	1.74	48.0	1.1	-79.4	10.0

As may be seen from Table II, groups B and C represent about equal increases of moments of inertia

(group B having slightly greater values than C) and, in regard to moments of inertia, are comparable. The moments of inertia for group D are much greater than for those of any of the other tests.

The effect of placing a large amount of ballast in the tail of the airplane as shown by a comparison of these data was a large decrease in rate of rotation, slight decrease in angle of attack, slight change in sideslip (in outward sense), and a large increase of radius of spin. The ease of recovery with ballast in the tail was the same as in the normal condition. Similar results have been observed in other airplanes, but the same results probably would not be found with all airplanes. Pilots should not conclude from these results that it is safe to place ballast or luggage in the rear part of the fuselage, unless tests have been made to prove the point.

Conclusions concerning the effect of the center-of-gravity position alone without any mass-distribution effect can not be drawn from the flight results with any certainty. It is evident from the flight results that with this airplane the rearward position of the center of gravity had very little effect; however, the exact nature of whatever effect there may have been can not be determined. Reference to the analysis given in the Analysis of Model Test Data shows that little effect would have resulted from the rearward displacement of the center of gravity, and that there might have been a slight decrease in angle of attack and rate of rotation.

Effect of dihedral of wings.—The effect of dihedral of the wings may be seen from Table VII. (Table II gives amounts of ballast and moments of inertia.)

TABLE VII

Test No.	Dihedral		Ω	α	β	γ	Radius	
	Lower wing	Upper wing						
57, 58, 60, 61, 62	°	°	Rad./sec.	°	°	°	Feet	c. g. at 25.8 per cent mean chord, no ballast.
16, 17, 18	1.25	0	2.42	54.3	1.1	-82.8	4.1	
70, 71, 72	4.6	4.17	2.56	50.7	0	-82.9	4.0	
63, 64, 65, 35, 36, 37, 66, 68, 69	1.25	0	1.71	55.6	3.3	-80.1	8.6	
	3	2.25	1.74	48.0	1.1	-79.4	10.0	
	4.6	4.17	1.89	51.2	1.8	-80.3	8.1	

The effect of dihedral is evidently very small, but these results indicate that an increase of wing dihedral causes a slight increase in angular velocity. The recovery from spins was not noticeably affected by the changes of dihedral employed in the tests.

Effect of decreased area of empennage elements.—Tests 76, 77, 78 were made with fabric stripped from elements of the empennage as described above, and they will be compared with tests 16, 17, 18 in Table VIII. The ballast conditions in these two groups of tests were not identical, as may be seen in Table II, but differed only by the weight and moment of inertia of the ballast containers, which were in place in the

airplane for the tests with the empennage altered but not for the tests 16, 17, 18 in which the empennage was in its normal condition. Aside from this small difference of ballast, the conditions of the tests involved no changes other than the change in empennage areas. There was no appreciable difference in the ease of recovery for these two groups of tests.

TABLE VIII

Test Nos.	Condition of empennage	Ω	α	β	γ	Radius
16, 17, 18, 76, 77, 78	Normal----- Part of fabric removed.	Rad./sec. 2.46 2.50	° 48.5 49.4	° 1.0 -.6	° -82.1 -82.2	Feet 4.6 4.4

The values in Table VIII show that the spins with the fabric removed were practically the same as those with the airplane in its normal condition. This result leads to the conclusion that the air forces on the areas from which the fabric was removed were normally small during the spin and, since the ease of recovery was not affected, the conclusion must apply also to the forces acting on these areas during recovery. Considering the forces that produced recovery (and recovery was effected mainly by means of the rudder with this airplane), the facts that very little fabric was removed from the rudder below the elevator, and that the ease of recovery was about the same for both groups of tests show that the important part of the rudder must have been the portion below the elevator where the air flow was unobstructed. A further conclusion that may be drawn is that since the actual area of the rudder which was effective was small, the yawing moment required to effect recovery, or at least the initial stages of the recovery must have been small.

Effect of control setting.—The effect of control setting may be seen in Table IX which shows results for right spins.

TABLE IX

Test Nos.	Control variation from normal ¹	Ω	α	β	γ	Radius
6, 7, 8	None-----	Rad./sec. 2.48	° 42.4	° 8.0	° -80.9	Feet 5.7
9	Ailerons with spin	2.91	47.7	-8.7	-82.8	3.5
12	Ailerons against spin	2.56	51.5	14.7	-82.6	4.2
13	Elevator down-----	3.17	40.3	16.2	-62.0	4.1

¹ The controls were deflected in the manner stated in the table to the extreme limit of their ranges.

In general, it is noted that aileron deflection caused a pronounced change in the nature of the spin, especially with respect to the angle of sideslip. These changes in the sideslip angle of the spin are undoubtedly related to the effect of aileron deflection on rolling moment due to rolling, but since many other factors are involved in the change of aerodynamic properties caused by aileron deflection, more complete data will be needed before the results may be completely under-

stood. Several characteristics other than sideslip angle were affected by aileron deflection, especially angle of attack and rate of rotation, which were both increased by aileron deflection in either sense.

The airplane had no tendency to recover as a result of aileron deflection, but undoubtedly the aileron setting must influence recovery indirectly, because of the difference in the nature of the spins produced. No tests on this subject were made.

The effect of aileron deflection on the spins of several other airplanes was noted during the course of the investigation and considerable difference in results was observed for the different airplanes. Because both the rolling moments and the yawing moments introduced by aileron deflection influence the spin, as will be seen in the analysis given later in this report, it is evident that the many variations of proportions and arrangements of ailerons occurring on different airplanes (especially on biplanes) would result in a wide variation of behavior.

Test results and experience indicate that conventional ailerons offer little promise for effective control of the spin; however, as in most cases some effect may be obtained, there is no reason why pilots should not avail themselves of this aid after experimenting with their particular airplanes to find the best conditions for recovery.

Downward deflection of the elevator produced an increase in angular velocity as shown in Table IX (right spins) and also in Table X giving results for left spins. For the right spins, downward deflection of the elevator produced a large increase in outward sideslip. In other respects the effect of downward elevator deflection is the same as for the left spin with normal center-of-gravity position discussed in the following paragraphs.

The effect of deflecting the elevator downward for left spins is shown by the results given in Table X for two mass-distribution and center-of-gravity conditions. The ballast used and moments of inertia are given in Table II.

TABLE X

Test Nos.	c. g., per cent mean chord	Elevator setting	Ω	α	β	γ	Radius
			Rad./sec.	°	°	°	Feet
29, 30, 31	25.8	Up.....	2.76	60.5	-2.0	-83.2	3.5
53, 54, 56	25.8	Down.....	3.42	47.7	5.0	-82.9	2.8
35, 36, 37	40.0	Up.....	1.74	48.0	1.1	-79.4	10.0
49, 51, 52	40.0	Down.....	2.48	49.5	1.2	-81.7	5.3

The most evident effect of putting the elevator down in all the tests made in the investigation was an increase in angular velocity, and this was accompanied by a small decrease in angle of attack; in fact, with the center of gravity in a rearward position the angle of attack increased when the elevator was put down. This result led to the expectation that possibly a more

rapid recovery from the spin could be effected by holding the elevator up during the first part of the recovery and putting it down later instead of immediately as is usually recommended. Accordingly, a few flight tests were made to compare the usual method of recovery with a method in which the elevator was held up at first until the rotation had been practically stopped by means of the rudder. The number of turns and altitude required for recovery were determined for both methods by simple observations, and no great difference in number of turns or altitude required was found. The NY-1 airplane was not particularly well suited for these tests, however, because it would recover normally in 1 to 1½ turns; an airplane requiring many turns for recovery would have shown the effect of this method of control manipulation much more clearly.

ANALYSIS OF MODEL TEST DATA

At present there are not sufficient data available to make an exact numerical analysis including all the factors affecting the spin; however, approximate methods utilizing wind-tunnel model tests have been devised which are very helpful, and which in some cases give results surprisingly consistent with flight measurements. A computation of the characteristics of the spin by one of these methods would be of especial interest when applied to an airplane for which accurate flight data were available, and therefore wind-tunnel measurements were made on a model of the airplane used in the above-described flight investigation to be used for a numerical analysis.

Fuchs and Schmidt have reported (reference 2) a method of analyzing spins that is logical and as complete as practicable with the data available. Other somewhat similar methods have been reported, but their method is best suited to this study and was used almost without change, except that the conventional symbols and axes of the National Advisory Committee for Aeronautics were employed.

MODEL TESTS

A 1/12-scale model of the airplane was tested in the 7 by 10 foot open-throat wind tunnel, which, with its balance and test procedure, is described in reference 4. Measurements of lift, drag, and pitching moment were made over a range of from 0° to 90° angle of attack (referred to X body axis) and all appropriate corrections, except tunnel-wall corrections, were made. The tunnel-wall correction is of no importance for these tests, since it is relatively small at very high angles of attack. Three positions of the elevator were tested for the complete model. For the tests of the wing cellule a center section was inserted in the lower wing where the fuselage formerly had been. The wing cellule was then tested through the same angles as those for the complete model. All coefficients were computed on

the basis of the area of the wing cellule with the lower wing carried through. Moment coefficients were referred to the center of gravity. The results of the model tests are presented as curves in Figure 3. The normal and tangential force curves were computed from the wing cellule alone and are given in Figure 4.

CALCULATIONS

The preliminary assumptions employed in the method outlined by Fuchs and Schmidt were that

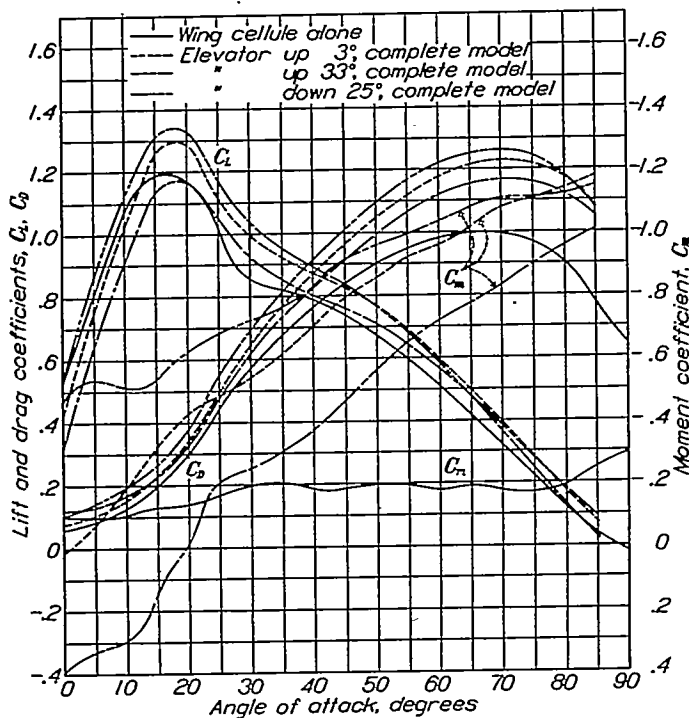

FIGURE 3.—Aerodynamic characteristics of a 1/12-scale model of the NY-1 airplane and of the wing cellule alone

lift, drag, and lateral force were not seriously affected by moderate degrees of sideslip; that lift, drag, and pitching moment were not affected seriously by small rates of rotation; and that rolling and yawing moments were affected by sideslip of 20° or less only in a manner that would correspond to some particular aileron setting with no sideslip. Some of these assumptions lead to negligible errors; others, as for example the assumption that lift, drag, and pitching moments are not affected by rotation, lead to small errors, but the necessity of assuming that rolling moment due to sideslip must be counterbalanced by a certain amount of aileron moment is indeed unfortunate when a study of a particular spin is to be made. An assumption that sideslip had no effect on the rolling moments would be untenable for values of sideslip of 10° or 20°, as may be seen from the results of reference 5.

When the method of Fuchs and Schmidt was applied to the left spins of the NY-1 airplane, it was improved in three particulars: (1) The airplane was known to spin with no sideslip (or a very small degree of side-

slip) with the controls in the normal setting for the spin, which eliminates errors from sideslip in the most important spin to be studied; (2) the pitching moment due to pitching as determined by approximation was found to be about equal to the pitching moment exerted on the propeller measured in the flight tests for left spins, making it possible to simplify the equations by dropping the terms for both of these factors; and (3) the moments of inertia of this airplane were known from actual measurement.

The yawing moment of the fuselage and empennage due to yawing is a factor of considerable importance, and one concerning which the information available is meager. The importance of this factor is indicated by two results of the flight tests: First, the tests indicated that all of the vertical surface of the empennage above the stabilizer and elevator was practically inoperative during the spin; and, second, it was found that the airplane would not remain in a spin if the rudder was neutralized while the elevator was still held hard up as for a spin. Since the effective area of the rudder was evidently small, the change in yawing moment that destroyed the spinning equilibrium was small, which points to the importance of even a small moment. On the other hand, wind-tunnel tests made in England and at this laboratory have shown that for a rectangular-section fuselage the magnitude and sense of the yawing moments (due to yaw or yawing) at

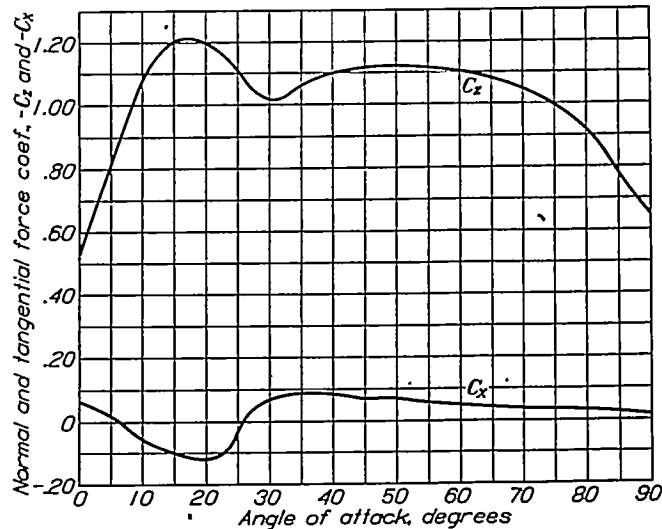

FIGURE 4.—Normal-force and tangential-force curves for the 1/12-scale model NY-1 wing cellule alone

high angles of attack were so much dependent upon details of shape that a method of approximation was practically out of the question. Thus, in spite of the importance of an exact knowledge of this factor, about the only course left open in the question was to assume that the yawing moment of the fuselage and empennage due to yawing was zero.

The rolling and yawing moments of the wing cellule due to rolling and yawing, computed by the strip method, are not exact when a finite number of strips

are employed, but the accuracy of this type of computation is certainly within the limits of the errors of the assumptions required for other parts of the analysis. These wing rolling and yawing moments were equated to the gyroscopic rolling and yawing moments acting on the airplane, since the rolling and yawing moments of the other parts of the airplane were taken to be zero. The rolling moment of the fuselage and empennage may be seen to be negligible from a consideration of their shapes; the reason for assuming the yawing moment of the fuselage and empennage to be zero was discussed in the foregoing paragraph.

The computation of the quantities necessary in the analysis of a spin is based on the following six equations of motion, which are the simplified forms of the general equations given in reference 6 for the case of zero sideslip.

Equilibrium of forces:

Path axis:

$$-W \sin \gamma - C_D q S = 0 \quad (1)$$

Lift axis:

$$m V \Omega \cos \gamma \sin \phi + W \cos \gamma \cos \phi - C_L q S = 0 \quad (2)$$

Axis \perp to path and lift axes:

$$m V \Omega \cos \gamma \cos \phi + W \cos \gamma \sin \phi = 0 \quad (3)$$

(Ω is positive for right spins.)

Equilibrium of moments, incorporating the above-mentioned simplifications:

$$-(B-C) qr = L \quad (4)$$

$$-(C-A) rp = M \quad (5)$$

$$-(A-B) pq = N \quad (6)$$

The values of p , q , and r , the angular velocities about the airplane body axes (assumed to coincide with the principal axes, which in many cases is exactly true, and is very nearly true in all others) were determined in terms of the resultant angular velocity and attitude angles, as follows:

$$p = -\Omega (\cos \gamma \cos \phi \sin \alpha + \sin \gamma \cos \alpha).$$

$$q = \Omega (\cos \gamma \sin \phi).$$

$$r = \Omega (\cos \gamma \cos \phi \cos \alpha - \sin \gamma \sin \alpha).$$

Solving (1) for V after substitution of $\frac{1}{2} \rho V^2$ for q :

$$V = \sqrt{\frac{-2W \sin \gamma}{C_D \rho S}} \quad (7)$$

Taking $\rho = 0.002176$ slug per cubic foot (3,000 feet altitude), $W = 2,910$ pounds (full ballast total weight), $S = 291$ square feet (area with wing extended through fuselage):

$$V = 95.5 \sqrt{\frac{-\sin \gamma}{C_D}}$$

Solving (2) and (3) for Ω :

$$\Omega = \sqrt{\frac{C_L^2 S^2 \rho^2 V^2}{4 m^2 \cos^2 \gamma} - \frac{g^2}{V^2}} \quad (8)$$

which, with the constants combined, becomes:

$$\Omega = g \sqrt{(1.18 \times 10^{-8}) \frac{C_L^2 V^2}{\cos^2 \gamma} - \frac{1}{V^2}} \quad (9)$$

Solving (3) for ϕ :

$$\phi = \tan^{-1} \left(\frac{V \Omega}{g} \right) \quad (10)$$

Because analytic expressions could not be obtained for the variation of lift and drag as a function of α , the solution could only be obtained by a semigraphical method. Therefore, choosing the values of $\gamma = -80^\circ$ and $\gamma = -86^\circ$, velocities along the flight path were computed for the whole range of angle of attack and plotted in Figure 5. Then values of Ω were computed and plotted in Figure 6 for $\gamma = -80^\circ, -82^\circ, -85^\circ, -86^\circ$, and finally values of angle of bank ϕ were computed and plotted in Figure 7. These quantities made it possible to compute values of p , q , and r in terms of α with γ as a parameter. (Figs. 8 to 10.)

With the values of p , q , and r computed it was possible to evaluate the expressions:

$$C_{i_w} = \frac{1}{V^2 S b} \sum_{\gamma = -\frac{b}{2}}^{\gamma = \frac{b}{2}} \left(C_z (\alpha + \Delta \alpha, V + \Delta V) \left(\frac{V + \Delta V}{\cos \Delta \alpha} \right) \right) c y \Delta y,$$

and

$$C_{n_w} = -\frac{1}{V^2 S b} \sum_{\gamma = -\frac{b}{2}}^{\gamma = \frac{b}{2}} \left(C_x (\alpha + \Delta \alpha, V + \Delta V) \left(\frac{V + \Delta V}{\cos \Delta \alpha} \right)^2 \right) c y \Delta y$$

in which $\Delta V = r y$ and $\Delta \alpha = \tan^{-1} \frac{p y}{V + \Delta V}$ and C_z and C_x are taken from the curves (fig. 4) of normal and tangential force coefficients of the wing cellule alone. As mentioned previously, the rolling and yawing moments of the wing cellule are set equal to the total aerodynamic rolling and yawing moments:

$$C_{i_w} = C_l$$

$$C_{n_w} = C_n$$

The actual computation of these two moments was made by using four strips on either side of the plane of symmetry.

The computed values of p , q , and r and the moments of inertia determined by measurement were used to compute the gyroscopic moments.

Figures 11 to 13 are curves of computed aerodynamic and gyroscopic moments about the three axes plotted in terms of angle of attack and for the several values of glide path. It is evident that in considering any one of these sets of three figures, equilibrium of moments might exist for any of the intersections of aerodynamic and gyroscopic moment curves corresponding to the same glide-path angle. However, it is necessary that equilibrium exist about all three moment axes simultaneously for a steady state of motion (spinning), and consequently only those intersections which occur for the same glide-path angle and angle of attack on the three charts of moments corresponded to an actual steady spin. Curves of glide-path angle and angle of

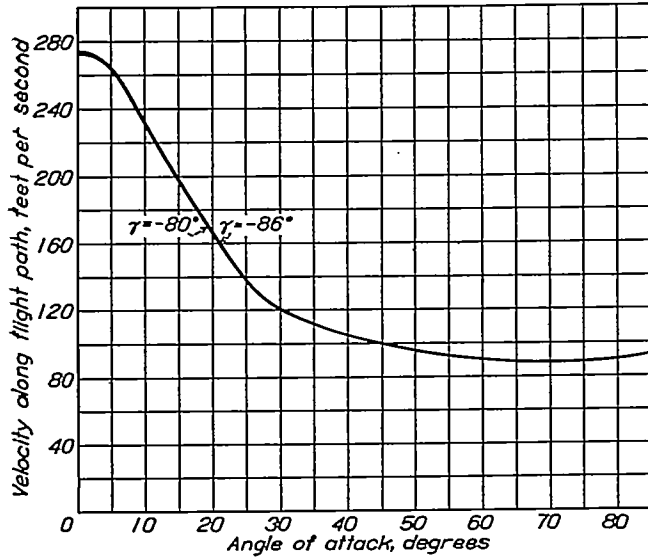

FIGURE 5.—Computed velocity along flight path, elevator up 33°, ballast at c. g.

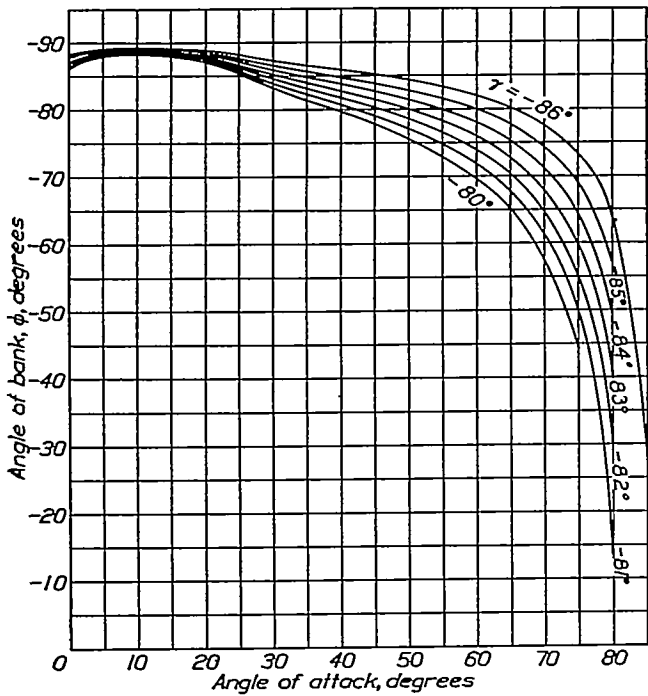

FIGURE 7.—Computed angle of bank, elevator up 33°, ballast at c. g.

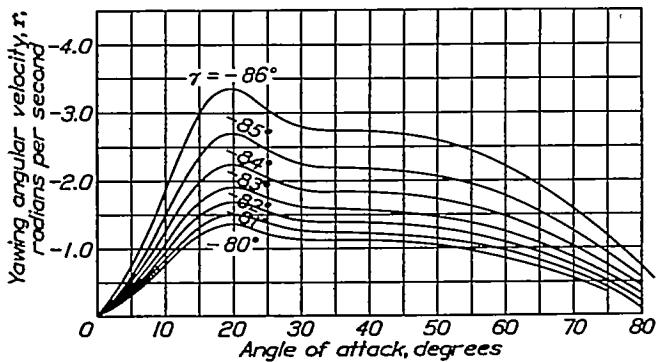

FIGURE 10.—Computed yawing angular velocity, elevator up 33°, ballast at c. g.

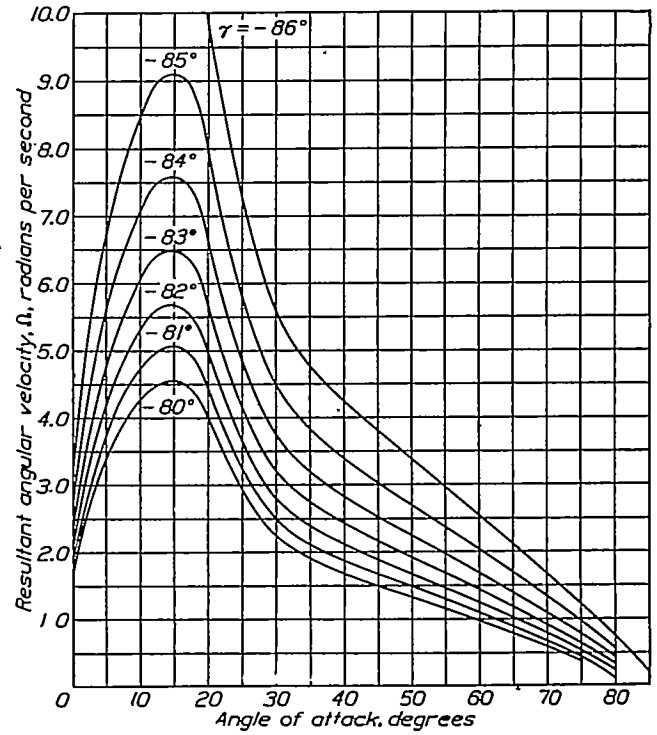

FIGURE 6.—Computed resultant angular velocity, elevator up 33°, ballast at c. g.

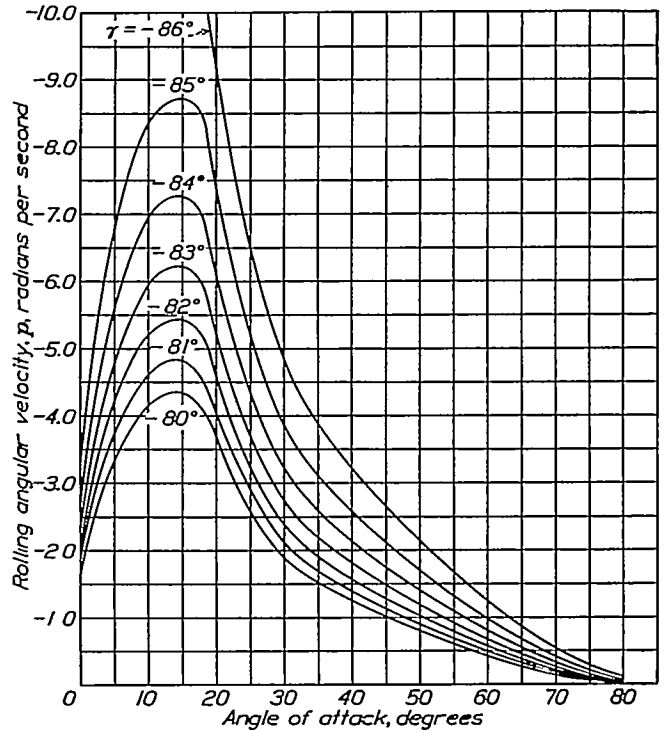

FIGURE 8.—Computed rolling angular velocity, elevator up 33°, ballast at c. g.

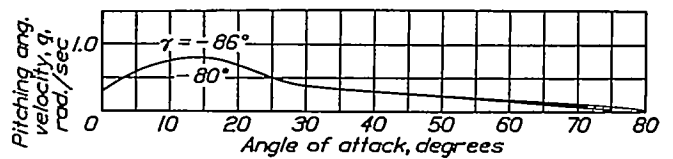

FIGURE 9.—Computed pitching angular velocity, elevator up 33°, ballast at c. g.

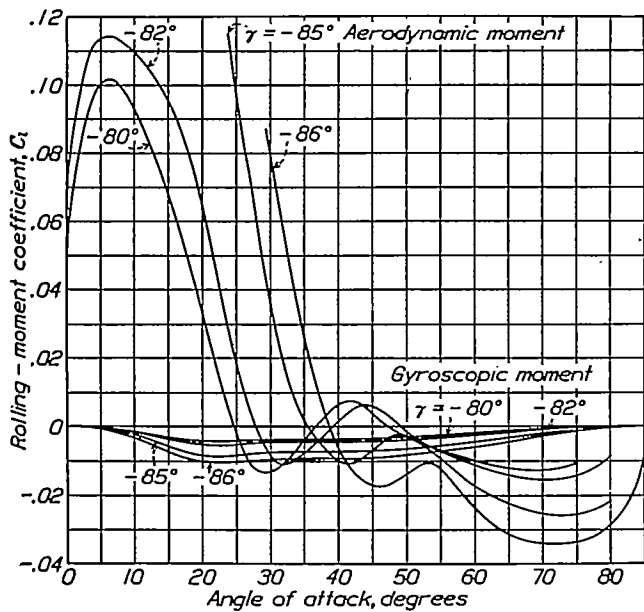

FIGURE 11.—Computed aerodynamic and gyroscopic rolling-moment coefficients, elevator up 33° , ballast at c. g.

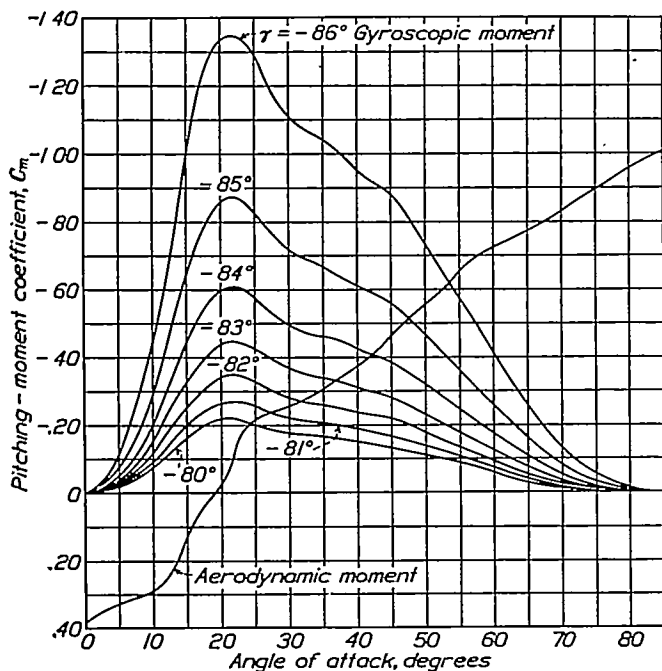

FIGURE 12.—Computed aerodynamic and gyroscopic pitching-moment coefficients, elevator up 33° , ballast at c. g.

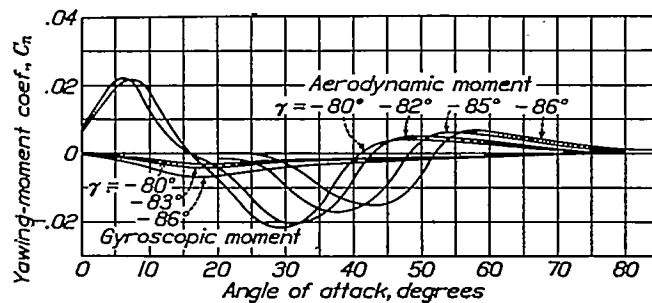

FIGURE 13.—Computed aerodynamic and gyroscopic yawing-moment coefficients, elevator up 33° , ballast at c. g.

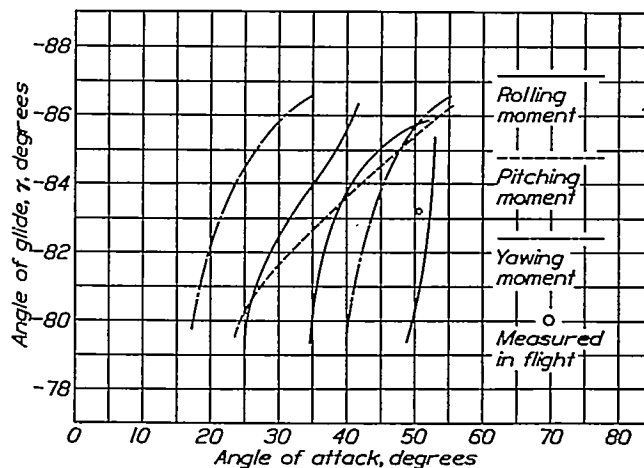

FIGURE 14.—Equilibrium of three moments, elevator up 33° , ballast at c. g.

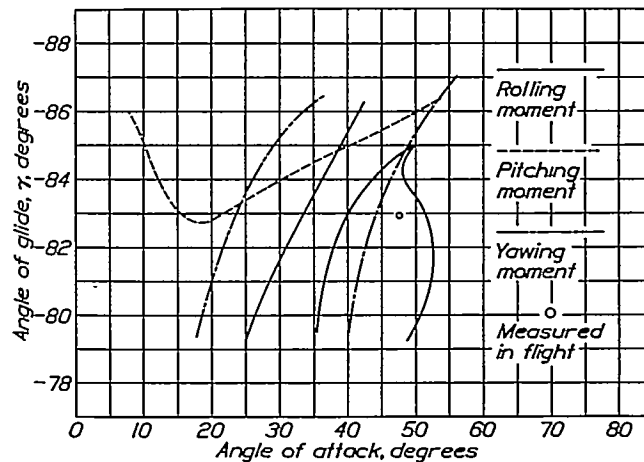

FIGURE 15.—Equilibrium of three moments, elevator down 25° , ballast at c. g.

attack, at which equilibrium of moments occurs for each of the three moments, are given in Figure 14. The curves of Figure 15 were obtained by a similar computation based on the model test with elevator down. Intersection of the three curves for rolling, pitching, and yawing moments at one point in these

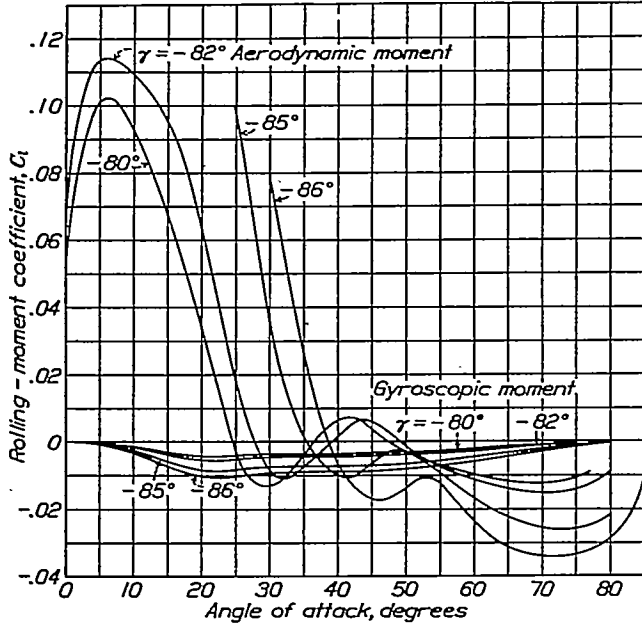

FIGURE 16.—Computed aerodynamic and gyroscopic rolling moments, elevator up 33°, ballast at nose and tail

charts would represent the conditions for a steady spin.

Thus far in the computations, only one ballast condition has been used. Computation of equilibrium conditions for other ballast conditions may be readily made employing most of the data already computed. It is obviously true in this computation

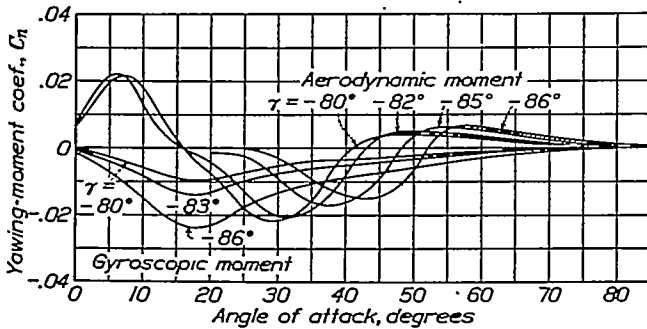

FIGURE 18.—Computed aerodynamic and gyroscopic yawing moments, elevator up 33°, ballast at nose and tail

that changes in ballast conditions do not change the aerodynamic quantities in any way so long as the weight remains constant. Therefore, the only computation necessary will be a determination of the gyroscopic moments, which is a relatively simple matter since the only new values will be those of moments of inertia. In cases in which the center of gravity was moved aft by placing unbalanced ballast in the tail of the airplane, the moment of the ballast

under the existing conditions of linear acceleration, referred to the center-of-gravity position of the original computations, should be included with the gyroscopic moments.

A computation of the equilibrium state was made for one ballast condition other than that of the com-

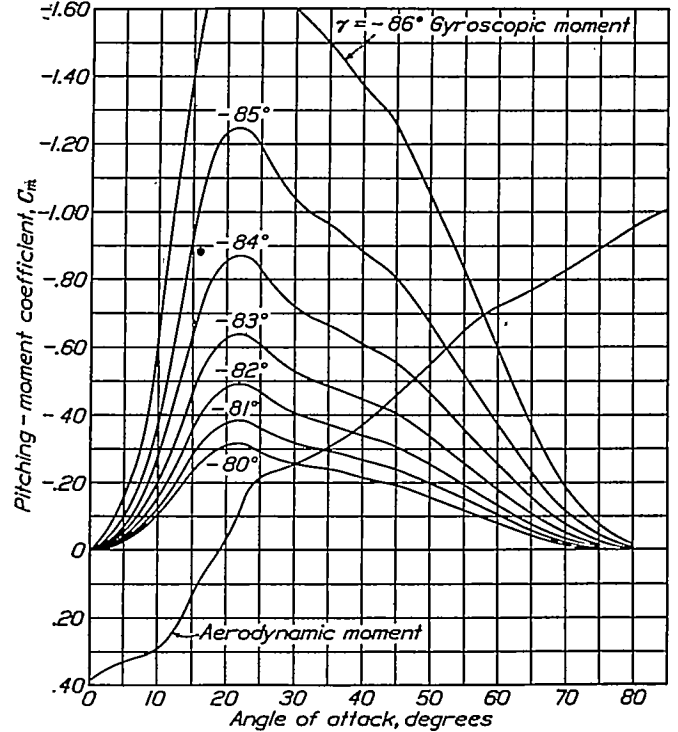

FIGURE 17.—Computed aerodynamic and gyroscopic pitching moments, elevator up 33°, ballast at nose and tail

putations already described. This was for the case that the ballast was placed in the nose and tail and therefore corresponded to the moments of inertia for flight tests, 19, 20, and 21. The results are shown in Figures 16 to 19.

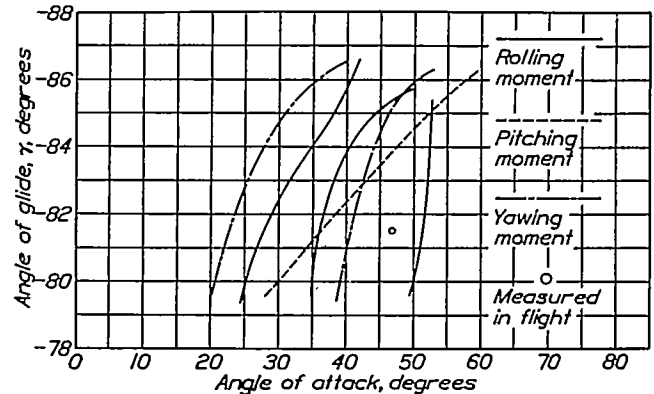

FIGURE 19.—Equilibrium of three moments, elevator up 33°, ballast at nose and tail

DISCUSSION OF COMPUTED RESULTS

A comparison of the flight results with the results of this numerical analysis discloses gratifying agreement when there is no sideslip. For the condition of ballast at the center of gravity and elevator up (fig. 15), the curves come very close to an intersection indicating equilibrium. The point plotted is the measured value

of angle of attack and glide-path angle from the flight tests. The major discrepancy between this flight result and the computed results is a $2\frac{1}{4}^\circ$ difference in glide-path angle. This difference, it is believed, is to be attributed to an interference effect in the wind-tunnel measurements. The model support employed for the tests was not particularly suitable for measurements at high angles of attack; force measurements (not published) on the same model in another tunnel indicate that the measurements presented herein are a few per cent too low. A study of the equations has shown that if the forces measured on the model were too small, all the computed curves would be shifted to unduly high values of glide-path angle, but that their form would not be seriously affected.

A further study of the results (fig. 14) shows that the intersection of the yawing and pitching moment equilibrium curves would occur at a slightly higher angle of attack if a small negative yawing moment were assumed in addition to that computed for the wings by the strip method. Such a moment could easily have arisen in the flight tests from the rudder, especially as the pilot reported that a moderate force on the rudder pedal was required to hold the rudder hard over for the spin. Finally, whatever slight shifting of the rolling-moment equilibrium curve may be required to cause it to pass through the intersection of the other two curves would correspond to differences in rolling moments smaller than the limits of error in the computation, or to the additional rolling moment caused by a very small degree of sideslip. Thus it is seen that, although the conditions for equilibrium were not obtained exactly and the flight results did not correspond exactly with the computed values, the lack of agreement was small enough to be readily explained.

The moment-equilibrium curves failed to intersect for the condition of elevator down, but the discrepancy is explained when it is noted that outward sideslip was recorded in the flight tests for both right and left spins. Since the computations did not take rolling moment due to sideslip into account, equilibrium of all moments should not be obtained by the computation. It may be seen, however, in a qualitative way, by inspecting Figures 23 to 26, that rolling moment due to outward sideslip would shift the rolling moment equilibrium curve upward toward larger values of glide-path angle, which would reasonably be expected to result in a condition of complete equilibrium. Since outward sideslip was recorded in the flight tests, there was undoubtedly a positive yawing moment due to air forces acting on the vertical tail surfaces which was not taken into account. Such a moment would have shifted the yawing-moment equilibrium curve toward larger values of angle of attack, a correction that would make the computed results agree more closely with the flight results.

Comparison of flight and computed results for changes of mass distribution (fig. 18) shows the same

trend in the computed results as in the flight results, but equilibrium of the computed curves was not indicated. In order to obtain equilibrium corresponding to the flight results, negative yawing and negative rolling moments must be added to the computed moments. Such moments could easily have resulted from some of the several factors not taken into account in the analysis. In spite of this lack of indicated equilibrium, however, it is clear that the trend of the computed value is the same as for the values measured in flight.

The equilibrium curves show only one intersection in the high angle-of-attack range for a particular condition of the airplane, and this was confirmed by flight tests. The orientation of the three moment-equilibrium curves, however, suggests that equilibrium at low angles of attack (in the region of 20° to 30°) may be possible. Spinning experience with this airplane has not indicated definitely that a spin is or is not possible at such a low angle of attack, but during this investigation the only maneuver approximating the low angle-of-attack spin was a maneuver inadvertently obtained in a few instances, which the pilot described as a steep spiral. The control forces and air speed were reported to build up to very high magnitudes and the maneuver was always terminated before a steady state was reached. The pilot's sensations were reported as very different from those in a spin. An extension of the numerical analysis to low values of α and γ and further flight tests would yield interesting information on this subject.

This method of analysis, or any equivalent method, may be considered perfectly general; its only limitations are the limitations of accuracy or knowledge of the data necessary for the computations. All the effects of the many complex details of aerodynamic shape, mass distribution, and other similar factors could be easily taken into account in this type of analysis, but at present data are not available for many of the factors that might be worth including. When it becomes possible to measure the resultant moments and forces on a model while executing a motion that simulates the full-scale spin, much of the uncertainty of the results will be removed. A special balance is now being perfected by the National Advisory Committee for Aeronautics for making these measurements.

CONCLUSIONS

The following conclusions were based on the results of these tests and computations.

1. Moderate increases in wing loading produced only the expected slight increases in angular velocity and linear velocity.
2. The change in mass distribution produced by moving ballast from the center of gravity to the nose and tail of the airplane without shift of centroid caused a decrease in rate of rotation, decrease in angle of

attack, negligible change in sideslip angle, and a decrease in glide-path angle. Recovery was perhaps slightly easier in this condition than with normal mass distribution.

3. The effect on the steady spin of moving the center of gravity aft without changes in stabilizer setting was small. Ballast placed in the tail of the airplane produced almost the same changes in the spin as ballast placed in the nose and tail with no change in center-of-gravity position.

4. The effect of moderate changes in dihedral of the wing cellule was small.

5. Removal of the covering from the fin and part of the rudder of this airplane did not materially affect the spin.

6. Displacement of the ailerons during a steady spin caused large changes in sideslip angle and several other minor changes, but no tendency to recover.

7. Full-down displacement of elevator caused an increase of angular velocity. With the center of gravity in its forward position, angle of attack was decreased and outward sideslip was produced, but with ballast in the tail the angle of attack increased and sideslip remained the same.

8. A numerical analysis based on static wind-tunnel measurements and strip computations gave results that checked the results of flight measurements very closely considering the assumptions necessary. The charts constructed in the analysis aided materially in studying the various characteristics of the spin, but with the data available at present, an analysis such as this for an airplane of unknown spinning characteristics would not always lead to useful results.

LANGLEY MEMORIAL AERONAUTICAL LABORATORY,
 NATIONAL ADVISORY COMMITTEE FOR AERONAUTICS,
 LANGLEY FIELD, VA., June 18, 1932.

REFERENCES

1. Soulé, H. A., and Scudder, N. F.: A Method of Flight Measurement of Spins. T. R. No. 377, N. A. C. A., 1931.
2. Fuchs, R., and Schmidt, W.: The Steady Spin. T. M. No. 630, N. A. C. A., 1931.
3. Miller, Marvel P., and Soulé, Hartley A.: Moments of Inertia of Several Airplanes. T. N. No. 375, N. A. C. A., 1931.
4. Harris, Thomas A.: The 7- by 10-Foot Wind Tunnel of the National Advisory Committee for Aeronautics. T. R. No. 412, N. A. C. A., 1932.
5. Knight, Montgomery, and Wenzinger, C. J.: Rolling Moments Due to Rolling and Yaw for Four Wing Models in Rotation. T. R. No. 379, N. A. C. A., 1931.
6. Fuchs, R., and Hopf, L.: Aerodynamik, Handbuch der Flugzeugkunde, Band II; 1922. R. C. Schmidt and Co., Berlin, W. 62.

BIBLIOGRAPHY

Baranoff, Alexander: Einige Ergebnisse von Rechnungen über den Übergang eines Flugzeugs ins Trudeln. Jahrbuch 1928, D. V. L., Seiten 205-208.

Baranoff, Alexander: Beitrag zur Frage der Stabilität der Trudelbewegung. Jahrbuch 1929, D. V. L., Seiten 175-182.

Fuchs, R.: Mathematical Treatise on the Recovery from a Flat Spin. T. M. 591, N. A. C. A., 1930.

Fukatsu, R.: On the equilibrium of the Steady Spinning of Aeroplanes. Read before the Fifth International Air Congress at the Hague, 1930.

Gates, S. B., and Bryant, L. W.: The Spinning of Airplanes. R. & M. No. 1001, British A. R. C., Oct., 1926.

Gates, S. B.: Spinning Experiments on a Single Seater Fighter, Part II, Full-Scale Spinning Tests. R. & M. No. 1278, British A. R. C., 1929.

Irving, H. B., and Batson, A. S.: Spinning of a Model of the Fairey III-F Seaplane. R. & M. No. 1356, British A. R. C., 1930.

Irving, H. B., and Stephens, A. V.: Safety in Spinning. Jour. Roy. Aero. Soc., March, 1932.

Sutton, H. A.: Airplane Spinning Characteristics. Air Corps Information Circular No. 613, February 15, 1928. Effect of Cellule Arrangement on the Rate of Autorotation Calculated by the "Strip" Method. Air Corps Information Circular No. 609, February 1, 1928.

Wright, K. V.: Experiments on the Spinning of a Bristol Fighter Aeroplane. R. & M. No. 1261, British A. R. C., May, 1929.

TABLE I. INSTRUMENT DATA

Test No.	Components of angular velocity, (rad./sec.)			Components of acceleration (g)			Vertical velocity, ft./sec.
	<i>p</i>	<i>q</i>	<i>r</i>	$\frac{X}{m}$	$\frac{Y}{m}$	$\frac{Z}{m}$	
1R ¹	1.45	0.076	1.78	-0.0236	-0.0375	1.37	86.1
2R	1.70	.126	1.67	-.0329	-.0333	1.42	92.1
3R	1.64	.120	1.81	-.0260	-.0351	1.40	93.4
5R	1.68	.060	1.76	-.0472	-.0379	1.39	83.3
7R	1.90	.041	1.67	-.0222	-.0433	1.56	89.8
8R	1.75	-.001	1.81	-.0076	-.0340	1.41	84.8
9R	1.82	.787	2.13	-.0010	.0565	1.38	80.1
12R	1.60	-.325	1.97	-.0083	-.0806	1.34	80.0
13R	2.40	-.453	2.02	-.0277	-.1153	1.64	89.9
16L	-1.53	.291	-1.88	-.0202	.0268	1.31	78.9
17L	-1.58	.291	-1.86	-.0100	.0251	1.30	82.9
18L	-1.53	.286	-1.88	-.0100	.0335	1.29	78.9
19L	-1.43	.258	-1.60	-.0867	-.0182	1.36	92.5
20L	-1.46	.378	-1.67	-.0468	-.0173	1.35	90.5
21L	-1.45	.286	-1.72	-.0720	-.0361	1.34	94.2
22L	-1.44	.251	-1.70	-.0284	.0049	1.27	85.6
23L	-1.44	.300	-1.71	-.0376	.0043	1.28	83.2
24L	-1.50	.458	-1.84	-.0464	-.0322	1.36	86.7
25L	-1.59	.413	-1.89	-.0437	-.0011	1.34	91.1
27L	-1.61	.369	-1.87	-.0437	.0006	1.36	85.3
28L	-1.61	.410	-1.92	-.0366	-.0234	1.31	87.4
29L	-1.63	.437	-2.12	-.0202	-.0328	1.20	97.3
30L	-1.71	.350	-2.14	-.0180	-.0192	1.33	91.4
31L	-1.72	.370	-2.12	-.0218	-.0268	1.36	85.8
32L	-1.37	.333	-1.71	-.1157	-.0218	1.20	80.4
33L	-1.34	.289	-1.66	-.110	-.0060	1.31	85.5
34L	-1.34	.266	-1.61	-.107	.0189	1.33	88.7
35L	-1.11	.276	-1.33	-.0916	.0059	1.44	95.3
36L	-1.14	.291	-1.31	-.0951	.0135	1.85	99.0
37L	-1.16	.290	-1.37	-.116	-.0334	1.87	95.3
42L	-1.40	.279	-1.72	-.0702	.0171	1.29	91.7
43L	-1.41	.323	-1.75	-.0783	-.0173	1.34	93.8
44L	-1.38	.302	-1.76	-.0796	-.0024	1.31	92.4
45L	-1.63	.295	-2.10	-.0377	.0051	1.23	85.1
46L	-1.68	.332	-2.08	-.0369	-.0039	1.29	82.2
47L	-1.03	.255	-1.42	-.123	-.0210	1.25	89.1
48L	-1.06	.240	-1.40	-.129	-.0003	1.30	84.9
49L	-1.54	.317	-1.87	-.223	-.0220	1.38	92.1
51L	-1.55	.304	-1.88	-.215	-.0394	1.31	91.3
52L	-1.65	.297	-1.90	-.226	-.0693	1.31	93.2
53L	-2.28	.057	-2.61	-.104	-.0052	1.39	72.1
54L	-2.25	.308	-2.56	-.100	-.0623	1.40	76.5
56L	-2.33	.023	-2.44	-.106	.0028	1.43	82.1
57L	-1.42	.286	-1.90	-.0164	-.0155	1.31	83.4
58L	-1.38	.258	-1.95	-.0122	-.0049	1.35	76.6
60L	-1.33	.249	-2.06	-.0123	.0078	1.28	70.3
61L	-1.37	.235	-1.98	-.0178	.0123	1.28	78.3
62L	-1.32	.249	-2.02	-.0103	.0188	1.15	82.3
63L	-.92	.166	-1.48	-.123	.0083	1.24	85.0
64L	-.92	.207	-1.43	-.130	.0006	1.25	84.0
65L	-.95	.209	-1.39	-.112	.0029	1.25	89.6
96L	-1.16	.256	-1.50	-.142	.0170	1.28	92.0
98L	-1.13	.266	-1.61	-.138	-.0055	1.24	85.4
99L	-1.12	.240	-1.42	-.130	-.0121	1.29	95.0
70L	-1.56	.294	-1.99	-.0112	-.0065	1.31	80.2
71L	-1.58	.368	-2.01	-.0103	-.0177	1.30	85.3
72L	-1.53	.271	-1.99	-.0159	.0070	1.30	87.9
76L	-1.56	.283	-1.90	-.0089	.0081	1.27	82.1
77L	-1.56	.287	-1.89	-.0162	.0083	1.31	79.9
78L	-1.57	.500	-1.95	-.0091	-.0156	1.33	84.9

¹ Letter R is right-hand spin; letter L is left-hand spin.

TABLE II.—PROPERTIES OF AIRPLANE

Test No.	Wt. during spin, pounds	Ballast, pounds			Moment of ellipsoid constants				c. g. position, per cent mean chord	Changes to external dimensions or controls of airplane
		Front	c. g.	Rear	A	B	C	r ¹		
1R.....	2,306	0	0	0	Slug ft. ² 2,300	Slug ft. ² 2,470	Slug ft. ² 3,863	° -0.3	25.8	None.
2R.....	2,366	0	0	0	2,300	2,470	3,863	-0.3	25.8	None, but motor was stopped.
3R.....	2,390	0	0	0	2,300	2,470	3,863	-0.3	25.8	Do.
5R.....	2,377	0	0	0	2,300	2,470	3,863	-0.3	25.8	Do.
6R.....	2,391	0	0	0	2,300	2,470	3,863	-0.3	25.8	None.
7R.....	2,391	0	0	0	2,300	2,470	3,863	-0.3	25.8	None.
8R.....	2,391	0	0	0	2,300	2,470	3,863	-0.3	25.8	None.
9R.....	2,385	0	0	0	2,300	2,470	3,863	-0.3	25.8	Ailerons with spin. ²
12R.....	2,377	0	0	0	2,300	2,470	3,863	-0.3	25.8	Ailerons against spin.
13R.....	2,354	0	0	0	2,300	2,470	3,863	-0.3	25.8	Elevator down.
16L.....	2,388	0	0	0	2,300	2,470	3,863	-0.3	25.8	None.
17L.....	2,390	0	0	0	2,300	2,470	3,863	-0.3	25.8	None.
18L.....	2,394	0	0	0	2,300	2,470	3,863	-0.3	25.8	None.
19L.....	2,900	343	0	93	2,330	3,427	4,814	2.5	25.8	None.
20L.....	2,923	343	0	93	2,330	3,427	4,814	2.5	25.8	None.
21L.....	2,911	343	0	93	2,330	3,427	4,814	2.5	25.8	None.
22L.....	2,930	243	131	62	2,314	3,151	4,647	2.1	25.8	None.
23L.....	2,930	243	131	62	2,314	3,151	4,647	2.1	25.8	None.
24L.....	2,900	243	131	62	2,314	3,151	4,647	2.1	25.8	None.
25L.....	2,900	114	291	31	2,308	2,879	4,288	1.6	25.8	None.
27L.....	2,911	114	291	31	2,308	2,879	4,288	1.6	25.8	None.
28L.....	2,917	114	291	31	2,308	2,879	4,288	1.6	25.8	None.
29L.....	2,916	0	436	0	2,298	2,607	4,026	.9	25.8	None.
30L.....	2,916	0	436	0	2,298	2,607	4,026	.9	25.8	None.
31L.....	2,916	0	436	0	2,298	2,607	4,026	.9	25.8	None.
32L.....	2,916	0	359	77	2,295	3,124	4,546	0	34.5	None.
33L.....	2,910	0	359	77	2,295	3,124	4,546	0	34.5	None.
34L.....	2,898	0	359	77	2,295	3,124	4,546	0	34.5	None.
35L.....	2,904	0	301	135	2,293	3,494	4,918	0	40.0	None.
36L.....	2,898	0	301	135	2,293	3,494	4,918	0	40.0	None.
37L.....	2,904	0	301	135	2,293	3,494	4,918	0	40.0	None.
42L.....	2,919	343	0	93	2,330	3,427	4,814	2.5	25.8	None.
43L.....	2,907	343	0	93	2,330	3,427	4,814	2.5	25.8	None.
44L.....	2,919	343	0	93	2,330	3,427	4,814	2.5	25.8	None.
45L.....	2,901	0	436	0	2,298	2,607	4,026	.9	25.8	None.
46L.....	2,937	0	436	0	2,298	2,607	4,026	.9	25.8	None.
47L.....	2,907	0	301	135	2,293	3,494	4,918	0	40.0	None.
48L.....	2,919	0	301	135	2,293	3,494	4,918	0	40.0	None.
49L.....	2,907	0	301	135	2,293	3,494	4,918	0	40.0	Elevator down.
51L.....	2,890	0	301	135	2,293	3,494	4,918	0	40.0	Do.
52L.....	2,901	0	301	135	2,293	3,494	4,918	0	40.0	Do.
53L.....	2,907	0	436	0	2,298	2,607	4,026	.9	25.8	Do.
54L.....	2,919	0	436	0	2,298	2,607	4,026	.9	25.8	Do.
56L.....	2,901	0	436	0	2,298	2,607	4,026	.9	25.8	Do.
57L.....	2,491	0	0	0	2,284	2,593	4,026	.9	25.8	Dihedral, lower wing, decreased from 3° to 1.25°. ³
58L.....	2,505	0	0	0	2,284	2,593	4,026	.9	25.8	Do.
60L.....	2,477	0	0	0	2,284	2,593	4,026	.9	25.8	Do.
61L.....	2,483	0	0	0	2,284	2,593	4,026	.9	25.8	Do.
62L.....	2,489	0	0	0	2,284	2,593	4,026	.9	25.8	Do.
63L.....	2,921	0	301	135	2,293	3,494	4,918	0	40.0	Do.
64L.....	2,919	0	301	135	2,293	3,494	4,918	0	40.0	Do.
65L.....	2,919	0	301	135	2,293	3,494	4,918	0	40.0	Do.
66L.....	2,896	0	301	135	2,293	3,494	4,918	0	40.0	Dihedral, lower wing, increased from 3° to 4.6°.
68L.....	2,913	0	301	135	2,293	3,494	4,918	0	40.0	Do.
69L.....	2,907	0	301	135	2,293	3,494	4,918	0	40.0	Do.
70L.....	2,495	0	0	0	2,284	2,593	4,026	.9	25.8	Do.
71L.....	2,495	0	0	0	2,284	2,593	4,026	.9	25.8	Do.
72L.....	2,495	0	0	0	2,284	2,593	4,026	.9	25.8	Do.
76L.....	2,501	0	0	0	2,284	2,593	4,026	.9	25.8	Fabric stripped from empennage.
77L.....	2,495	0	0	0	2,284	2,593	4,026	.9	25.8	Do.
78L.....	2,495	0	0	0	2,284	2,593	4,026	.9	25.8	Do.

¹ Angle between X body axis and X^{1V} principal axis.

² "Ailerons with spin" is aileron deflection such that in normal flight the airplane would be caused to roll in the direction of the rolling of the spin.

³ Dihedral values given are for the lower wing; interplane struts were not changed.

