

## REPORT No. 482

# WING-FUSELAGE INTERFERENCE, TAIL BUFFETING, AND AIR FLOW ABOUT THE TAIL OF A LOW-WING MONOPLANE

By JAMES A. WHITE and MANLEY J. HOOD

### SUMMARY

*This report presents the results of an investigation of the wing-fuselage interference of a low-wing monoplane conducted in the N.A.C.A. full-scale wind tunnel on the "McDonnell" airplane. The tests included a study of tail buffeting and the air flow in the region of the tail. The airplane was tested with and without the propeller slipstream, both in the original condition and with several devices designed to reduce or eliminate tail buffeting. The devices used were wing-fuselage fillets, an N.A.C.A. cowling, reflexed trailing edge of the wing, and stub auxiliary airfoils.*

*The use of proper fillets practically eliminated the wing-fuselage interference and greatly reduced the tail vibrations due to buffeting. An N.A.C.A. cowling reduced the buffeting and interference effects to unobjectionable magnitudes at angles of attack up to within about 3° of the stall. A large fillet alone gave the greatest reduction in buffeting effect, reducing the tail vibrations to one seventh their original amplitude, but the combination of the large fillet and N.A.C.A. cowling gave the best all-round results. This combination reduced the tail oscillations due to buffeting to one fourth their original amplitude, increased the maximum lift 11 percent, decreased the minimum drag 9 percent, increased the maximum lift/drag ratio of the whole airplane 19 percent, and increased the effectiveness of the elevator about 40 percent at angles of attack in the landing range. The reflexed trailing edge had a minor effect and the auxiliary airfoils in the best position tested were considerably inferior to the fillets. With the propeller operating, the interference effects were practically eliminated, even with the airplane in the original condition.*

*The elimination of the wing-fuselage interference slightly decreased the longitudinal stability of the airplane.*

*Records of the fluctuations in the dynamic pressure of the air stream at the tail show a prominent wake-fluctuation frequency of the order of magnitude of the natural frequency of the tail vibrations.*

### INTRODUCTION

The increasing use of low-wing monoplanes has emphasized the susceptibility of this type of airplane to detrimental interference at the intersection of the wing

and fuselage. In addition to decreasing the aerodynamic efficiency, this interference often causes a loss of longitudinal control and a violent shaking, or buffeting, of the tail of the airplane by the eddying wake from the wing roots. Tail buffeting may become so severe in some cases as to endanger the tail structure. In at least one instance it was considered as a possible cause of the failure of a low-wing monoplane that broke to pieces in the air (references 1 to 4, inclusive).

Methods have been suggested for reducing or eliminating wing-fuselage interference and buffeting, and some tests have been conducted on small-scale models and in flight (references 2 and 5 to 9, inclusive). This report covers the results of tests conducted in the N.A.C.A. full-scale wind tunnel on a low-wing monoplane that was subject to tail buffeting. The tests included an investigation of the wing-fuselage interference and buffeting with the airplane in its original condition and with various devices installed to eliminate or reduce the detrimental effects. As the detrimental effects appear to be directly due to a premature breakdown of the flow at the wing-fuselage intersection, the devices were designed with a view to their ability to postpone this breakdown of the flow to the angle of attack at which the entire wing stalls. The devices tested were two different wing-fuselage fillets, an N.A.C.A. cowling, a reflexed trailing edge next to the fuselage, auxiliary airfoils of short span in three different positions, and various combinations of the above.

The value of the various devices was determined by visual observation of the air flow at the wing-fuselage intersection by means of strings; measurements of the lift, drag, and pitching moments of the airplane; records of the vibrations of the tail; and surveys of the direction and speed of the air flow at the tail of the airplane, including records of the fluctuations of the air speed. Observations were made both with and without the slipstream from the airplane propeller.

Part of the results given here have been previously published as a technical note (reference 10).

### APPARATUS

Wind tunnel.—The tests discussed in this report were conducted in the N.A.C.A. full-scale wind tunnel. The wind tunnel, the balance for measuring the forces

and moments, and the apparatus used for determining the air speed and direction at any point in the jet are described in reference 11.

**Airplane.**—The *McDonnell* airplane, a low-wing monoplane originally built for entry in the Daniel Guggenheim Safe Aircraft Competition in 1929, was chosen for these tests because it was reported by pilots to be subject to tail buffeting. Flight tests of the *McDonnell* airplane are described in reference 12. Figure 1 is a photograph of the airplane mounted in the wind tunnel; figure 2 is a 3-view drawing showing its principal dimensions; and figure 3 is a view of the intersection of the wing and fuselage. The airplane is equipped with a Warner Scarab engine having a rating of 110 horsepower at 1,850 r.p.m. The airplane is provided with movable leading-edge slots and trailing-edge

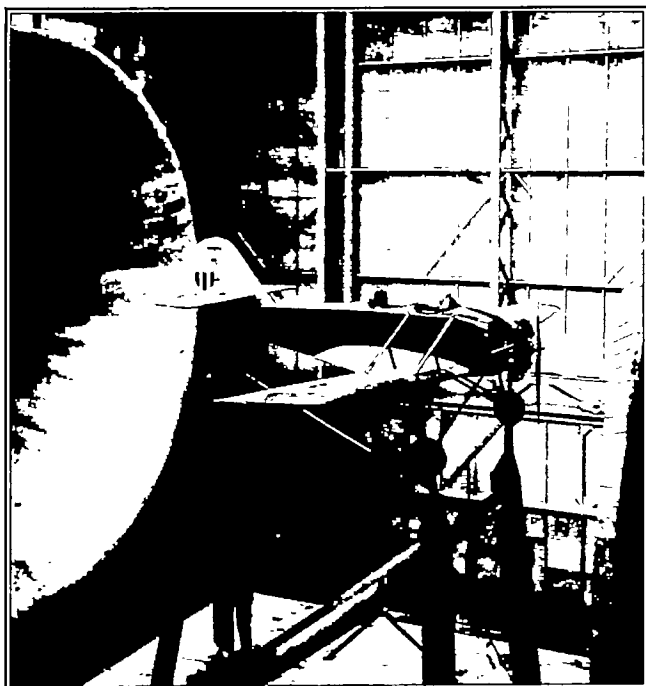

FIGURE 1.—The *McDonnell* airplane with large fillet in full-scale wind tunnel.

flaps, but for these tests the slots were covered with doped fabric and the flaps locked in the neutral position. After preliminary tests had been made, a walkway that extended from the fuselage to 10 inches outboard and raised the top surface of the right wing five eighths of an inch above the normal profile from 15 to 69 percent of the chord was removed, and the gaps between the wings and fuselage, which were as much as 3 inches wide on the under side, were covered. The stabilizer was set at an incidence of  $0.6^\circ$  with respect to the thrust axis for all the tests and, except when elevator effectiveness was being measured, the elevator was locked in the neutral position.

**Fillets.**—The wing-fuselage fillets were designed to reduce the rate at which it was necessary for the air in this region to diverge in order to follow the surfaces. The radius was small at the leading edge and a short

distance back started increasing smoothly to a maximum at the trailing edge, behind which the fillet was faired into the fuselage. The principal difference between the two fillets was in size, hence they will be referred to as the "small fillet" (figs. 4 and 5) and the "large fillet" (figs. 6 and 7). Another difference was that the small fillet had a constant radius from the leading edge back to 41 percent of the chord, whereas the radius of the large fillet began to increase at 6.6 percent of the chord back of the leading edge.

**N.A.C.A. cowling.**—The N.A.C.A. cowling (fig. 8) consisted of a hood that was placed over the engine and nose of the airplane without alteration being made in the original fuselage lines. The hood was designed in accordance with the information in reference 13, except that its cross section did not resemble an airfoil profile because it consisted of only one thickness of metal.

**Reflexed trailing edge.**—The modification of the wing root, herein called a "reflexed trailing edge" (fig. 9), was designed to decrease the incidence at the wing root. The lower surface of the wing, which had an upward curvature (N.A.C.A.-M6 section), was extended to the rear and a new upper surface formed of straight-line elements from the new trailing edge to the points of tangency with the upper surface of the original wing. The fillet tested in combination with this reflexed trailing edge (fig. 10) was similar to the large one previously described.

**Auxiliary airfoils.**—The auxiliary airfoils used in these tests were of the N.A.C.A. 22 section, had a 10-inch chord (14.7 percent of the main wing chord), and extended 30 inches from the fuselage on each side. They were tested in three positions near the leading edge of the wing (see fig. 15), the first position being similar to that found to be the optimum in the investigation reported in reference 14.

#### METHODS

**Air flow at wing roots.**—The air flow at the wing roots was studied by noting the behavior of a lightweight string on the end of a slender stick held by an observer in the cockpit.

**Force and moment measurements.**—The power-off lift, drag, and pitching moments were all measured with the propeller removed. The power-on measurements were made with the propeller turning at such a speed that its thrust just balanced the drag of the airplane (due allowance being made for jet-boundary effect), thus simulating steady level-flight conditions. As the jet-boundary corrections could be only estimated beforehand, it was not feasible to adjust the engine speed so as to give exactly zero net drag. Therefore, three readings were taken at each angle of attack at three propeller speeds near the proper value and the value of lift for zero net drag was found from a plot of these points against net drag. All tests were

made at an air speed of 55 to 60 miles per hour except in the case of the power-on tests, where at high angles of attack it was necessary to reduce the speed to keep the drag within the range of the available thrust.

Records of tail buffeting.—The vertical movements of the tip of the stabilizer were recorded on a moving film by means of an N.A.C.A. control-position recorder. From these records the amplitude and frequency of the motions of the tail surfaces were determined. The instrument was mounted on a solid base and connected to the stabilizer by an 0.008-inch diameter piano wire shielded from the wind by a steel tube.

main supports at the landing-wheel axles only by cables secured to the forward part of the fuselage.

Most of the records were taken at an air speed of approximately 58 miles per hour, but a few were taken at speeds between 35 and 60 miles per hour to determine the effect of change in speed.

Air flow at tail.—The direction and speed of the air flow at the tail in a vertical plane through the elevator hinge line were measured with all the tail surfaces removed, using the combined pitot-static, yaw, and pitch tube and auxiliary apparatus described in reference 11. In addition to the measurements of average

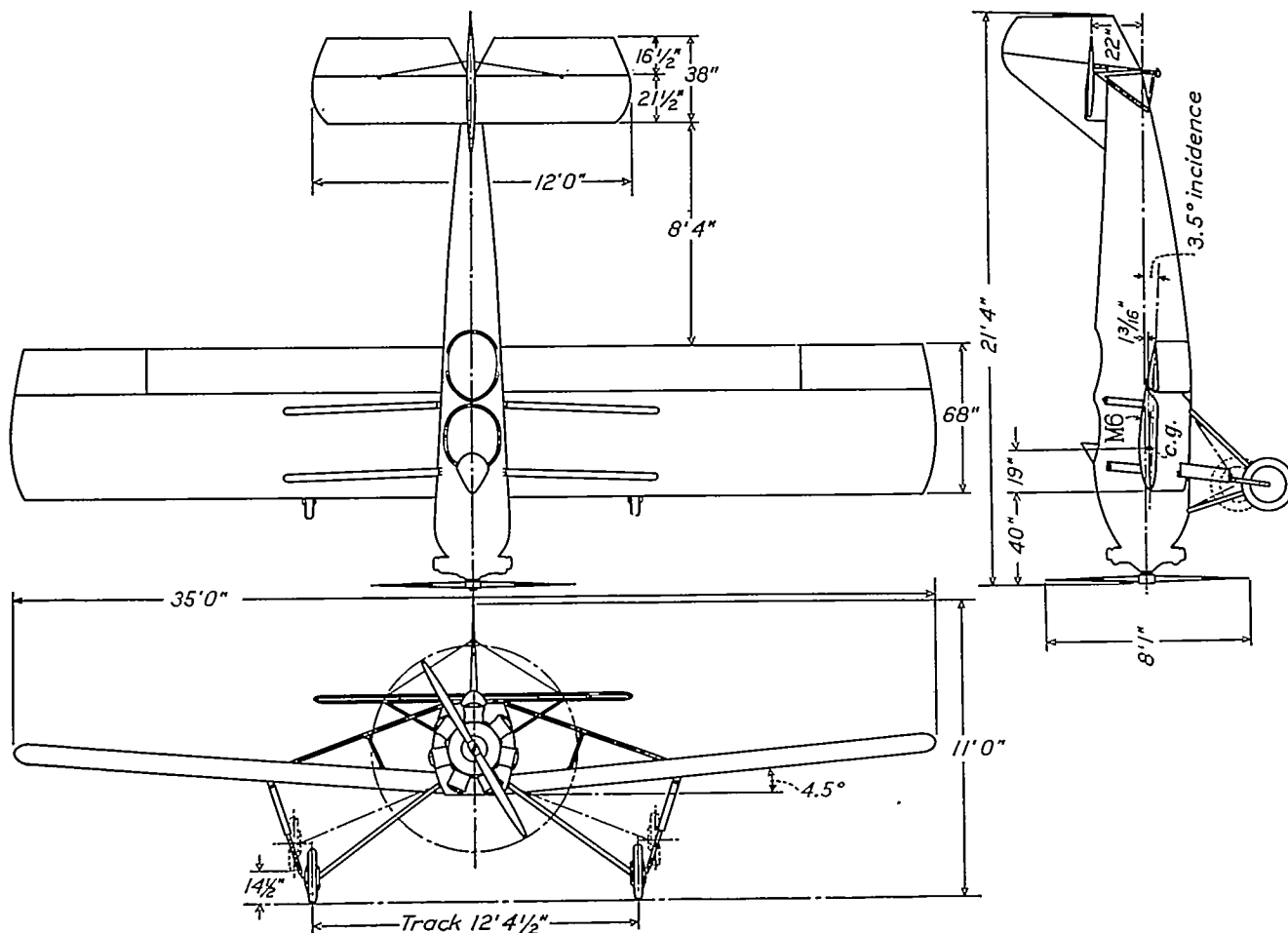

FIGURE 2.—Three-view drawing of the McDonnell airplane.

The natural frequency of the piano wire and instrument was about 34 cycles per second, which is almost four times the highest frequencies recorded. Play and friction in the instrument caused errors in indicated amplitudes of the vibrations probably not exceeding one eighth inch.

During most of these tests the tail of the airplane was supported by a rigid A-frame fastened to the tail-post. In order to determine the effect of this rigid support, records were made of the movements of the stabilizer tip and the rear end of the fuselage while the tail of the airplane was free from external support, the airplane being prevented from turning about the

speed and direction, several records were made with a recording manometer connected to the pitot tube to determine the frequency of the air-speed fluctuations in the wake from the wing roots and the relative magnitudes of the fluctuations at different positions near the tail. These records were not entirely satisfactory because of the large amount of damping in the long rubber tubes required to reach from above the air stream down to the pitot tube near the tail of the airplane. Consequently the true magnitude of the fluctuations cannot be determined from these records; however, some idea of the frequencies involved can be obtained.

**RESULTS**

**Air flow at wing root.**—The action of the string held in the region of the wing-fuselage intersection indicated that, except when the airplane was equipped with some of the most effective devices, the air flow over the upper surface of the wing began to break down near the intersection of the wing and fuselage and that the turbulent region spread laterally as the angle of attack was increased. With the airplane in the original condition the turbulent flow extended approximately 3 feet outboard from the fuselage at 14° angle of attack. The approximate angles of attack at which the air flow over the root of the wing first burredled

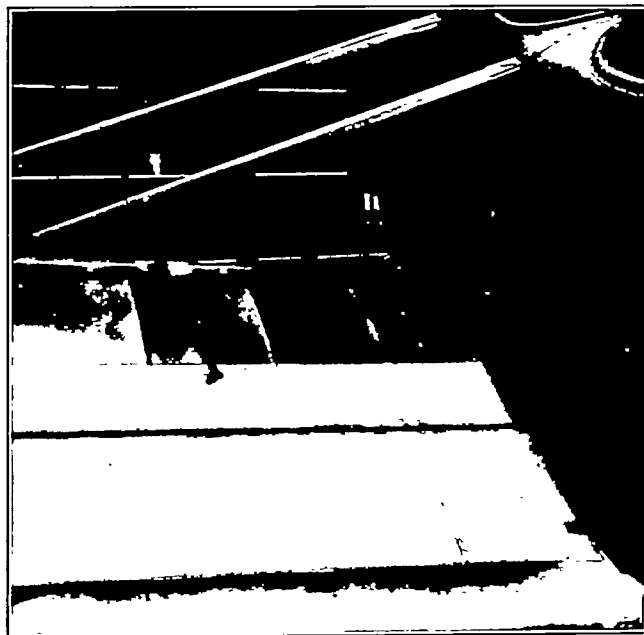

FIGURE 3.—Wing-fuselage intersection of *McDonnell* airplanes.

when the airplane was equipped with the various devices with power off were as follows:

Original condition.....	5°.
Small fillet.....	12°.
Large fillet.....	15°.
N.A.C.A. cowling.....	14°.
Small fillet and N.A.C.A. cowling.....	17° (at stall).
Large fillet and N.A.C.A. cowling.....	17° (at stall).
Reflexed trailing edge.....	7°.
Reflexed trailing edge and N.A.C.A. cowling.....	16° (at stall).
Reflexed trailing edge and fillet.....	Above stall.
Reflexed trailing edge, fillet, and N.A.C.A. cowling.....	Above stall.
Auxiliary airfoil in position 1.....	7°.
Auxiliary airfoil in position 2.....	7°.
Auxiliary airfoil in position 3.....	10°.

When the auxiliary airfoils were used, vortices trailing from their tips were evident. When the N.A.C.A. cowling was used, particularly in combination with any of the fillets and both with and without the slipstream, the action of the string indicated the presence of trailing vortices approximately concentric with the fillets.

The direction of rotation of these vortices was the reverse of what it would be for vortices corresponding to a loss of lift at the center section.

**Lift and drag characteristics.**—The power-off lift and drag data are presented in four groups of polars and lift and drag curves. The first group (figs. 11 and 12) compares the various fillets and fillet combinations; the second (figs. 13 and 14) shows the effects of the reflexed trailing edge alone and with the cowling and fillet; the third (figs. 15 and 16) shows the effects of the auxiliary airfoil in three positions; and the fourth (figs. 17 and 18) shows the effects of the cowl-

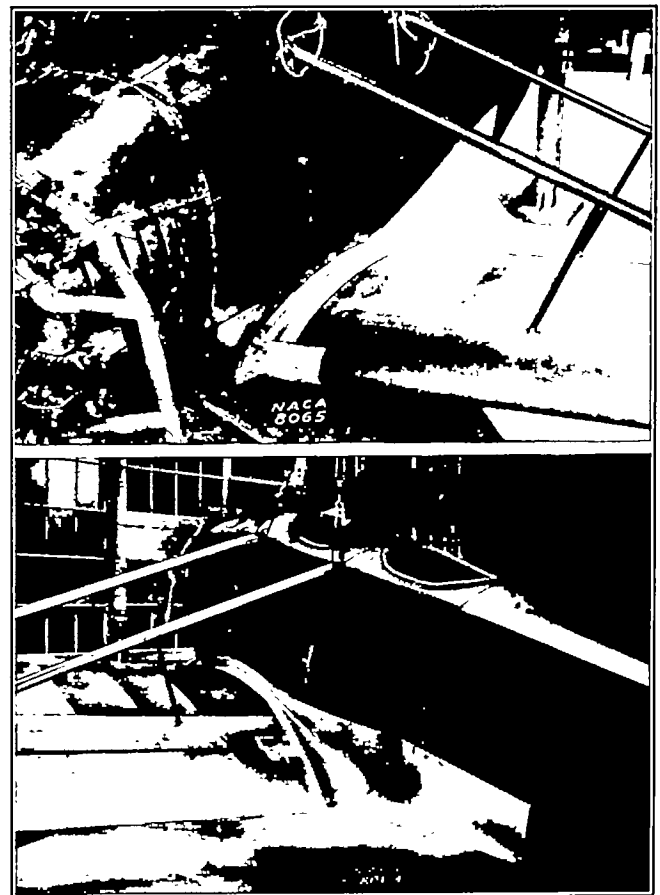

FIGURE 4.—Small fillet on *McDonnell* airplane.

ing alone and summarizes the other groups. In addition, a representative polar is shown with the experimental points (fig. 19). The theoretical induced-drag curve based on the geometrical aspect ratio of the wing (6.2) is included with each group of polars.

Power-on lift curves, corresponding to level flight, are presented for the original condition and for the condition with the large fillet and cowling (figs. 20 and 21). All the other conditions tested gave results practically the same as those for the large fillet and cowling. No means were available for determining the thrust of the propeller, so it was not possible to determine exactly either the effect of the slipstream on the drag characteristics of the airplane or what part of the total lift



was due to the vertical component of the propeller thrust. An approximate correction for this vertical component of thrust was applied; however, in order to

attack, the vertical component of a thrust large enough to overcome the drag of the airplane without the slipstream.

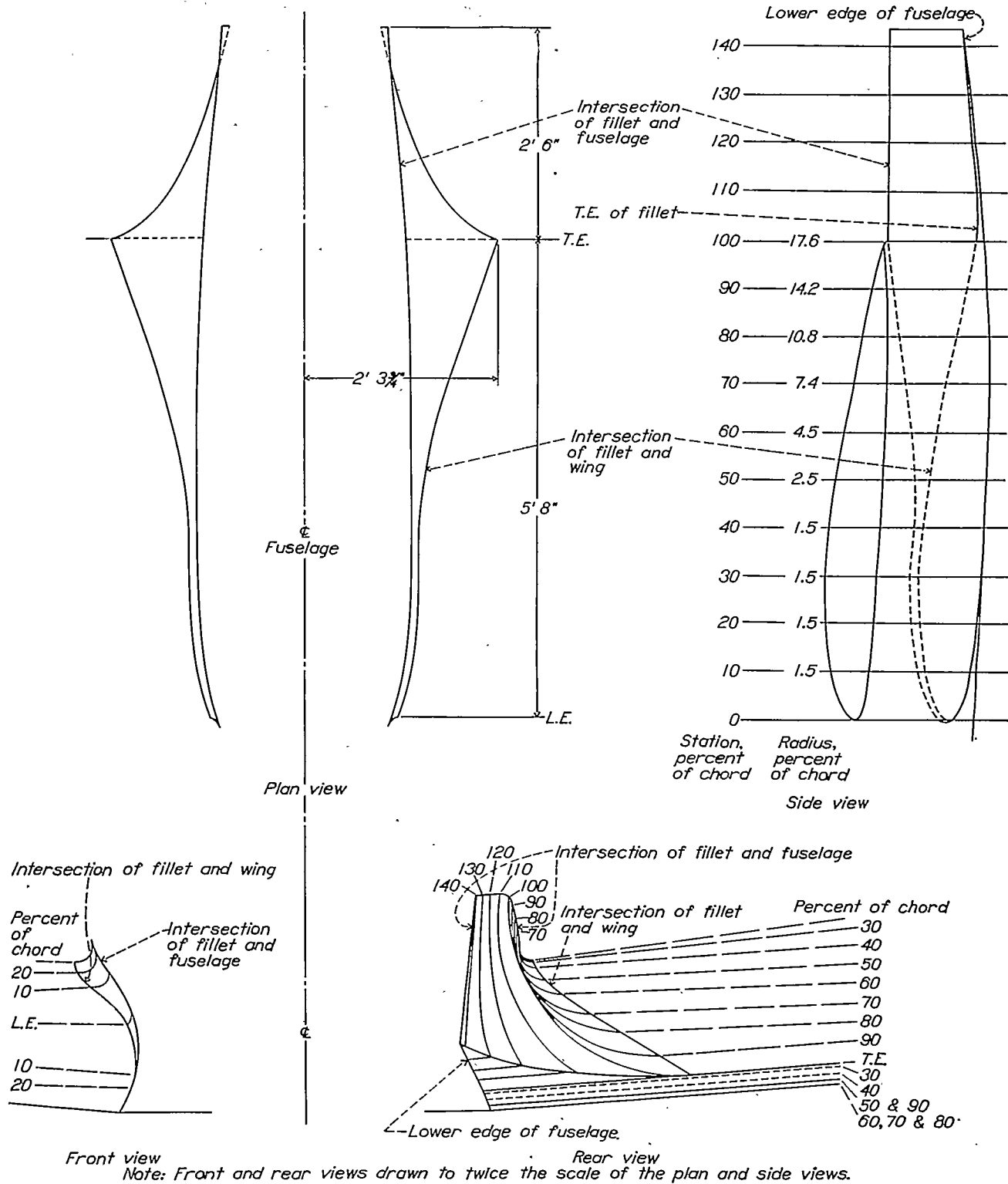

FIGURE 5.—Drawing of the small fillet.

make the difference between the power-off and power-on lift curves more nearly represent the effect of the slipstream; the lift curves are shown both with and without this correction. These approximate corrections were arrived at by computing, for each angle of

All coefficients are based on the original wing area of 196.5 square feet. The added area due to the addition of the large fillet and the reflexed trailing edge amounted to about 2.5 percent and 7 percent, respectively.

Pitching moments.—Curves of pitching moments about the center of gravity plotted against angle of attack are shown for the power-off condition in figure 22. Curves of pitching moments with the tail surfaces removed and pitching moments due to the tail alone are shown in figure 23. Figure 24 shows the pitching-moment curves for two power-on conditions. The power-on pitching moments were found to be practically the same for all conditions. The influence of several of the devices on elevator effectiveness is shown by curves of pitching moment plotted against elevator angle for an angle of attack just below the stall (fig. 25). The pitching-moment coefficients are



FIGURE 6.—Large fillet on McDonnell airplane.

based on the original wing area (196.5 square feet) and the original mean chord of 5.62 feet.

Tail buffeting.—Typical records of the motion of the stabilizer tip are shown in figure 26. Curves of the maximum amplitudes of tail vibrations for various conditions of the airplane are shown in figure 27. Amplitude is here considered as the deflection between adjacent extremes of the up-and-down motion and is given in inches of motion normal to the plane of the stabilizer. The amplitude of stabilizer-tip movements with the propeller operating is not included in figure 27 because it did not vary consistently enough to permit the drawing of curves. Nearly all the maximum de-

flections measured with power on fall between 0.1 and 0.4 inch for angles of attack below the stall. The values in figure 27 were all obtained with the rear end of the fuselage rigidly supported. When it was free from external support the amplitude of stabilizer-tip movement was nearly doubled and the vertical movement of the rear end of the fuselage itself was only about one fifth as great as that of the stabilizer tip. Figure 28 shows the variation in amplitude with changes of air speed between 35 and 60 miles per hour.

The natural frequencies of the stabilizer were as follows:

	<i>Vibrations per second</i>
With rear end of fuselage rigidly supported.....	7.3
With rear end of fuselage unsupported.....	8.5

For each method of support the predominant frequency of the tail vibrations caused by buffeting was approximately the same as the corresponding natural frequency.

The stiffness of the stabilizer and fuselage was such that, when the rear end of the fuselage was externally supported, the stabilizer tip was deflected 1 inch by a force of 60 pounds concentrated at the tip.

Air flow at tail.—The surveys of the air flow at the tail are shown by dynamic-pressure contours and direction vectors (figs. 29 to 33, inclusive). The contours show lines of equal dynamic head expressed as the ratio of measured dynamic head to the dynamic head at the same point in the air stream with the airplane removed. The vectors show the component of the velocity in the plane of the survey, that is, normal to the tunnel axis. The length of the vector shows the magnitude of the component velocity  $v$  relative to the total velocity  $V_0$  in the direction of the flow at the point considered and therefore is also a measure of the angular deflection of the air flow from its initial direction parallel to the tunnel axis. When, as in this case, the angular deflections are relatively small, the scale of vector lengths can be divided so as to give directly the deflection in degrees in any direction from the tunnel axis by scaling the proper component of the vector. Thus, the angles of downwash and yaw of the air flow can be determined directly by scaling the vertical and horizontal components of the vectors. The surveys are presented with the vector scale graduated in terms of both  $v/V_0$  and the angular deflection from the tunnel axis. A specimen record of the fluctuation in dynamic pressure at the tail is shown in figure 34.

Wind-tunnel corrections.—All results except the velocity-component vectors shown on the surveys of air flow at the tail are corrected for tunnel effects.

#### DISCUSSION

Air flow at wing roots.—The visual observations of the air flow at the wing roots showed that the interference caused a premature stalling of the wing at that point. Several factors tend to cause this section to

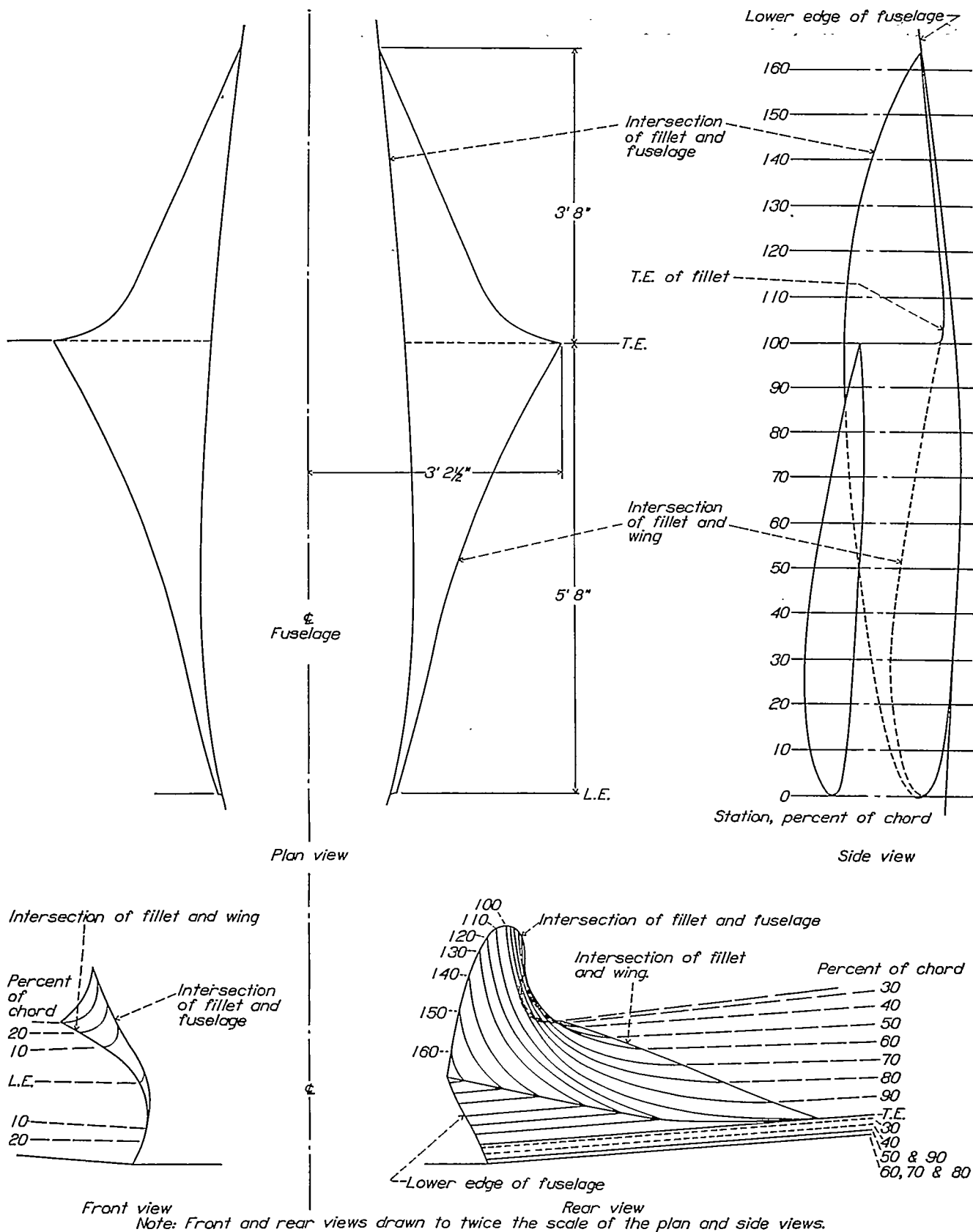

FIGURE 7.—Drawing of the large fillet.

stall prematurely: The presence of the fuselage, which tapers to the rear and toward the bottom, increases the volume into which the air coming over the wing in that region must diverge; the side of the fuselage offers additional frictional resistance increasing the adverse pressure gradient; and the large drag of the engine absorbs much kinetic energy from the air and makes it less able to overcome the adverse pressure gradient. The observations showed that the disturbance started in this region at an angle of attack as low as  $5^\circ$  for the airplane in the original condition. The use of devices which either decreased the rate at which the air flow

fuselage so that the part of the wing on each side of the fuselage tended to act independently as a wing of low aspect ratio.

The effectiveness of the fillets and N.A.C.A. cowling in preventing the premature break down of flow at the wing-fuselage intersection is attested by the straightness of the lift curves and the parallelism of the polars to the induced-drag polar as seen in figures 17 and 18. Both the large fillet and the N.A.C.A. cowling postponed the breakdown of the flow to within  $3^\circ$  of the angle of maximum lift, although the double curve near maximum lift when the cowling was used alone indicates an unstable state of flow at high angles of attack. Figures 17 and 18 also show that the reflexed trailing edge increased the angle of attack at which the flow started to break down by about the same amount that the incidence of the wing at the root was changed ( $2^\circ$  or  $3^\circ$ ), but once the flow started to break down the reflexed trailing edge had little effect. The improvement due to the auxiliary airfoils in the best position tested was only about half as much as that due to the fillets or the N.A.C.A. cowling. It is possible, however, that this is not the optimum position for the airfoils, as only three positions were tested.

When used alone the large fillet was found to give slightly better lift and drag characteristics than the small one, as shown by comparison of the two polars (fig. 11); but when used with the N.A.C.A. cowling the results were practically identical.

In addition to its effect on the wing-fuselage interference the N.A.C.A. cowling gave a large reduction in parasite drag. The minimum drag coefficient was reduced from 0.0637 to 0.0590 by the cowling; to 0.0625 by the large fillet; and to 0.0580 by the combination of large fillet and cowling.

The best lift and drag characteristics were obtained when the large fillet and N.A.C.A. cowling were used together. The use of this combination eliminated most of the wing-fuselage interference, increased the maximum lift 11 percent above its original value, decreased the minimum drag 9 percent, and increased the maximum lift/drag ratio 19 percent.

The slipstream prevented a premature break down of the flow near the wing-fuselage intersection in all except the original condition and even in this condition the improvement was very great (figs. 20 and 21). In the original condition the lift curve begins to break over at almost the same angle of attack (about  $6^\circ$ ) as without the slipstream; but as the angle of attack was increased, corresponding to a lower flying speed in level flight, the slipstream velocity became much greater relative to the air speed until it was sufficient to smooth out the flow, and at  $12^\circ$  the lift was almost as high as when the large fillet and cowling were used. Beyond  $12^\circ$  the flow apparently started to break away again. It is not practicable, however, to depend on

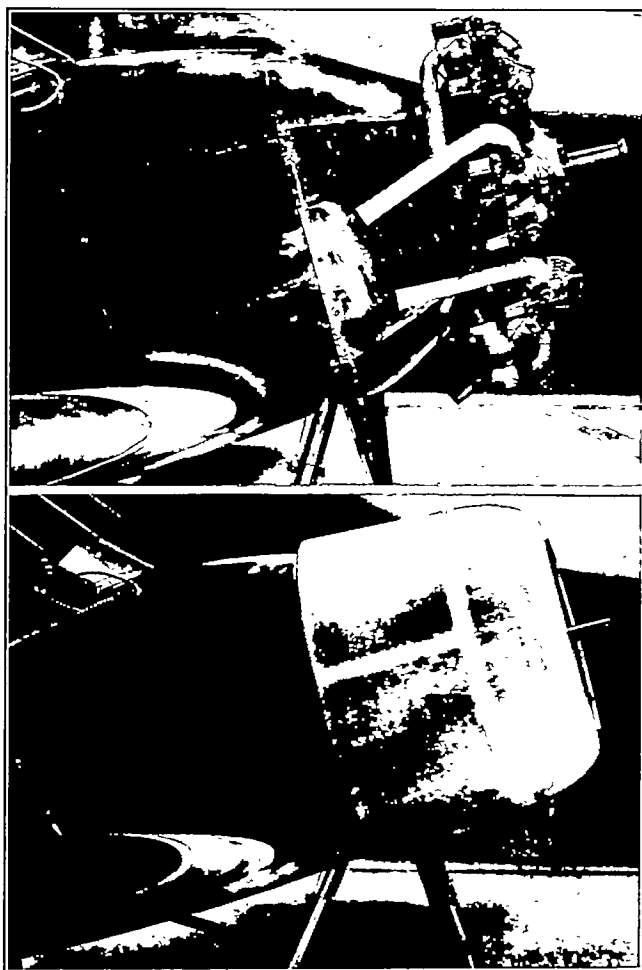

FIGURE 8.—Nose of *McDonnell* airplane in original condition and with N.A.C.A. cowling.

had to diverge or increased the kinetic energy of the air next to the fuselage postponed the break down of flow to much higher angles of attack.

Lift and drag characteristics.—A comparison of the polar for the airplane in the original condition (fig. 19) with the theoretical induced-drag polar for the whole wing (aspect ratio = 6.2) and for the portion at one side of the fuselage (aspect ratio = 2.9) agrees with the observations of the air flow at the wing roots in indicating that even at relatively low angles of attack the smooth flow over the wing broke down next to the



the slipstream for maintaining the smooth flow, especially during landing.

Preliminary tests showed that the presence of the raised walkway next to the fuselage had no appreciable effect on the characteristics of the airplane equipped with the small fillet and that removing the walkway and covering the gaps between the wing and fuselage when the airplane was not equipped with any of the special devices had a negligible effect.

The maximum lift coefficient of the airplane in its original condition, as determined by these tests, was

pitching moments between the various conditions with power on.

The effectiveness of the elevator (fig. 25) was increased by the devices that reduced the wing-fuselage interference, probably because of the higher velocity of flow over the tail (figs. 29 to 33, inclusive). Additional data taken at other angles of attack showed that the improvement extended over about the same angle-of-attack range as the corresponding improvement in lift and drag characteristics (from about 8° to beyond the stall).

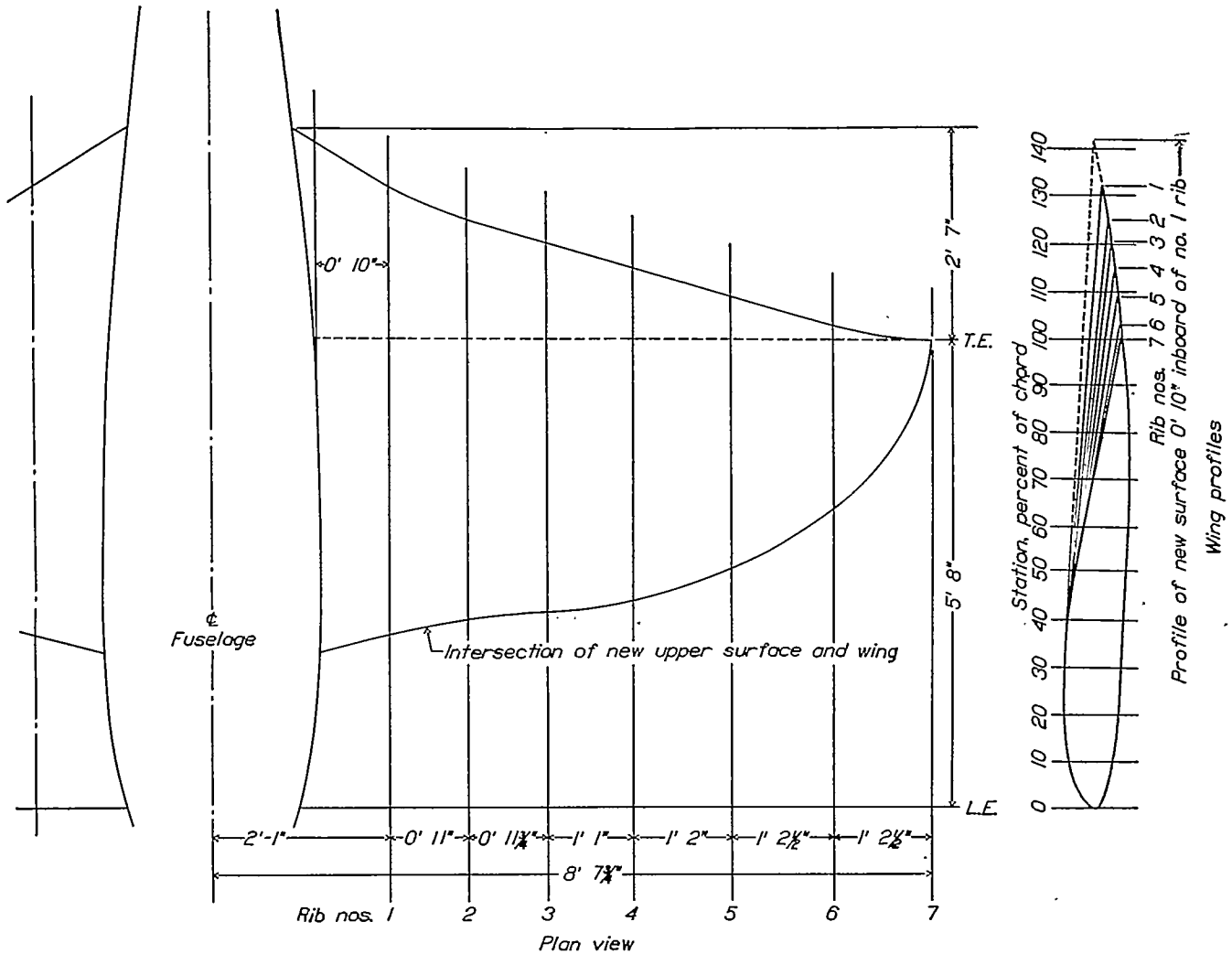

FIGURE 9.—Drawing of the reflexed trailing edge.

considerably higher than the highest value measured in flight with slots closed and flaps neutral (reference 12). This difference was due to the fact that in flight the pilot was not able to maintain steady conditions long enough to take satisfactory records at angles of attack above 16°.

**Pitching moments.**—Improving the air flow at the wing roots resulted in a slight decrease in longitudinal stability (fig. 22), due mainly to the increased downwash at the tail (fig. 23). The curves of pitching moments with elevator neutral and with power on presented in figure 24 show that there is very little difference in

**Tail buffeting.**—The effectiveness of the various devices in reducing tail buffeting is clearly shown in figure 27. The oscillations due to buffeting were reduced to amplitudes small enough to be considered unobjectionable throughout the range of normal flight attitudes by the use of the fillets, either alone or in combination with the N.A.C.A. cowling or the reflexed trailing edge. The use of the large fillet alone gave the least buffeting, reducing the oscillations to one seventh their original amplitude. The use of this fillet with the cowling, the combination giving the best lift and drag characteristics, reduced the vibrations to

one fourth their original amplitude. The slipstream was practically as effective as the fillets.

In general, the various devices decreased the buffeting in about the same proportion that they improved



FIGURE 10.—Reflexed trailing edge with fillet on McDonnell airplane.

the lift and drag characteristics. The N.A.C.A. cowling was an exception to this rule because whenever it

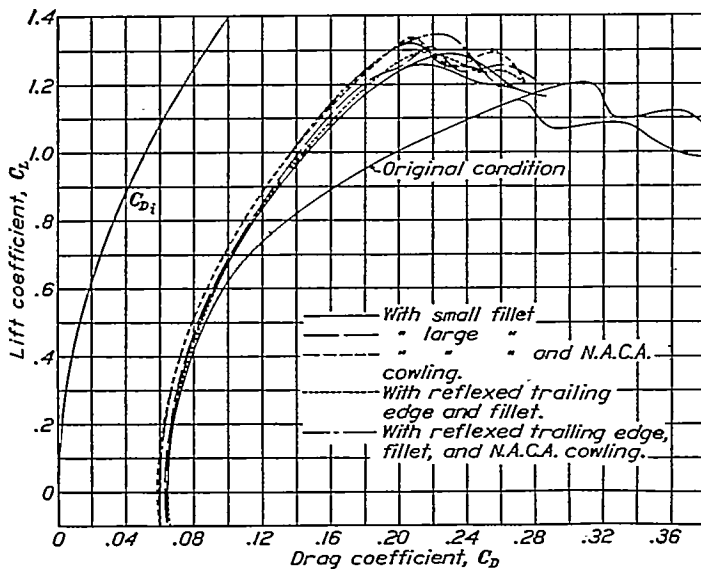

FIGURE 11.—Polars for McDonnell airplane with various fillets. Corrected for tunnel effects. Power off.

was used the buffeting was greater than would have been expected from the improvement in the polar. This excessive buffeting was probably due to the vor-

ticals mentioned in connection with the observations of the air flow at the wing root and seen on the survey of the air flow at the tail (fig. 32).

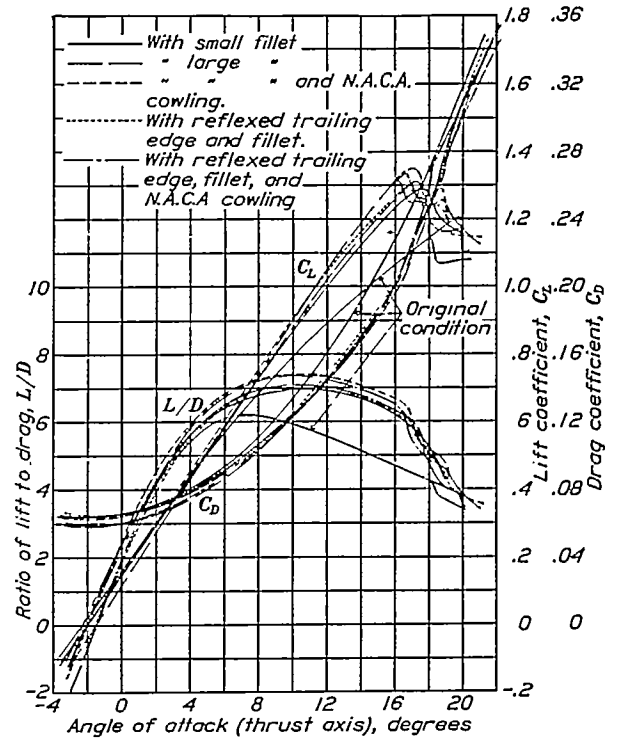

FIGURE 12.—Lift and drag of McDonnell airplane with various fillets. Corrected for tunnel effects. Power off.

The records of the stabilizer-tip movements (fig. 26) show the nature of the vibrations. It will be noted that the vibrations had a quite definite frequency

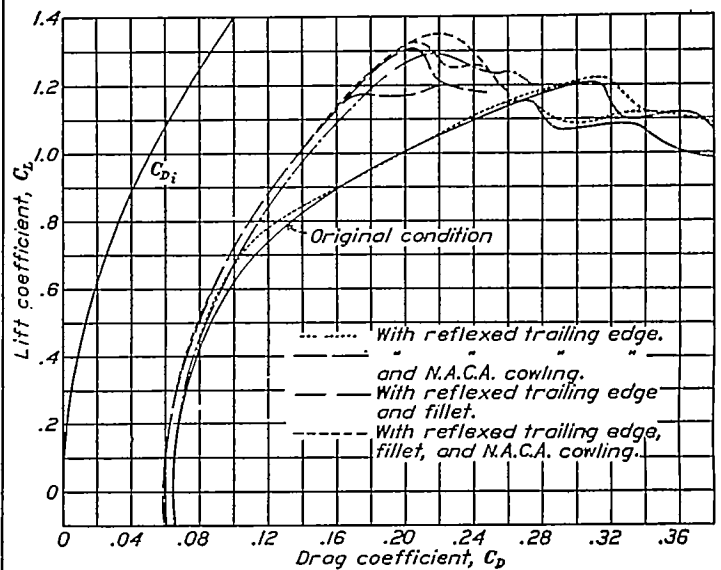

FIGURE 13.—Polars for McDonnell airplane with reflexed trailing edge. Corrected for tunnel effects. Power off.

which was practically the same as the free-vibration frequency of the stabilizer. The amplitude, however, was so irregular that to an observer the motion looked like a haphazard shaking of the tail. There appeared to be very little deflection of the stabilizer and elevator

as a beam, most of the deflection being due to twisting of the fuselage.

The vibrations of the stabilizer obtained under the conditions of these tests afford good comparisons be-

pendent upon the natural frequency of the tail structure, which is slightly higher with the tail unsupported.

The severity of buffeting was shown to increase rapidly with increase in air speed between 35 and 60

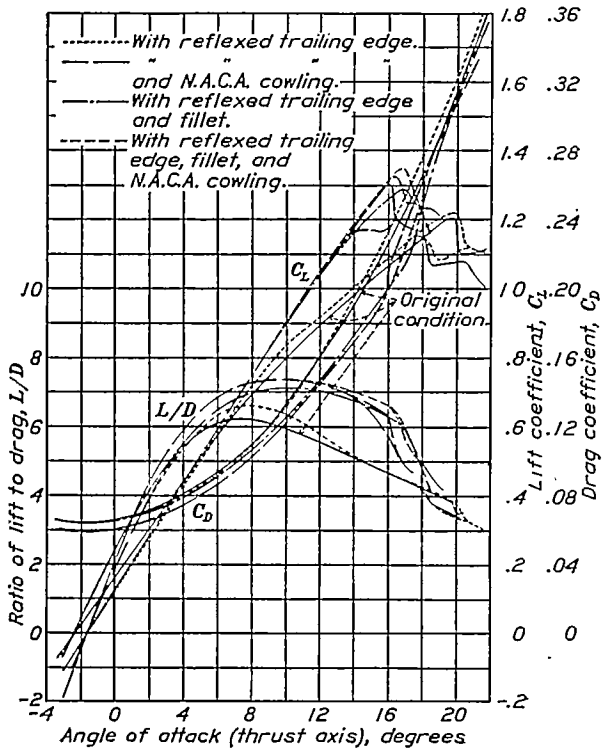

FIGURE 14.—Lift and drag of McDonnell airplane with reflexed trailing edge. Corrected for tunnel effects. Power off.

tween the degrees of buffeting under the various conditions tested, although the results of the special tests made with the rear end of the fuselage unsupported

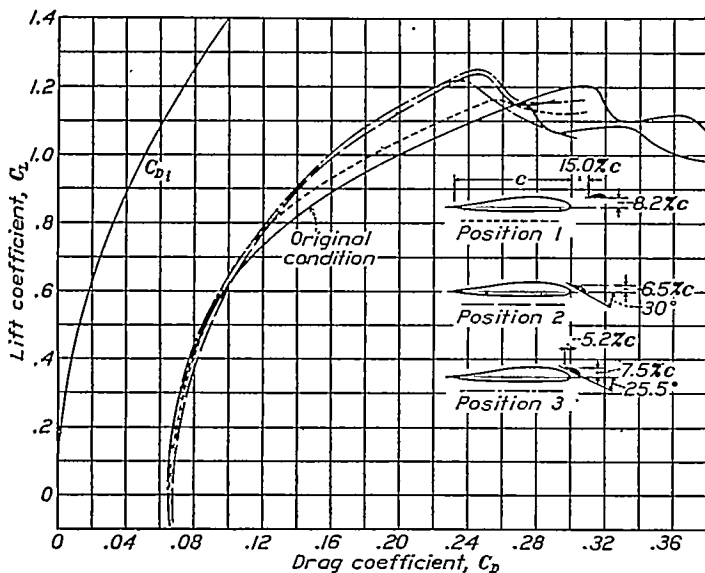

FIGURE 15.—Polars for McDonnell airplane with auxiliary airfoils. Corrected for tunnel effects. Power off.

indicate that in actual flight the magnitude of the oscillations would be about twice as great as the values given in figure 27. The frequency is apparently de-

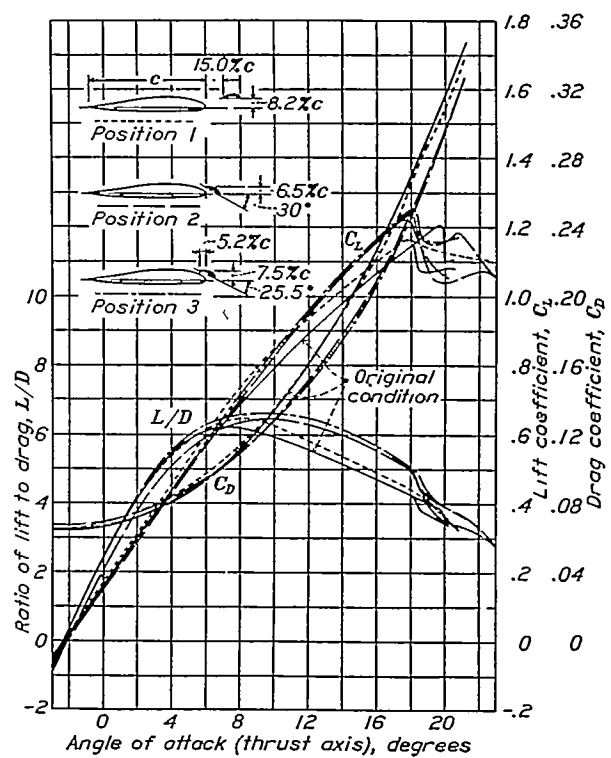

FIGURE 16.—Lift and drag of McDonnell airplane with auxiliary airfoils. Corrected for tunnel effects. Power off.

miles per hour (fig. 28). It cannot be assumed, however, that this rate of increase would continue at ve-

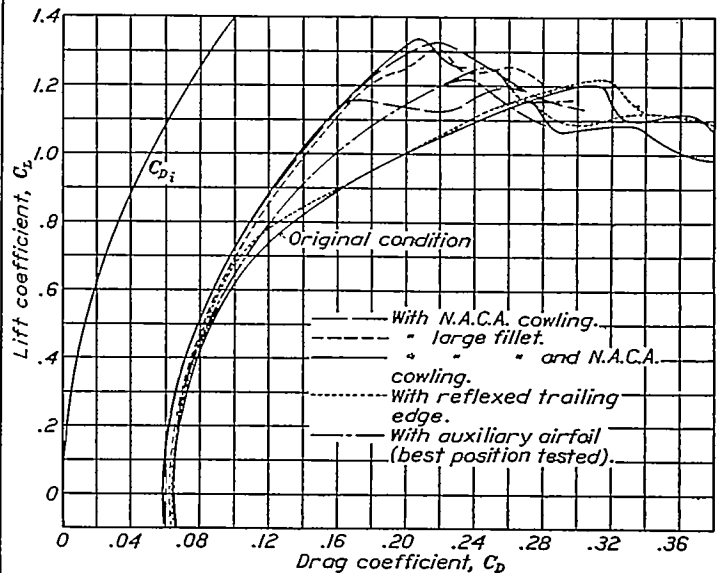

FIGURE 17.—Polars for McDonnell airplane comparing various devices. Corrected for tunnel effects. Power off.

locities above those investigated, as the relations may be affected by resonance between the natural frequency of the tail and the frequency of the buffeting eddies.

Air flow at tail.—The surveys of the air flow at the tail of the airplane substantiate the observations from the other data in regard to the effects of the wing-fuse-

(figs. 29 and 30) show that the part of the wing on each side of the fuselage tended to act as a separate wing

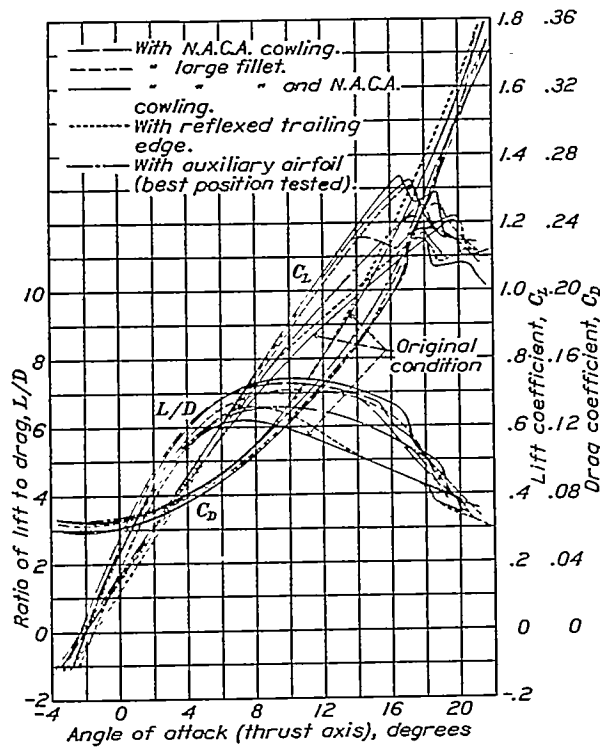

FIGURE 18.—Lift and drag of McDonnell airplane comparing various devices. Corrected for tunnel effects. Power off.

lage interference on the air flow and lift distribution and indicate in more detail how elimination of the interference reduced tail buffeting. The lift distribution

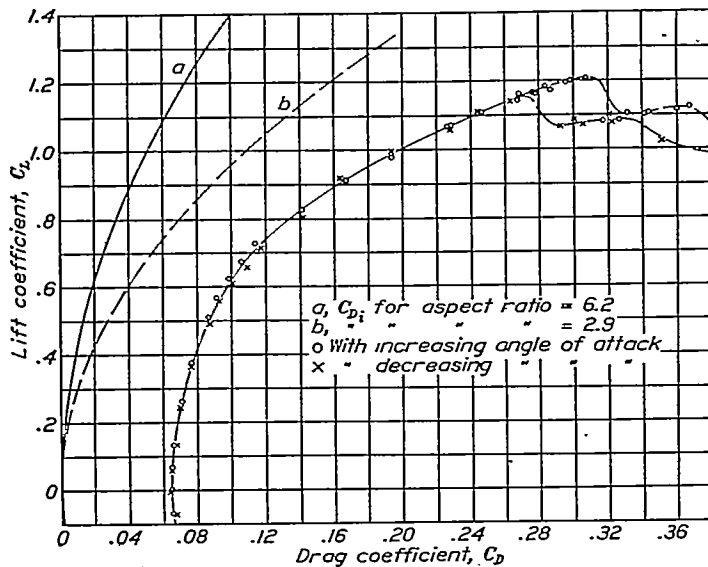

FIGURE 19.—Polar for McDonnell airplane in original condition. Corrected for tunnel effects. Power off.

near the fuselage for the various conditions is indicated by the downwash vectors and also by the vertical position of the wake from the wing roots. For the original condition, prominent vortices next to the fuselage

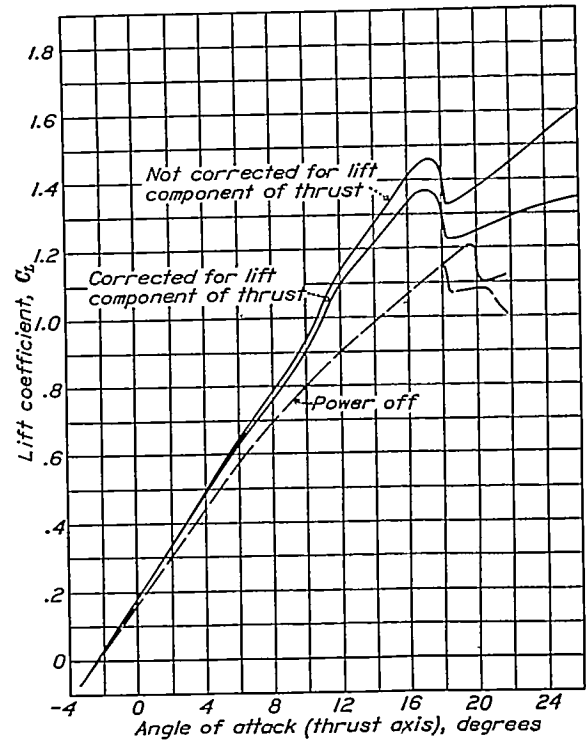

FIGURE 20.—Power-on lift of McDonnell airplane in original condition. Corrected for tunnel effects.

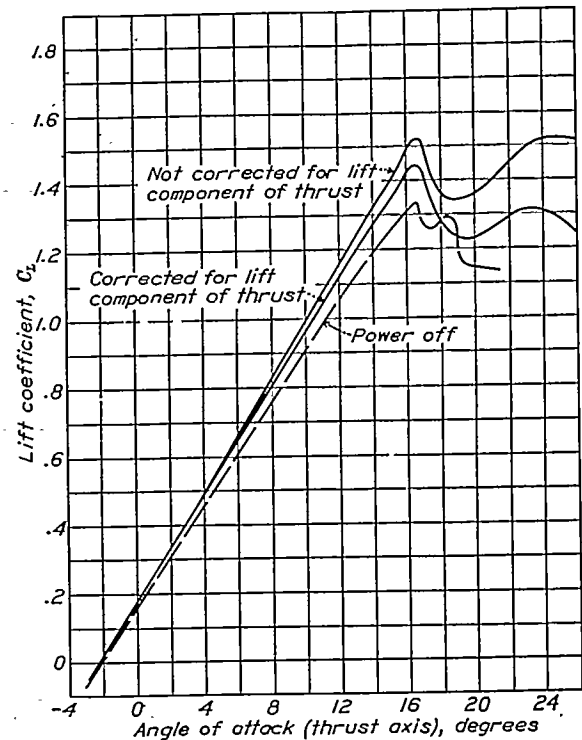

FIGURE 21.—Power-on lift of McDonnell airplane with large fillet and N.A.C.A. cowling. Corrected for tunnel effects.

with its pair of tip vortices. These vortices produced an upflow of the air near the fuselage which probably increased the tail vibrations by causing part of the



horizontal surfaces to be stalled. In the improved conditions, such as that with the large fillet (fig. 31) and with the N.A.C.A. cowling (fig. 32), the tur-

eliminated the vortices due to the wing-fuselage intersection.

Judging from the air-flow surveys for the original condition, it would not be possible to reduce the tail buffeting materially by moving the horizontal tail surfaces upward for any reasonable distance (figs. 29 and 30). Lowering the tail surfaces about 2 feet would cause quite an improvement, but would bring the stabilizer down near the bottom of the fuselage — an impracticable location. In any case, since the interference that causes tail buffeting also causes a loss in aerodynamic efficiency, it appears best to cure the

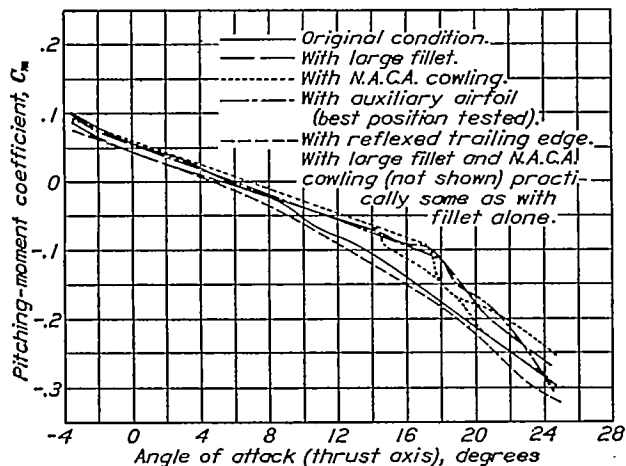

FIGURE 22.—Pitching moments of McDonnell airplane with various devices. Corrected for tunnel effects. Power off. Stabilizer  $0.6^\circ$  to thrust axis. Elevator  $0^\circ$  to stabilizer.

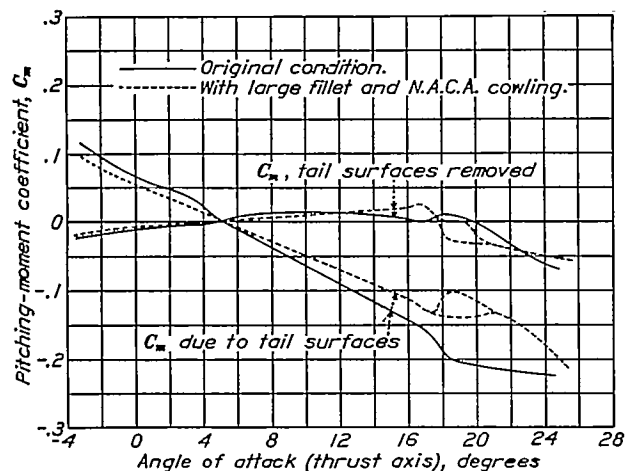

FIGURE 23.—Pitching moments due to tail of McDonnell airplane. Corrected for tunnel effects. Power off. Stabilizer  $0.6^\circ$  to thrust axis. Elevator  $0^\circ$  to stabilizer.

bulent wake from the wing roots was greatly reduced. The power-on survey (fig. 33) shows that even in the original condition the slipstream practically

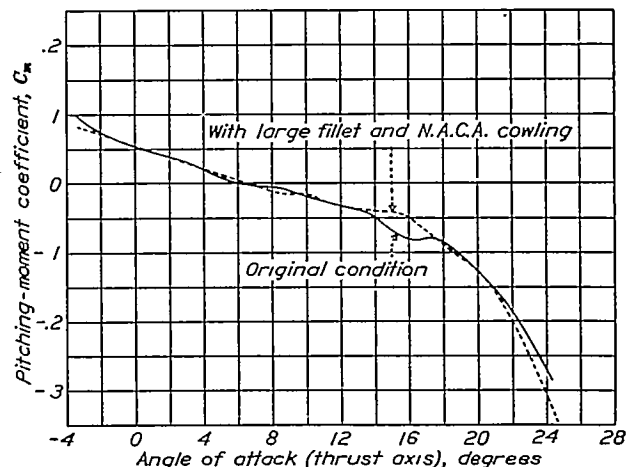

FIGURE 24.—Pitching moments of McDonnell airplane with power on. Corrected for tunnel effects. Stabilizer  $0.6^\circ$  to thrust axis. Elevator  $0^\circ$  to stabilizer.

trouble at its source by methods such as those used in this investigation.

The specimen record of the fluctuations in dynamic pressure at the tail (fig. 34) shows that although the fluctuations were very irregular they had some semblance of a definite frequency. It was very difficult to determine definitely either this frequency or the true magnitude of the fluctuations from the records taken, owing to the irregularity of the changes and to the large amount of damping introduced by the connecting tubes. In spite of these difficulties, however, after a careful study of the records, the following conclusions in

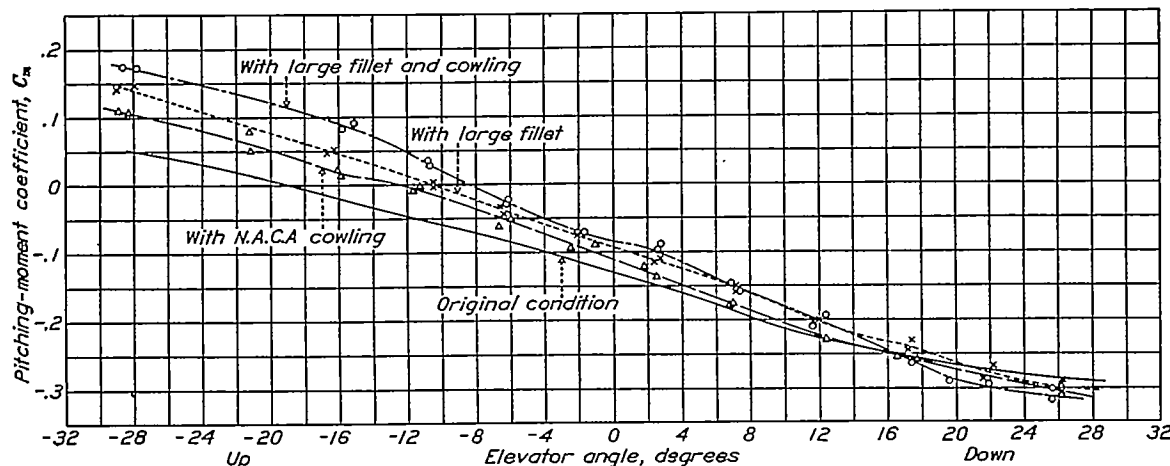
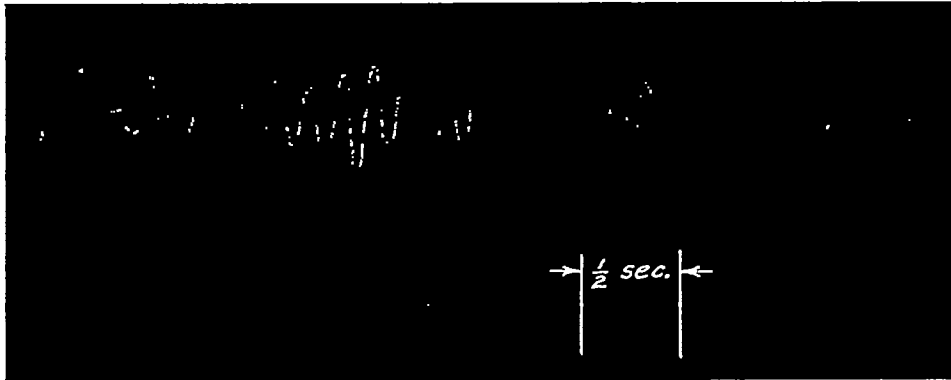

FIGURE 25.—Elevator effectiveness of McDonnell airplane with various devices. Corrected for tunnel effects. Power off. Angle of attack (thrust axis)  $=15.8^\circ$ .

REPORT NATIONAL ADVISORY COMMITTEE FOR AERONAUTICS

Deflection for 1-inch  
 vertical movement --->  
 of stabilizer



ORIGINAL CONDITION

Angle of attack= $14.1^\circ$ ,  $5.6^\circ$  below  $\alpha_{C_{L_{max}}}$ ,  $C_L=0.990$ .

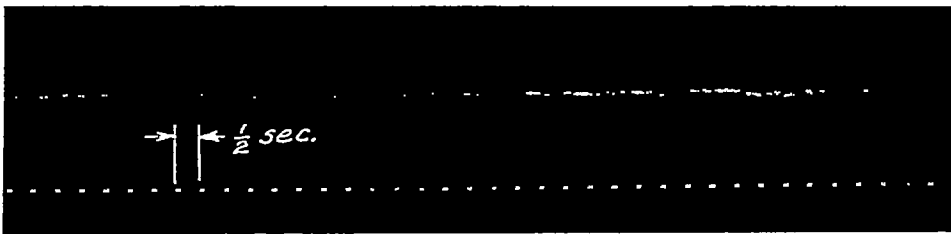

WITH LARGE FILLET

Angle of attack= $14.1^\circ$ ,  $3.3^\circ$  below  $\alpha_{C_{L_{max}}}$ ,  $C_L=1.145$ .

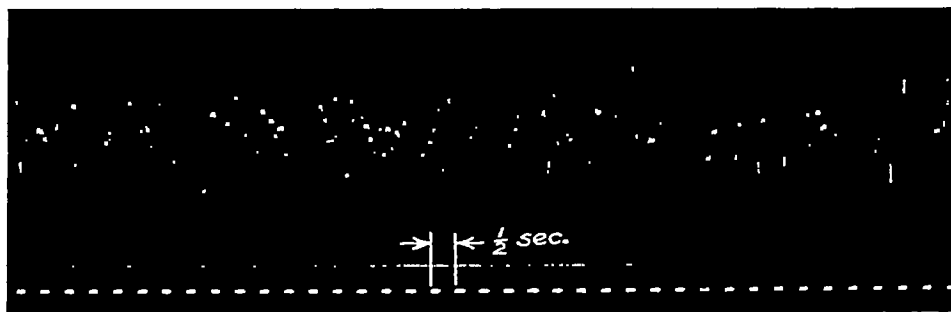

ORIGINAL CONDITION

Angle of attack= $17.8^\circ$ ,  $1.8^\circ$  below  $\alpha_{C_{L_{max}}}$ ,  $C_L=1.142$ .

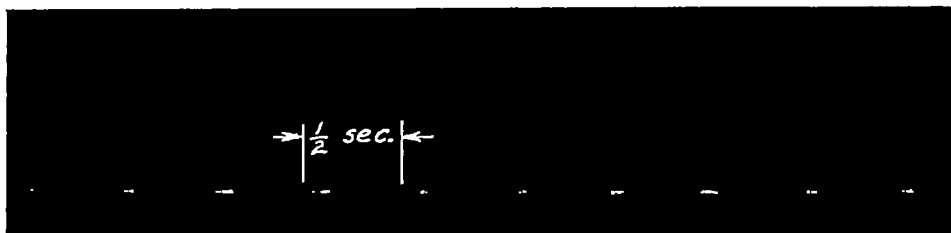

WITH LARGE FILLET

Angle of attack= $17.8^\circ$ ,  $0.6^\circ$  above  $\alpha_{C_{L_{max}}}$ ,  $C_L=1.250$ .

FIGURE 26.—Typical records of stabilizer-tip movements.

regard to air-flow conditions at the tail seem to be justified, although they cannot be considered as definitely proved:

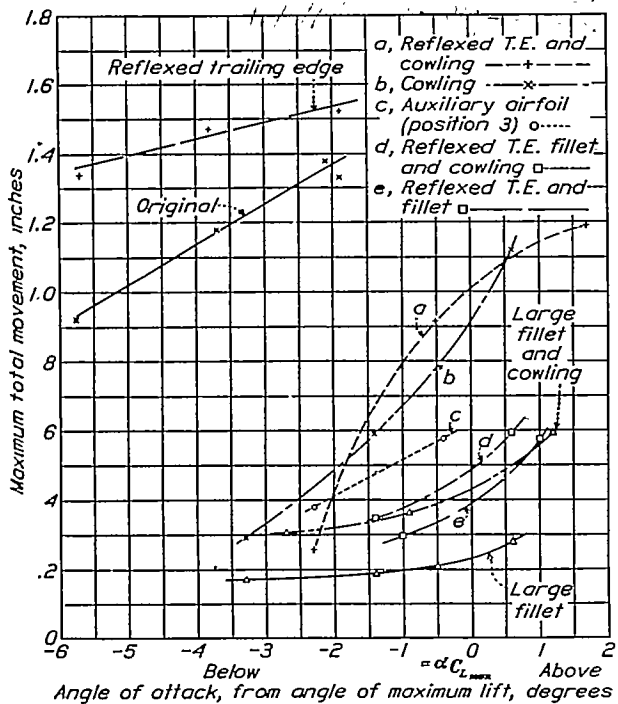

FIGURE 27.—Amplitude of stabilizer-tip movements under various conditions. Angle of attack corrected for tunnel effects. Power off. Air speed approximately 58 m.p.h.

1. The principal frequency of fluctuations in the wake from the wing-fuselage intersection for the airplane in the original condition was close enough to the

natural frequency of the tail to indicate the possibility of resonance (fig. 34). These high-frequency fluctuations (7 or 8 per second) are of much greater magnitude

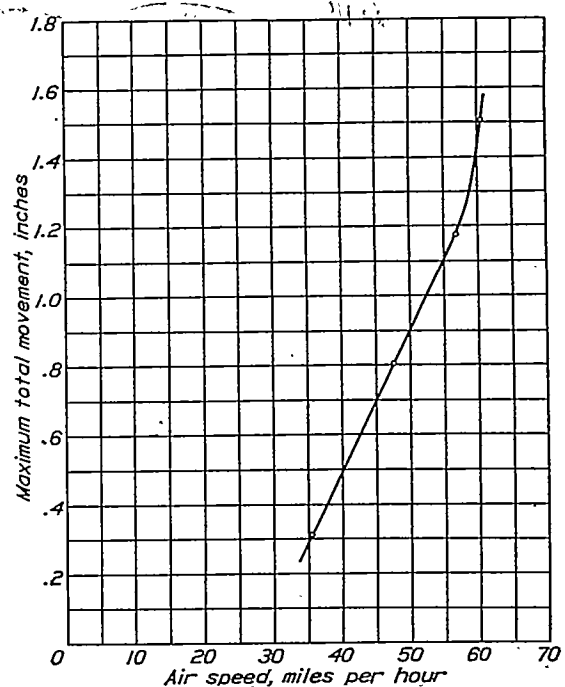

FIGURE 28.—Variation in stabilizer-tip movements with changes in air speed. Power off. McDonnell airplane in original condition. Angle of attack (corrected for tunnel effect),  $3.7^\circ$  below  $\alpha_{0L_{max}}$ .

relative to the lower frequency changes than the record indicates because high-frequency fluctuations are damped much more than slow ones.

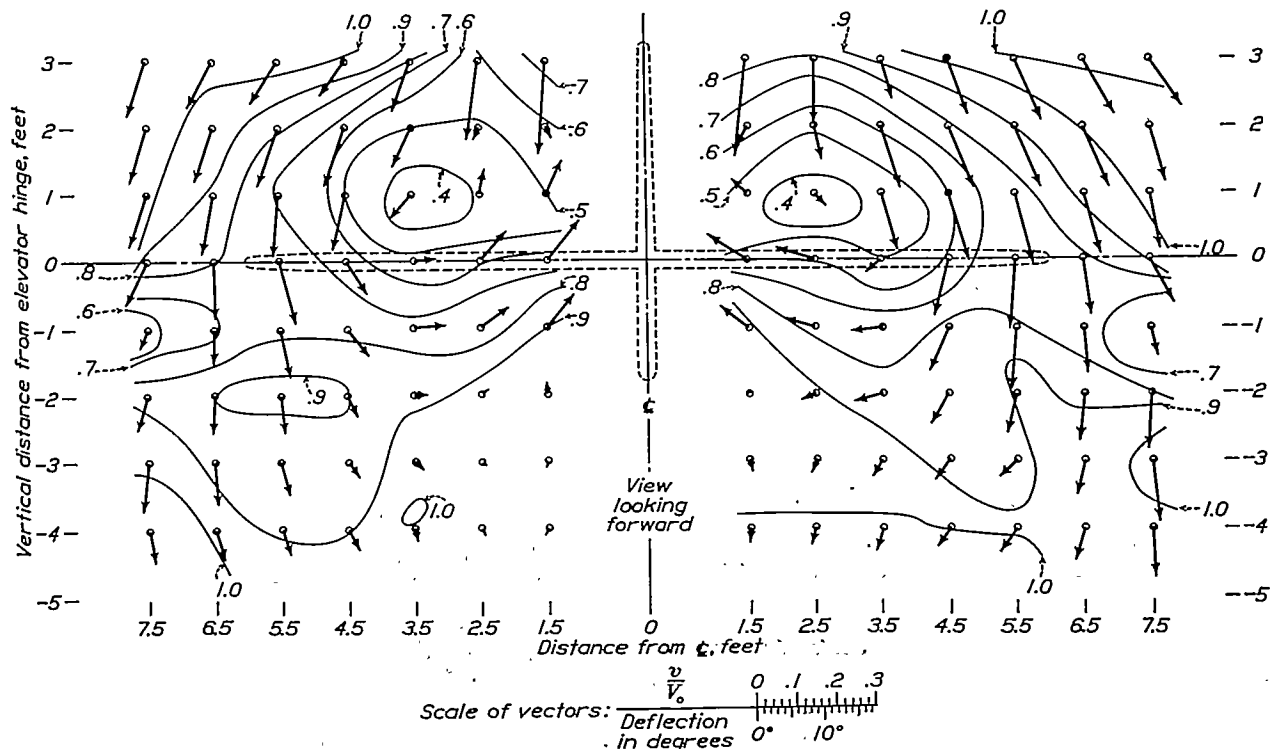

FIGURE 29.—Air flow at tail of McDonnell airplane in original condition, power off. Survey in vertical plane through elevator hinge line. The contours show the ratio of the dynamic pressure behind the airplane to the dynamic pressure in the free air stream. The vectors show the components of the velocity in the plane of the survey. Angle of attack (thrust axis) =  $14.2^\circ$  (corrected for tunnel effects). Lift coefficient = 0.984.

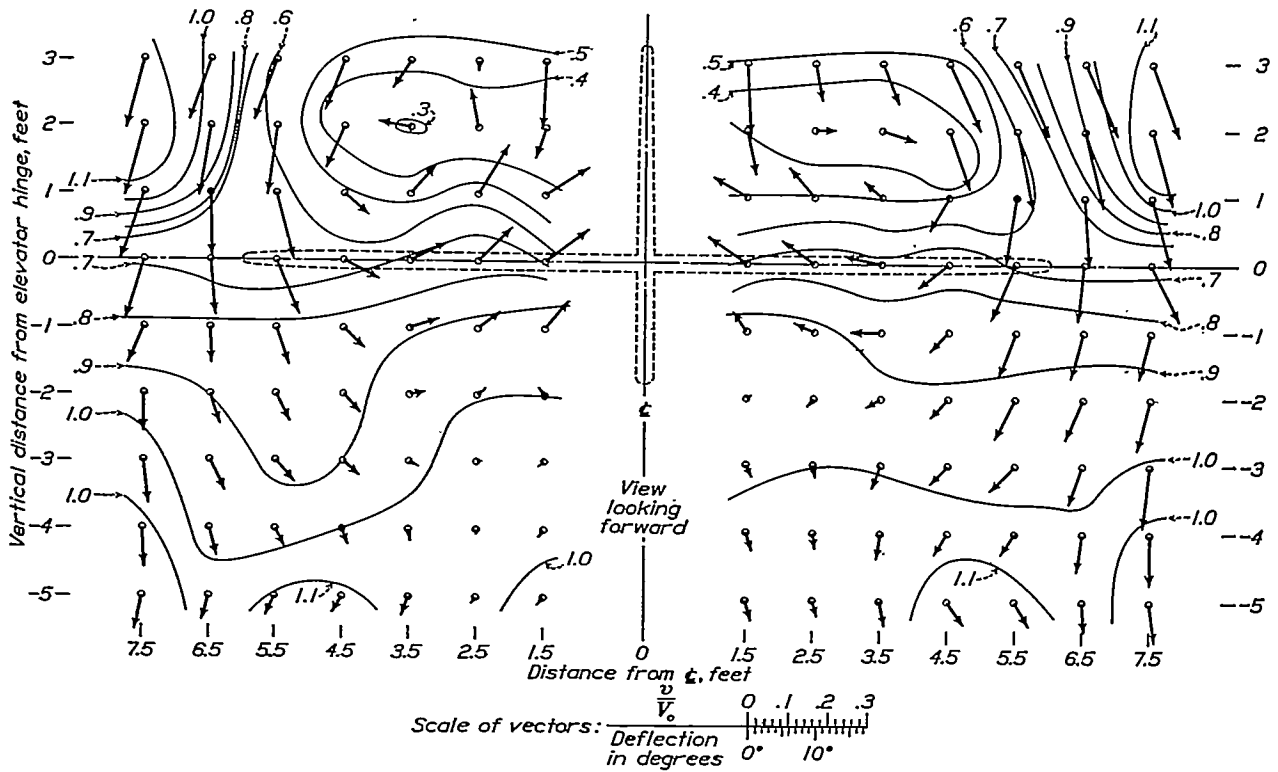

FIGURE 30.—Air flow at tail of McDonnell airplane in original condition, power off. Survey in vertical plane through elevator hinge line. The contours show the ratio of the dynamic pressure behind the airplane to the dynamic pressure in the free air stream. The vectors show the components of the velocity in the plane of the survey. Angle of attack (thrust axis)=17.9° (corrected for tunnel effects). Lift coefficient=1.105.

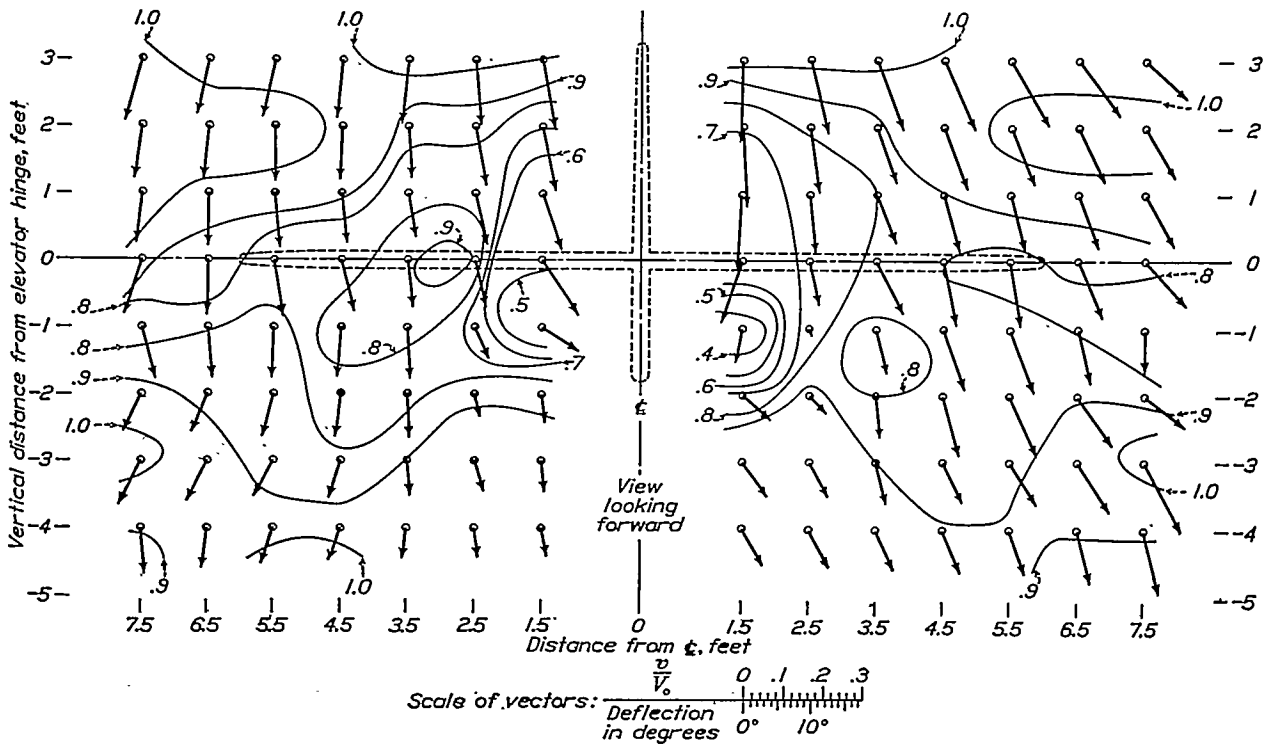

FIGURE 31.—Air flow at tail of McDonnell airplane with large fillet, power off. Survey in vertical plane through elevator hinge line. The contours show the ratio of the dynamic pressure behind the airplane to the dynamic pressure in the free air stream. The vectors show the components of the velocity in the plane of the survey. Angle of attack (thrust axis)=13.9° (corrected for tunnel effects). Lift coefficient=1.141.



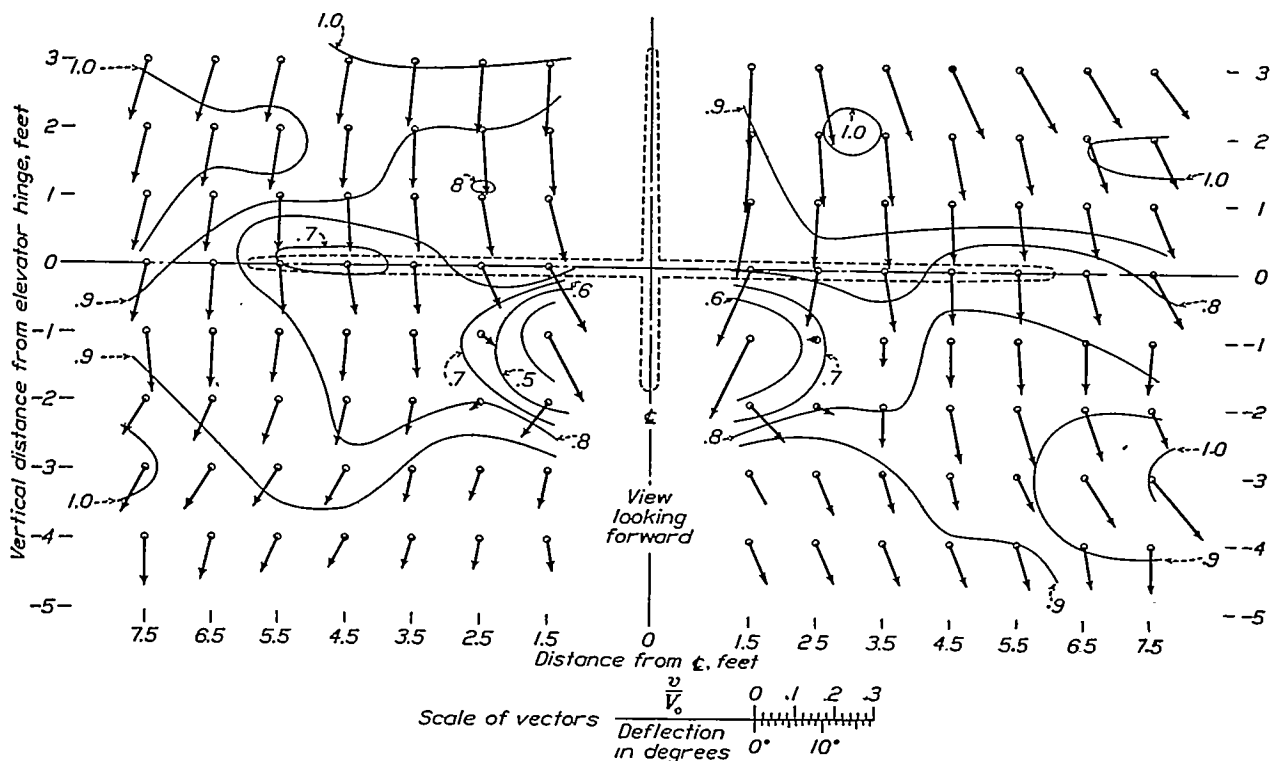

FIGURE 32.—Air flow at tail of *McDonnell* airplane with N.A.O.A. cowling, power off. Survey in vertical plane through elevator hinge line. The contours show the ratio of the dynamic pressure behind the airplane to the dynamic pressure in the free air stream. The vectors show the components of the velocity in the plane of the survey. Angle of attack (thrust axis)=13.9° (corrected for tunnel effects). Lift coefficient=1.153.

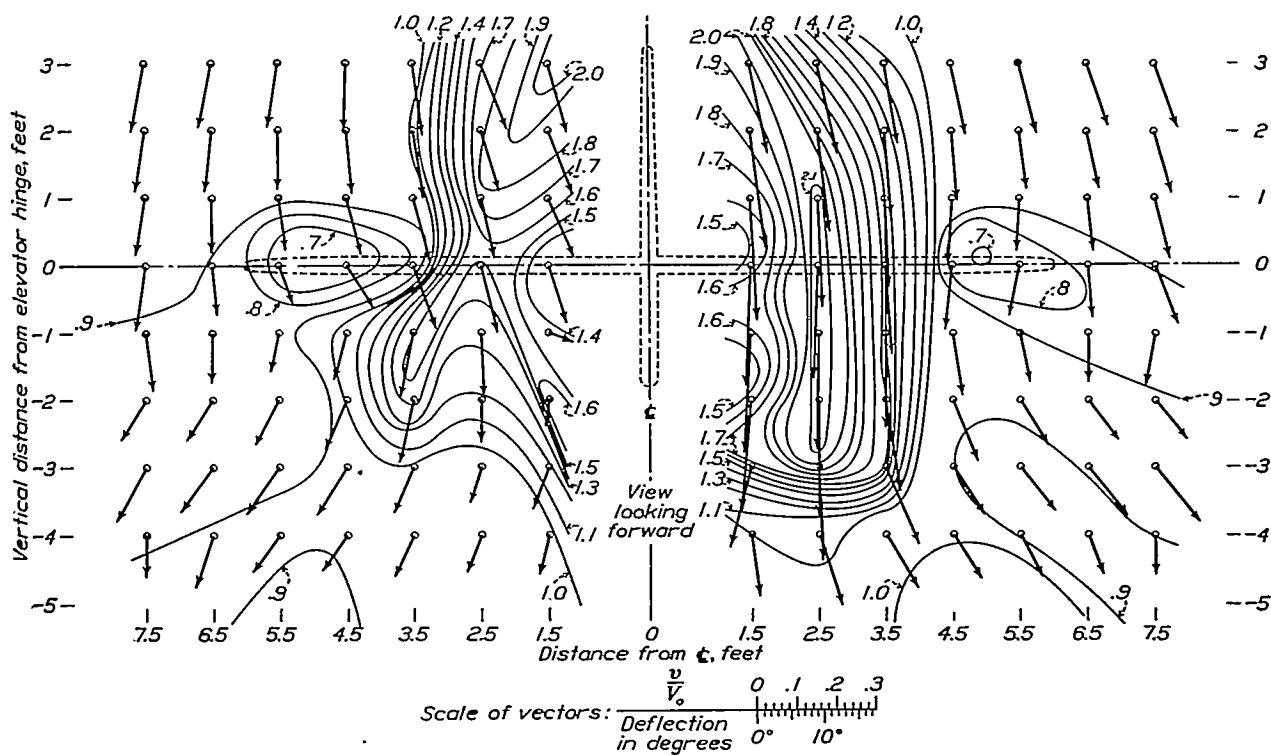

FIGURE 33.—Air flow at tail of *McDonnell* airplane in original condition, power on. Survey in vertical plane through elevator hinge line. The contours show the ratio of the dynamic pressure behind the airplane to the dynamic pressure in the free air stream. The vectors show the components of the velocity in the plane of the survey. Angle of attack (thrust axis)=13.7° (corrected for tunnel effects). Lift coefficient=1.241.

2. Improving the flow at the wing root increased the frequency of the eddies in the wake to approximately 50 percent greater than that for the original condition.

3. Over the range tested, from 37 to 58 miles per hour, the frequency of the fluctuations appeared to vary proportionally with the velocity.

4. In addition to the fluctuations with a fairly definite frequency there were also irregular and sudden "bumps."

It is difficult to say just how much of the buffeting motion was due to trains of oscillations set up by the bumps mentioned in item 4 and how much was due to the more regular air fluctuations of about the same frequency as the natural frequency of the tail. Undoubtedly, some of the reduction in buffeting for improved conditions of the airplane was due to the frequency of the eddies having been increased to a value well above the natural frequency of the tail.

### CONCLUSIONS

The following conclusions are drawn from the tests on the *McDonnell* airplane. Differences in engine, fuselage shape, and wing section and location might modify the results for other low-wing monoplanes.

1. In addition to the presence of sudden changes or bumps, the eddying wake from the wing roots had a predominant frequency of fluctuation of the order of the natural-vibration frequency of the tail, although

7. The combination of the large fillet and the N.A.C.A. cowling gave the best all-round results. This combination reduced the total amplitude of stabilizer-tip oscillations at an angle of attack  $2^\circ$  below maximum lift from the original 1.37 inches to 0.32 inch, increased the maximum lift 11 percent, decreased the minimum drag 9 percent, increased the maximum lift/drag ratio of the airplane 19 percent, and increased the effectiveness of the elevator about 40 percent at angles of attack in the landing range.

8. The slipstream was practically as effective as the fillets in reducing tail buffeting.

9. The use of fillets or other devices for eliminating wing-fuselage interference slightly decreased the longitudinal stability of the airplane.

LANGLEY MEMORIAL AERONAUTICAL LABORATORY,  
 NATIONAL ADVISORY COMMITTEE FOR AERONAUTICS,  
 LANGLEY FIELD, VA., December 13, 1933.

### REFERENCES

1. Accidents Investigation Subcommittee: Accident to the Aeroplane G-AAZK (Junkers F. 13 G.E) at Meopham, Kent, on 21st July, 1930. R. & M. No. 1360, British A.R.C., 1931.

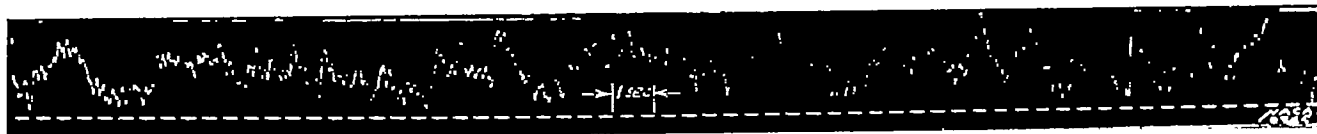

FIGURE 34.—Fluctuations in dynamic pressure at tail of *McDonnell* airplane in original condition, power off. Angle of attack (thrust axis) =  $14.2^\circ$  (corrected for tunnel effects).

the fluctuations were very irregular, which suggests that the magnitude of the tail vibrations was very probably influenced to some extent by resonance effects.

2. Fillets without cowling reduced the wing-fuselage interference and tail buffeting to unobjectionable magnitudes throughout the range of normal-flight attitudes.

3. The N.A.C.A. cowling without fillets reduced the wing-fuselage interference and tail buffeting to unobjectionable magnitudes at angles of attack up to within  $3^\circ$  of the stall.

4. The reflexed trailing edge had a minor effect, slightly increasing the amplitude of tail oscillations due to buffeting.

5. The auxiliary airfoils, in the positions tested, gave some improvement but were considerably inferior to the fillets.

6. Buffeting was least when the large fillet was used alone. This fillet reduced the amplitude of stabilizer-tip oscillations from the 1.37 inches obtained with the airplane in the original condition to 0.18 inch at an angle of attack  $2^\circ$  below the stall.

2. Aerodynamics Staff of the National Physical Laboratory: Two Reports on Tail Buffeting. R. & M. No. 1457, British A.R.C., 1932.

3. Blenk, Hermann; Hertel, Heinrich; and Thalau, Karl: The German Investigation of the Accident at Meopham (England). T.M. No. 669, N.A.C.A., 1932.

4. Blenk, Hermann: A German View of Buffeting. Aircraft Engineering, May 1933, pp. 113-115. Translated from Z.F.M., vol. 24, no. 1, Jan. 14, 1933, pp. 21-24.

5. Stieger, H. J.: Wing Construction. Roy. Aero. Soc. Jour., vol. XXXVI, no. 262, October 1932, pp. 789-827.

6. Mutray, H.: Investigation of the Effect of the Fuselage on the Wing of a Low-Wing Monoplane. T.M. No. 517, N.A.C.A., 1929.

7. Klein, A. L.: Effect of Fillets on Wing-Fuselage Interference. Paper presented before A.S.M.E., Berkeley, Calif., June 9 and 10, 1932.

8. Jacobs, H. H., and Anderson, H. L.: Wind Tunnel Tests of Fokker XA-7 with Cockpit Cowls, Auxiliary Stub Wings, Reflexed Trailing Edge, and Airfoil Wing-Braicing Struts. A.C.T.R., serial no. 3623, Matériel Division, Army Air Corps, 1932.

9. Biechteler, Curt: Tests for the Elimination of Tail Flutter. T.M. No. 710, N.A.C.A., 1933.

10. Hood, Manley J., and White, James A.: Full-Scale Wind-Tunnel Research on Tail Buffeting and Wing-Fuselage Interference of a Low-Wing Monoplane. T.N. No. 460, N.A.C.A., 1933.
11. DeFrance, Smith J.: The N.A.C.A. Full-Scale Wind Tunnel. T.R. No. 459, N.A.C.A., 1933.
12. Soulé, Hartley A.: The Effect of Slots and Flaps on the Lift and Drag of the McDonnell Airplane as Determined in Flight. T.N. No. 398, N.A.C.A., 1931.
13. Weick, Fred E.: Drag and Cooling with Various Forms of Cowling for a "Whirlwind" Radial Air-Cooled Engine.-I. T.R. No. 313, N.A.C.A., 1929.
14. Weick, Fred E., and Bamber, Millard J.: Wind-Tunnel Tests of a Clark Y Wing with a Narrow Auxiliary Airfoil in Different Positions. T.R. No. 428, N.A.C.A., 1932.