

REPORT No. 489

AIR CONDITIONS CLOSE TO THE GROUND AND THE EFFECT ON AIRPLANE LANDINGS

By F. L. THOMPSON, W. C. PECK, and A. P. BEARD

SUMMARY

This paper reports an investigation undertaken to determine the feasibility of making glide landings in gusty air. Wind velocities were measured at several stations between the ground and a height of 51 feet, and flight tests were made to determine the actual influence of gusts on an airplane gliding close to the ground. The airplane used for the flight tests was equipped with a landing gear of unusually long travel so that glide landings with the elevator fixed could be made under favorable air conditions. In very gusty air the glides with fixed elevator were terminated at a safe altitude without actual landings.

The results of the wind measurements indicate an average increase in velocity with height in accordance with the expression $\frac{V}{V_1} = \left(\frac{h}{h_1}\right)^{1/7}$. Maximum variations in the horizontal components of wind velocity were found to be of the order of ± 4 miles per hour without perceptible dependence on the average velocity or height, while maximum variations in vertical components were of the same order at the higher elevations, decreasing with height but with no perceptible dependence on wind velocity. Unchecked glide landings in gusty air with the conventional airplane were found to be unduly hazardous. The hazard would tend to be reduced, however, by the addition of a high-lift device that extends the lift curve without modifying the lift characteristics in the normal range of angle of attack.

INTRODUCTION

The ability to land an airplane in a restricted space has long been recognized as an item of importance in connection with the general problem of safety of flight. In a previous investigation with several airplanes (reference 1) it was found that the horizontal distance traversed during the approach for a landing and the subsequent landing run could be greatly reduced if the flight path during the approach were a steady glide without the usual flare. It was concluded that such landings would be feasible in smooth air, although the vertical velocities at contact would be considerably greater than those normally encountered and special landing gears would be required. As

the practicability of making such landings in gusty air remained questionable, the need for further investigation was indicated.

The present investigation was undertaken to determine the feasibility of glide landings in gusty air. Two more or less independent lines of attack were followed. In one series, measurements were made to determine the magnitude of the fluctuations in wind velocities likely to be encountered by a landing airplane, a fairly extensive literature on the subject of wind fluctuations having been found to be inapplicable to the specific problem. In the other series, landing tests were made of an airplane equipped with a special long-travel landing gear. For the wind-velocity measurements, an apparatus was constructed to record simultaneously the velocities at various heights up to 51 feet. For the landing tests, the motion of the airplane was recorded by an apparatus which consisted of a motion-picture camera set up to perform the combined functions of a camera and a recording theodolite and which will be referred to hereinafter as a "recording phototheodolite."

The investigation was conducted by the National Advisory Committee for Aeronautics at Langley Field, Va. The experiments were made at various times during a period of about 1 year, ending early in 1933. In general, no attempt was made to carry on the experimental work of the two phases of the investigation simultaneously, inasmuch as it was not feasible to make the landing tests and the wind-velocity measurements on the same portion of the field.

WIND MEASUREMENTS

APPARATUS AND PROCEDURE

Apparatus.—A simple method was devised to determine the direction and magnitude of the wind at various elevations. A portable mast with indicator units located at heights of 6, 11, 21, 36, and 51 feet was used (fig. 1). Each unit (fig. 2) consisted of a vane with vertical and horizontal fins to indicate the inclination of the wind to the horizontal, and a pair of light V-shaped pendulums to indicate the magnitude of the wind. The vane and pendulums were mounted on a horizontal shaft about which they were free to rotate

independently, the horizontal shaft in turn being free to rotate about a vertical axis so as to keep the unit properly aligned with the direction of the wind. Simultaneous records of the inclinations of all indicators were obtained with a motion-picture camera using standard-size film.

The pendulums were calibrated for a horizontal wind in the 7- by 10-foot wind tunnel, identical calibrations being obtained for all pendulums by increasing or decreasing the angle included between the sides of each of the pendulums. As the inclination of the V-shaped pendulums depended on both the magnitude and the direction of the wind, it was necessary to obtain cali-

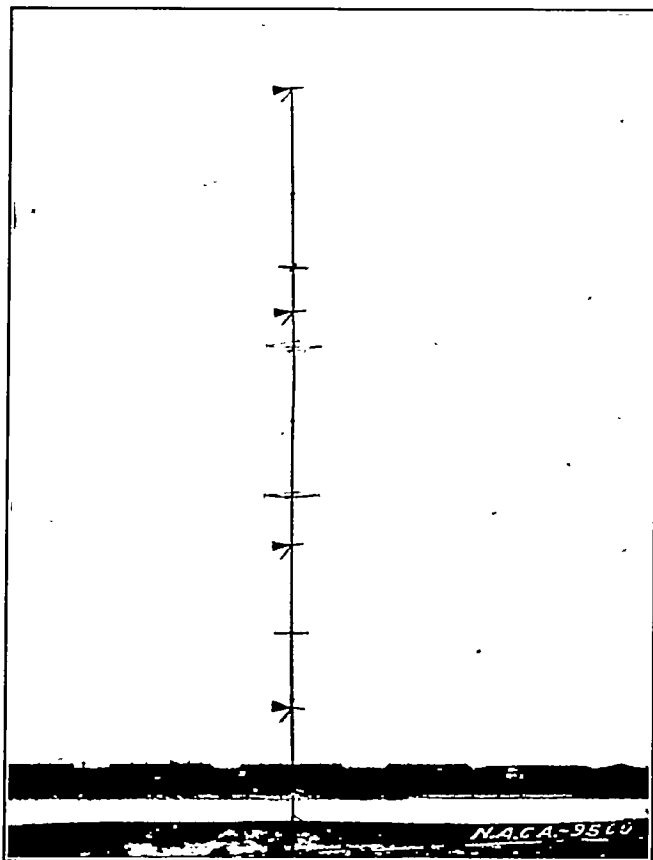

FIGURE 1.—Wind mast.

brations for inclined winds. In order to obtain such calibrations, the aerodynamic moment for each inclination of the pendulums was equated to the weight moment and was assumed to be a function of dynamic pressure and angle of attack. The relation between these variables and the actual weight moments of the pendulums for all inclinations was then used to establish the calibration for inclined winds.

Procedure.—When records were taken, the mast was located a distance of about 800 feet from the nearest obstruction. The area swept by the oncoming wind was level and grassy for a minimum distance of 1,000 feet, beyond which the ground was covered with brush and small trees. The camera was mounted 4 feet

above the ground and 110 feet from the base of the mast, laterally level but with the optical axis inclined 11° above the horizontal in a vertical plane containing the mast and approximately perpendicular to the direction of the prevailing wind. A similar set-up was used in each case so that corrections for inclination of the camera would be simplified.

Most of the records were taken with the camera operated intermittently so as to obtain one image each second for a period of 30 to 40 seconds. A few records were taken, however, with the camera operating at the rate of 16 exposures per second in order to determine the rapidity of wind variations and response of the indicators. While the records were being made the average wind velocity at a height of 6 feet was also determined with a vane-type anemometer.

For the evaluation of data the photographs were projected on a translucent glass screen with an enlargement factor of 15. Angles of the vanes and pendulums

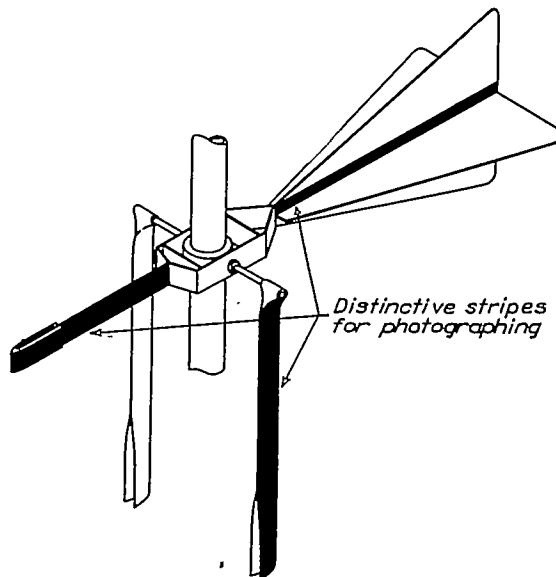

FIGURE 2.—Unit for indicating wind speed and inclination.

were then read with a protractor. Corrections were made for the effect of the vertical inclination of the camera. The proper calibration to use for each unit was determined by reference to the inclination of the wind as indicated by the vane of that unit.

RESULTS

Time histories of the magnitude and inclination of the wind at the elevations of 6, 11, 21, 36, and 51 feet are shown in figures 3 to 9, inclusive. These results were obtained in winds of average ground velocities ranging from 8 to 16 miles per hour at an elevation of 6 feet as measured by a vane-type anemometer over a period of several minutes. Positive inclinations in these figures indicate upward components of velocity.

A very definite increase in the magnitude of the average wind velocity with increasing altitude is at

once apparent from an examination of these results. The average gradient with altitude for each wind condition was determined by averaging the ratios of velocities at various elevations to the velocities at 51 feet. The gradients thus obtained showed somewhat different characteristics but no consistent variation with average wind speed. The average gradient for the entire series of measurements is represented by the solid line in figure 10. It is interesting to observe that this curve follows fairly closely a gradient represented by the expression $\frac{V}{V_1} = \left(\frac{h}{h_1}\right)^{1/7}$ as shown by the broken line in figure 10. Other results, such as those reported by Schmidt in reference 2 (see also references 3 and 4), indicate that the gradient may conform to this type of expression with exponents varying between 1/3 and 1/7.

Of greater importance than the average gradient with height are the fluctuations with time as regards both the magnitude of the velocity and the inclination to the horizontal. The maximum fluctuations in magnitude were generally of the order of ± 4 miles per hour from the average at any height, there being no pronounced dependence on either the height or the magnitude of the nominal wind velocity, except that at the highest wind speed there were occasional fluctuations as great as 6 miles per hour. The fluctuations in inclination, on the other hand, show a pronounced decrease in magnitude with increased wind speed, as well as a fairly definite tendency for the fluctuations to decrease in magnitude with decreasing height. At the three upper stations the range of variation in inclination was of the order of $\pm 20^\circ$ to $\pm 30^\circ$ for nominal wind speeds of 8 miles per hour and of the order of $\pm 10^\circ$ at 16 miles per hour. This fact indicates that, as was previously noted regarding resultant velocities, vertical components are independent of the average wind speed. Fluctuations in horizontal components, being of approximately the same magnitude as the fluctuations in resultant velocities, were of the order of ± 4 miles per hour. Vertical components increased in magnitude with height. The combination of relatively high wind speeds and inclinations at a height of 51 feet indicates that at this elevation fluctuations of vertical components of velocity were also of the order of ± 4 miles per hour.

It can readily be appreciated that the conditions encountered by a landing airplane are not represented by the conditions that prevail at any instant in a vertical section of the 51-foot layer of air. In order to obtain a general indication of the conditions that might have been encountered by an airplane in a landing approach for some of the cases shown in figures 3 to 9, the following method was used: It was assumed that the airplane moved horizontally relative to the air with a constant velocity of 70 feet per second and had a constant rate of descent of 10 feet per second

regardless of vertical air currents encountered. Conditions encountered at some desired time at the 51-foot level were spotted on the curve for this level. For the assumed conditions, the airplane reached the 36-foot level $1\frac{1}{2}$ seconds after passing the 51-foot level, and moved upstream 105 feet relative to the air. Therefore, the time interval t required for this air distance was calculated by assuming the average speed over this interval to be the same as the average at 51 feet, and a point was spotted on the curve for the 36-foot level at t seconds later than the point at the 51-foot level. A similar procedure was followed for each step of the descent, using as average wind velocity over each increment the average velocity at the start of the increment. Points obtained by this procedure for a sample case are shown by the broken line in figure 7.

Curves showing the horizontal and vertical components of the wind speed that would thus be encountered are shown for several cases in figures 11 to 14. Although the method is rather inexact, it serves the intended purpose of giving consideration to fluctuations of wind velocity with time as well as with altitude. One objection to this method of interpretation is that the wind front on which the measurements were obtained has no width and disturbances actually may not extend over a distance equal to the span of the airplane.

The effect on the motion of a gliding airplane that encounters disturbances such as some of those shown in figures 11 to 14 would appear to be large. In order to determine what the effect might be for a hypothetical case it was necessary to resort to a step-by-step integration with a solution by trial and error. Data were used for an actual airplane (Doyle O-2) for which lift, drag, moment of inertia, and pitching-moment characteristics were known (reference 5). The elevator was assumed to be held stationary and the airplane was assumed to be gliding steadily at the 51-foot level, as though the conditions prevailing at that level extended upward indefinitely. For gliding descent in still air, the airplane was assumed to have a horizontal component of velocity of 70 feet per second, a vertical component of velocity of 10 feet per second, an attitude angle of 6.3° , and an angle of attack of 14.4° . The results of the calculations are shown in table I. It is interesting to note the increase in vertical velocity to more than 20 feet per second and a decided change in attitude to a nose-down condition. Changes in angle of attack were small.

Similar calculations were made to determine the effect of the average gradient in a fairly strong wind. The results of these calculations are also shown in table I. Here again it was assumed that the gradient was encountered at the 51-foot level, conditions above that elevation being constant. The vertical velocity in this case increased to 16.6 feet per second.

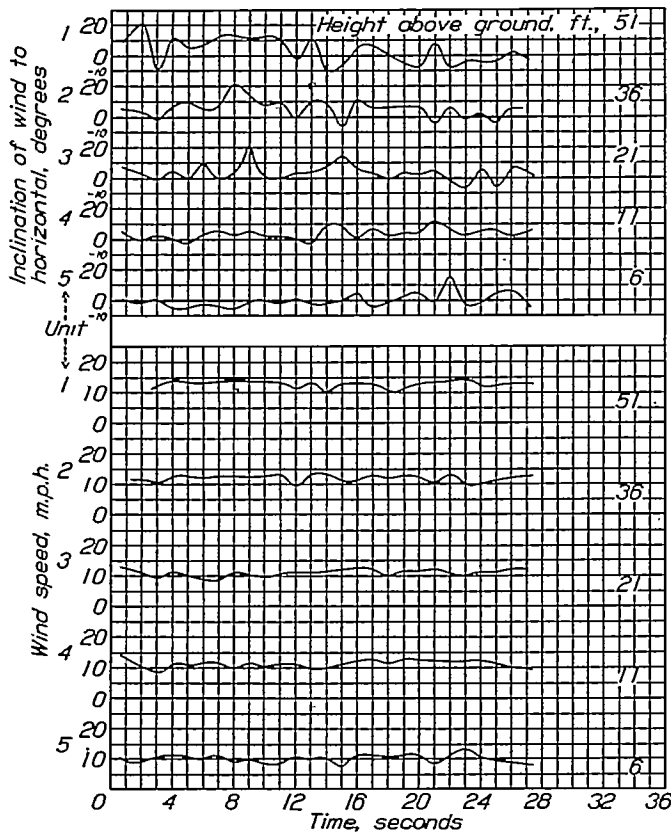

FIGURE 3.—Wind speed and inclination fluctuations for an average ground wind of 8 miles per hour. Run 1, April 1, 1932.

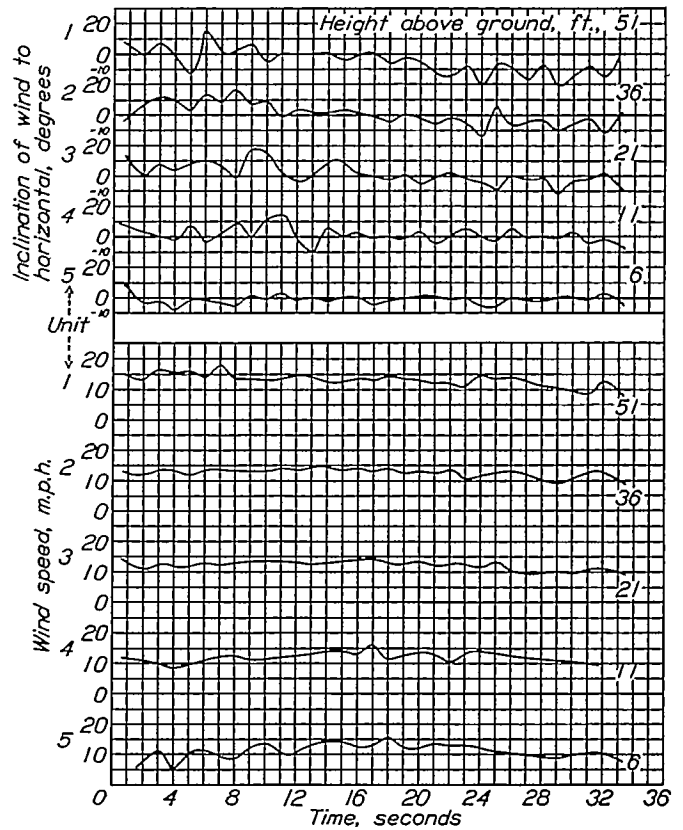

FIGURE 5.—Wind speed and inclination fluctuations for an average ground wind of 8 miles per hour. Run 1, July 8, 1932.

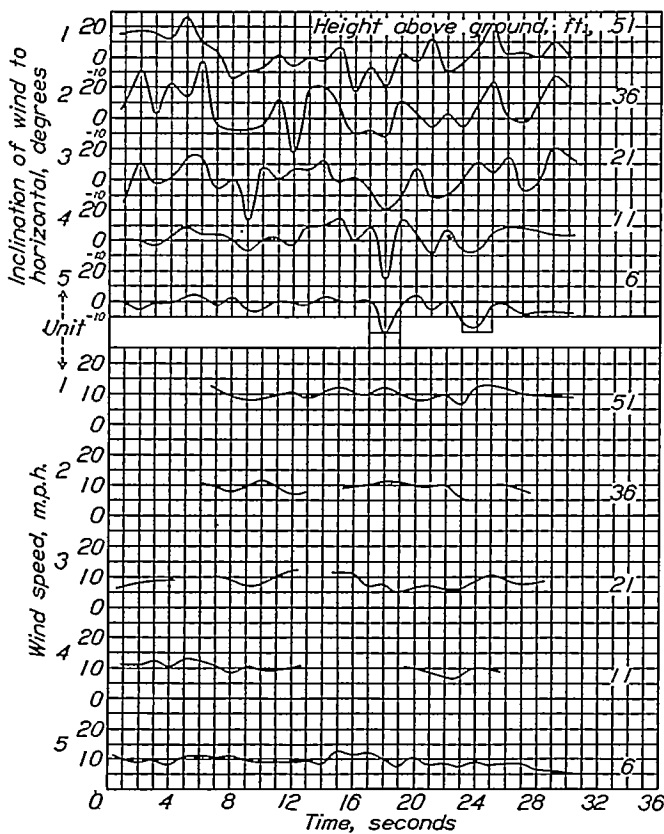

FIGURE 4.—Wind speed and inclination fluctuations for an average ground wind of 8 miles per hour. Run 3, April 6, 1932.

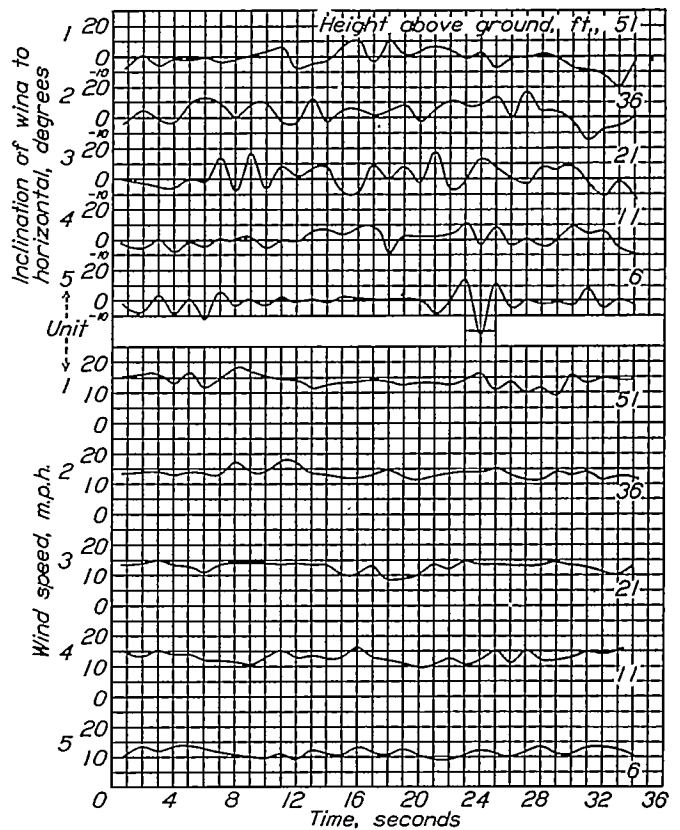

FIGURE 6.—Wind speed and inclination fluctuations for an average ground wind of 10 miles per hour. Run 3, August 16, 1932.

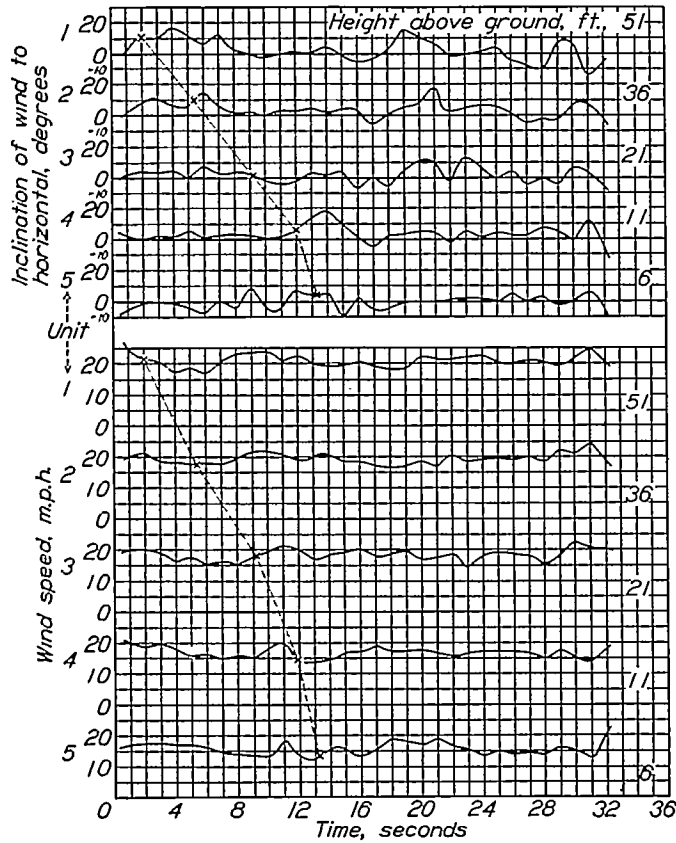

FIGURE 7.—Wind speed and inclination fluctuations for an average ground wind of 12 miles per hour. Run 4, April 13, 1932.

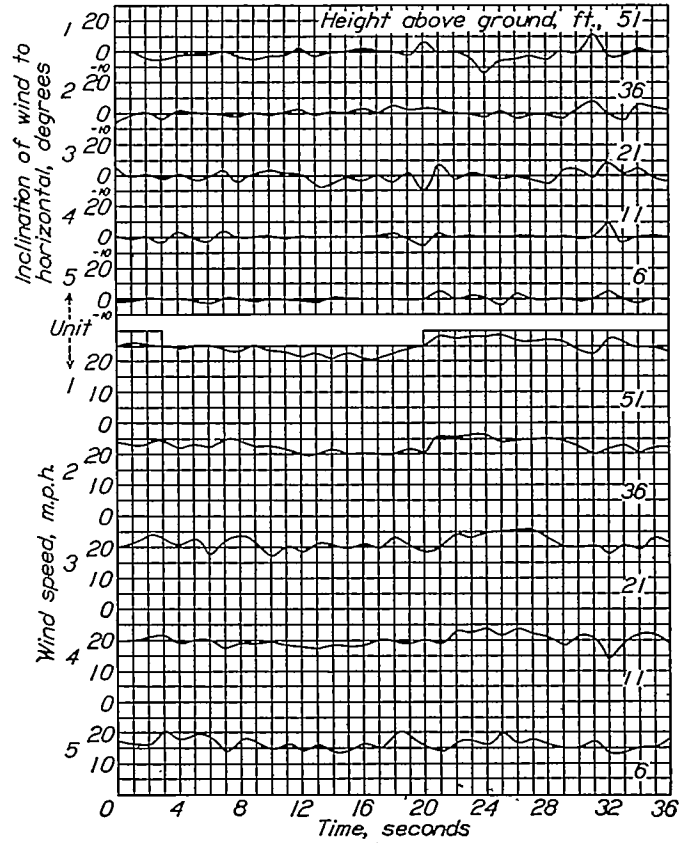

FIGURE 9.—Wind speed and inclination fluctuations for an average ground wind of 16 miles per hour. Run 2, February 21, 1933.

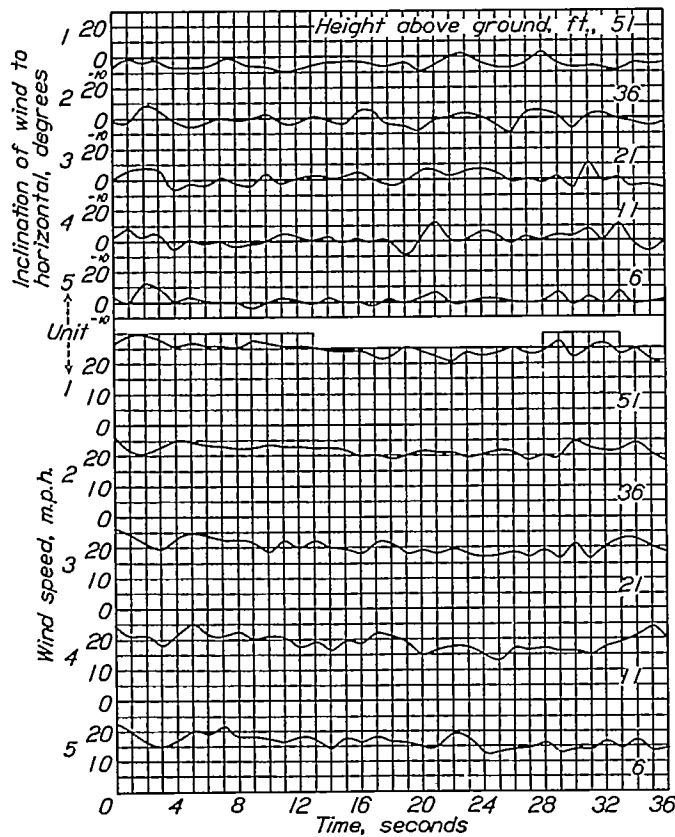

FIGURE 8.—Wind speed and inclination fluctuations for an average ground wind of 16 miles per hour. Run 1, February 21, 1933.

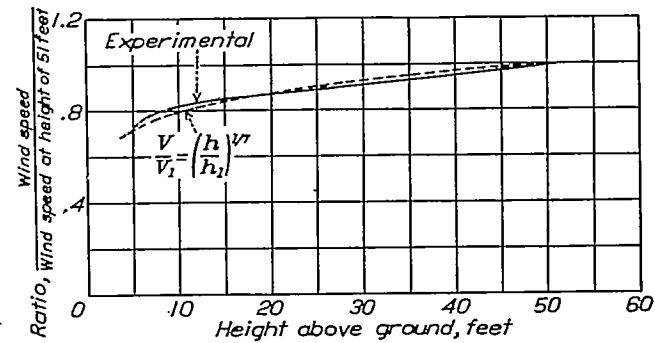

FIGURE 10.—Average wind speeds expressed in terms of the average wind speed at altitude of 51 feet.

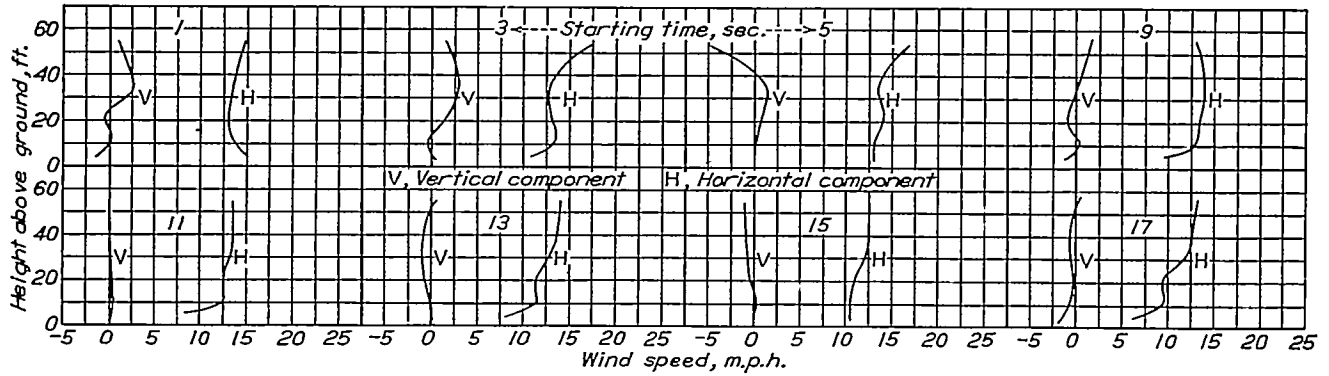

FIGURE 11.—Wind variations encountered along an assumed flight path. Run 1, July 8, 1932. (Average ground wind 8 miles per hour.) Negative wind is a descending vertical component.

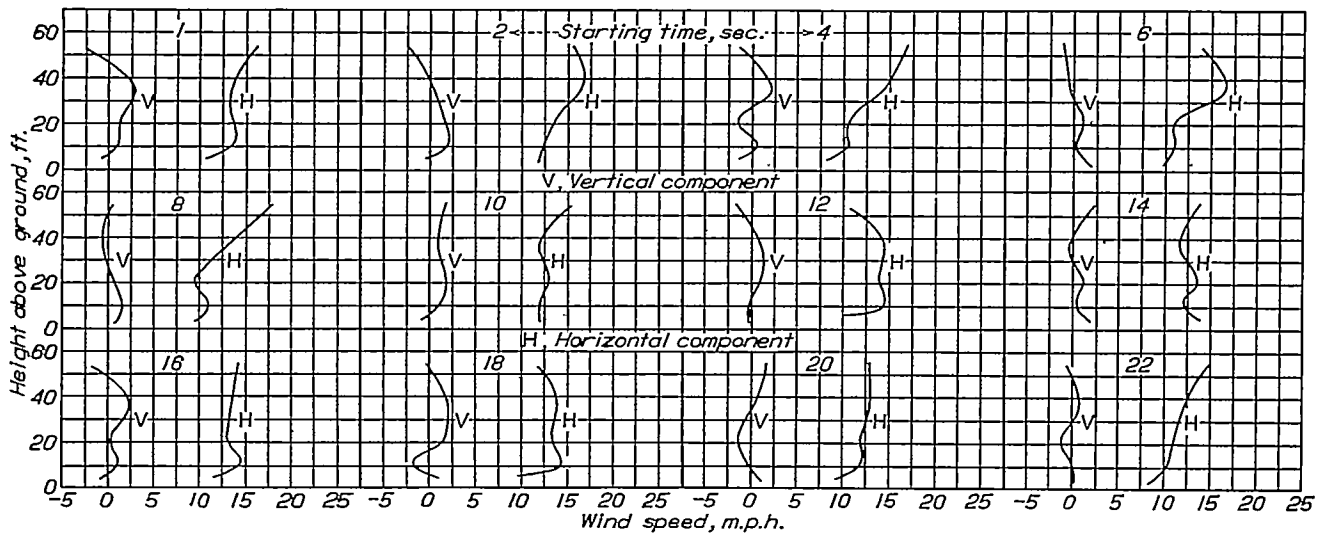

FIGURE 12.—Wind variations encountered along an assumed flight path. Run 3, August 16, 1932. (Average ground wind 10 miles per hour.) Negative wind is a descending vertical component.

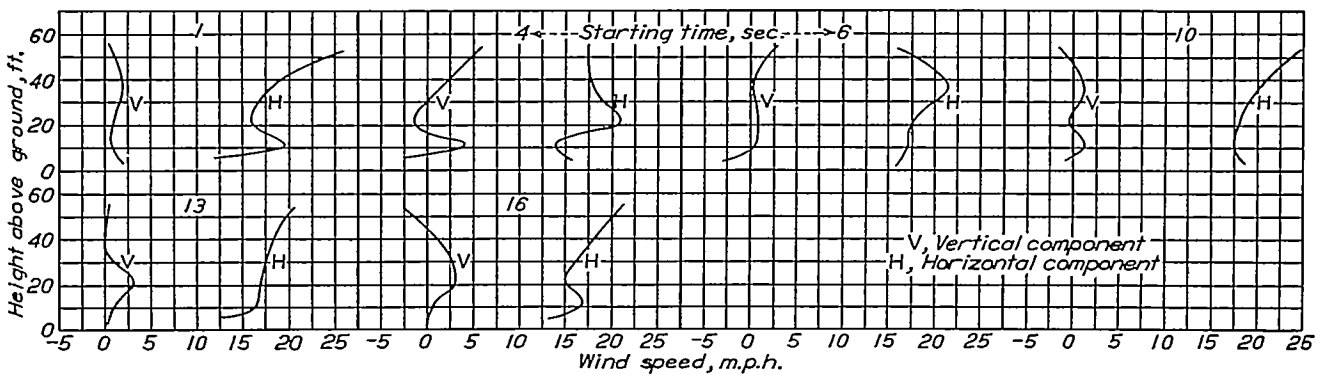

FIGURE 13.—Wind variations encountered along an assumed flight path. Run 4, April 13, 1932. (Average ground wind 12 miles per hour.) Negative wind is a descending vertical component.

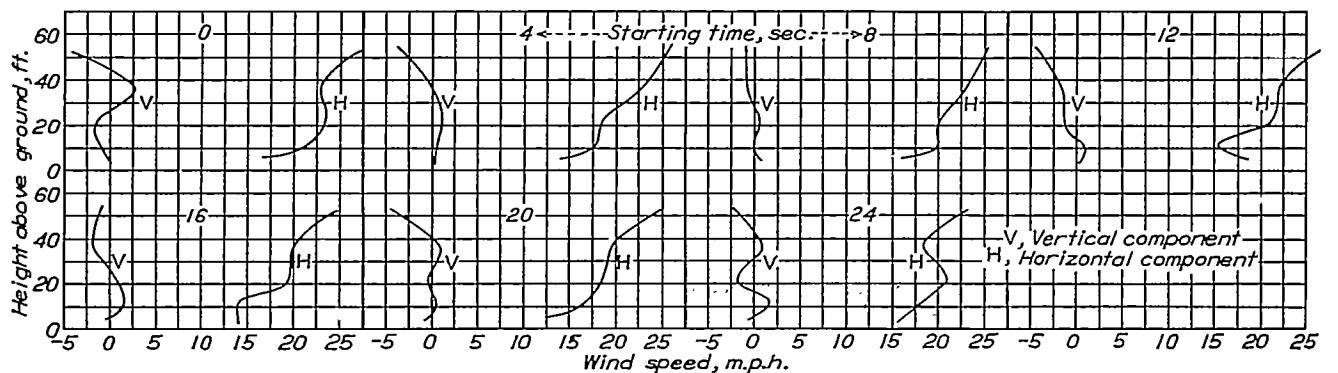

FIGURE 14.—Wind variations encountered along an assumed flight path. Run 1, February 21, 1933. (Average ground wind 16 miles per hour.) Negative wind is a descending vertical component.

It is worth noting in connection with this subject that the initial rate of climb as well as the rate of descent tends to be increased by the effect of the gradient with height. Quantitative data for climbs of 50 feet are given for several airplanes in reference 6. These data show as much as 100 percent increase in the rate of climb in some cases. It would be well to keep this fact in mind, particularly when determining the ability of an airplane to clear obstacles in take-off.

PRECISION

Angles on the photographic records were measured to within $\pm 2^\circ$. As regards the magnitude of the wind velocity, an error of 2° corresponds to an error of ± 1 mile per hour. Consistent errors of probably not greater than ± 0.3 mile per hour may have been introduced by calibration errors of the pendulums. Changes in direction of the wind that cause misalignment of the indicators relative to the vertical plane containing the optical axis of the camera would tend to produce insignificant errors in the apparent pendulum angles, but might introduce errors as great as about 4° in the apparent angles of inclination. Inertia of the vanes and pendulums probably introduces errors of appreciable magnitude for very sharp fluctuations, so that a true picture of the wind structure is not shown by the results. The effect of the inertia on the general magnitude of the fluctuations does not appear to be very important, however, since an evaluation of records taken at high film speeds did not indicate the existence of free oscillations of any considerable magnitude for either the vanes or the pendulums.

**LANDING MEASUREMENTS
 APPARATUS AND PROCEDURE**

Apparatus.—A Verville airplane (fig. 15) was used for the landing tests. In preparation for these tests

the fuselage was reinforced and a special landing gear was installed (fig. 16) that was designed to withstand a load factor of 12 in landings. In the design of the landing gear no consideration was given to the aerodynamic qualities of the gear, the primary considerations being energy-absorbing capacity, strength, and geometric arrangement. The gear utilized shock-absorbing struts having a stroke of 16.7 inches, which in turn permitted a 24-inch displacement of the center of gravity of the airplane. The design load factor of 12 was based on an expected maximum rate of descent at contact of 30 feet per second. This probable maximum rate of descent was determined from consideration of a fixed-elevator glide landing made in a previous series of tests with the same airplane in its normal condition, wherein the airplane was damaged at contact.

A recording phototheodolite was developed to determine the motion of the landing airplane relative to the ground. This apparatus (fig. 17) consisted essentially of a spring-driven motion-picture camera fitted to a mounting that permitted freedom for rotation about horizontal and vertical axes, the mounting being connected by cords to an instrument that recorded the angular displacement about these axes. The latter instrument was of the type usually employed for recording control positions of an airplane in flight. The camera was equipped with a 15-inch focal length lens and operated at an exposure time of $\frac{1}{2}$ second.

In order to record time intervals on the motion-picture film, a timing light was mounted in the camera field about 2 inches in front of the camera lens. This light was encased in a shell containing a short focal length lens interposed between the light and the camera lens. With this arrangement the timing light registered on the motion-picture film only when incandescent, as shown in figure 18. A timer was employed to operate the light at 1-second intervals.

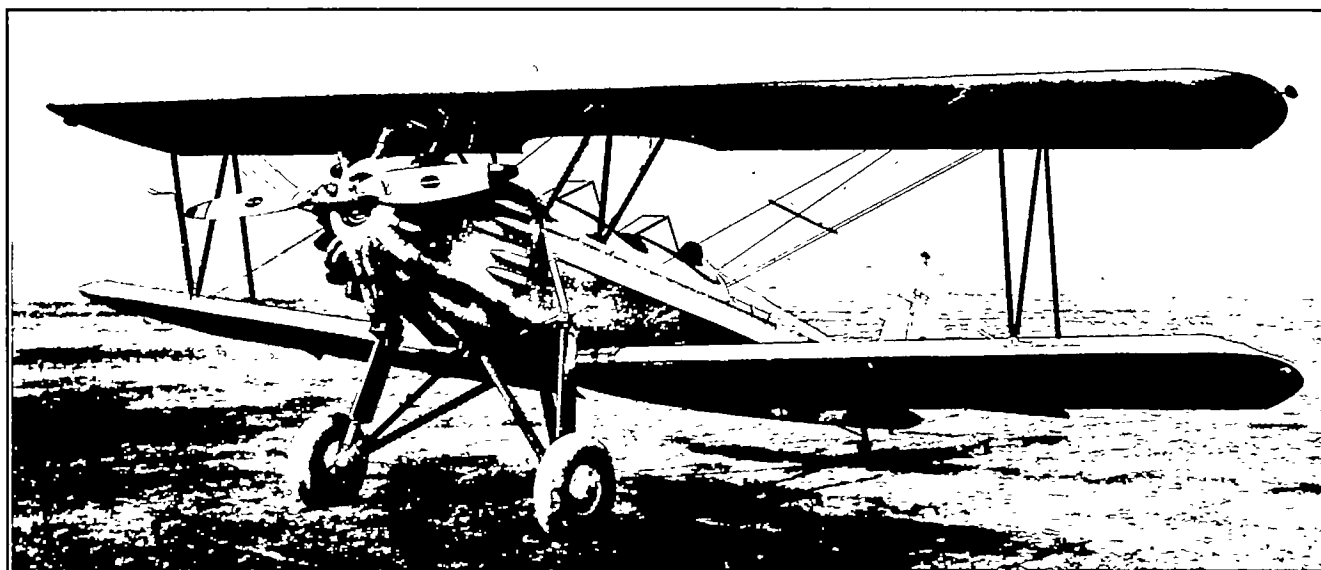

FIGURE 15.—Verville airplane with original landing gear.

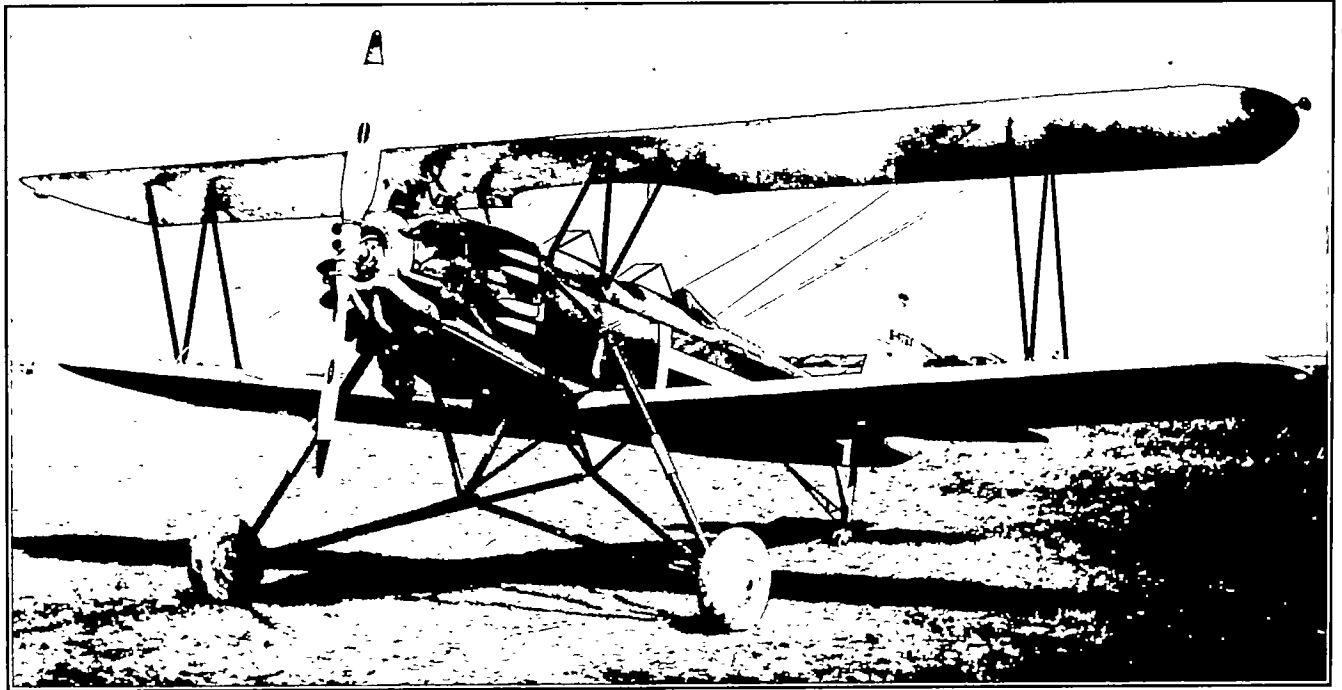

FIGURE 10.—Verville airplane modified for landing tests.

A special finder was provided for sighting the camera on the airplane. This finder consisted of a tube fitted with cross hairs at the objective end, the tube having a ratio of length to internal diameter equal to the ratio of the focal length of the camera to the height of the image field. The finder also served as a handle for manipulating the camera.

Instruments were mounted in the airplane to record air speed, angle of attack, and positions of the controls. The angle-of-attack recorder consisted of a vane pivoted about a horizontal axis, mounted on a boom forward of the upper wing, and connected by cords to a mechanism that recorded the angular position of the vane. The use of this instrument required a calibration to determine the alinement of the vane as a function of angle of attack. The other instruments were of the type usually employed by the N.A.C.A. in flight tests. The records obtained with the instruments were synchronized at 1-second intervals by means of a timer.

Test procedure.—At the outset, it was necessary to determine the relations between air speed, rate of descent, and elevator position for the airplane used. The results of these preliminary tests (fig. 19) were used to determine the "best" air speed for glide landings on the basis of change in rate of descent for a given change in air speed, the best air speed occurring where the change in rate of descent was a minimum for a change in air speed of approximately ± 6 miles per hour. Incidentally, it may be noted that these results, as well as the results of glide tests on several conventional airplanes, show that the best air speed is about 5 to 10 percent greater than the

minimum gliding speed. It may also be noted that the attitude corresponding to the best air speed is, in general, reasonably satisfactory for landing. During these preliminary tests the dynamic longitudinal

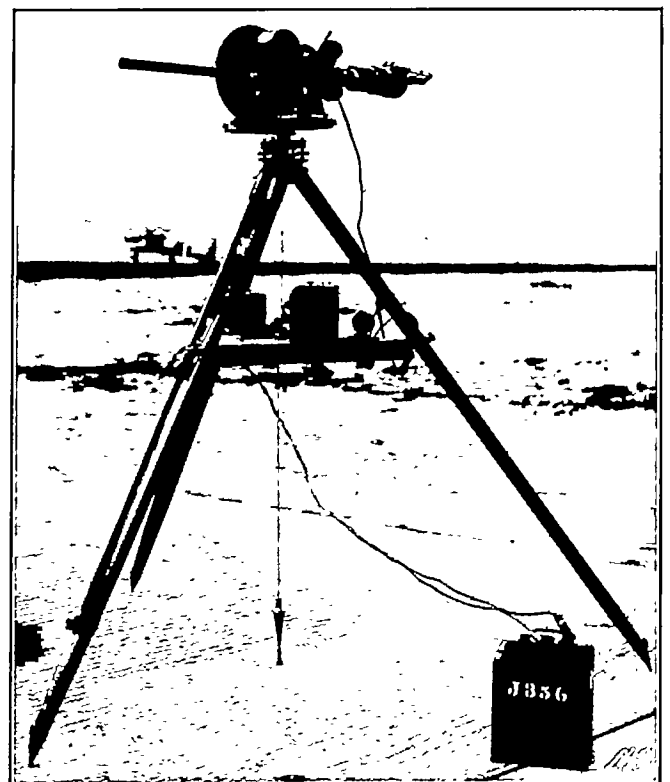

FIGURE 17.—Recording phototheodolite.

stability of the airplane in the low-speed gliding range was observed to be satisfactory.

The landing tests consisted of normal, pancake, and fixed-elevator glide landings in smooth air; normal and pancake landings in rough air; and simulated landings in rough air with fixed-elevator. In the simulated landings the records were started at an elevation of about 600 feet and the elevator was held approximately stationary for as long as the pilot deemed advisable. Although a strap was connected to the stick to assist the pilot in holding the elevator stationary in the fixed-stick glides, he was unable to do so and small elevator movements occurred.

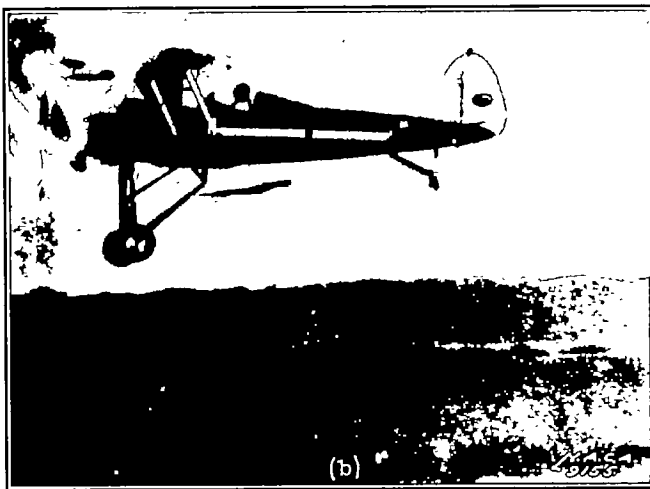
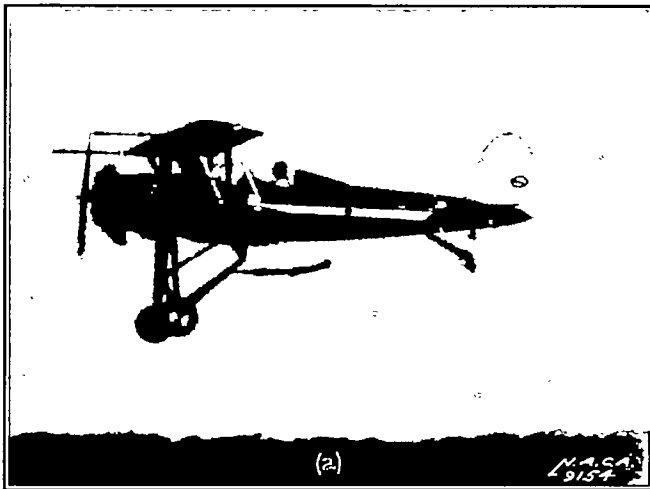

FIGURE 18.—Enlarged camera records: (a) Noninterference of timing light. (b) Record of timing-light filament.

The recording phototheodolite was set up for landing tests as shown in figure 20. After the camera station C was located, a reference line AC was established and markers B were placed on the field parallel to the wind direction at a distance of approximately 800 feet from the camera. These markers consisted merely of pieces of cloth laid on the ground to indicate to the pilot the desired point of contact and flight direction, the method of measurement being dependent on the pilot's following a straight line of flight during the approach for landing.

In order to establish definitely the line of flight E'F' actually followed during the approach for landing, the airplane was equipped with two weighted streamers that could be released by the pilot when desired. One streamer E was dropped at an elevation of several feet immediately prior to the starting of the recording instruments in the airplane. The second streamer F was dropped several seconds later, after the airplane had made contact with the ground in the actual landings or while it was still in the air in the simulated landings. The positions of these two streamers were located with respect to the reference line by triangulation, a transit being used to make the required measurements.

Shortly before a landing, the recording phototheodolite was leveled and sighted along the reference line and a short record taken to obtain a record of the angular position of reference point A. During the landing the camera C' was sighted on the airplane before the first streamer was dropped and was started

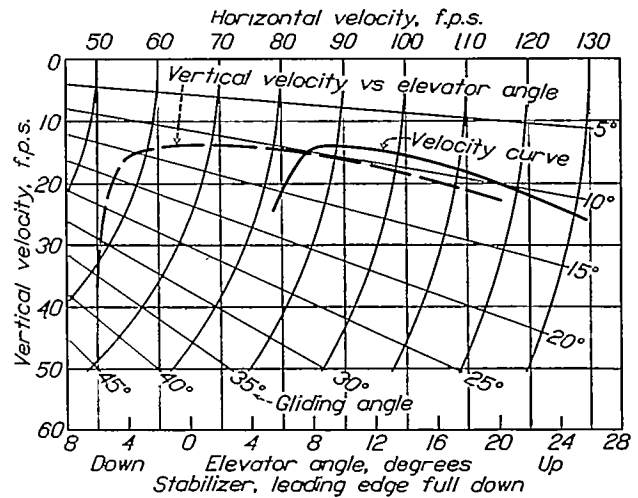

FIGURE 19.—Relations of air speeds, rates of descent, and elevator settings of modified Verville airplane in steady glides.

at the instant that this streamer was seen to leave the airplane. The camera was stopped after the airplane had made contact with the ground or upon the release of the second streamer.

Evaluation of data.—In the evaluation of records a datum time was used to synchronize the data obtained from the recording phototheodolite with records from the instruments mounted in the airplane. In the actual landings the datum time was taken as the instant of contact with the ground. In the motion-picture records this instant was indicated by the point at which the airplane wheels started rotating, segments of the wheels having been marked with white paint to make this method of identification possible. For the records obtained with the instruments mounted in the airplane, the instant of contact was determined by observing the accelerometer records, the other records being synchronized with the accelerometer records by means of the timer as previously noted.

In simulated landings, the datum time was taken as the instant of release of the second streamer. This streamer was large enough to be visible in the motion-picture records and was released simultaneously with the stopping of the recording instruments in the airplane.

Records of the angular positions θ and ϵ of the optical axis of the camera as a function of time were obtained directly with the recording phototheodolite. In general, however, the optical axis of the camera was not directed exactly at the center of gravity of the airplane. This deviation was shown by the position of the airplane in the motion-picture photographs and is indicated by the angles δ and φ on figure 20. Corrections for the deviation of the optical axis were made in order to obtain time histories of the angular position of the line $C'P$ joining the center of gravity of the airplane and the camera. Successive positions of the airplane in the vertical plane containing the line of

attitude angles were deduced by means of the following approximate expression:

$$\lambda = \tan^{-1} \frac{\tan \psi - \tan (\alpha - 90^\circ) \sin \epsilon_m}{\cos \epsilon_m \sec (\alpha - 90^\circ)}$$

where

λ is the corrected attitude.

ψ , the apparent attitude.

α , the angle between the vertical plane of the flight path and the vertical plane of the optical axis (fig. 20).

ϵ_m the mean of the angular elevation of the optical axis ϵ and the angular elevation of the airplane ϵ_a . (The difference between these elevation angles was necessarily small as the optical axis of the camera was always directed approximately on the airplane.)

RESULTS

The results of the landing measurements are presented in figures 21 to 27, inclusive, and in table II.

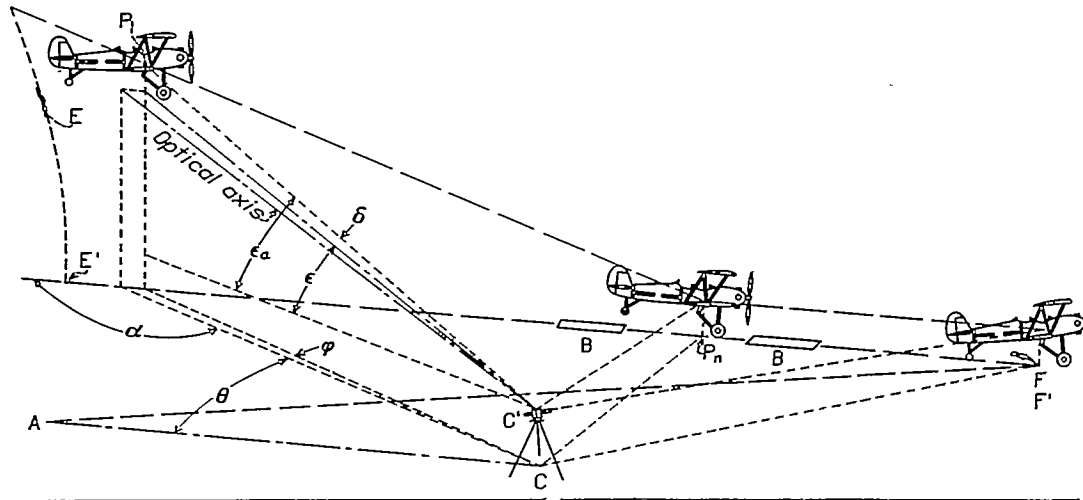

FIGURE 20.—Field layout for recording phototheodolite.

flight, as established by the weighted streamers, were determined by triangulation. Horizontal and vertical components of displacement were then plotted against time and differentiated graphically to determine the velocity components. The wind speed was deduced as the difference between the horizontal components of recorded air speed and the horizontal component of velocity along the flight path measured with reference to the ground.

The attitude of the airplane was also deduced from the records obtained with the recording phototheodolite. The apparent attitudes shown by the motion-picture records were measured, but required correction owing to the inclination of the optical axis to the vertical plane containing the line of flight. The true

Figures 21, 23, and 25, respectively, present data from normal, pancake, and fixed-elevator glide landings made in smooth air. Figures 22 and 24 were obtained from representative normal and pancake landings made in rough air, and figure 26 from data for a simulated fixed-elevator glide landing made in rough air. Figure 27 illustrates the shortening of the landing approach obtained with the airplane used in the tests by means of a fixed-elevator glide landing in zero wind. Table II shows the landing characteristics at contact for the typical cases. It should be noted that the vertical velocity of contact of 20.7 feet per second for the smooth-air pancake landing is unusually severe as compared with what would be permissible with an airplane having a normal landing gear.

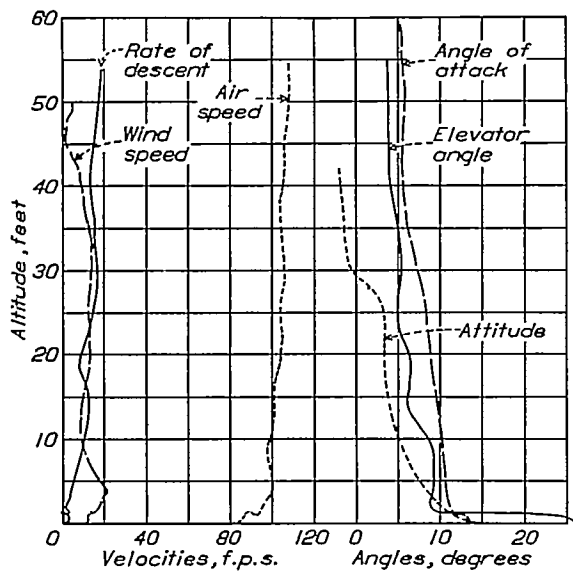

FIGURE 21.—Normal landing in smooth air.

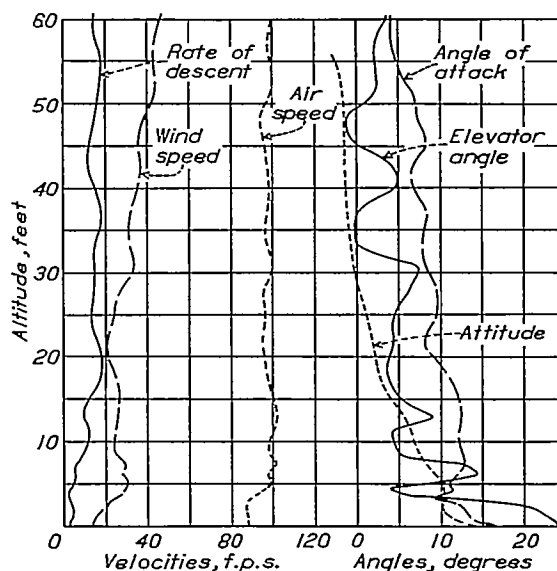

FIGURE 22.—Normal landing in rough air.

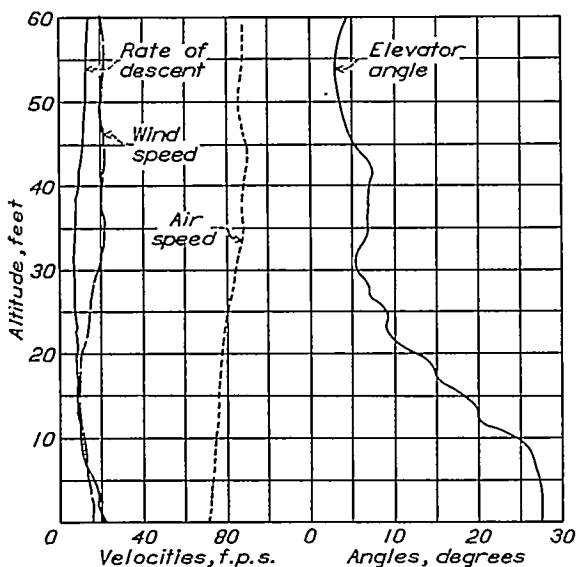

FIGURE 23.—Pancake landing in smooth air.

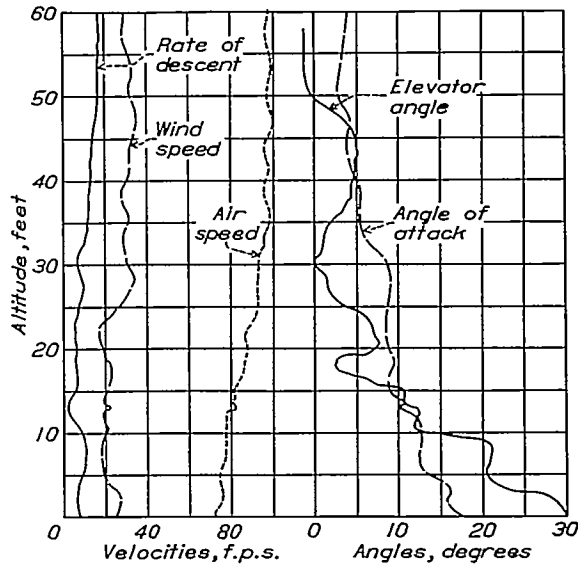

FIGURE 24.—Pancake landing in rough air.

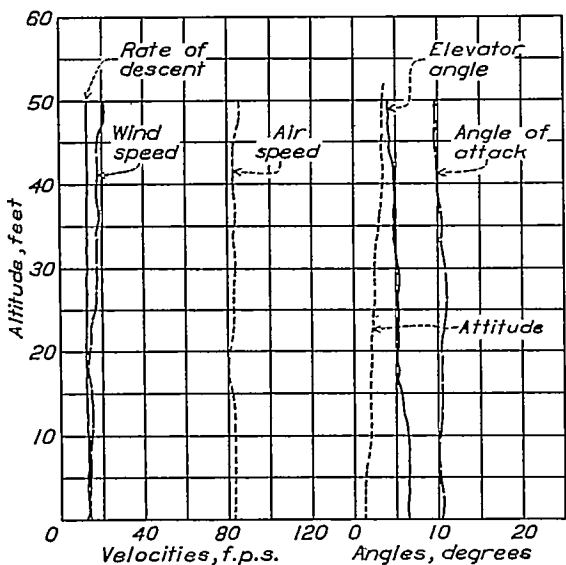

FIGURE 25.—Fixed-elevator landing in smooth air.

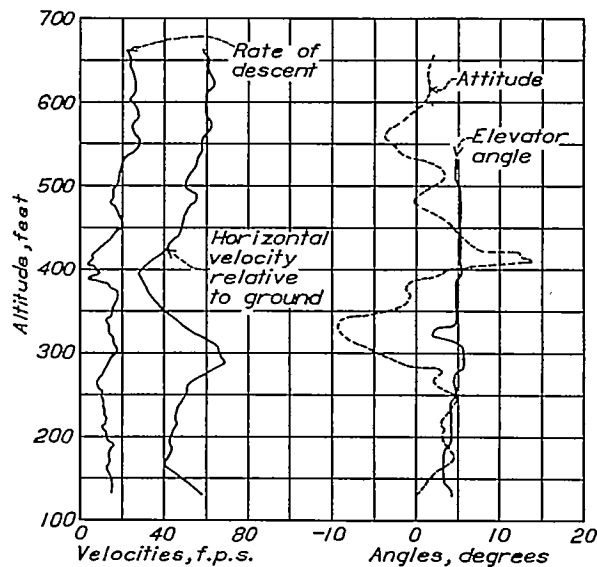

FIGURE 26.—Fixed-elevator glide in rough air.

The results presented in figures 21, 23, and 25 show that in smooth air the motion of the airplane remains reasonably steady without appreciable movement of the elevator. Figures 22 and 24 show, however, that in rough air the elevator must be moved vigorously to maintain approximately the desired attitude and flight path. An indication of what may happen if the elevator is not moved during a glide in rough air is presented in figure 26. In the glide from which these data were obtained, the pilot attempted to hold the controls in fixed positions from an altitude of approximately 650 feet down to 130 feet. During this glide, between the altitudes of 550 feet and 350 feet, the rate of descent varied from 28 to 4 feet per second; the attitude from 14° to -9° ; and the horizontal velocity, relative to the ground, from 58 to 28 feet per second. Unfortunately, no air-speed record was obtained in this case. The horizontal velocity is presented in lieu of the air speed to furnish an indication of the variance in speed of the airplane. In

feet per second vertically. The air speeds are believed to be precise to within ± 3 feet per second as regards absolute values and subject to no appreciable errors as regards the magnitude of variations. The angles of attack, attitude angles, and elevator positions are believed to be precise to within $\pm 1^\circ$. Owing to the manner in which wind speeds were determined, the values given are subject to the errors in the air speeds and the horizontal velocities relative to the ground. Hence, the precision of the wind speeds is of the order of ± 3 feet per second as regards both the general magnitude and the fluctuations with altitude.

DISCUSSION

The effect of gusts on a conventional airplane attempting a steady glide landing with fixed elevator is indicated by the analysis of the wind measurements and more conclusively demonstrated by the simulated landings. Both phases of the investigation indicate the necessity for control of the airplane's motion by the pilot in order to prevent dangerous changes in attitude and rate of descent. Thus such landings are shown to be impracticable except for smooth-air conditions; even then the landings are much more severe than those normally encountered, so that in general a special landing gear is required. The impracticability of such landings arises not merely from the fact that the elevator is held in a fixed position, but also from the fact that the pilot's ability to control the airplane is limited by the low air speed and the high angle of attack at which the glide is made. For safety it is essential that the approach for landing in rough air be made with a considerable margin of speed and angle of attack, a procedure that is in accordance with the practice of experienced pilots. The usefulness of fixed-elevator glide landings for conventional airplanes therefore seems to be limited to such cases as emergency landings in which there is ample assurance that the air is smooth, as for example in fog.

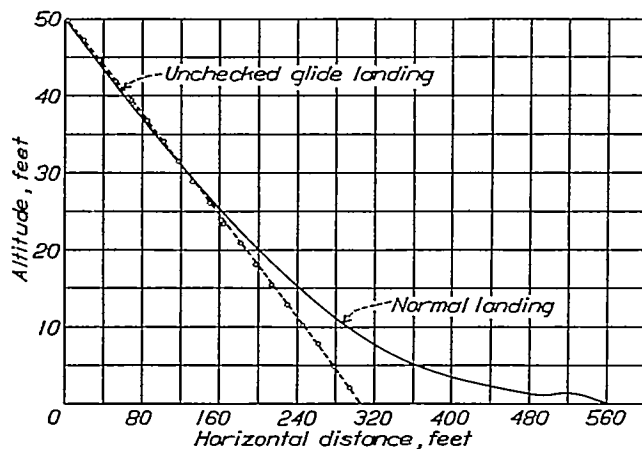

FIGURE 27.—Flight paths relative to air for normal landing and for fixed-elevator landing in smooth air.
 (From landings shown in figs. 21 and 25.)

another fixed-elevator glide in rough air for which no records were obtained, owing to failure of the recording phototheodolite, the vertical velocity of the airplane was observed to increase rapidly without any appreciable change in attitude at an altitude of approximately 100 feet. At an altitude of about 50 feet the pilot attempted to recover from the high rate of descent by using the throttle. He was unable to recover sufficiently, however, to avoid contact with the ground at a high rate of descent.

PRECISION

It is estimated that successive positions of the airplane were determined from the phototheodolite records with a precision of ± 0.8 foot horizontally and ± 0.5 foot vertically. Faired results reduce these errors to about ± 0.5 foot horizontally and ± 0.2 foot vertically. The velocities as determined from the slope of the displacement curves are estimated to have a precision of ± 3 feet per second horizontally and ± 2

Conditions would be considerably more favorable for the attempted glide landing if the airplane were equipped with a high-lift device that extends the lift curve without essentially modifying the wing characteristics in the normal range of angles of attack (for example, leading-edge slots or the leading-edge auxiliary airfoil described in reference 7). The glide could then be made under essentially the same conditions as before as regards angle of attack, flight path, air speed, and attitude, while the extension of the lift curve would tend to provide the margin of angle of attack and air speed required for safety. As the elevator travel would not be limited to the position corresponding to the desired gliding speed, it becomes apparent that the landing would then be essentially a normal landing, except that the airplane would be in a landing attitude throughout the approach. The usual change in attitude angle just before contact would not be essential in that case, provided that the landing gear were

capable of absorbing the shock resulting from the high rate of descent.

The effect of the average gradient of velocity with height is of limited practical significance, inasmuch as the gradient encountered in any particular case is probably influenced to a great extent by gusts. It would be well to bear in mind, however, that such an average gradient exists and that the rate of ascent as well as the rate of descent tends to be increased by the effect of this gradient. That the initial rate of climb in general is influenced by the wind velocity should be considered in connection with the measurement of take-off performance. A point worth noting in this connection is that the influence of the gradient tends to become confused with ground effect inasmuch as both factors influence the performance of an airplane close to the ground. The influence of a wind gradient of given magnitude, however, depends upon the rate of ascent or descent, whereas ground effect influences the performance in level flight as well as in climbs or glides.

CONCLUSIONS

1. The results of the wind-velocity measurements, which cover a range of heights from 6 to 51 feet and a range of average ground-wind speeds at the lower height of 8 to 16 miles per hour show:

a. An average increase in velocity with height that is expressed approximately by the relation $\frac{V}{V_1} = \left(\frac{h}{h_1}\right)^{1/7}$.

b. Maximum variations in horizontal components of the order of ± 4 miles per hour without perceptible dependence on the average velocity or the height.

c. Maximum variations of vertical components increasing in magnitude with height to a value of the order of ± 4 miles per hour at a height of 51 feet, without perceptible dependence on the average velocity.

2. Unchecked glide landings in gusty air with the conventional airplane are unduly hazardous even though the airplane is equipped with a landing gear of unusual shock-absorbing capacity. The hazard would tend to be reduced by the addition of the type of high-lift device that extends the lift curve without modifying the wing characteristics in the normal range of angles of attack.

LANGLEY MEMORIAL AERONAUTICAL LABORATORY,
 NATIONAL ADVISORY COMMITTEE FOR AERONAUTICS,
 LANGLEY FIELD, VA., April 3, 1934.

REFERENCES

1. Weick, Fred E.: Preliminary Investigation of Modifications to Conventional Airplanes to Give Nonstalling and Short-Landing Characteristics. T.R. No. 418, N.A.C.A., 1932.
2. Schmidt, Wilhelm: The Structure of the Wind. Sitzungsbericht Akademie der Wissenschaften, vol. 138, pp. 85-116, Vienna, 1929.
3. Burgess, C. P.: Note on the Variation of Wind Velocity with Altitude. Bur. Aero., Navy Dept. Design Memo. No. 124, 1932.
4. Bradfield, F. B., and Cohen, J.: Lift and Drag Measured in a Velocity Gradient. R. & M. No. 1489, British A.R.C., 1932.
5. Soulé, Hartley A., and Wheatley, John B.: A Comparison between the Theoretical and Measured Longitudinal Stability Characteristics of an Airplane. T.R. No. 442, N.A.C.A., 1932.
6. Rolinson, D.: Take-Off and Landing of Aircraft. R. & M. No. 1406, British A.R.C., 1931.
7. Soulé, Hartley A.: Flight Tests to Determine the Effect of a Fixed Auxiliary Airfoil on the Lift and Drag of a Parasol Monoplane. T.N. No. 440, N.A.C.A., 1932.

TABLE I.—CALCULATED EFFECT OF WIND GRADIENTS ON A LANDING AIRPLANE

	Computations based on gradients shown in fig. 13, starting time 1 second						Computations based on gradients shown in fig. 14, starting time 4 seconds						Computations based on average gradient for 16 m.p.h. ground wind without fluctuations					
	51	41	31	21	11	6	51	41	31	21	11	6	51	41	31	21	11	6
Height above ground.....feet..	51	41	31	21	11	6	51	41	31	21	11	6	51	41	31	21	11	6
Vertical velocity relative to air.....feet per second..	-10.0	-12.5	-17.6	-20.7	-22.9	-24.6	-10.0	-13.0	-16.1	-19.1	-20.7	-21.7	-10.0	-10.5	-12.1	-13.9	-15.8	-16.6
Vertical velocity relative to ground.....do.....	-8.7	-11.3	-16.6	-20.7	-23.3	-24.0	-14.3	-14.3	-15.2	-17.4	-19.8	-21.0	-10.0	-10.5	-12.1	-13.9	-15.8	-16.6
Horizontal velocity relative to air.....do.....	70.0	61.6	63.8	69.2	66.8	68.3	70.0	67.4	64.7	61.7	63.0	69.7	70.0	68.5	67.5	67.0	66.8	65.8
Horizontal velocity relative to ground.....do.....	33.3	32.9	33.7	35.5	37.9	39.0	32.6	32.4	33.1	34.5	36.6	37.7	41.0	40.9	41.1	41.8	43.0	43.8
Flight-path angle.....degrees..	-8.1	-11.5	-16.7	-19.3	-18.9	-22.9	-8.1	-10.9	-14.0	-17.2	-18.2	-20.0	-8.1	-8.7	-10.2	-11.7	-13.3	-14.1
Attitude angle.....do.....	6.3	3.5	-0.9	-4.1	-5.3	-6.8	6.3	5.3	2.2	-0.7	-3.2	-4.3	6.3	5.6	4.2	2.5	1.1	0.2
Angle of attack.....do.....	14.4	15.0	15.8	15.2	13.6	16.1	14.4	16.2	16.2	16.5	15.0	15.7	14.4	14.3	14.4	14.2	14.4	14.3

TABLE II.—LANDING CHARACTERISTICS AT CONTACT FOR MODIFIED VERVILLE AIRPLANE

Type of landing	Air conditions	Air speed	Angle of attack	Attitude	Horizontal velocity		Vertical velocity	Elevator angle
					Air	Ground		
					Feet per second	Feet per second		
Normal.....	Smooth.....	82	13.5	14	82	71	0.5	26
Do.....	Bumpy.....	89	16.5	14	89	81	3.6	24
Pancake.....	Smooth.....	71	18.2	11.8	68	52	20.7	27.5
Do.....	Bumpy.....	72	17.4	11.8	71	42	7.4	30
Fixed elevator glide.....	Smooth.....	83	10.5	1.2	82	68.5	13.9	6.5