

## REPORT No. 495

### A DESCRIPTION AND TEST RESULTS OF A SPARK-IGNITION AND A COMPRESSION-IGNITION 2-STROKE-CYCLE ENGINE

By J. A. SPANOGLE and E. G. WHITNEY

#### SUMMARY

*A single-cylinder, gasoline-injection, spark-ignition, 2-stroke-cycle engine was constructed using a modified air-cooled Liberty engine cylinder and a universal test engine base. The combustion and scavenging air were admitted through piston-controlled ports near the bottom of the cylinder and the exhaust gases discharged through two poppet valves in the cylinder head. The displacement of the engine was 118 cubic inches. Optimum performance was obtained with the inlet air directed into the cylinder at an angle of 20° to the radial. A maximum net brake mean effective pressure of 132 pounds per square inch was obtained at an engine speed of 1,000 r.p.m. A maximum of 43.0 net brake horsepower was obtained at 1,225 r.p.m. The cylinder could not be cooled satisfactorily at high power outputs with an air velocity of 120 miles per hour.*

*A water-cooled cylinder of the same displacement was constructed to continue the 2-stroke-cycle investigation to higher speeds and under more favorable cooling conditions. Four masked poppet valves in the cylinder head were used for exhaust. The engine could be operated with either spark ignition or compression ignition. With spark ignition a maximum of 69.0 gross brake horsepower (uncorrected for blower power) was developed at 1,800 r.p.m. using a scavenging pressure of 8.4 inches of mercury—a specific output of 0.585 gross brake horsepower per cubic inch of piston displacement.*

*More extensive tests were conducted with the engine operating on compression ignition. The optimum fuel-spray distribution was determined by systematically varying the number, size, and arrangement of the orifices in the fuel-injection valve. Inertia of the scavenging air and length of the exhaust pipes had a marked effect on the engine performance. With other conditions constant, the increase in gross power output was found to be proportional to the increase in scavenging pressure. A maximum gross mean effective pressure of 167 pounds per square inch was obtained at 1,230 r.p.m. with a scavenging air pressure of 8.0 inches of mercury. The corresponding gross brake horsepower was 61.5.*

#### INTRODUCTION

The possibility of obtaining greatly increased power per unit of piston displacement has caused much effort to be directed toward the development of 2-stroke-cycle engines suitable for aircraft. The outstanding 2-stroke-cycle aircraft engine at this time is the Junkers 800-horsepower, valveless, opposed piston, compression-ignition engine (reference 1). Other engines, less well known and less thoroughly developed but of very promising performance, have been described and advertised. A list of 130 spark-ignition and 11 high-speed, compression-ignition 2-stroke-cycle engines is given in reference 2.

Fuel economy in the conventional 2-stroke-cycle spark-ignition engine is poor because the cylinder is scavenged with a carbureted mixture. The loss of fuel with the scavenging air can be prevented by injecting the fuel into the engine cylinder after the scavenging has been completed. The first tests conducted by the N.A.C.A. on a single-cylinder 2-stroke-cycle spark-ignition engine with fuel injection are reported in reference 3. The method of scavenging and charging the cylinder utilized piston-controlled inlet ports located near the bottom of the cylinder and mechanically operated exhaust valves in the cylinder head. The results obtained were sufficiently promising to warrant further investigation with fuel injection and spark ignition, with the same arrangement of inlet ports and exhaust valves. A modified air-cooled cylinder was used with movable guide vanes placed at the inlet ports to direct the inlet air so that it passed through the cylinder in an orderly swirl.

At high power outputs it was impossible to cool satisfactorily the air-cooled cylinder with the available air blast. A water-cooled cylinder was constructed to continue the investigation to higher speeds. The cylinder was designed for operating with fuel injection and both spark ignition and compression ignition.

This report covers the investigation with the air-cooled engine conducted prior to the latter part of 1931 and the work in connection with the water-cooled engine continued from that time until the summer of 1933.

**I.—AIR-COOLED TEST ENGINE**

**DESCRIPTION**

The air-cooled 2-stroke-cycle test engine consisted of a modified Liberty air-cooled engine cylinder mounted on the crankcase of an N.A.C.A. universal test engine. The bore was  $4\frac{1}{8}$  inches and the stroke 7 inches, giving a swept volume of 118 cubic inches. The compression ratio computed on the swept volume was 5.3. Figure 1 shows the general appearance of the engine and test apparatus; the large cone in the right foreground is the fan for supplying the cooling air. Details of the cylinder, piston, and valve mech-

cylinder barrel. The cylinder was adapted to the N.A.C.A. universal test engine base by the addition of a cast aluminum base and a short extension to the barrel to accommodate the longer piston required for 2-stroke-cycle operation.

Six rectangular inlet ports spaced evenly around the cylinder and having a combined width equal to one-half the cylinder circumference provided a total scavenging and charging period of  $80^\circ$  of crankshaft rotation,  $40^\circ$  on either side of bottom center. A suitable manifold with adjustable guide vanes was clamped around the cylinder to direct the scavenging

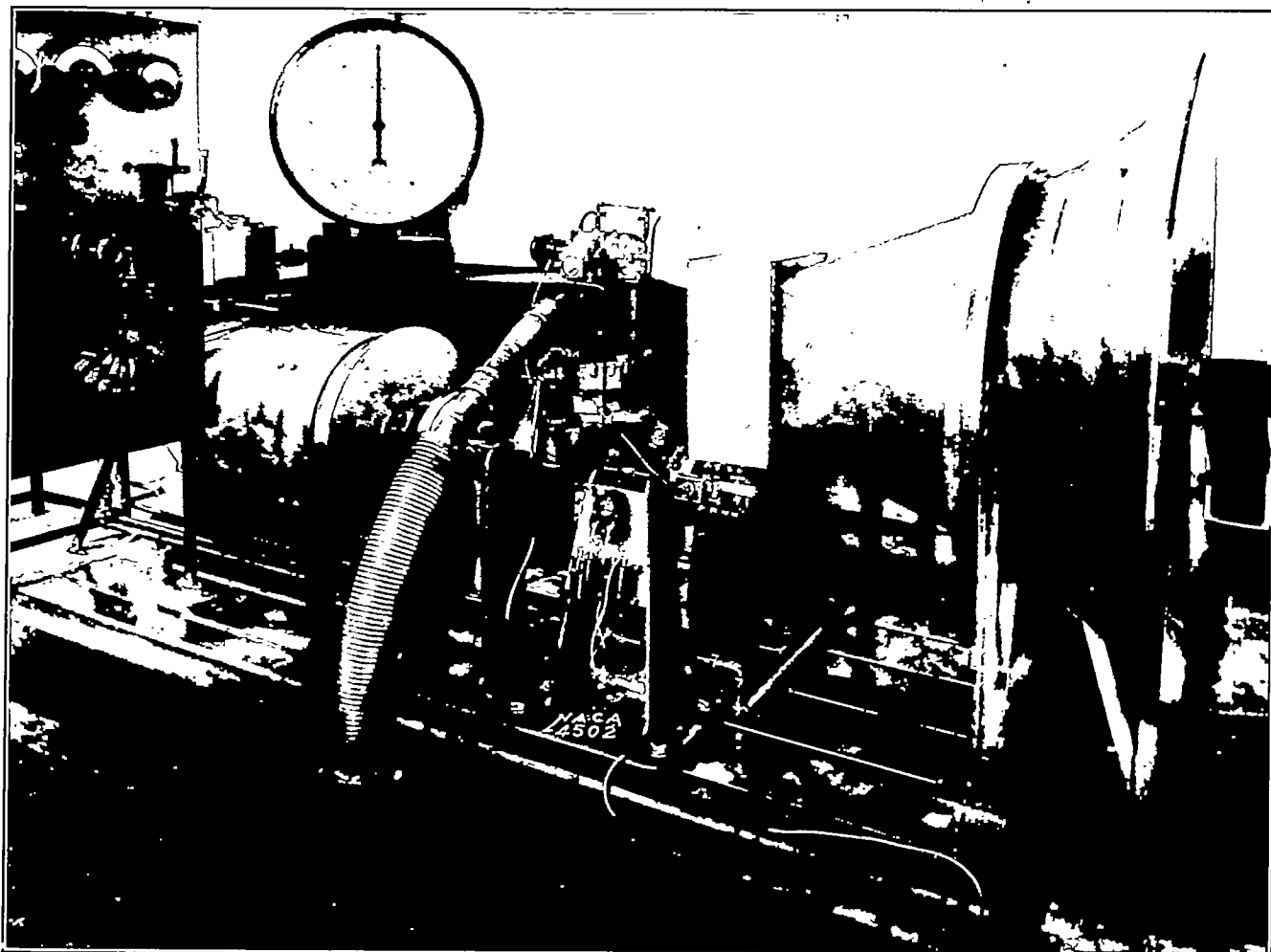

FIGURE 1.—The 2-stroke-cycle air-cooled test engine and test apparatus.

anism are shown by the sectional views of figure 2. The construction of the crankcase is described in reference 4.

The cylinder of the Liberty air-cooled engine was selected for this work since it could be conveniently adapted to the available test engine base and the necessary alterations for 2-stroke-cycle operation could be readily made. It embodied conventional air-cooled cylinder construction with a domed 2-valve head of cast aluminum alloy screwed and shrunk onto a steel

air into the inlet ports. Figure 3 is a view of the altered cylinder showing the inlet manifold in place with the cover removed. The guide vanes, pivoted in the manifold at the inlet ports, were controllable through a range of  $50^\circ$  by the knob on the outside of the manifold. With this mechanism the effect of the direction of the streams of scavenging air entering the cylinder could be studied.

In order to utilize the greatest available time-area, both poppet valves in the cylinder head were operated

as exhaust valves, the original 1½-inch exhaust valve

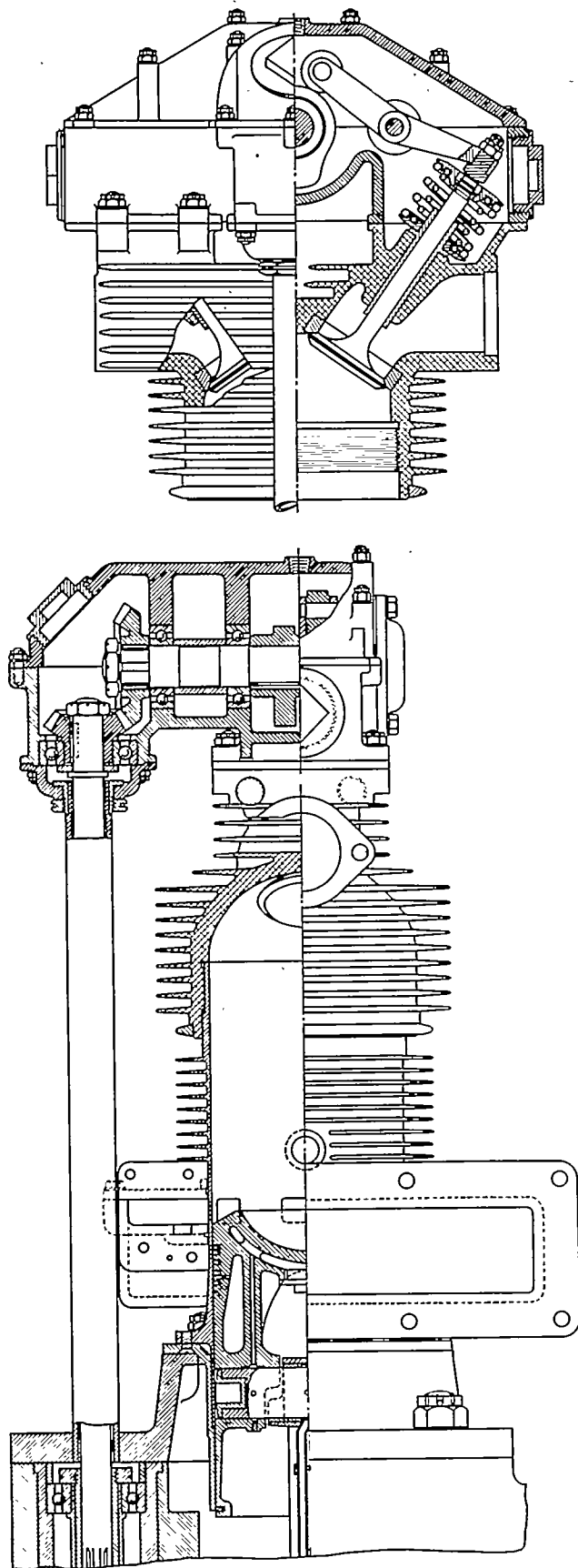

FIGURE 2.—Sectional views of the 2-stroke-cycle air-cooled test engine.

being unchanged and a salt-cooled valve substituted for the original 2½-inch inlet valve with a plain stem.

Both valves were operated simultaneously through rocker arms by a single overhead camshaft. The lift of the exhaust valves was 0.50 inch. Helical valve springs of greater total force were installed to meet the higher accelerations required for 2-stroke-cycle operation.

The trunk-type piston with a solid skirt was cast of Y alloy. The piston crown was beveled upward at 30° at the outside rim to give the entering air an upward deflection and was dished in the center, which combined with the domed cylinder head to form an

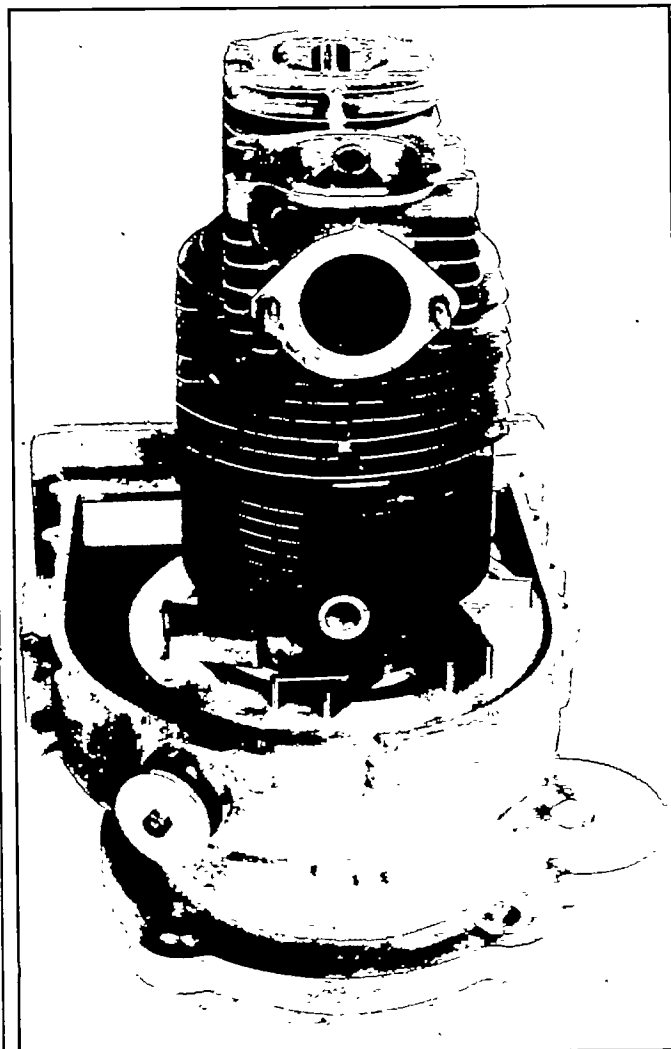

FIGURE 3.—Altered air-cooled cylinder showing inlet manifold and guide vanes.

approximately spherical combustion chamber. The piston head was cast hollow for oil cooling; drilled passages led the oil from the pin bosses to the head cavity whence it drained back to the crankcase through a metering orifice.

Six ⅜-inch piston rings were used: 3 compression, 2 oil scraper, and 1 air seal. Two of the compression rings were installed in the top groove. Oil rings had beveled faces and drain holes were provided below the ring grooves. The air-seal ring was provided at the lower edge of the piston to prevent loss of air from the manifold into the crankcase.

A 1¼-inch freely floating piston pin was used, with a pressed-in duralumin plug in each end. Forced lubrication was supplied to the piston pin by means of a tube added to the Liberty connecting rod. Pressure lubrication was maintained at the piston bosses through drilled holes in the hollow piston pin. Alumi-

of the impinging-jets type (reference 5), adjusted to open at a pressure of 1,500 to 2,000 pounds per square inch, and the cam-operated port-controlled plunger pump shown in figure 4. The pump cam was driven from the engine crankshaft through a phase-changing gear. The flat spray of gasoline injected into the

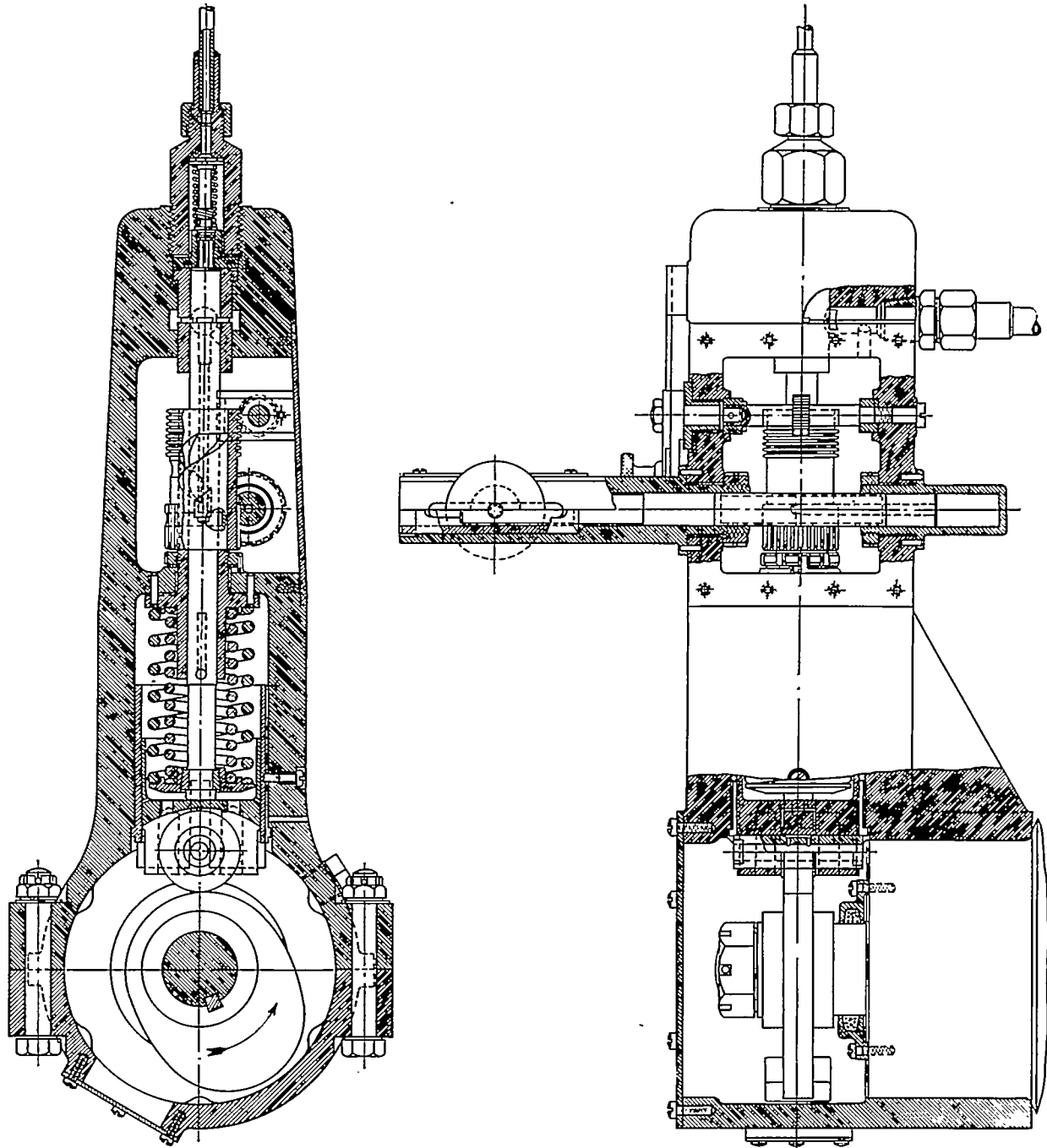

FIGURE 4.—Sectional views of the port-control fuel-injection pump.

num tubes pressed into the piston carried oil under pressure from annular grooves in the pin bosses to the thrust faces of the piston skirt.

The system for injecting the gasoline into the engine cylinder included an automatic injection valve

cylinder had sufficient penetration to impinge upon the opposite cylinder wall and impair the lubricating qualities of a mineral-oil film. Possible breakdown of the oil film opposite the injection valve was prevented by lubricating the engine with castor oil.

A modified automobile circuit breaker, driven from the camshaft, was used with two spark coils. The two spark plugs were located on opposite sides of the combustion chamber. The spark timing range was 40 crankshaft degrees.

Cooling air was supplied at speeds up to 120 miles per hour by a 4-bladed propeller, belt-driven from a motor and mounted at the mouth of a metal cone. The cone faired into a reduced section 11 inches by 17 inches at the small end and directed a rectangular stream of air over the engine cylinder. Thermocouples

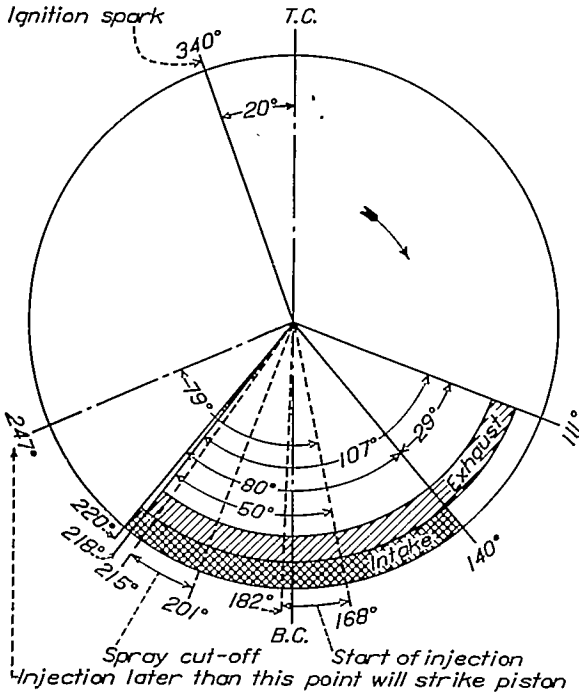

FIGURE 5.—Timing diagram of the air-cooled test engine.

connected to a recording pyrometer measured the temperatures at 12 points on the cylinder and head.

Scavenging air was supplied by a calibrated Roots-type blower separately driven by a variable-speed electric motor. A surge tank of 16-cubic-foot capacity was installed between the inlet blower and engine manifold. Scavenging pressure, as referred to in this report, is the pressure in the surge tank as indicated by a mercury manometer. Electrically operated counters in the stop-watch circuit that automatically times the consumption of one-half pound of fuel were used to determine blower and engine revolutions and the fuel quantity injected per cycle.

## TESTS AND RESULTS

### Spark ignition

Preliminary tests with the air-cooled engine showed that forced lubrication to the piston skirt was undesirable; oil was thrown from the inlet ports and exhaust valves and was burned in such quantities in the combustion chamber that, once started, the engine would continue to run with no gasoline injected. This

condition was remedied by successively closing the oil-supply holes until all forced lubrication to the piston skirt was eliminated.

Stresses in the valve-operating mechanism, especially in the valve springs, limited the maximum allowable engine speed to 1,350 r.p.m. and led to the adoption of 1,000 r.p.m. as standard test speed. However, even at these comparatively low speeds, the 120-mile-per-hour blast of cooling air was inadequate to limit the maximum cylinder-head temperatures to 600° F. when operating at high power outputs. In order to operate at 8 inches of mercury scavenging pressure,

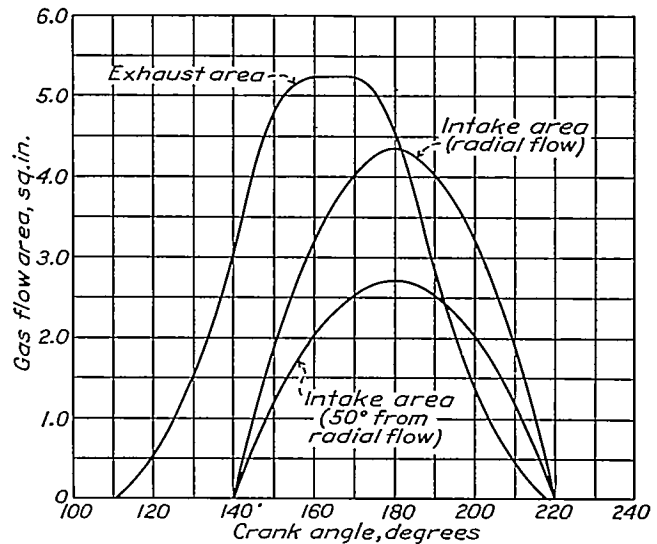

FIGURE 6.—Gas-flow area diagram of the air-cooled test engine.

it was necessary to use air deflectors and a water spray directed onto the cylinder head.

**Timing.**—Figure 5 shows the timing diagram adopted. The values for exhaust opening and closing are those determined under static conditions; with the engine running, the valves opened 2° later and closed 4° earlier than this diagram indicates. Comparative inlet and exhaust time areas are shown in figure 6. Two inlet-area curves are shown representing the flow areas with the guide vanes at their limiting positions; the difference in areas was caused by the restriction due to the angularity of the vanes.

The periods during which fuel was injected are shown on figure 5 for the injection valve installed near the bottom of the cylinder. The earliest injection corresponds to the condition of lowest scavenging pressure. As the scavenging pressure was increased, later injection was necessary for optimum performance, probably because injection started before the exhaust valve closed, so that with the higher scavenging velocities and equally early injection, some of the fuel would be carried out the exhaust. Tests were conducted also with the injection valve in one of the upper spark-plug holes. The performance, however, was inferior and the engine decidedly less flexible. All the performance

curves presented were obtained with the injection valve just above the inlet ports.

Effect of inlet-vane angle.—A constant-speed, constant-scavenging-pressure test was conducted during

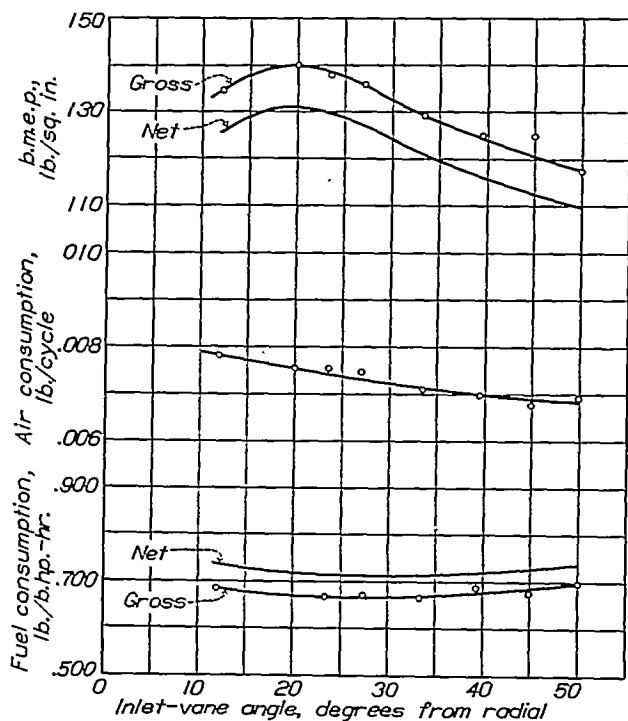

FIGURE 7.—Effect of inlet-vane angle on the maximum power performance of the air-cooled test engine. Engine speed, 1,000 r.p.m.; scavenging pressure, 8 inches of mercury.

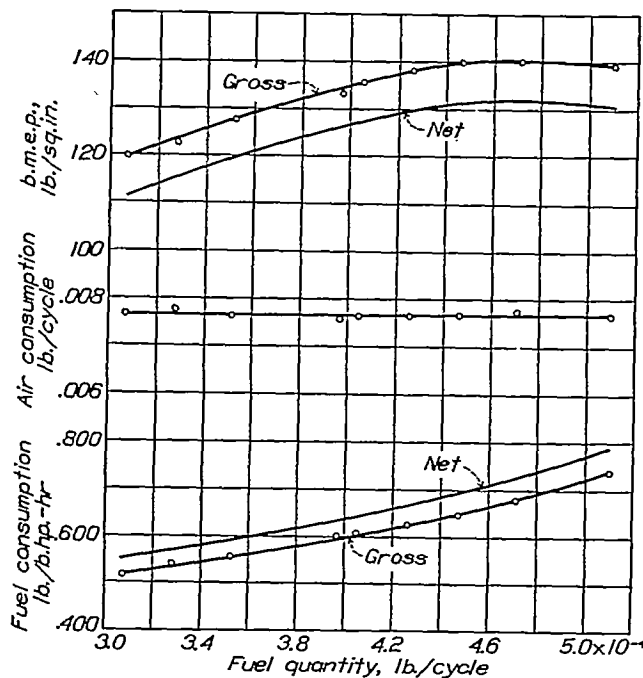

FIGURE 8.—Effect of fuel quantity on the performance of the air-cooled test engine. Engine speed, 1,000 r.p.m.; inlet-vane angle, 20° from radial; scavenging pressure, 8 inches of mercury.

which the inlet-vane angle was varied over its entire range and the air consumption, mean effective pressure, and fuel consumption were measured at maximum

power. Figure 7 gives the results of this investigation for an engine speed of 1,000 r.p.m. and a scavenging pressure of 8 inches of mercury. Gross and net brake mean effective pressures and fuel consumptions are plotted, the difference between them representing the power required to supply the combustion and scavenging air, computed on the assumption of a 70-percent over-all adiabatic efficiency. Values of mean effective

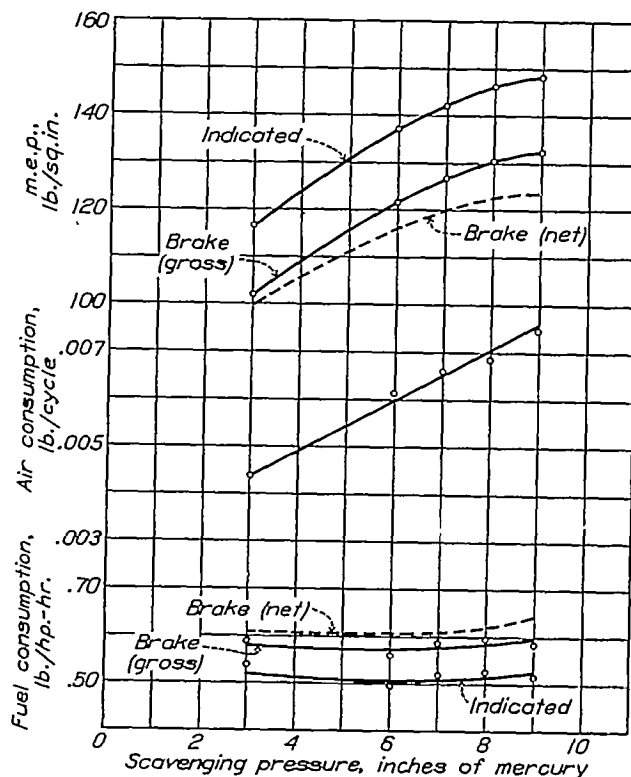

FIGURE 9.—Effect of scavenging pressure on the performance of the air-cooled test engine. Engine speed, 1,000 r.p.m.; inlet-vane angle, 23° from radial.

pressure are computed on a basis of 118 cubic inches displaced volume.

The air consumption decreased steadily as the vane angle was varied from the radial due to increasing restriction of flow area. However, maximum mean effective pressure was not obtained at the vane setting giving maximum air consumption but at a vane angle of 20° from the radial, at which setting the air consumed was but 91 percent of the maximum. Increased scavenging efficiency resulting from the swirling motion given the air by the 20° vane angle is apparently responsible for the increased power.

Effect of fuel quantity.—With the supply of fuel and air to the cylinder independently controlled and the amount of air charge retained in the cylinder unknown, it was not possible to establish and maintain a constant fuel-air ratio for all conditions of engine speed and load. Since the performance of the engine varied widely with the fuel-air ratio, a test was conducted in which the amount of air supplied to the cylinder per cycle was maintained constant and the quantity of fuel

injected varied. Figure 8 shows the variation in brake mean effective pressure with specific fuel consumption at 1,000 r.p.m. and a scavenging air pressure of 8 inches of mercury with the inlet vanes set to give best performance. The lowest fuel quantity recorded gave the leanest mixture at which the engine would run

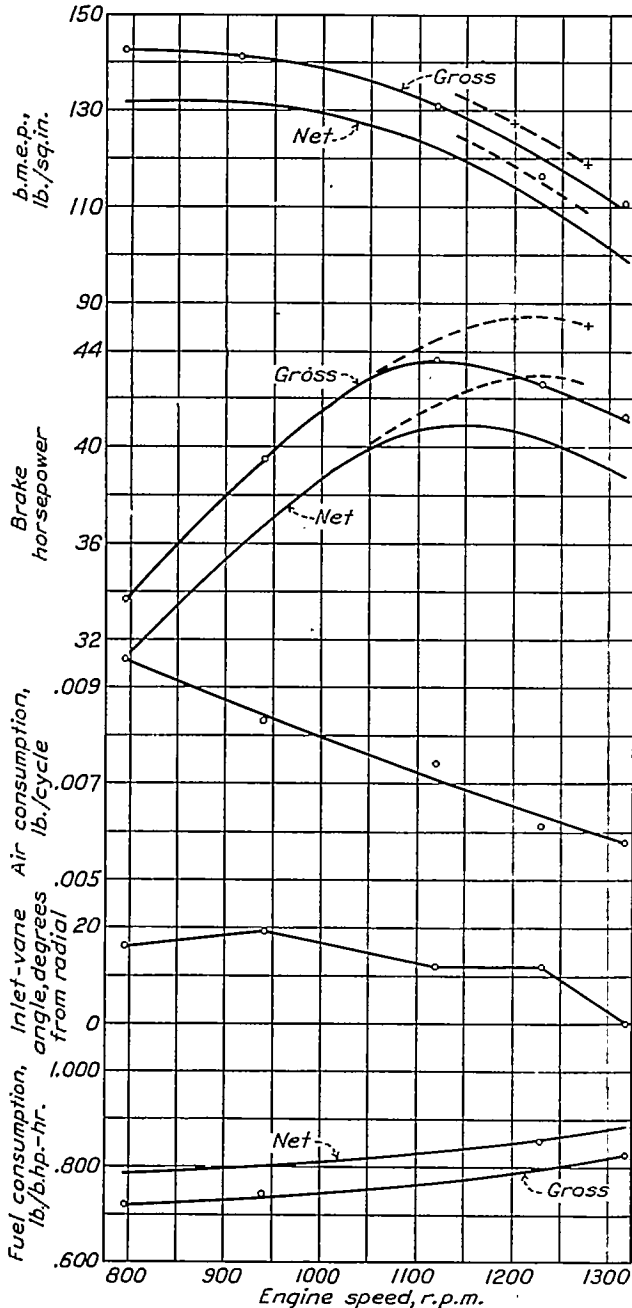

FIGURE 10.—Effect of speed on maximum power performance of the air-cooled test engine. Scavenging pressure, 8 inches of mercury; dotted line, exhaust opens 105° after top center.

evenly. At the rich end of the mixture range the engine still ran smoothly after the brake mean effective pressure had peaked over. A maximum net brake mean effective pressure of 132 pounds per square inch was

obtained at a specific fuel consumption of 0.71 pound per brake horsepower-hour. At best economy, 0.55 pound per brake horsepower-hour, the net brake mean effective pressure dropped to 111 pounds per square inch.

**Effect of scavenging pressure.**—The variation in performance with scavenging pressure is shown by figure 9. The inlet-vane angle was set at 23° and mixture ratios chosen to maintain the net fuel consumption below 0.65 pound per horsepower-hour. Air consumption was found to increase uniformly with increasing scavenging pressure. Mean effective pressures increased more slowly and at a diminishing rate. The greatest variation in specific fuel consumption was 7 percent. A maximum net brake mean effective pressure of 123 pounds per square inch was obtained at 9 inches of mercury scavenging pressure with a net specific fuel

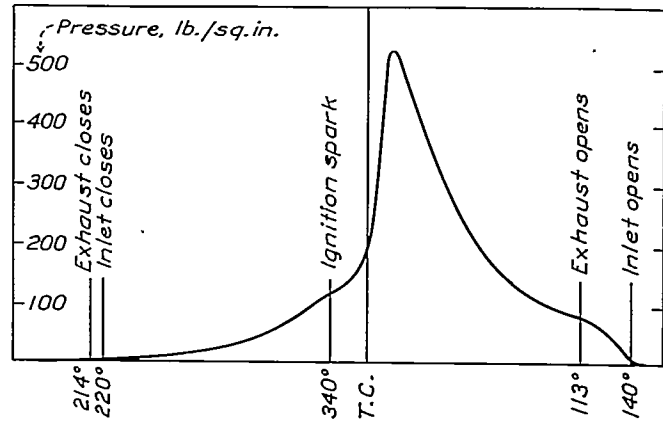

FIGURE 11.—Pressure-time card of the air-cooled test engine. Engine speed, 1,020 r.p.m.; scavenging pressure, 8 inches of mercury; l.m.a.p., 133 pounds per square inch.

consumption of 0.63 pound per horsepower-hour. Maximum cylinder pressures were constant at about 600 pounds per square inch. The friction mean effective pressure was 16 pounds per square inch at 1,000 r.p.m.

**Effect of speed.**—With the optimum inlet-vane setting for each speed, a maximum power test was conducted at 8 inches of mercury scavenging pressure over a speed range from 800 to 1,320 r.p.m. Figure 10 shows the gross and net brake results. It is evident from the early peaking of the power curve that the engine breathing capacity was insufficient; as the speed increased, it was necessary to diminish the restriction at the inlet ports by decreasing the angle of the inlet vanes to obtain maximum power. The solid lines show the brake mean effective pressure and horsepower obtained with the valve timing of figure 4. An improvement in performance, shown by the dotted lines, was obtained by opening the exhaust valves 6° earlier. At the higher speeds the brake mean effective pressure

was increased 4 pounds per square inch and the maximum net horsepower was increased from 40.8 at 1,150 r.p.m. to 43.0 at 1,225 r.p.m. Air consumption decreased in direct proportion to the increase in speed, whereas specific fuel consumption increased. Rich fuel-air mixtures were used to aid cylinder cooling; the output to be expected at lower fuel consumption may be estimated from the curve of variation of mean effective pressure with fuel economy (fig. 8).

Figure 11 shows a pressure-time card reproduced from a record obtained with a modified Farnboro indicator for the engine developing an indicated mean effective pressure of 133 pounds per square inch at 1,020 r.p.m. The sacrifice in expansion stroke as compared with a 4-stroke-cycle engine is apparent.

**Idling characteristics.**—In tests conducted to determine the idling characteristics of the engine, it was found that regular firing could be obtained at 650 r.p.m. by throttling the inlet air. A further reduction in speed to as low as 250 r.p.m. was found possible by injecting an excessive fuel charge with the inlet air throttled, an explosion occurring about every 8 to 10 cycles. The intermittent firing seemed to be caused by the mixture being overrich for ignition at speeds above 250 r.p.m.; the increase in speed occasioned by a firing impulse diminished the time available for air to enter the cylinder and an ignitable mixture would not be obtained until some 8 to 10 cycles later when the speed had again decreased and enough time had elapsed to develop another ignitable mixture. Spark plugs fouled quickly under these conditions.

#### COMPRESSION IGNITION

A similar air-cooled cylinder was modified for tests with fuel-oil injection and compression ignition. The dished-crown piston was replaced by a convex-crown piston to increase the compression ratio and the injection valve installed in one of the original spark-plug holes in the cylinder head. The timing of the exhaust valves and inlet ports was unchanged and a few tests conducted with diesel fuel. Fuel distribution was poor, however, as the spray impinged on the piston crown soon after leaving the injection valve nozzle, destroying its penetration. The exhaust was smoky and the fuel consumption high. Tests, however, demonstrated the vane angle for best performance to be 33° from the radial. Failure of the cylinder, weakened by the inlet ports and overstressed by high explosion pressures, terminated the compression-ignition tests.

## II.—WATER-COOLED TEST ENGINE

### DESCRIPTION

A water-cooled cylinder unit was constructed and adapted to the crankcase used for the air-cooled engine tests. The 4½-inch bore and 7-inch stroke were retained and also the piston-controlled inlet ports and poppet exhaust valves. Four exhaust valves were used, operated by individual cams on two overhead camshafts. A general view of the engine test apparatus is given in figure 12 and sectional views of the cylinder unit in figure 13.

The cylinder was constructed of two castings, a steel liner, and removable guide vanes. The lower casting forms the inlet manifold and adapts the cylinder casting to the crankcase. The upper casting serves as a water jacket around the pressed-in liner and bolts to the top of the manifold casting to complete the manifold and transfer the loads to the crankcase. Four openings from the outside to the cylinder bore are tapped to accommodate injection valves or pressure-measuring instruments. Steel guide vanes are doweled and screwed into the manifold cover casting and impart a swirling motion to the incoming air. These vanes are interchangeable to give two degrees of swirl, viz, an entering stream approximately 20° to the radial or a flow approximately 33° to the radial. These angles were determined by the previous experiments with the air-cooled cylinder as those giving the best performance with spark ignition and compression ignition, respectively. Figure 14 shows the vane arrangement viewed from below.

The steel cylinder liner is pressed into the cylinder castings with rubber-ring gaskets just above and below the inlet ports. Eight equally spaced inlet ports are cut through the liner near its lower end. The sides of the ports are beveled radially to provide a smooth flow of entering air and the upper and lower edges are beveled upward at an angle of 30°. The cylinder design allows interchangeability of liners to facilitate variation in size and timing of inlet ports. During the tests of this report, a port height of 1 inch was used with a combined port length equal to eight-tenths of the cylinder circumference. An inlet period of 100 crank degrees equally divided from bottom center was thereby provided.

The cylinder head constructed for this engine contained the disk form of combustion chamber and gave a compression ratio of 13.3, based on the displaced volume, when used with a flat-top piston.



The four symmetrically spaced exhaust valves seated in individual recesses one-sixteenth inch deep and one sixty-fourth inch larger in diameter than the valve heads, so that with the valves closed the valve heads were flush with the roof of the combustion chamber. Water-jacketed exhaust passages faired into two external ports exhausting on opposite sides of the head. Cooling water entered the head through two inlets at the bottom and was discharged through two outlets at the top after having been directed around the combustion chamber, valve ports, and valve guides. Four equally spaced spark-plug or injection-valve holes were tapped radially into the combustion chamber.

A cylinder-head spacer, not shown in figure 13, was designed to be bolted between the cylinder and

the areas that would be obtained without valve masking. Both curves are flat-topped at a total area of 5.4 square inches, since at this value the area of flow through the valves equals the minimum area of the ports. The excess lift of the valves permitted quick opening and closing. Figure 16 shows the comparative gas-flow areas provided by the exhaust valves and inlet ports.

The valve-operating mechanism built for this cylinder consists of a vertical shaft driven from the crankshaft and driving two overhead camshafts; four cams are keyed to the camshafts and four tappet arms are interposed between the cams and the valve stems. The underside of the tappet arms has a doweled and screwed-on hardened tappet to bear on the end of the valve stems. Shims between the tappet and arm

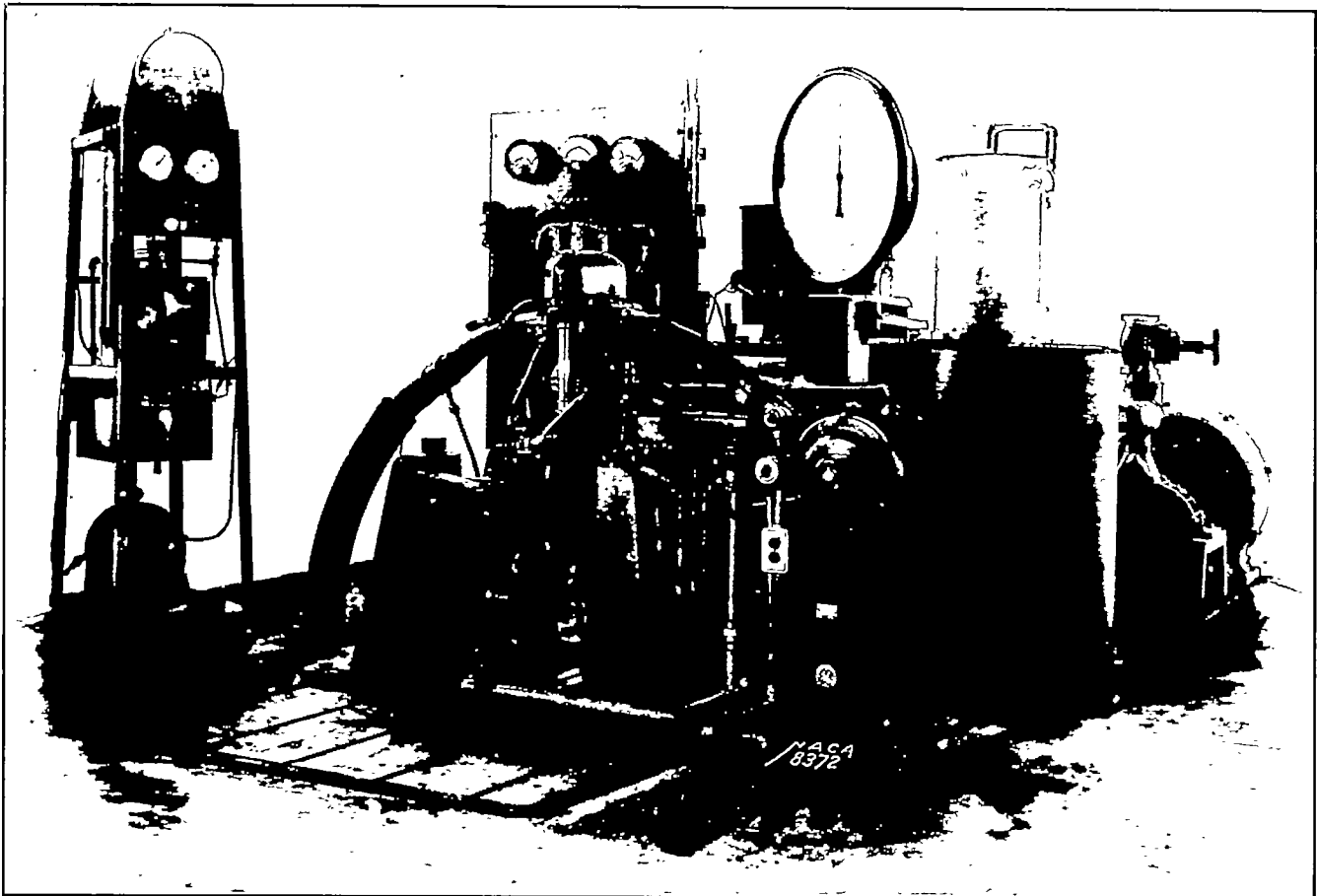

FIGURE 12.—The 2-stroke-cycle water-cooled test engine and test apparatus.

cylinder head to reduce the compression ratio for spark-ignition tests.

Pressed-in cast-iron valve guides were used. Valves were nickel-silicon-chromium steel,  $1\frac{1}{2}$ -inch diameter with  $45^\circ$  seat and sodium-cooled stems. The cams provided a maximum valve lift of 0.522 inch, 0.063 inch of which was masked by the recessed seat to give a rapidly opening and closing discharge area. Figure 15 shows the effect of the masking on the time-area diagram. The solid line shows the areas provided with the valves masked and the dotted line

adjust the tappet clearance. Oil is supplied to the wiping arc of the cams by drilled passages through the tappet arms fed from drilled holes in the pins supporting the tappet arms. Means are provided on the vertical drive shaft to permit the adjustment of the exhaust phase through  $30^\circ$  while the engine is running.

Each valve is closed by two concentric helical springs. The combined spring force is 150 pounds with the valve open and 67 pounds with the valve closed.

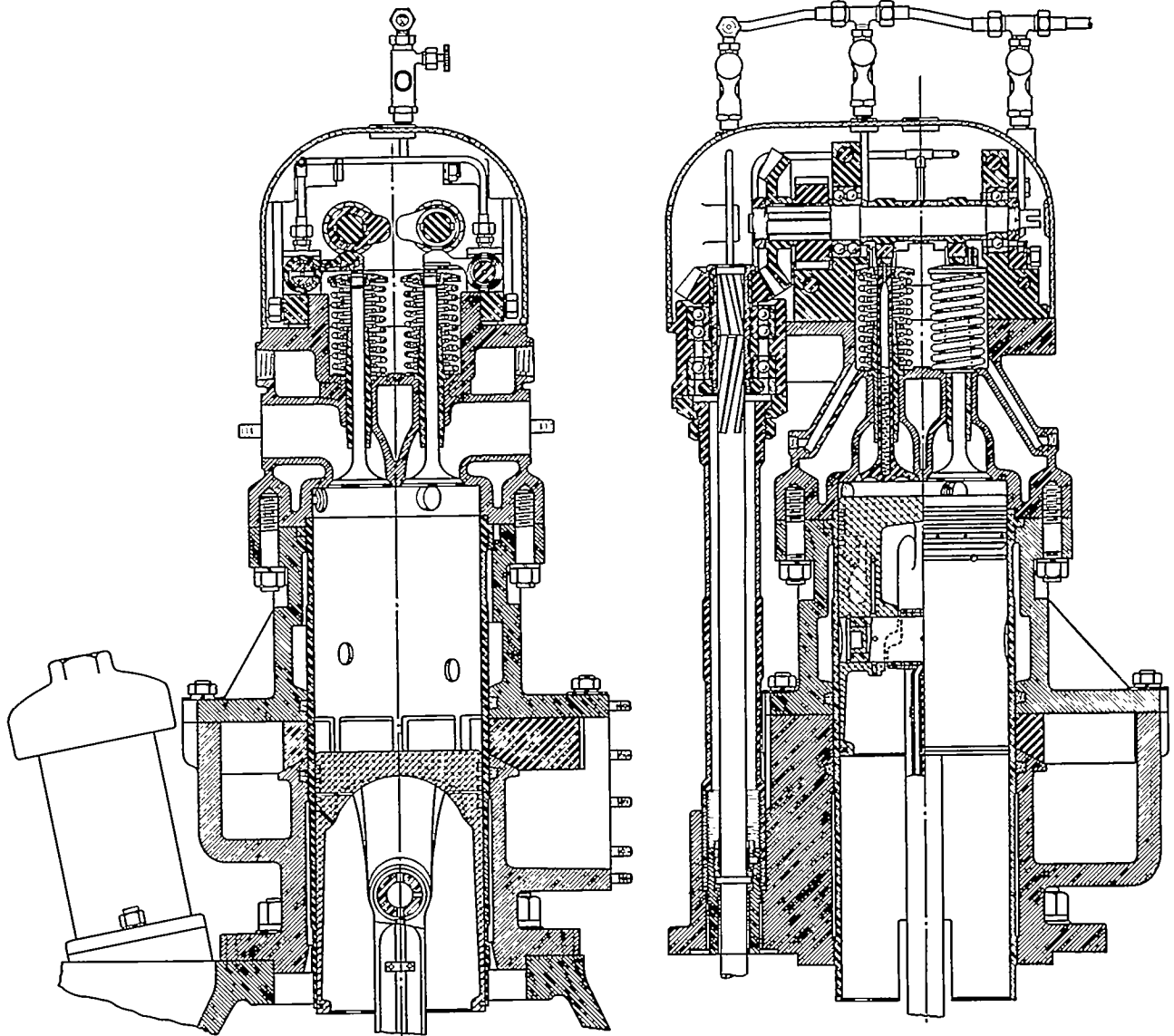

FIGURE 13.—Sectional views of the water-cooled 2-stroke-cycle test engine.

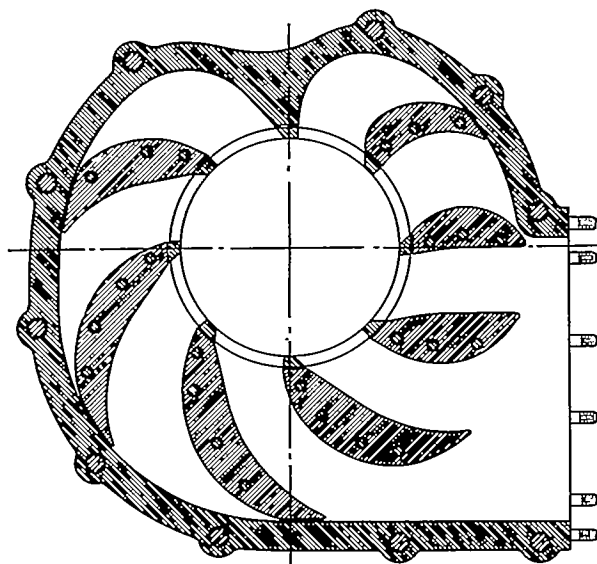

FIGURE 14.—Section through inlet manifold showing guide vanes, viewed from below

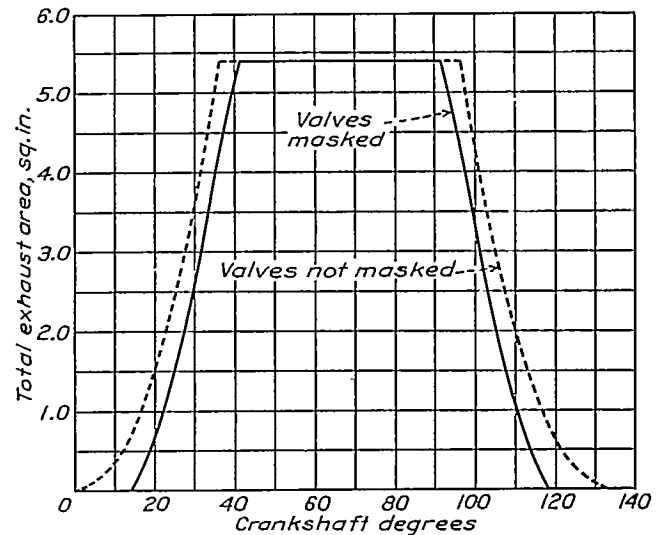

FIGURE 15.—Exhaust area curves showing effect of masked exhaust valves.

Provision is made at the end of one camshaft to drive a modified automobile circuit breaker for spark-ignition tests. The circuit breaker is supported by a bracket screwed to the cylinder head.

A flat-head trunk-type piston of cast Y alloy was used in this engine. The solid skirt was relieved 0.010 inch on the diameter over an arc of 90° on the faces at right angles to the thrust. Other particulars of the skirt, pin bosses, and rings are identical with those of the piston used in the air-cooled test engine, with the exception that the freely floating piston pin is retained by circular wire clips in the piston bosses.

**TESTS AND RESULTS**

**SPARK IGNITION**

Initial tests were conducted on the water-cooled test engine with a cylinder-head spacer installed for

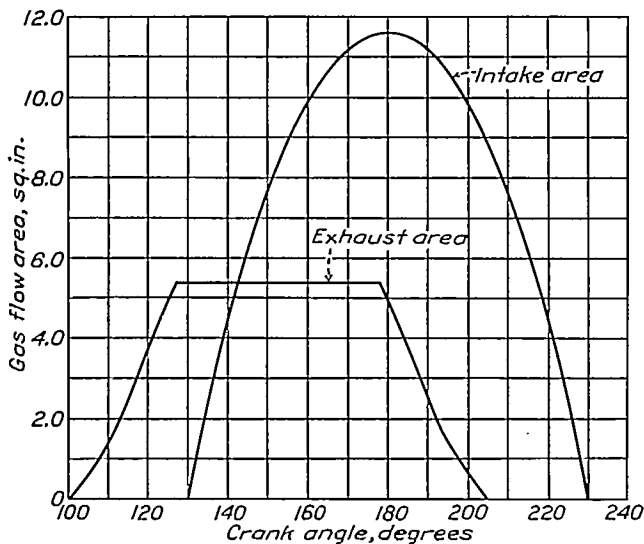

FIGURE 16.—Gas-flow area diagram of the water-cooled test engine.

gasoline injection and spark ignition. The volumetric compression ratio measured 4.9. Fuel was injected by the cam-operated port-control plunger pump through the impinging-jets injection valve. The flat spray of gasoline entered the cylinder at a point about 2¼ inches above the crown of the piston when at its lower center position and was timed as early as possible without loss of fuel through the exhaust valves during the scavenging period. Two diametrically opposed spark plugs in the cylinder head were used. Figure 17 shows the timing diagram with the inlet and exhaust phases in their proper relations.

Preliminary tests showed that after the engine had been brought up to operating temperatures the performance was unaffected by advancing or retarding the spark and that it would continue to operate without change of power when the ignition switches were cut. The source of auto-ignition was traced to glowing exhaust valves, but not before the stems had expanded sufficiently to prevent the valves from seating and caused the cylinder head to crack between the valve

seats due to the resultant thermal stresses. The cylinder head was repaired, tappet clearances increased to

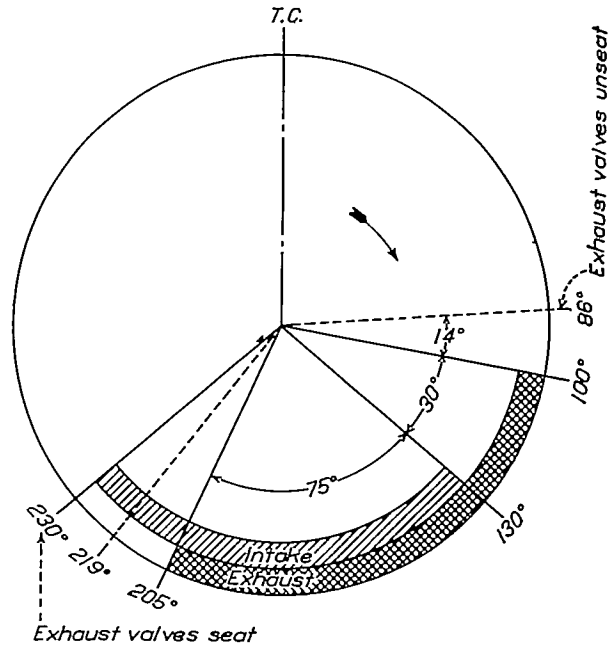

FIGURE 17.—Timing diagram of the water-cooled test engine with gasoline injection and spark ignition.

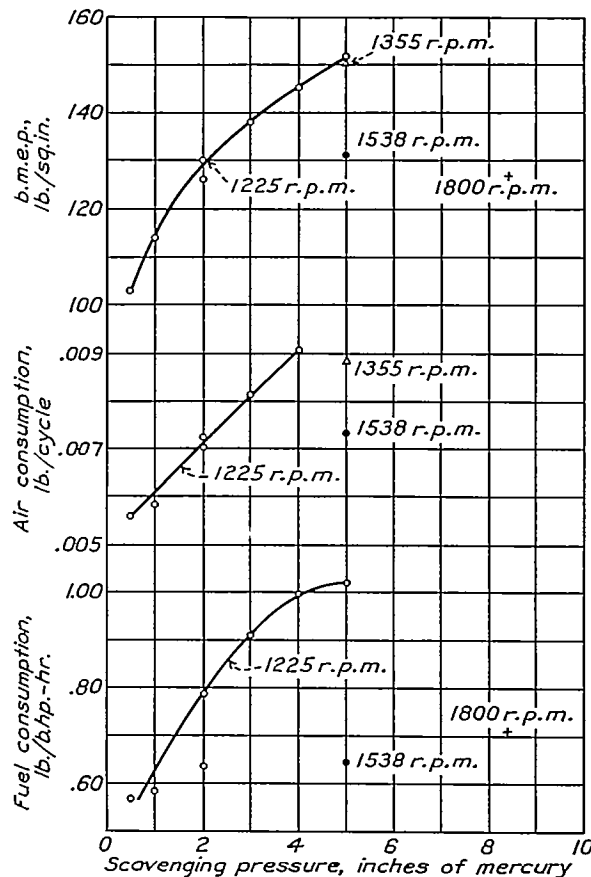

FIGURE 18.—Effect of scavenging pressure on the gross performance of the water-cooled test engine at maximum power with gasoline injection and spark ignition.

0.019 inch, and an electrical indicator devised to measure the clearance at one tappet when operating

under power. Although the condition of auto-ignition persisted, a maximum power-performance check was taken. Figure 18 shows curves of the performance obtained at a constant speed of 1,225 r.p.m. when the scavenging pressure was varied from 1 to 5 inches of mercury, but gives only an approximation of the true performance to be expected from the set-up. The brake mean effective pressure was doubtless lowered by auto-ignition and the fuel consumption is meaningless, as no attempt was made to maintain a constant or economical fuel-air ratio. Previous experiments with the air-cooled cylinder had shown the power to vary comparatively little over a wide range of specific fuel consumptions at the rich end of the mixture range (see fig. 8), and large increases in economy could have been obtained with small decreases in power. Test points were taken at 1,355, 1,538, and 1,800 r.p.m. and are spotted on figure 18. At 1,800 r.p.m. and 8.4 inches of mercury, 69.0 gross brake horsepower was developed, which represents 0.585 horsepower per cubic inch of piston displacement. Considering the preliminary nature of the test and the fact that auto-ignition could not be prevented, the performance indicates the high power per unit of displacement obtainable from this engine if these difficulties can be avoided.

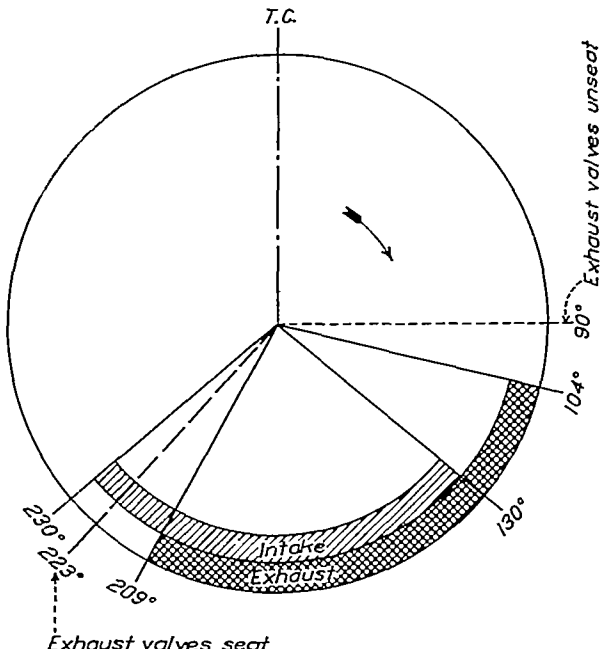

FIGURE 19.—Timing diagram of the water-cooled test engine with compression ignition.

**COMPRESSION IGNITION**

A second failure of the cylinder head between the valve seats, despite the precautions to prevent it, caused the temporary discontinuance of gasoline-injection, spark-ignition tests pending alterations to the design of the cylinder head and the installation of exhaust valves having sodium-cooled heads. As the exhaust valves remained gas-tight and water leakage into the combus-

tion chamber was negligible, preliminary compression-ignition tests were undertaken using the cylinder head cracked during the spark-ignition tests. The other set of inlet-air guide vanes was installed to give an entering angle of 33° to the radial instead of 20° and the cylinder-head spacer removed to increase the compression ratio to 13.3. Inlet port timing and exhaust valve cams were unchanged. The timing diagram is shown in figure 19.

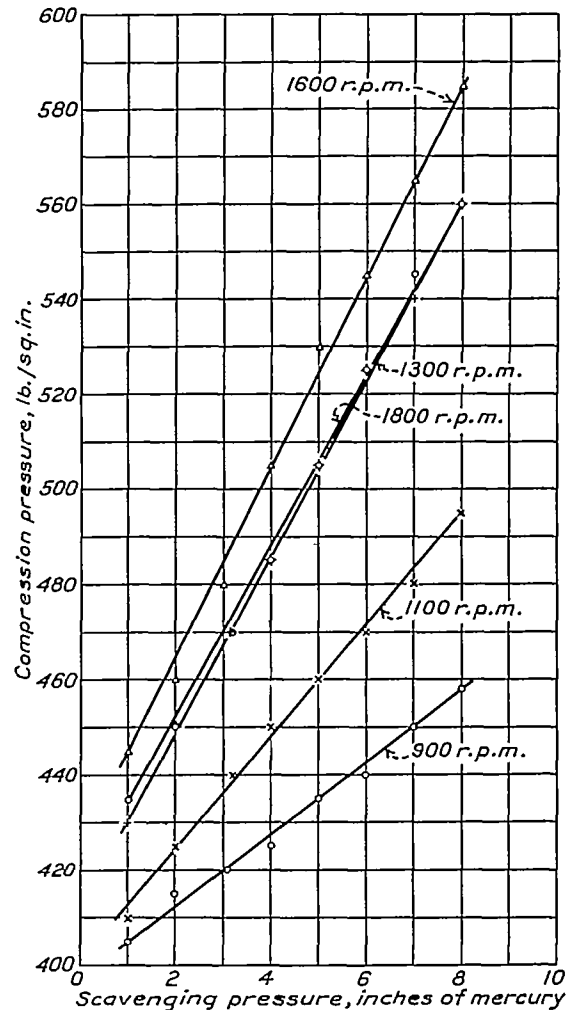

FIGURE 20.—Variation of compression pressure with engine speed and scavenging pressure.

**Preliminary tests.**—Before power tests were conducted the engine was motored at speeds between 900 and 1,800 r.p.m. and compression pressures measured at scavenging pressures from 1 to 8 inches of mercury. Figure 20 shows the compression pressures measured with an electrical balanced-diaphragm indicator. The decrease in compression pressures at 1,800 r.p.m. is interpreted to indicate throttling of the air because of reduced inlet and/or exhaust time-areas. The pressures developed on the compression stroke with the engine under power may differ considerably from those measured with the engine motored, because of the

large difference in air consumption under the two conditions, which will be shown later.

The impinging-jets injection valve was then installed in the cylinder head to inject a flat spray across the combustion chamber, and power tests were undertaken. The engine started readily and ran smoothly but the output and economy were poor with excessive smoke and yellow flame present in the exhaust, indicative of quite incomplete burning of the fuel. Examination of the markings on the piston crown showed insufficient penetration of the fuel into the combustion chamber. The injection valve was accordingly replaced by one with a multiple-orifice nozzle, F-29. (See reference 6.) The better distribution obtained from this nozzle improved the engine performance over 30 percent, and indicated that the penetration and

distribution obtained with a multiple-orifice nozzle would be necessary for optimum performance with this combustion chamber and its conditions of air flow.

Valve-nozzle investigation.—An investigation was undertaken to determine the required number, size, and arrangement of orifices to give maximum performance. Several nozzles described in reference 6 were first tried, both singly and in pairs; in the latter case, two valves diametrically opposed in the same plane injected across the combustion chamber. Engine speed and scavenging pressure were held constant for these tests at 1,250 r.p.m. and 1 inch of mercury, respectively. Special fuel-valve nozzles were then designed and built and the size and number of orifices varied systematically until the arrangement giving optimum engine performance was determined.

TABLE I.—NOZZLE CHARACTERISTICS AND CORRESPONDING ENGINE PERFORMANCE. ENGINE SPEED, 1,250 R.P.M.; SCAVENGING PRESSURE, 1 INCH OF MERCURY











Orifice arrangement	Nozzle designation	Total orifice area, sq. in.	Orifice diameter, in.	Percentage total orifice area	B.m.e.p., lb./sq. in.	
					Fuel consumption = 0.45 lb./b.hp./hr.	Fuel consumption = 0.50 lb./b.hp./hr.
	K-4.....	0.000975	A=.019 B=.014 C=.008	A=29.1 B=15.8 C= 5.2	101.0	106.5
	No. 9.....	.000687	A=.007 B=.018 C=.005 D=.008	A= 5.6 B=37.1 C= 2.9 D= 7.3	98.5	112.0
	F.....	.0007352	A=.018 B=.012	A=34.6 B=15.4	98.1	109.0
	R-1.....	.0006094	A=.016 B=.014 C=.008	A=33.0 B=25.3 C= 8.3	93.8	103.0
	R-1-I.....	.0006895	A=.018 B=.014 C=.009	A=36.9 B=22.3 C= 9.2	110.0	113.0
	R-1-II.....	.0007833	A=.018 B=.016 C=.008	A=32.5 B=25.6 C= 8.5	106.0	110.1
	R-1-III.....	.0008723	A=.020 B=.016 C=.010	A=36.0 B=23.0 C= 9.0	110.0	113.0
	R-1-IV.....	.0009252	A=.020 B=.017 C=.010	A=34.0 B=24.6 C= 8.5	104.7	109.2
	R-1-V.....	.0009944	A=.020 B=.017 C=.012	A=31.6 B=22.8 C=11.4	109.8	113.3
	R-1-IV B's closed.....	.0004712	A=.020 C=.010	A=66.7 C=16.7	110.6	118.5

TABLE I.—NOZZLE CHARACTERISTICS AND CORRESPONDING ENGINE PERFORMANCE. ENGINE SPEED, 1,250 R.P.M.; SCAVENGING PRESSURE, 1 INCH OF MERCURY—Continued













Orifice arrangement	Nozzle designation	Total orifice area, sq. in.	Orifice diameter, in.	Percentage total orifice area	B.m.e.p., lb./sq. in.	
					Fuel consumption = 0.45 lb./b.hp./hr.	Fuel consumption = 0.50 lb./b.hp./hr.
	R-1-V B's closed.....	.0005404	A = .020 C = .012	A = 58.2 C = 20.9	101.0	111.2
	R-1 one C closed.....	.0005593	A = .016 B = .014 C = .008	A = 36.0 B = 27.5 C = 9.0	93.9	97.0
	R-2.....	.000575	A = .014 B = .011 C = .007	A = 26.8 B = 16.5 C = 6.7	-----	-----
	R-2-I.....	.0006693	A = .016 B = .011 C = .007	A = 30.1 B = 14.2 C = 5.8	83.7	93.7
	R-2-II.....	.0006928	A = .016 B = .011 C = .008	A = 29.0 B = 13.7 C = 7.3	-----	92.6
	R-2-III.....	.0008032	A = .018 B = .011 C = .008	A = 31.7 B = 11.8 C = 6.3	-----	93.3
	R-2 one C closed.....	.0005364	A = .014 B = .011 C = .007	A = 28.6 B = 17.7 C = 7.2	79.4	84.5
	R-2-I B's closed.....	.0004492	A = .016 C = .007	A = 44.8 C = 8.6	101.2	113.2
	R-2-II B's closed.....	.0005027	A = .016 C = .008	A = 40.0 C = 10.0	100.4	115.0
	R-1 one C closed and.....	.0005592	A = .016 B = .014 C = .008	-----	105.0	114.5
	R-2 one C closed.....	.0005364	A = .014 B = .011 C = .007	-----		
	R-1.....	.0006094	A = .016 B = .014 C = .008	-----	105.0	114.4
	and R-2.....	.000575	A = .014 B = .011 C = .007	-----		

Table I lists some of the nozzles tested in this investigation, giving the proportionalities of total orifice area and the gross brake mean effective pressure obtained with the engine at specific fuel consumptions of 0.45 and 0.50 pound per brake horsepower-hour. The no. 9, K-4, and F nozzles were tested without alterations. The R-1 and R-2 series show how the orifices

of a 5- and 6-orifice nozzle, respectively, were varied. Two examples are given of nozzles tested in pairs.

The nozzle finally adopted had a central 0.020-inch orifice and two 0.010-inch orifices at an angle of 60°, all in the same plane, and was the simplest combination of orifices giving performance equal to any other orifice combination tested. Figure 21 shows the engine

performance obtained with this nozzle over a range of fuel quantities when the maximum cylinder pressure was limited to 1,000 pounds per square inch. At 0.50 pound per brake horsepower-hour fuel consumption, the gross brake mean effective pressure obtained was 115 pounds per square inch. At the better economy of 0.45 pound per brake horsepower-hour, 105 pounds per square inch brake mean effective pressure was obtained.

**Effect of scavenging pressure.**—With the speed and maximum cylinder pressure held constant, the effect of increasing the scavenging pressure was investigated. Figure 22 shows the performance obtained up to and including 6 inches of mercury scavenging pressure at a constant fuel consumption of 0.50 pound per brake horsepower-hour. It will be seen that the power increased uniformly with increasing scavenging pressure. Above 6 inches of mercury scavenging pressure

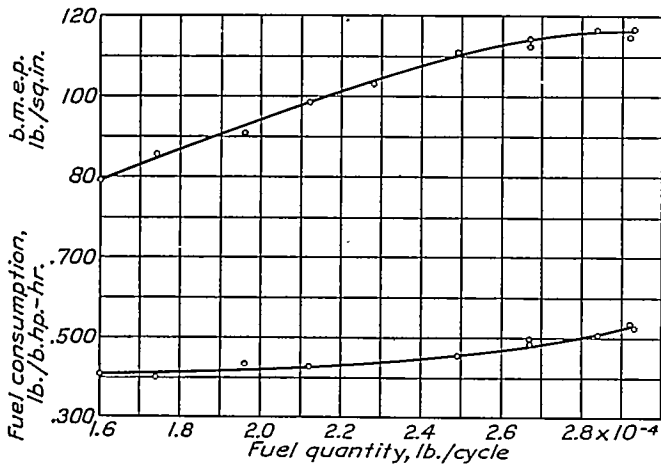

FIGURE 21.—Effect of fuel quantity on gross engine performance. Engine speed, 1,250 r.p.m.; scavenging pressure, 1 inch of mercury; maximum cylinder pressure, 1,000 pounds per square inch.

the fuel quantity required exceeded the capacity of the injection pump and resulted in inefficient combustion owing to a protracted injection period. However, the torque limit of the dynamometer was reached when the engine developed 167 pounds per square inch gross brake mean effective pressure at 8 inches of mercury scavenging pressure at the expense of increased fuel consumption.

**Effect of engine speed.**—The effect of engine speed on performance was determined for a constant scavenging pressure of 1 inch of mercury and a constant gross fuel consumption of 0.50 pound per brake horsepower-hour. The results are shown in figure 23. The shapes of the curves of power and mean effective pressure above 1,100 r.p.m. are similar to that of the air-consumption curve which is a characteristic of the present scavenging system. Tests have shown the exhaust-pipe length to be an important factor in determining

the charging capacity and therefore the power output of the cylinder, although sufficient data have not yet been accumulated to show the exact relationship. The length of the exhaust pipes used in these tests was 43 inches.

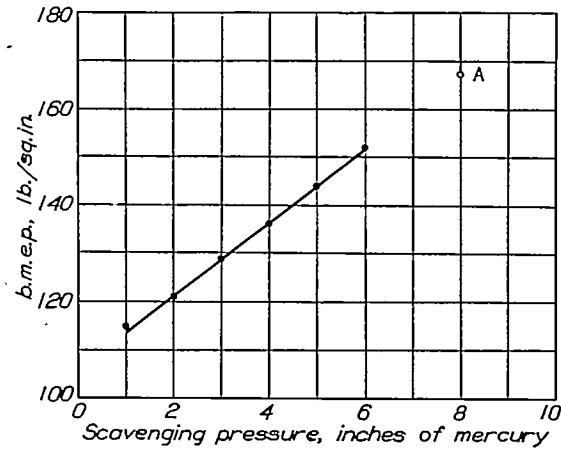

FIGURE 22.—Effect of scavenging pressure on gross engine performance. Engine speed, 1,230 r.p.m.; maximum cylinder pressure, 1,000 pounds per square inch; fuel consumption, 0.50 pound per brake horsepower-hour. A, fuel consumption not measured at this point.

**Variation of air consumption.**—Tests conducted at scavenging pressures of 1 to 4 inches of mercury showed the air consumed under power to be from 2 to 6 times that used when motoring, the greatest difference oc-

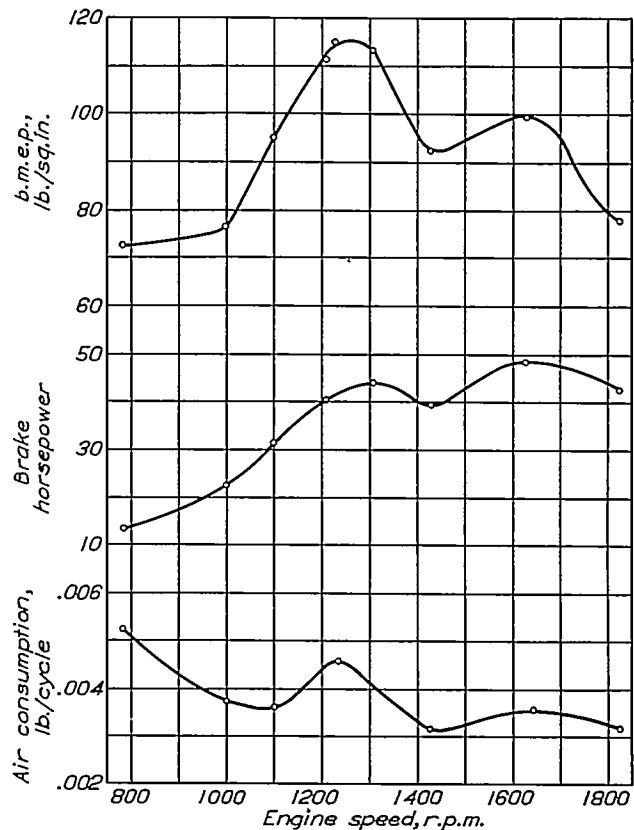

FIGURE 23.—Effect of speed on gross engine performance. Scavenging pressure 1 inch of mercury; maximum cylinder pressure, 1,000 pounds per square inch; fuel consumption, 0.50 pound per brake horse power-hour.

curing at the lowest scavenging pressure and the least difference at the high scavenging pressures. However, the air consumed under power was found to vary but slightly with engine load, as is shown in figure 24.

Figure 25 shows the variation in specific air consumption for various scavenging pressures at a constant

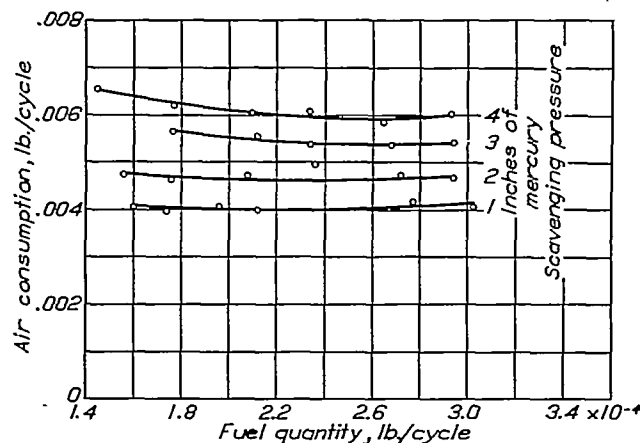

FIGURE 24.—Effect of fuel quantity on air consumption at various scavenging pressures. Engine speed, 1,270 r.p.m.

engine speed and constant specific fuel consumption. The increase in specific air consumption at increasing scavenging pressures is indicative of the increased air passed through the cylinder during the scavenging period.

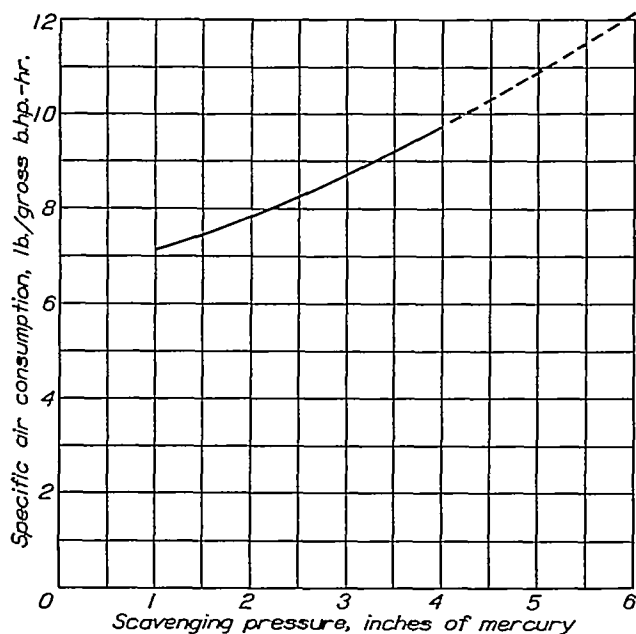

FIGURE 25.—Effect of scavenging pressure on specific air consumption. Engine speed, 1,270 r.p.m.; specific fuel consumption, 0.50 pound per brake horsepower-hour.

**Exhaust inertia.**—Further evidence of the existence of inertia scavenging and charging effects was given by continued running of the engine when the inlet manifold was opened to atmospheric pressure. The power output was obviously quite low, but it was possible to accelerate the engine to the highest allowable speed of 2,000 r.p.m. with only atmospheric pressure at the intake ports.

**Correction for power lost to scavenging blower.**—Plotted performance of all tests represents gross output and fuel consumption, uncorrected for power absorbed by the blower. Figure 26 shows the power loss

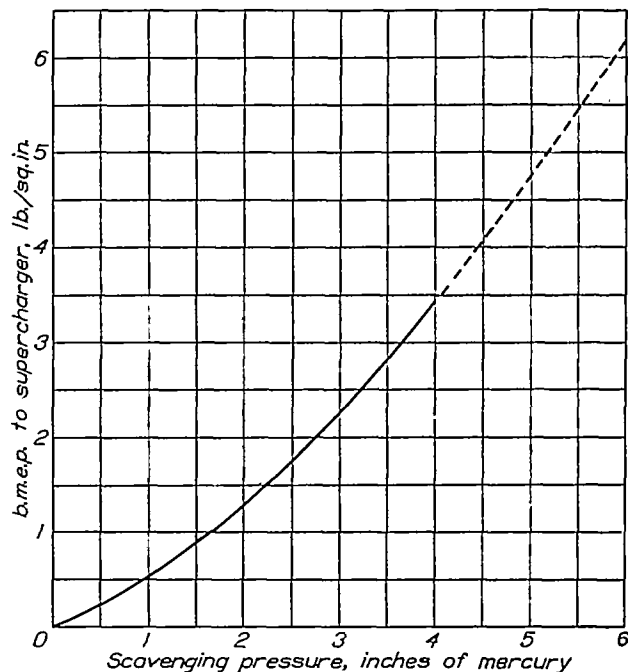

FIGURE 26.—Effect of scavenging pressure on engine mean effective pressure required to drive the scavenging blower. Engine speed, 1,270 r.p.m.

to the blower at an engine speed of 1,270 r.p.m. for pressures from 0 to 6 inches of mercury in terms of engine brake mean effective pressure. Net outputs may be obtained by applying the correction obtained from figure 26 to the gross outputs.

**Idling characteristics.**—Idling tests conducted with the same fuel pump and automatic injection valve showed the minimum steady idling speed to be 350 r.p.m. With a different injection system, a minimum idling speed of 150 r.p.m. was obtained with consistent firing. In order to obtain this low speed the fuel quantity was reduced to a low value and then the air to the manifold was progressively throttled to about 0.1 inch of mercury. After the engine had slowed down to 150 r.p.m., however, increasing the air pressure had no effect on the speed.

**Remarks.**—The severity of combustion shock cannot be definitely evaluated. Observers agreed, however, that the combustion shock in this engine was less evident than in either an unsupercharged quiescent or prechamber 4-stroke-cycle compression-ignition engine. Indicator cards showed successive cycles to be as regular as those of a 4-stroke-cycle engine.

Although complete friction data were not recorded, the friction mean effective pressure at 1,200 r.p.m. and 1 inch of mercury inlet pressure was found to be 45 percent less than that of a similar 4-stroke-cycle, compression-ignition engine. With increasing inlet pressure, the friction advantage of the 2-stroke-cycle engine decreases.



The exhaust valves that caused discontinuance of spark-ignition tests because of pre-ignition resulting from their high temperatures were used throughout the compression-ignition tests, demonstrating an important advantage of compression ignition for 2-stroke-cycle operation.

Trouble was encountered with repeated sticking of the piston rings in the top groove, although the piston showed no evidence of overheating. No improvement was effected by replacing the original installation of two 1/8-inch rings with a single 1/4-inch ring or by changing from castor oil to mineral oil for engine lubrication.

Frequent inspections during more than 100 hours of engine operation under various conditions of speed and load showed that the steel-backed babbitt bearing in the connecting rod big end and the bronze bearing in the connecting rod small end were operating quite satisfactorily. The piston pin bearing in the Y alloy piston bosses was also satisfactory.

#### CONCLUSIONS

From the preliminary tests conducted with the 2-stroke-cycle spark-ignition, fuel-injection engine it is concluded that:

1. With the port-inlet and poppet-exhaust valve arrangement, this type of engine will develop 0.585 gross horsepower per cubic inch of piston displacement. Test results indicate the probability of slightly inferior fuel economy with the 2-stroke-cycle engine as compared with the 4-stroke-cycle engine.

2. Satisfactory operation at high specific outputs with gasoline injection and spark ignition depends upon successfully cooling the exhaust valves, the valves being subjected to much greater thermal stresses than those of 4-stroke-cycle engines. The requirements of valve cooling with compression ignition are apparently less severe.

3. At low scavenging pressures the scavenging and charging of the cylinder are greatly affected by the inertia of the exhaust gas and length of the exhaust pipe.

The tests conducted with the 2-stroke-cycle compression-ignition engine show that:

4. With the orderly air swirl induced by the inlet-air-guide vanes, a 3-orifice nozzle injecting across the combustion chamber gives power and economy equal to that obtained with any other number and arrangement of orifices tested in a single nozzle; two injection valves connected to the same fuel pump give no better performance.

5. Other conditions remaining constant, the gross power output increases with increasing inlet-air pressure up to a pressure of 6 inches of mercury, the increase in power being directly proportional to the increase in the scavenging pressure.

6. Satisfactory idling can be obtained with regular firing at low inlet-air pressures.

7. Power varies irregularly with speed at low scavenging pressures and indicates an inertia charging effect that requires further investigation.

NATIONAL ADVISORY COMMITTEE FOR AERONAUTICS,  
 LANGLEY MEMORIAL AERONAUTICAL LABORATORY,  
 LANGLEY FIELD, VA., *May 14, 1934.*

#### REFERENCES

1. Kurtz, Oskar: Knowledge Gained from Practical Experience in the Designing of Aircraft Engines. T.M. No. 706, N.A.C.A., 1933.
2. Caunter, C. F.: The Two-Cycle Engine. Sir Isaac Pitman & Sons, Ltd., London, 1932.
3. Paton, C. R., and Kemper, Carlton: Power Output and Air Requirements of a Two-Stroke-Cycle Engine for Aeronautical Use. T.R. No. 239, N.A.C.A., 1926.
4. Ware, Marsden: Description of the N.A.C.A. Universal Test Engine and Some Test Results. T.R. No. 250, N.A.C.A., 1927.
5. Spanogle, J. A., and Hemmeter, G. T.: Development of an Impinging-Jet Fuel-Injection Valve Nozzle. T.N. No. 372, N.A.C.A., 1931.
6. Spanogle, J. A., and Foster, H. H.: Basic Requirements of Fuel-Injection Nozzles for Quiescent Combustion Chambers. T.N. No. 382, N.A.C.A., 1931.