

REPORT No. 506

TESTS OF NACELLE-PROPELLER COMBINATIONS IN VARIOUS POSITIONS WITH REFERENCE TO WINGS V—CLARK Y BIPLANE CELLULE—N.A.C.A. COWLED NACELLE—TRACTOR PROPELLER

By E. FLOYD VALENTINE

SUMMARY

This report is the fifth of a series giving the results obtained in the N.A.C.A. 20-foot wind tunnel on the interference drag and propulsive efficiency of nacelle-propeller-wing combinations. The first report gave the results of the tests of an N.A.C.A. cowled air-cooled engine nacelle with tractor propeller located in 21 positions with reference to a thick monoplane wing. The second and third reports gave the results with several engine cowlings and nacelles with tractor propeller located in four positions with reference to the thick wing and a Clark Y wing, respectively. Results with several engine cowlings with tandem nacelle arrangements in various positions with reference to the thick wing were given in the fourth report. The present report gives results of tests of an N.A.C.A. cowled air-cooled engine nacelle with tractor propeller located in 12 positions with reference to a Clark Y biplane cellule.

The biplane cellule consisted of two wings of Clark Y section with a 38-inch chord and a 15-foot 10-inch span. It had a gap of 3 feet and no stagger or decalage. The engine, which was a 4/9-scale model of a Wright J-5 radial air-cooled engine, was installed in an N.A.C.A. cowled nacelle. A 4-foot model of a Navy no. 4412 adjustable metal propeller was used.

The lift, drag, and propulsive efficiency were determined at several angles of attack in each nacelle position. The net efficiency was computed by the method of the first report. The results are compared with those for a monoplane wing of the same section and chord given in the third report.

The best results were obtained with the propeller, 50 percent of the chord directly ahead of the upper wing. The same position relative to the lower wing is nearly as good. Positions about half-way between the two wings with the propeller near the leading edges are the poorest. There is a fair agreement between the results with biplane combinations and those for similar monoplane combinations.

INTRODUCTION

This report is the fifth of a series giving the results of a general investigation of the mutual effects of wings, nacelles, and propellers. The program includes tests of nacelles with tractor, pusher, and tandem propellers in combination with monoplane and biplane wings.

The first report (reference 1) gave the results obtained with an N.A.C.A. cowled air-cooled-engine nacelle with a tractor propeller located in 21 positions with reference to a thick wing. The second and third reports gave the results for several engine cowlings and nacelles with tractor propeller located in four positions with reference to a thick wing (reference 2) and to a Clark Y wing (reference 3). In the fourth report (reference 4) results are given for various engine cowlings with tandem nacelle arrangements in several positions with respect to a thick wing.

This report gives the results for an N.A.C.A. cowled nacelle with tractor propeller in 12 positions with reference to a biplane cellule. The manner of presenting the results is similar to that used in the previous reports. Sufficient information is given in the tables to permit the reader to reduce the results by other methods if desired.

APPARATUS AND METHODS

The propeller-research tunnel in which the tests were made is described in reference 5. The cellule consisted of two wooden airfoils of Clark Y section with a 38-inch chord, a 15-foot 10-inch span, a gap of 36 inches, but no stagger or decalage. Conventional N-struts of streamline steel tubing, together with streamline lift wires, were used between the wings.

A 4/9-scale model of a Wright J-5 radial air-cooled engine was mounted in an N.A.C.A. cowled nacelle of the same scale. Figure 1 shows the dimensions of the nacelle. The propeller used was a 4-foot diameter model, geometrically similar to the Navy no. 4412 9-foot adjustable propeller. For these tests the blades

were set 17° at $0.75 R$. A 25-horsepower 220-volt direct-current motor was mounted inside the nacelle and the propeller mounted directly on its shaft. Wires from the motor were led down the nacelle-supporting struts into the wing and from the wing down the sup-

porting struts to the control equipment. Figures 4 and 5 are photographs showing the details of each combination. In all cases the thrust line was parallel to the chord.

Previous tests (reference 1) showed that it was advantageous to fair the nacelle into the wing when the

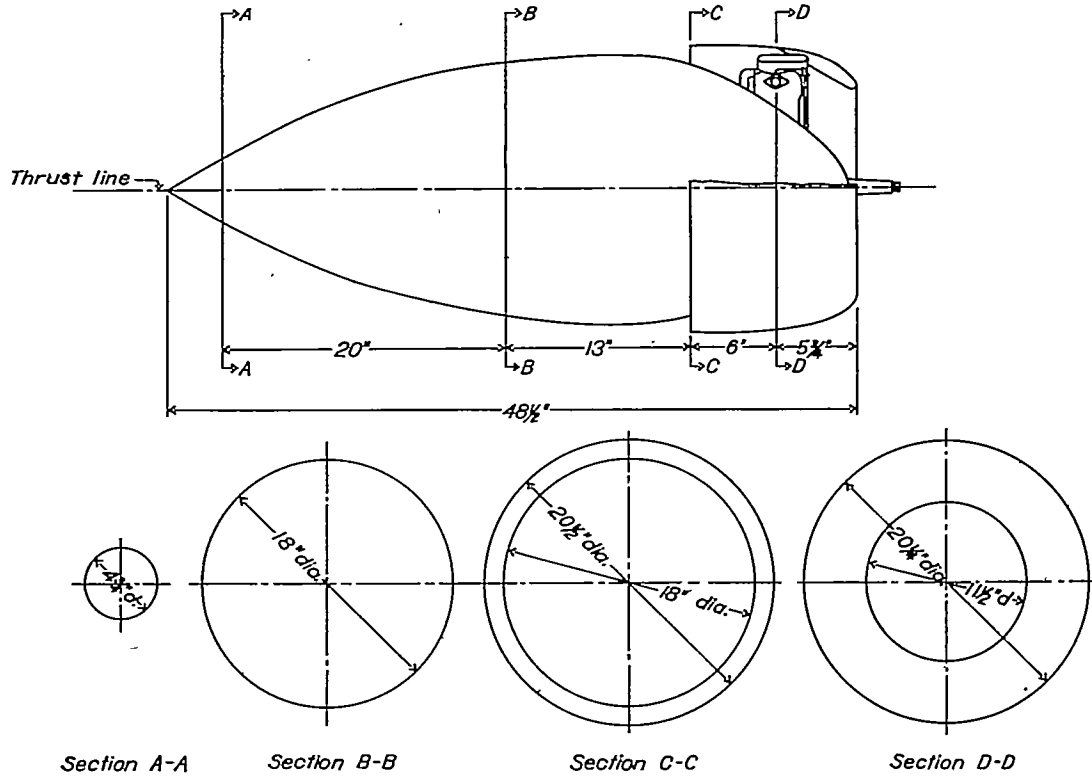

FIGURE 1.—N.A.C.A. cowled nacelle and engine assembly.

porting struts to the control equipment. The motor was calibrated with a Prony brake. Curves of armature current against torque were obtained for several values of the field current. The revolution speed was indicated by a condenser-type tachometer which was connected by wires to an indicating instrument at the controls below.

The test set-up, mounted as described in reference 6, was pivoted about the 25-percent chord point of the lower wing. Figure 2 shows a combination mounted for testing.

All the tests of this investigation were made at Reynolds Numbers varying from 1,360,000 at the lowest speed (50 m.p.h.) to 2,750,000 at the highest speed (100 m.p.h.). The biplane cellule alone was tested at several angles of attack ranging from -5° to 23° . When the cellule was tested without the nacelle it was braced at the midspan by N-struts. Tare-drag tests were made with the biplane cellule supported independently of the balance system. Tests had already been made on the nacelle alone; the results are given in reference 7.

Figure 3 shows the relative location of the nacelle with respect to the cellule in the 12 positions tested.

two were close together. Consequently, in positions 4, 5, 7, and 8 the nacelle was faired into the wing.

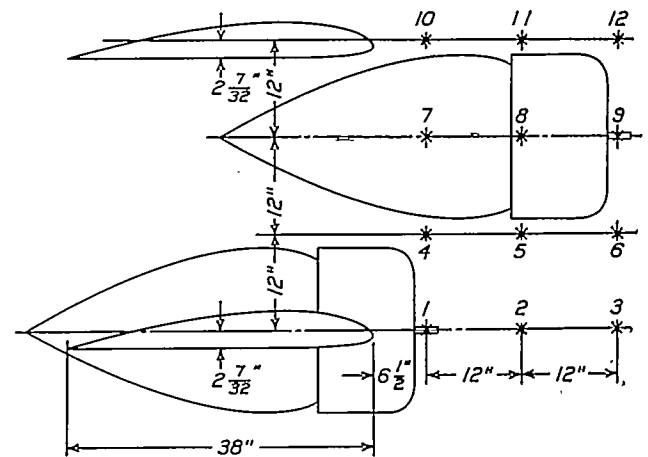

FIGURE 3.—Biplane-nacelle test locations.

Each combination was first tested without the propeller and tests were then made with the propeller operating. These tests were made at angles of attack of -5° , 0° , 5° , 10° , and 15° .

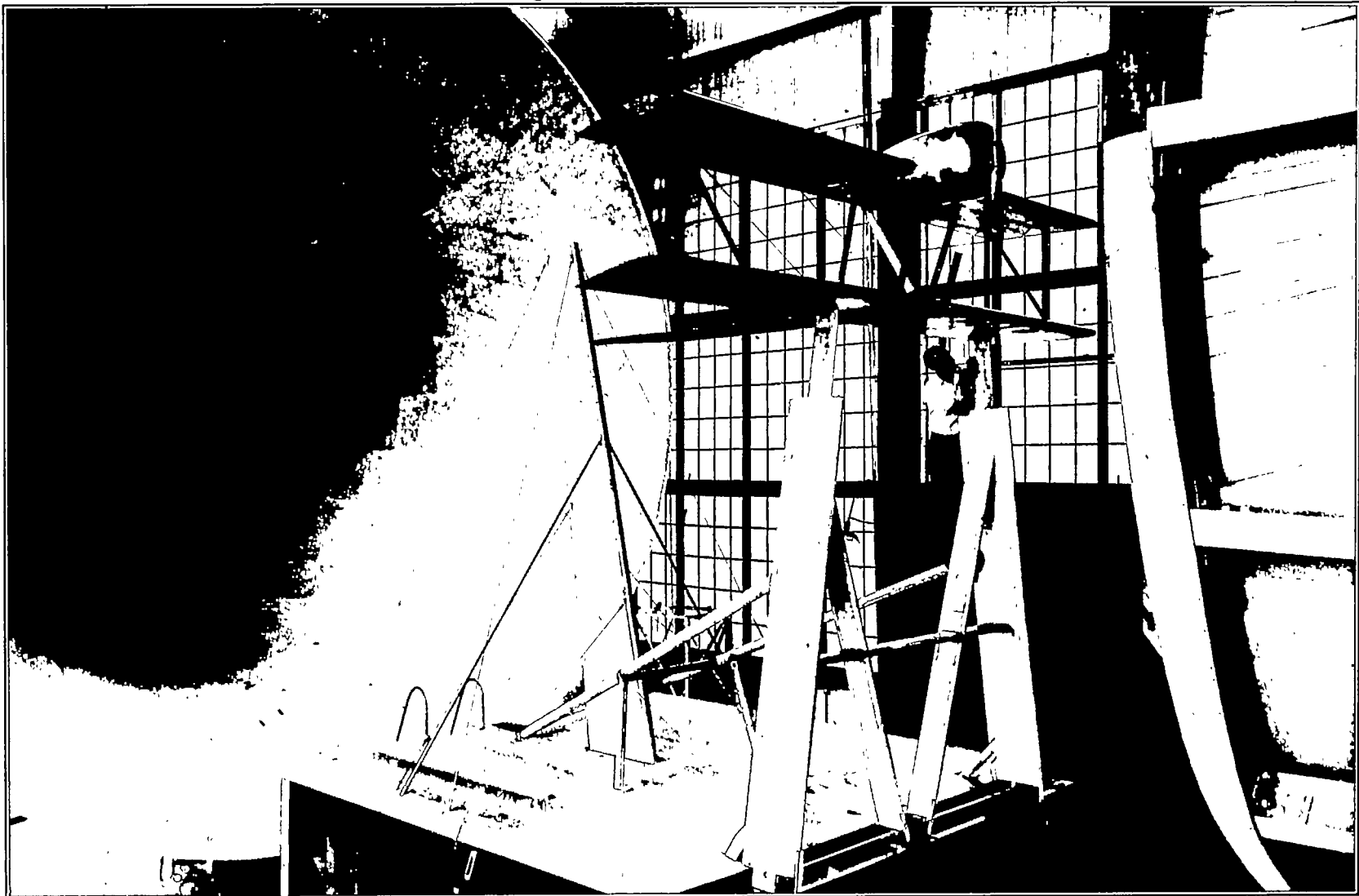

FIGURE 2.—Biplane cellule with nacelle in position 11 mounted for test.

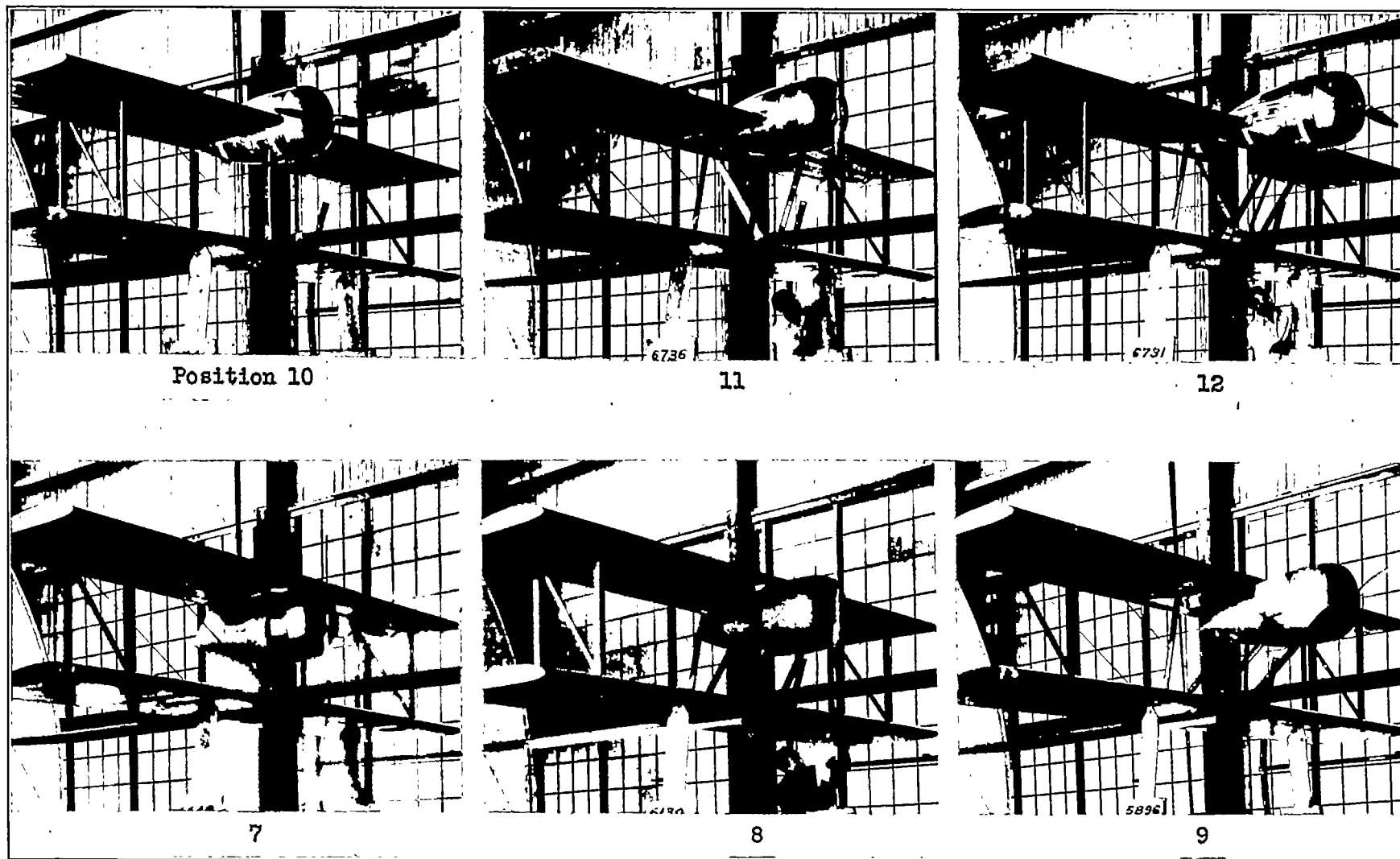

FIGURE 4.—Biplane-nacelle combinations with nacelle near upper wing.

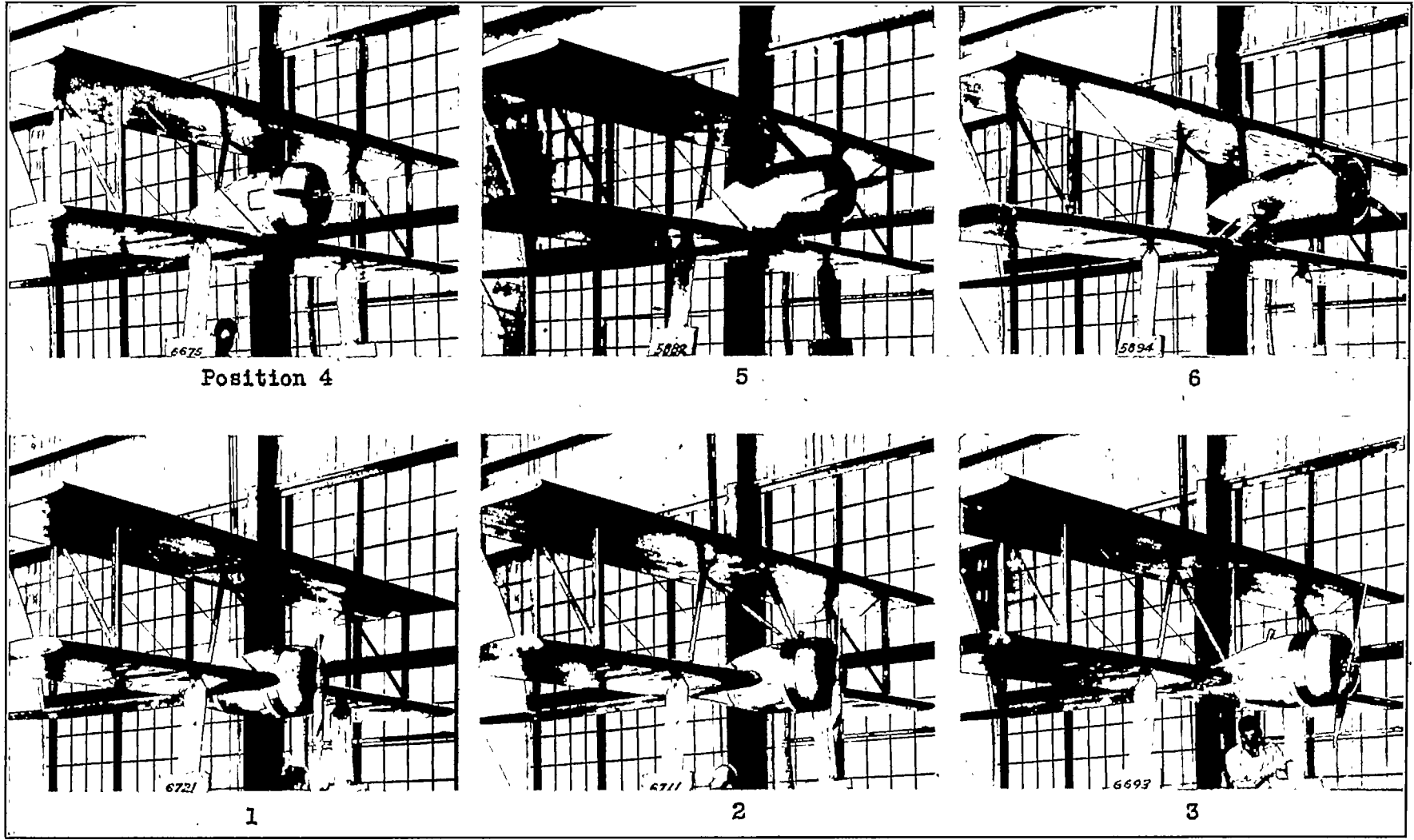

FIGURE 5.—Biplane-nacelle combinations with nacelle near lower wing.

RESULTS

The measurements with the propeller removed were reduced to the usual coefficients

$$C_L = \frac{\text{lift}}{qS} \quad C_D = \frac{\text{drag}}{qS} \quad C_m = \frac{\text{moment}}{qSc}$$

where

- q , dynamic pressure ($\frac{1}{2}\rho V^2$).
- ρ , mass density of air.
- V , velocity.
- S , area of wing.
- c , chord of wing.

The moments were taken about the geometric mean quarter-chord point. The preceding coefficients for each angle of attack were plotted against dynamic pressure and faired values from these curves were then cross-plotted against angle of attack at 50, 75, and 100 miles per hour. Values from these faired curves are given in the tables. Values of C_L and C_D are given in tables I and II, respectively. Table III gives the moment coefficients at 100 miles per hour only, as there was no observable scale effect on the moments.

The final results are not affected by the fact that jet-boundary corrections were not applied, since all drag differences are taken at equal values of lift.

The usual coefficients are used for presenting the results with the propeller operating:

$$C_T = \frac{T - \Delta D}{\rho n^2 D^4} \quad C_P = \frac{P}{\rho n^3 D^5}$$

where

T , thrust of propeller operating in front of a body (tension in crankshaft).

ΔD , change in drag of body due to action of propeller.

$T - \Delta D$, effective thrust (reference 3).

n , revolutions per unit of time.

D , propeller diameter.

P , motor power.

and

η = propulsive efficiency.

$$= \frac{\text{effective thrust} \times \text{velocity of advance}}{\text{motor power}}$$

$$= \frac{(T - \Delta D)V}{P} = \frac{C_T V}{C_P nD}$$

Lift and moment coefficients were obtained in the same manner as with the propeller removed, but are designated C_{LP} and C_{mP} . Coefficients read from faired curves at different values of V/nD are given in the tables for several angles of attack as follows: Table IV, Thrust Coefficient (C_T); Table V, Power Coefficient (C_P); Table VI, Propulsive Efficiency (η); Table VII, Lift Coefficient with Propeller Operating (C_{LP}); Table VIII, Moment Coefficient with Propeller Operating (C_{mP}). A typical example of the propeller curves may be found in reference 1.

ACCURACY

The scales and instruments were calibrated frequently during the period over which the tests were run. The angle of attack was set to within 5' by means of an inclinometer. The scattering of the points in the motor calibration indicated a maximum error of 1 percent. The tachometer readings were correct to within 10 revolutions per minute. Lift and drag balances were read to the nearest pound. At high angles of attack in some cases the fluctuation of forces was such that the above accuracy could not be maintained.

DISCUSSION

When considering the relative merits of wing-nacelle-propeller arrangements it is necessary to take several factors into account. The lift and drag of the wing, or cellule, are affected by the presence of the nacelle. Similarly, the characteristics of the nacelle are changed due to the presence of the wing. Not only does the propeller affect the lift and drag of the wing-nacelle combination, but its efficiency in turn depends on the arrangement of bodies in its slipstream. All these factors are, of course, functions of the conditions under which the combination is operating.

A method of comparing one arrangement with another is developed in reference 1, and the following formulas result:

$$\text{Propulsive efficiency} = \eta = \frac{(T - \Delta D)V}{P} = \frac{C_T V}{C_P nD}$$

Nacelle drag efficiency factor

$$= \frac{C_{DC} - C_{DW}}{C_P} \frac{S}{2D^2} \left(\frac{V}{nD}\right)^3$$

$$\text{Net efficiency} = \frac{C_T V}{C_P nD} - \frac{C_{DC} - C_{DW}}{C_P} \frac{S}{2D^2} \left(\frac{V}{nD}\right)^3$$

where C_{DW} , drag coefficient of the wing at a given angle of attack.

C_{DC} , drag coefficient of the wing-nacelle combination (propeller removed) at the angle of attack at which the lift coefficient with the propeller operating is the same as the lift coefficient of the wing alone at the given angle of attack.¹

These formulas are applied to two conditions: One for high speed and cruising with a propeller $V/nD = 0.65$ and a lift coefficient corresponding to that of the cellule alone at an angle of attack of 0° ($C_L = 0.259$), and one for climbing with a $V/nD = 0.42$ and a lift coefficient corresponding to that of the cellule alone at an angle of attack of 5° ($C_L = 0.480$). The V/nD

¹ This definition of C_{DC} has the same meaning as that in references 1 to 4. The present wording is used to clear up confusion that has arisen from the previous simplified definition.

selected for the high-speed comparison is that at which the propeller operated at greatest efficiency in the

that the engine delivers its power at a constant torque. A diagram of the method of obtaining the drag value used in computing the nacelle drag efficiency factor is given in reference 3. The net efficiency, as defined, is equal to the efficiency that would be obtained by considering the difference between the drag of a wing-nacelle-propeller combination and the drag of the wing alone, at equal lift coefficients, as part of the drag chargeable to the propulsive unit, in the same way that ΔD is ordinarily charged to the propeller. A proper comparison of two combinations can only be made at equal values of lift.

At an angle of attack of 0° with the propeller operating the lift was increased, except with the nacelle in positions 1, 7, 8, and 9. The greatest increase in lift

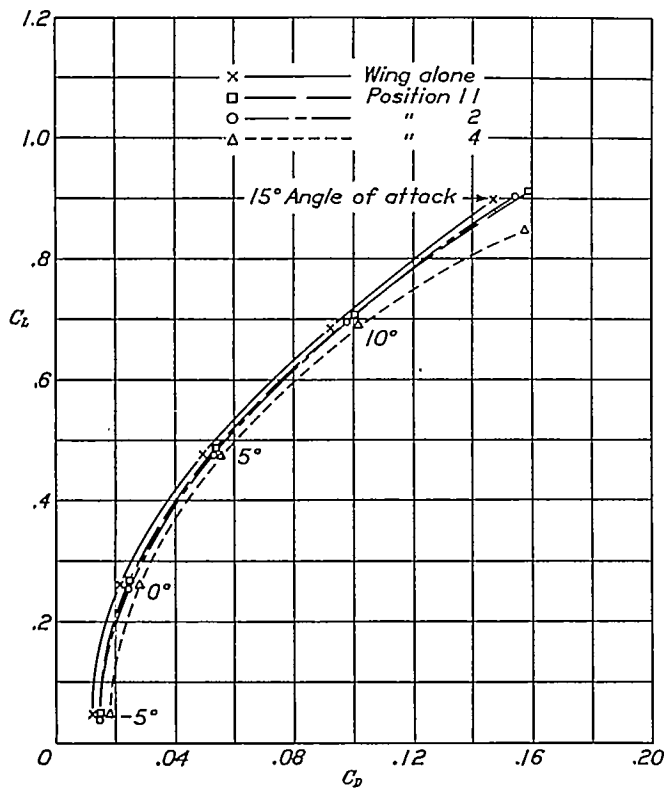

FIGURE 6.—Comparison of lift and drag characteristics of the biplane cellule alone and with the nacelle in positions 2, 4, and 11.

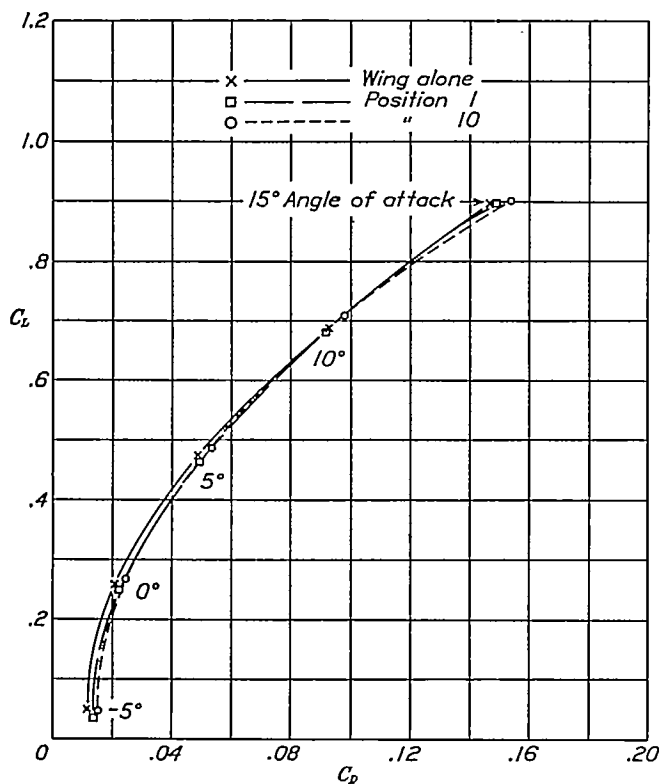

FIGURE 7.—Comparison of lift and drag characteristics of the biplane cellule alone and with the nacelle in positions 1 and 10.

tests. The V/nD for climb is obtained by assuming that climbing is done at 60 percent of high speed and

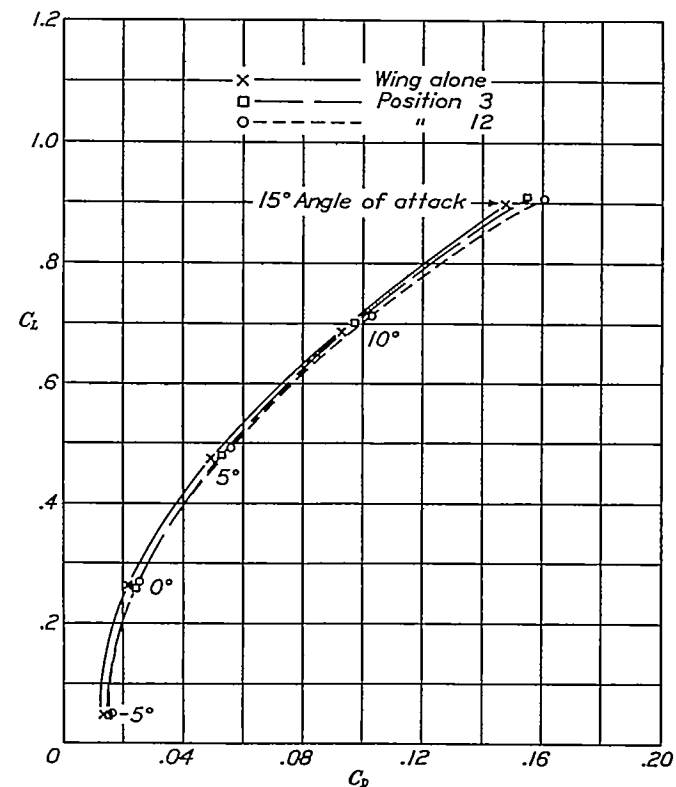

FIGURE 8.—Comparison of lift and drag characteristics of the biplane cellule alone and with the nacelle in positions 3 and 12.

was obtained with the nacelle in line with the upper wing.

Figure 6 shows the lift and drag coefficients of the biplane cellule with the nacelle in position 4, which had the poorest net efficiency, and in positions 2 and 11, which had high net efficiencies. A study of figures 6, 7, and 8 shows that the drag is not greatly different for similar positions ahead of the upper and lower wings.

Contours of propulsive efficiency, nacelle drag efficiency factor, and net efficiency have been plotted in figures 9, 10, and 11 for the high-speed and cruising flight conditions previously mentioned. Values for intermediate positions can be picked from these charts. In general, all three factors become increasingly favorable with distance ahead of the wings and with dis-

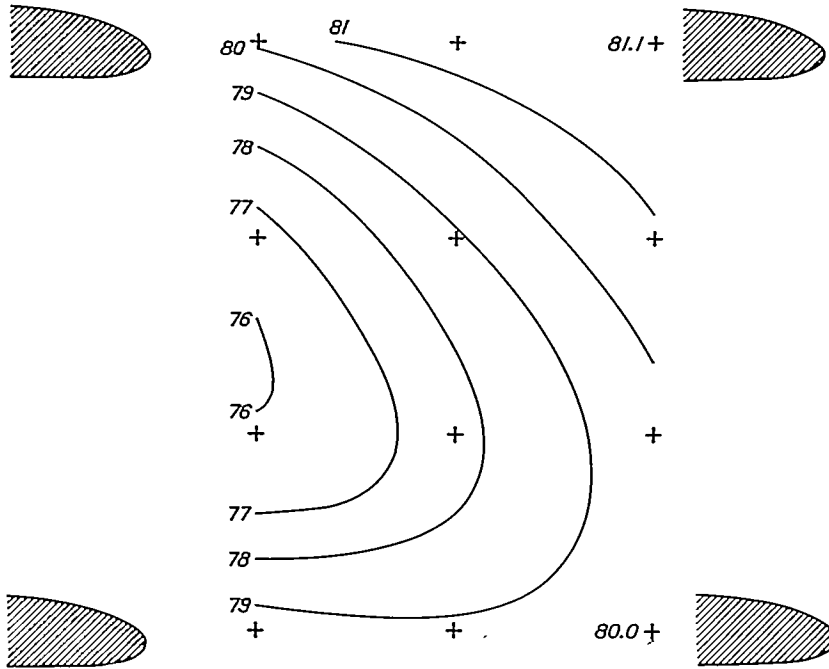

FIGURE 9.—Propulsive efficiency (percent) for cruising and high-speed conditions. ($C_L=0.259$; propeller set 17° at $0.75 R$; η taken at $V/nD=0.65$.)

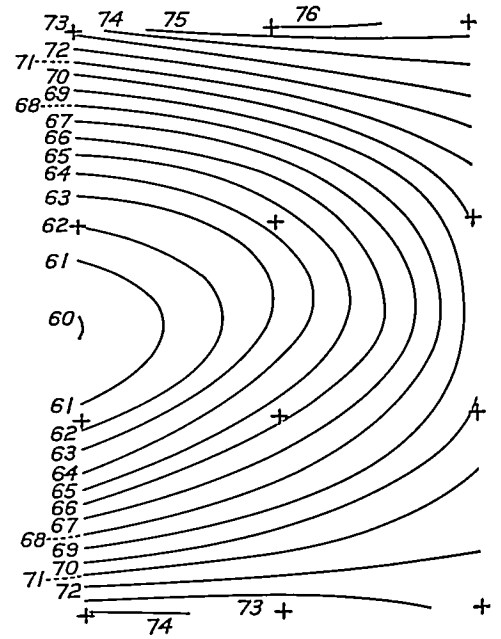

FIGURE 11.—Net efficiency (percent) for cruising and high-speed conditions. ($C_L=0.259$; propeller set 17° at $0.75 R$; η taken at $V/nD=0.65$.)

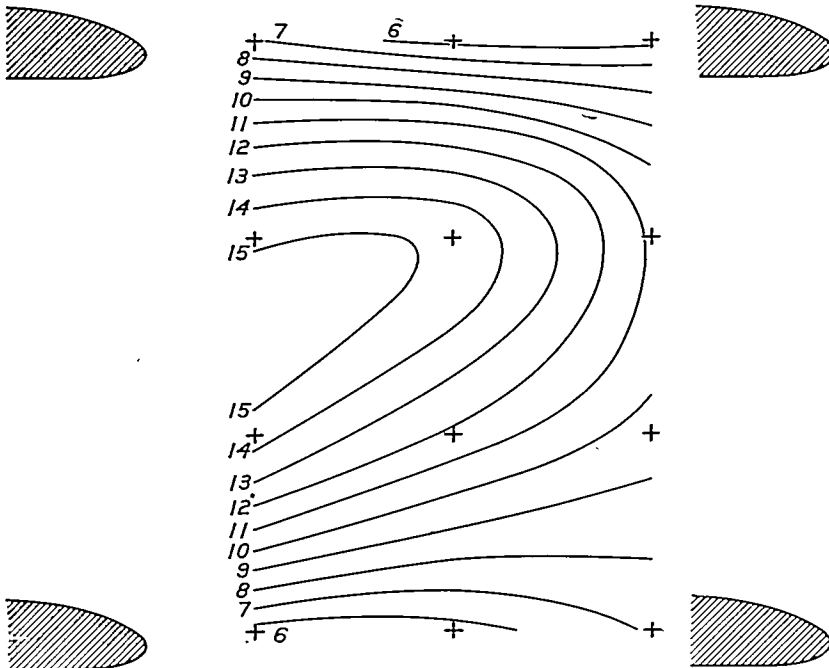

FIGURE 10.—Nacelle drag efficiency factor (percent) for cruising and high-speed conditions. ($C_L=0.259$; propeller set 17° at $0.75 R$; η taken at $V/nD=0.65$.)

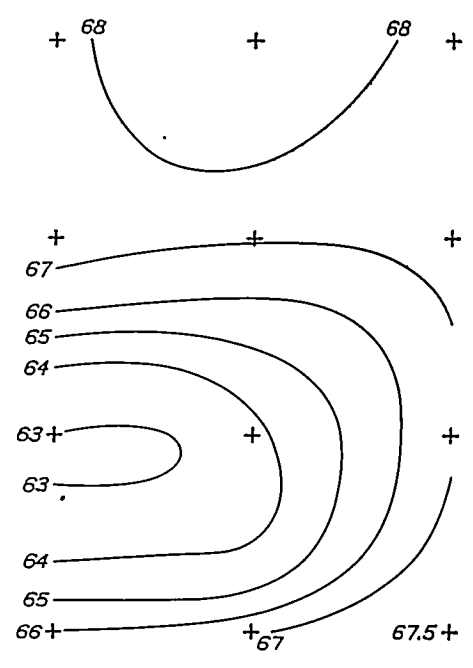

FIGURE 12.—Propulsive efficiency (percent) for climbing condition. ($C_L=0.480$; propeller set 17° at $0.75 R$; η taken at $V/nD=0.42$.)

tance from the mean chord line. Similar contours are given in figures 12, 13, and 14 for the climbing condition. In this case the propulsive efficiency and the

of charts indicates that the best position for the nacelle is that with the propeller one-half chord ahead of the upper wing.

For the speeds now being attained by modern high-speed transport airplanes other factors may have to be taken into account. At high speeds using a high-pitch propeller, changes in propeller efficiency with speed become so small as to be negligible. The propeller slipstream also has a smaller relative effect on the flow over the wing and nacelle, thus making the drag of the wing-nacelle combination the dominant factor in selecting the most favorable arrangement.¹

Figure 15 shows contours of the effective nacelle drag in terms of the drag of the nacelle alone at 0°. The effective nacelle drag used here is the difference in drag between the biplane-nacelle combination and the cellule alone, both drag values being taken at a

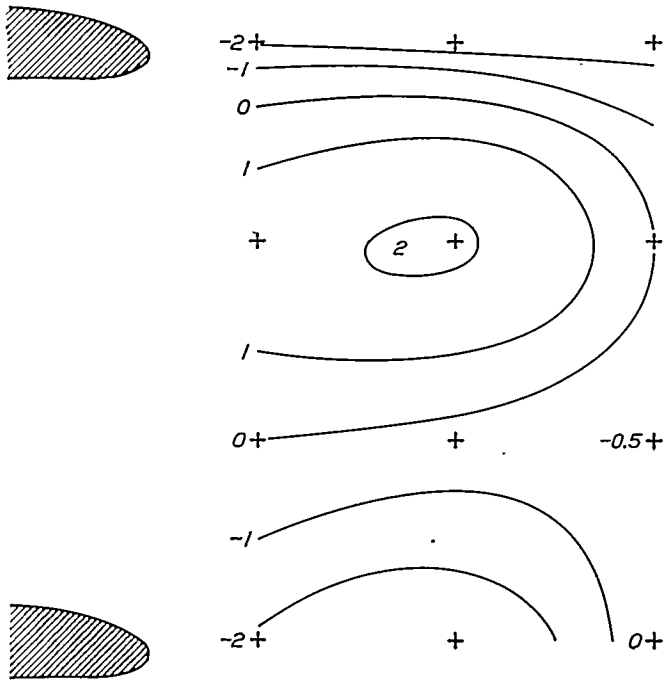

FIGURE 13.—Nacelle drag efficiency factor (percent) for climbing condition. ($C_L=0.430$; propeller set 17° at $0.75 R$; η taken at $V/nD=0.42$.)

net efficiency improve with distance from a point one-third of the gap above the lower leading edge. The

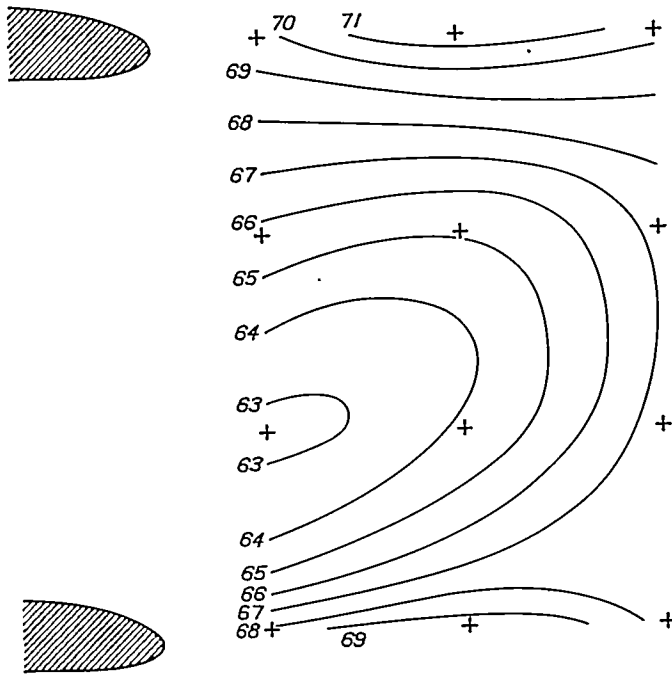
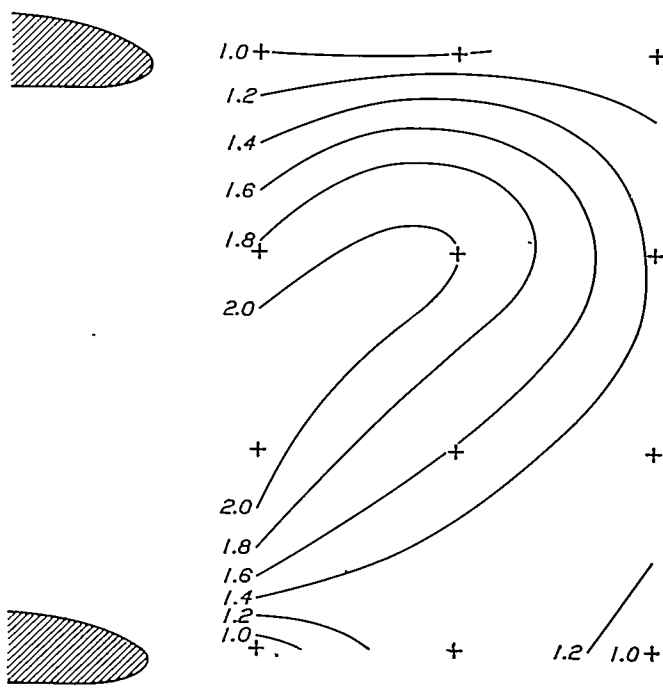

FIGURE 14.—Net efficiency (percent) for climbing condition. ($C_L=0.430$; propeller set 17° at $0.75 R$; η taken at $V/nD=0.42$.)

nacelle drag efficiency factor is negative when the nacelle is in line with either wing and positive for intermediate positions. An examination of both sets



Numbers on curves are $\frac{\text{effective nacelle drag}}{\text{drag of nacelle alone at } 0^\circ}$
 $= \frac{\text{drag of biplane nacelle combination} - \text{drag of biplane cellule alone}}{\text{drag of nacelle alone at } 0^\circ}$

FIGURE 15.—Effective nacelle drag ratio. ($C_L=0.259$, corresponding to an angle of attack of 0° for the cellule alone.)

lift coefficient of 0.259 corresponding to the high-speed and cruising condition. A ratio of 1.0 in figure 15 indicates an interference drag of zero. Position 1 in which the nacelle was mounted in line with the lower wing and close to the leading edge is the only one having a negative interference drag. With the nacelle in positions 3, 10, and 11 the interference drag is zero. A location of the nacelle half-way between the two chord lines with the propeller back close to the wing is most unfavorable.

¹ This conclusion is evident from the fact that the nacelle drag efficiency factor varies as $(V/nD)^2$ or for a given engine at rated r.p.m. as V^2 . At high speeds the nacelle drag efficiency factor becomes large and the net efficiency low, finally becoming zero. The efficiencies here given for the high-speed condition hold for speeds of approximately 120 m.p.h. and 140 m.p.h. for the J-5 and Wasp Jr. engines respectively.

For each nacelle position with respect to the Clark Y monoplane wing for which the results are given in reference 3 there is a corresponding biplane-nacelle location which is in a similar position with reference

wing than for other positions. Positions in line with the wing being excepted, the greatest difference in net efficiency is 2.2 percent for high speed and 2.6 percent for climbing conditions. Closer agreement

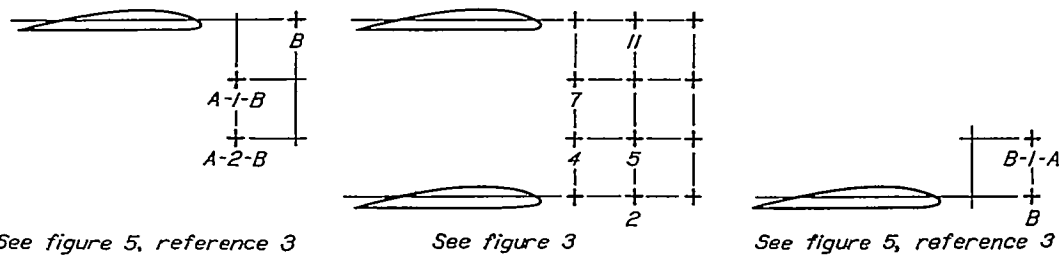

FIGURE 16.—Similarity of monoplane and biplane wing-nacelle combinations tested.

to either the upper or the lower wing. This relationship is illustrated in figure 16. It is seen that positions 2, 4, 5, 7, and 11 are similar to previously tested monoplane positions.

A comparison of the efficiency factors of similar monoplane and biplane positions is given in the following table:

	High-speed and cruising condition			Climbing condition		
	1 Biplane cellule	2 Mono- plane wing	(1)-(2)	1 Biplane cellule	2 Mono- plane wing	(1)-(2)
BIPLANE POSITION 2						
Propulsive efficiency.....	0.793	0.760	0.033	0.668	0.618	0.050
Nacelle drag efficiency factor.....	.056	.046	.010	-.028	-.013	-.015
Net efficiency.....	.737	.714	.023	.636	.631	.005
BIPLANE POSITION 4¹						
Propulsive efficiency.....	0.781	0.773	-0.012	0.628	0.647	-0.019
Nacelle drag efficiency factor.....	.145	.135	-.010	.000	.019	-.019
Net efficiency.....	.616	.638	-.022	.628	.628	.000
BIPLANE POSITION 5¹						
Propulsive efficiency.....	0.778	0.788	-0.012	0.637	0.658	-0.021
Nacelle drag efficiency factor.....	.119	.125	-.006	-.005	-.010	.005
Net efficiency.....	.657	.663	-.006	.642	.668	-.026
BIPLANE POSITION 7¹						
Propulsive efficiency.....	0.767	0.793	-0.026	0.674	0.670	0.004
Nacelle drag efficiency factor.....	.147	.151	-.004	.016	.027	-.011
Net efficiency.....	.620	.642	-.022	.658	.643	.015
BIPLANE POSITION 11						
Propulsive efficiency.....	0.815	0.760	0.055	0.688	0.618	0.070
Nacelle drag efficiency factor.....	.056	.046	.010	-.027	-.013	-.014
Net efficiency.....	.759	.714	.045	.715	.631	.084

¹ Nacelle faired into airfoil.

Under the conditions of high speed and cruising, the maximum difference in net efficiency is 4.5 percent. For climbing conditions the maximum difference is 8.4 percent. It appears that the similarity of characteristics is less marked for positions in line with the

is hardly to be expected because the monoplane and biplane wings were of different effective aspect ratios and the comparisons were not made at the same lift in both cases.

In figure 17 the effective drag of the nacelle is compared for similar positions with respect to the monoplane wing and biplane cellule. Since the same nacelle was used in one case with 50 square feet of wing area and in the other case with 100 square feet of wing area, it was necessary to multiply the drag coefficient referred to the biplane cellule by 2 for comparison. Positions 2 and 11 give results in general agreement with those for similar monoplane positions throughout the range, while positions 4, 5, and 7 give a similar agreement only at low angles. All positions give the same agreement over the normal flying range. The nacelle drag for combinations with the biplane cellule starts to increase at higher values of the lift coefficient for all of the cases compared. The actual differences in nacelle drag are quite large but the statement as to agreement is based on the fact that the nacelle drag is a small part of the total drag. A difference of 50 percent in nacelle drag means only a small percentage difference in the total drag; hence there is only a small change in the over-all performance indicated by the comparative curves of figure 17.

From the agreement between the results for similar monoplane and biplane arrangements, it would seem that there would be little error in predicting the results with the nacelle above or below the biplane cellule on the basis of the results obtained with the nacelle and the monoplane wing.

CONCLUSIONS

1. At a lift coefficient corresponding to the high speed and cruising condition with the propeller removed, the interference drag is favorable only when the nacelle is in a position just ahead of the lower wing. It is most unfavorable with the nacelle in a position just ahead of the leading edges with its axis at the center of the gap.

2. For both the high speed and the climbing conditions, the propulsive efficiency is greatest when the propeller axis is in line with either wing chord, and

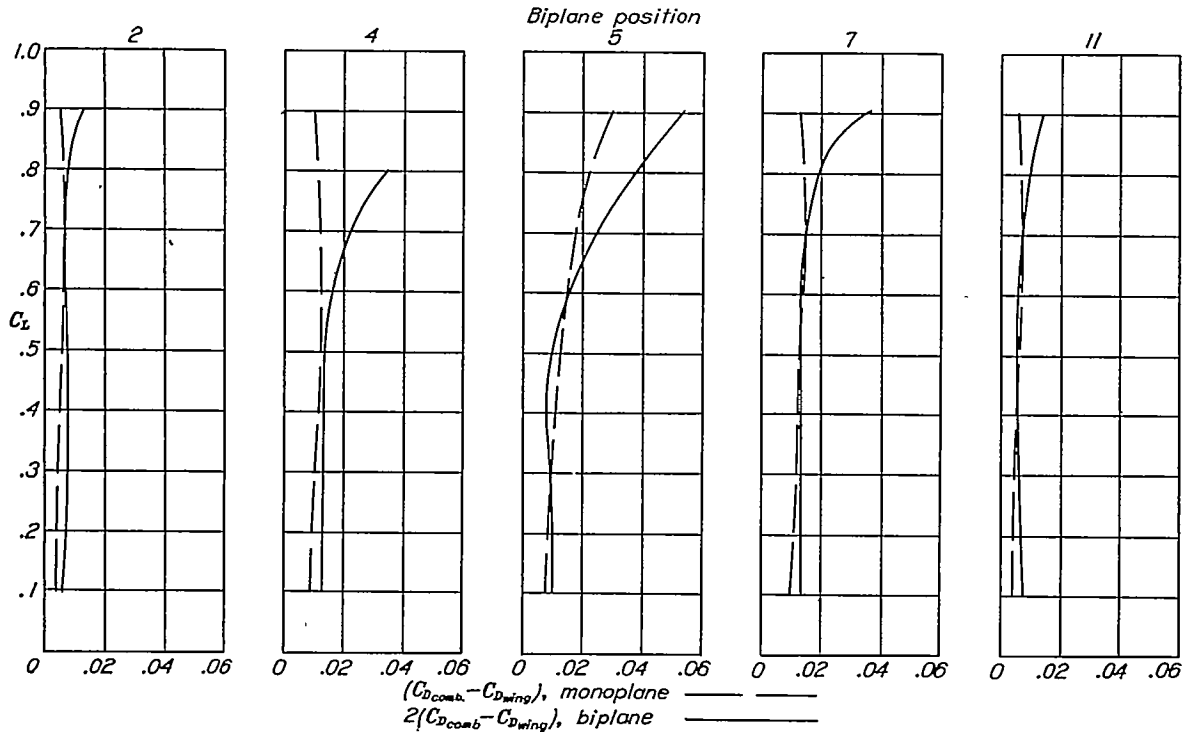

FIGURE 17.—Comparison of effective nacelle drag coefficients of similar monoplane and biplane combinations.

least when the axis is between the two wings and the propeller is close to the leading edges.

3. The highest net efficiency, considering both high speed and climbing conditions, is obtained with the propeller axis in line with the chord of the upper wing and the propeller about one-half chord length ahead of the leading edge. A similar position with respect to the lower wing is nearly as good.

4. The poorest nacelle location, considering the net efficiency at high speed and at climbing conditions, is with the propeller near the leading edges and its axis between the two chord lines.

5. The net efficiency of a biplane-nacelle combination agrees fairly well with that of the monoplane arrangement represented by the nacelle and the biplane wing nearest to it.

LANGLEY MEMORIAL AERONAUTICAL LABORATORY,
 NATIONAL ADVISORY COMMITTEE FOR AERONAUTICS,
 LANGLEY FIELD, VA., January 26, 1934.

REFERENCES

1. Wood, Donald H.: Tests of Nacelle-Propeller Combinations in Various Positions with Reference to Wings. Part I. Thick Wing—N.A.C.A. Cowled Nacelle—Tractor Propeller. T.R. No. 415, N.A.C.A., 1932.

2. Wood, Donald H.: Tests of Nacelle-Propeller Combinations in Various Positions with Reference to Wings. II—Thick Wing—Various Radial-Engine Cowlings—Tractor Propeller. T.R. No. 436, N.A.C.A., 1932.

3. Wood, Donald H.: Tests of Nacelle-Propeller Combinations in Various Positions with Reference to Wings. III—Clark Y Wing—Various Radial-Engine Cowlings—Tractor Propeller. T.R. No. 462, N.A.C.A., 1933.

4. McHugh, James G.: Tests of Nacelle-Propeller Combinations in Various Positions with Reference to Wings. IV—Thick Wing—Various Radial-Engine Cowlings—Tandem Propellers. T.R. No. 505, N.A.C.A., 1934.

5. Weick, Fred E., and Wood, Donald H.: The Twenty-Foot Propeller Research Tunnel of the National Advisory Committee for Aeronautics. T.R. No. 300, N.A.C.A., 1928.

6. Wood, Donald H.: Tests of Large Airfoils in the Propeller Research Tunnel, Including Two with Corrugated Surfaces. T.R. No. 336, N.A.C.A., 1929.

7. Windler, Ray: Drag Tests of 4/9-Scale Model Engine Nacelles with Various Cowlings. T.N. No. 432, N.A.C.A., 1932.

8. Weick, Fred E.: Working Charts for the Selection of Aluminum Alloy Propellers of a Standard Form to Operate with Various Aircraft Engines and Bodies. T.R. No. 350, N.A.C.A., 1930.

TABLE I
LIFT COEFFICIENT WITHOUT PROPELLER

$$C_L = \frac{\text{Lift}}{qS}$$

Nacelle position	50 m.p.h. R.N.=1,360,000					75 m.p.h. R.N.=2,040,000					100 m.p.h. R.N.=2,720,000				
	-5°	0°	5°	10°	15°	-5°	0°	5°	10°	15°	-5°	0°	5°	10°	15°
Nacelle alone.....	-0.006	0.000	0.002	0.007	0.011	-0.006	0.000	0.002	0.007	0.011	-0.006	0.000	0.002	0.007	0.011
Cellule alone.....	.054	.267	.480	.693	.900	.051	.264	.477	.690	.897	.046	.259	.472	.685	.894
1.....	.042	.267	.473	.682038	.253	.469	.688033	.247	.463	.682	.897
2.....	.043	.283	.483	.704039	.269	.479	.700034	.253	.473	.695	.900
3.....	.045	.284	.485	.704042	.261	.482	.701038	.258	.478	.697	.900
4 ¹053	.289	.482	.690049	.264	.478	.687043	.258	.472	.683	.894
5 ¹067	.279	.486	.693063	.275	.482	.690058	.270	.477	.685	.894
6.....	.046	.282	.472	.681042	.258	.468	.678037	.252	.463	.675	.870
7 ¹060	.268	.477	.688055	.263	.472	.683048	.257	.465	.676	.870
8 ¹040	.255	.470	.687036	.251	.467	.685030	.245	.464	.682	.878
9.....	.053	.264	.477	.691048	.260	.473	.687041	.254	.467	.682	.878
10.....	.057	.277	.497	.719053	.273	.493	.715047	.267	.487	.710	.905
11.....	.057	.277	.496	.713053	.273	.492	.709047	.267	.486	.704	.909
12.....	.059	.279	.500	.720054	.274	.495	.716046	.267	.489	.710	.906

¹ Nacelle faired into airfoil.

TABLE II
DRAG COEFFICIENT WITHOUT PROPELLER

$$C_D = \frac{\text{Drag}}{qS}$$

Nacelle position	50 m.p.h. R.N.=1,360,000					75 m.p.h. R.N.=2,040,000					100 m.p.h. R.N.=2,720,000				
	-5°	0°	5°	10°	15°	-5°	0°	5°	10°	15°	-5°	0°	5°	10°	15°
Nacelle alone.....	0.0040	0.0040	0.0040	0.0050	0.0060	0.0035	0.0035	0.0040	0.0045	0.0055	0.0025	0.0030	0.0035	0.0040	0.0050
Cellule alone.....	.0125	.0220	.0300	.0385	.485	.0125	.0215	.0495	.0930	.1475	.0120	.0210	.0490	.0920	.1405
1.....	.0155	.0240	.0310	.09400160	.0235	.0505	.09300140	.0225	.0495	.0920	.1480
2.....	.0160	.0250	.0335	.09800155	.0245	.0530	.09750145	.0240	.0525	.0970	.1540
3.....	.0160	.0250	.0335	.09750155	.0245	.0530	.09700145	.0240	.0525	.0965	.1545
4 ¹0200	.0290	.0370	.10300195	.0285	.0560	.10200185	.0275	.0550	.1010	.1570
5 ¹0185	.0280	.0365	.10500180	.0275	.0555	.10400170	.0265	.0545	.1030	.1635
6.....	.0175	.0265	.0335	.09700165	.0255	.0530	.09850150	.0240	.0520	.0960	.1540
7 ¹0195	.0280	.0350	.09700190	.0275	.0545	.09850180	.0265	.0540	.0960	.1525
8 ¹0200	.0275	.0340	.09850195	.0270	.0535	.09900185	.0260	.0530	.0955	.1510
9.....	.0180	.0260	.0335	.09700170	.0255	.0530	.09850160	.0245	.0520	.0955	.1520
10.....	.0170	.0270	.0360	.10050160	.0260	.0550	.09950150	.0245	.0535	.0985	.1565
11.....	.0175	.0270	.0350	.10100165	.0260	.0540	.10050150	.0245	.0530	.0985	.1580
12.....	.0180	.0270	.0370	.10300170	.0260	.0565	.10300160	.0250	.0560	.1025	.1600

¹ Nacelle faired into airfoil.

TABLE III
MOMENT COEFFICIENT WITHOUT PROPELLER

$$C_m = \frac{\text{Moment}}{qSc}$$

Nacelle position	Angle of attack				
	-5°	0°	5°	10°	15°
Cellule alone.....	-0.062	-0.057	-0.056	-0.058	-0.049
1.....	-.065	-.060	-.057	-.054	-.054
2.....	-.065	-.060	-.067	-.050	-.048
3.....	-.066	-.060	-.052	-.044	-.032
4 ¹	-.063	-.060	-.057	-.061	-.072
5 ¹	-.063	-.053	-.050	-.055	-.058
6.....	-.067	-.055	-.046	-.041	-.033
7 ¹	-.060	-.058	-.067	-.057	-.056
8 ¹	-.067	-.061	-.059	-.055	-.046
9.....	-.072	-.059	-.051	-.044	-.033
10.....	-.062	-.060	-.058	-.058	-.050
11.....	-.062	-.054	-.046	-.042	-.042
12.....	-.059	-.051	-.045	-.037	-.030

¹ Nacelle faired into airfoil.

TABLE IV
 THRUST COEFFICIENT

$$C_T = \frac{(T - \Delta D)}{\rho n^2 D^4}$$

Propeller no. 4412, 4 feet. Set 17° at 0.75 R.

Nacelle position	Angle of attack = -5°									Angle of attack = 0°								
	$\frac{V}{nD}$									$\frac{V}{nD}$								
	0.1	0.2	0.3	0.4	0.5	0.6	0.7	0.8	0.9	0.1	0.2	0.3	0.4	0.5	0.6	0.7	0.8	0.9
1.....	0.0825	0.0778	0.0717	0.0638	0.0539	0.0431	0.0311	0.0168	0.0005	0.0830	0.0783	0.0723	0.0644	0.0549	0.0436	0.0317	0.0179	0.0032
2.....	.0834	.0791	.0730	.0650	.0543	.0421	.0290	.0145	-.0009	.0834	.0793	.0732	.0652	.0547	.0431	.0306	.0170	.0011
3.....	.0841	.0794	.0729	.0648	.0545	.0427	.0300	.0151	-.0002	.0840	.0794	.0730	.0646	.0544	.0429	.0304	.0164	.0013
4.....	.0848	.0800	.0733	.0651	.0553	.0444	.0325	.0185	.0054	.0847	.0797	.0732	.0637	.0540	.0435	.0323	.0196	.0061
4 ¹0848	.0802	.0745	.0663	.0563	.0458	.0335	.0192	.0036	.0848	.0799	.0733	.0651	.0553	.0446	.0327	.0185	.0032
6.....	.0862	.0815	.0753	.0673	.0571	.0465	.0325	.0185	.0036	.0869	.0811	.0750	.0670	.0566	.0451	.0322	.0183	.0036
7 ¹0840	.0795	.0728	.0639	.0539	.0425	.0306	.0177	.0047	.0869	.0808	.0742	.0658	.0557	.0439	.0317	.0188	.0055
8.....	.0874	.0820	.0753	.0667	.0566	.0452	.0328	.0191	.0049	.0874	.0820	.0751	.0666	.0567	.0468	.0330	.0189	.0037
9.....	.0863	.0813	.0741	.0653	.0559	.0445	.0324	.0189	.0036	.0868	.0814	.0745	.0661	.0561	.0464	.0328	.0192	.0037
10.....	.0870	.0812	.0738	.0650	.0550	.0439	.0311	.0172	.0021	.0867	.0804	.0736	.0650	.0550	.0437	.0306	.0189	.0009
11.....	.0877	.0827	.0760	.0676	.0572	.0453	.0325	.0179	.0023	.0877	.0827	.0760	.0676	.0570	.0448	.0315	.0185	.0006
12.....	.0864	.0813	.0745	.0660	.0564	.0453	.0327	.0186	.0027	.0864	.0813	.0745	.0660	.0564	.0453	.0327	.0186	.0027
Angle of attack = -5°																		
Angle of attack = 10°																		
1.....	0.0813	0.0766	0.0703	0.0622	0.0528	0.0418	0.0301	0.0170	0.0029	0.0801	0.0752	0.0687	.0606	0.0513	0.0408	0.0302	0.0175	0.0039
2.....	.0832	.0785	.0718	.0631	.0530	.0420	.0301	.0168	.0025	.0799	.0747	.0677	.0596	.0404	.0290	.0169	.0042	.0012
3.....	.0837	.0788	.0719	.0632	.0533	.0426	.0304	.0167	.0023	.0805	.0750	.0682	.0600	.0511	.0412	.0300	.0174	.0043
4.....	.0817	.0763	.0696	.0610	.0513	.0407	.0295	.0174	.0044	.0798	.0729	.0649	.0562	.0468	.0370	.0273	.0172	.0064
5.....	.0831	.0778	.0708	.0622	.0520	.0406	.0288	.0165	.0031	.0806	.0737	.0657	.0570	.0480	.0380	.0274	.0160	.0043
6.....	.0840	.0790	.0725	.0640	.0542	.0429	.0305	.0168	.0020	.0811	.0759	.0682	.0610	.0518	.0415	.0303	.0179	.0050
7.....	.0854	.0803	.0733	.0649	.0550	.0420	.0320	.0190	.0047	.0832	.0781	.0715	.0634	.0540	.0435	.0320	.0197	.0033
7 ¹0866	.0815	.0749	.0663	.0562	.0447	.0318	.0177	.0021	.0853	.0801	.0733	.0650	.0552	.0440	.0319	.0187	.0047
9.....	.0850	.0797	.0729	.0647	.0553	.0443	.0323	.0183	.0023	.0840	.0789	.0722	.0642	.0547	.0436	.0312	.0173	.0025
10.....	.0853	.0798	.0728	.0640	.0535	.0412	.0282	.0138	-.0013	.0825	.0772	.0703	.0618	.0522	.0410	.0277	.0127	-.0038
11.....	.0847	.0800	.0740	.0658	.0557	.0441	.0304	.0148	-.0017	.0838	.0788	.0721	.0639	.0539	.0426	.0297	.0148	-.0023
12.....	.0843	.0794	.0728	.0644	.0543	.0425	.0297	.0162	-.0003	.0835	.0782	.0717	.0633	.0539	.0424	.0295	.0144	-.0018

¹ Nacelle faired into airflow.

TABLE V
 POWER COEFFICIENT

$$C_P = \frac{P}{\rho n^3 D^5}$$

Propeller no. 4412, 4 feet. Set 17° at 0.75 R

Nacelle position	Angle of attack = -5°									Angle of attack = 0°								
	$\frac{V}{nD}$									$\frac{V}{nD}$								
	0.1	0.2	0.3	0.4	0.5	0.6	0.7	0.8	0.9	0.1	0.2	0.3	0.4	0.5	0.6	0.7	0.8	0.9
1.....	0.0397	0.0397	0.0395	0.0387	0.0365	0.0329	0.0274	0.0191	0.0080	0.0397	0.0397	0.0396	0.0387	0.0369	0.0331	0.0276	0.0193	0.0097
2.....	.0400	.0400	.0398	.0390	.0367	.0329	.0267	.0181	.0075	.0400	.0400	.0396	.0390	.0368	.0329	.0274	.0193	.0087
3.....	.0400	.0397	.0392	.0382	.0360	.0323	.0268	.0184	.0073	.0400	.0397	.0394	.0382	.0361	.0325	.0269	.0191	.0077
4.....	.0405	.0405	.0403	.0396	.0376	.0343	.0293	.0219	.0119	.0407	.0407	.0404	.0399	.0379	.0347	.0296	.0221	.0122
5.....	.0405	.0405	.0404	.0399	.0380	.0347	.0293	.0213	.0108	.0407	.0407	.0407	.0400	.0380	.0347	.0293	.0213	.0113
6.....	.0409	.0409	.0406	.0397	.0375	.0340	.0283	.0201	.0100	.0409	.0409	.0407	.0397	.0375	.0340	.0285	.0205	.0106
7.....	.0407	.0407	.0405	.0397	.0380	.0349	.0300	.0227	.0130	.0407	.0407	.0405	.0395	.0378	.0343	.0292	.0218	.0125
8.....	.0417	.0417	.0415	.0406	.0385	.0348	.0293	.0214	.0117	.0418	.0418	.0415	.0403	.0383	.0349	.0295	.0218	.0117
9.....	.0410	.0410	.0407	.0397	.0376	.0340	.0283	.0203	.0105	.0407	.0407	.0402	.0393	.0373	.0340	.0283	.0205	.0104
10.....	.0405	.0405	.0401	.0389	.0370	.0334	.0273	.0198	.0083	.0405	.0405	.0402	.0390	.0370	.0331	.0269	.0180	.0070
11.....	.0417	.0416	.0410	.0397	.0375	.0335	.0277	.0191	.0083	.0417	.0415	.0409	.0396	.0373	.0333	.0274	.0188	.0080
12.....	.0407	.0406	.0403	.0394	.0375	.0338	.0280	.0195	.0089	.0409	.0408	.0406	.0396	.0372	.0335	.0274	.0188	.0082
Angle of attack = -5°																		
Angle of attack = 10°																		
1.....	0.0398	0.0398	0.0397	0.0388	0.0370	0.0332	0.0281	0.0207	0.0105	0.0400	0.0399	0.0398	0.0392	0.0373	0.0343	0.0300	0.0230	0.0131
2.....	.0400	.0400	.0398	.0390	.0368	.0329	.0275	.0195	.0093	.0397	.0396	.0393	.0387	.0371	.0338	.0283	.0210	.0118
3.....	.0400	.0397	.0394	.0382	.0360	.0325	.0270	.0189	.0085	.0400	.0400	.0397	.0391	.0372	.0335	.0279	.0199	.0068
4.....	.0409	.0409	.0407	.0402	.0380	.0348	.0300	.0232	.0135	.0410	.0410	.0409	.0403	.0386	.0355	.0310	.0243	.0157
5.....	.0409	.0409	.0408	.0405	.0385	.0350	.0295	.0220	.0119	.0410	.0410	.0409	.0406	.0387	.0354	.0305	.0235	.0137
6.....	.0410	.0410	.0407	.0398	.0378	.0340	.0288	.0209	.0110	.0410	.0410	.0408	.0399	.0377	.0343	.0293	.0216	.0120
7.....	.0423	.0420	.0413	.0400	.0377	.0343	.0290	.0216	.0117	.0427	.0424	.0417	.0405	.0383	.0348	.0295	.0223	.0125
8.....	.0420	.0420	.0415	.0404	.0384	.0347	.0290	.0211	.0110	.0423	.0421	.0420	.0414	.0394	.0353	.0298	.0218	.0123
9.....	.0420	.0420	.0417	.0405	.0379	.0340	.0288	.0206	.0107	.0420	.0419	.0415	.0403	.0384	.0348	.0291	.0207	.0107
10.....	.0407	.0405	.0401	.0391	.0365	.0321	.0258	.0164	.0063	.0407	.0405	.0401	.0391	.0368	.0327	.0261	.0165	.0043
11.....	.0410	.0410	.0406	.0396	.0375	.0334	.0270	.0181	.0074	.0410	.0410	.0407	.0399	.0374	.0333	.0271	.0181	.0073
12.....	.0414	.0413	.0410	.0399	.0376	.0334	.0274	.0188	.0082	.0417	.0417	.0413	.0402	.0380	.0338	.0277	.0191	.0082

¹ Nacelle faired into airflow.

REPORT NATIONAL ADVISORY COMMITTEE FOR AERONAUTICS

TABLE VI
 PROPULSIVE EFFICIENCY

$$\eta = \frac{(T-\Delta D)V}{P}$$

Propeller no. 4412, 4 feet. Set 17° at 0.75 R

Nacelle position	Angle of attack=-5°									Angle of attack=0°								
	$\frac{V}{nD}$									$\frac{V}{nD}$								
	0.1	0.2	0.3	0.4	0.5	0.6	0.7	0.8	0.9	0.1	0.2	0.3	0.4	0.5	0.6	0.7	0.8	0.9
1	0.208	0.392	0.545	0.659	0.738	0.786	0.795	0.704	0.058	0.209	0.394	0.547	0.665	0.744	0.791	0.804	0.742	0.297
2	.209	.396	.551	.666	.740	.768	.761	.641	-----	.209	.396	.552	.670	.744	.780	.782	.705	.114
3	.210	.400	.558	.679	.757	.794	.784	.656	-----	.210	.400	.556	.676	.753	.791	.790	.687	.152
4 ¹	.209	.395	.546	.658	.735	.776	.777	.712	.408	.208	.395	.545	.659	.732	.762	.762	.710	.450
5 ¹	.209	.396	.553	.670	.747	.794	.802	.720	.300	.208	.392	.540	.651	.723	.771	.772	.694	.255
6	.211	.398	.556	.673	.762	.804	.804	.739	.324	.210	.396	.552	.675	.755	.796	.791	.715	.306
7 ¹	.208	.390	.539	.644	.709	.730	.714	.624	.325	.211	.396	.550	.666	.737	.768	.760	.690	.390
8 ¹	.209	.393	.544	.659	.735	.780	.783	.714	.377	.209	.393	.543	.661	.740	.783	.783	.693	.284
9	.210	.396	.546	.663	.744	.791	.800	.743	.309	.213	.401	.555	.673	.753	.801	.811	.751	.320
10	.215	.401	.552	.668	.743	.789	.797	.731	.228	.212	.397	.550	.666	.744	.792	.787	.708	-----
11	.210	.397	.556	.681	.763	.812	.823	.748	.249	.210	.398	.557	.683	.764	.807	.800	.702	.068
12	.212	.400	.555	.670	.752	.805	.819	.763	.273	.211	.399	.552	.669	.753	.801	.803	.715	.033
Nacelle position	Angle of attack=5°									Angle of attack=10°								
	$\frac{V}{nD}$									$\frac{V}{nD}$								
	0.1	0.2	0.3	0.4	0.5	0.6	0.7	0.8	0.9	0.1	0.2	0.3	0.4	0.5	0.6	0.7	0.8	0.9
1	0.204	0.335	0.531	0.641	0.714	0.756	0.749	0.655	0.249	0.200	0.377	0.518	0.619	0.687	0.714	0.705	0.609	0.203
2	.208	.392	.541	.648	.720	.766	.766	.688	.246	.201	.378	.517	.616	.682	.718	.718	.644	.320
3	.209	.396	.547	.662	.741	.787	.790	.708	.244	.201	.375	.516	.614	.687	.739	.754	.700	.306
4 ¹	.200	.373	.513	.606	.675	.702	.688	.600	.293	.194	.356	.476	.563	.606	.624	.617	.567	.307
5 ¹	.203	.380	.520	.615	.676	.700	.683	.599	.234	.187	.360	.482	.562	.620	.644	.629	.544	.282
6	.205	.385	.534	.643	.721	.758	.749	.643	.164	.198	.370	.509	.611	.688	.726	.724	.663	.375
7 ¹	.202	.382	.532	.649	.729	.769	.773	.704	.162	.185	.368	.515	.625	.705	.750	.759	.707	.417
8 ¹	.206	.388	.541	.656	.731	.774	.769	.677	.172	.202	.380	.524	.623	.700	.747	.750	.685	.344
9	.202	.380	.524	.639	.730	.784	.791	.711	.194	.200	.376	.522	.637	.713	.752	.751	.668	.220
10	.210	.394	.544	.655	.732	.770	.773	.673	-----	.203	.381	.525	.632	.710	.752	.742	.610	-----
11	.207	.390	.547	.665	.744	.792	.787	.654	-----	.204	.384	.531	.640	.721	.768	.767	.658	-----
12	.204	.384	.533	.645	.723	.764	.758	.647	-----	.200	.375	.521	.629	.709	.752	.745	.603	-----

¹ Nacelle faired into airfoil.

TABLE VII
 LIFT COEFFICIENT WITH PROPELLER OPERATING

$$C_{Lp} = \frac{L_P}{qS}$$

Propeller no. 4412, 4 feet. Set 17° at 0.75 R

Nacelle position	Angle of attack=-5°						Angle of attack=0°					
	$\frac{V}{nD}$						$\frac{V}{nD}$					
	0.4	0.5	0.6	0.7	0.8	0.9	0.4	0.5	0.6	0.7	0.8	0.9
1	0.021	0.022	0.023	0.023	0.024	0.026	0.267	0.261	0.254	0.252	0.250	0.240
2	.039	.040	.042	.043	.043	.045	.285	.274	.267	.263	.261	.261
3	.046	.041	.037	.037	.037	.037	.267	.264	.263	.263	.264	.264
4 ¹	.060	.054	.049	.046	.045	.046	.294	.280	.271	.268	.263	.261
5 ¹	.071	.063	.060	.056	.056	.058	.297	.287	.279	.274	.272	.270
6	.053	.043	.036	.035	.035	.036	.278	.267	.261	.256	.255	.254
7 ¹	.058	.056	.053	.052	.049	.046	.283	.269	.261	.257	.255	.253
8 ¹	.049	.034	.031	.029	.029	.028	.279	.264	.256	.253	.251	.240
9	.041	.040	.038	.037	.037	.037	.282	.269	.269	.263	.261	.250
10	.081	.062	.050	.043	.041	.041	.304	.292	.283	.278	.273	.270
11	.064	.057	.053	.049	.047	.047	.296	.282	.273	.267	.265	.264
12	.081	.068	.060	.053	.051	.049	.314	.292	.281	.274	.269	.260
Nacelle position	Angle of attack=5°						Angle of attack=10°					
	$\frac{V}{nD}$						$\frac{V}{nD}$					
	0.4	0.5	0.6	0.7	0.8	0.9	0.4	0.5	0.6	0.7	0.8	0.9
1	0.503	0.489	0.479	0.473	0.469	0.467	0.737	0.716	0.701	0.692	0.687	0.684
2	.528	.514	.502	.494	.489	.486	.772	.743	.726	.717	.714	.712
3	.508	.500	.497	.490	.489	.487	.743	.728	.715	.705	.699	.691
4 ¹	.535	.511	.494	.486	.482	.482	.740	.724	.712	.703	.697	.694
5 ¹	.523	.504	.493	.486	.483	.482	.756	.728	.710	.703	.698	.697
6	.512	.499	.489	.482	.475	.472	.747	.724	.708	.697	.692	.680
7 ¹	.520	.492	.477	.470	.466	.464	.731	.708	.693	.686	.683	.681
8 ¹	.489	.482	.474	.469	.466	.464	.726	.711	.698	.691	.686	.683
9	.503	.489	.480	.474	.471	.467	.736	.717	.703	.694	.687	.682
10	.537	.516	.502	.491	.490	.489	.767	.743	.724	.713	.707	.701
11	.564	.538	.521	.506	.498	.493	.765	.745	.731	.720	.713	.708
12	.544	.523	.511	.506	.503	.503	.772	.754	.742	.731	.724	.717

¹ Nacelle faired into airfoil.

TABLE VIII
 MOMENT COEFFICIENT OPERATING WITH PROPELLER

$$C_{mP} = \frac{M_P}{q S c}$$

Propeller No. 4412, 4 feet. Set 17° at 0.75 R.

Nacelle position	Angle of attack = -5°						Angle of attack = 0°					
	$\frac{V}{nD}$						$\frac{V}{nD}$					
	0.4	0.5	0.6	0.7	0.8	0.9	0.4	0.5	0.6	0.7	0.8	0.9
1.....	-0.024	-0.041	-0.053	-0.060	-0.066	-0.069	-0.010	-0.028	-0.040	-0.049	-0.054	-0.057
2.....	-0.040	-0.051	-0.059	-0.065	-0.068	-0.070	-0.012	-0.030	-0.043	-0.052	-0.057	-0.060
3.....	-0.025	-0.043	-0.054	-0.062	-0.067	-0.070	-0.012	-0.029	-0.042	-0.050	-0.056	-0.059
4 ¹	-0.057	-0.060	-0.062	-0.064	-0.065	-0.065	-0.056	-0.057	-0.057	-0.057	-0.056	-0.056
5 ¹	-0.053	-0.056	-0.059	-0.061	-0.062	-0.063	-0.038	-0.043	-0.047	-0.049	-0.051	-0.052
6.....	-0.065	-0.065	-0.065	-0.066	-0.066	-0.067	-0.042	-0.048	-0.051	-0.053	-0.054	-0.054
7 ¹	-0.094	-0.085	-0.077	-0.072	-0.068	-0.066	-0.035	-0.077	-0.071	-0.066	-0.062	-0.058
8 ¹	-0.110	-0.096	-0.086	-0.078	-0.073	-0.069	-0.093	-0.083	-0.075	-0.069	-0.065	-0.062
9.....	-0.109	-0.095	-0.085	-0.077	-0.073	-0.069	-0.096	-0.083	-0.073	-0.066	-0.061	-0.058
10.....	-0.145	-0.108	-0.090	-0.080	-0.073	-0.068	-0.127	-0.098	-0.080	-0.069	-0.062	-0.058
11.....	-0.135	-0.106	-0.088	-0.075	-0.067	-0.061	-0.125	-0.096	-0.078	-0.067	-0.058	-0.054
12.....	-0.147	-0.113	-0.093	-0.081	-0.073	-0.068	-0.131	-0.095	-0.077	-0.065	-0.058	-0.052
Nacelle position	Angle of attack = 5°						Angle of attack = 10°					
	$\frac{V}{nD}$						$\frac{V}{nD}$					
	0.4	0.5	0.6	0.7	0.8	0.9	0.4	0.5	0.6	0.7	0.8	0.9
1.....	-0.011	-0.029	-0.041	-0.049	-0.054	-0.056	0.001	-0.016	-0.029	-0.038	-0.045	-0.051
2.....	0.000	-0.022	-0.037	-0.048	-0.054	-0.058	-0.001	-0.019	-0.032	-0.040	-0.045	-0.048
3.....	-0.005	-0.023	-0.035	-0.044	-0.049	-0.053	0.011	-0.010	-0.024	-0.034	-0.039	-0.042
4 ¹	-0.049	-0.054	-0.057	-0.058	-0.060	-0.060	-0.048	-0.052	-0.053	-0.054	-0.055	-0.055
5 ¹	-0.029	-0.039	-0.044	-0.047	-0.048	-0.048	-0.041	-0.043	-0.044	-0.045	-0.045	-0.045
6.....	-0.033	-0.038	-0.042	-0.045	-0.047	-0.047	-0.026	-0.030	-0.033	-0.035	-0.037	-0.039
7 ¹	-0.081	-0.072	-0.066	-0.061	-0.058	-0.055	-0.071	-0.065	-0.060	-0.055	-0.053	-0.052
8 ¹	-0.075	-0.069	-0.065	-0.062	-0.059	-0.057	-0.078	-0.069	-0.062	-0.058	-0.054	-0.052
9.....	-0.081	-0.071	-0.063	-0.058	-0.054	-0.051	-0.060	-0.054	-0.050	-0.047	-0.044	-0.042
10.....	-0.184	-0.098	-0.080	-0.068	-0.060	-0.054	-0.120	-0.092	-0.074	-0.063	-0.055	-0.052
11.....	-0.111	-0.087	-0.069	-0.058	-0.050	-0.044	-0.105	-0.078	-0.060	-0.048	-0.041	-0.038
12.....	-0.119	-0.087	-0.066	-0.054	-0.048	-0.044	-0.105	-0.077	-0.058	-0.047	-0.039	-0.036

¹ Nacelle faired into airfoil.

TABLE IX
 RELATIVE MERITS OF DIFFERENT NACELLE LOCATIONS

Propeller No. 4412, 4 feet. Set 17° at 0.75 R.

Nacelle position	High-speed and cruising condition $\frac{V}{nD}=0.65$ $C_L=0.259$			Climbing condition $\frac{V}{nD}=0.42$ $C_L=0.480$		
	Propulsive efficiency	Nacelle drag efficiency factor	Net efficiency	Propulsive efficiency	Nacelle drag efficiency factor	Net efficiency
	1.....	0.799	0.056	0.743	0.660	-0.022
2.....	.793	.056	.737	.668	-.028	.690
3.....	.800	.071	.729	.675	.000	.675
4 ¹791	.145	.616	.628	.000	.628
5 ¹776	.119	.657	.637	-.005	.642
6.....	.797	.095	.702	.670	-.003	.675
7 ¹787	.147	.620	.674	-.016	.658
8 ¹789	.145	.644	.672	.021	.651
9.....	.810	.109	.701	.673	.000	.673
10.....	.802	.071	.731	.676	-.022	.698
11.....	.815	.056	.759	.688	-.027	.715
12.....	.811	.056	.765	.676	-.027	.703

¹ Nacelle faired into airfoil.