

## REPORT No. 856

# THE NACA HIGH-SPEED MOTION-PICTURE CAMERA OPTICAL COMPENSATION AT 40,000 PHOTOGRAPHS PER SECOND

By CEARCY D. MILLER

### SUMMARY

*The principle of operation of the NACA high-speed camera is completely explained. This camera, operating at the rate of 40,000 photographs per second, took the photographs presented in numerous NACA reports concerning combustion, preignition, and knock in the spark-ignition engine.*

*Many design details are presented and discussed, but details of an entirely conventional nature are omitted. The inherent aberrations of the camera are discussed and partly evaluated. The focal-plane-shutter effect of the camera is explained. Photographs of the camera are presented. Some high-speed motion pictures of familiar objects—photoflash bulb, firecrackers, camera shutter—are reproduced as an illustration of the quality of the photographs taken by the camera.*

### INTRODUCTION

The NACA high-speed motion-picture camera was invented in February 1936 at the Langley Field laboratory because of a demonstrated need for a faster camera than was commercially available for use in the study of spark-ignition engine knock. A detailed design of the camera was prepared during 1936 and 1937. The first working camera was constructed at the Norfolk Navy Yard during 1938, and this camera operated successfully at the first test on December 16, 1938, at Langley Field. Additional cameras have since been constructed according to the same design. Since the first test, the camera has been used by the NACA in the study of combustion and knock in the cylinders of internal-combustion engines, both with spark ignition and compression ignition. During this 6-year period, the camera has given dependable trouble-free service. Some of the photographs taken with the camera during this period have been published in references 1 to 6, and others are not yet published. The high-speed photographs presented in two technical films (references 7 and 8) were also taken with this camera.

The camera has been operated at rates up to 40,000 photographs per second. The camera is probably capable of operating safely at 80,000 photographs per second with only slight modification. Inasmuch as the advantages to be obtained from higher speeds increase only approximately as the logarithm of the speed, it has not appeared worth while to modify the camera for operation at 80,000 photographs per second.

The camera is of the optical-compensator type, in which

the photosensitive film is moved at a constant speed and the successive photographic images are caused to move in the same direction and at the same speed as the film by optical means. When picture-taking rates become so high that it is not practicable to stop the film during the exposure of each photograph, as with the standard type of motion-picture camera, it becomes necessary either to use optical compensation to hold the photographic images stationary relative to the moving film or to expose each photograph by a light flash of such short duration the film does not have time to move appreciably during the exposure.

A very considerable number of optical-compensating devices are known and several of them have been more or less successfully used. The bibliographies presented in references 9, 10, and 11 include literature describing many of the known devices.

In any camera designed to take photographs at very high rates, compromises must be made between various desirable but conflicting characteristics. The principle involved in the NACA high-speed motion-picture camera has been found to allow an exceptionally satisfactory compromise between the following characteristics:

- High optical speed
- High mechanical speed
- Good definition
- Freedom from distortion
- Freedom from blurring due to motion of image with respect to film
- Adaptability to various types of photography and various types of subject matter
- Large number of pictures that can be exposed in one sequence
- Single point of view for all photographs of a sequence
- Possibility of projecting photographs as exposed without reprinting
- Simplicity and ruggedness of construction
- Economy of construction
- Economy in the use of photographic film

The rugged construction and the remarkable simplicity of the camera assure years of trouble-free operation. Inasmuch as the camera has only one moving part, a rotating drum, there is no possibility of wear except in the easily replaceable ball bearings that support the rotating drum. Barring accident, the useful life of the camera is therefore indefinitely long.

The present paper completely explains the principle of operation of the camera and design details that are of special interest but does not include design details that are of a conventional nature. Some miscellaneous examples of photographs taken with the camera are presented.

**DESIGN DETAILS**  
**OPTICAL SYSTEM**

**Over-all view of optical system.**—The NACA high-speed motion-picture camera operates on the optical-compensator principle; the photosensitive film is kept continuously in motion and the photographic images are moved with the film by optical means in such a manner that each image remains stationary relative to the film during the time of its exposure.

A cross section of the camera exposing the optical system is shown in figure 1. The optical elements that impart mo-

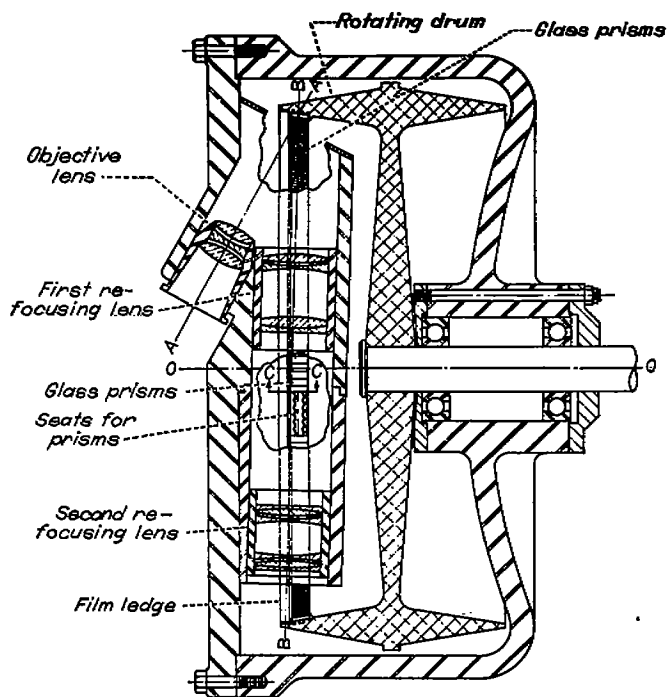

FIGURE 1.—Cross section of optical system of NACA high-speed motion-picture camera.

tion to the photographic images are glass prisms, which will be explained in detail later. These prisms, each constituting essentially a pair of mirrors, are arranged in a continuous row around the inner surface of a rotating drum as shown in figure 1, at a radius slightly less than 9 inches. The photosensitive film is carried on the inner surface of the same rotating drum, alongside the glass prisms. The film is at the outermost edge of the drum, the prisms being placed farther inward so that their centrifugal force will impose a smaller cantilever stress on the drum ledge. The drum with its shaft, prisms, and photosensitive film constitutes the only moving part of the camera.

The camera has three stationary lenses, mounted on the axes AA and BB, as shown in figure 1. The axes AA and BB and the axis of rotation OO of the drum are all in a single

plane. Each of the glass prisms carried by the drum passes across the intersection of axes AA and BB as the drum rotates. The axis BB passes through the photosensitive film on the side of the rotating drum opposite the point where that axis passes through the glass prisms, that is, opposite the point of intersection of axes AA and BB.

The objective lens forms a primary image of the object that is to be photographed at the point of intersection of axes AA and BB. Each of the glass prisms, as it passes through this point of intersection, reflects the light beam coming from the objective lens. The reflected beam passes through the first and second refocusing lenses, which form a secondary image on the photosensitive film every time a glass prism crosses the intersection of axes AA and BB.

Each of the glass prisms not only reflects the light beam but imparts a translatory motion to it, and the two stationary refocusing lenses shown in figure 1 modify the motion of the light beam in such a manner that the images formed on the moving film are stationary relative to that film. Each glass prism translates the reflected beam in a direction normal to the axis of the beam without appreciable rotation of the beam about any axis. This translatory motion imparted to the reflected beam by the glass prism is in the same direction as the motion of the prism itself and is twice as fast as the motion of the prism. Because of the translatory motion imparted to the reflected beam, if the primary image formed by the objective lens is observed by the light of the reflected beam that image will have the appearance of moving in the same direction as the prism and twice as fast. Inasmuch as the two refocusing lenses and the photosensitive film "see" the primary image by the light of the reflected beam, they will treat the primary image in all respects as if it actually were moving in the same direction as the glass prism and twice as fast. The secondary image, formed on the photosensitive film by the refocusing lenses, is inverted with respect to the primary image as seen by the light of the reflected beam, inasmuch as no image is formed between the two refocusing lenses to cause a double inversion. For this reason, the secondary image moves in the direction opposite to the motion of the primary image as seen by the light of the reflected beam, or in the same direction as the photosensitive film on which the secondary image is formed.

With the optical system treated for the present as if the emulsion on the photosensitive film and the intersection of axis AA with axis BB were equidistant from the axis of rotation OO of the drum, the focal lengths of the two refocusing lenses are so chosen and their positions along the axis BB are so adjusted that the secondary image falling on the photosensitive film is half as large, in any linear dimension, as the primary image formed by the objective lens. The secondary image, being half as large as the primary image, moves half as fast as the primary image. If the speed of the photosensitive film is designated  $v$ , then the speed of the glass prisms is also  $v$ ; the speed of the primary image as viewed by the light of the reflected beam is  $2v$ ; and the speed of the secondary image is  $\frac{1}{2} \times 2v = v$  or the same as the speed of the photosensitive film.

Because of drum-stress considerations, the glass prisms were placed slightly closer to the axis of rotation OO than was the supporting ledge for the photosensitive film. For this reason, in order to make the speed of the secondary image equal to the speed of the emulsion on the photosensitive film, it was necessary that the size of the secondary image be made very slightly greater than half the size of the primary image. By a careful trial-and-error adjustment of the positions of the two refocusing lenses along the axis BB, it has been possible to make the speed of the secondary image very closely the same as the speed of the photosensitive emulsion so that the secondary image remains stationary with respect to the emulsion throughout the time of exposure.

In any case where the object being photographed is moving steadily in a single direction, the secondary image of the moving object can be made stationary with respect to the photosensitive film. In such a case the camera is so oriented that the motion of the object, as seen in the primary image formed by the objective lens, is in the same direction as the motion of the glass prisms. By an appropriate readjustment of the positions of the first and second refocusing lenses, the secondary image of the moving object can be made stationary with respect to the moving film. With the refocusing lenses adjusted in this manner, any stationary object would appear somewhat blurred in the photographs produced on the photosensitive film; only the steadily moving object would appear sharply defined.

Physical form and manner of mounting of the optical-compensating elements.—One of the glass prisms that reflect and impart motion to the light beam in the camera is shown in three views in figure 2. Use of an optical-compensating element of this type, but in a different manner, was proposed in 1898 by Mortier (reference 12) and the element has been used in other designs since that time (references 13 to 16). Faces D, G, and H of the prism are optically polished and faces G and H are coated with an aluminum film for back-surface reflection. Faces E and F and the prism ends J and K are rough-ground. The manner of mounting the glass prisms in the rotating drum is made clear in figures 3 and 4.

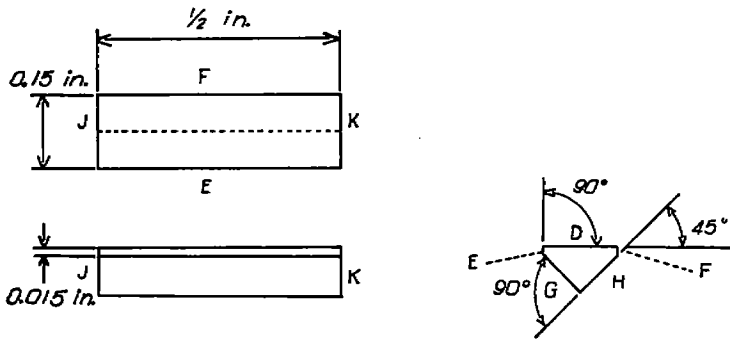

FIGURE 2.

sating element of this type, but in a different manner, was proposed in 1898 by Mortier (reference 12) and the element has been used in other designs since that time (references 13 to 16). Faces D, G, and H of the prism are optically polished and faces G and H are coated with an aluminum film for back-surface reflection. Faces E and F and the prism ends J and K are rough-ground. The manner of mounting the glass prisms in the rotating drum is made clear in figures 3 and 4.

Figure 3 is an enlarged sketch of section C-C from figure 1, with an auxiliary view of a portion of the drum, the auxiliary view having the conventional relationship to the sketch

of section C-C. Both the section C-C and the auxiliary view are drawn with only one glass prism installed. Figure 4

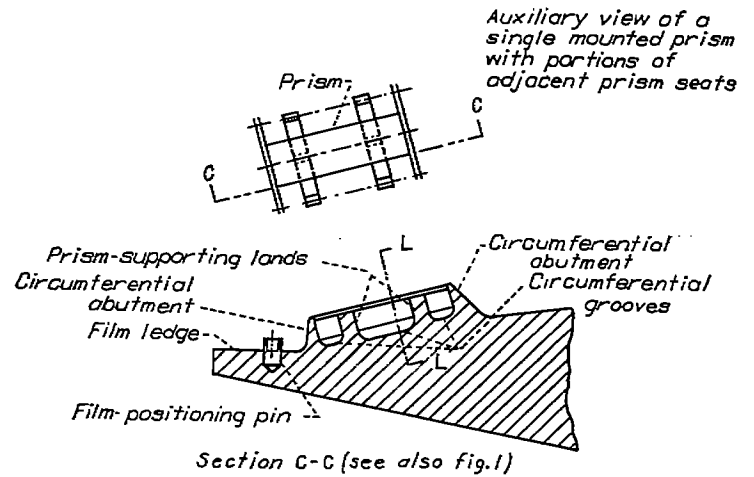
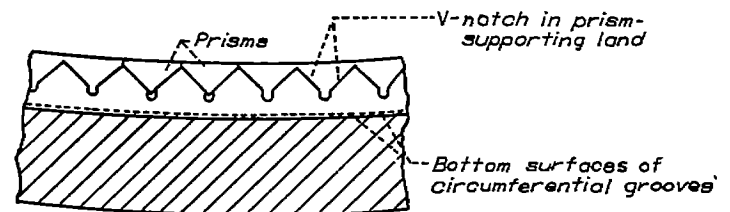

FIGURE 3.

is an enlarged sketch of section L-L from figure 3, showing the V-notched prism-supporting land with two of the glass prisms in place.

The details of the seats for the glass prisms (figs. 3 and 4) can probably best be explained in terms of machining operations. In the turning of the drum a land, a little more than 1/2 inch wide, was provided around the inner surface of the drum in order that the prism seats would not have to be cut into the body of the drum, weakening it in the cantilever sense. The three circumferential grooves indicated in figure 3 were then turned by cutting into the 1/2-inch-wide land. After these three grooves were turned, all that remained of the 1/2-inch-wide land were the two circumferential abutments and the two prism-supporting lands indicated in figure 3. The next, and final, machining operation was the milling of V-shaped notches in each of the two prism-supporting lands, as shown in figure 4.



Section L-L, fig. 3

FIGURE 4.

After the machining operations were completed and the drum was balanced and mounted, the glass prisms were inserted in the V-shaped notches in the prism-supporting lands in the manner shown in figures 3 and 4. Each prism was placed with one end in contact with the circumferential abutment nearer the film ledge in order to oppose the component of centrifugal force tending to cause the prisms to slide lengthwise in their supports.

The two prism-supporting lands were so positioned that the maximum bending stress in the glass prisms at the two points of support would be equal to the maximum bending stress in the prisms at a point halfway between the two points of support. This arrangement produced the lowest maximum stress possible with two points of support.

In one mounting of the prisms in the drum, each prism was simply laid in position in the V-notches and kept there by the compression of a very small neoprene disk. The neoprene disk was cemented to one end of the prism and was compressed between the prism end and the circumferential abutment farther from the film ledge. In another mounting the neoprene disk was eliminated and each prism was cemented in its V-notch.

Some optical features of the compensating element.—A prism of the type shown in figure 2 has a number of well-known characteristics that must be borne in mind in any study of the optical system of the camera. The most important of these characteristics is the one illustrated in figure 5. In this figure a prism, without the faces E and F

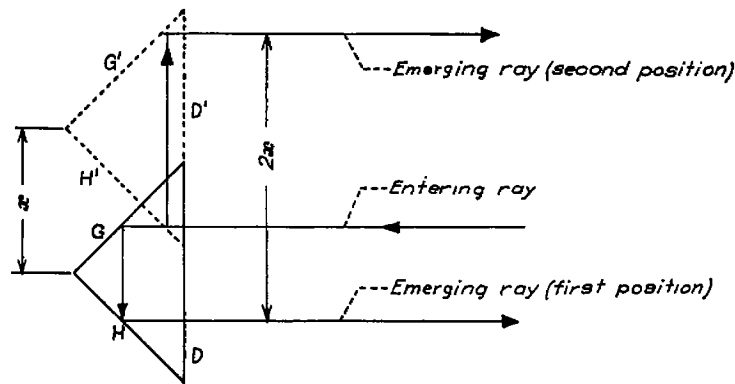

FIGURE 5.

that were included in figure 2, is shown in two positions: the first position represented by the full lines, with prism faces designated D, G, and H; and the second position represented by the dashed lines, with prism faces designated D', G', and H'. A stationary entering ray of light is shown in the same position for both prism positions. With the first prism position, the entering ray is reflected first from prism face G, then from prism face H, thence out of the prism. With the prism in the second position, the entering ray of light first strikes prism face H', then face G', and thence out of the prism. As can easily be shown by simple geometric principles, the separation between the emerging rays for the two prism positions is always equal to  $2x$  where the separation between the two prism positions is  $x$ . It is therefore apparent that the emerging ray receives a translatory motion in the same direction as the prism motion and at twice the speed of the prism. It is this effect that imparts a translatory motion to the primary image in the camera as seen by the light of the reflected beam.

In figure 5, the ray of light is shown following two different courses through the prism: In the first course the ray strikes

face G before it strikes face H; in the second course, face H before face G. The reversal of the course occurs at the instant the intersection of faces G and H crosses the entering ray. There is no break in the velocity of translation of the emerging ray at the instant this reversal of the course occurs.

Figure 6 illustrates the formation of a double image resulting from the inevitable inaccuracy in the  $90^\circ$  dihedral

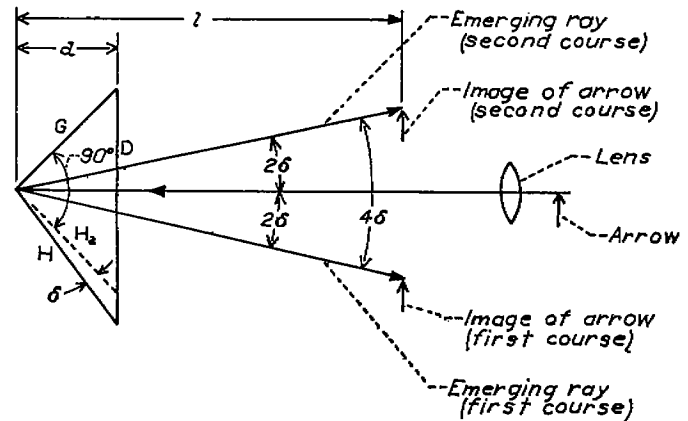

FIGURE 6.

angle of the glass prism. An objective lens is shown that is assumed to be focusing a primary image of an arrow, the primary image not occurring, however, within the glass prism but in the reflected beam at a distance  $l$  from the prism. Only one ray of light is shown passing from the point of the arrow through the objective lens and into the glass prism. The prism is shown with an angle of  $90^\circ + \delta$  between faces G and H, attainment of a perfect  $90^\circ$  angle being a practical impossibility. The position of face H for an accurate  $90^\circ$  angle is shown by the dashed line  $H_0$ . Two emerging rays are shown. The upper emerging ray is based on the assumption that the entering ray first struck face H at an infinitesimal distance below the intersection of faces G and H, and then struck face G and was reflected out of the prism. The lower emerging ray is based on the assumption that the ray followed the opposite course through the prism, first striking face G at an infinitesimal distance above the intersection of faces G and H. As can readily be shown, the two emerging rays diverge by an angle of  $4\delta$  and two images of the arrow will therefore be found with a separation between them equal to  $4l\delta$ . This treatment has ignored the refractive effect of face D of the prism. In cases where  $l$  is large compared with the prism depth  $d$ , as shown in figure 6, taking the refractive effect into account increases the separation between the two images from  $4l\delta$  to approximately  $4nl\delta$  for small values of  $\delta$ ,  $n$  being the index of refraction. The separation  $4nl\delta$  occurs also if the primary image is focused in the entering beam before the light reaches the intersection of faces G and H. Because of the separation of the images formed by light following the two different courses through the prism,  $4l\delta$  must be made as small as possible by making  $l$  as small as possible; that is, by focusing the primary image as nearly as possible at the line of intersection of faces G and H of the prism.

The characteristic of the optical-compensating element illustrated in figure 7 makes clear why the incident and reflected beams in the camera had to lie in a plane normal to the direction of motion of the prisms rather than in a plane containing the line of motion of the prisms. In this figure an entering ray is shown making an angle with a normal to the face D. The emerging ray can easily be shown to be parallel to the entering ray. With a 90° angle between prism faces G and H, it is not possible to form an angle between the entering and emerging rays if the two rays form a plane containing the line of motion of the prism, that is, the plane of the paper in figure 7.

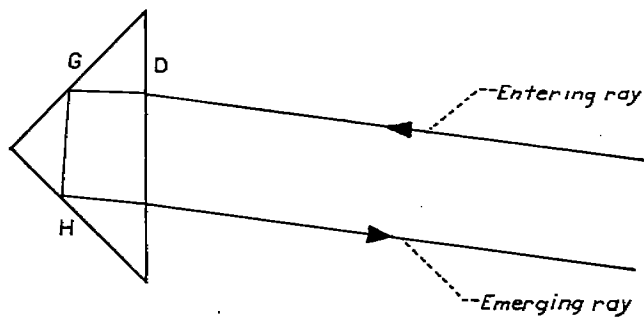

FIGURE 7.

The entering and emerging rays are, of course, displaced from each other laterally. In a practical case this lateral displacement could be used to separate the incident and reflected beams, that is, to cause the reflected beam to pass through the refocusing lenses rather than to go back into the objective lens, only if the prism were very large relative to the lens dimensions. The large size of the prism would reduce the picture-taking rate to a small fraction of that actually obtained.

In figure 8 appears a two-view sketch of the reflection of a

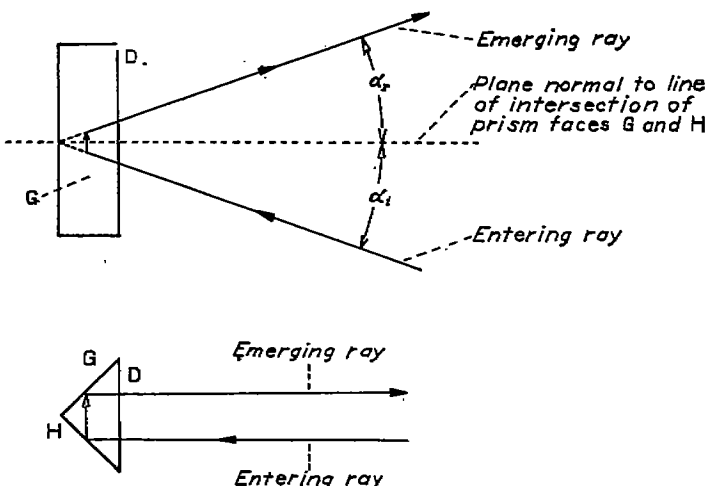

FIGURE 8.

light ray entering the prism at a considerable angle to a plane that is normal to the line of intersection of prism faces G and H. Although in the lower view of figure 8 the entering and emerging rays are only laterally displaced from each other, in the upper view they make an angle with each other. In the upper view the angle of incidence is equal to the angle of reflection as measured from the plane normal to the intersection of prism faces G and H. It is this angular displacement that is used to separate the incident from the reflected beam in the camera.

Figure 9 illustrates the need for the two rough-ground and black-painted prism faces E and F. As objective lenses of large aperture are sometimes used in the camera, some light rays make a rather considerable angle with the normal to the prism face D. Without the side faces E and F some of these oblique rays may, as shown in the upper view of

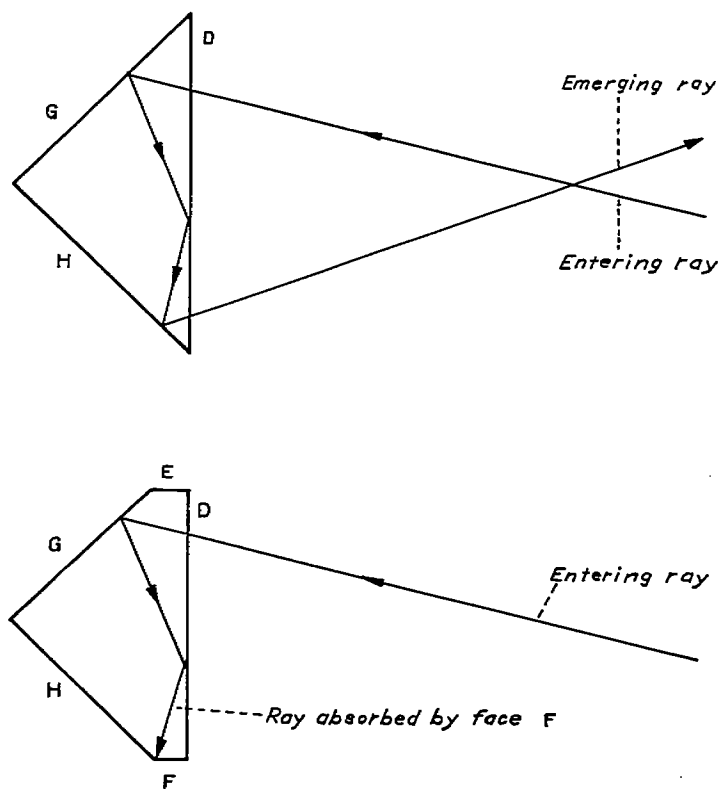

FIGURE 9.

figure 9, reflect from face G to face D to face H and thence out of the prism to the wrong place on the photosensitive film. With the type of prism actually used in the camera, as shown in the lower view of figure 9, such an oblique ray reflects from face G to face D to face F and is there absorbed. The side faces E and F also have the effect of materially thickening the prism and thereby increasing its resistance to bending stress caused by centrifugal force.

Figure 10 illustrates the nearly nil effect of rotating the prism about the line of intersection of faces G and H. Whether the prism is in the full-line position with faces D, G, and H, or in the dashed-line position with faces D', G', and H', the emerging ray comes out of the prism along the same line, if the refracting effect of face D is neglected. The refracting effect of face D actually imparts a slight

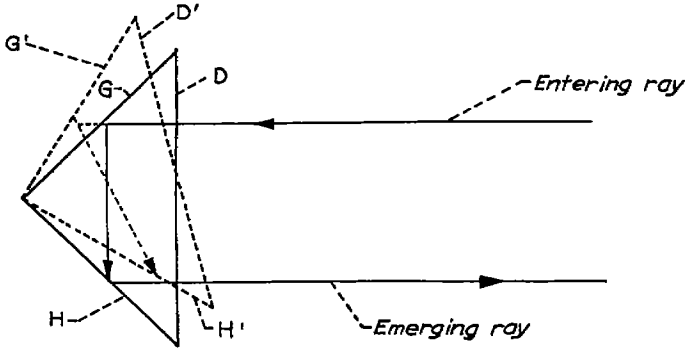

FIGURE 10

motion to the primary image as seen by the reflected beam, as the prism rotates, in the same manner as with the rotating prism of the camera described in reference 17. This motion only alters slightly the reduction ratio required between the primary and secondary images in the camera. The motion is not quite linear with the angular displacement of the prism, but the total angle throughout which the prism rotates during the exposure of the photograph is so small that the departure from linearity is an unimportant effect.

A rotational characteristic of the glass prism that must be considered in a study of the optical system of the camera is

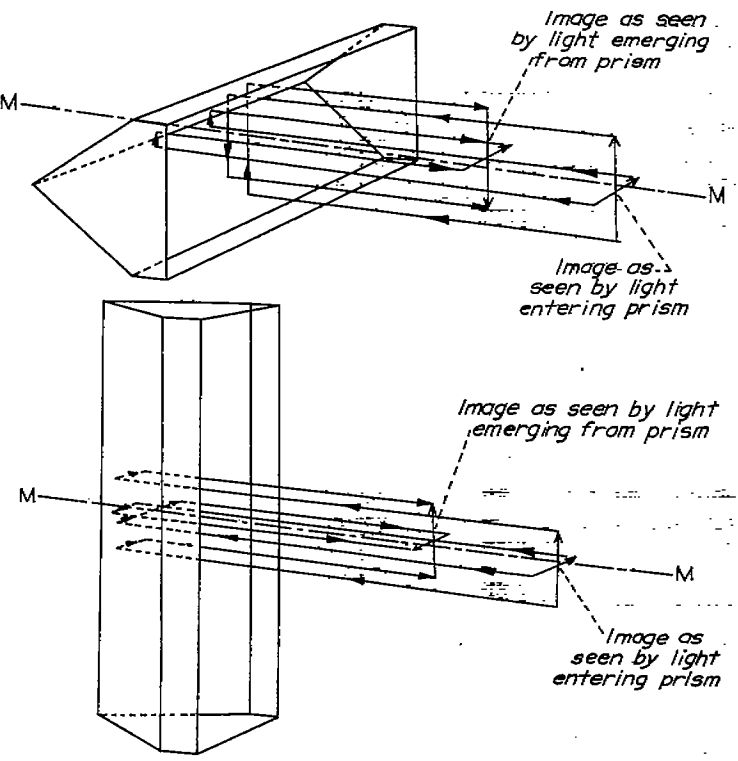

FIGURE 11.

illustrated in figure 11. This figure shows the prism in two positions rotated from each other through an angle of 90° about the axis MM. A hypothetical image is shown as seen in the beam entering the prism and in the beam leaving the prism, for both the first and second prism positions. Although the image as seen in the entering beam is the same for both prism positions, the image as seen in the emerging beam is rotated through 180° by the 90° rotation of the prism. Just as translatory motion of the prism in the proper direction imparts translatory motion to the reflected beam in the same direction and at twice the speed, rotation of the prism about the axis MM imparts rotation to the reflected beam in the same direction and with twice the angular velocity. This effect must be considered in a study of the optical system of the camera because there is a small component of rotation of the prism about the axis MM during the exposure of the photograph.

A final characteristic of the glass prism that is necessary to a complete understanding of the camera is its effect of inverting the reflected beam of light. The beam is inverted about a neutral plane containing the axis MM and the 90° prism-face intersection, as shown in the upper view of figure 11. It is fundamentally this property of inversion of the reflected beam about a neutral plane, the neutral plane moving with the prism at the same speed as the prism, that causes the reflected beam to receive a motion of translation in the same direction and at twice the speed of the prism. Any optical element that either reflects or transmits a beam of light, and at the same time inverts that beam about a neutral plane fixed with respect to the optical element itself, will have the same effect of imparting translatory motion to the reflected or transmitted beam. An example of a transmitting element that produces this effect is shown in figure 12.

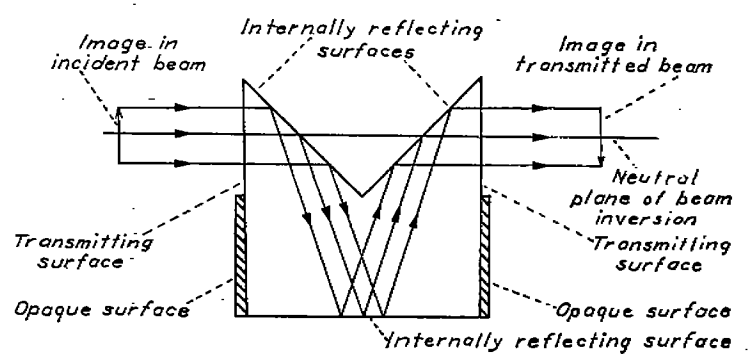

FIGURE 12.

It should be understood that the beam-inverting effect of the prism used in the camera is not the same as the right-to-left inversion commonly thought to exist with ordinary plane mirrors. With normal incidence the ordinary plane mirror does not actually invert the light beam either from right to left or from top to bottom. What it actually does is only to reverse the direction of the beam, or to invert the beam from front to back. The neutral plane of the inversion is the plane of the mirror surface itself. In a camera with a single

plane mirror interposed between the lens and the film, inasmuch as only one inversion of the beam occurs, from front to back with normal incidence, a mirror image is produced on the film if the image is viewed in the conventional manner from the back side of the film. With the camera here under discussion, however, there are always two reflections and two inversions. The reflected beam is not only inverted from front to back but also from top to bottom. The image produced on the film is consequently a true image of the object as in a conventional camera, not a mirror image.

**Lenses used in the camera.**—Many different lenses have been used in the camera as objectives. Once the two refocusing lenses are properly adjusted, the objective lens may be changed at will without any need of altering the adjustment of the refocusing lenses. It is only necessary that the objective lens be adjusted to form a primary image at the intersection of axes AA and BB. (See fig. 1.)

The design of the camera places a limitation on the back focus of the objective lens, in that the objective lens must not physically interfere too much with the light beams reflected from the moving prisms. The design also places a limitation on the usable relative aperture of the objective lens. This limitation on relative aperture is twofold: first, the physical limitation due to selection of the smallest feasible angle, about  $27^\circ$ , between axes AA and BB; second, the limited capacity of the apertures of the refocusing lenses to transmit the light from a large-aperture objective.

The lower limit of back focus is about 1 inch, with a relative aperture of  $f/3$ . A lens meeting these specifications would require a special mounting such that almost the entire diameter of lens and mount would be useful aperture. The objective lens actually used for all the schlieren photographs of combustion and knock presented in references 1 to 6 was a plain cemented doublet with a back focus of  $2\frac{1}{2}$  inches and a relative aperture of about  $f/5$ . The high-speed motion pictures that will be presented in this report were taken with a more highly corrected photographic objective having a focal length of 5 inches and a relative aperture of  $f/3$ .

No very definite formula can be set for selection of the two refocusing lenses, which must be well-corrected photographic lenses with undistorted fields. If only one refocusing lens had been used, instead of two, its aperture would have had to be very much larger than the apertures of the two refocusing lenses that were actually used, in order to transmit all the light received via the moving prisms from the objective lens. The larger diameter for the single lens would have been undesirable for two reasons: first, because such large lenses are much more difficult to obtain commercially than the smaller lenses; second, because the larger diameter would have required a wider rotating drum, creating greater cantilever stresses.

A further advantage of using two refocusing lenses is that commercially available lenses may be used with approximately the conjugate foci for which they were designed, that is, infinity and the principal focus. A lens was chosen as the first refocusing lens having a focal length approximately twice that of the second refocusing lens. (See fig. 1.) With this combination of focal lengths, the necessary ratio of 2

between the size of the primary image and that of the secondary image was obtained approximately with the primary image at the principal focus of the first refocusing lens and the secondary image at the principal focus of the second refocusing lens. The first refocusing lens, consequently, forms a virtual image at infinity, and the second refocusing lens uses this virtual image at infinity as its object. The first refocusing lens is used backward in the sense that the light passes through it in the opposite direction to the conventional. It is used in the correct manner, however, inasmuch as the near focus is on the correct side of the lens.

After a decision was made that two refocusing lenses should be used, the first having approximately twice the focal length of the second, an infinite number of combinations of focal lengths still remained. In the selection of a combination from the infinite number of possible combinations, a number of factors had to be taken into account. First calculations were made on the basis of the apertures required to transmit all light from the 5-inch-focal-length,  $f/3$  objective. It was found that with short focal lengths of the refocusing lenses, the aperture of the second refocusing lens had to be unreasonably large and that with long focal lengths the aperture of the first refocusing lens had to be large. The greater commercial availability of short-focal-length lenses with small f-numbers than of long-focal-length lenses with small f-numbers had to be considered. The relative qualities of definition of the available lenses of different f-numbers were important.

In the earliest operation of the camera a first refocusing lens of 7-inch focal length and  $f/3$  relative aperture was used; the second refocusing lens was of  $3\frac{1}{2}$ -inch focal length and  $f/1.5$  relative aperture. This combination, according to calculations, would transmit all the light that passed through the 5-inch,  $f/3$  objective lens except the unavoidable losses from absorption and reflection at glass-air surfaces. These lenses did not prove to have good enough definition and, inasmuch as the available light proved to be more than ample, a decision was made to sacrifice aperture in favor of definition. A 7-inch-focal-length and a  $3\frac{1}{4}$ -inch-focal-length Bausch and Lomb Cinephor lens, each of about  $f/2.9$  relative aperture, were obtained and these lenses have been used as first and second refocusing lenses throughout the past 5 years. The light transmission has been adequate for the taking of the schlieren photographs presented in references 1 to 6, with 100- to 500-watt incandescent projection lamps. The definition has been quite adequate for the scientific purposes for which the camera was intended and has been used.

**Photosensitive film.**—The camera was designed to use standard single-width 8-millimeter motion-picture film, perforated on one side only. The film is placed around the inside of the rotating drum by hand, through a 4-inch-diameter hand hole in the camera casing. The film is held about the inner edge of the drum by aluminum-alloy pegs pressed into holes in the inner surface of the drum, one peg for every 12 perforations in the film, 31 pegs in all. When the film is mounted in the drum, it usually tends to loop away from the drum between some of the pegs, the amount

of looping depending on the humidity. When the drum is rotated at the operating speed of 6500 rpm, however, centrifugal force seems to be adequate to eliminate the loops. The film is mounted with about 1-inch overlap and care is taken that the trailing end of the film laps over the leading end rather than vice versa. The backing of the trailing end is moistened to cement the ends together temporarily.

No attempt has been made at any time to obtain special films for the camera, as the faster commercially available panchromatic films have proved adequate.

**Aberrations and defects of the optical system.**—In all known optical-compensator cameras, designed to operate at speeds comparable with that of the camera being described here, some sacrifices of image quality in favor of speed have been necessary. The aberrations of the NACA high-speed camera will be listed here but only partly evaluated. The definition of the photographs has been adequate for the scientific purposes for which the camera was intended in spite of all the aberrations. The quality of the definition may be judged visually by observation of the photographs of references 1 to 6 or of the photographs presented in this report. Considerable clarity is, of course, unavoidably lost in the printed reproductions.

The aberrations and defects of the optical system of the camera are as follows:

1. With three lenses used in series, the inherent defects are almost entirely additive. If specially designed lenses were used, it might be possible to use elements of one of the refocusing lenses to compensate distortions of the other refocusing lens, with a consequent reduction in the total number of lens elements in the camera and an improvement over its present condition. The series of three lenses, however, could never be made as good as a single lens. With the three commercial lenses actually used in the camera, the diameters of the circles of confusion of the three lenses can probably be added together to find the circle of confusion of the combination, the diameter of the circle of confusion being expressed in each case as a fraction of the image width.

2. The two refocusing lenses, and to a lesser degree the objective lens, are of longer focal length than would be used in a conventional 8-millimeter camera. The longer focal-length lenses, in general, have larger circles of confusion than lenses of the same relative aperture and shorter focal length.

3. Any curvilinear distortion introduced by the two refocusing lenses, unless the distortions are mutually compensating, will not merely produce curvilinear distortion in the photographic image but will cause a blurring of the photographic image. The blurring is caused by the fact that both primary and secondary image move across the fields of the first and second refocusing lenses, respectively, during exposure.

4. The glass prisms and also the photosensitive film are not actually moved in a straight line across the light beam but on the arc of a circle. This defect could be largely corrected by the designing of special curved-field lenses for use as refocusing lenses. This defect adds about 0.0007 inch to the circle of confusion in the final image or about 0.5 percent of the height of a frame on the 8-millimeter film.

5. As explained, the primary image must be formed at the intersection of faces G and H of the glass prism in order to avoid doubling of images due to inaccuracy of the 90° prism angle. (See fig. 6.) However, inasmuch as the axis of the objective lens AA (fig. 1) cannot be made perpendicular to the intersection of prism faces G and H, it is not possible for all parts of the primary image to focus at the intersection of prism faces G and H. The 90° angle of the prisms used in the camera was held within a tolerance of  $\pm 15'$ . The angle between the lens axis AA and the prism-face intersection is about  $76\frac{1}{2}^\circ$ . With the primary-image width of 0.4 inch, the maximum doubling of the image amounts to 0.0007 inch in the primary image and 0.00035 inch in the secondary image or about 0.23 percent of the height of the frame.

6. The glass prisms are set in the rotating drum at an angle of 15° with the axis of rotation of the drum. This angularity of the prism setting introduces a component of rotation of the prism about the axis MM (fig. 11), which causes the image to rotate on the film during exposure. Expressed in another but less adequate manner, this aberration is caused by the fact that parts of the prism, being at a greater distance from the axis of rotation, are moving faster than other parts and will therefore impart a faster motion to the reflected light beam. The maximum effect of this aberration is about 0.0016 inch in the primary image and about 0.0008 inch in the secondary image, or about 0.5 percent of the frame height.

7. Some light is reflected from both sides of face D of the glass prisms. (See fig. 2.) No translatory motion is imparted to this light and it therefore forms a blurred stationary image on the photosensitive film. This stationary image produces smeared streaks on the film if the light intensity is so great as to overexpose the optically compensated image. In all cases where the optically compensated image was not overexposed, the smear caused by the reflection from prism face D has not been noticeable. This defect could be largely overcome by applying antireflection coatings to the prism faces D, but the defect has not been sufficiently troublesome to justify this measure.

8. The photosensitive film makes an angle of about 2° with the axis BB at the point where this axis passes through the film. This angle causes a difficulty in focusing the secondary image sharply over its entire area. This difficulty has been almost entirely overcome by mounting the second refocusing lens with its optical axis at an angle of about 2° with the axis BB (not as shown in fig. 1) so that the optical axis of this lens is perpendicular to the surface of the film. The means of adjusting the position of the second refocusing lens along the axis BB is such that the intersection of the lens axis with the axis BB is always at a point halfway between the nodal points of the lens. The nodal points in the lenses used are very close together.

9. The exposure time for any point within the photographic image is equal to the reciprocal of the picture-taking frequency; that is, when the exposure of a point is completed in one frame, the point immediately begins to be exposed in the next succeeding frame. It has been pointed out repeatedly (references 11 and 18) that for scientific purposes the exposure time should be only a small part of the total time



between successive frames. The exposure time for any point within the image could have been reduced in this camera by reducing the size of the cross section of the prisms and mounting the prisms in the drum with blackened spaces between them. Any great reduction in cross section, however, would seriously weaken the prisms and would make them very difficult to manufacture. The only feasible way to reduce the ratio of exposure time to the total time between successive frames would therefore be to reduce the picture-taking rate of the camera without changing the prism design; that is, simply to remove alternate prisms from the camera drum, or to remove two prisms out of every three, and so on. The fact that the long relative exposure time has not been fatal to the successful scientific use of the camera is evidenced by the work of reference 6. In this reference, the type of knock commonly encountered in the spark-ignition engine is shown to be a self-propagating disturbance traveling at the speed of a detonation wave. This fact could not have been shown from the photographs if the picture-taking rate had been materially reduced in order to reduce the ratio of exposure time to total time between frames.

10. The camera does not have a framing mechanism, that is, a provision to prevent one photograph from covering such a wide field of view that it overlaps the next succeeding photograph. The absence of a framing device is not a serious disadvantage in a camera operating at 40,000 frames per second because the objects outside the intended field of view are rarely lighted intensely enough to photograph at this speed. In the rare cases where necessary, an external framing shield may be erected between the camera and the object to be photographed.

**Focal-plane-shutter effect.**—The focal-plane-shutter effect of the camera might be listed as an aberration, but is of greater importance than any of the other aberrations. It has been necessary to use the conclusions developed herein concerning the focal-plane-shutter effect in the determination of knock-detonation-wave speeds in reference 6.

The conventional type of focal-plane shutter used in a high-speed "still" camera consists of a sort of window blind, which is rapidly rolled from one roller to another at the time of snapping the photograph. The expanse of window blind between the two rollers at each instant is slightly larger than the area to be exposed on the film and is in a plane almost in contact with the photosensitive emulsion of the film, between the film and the lens. The window blind has a transverse slit, usually of adjustable width, which moves rapidly across the film as the window blind passes from one roller to the other. The moving narrow slit allows light to pass through to the film and provides a very short exposure time for each individual point in the picture. The shutter has the disadvantage, however, that different parts of the photograph are exposed at different times.

The focal-plane shutter has two undesirable effects if there are any motions in the objects being photographed, provided that the motions as seen in the photographic image are of a velocity comparable with the velocity of the slit of the focal-plane shutter. The first of these effects is

distortion of a moving object; the second is falsification of the velocity of a moving object. Peculiarly, in spite of these effects the focal-plane shutter does not distort the recorded path of a moving point.

Each of the prisms in the NACA high-speed camera acts as the moving slit of a focal-plane shutter as it moves across the light beam approximately in the plane of the primary image formed by the objective lens. The focal-plane-shutter effect of the prisms is illustrated in figure 13. In this figure view 1 is an end view of some of the prisms, shown only for the purpose of assisting the reader to orient views 2 and 3 of the figure. Views 2 and 3 are taken with the prism face D (see fig. 2) in the plane of the paper and should be understood to represent one and the same view of the same prisms in the same position. The only difference between the two views is that view 2 shows a stationary primary image  $I_1$  formed by the incident light on the prism from the objective lens, whereas view 3 shows the three moving images  $I_1$ ,  $I_2$ , and  $I_3$ , formed by prisms  $P_1$ ,  $P_2$ , and  $P_3$ , respectively, as seen by the light of the reflected beam.

With the fact in mind that each prism inverts that portion of the light beam incident upon it about the prism center line, it will be understood that the image as seen by the light of the reflected beam will be split into three parts as shown by the black portions of the images in view 3. When each of these three parts of the image is used as a basis for construction of a complete dashed-line image, as has been done in view 3, the resulting three images are contiguous. These resulting three images have been designated images  $I_1$ ,  $I_2$ , and  $I_3$  in the figure, according to their formation by prisms  $P_1$ ,  $P_2$ , and  $P_3$ , respectively. Inasmuch as each prism transports its corresponding image a distance equal to two prism widths when the prism itself moves a distance equal to one prism width, it is a necessary condition that the prism width be exactly half the image height if both successive prisms and successive moving images are to be contiguous. If either the prisms are made larger, or the images are made smaller, the series of moving images will have blank spaces between them.

The actual velocity of prism motion in views 1 and 2 has been assumed upward. This actual prism velocity is indicated, above view 2, as  $V_a$ . In view 3 the velocity  $V_i$  of the moving images is indicated to be in the same direction as and at twice the speed of the absolute velocity of the prisms. The velocity  $V_r$  of the prisms relative to the moving images of view 3 is, as shown in figure 13, downward at half the speed of the moving images. A little study of figure 13 is sufficient to show that as each prism moves upward across the stationary image of view 2 that same prism moves relatively downward across its moving image in view 3, making all parts of the moving image visible from top to bottom, successively.

It is evident, in view 2 of figure 13, that the trailing edge of prism  $P_1$  coincides with the leading edge of prism  $P_2$ , and that the trailing edge of prism  $P_2$  coincides with the leading edge of prism  $P_3$ . When the motion of the prisms relative to the moving images is considered in view 3, however, it is found that the trailing edge of prism  $P_1$  is separated from the leading edge of prism  $P_2$ , and that the trailing edge of prism

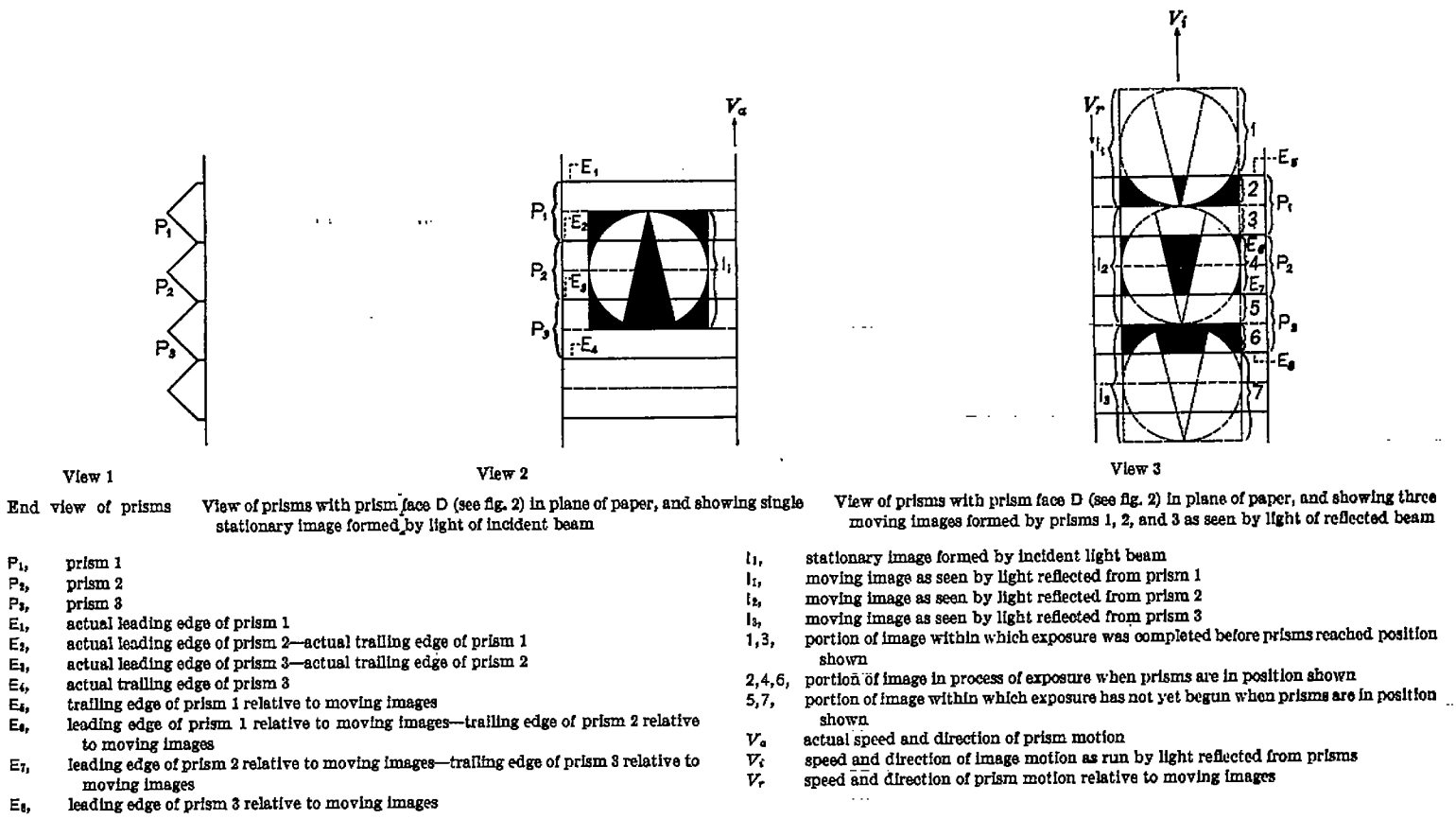

FIGURE 13.—Illustration of focal-plane-shutter effect in NACA high-speed motion-picture camera.

$P_2$  is separated from the leading edge of prism  $P_3$  by a distance equal to two complete prism widths, or a distance equal to the height of one of the moving images. For this reason, when any point ceases to be exposed in one frame it immediately begins to be exposed in the next succeeding frame on the film. The conclusions reached from a study of figure 13 and used in reference 6 may be summarized as follows:

1. Each moving prism produces one independent moving image.
2. Each moving prism acts as a focal-plane-shutter slit in the exposure of its image.
3. The focal-plane-shutter slit width has half the height of the image if the moving images are contiguous.
4. The motion of the focal-plane-shutter slits relative to the moving images is at half the speed and in the opposite direction.
5. The direction of motion of the focal-plane-shutter slits relative to the moving images is away from the previously exposed frames toward the frames that are yet to be exposed.
6. At any instant the trailing edge of the focal-plane-shutter slit in one photographic image is in the same relative position as the leading edge of the focal-plane-shutter slit in the next succeeding image.

**ROTATING-DRUM DESIGN**

The rotating drum, as seen in cross section in figure 1, consists essentially of a central tapered disk with two overhanging tapered ledges machined integral with the periphery

of the disk. The outside diameter of the drum is  $19\frac{1}{4}$  inches. The tapered drum ledges were the result of an attempt to transmit a portion of the centrifugal force of the drum to the disk by means of cantilever loading. The purpose of the idle ledge, on the opposite side of the central disk from the optical system, was to balance the cantilever bending moment of the utilized ledge. In this manner, warping of the central disk is avoided, and such cantilever load as the ledges actually transmit to the periphery of the disk is a purely radial load.

The overhang of the drum ledges is so great that the advantage obtained by the elaborate design is slight. The attempt to utilize cantilever stress in the drum ledges accomplished an estimated 25-percent reduction in the maximum stress as compared with a drum of the same diameter in which the centrifugal force is carried by the tangential stress of the drum alone. The bursting speed was increased an estimated 15 percent by the utilization of the cantilever stress.

The method used for designing the drum was entirely a matter of cut-and-try and is not believed to be sufficiently pertinent to present in this paper.

The drum was forged to a shape providing  $\frac{1}{8}$  inch of excess metal all around, then machined. The material was 14S-T aluminum alloy, having a yield stress of 65,000 pounds per square inch. The calculated maximum stress at the operating speed of 6500 rpm is approximately 7000 pounds per square inch. The calculated speed for yield of the drum material is therefore about 18,000 rpm or about 110,000 frames per second.

**PHOTOGRAPHIC VIEWS OF CAMERA**

Figure 14 is a photograph of the entire camera, stand, and electrical control box. The cast armor-steel drum housing, the direct-current, direct-connected driving motor, and the tachometer magneto are bolted to a structural steel framework, which is laid inside a larger structural framework. The larger structural steel framework is welded to the legs and leg braces, thus forming a rigid stand. Positioning bolts are provided in the outer structural steel framework, the inner ends of the bolts seating against the inner structural steel framework. The positioning bolts are used for the finer adjustments of camera position and orientation.

The shutter shown in figure 14 is of the conventional type. It covers up the objective lens so that that lens cannot be seen in the photograph. This shutter is timed to remain open for a time interval equal to that required for one complete turn of the rotating drum. Its purpose, of course, is to prevent the multiple exposure of photographs around and around the drum on the same film. This shutter is released by a solenoid, not shown, acting on an electrical impulse from the engine or other object being photographed. The tachometer magneto is connected to the driving motor through 5:1 step-down gears. The output of this magneto is delivered to the tachometer voltmeter on the electrical control box; the voltmeter is graduated in revolutions per minute. This tachometer was carefully calibrated and corrections have been applied to the readings so that camera

speeds reported are believed to be accurate to within one-half of 1 percent.

Current for the direct-current driving motor is supplied by the motor-generator set bolted to the under side of the outer structural steel framework. The alternating-current motor of this motor-generator set operates on a three-phase, 60-cycle, 230-volt supply. The camera-speed control and starting-current control is by the Ward-Leonard control system, the field excitation of the direct-current generator being controlled by the rheostat mounted on the electrical control box. This rheostat is wired as a dropping resistor. The excitation of the direct-current driving motor is fully maintained at all times. When the camera is started, the field current of the direct-current generator is continuously increased at such a rate that its armature current, and the armature current of the direct-current driving motor, as shown by the ammeter mounted on the electrical control box, remains constant at a value equal to 200 or 300 percent of the rated full-load current of the driving motor. After the photograph is taken the camera drum is stopped by regenerative braking, the rheostat again being continuously adjusted to keep the armature current at a value of 200 or 300 percent of rated full-load current. The accelerating and decelerating periods are each about 2½ minutes.

Shown in figure 14 is a variable-output voltage transformer, which is used to control the voltage applied to the light source used with the camera. The conduit to the timing spark gap shown in the photograph supplies the voltage

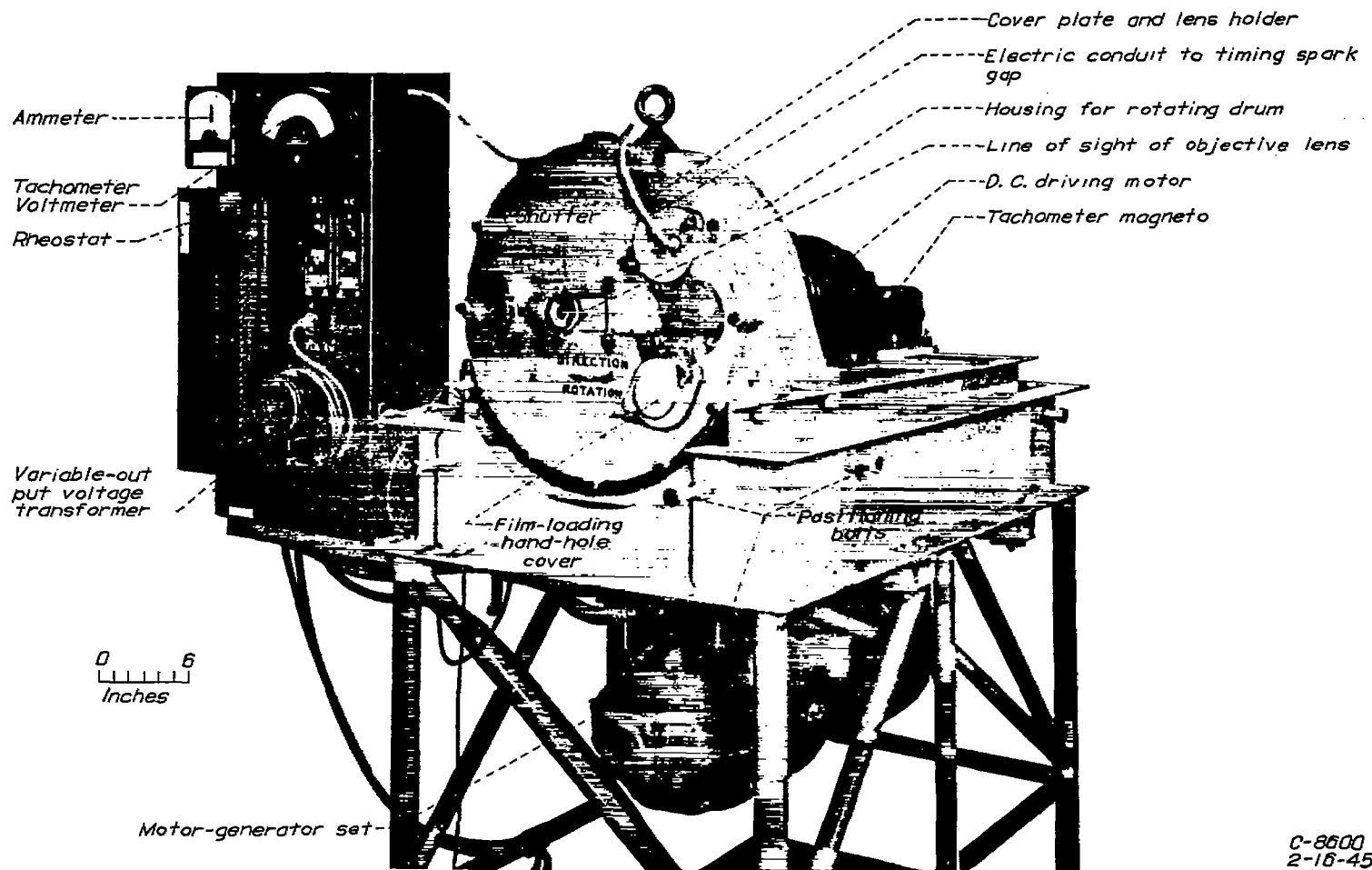

FIGURE 14.—Photograph of NACA high-speed motion-picture camera with stand and electrical control box.

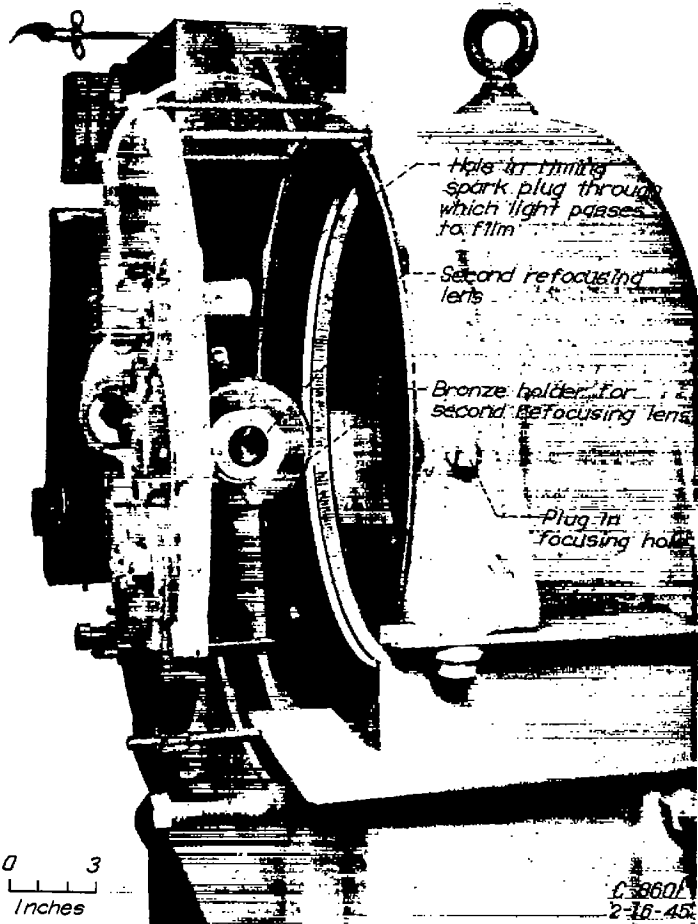

FIGURE 15.—View inside camera housing showing rotating drum with prisms and film.

surge for a timing spark that makes a record on the film such as was used in the investigation of reference 3. In that investigation this timing spark was used to establish a chronological relationship between the events seen on the high-speed photographic film and the events seen on a pressure-time record of the combustion and knock in an engine cylinder.

Figure 15 is a view inside the drum housing. The capscrews that hold the cover plate to the housing have been removed and the cover plate has been pulled away from the housing on long bolts inserted temporarily into the housing. The film and the prisms on the inside of the drum are plainly visible. A glass element of the second refocusing lens may be seen in the bronze holder. The indicated plug in the housing is removed for focusing operations. A dental mirror is inserted through the focusing hole and the image on the film is examined through its reflection in the dental mirror.

The inner side of the cover plate is seen in figure 16. It shows the holder for the first refocusing lens, cast integral with the cover plate; the bronze holder for the second refocusing lens; the timing spark plug; and a shield for stray light, screwed to the holder of the first refocusing lens. The bronze holder for the second refocusing lens is fastened to the holder for the first refocusing lens by two capscrews. This bronze holder is also fastened to the cover plate with four capscrews visible in figures 14 and 15. The shield for stray light has a rectangular aperture, not visible in the photo-

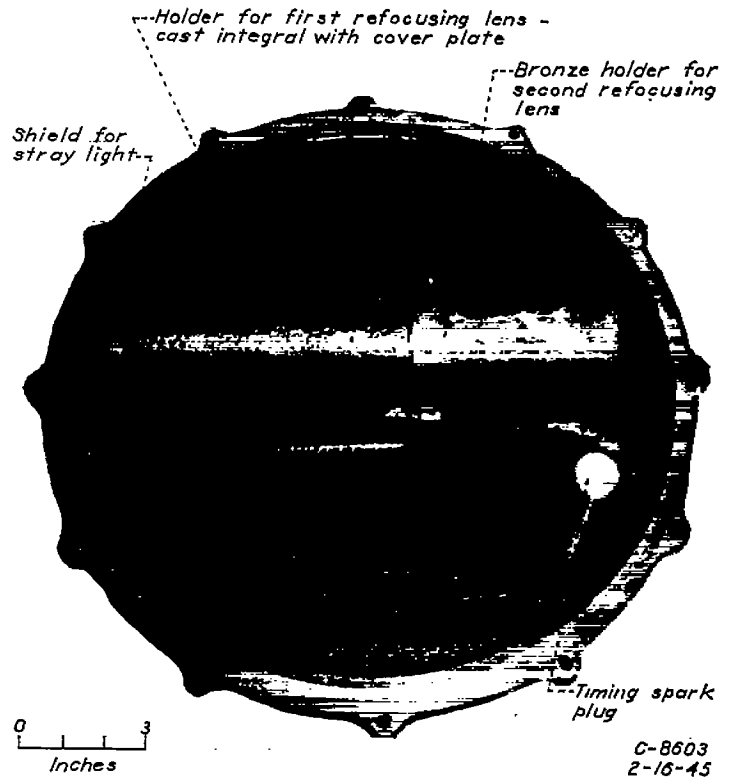

FIGURE 16.—Inner side of camera cover plate and lens holder.

graph, just large enough to allow the light beam to pass through it from the objective lens to the glass prisms and back again from the glass prisms to the refocusing lenses. This shield is machined on its outer surface in such manner as to approach closely at all points to the surfaces of the rotating drum, the glass prisms, and the film.

Figure 17 is an exploded view of the inside of the cover plate and the elements that are mounted on it. The rectangular aperture in the stray-light shield is visible in this photograph. The first refocusing lens screws into the holder, cast integral with the cover plate. The position of the first refocusing lens along the axis BB (see fig. 1) is adjusted simply by screwing the lens farther into or out of the holder. Adjustment of the second refocusing lens along the axis BB is not made in this manner because of the necessity of keeping the optical axis of this lens at an angle of  $2^\circ$  with the axis BB.

The second refocusing lens was so constructed that the axis of its outer cylindrical metal surface makes an angle of  $2^\circ$  with the optical axis of the glass elements inside the lens. The bronze holder for the second refocusing lens has a cylindrical bore whose axis is BB of figure 1. The second refocusing lens slides within the bore of the bronze holder, without rotation, in such a manner that the outer cylindrical metal surface of the lens is concentric with the axis BB but with the optical axis of the glass elements always at an angle of  $2^\circ$  with the axis BB. The lens is prevented from rotating within the bronze holder by a dowel projecting inward from the inner surface of the holder. This dowel fits into a longitudinal slot in the outer surface of the lens, not visible in figure 17 but visible in figure 18. The lens is adjusted along the axis BB of figure 1 by means of the focusing barrel shown in figure 17. This focusing barrel is screwed onto the out-

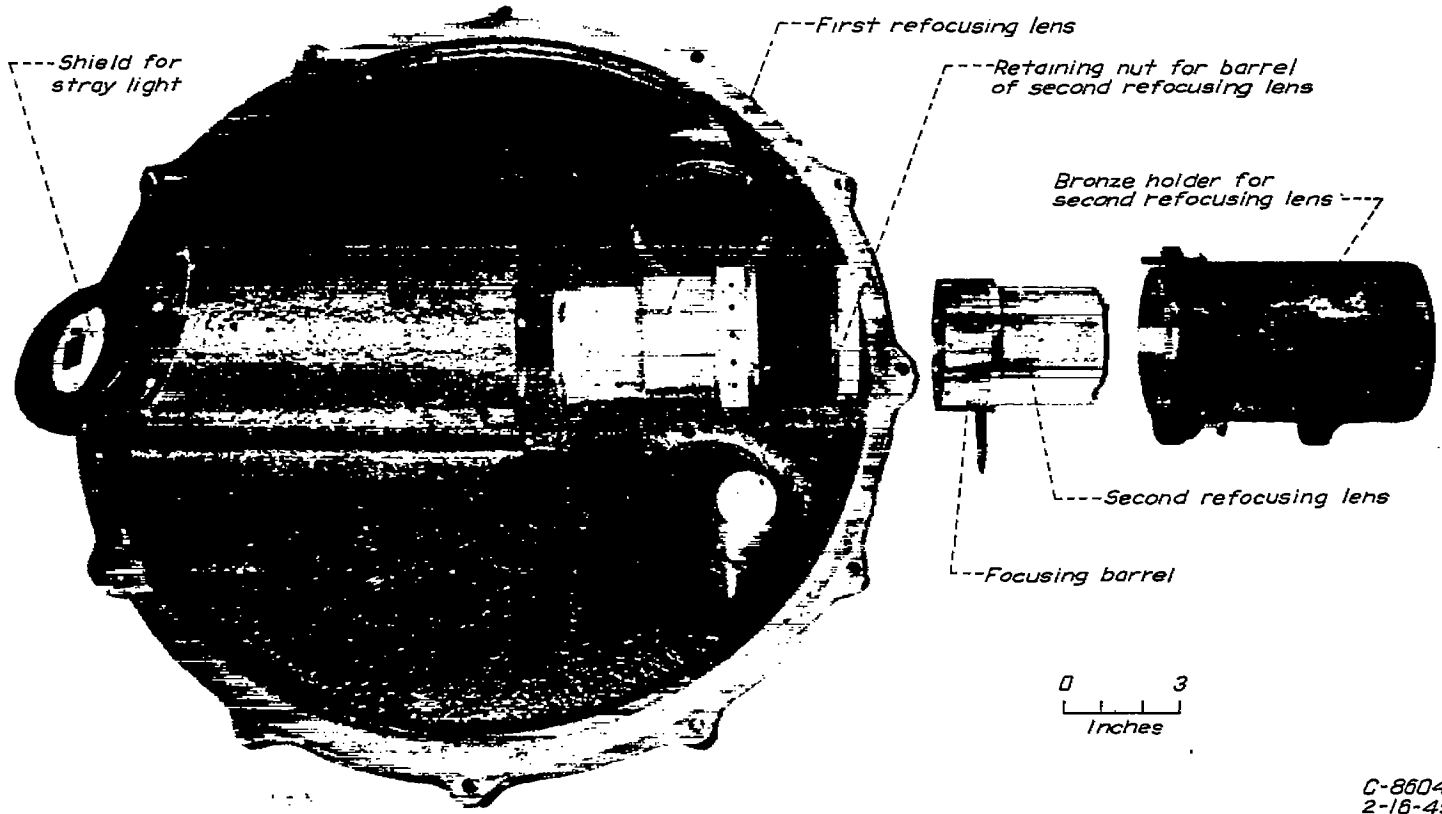

FIGURE 17.—Exploded view of lens assembly and inner side of camera cover plate.

side of the second refocusing lens. When the lens is assembled in the holder, the focusing barrel is free to rotate but is constrained axially, on one side by a shoulder machined inside the bronze holder and on the other side by the retaining nut shown in figure 17. The retaining nut is screwed into the bronze holder just far enough to eliminate axial play of the focusing barrel but not far enough to clamp the barrel and prevent rotation. Rotation of the barrel causes the lens to slide along the axis BB of figure 1.

A photograph of the two refocusing lenses, with the focusing barrel mounted on the second refocusing lens, appears in figure 18. Figure 19 presents a view of the rotating drum with prisms and film mounted.

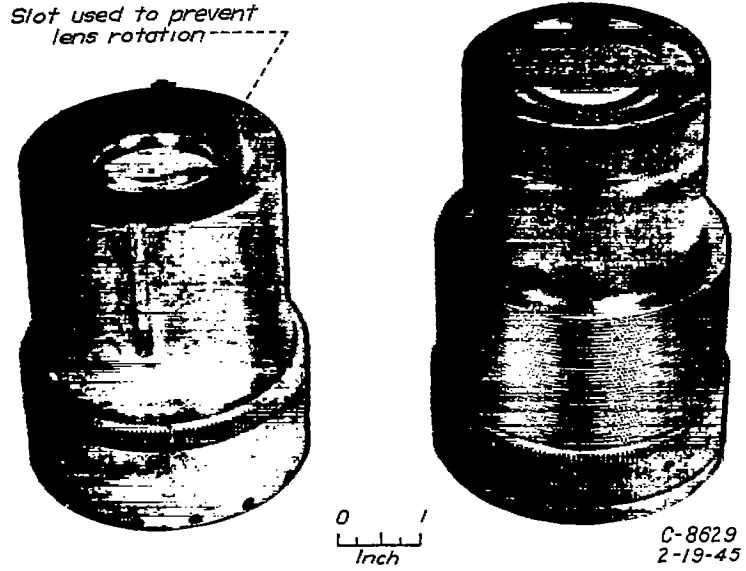

FIGURE 18.—View of the two refocusing lenses.



FIGURE 19.—View of rotating drum with prisms and film in place.

**EXAMPLES OF PHOTOGRAPHS TAKEN WITH THE CAMERA**

Some of the earliest photographs taken at the rate of 40,000 frames per second in the original try-out of the camera are reproduced in figures 20 to 23. They are presented here as an illustration of the quality of pictures taken of subject matter with which most readers are sufficiently familiar to allow them to draw conclusions.

Figure 20 is a shot of an ordinary photographer's photo-

flash bulb, of the type that is filled with aluminum foil. The individual photographs, or frames, are arranged in horizontal rows designated A, B, C, etc. The frames in each row are designated 1, 2, 3, etc. Throughout the comments on all of these figures individual frames will be designated frame A-1, meaning the first frame of row A; C-7, meaning the seventh frame of row C; and so on. The order in which the frames of figure 20 were exposed is from left to right

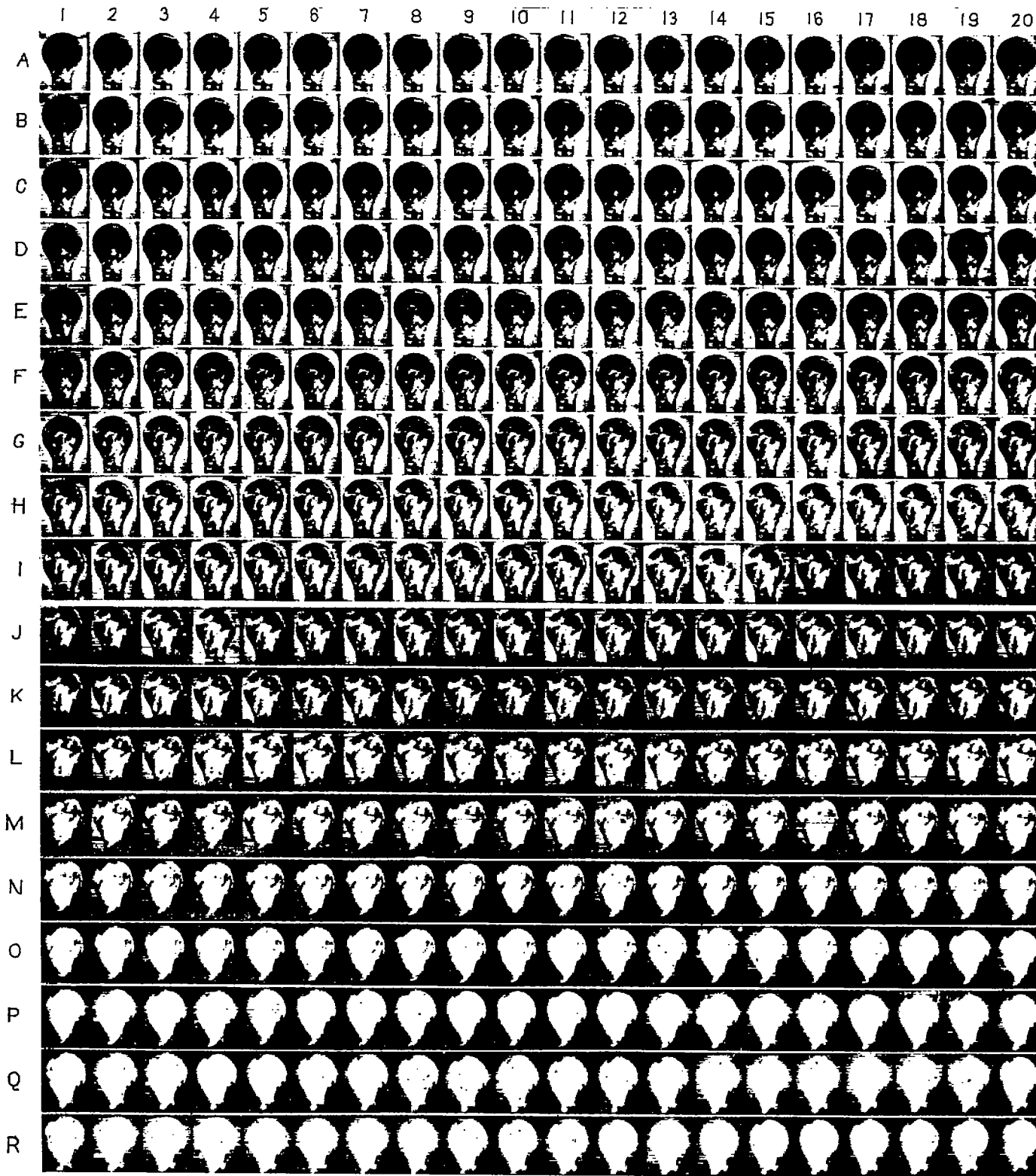

C-9450  
3-29-45

C-9451  
3-29-45

FIGURE 20.—Shot of combustion of an ordinary photoflash bulb taken at 40,000 frames per second with the NACA high-speed motion-picture camera.

through row A, frames A-1 through A-20; then from left to right through row B, frames B-1 through B-20; and so on to row R, frames R-1 through R-20. The series contains 360 frames in all; only 12 frames were lost in the opening and closing of the external shutter.

The flash of the photoflash bulb is by no means instantaneous. The entire series of figure 20 shows only the earliest stages of the flash, that is, the period from the beginning of the combustion of the aluminum foil until the entire bulb has become incandescent. Slower motion pictures have shown that the duration of the entire flash of the bulb is approximately 10 times as long as the period covered by the photographs of figure 20.

Figures 21 and 22 each show the explosion of a large firecracker. The firecracker was set off by a heavy jolt of electric current through a fine wire threaded from one end of the firecracker to the other. The camera shutter was tripped by the same electric impulse that fired the firecracker. In figure 21, fire had already begun to blow out of the ends of the firecracker at the time the shutter opened at frame

A-5. The wall of the firecracker began to break and to allow flame to escape from the side of the firecracker at frame B-9, 500 microseconds after the opening of the shutter. In the 25-microsecond interval between frames B-9 and B-10, the flame made very considerable progress out through the sides of the firecracker. In frame B-10 the side wall may be seen to have ruptured at two points simultaneously. After frame B-10 the photographs are of very poor quality because of the overlapping of the successive frames. This overlapping could easily have been prevented by mounting a framing screen just in front of the firecracker, between the firecracker and the camera. The intended use of the camera, however, was research on combustion and knock in the engine cylinder, and no effort was made to obtain the best possible photographs of firecrackers. In spite of the overlapping of exposures, a portion of the firecracker side-wall can be seen being blown away from the original position of the firecracker in frames B-11 to C-12.

Smoke was already issuing from the lower end of the firecracker at the time of exposure of frame A-1 of figure 22.

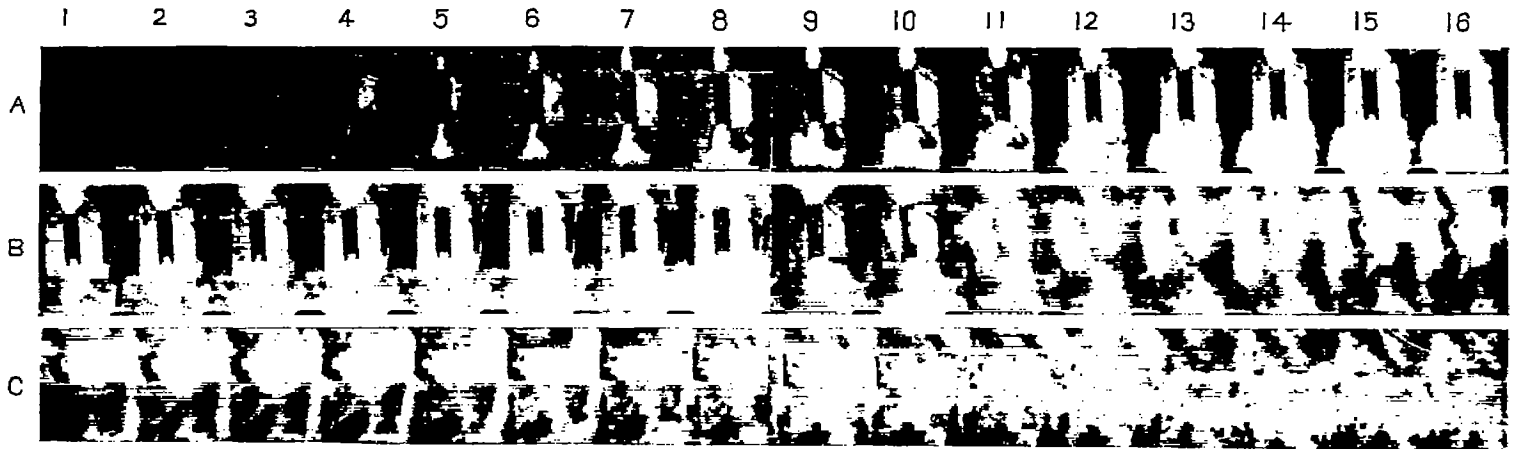

C-9448  
3-29-45

FIGURE 21.—Shot of exploding firecracker showing simultaneous rupture of side wall at two points, taken at 40,000 frames per second with the NACA high-speed motion-picture camera.



C-9449  
3-29-45

FIGURE 22.—Shot of exploding firecracker showing smoke issuing from ends before flame becomes visible, taken at 40,000 frames per second with the NACA high-speed motion-picture camera.

Visible flame began to issue from the upper end of the firecracker 100 to 125 microseconds later, frame A-5 or A-6. About 325 microseconds later, frame B-2 or B-3, flame began to blow out of the lower end of the firecracker. Flame then spewed out of both ends of the firecracker for 450 microseconds before the sidewall finally failed at frame C-5. After frame C-6 or C-7 the photographs are meaningless partly because of the overlapping of exposures and perhaps partly because there was actually little detail to be seen in the mass of flame and smoke between the firecracker and the camera.

Figure 23 is a photographic shot of a high-grade shutter of the conventional between-the-lens type. The shutter first began to open at frame A-4 and was completely closed at frame H-15. The total partly open time was therefore

almost trouble-free service. On one occasion a progressive deterioration of the definition of the photographs was found to be caused by the unscrewing of an element of one of the refocusing lenses. The unscrewing of the element was caused by vibration. Provision was subsequently made to lock all elements permanently in position. On a few occasions the film has become detached from the camera drum and torn to shreds. No harm to any part of the camera has ever resulted from this mishap. A cleaning out of the camera is, of course, required.

The original adjustment of the first and second refocusing lenses requires the attention of an expert. Once the adjustments are made the operation of the camera is no more difficult than the operation of a conventional camera.

The general opinion among observers of the motion

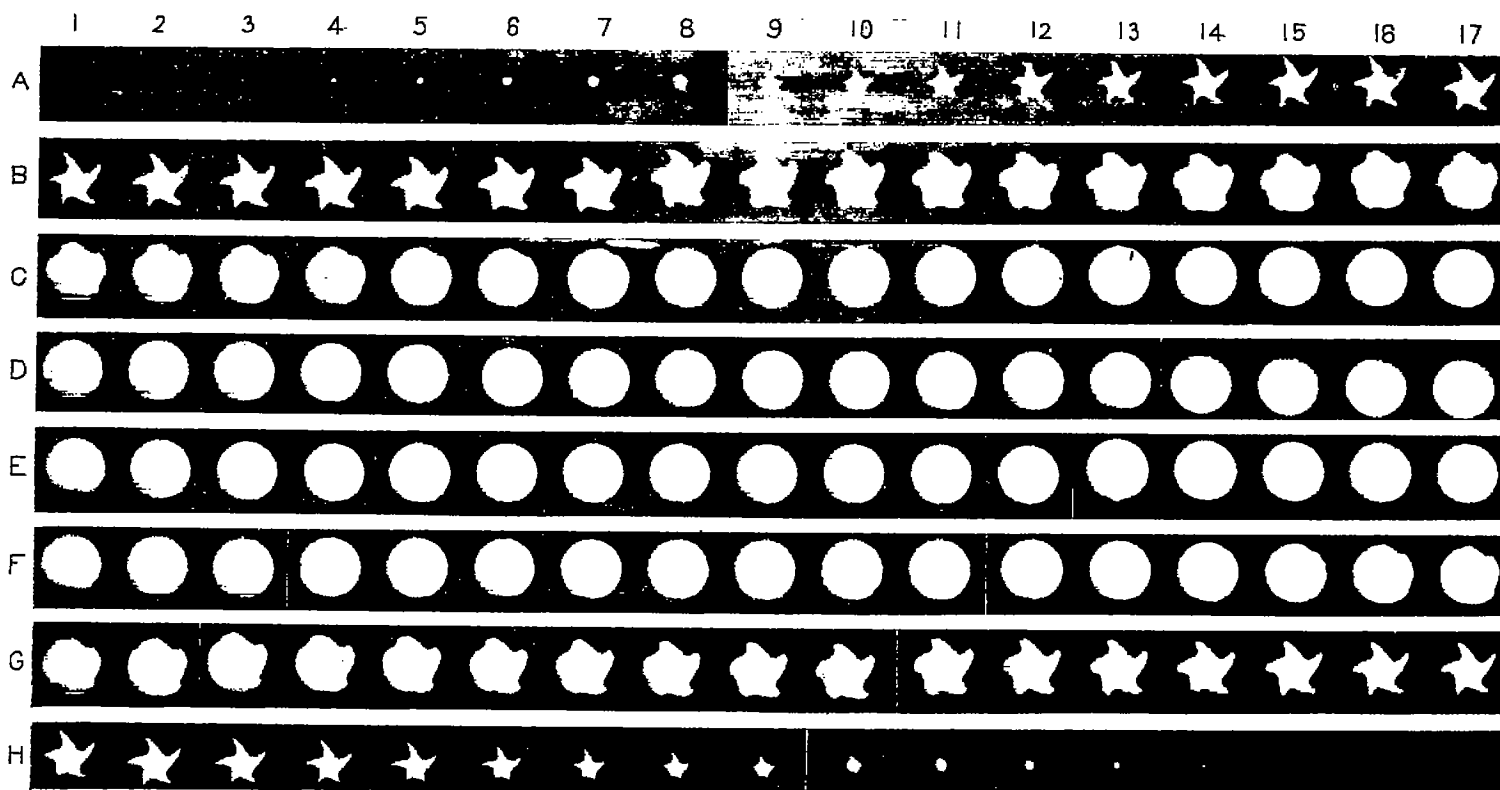

C-9447  
 3-29-45

FIGURE 23.—Shot of high-speed camera shutter of between-the-lens type, set for 1/500 second, taken at 40,000 frames per second with the NACA high-speed motion-picture camera.

3275 microseconds, or about half again as much as the 1/500-second interval for which the shutter was set. The shutter was first completely open at frame C-10, and remained completely open through frame F-13, an interval of 1375 microseconds, or about 70 percent of the 1/500-second interval for which the shutter was set. The equivalent fully open time of the shutter was probably quite close to the setting of 1/500 second.

**CONCLUDING REMARKS**

In over 6 years of service, the cameras constructed according to the principle described have given dependable and

pictures produced with the camera appears to be that the quality is good, if full consideration is given to the speed at which the pictures were taken. The quality has been quite adequate for the scientific purposes for which the camera has been used. The photographs have uncovered a considerable amount of new information concerning the phenomenon of knock in the spark-ignition engine.

AIRCRAFT ENGINE RESEARCH LABORATORY,  
 NATIONAL ADVISORY COMMITTEE FOR AERONAUTICS,  
 CLEVELAND, OHIO, November 6, 1945.



REFERENCES

1. Rothrock, A. M., Spencer, R. C., and Miller, Cearcy D.: A High-Speed Motion-Picture Study of Normal Combustion, Knock, and Preignition in a Spark-Ignition Engine. NACA Rep. No. 704, 1941.
2. Miller, Cearcy D.: A Study by High-Speed Photography of Combustion and Knock in a Spark-Ignition Engine. NACA Rep. No. 727, 1942.
3. Miller, Cearcy D., and Olsen, H. Lowell: Identification of Knock in NACA High-Speed Photographs of Combustion in a Spark-Ignition Engine. NACA Rep. No. 761, 1943.
4. Brun, Rinaldo J., Olsen, H. Lowell, and Miller, Cearcy D.: End-Zone Water Injection as a Means of Suppressing Knock in a Spark-Ignition Engine. NACA RB No. E4I27, 1944.
5. Miller, Cearcy D., and Logan, Walter O., Jr.: Preknock Vibrations in a Spark-Ignition Engine Cylinder as Revealed by High-Speed Photography. NACA Rep. No. 785, 1944.
6. Miller, Cearcy D.: Relation between Spark-Ignition Engine Knock, Detonation Waves, and Autoignition as Shown by High-Speed Photography. NACA Rep. No. 855, 1946.
7. Rothrock, A. M., Miller, Cearcy D., and Spencer, R. C.: Slow Motion Study of Normal Combustion, Preignition, and Knock in a Spark-Ignition Engine. NACA Tech. Film No. 14, 1940.
8. Miller, Cearcy D.: Slow Motion Study of Fuel Injection and Combustion in a Diesel Engine. NACA Tech. Film No. 15, 1942.
9. Tuttle, Fordyce, and Reid, Chas. D.: The Problem of Motion Picture Projection from Continuously Moving Film. Jour. Optical Soc. Am., vol. 22, no. 2, Feb. 1932, pp. 39-64.
10. Edgerton, Harold E., and Killian, James R., Jr.: Flash! Seeing the Unseen by Ultra High-Speed Photography. Hale, Cushman & Flint (Boston), 1939.
11. Cranz, C., und Schardin, H.: Fortschritte auf dem Gebieb der Hochfrequenz-Kinematographie. VDI Zeitschr., Bd. 79, Nr. 36, Sept. 7, 1935, S. 1075-1079.
12. Mortier, P.: Kinematographic Apparatus. Great Britain Patent Office No. 22,713, 1898.
13. Mills, C. K.: Kinematographs. Great Britain Patent Office No. 7482, 1905.
14. Wescott, William B.: Cinematography. U. S. Patent Office No. 1,245,844, Nov. 6, 1917.
15. Comstock, Daniel F.: Cinematography, U. S. Patent Office No. 1,252,321, Jan. 1, 1918.
16. Kosken, Wilho A.: Means for Projecting Picture Films. U. S. Patent Office No. 1,906,759, May 2, 1933.
17. Tuttle, F. E.: A Non-Intermittent High-Speed 16 mm Camera. Jour. Soc. Motion Picture Eng., vol. XXI, no. 6, Dec. 1933, pp. 474-477.
18. Thun, Rudolf: Motion Picture Apparatus. U. S. Patent Office No. 1,956,736, May 1, 1934.