

REPORT 982

ICING-PROTECTION REQUIREMENTS FOR RECIPROCATING-ENGINE INDUCTION SYSTEMS

By WILLARD D. COLES, VERN G. ROLLIN, and DONALD R. MULHOLLAND

SUMMARY

Despite the development of relatively ice-free fuel-metering systems, the widespread use of alternate and heated-air intakes, and the use of alcohol for emergency de-icing, icing of aircraft-engine induction systems is a serious problem. Investigations have been made to study and to combat all phases of this icing problem. From these investigations, criteria for safe operation and for design of new induction systems have been established.

The results were obtained from laboratory investigations of carburetor-supercharger combinations, wind-tunnel investigations of air scoops, multicylinder-engine studies, and flight investigations. Characteristics of the three forms of ice, impact, throttling, and fuel evaporation, were studied. The effects of several factors on the icing characteristics were also studied and included (1) atmospheric conditions, (2) engine and air-scoop configurations, including light-airplane systems, (3) type of fuel used, and (4) operating variables, such as power condition, use of a manifold pressure regulator, mixture setting, carburetor heat, and water-alcohol injection. In addition, ice-detection methods were investigated and methods of preventing and removing induction-system ice were studied. Recommendations are given for design and operation with regard to induction-system icing.

INTRODUCTION

Ice formations within an aircraft-engine induction system are serious hazards because: (1) the critical areas may be sufficiently restricted to reduce considerably the flow of combustion air to the engine; (2) the fuel-metering process may be upset and cause erratic engine operation; or (3) the movable parts, such as the throttle or the heat damper, may freeze and become inoperative.

The symptoms associated with induction-system icing are not always discernable and recognition of icing conditions usually requires considerable operational experience and judgment. This type of icing is not necessarily a cold-weather phenomenon, but may occur at temperatures far above the normal ambient freezing level. Evidence of ice formation during operation or following failure is not easily obtained because the ice rapidly melts and a completely reliable icing indicator for induction systems is as yet unavailable.

Induction-system icing has long been a recognized problem and was rated a principal cause of power-plant failure as

early as 1921 (reference 1). Attention was sharply focused on the problem in 1939 by the loss of the British flying boat "Cavalier" (reference 2) and again during the war years by an alarming number of transport losses in the China-Burma-India theater of operations.

The icing problem remains a serious hazard, despite the fact that the induction systems on most licensed aircraft are capable of providing sufficient protection in all weather conditions if the protection is correctly applied and at the proper time. Because the symptoms of carburetor icing are often similar to those associated with other engine operating difficulties, the pilot must be familiar with the aspects of induction-system icing if proper protection is to be promptly applied with most protective systems now in use.

Pilot reports of current operation of several airplanes of recent design show that numerous incidents of engine stoppage and erratic operation are attributable to both ice formation and water in the induction system. Much effort has been expended to prevent such trouble by altering the design of the equipment or by changing the operating technique.

In a review of Civil Aeronautics Administration reports of accidents and of failures found during inspection and overhaul for 1930-46, Posner (reference 3) reported that 109½ cases of carburetor icing were recorded out of a total of 4833 reports. This review covers nonscheduled aircraft operations and approximately 99 percent of the data represented operation of small single-engine aircraft. From an analysis of light-airplane power-plant failures for 1947, Weick (reference 4) indicates that 34 percent of the forced landings were caused by ineffective carburetor heat or by nonapplication or improper application of carburetor heat. This analysis was based on one-seventh of the total of 9253 privately operated airplane mishaps recorded by the Civil Aeronautics Board for the year.

In 1940, as operations through inclement weather began to increase, the Air Transport Association recognized the need for a better understanding of causes, effects, and cures of induction-system icing and requested the NACA to study the problem. Research was started in 1941 at the National Bureau of Standards under the direction of a special NACA subcommittee. In 1943, the work was transferred to research facilities at the NACA Lewis laboratory with a more comprehensive program sponsored by the Army Air Force.

The NACA research program included laboratory determinations of icing characteristics and heated-air and fluid de-icing requirements for representative float-type, pressure-type, and fuel-injection-type carburetors in combination with representative manifolds, adapters, and supercharger combinations; dynamometer measurements of the effects of ice on engine operation; icing-research-tunnel studies of several protected air-inlet scoops; and flight research under both natural and simulated icing conditions (references 5 to 21). The performance of several special ice-warning instruments was studied and an investigation was made of methods of eliminating the icing problem by suitable design of the air inlet, the fuel-injection device, and the throttles (references 13, 18, and 19, respectively).

Acknowledgement is made of the work of previous investigators, which is considered throughout this report and is presented in conjunction with the results obtained by the NACA. Further acknowledgement is made to domestic air-transport companies, government agencies, the armed services, and engine and accessory companies for their helpful advice, reports on operating incidents and practices, and the loan of equipment for experimental investigations.

REPRESENTATIVE INDUCTION SYSTEMS

The induction system of a reciprocating engine includes all elements and accessories of the air duct from the main air-inlet scoop to the inlet valve on the engine cylinder. The possible combinations of these elements are increased by variations in design and size of each component and by use of several different groups of the components on a single model aircraft.

An induction system typical of those used on large aircraft is illustrated in figure 1(a). The system consists of an offset air scoop with boundary-layer bypass, a hot-air selector valve, a protective screen, a downdraft pressure-injection-type carburetor, a fuel-injection nozzle, turning vanes in the supercharger-inlet elbow, and supercharger. Warm air from behind the engine cylinders can be drawn into the system through a heating shroud surrounding the exhaust collector when the hot-air valve is turned to close off the cold ram air. The induction system shown in figure 1(b) is similar to that of figure 1(a), except that the inlet-air duct is built into the leading-edge region of the engine cowl. An undercowl scoop that utilizes the principle of inertia separation for removing some of the free water from the inlet air is shown in figure 1(c). Any of these systems can also incorporate additional equipment, such as an auxiliary-stage supercharger, an air filter, and an intercooler, which inherently complicates the air-flow path.

Nearly all aircraft induction systems have some type of alternate air inlet. Systems other than those shown in figure 1 have been employed for obtaining sheltered or heated air or both, such as taking engine cooling air directly from behind the cylinders without special heat provision,

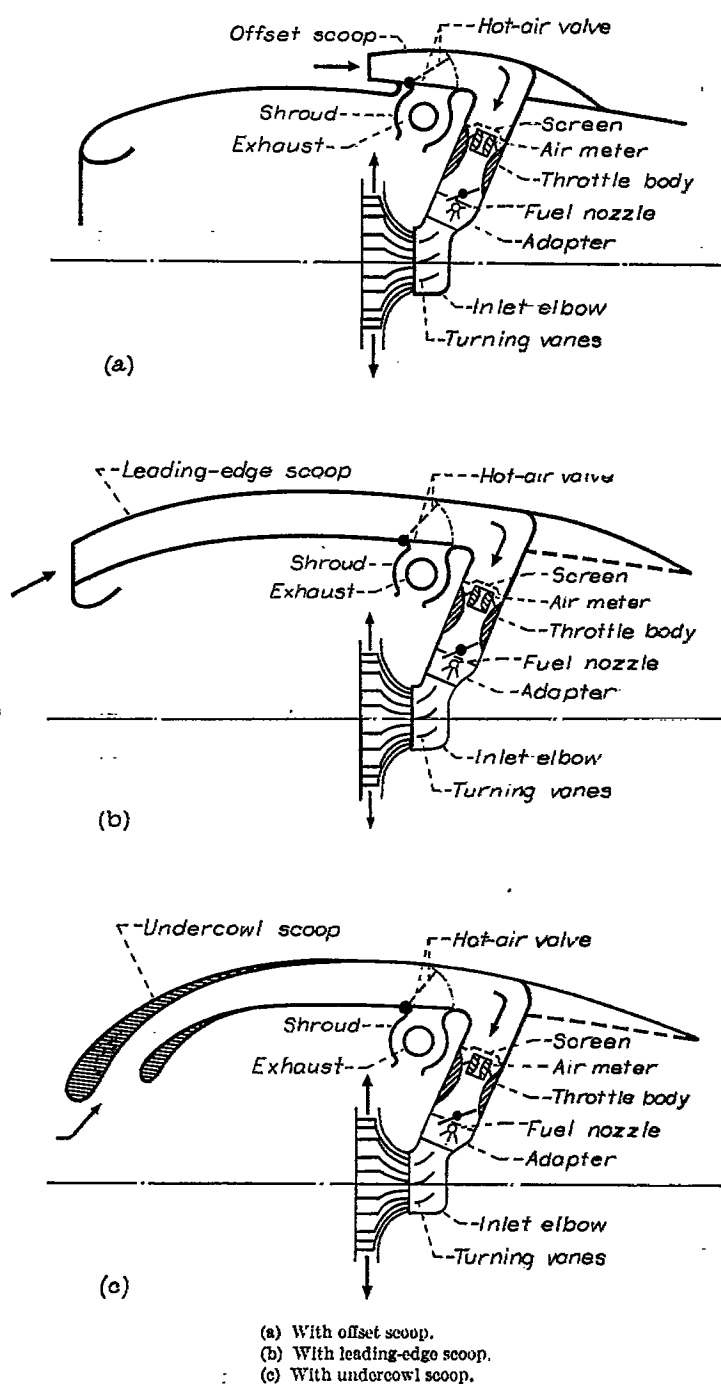

FIGURE 1.—Typical induction system.

using a turbosupercharger as a sole means of heat, or using a sheltered unheated inlet such as a wheel well.

In addition to alternate or heated-air systems, alcohol sprays have frequently been used at various locations in the induction system for emergency ice protection. The British have favored the use of oil or coolant jackets for surface heating of the carburetor (reference 22).

The fuel-metering equipment on large aircraft engines usually consists of pressure-type carburetors or fuel-injection systems. In recent years, the speed-density fuel-metering system has been considered

A typical light-airplane induction system is shown in figure 2. The main inlet-air duct contains a ram-air filter,

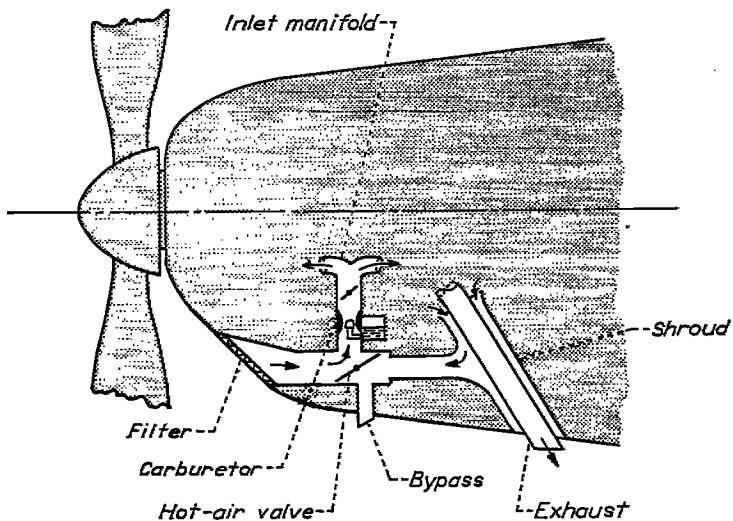

FIGURE 2.—Conventional light-airplane induction system.

a selector valve for changing from the normal ram-air inlet to the alternate hot-air system, an updraft float-type carburetor with fuel nozzle ahead of the throttle, and a mixture-distributing manifold. Warm air from the engine compartment can be drawn through a heating shroud surrounding the exhaust manifold into the carburetor when the selector valve is turned to close the ram-air inlet and the hot-air bypass.

TYPES OF INDUCTION-SYSTEM ICE FORMATION

Three distinct types of icing that occur in the induction system are impact, throttling, and fuel-evaporation icing.

IMPACT ICING

Impact icing occurs when a subfreezing surface comes in contact with supercooled water droplets such as may be found in clouds or freezing rain. When the droplet strikes the surface, a small portion of the water freezes instantaneously and the latent heat that is released raises the temperature of the remaining water to 32° F. Heat transfer to the surface and to the atmosphere causes this water to freeze.

Impact ice collects on scoop inlets, duct walls, carburetor-inlet screens, exposed metering elements, throttles, and other protuberances in the induction system. These ice formations may throttle the air flow and thereby reduce the engine power. In addition, the ice formations upset the carburetor metering by disturbing the air-flow pattern.

Generally, dry snow and sleet at low temperatures do not cause serious icing unless certain types of filter or screen are used. Inadequate heating of the inlet may cause dry snow to stick to the inlet and produce more serious icing than would be experienced with no heating.

The rates at which local formations of impact ice grow depend on the local impingement rates of water droplets. Analytical determination of local impingement rates is

exceedingly difficult because the air-flow pattern must be calculated and a tedious step-by-step integration of the droplet trajectories performed. An approximate estimate of the total amount of *free water* entering the system can be made, however. The term *free water* is used to denote water in a liquid state and excludes water vapor. The rate at which free water is carried into the induction system equals the product of the volume rate of air flow, the free-water concentration per unit of air volume, and the collection efficiency of the inlet. The collection-efficiency factor allows for the variations in water concentration that result from the deviation of droplet paths from the streamlines.

Water concentrations that might be expected in various meteorological conditions are tabulated in reference 23.

THROTTLING ICING

Throttling icing is caused either by freezing of water or by condensation and freezing of water vapor resulting from the expansion cooling of the charge air as it passes through restrictions in the induction system. The formation of throttling ice on a throttle and a throttle barrel is illustrated in figure 3. As the air flows from a region of high

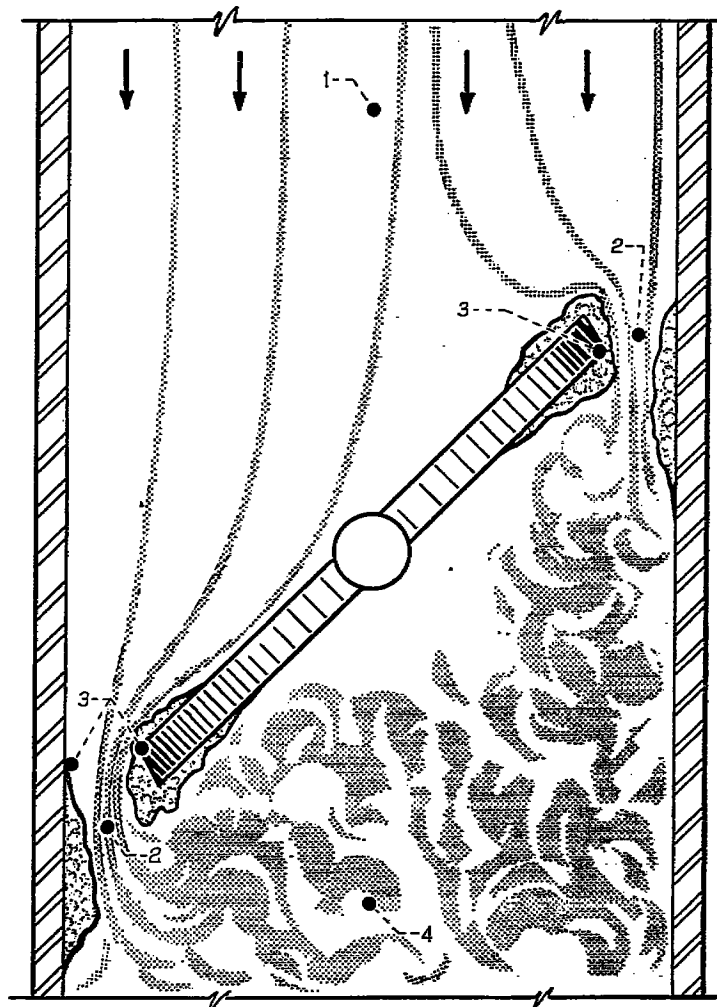

FIGURE 3.—Schematic diagram of throttle and throttle barrel showing air-flow pattern and throttling ice.

pressure (region 1) to a region of low pressure (region 2), it is accelerated to a high velocity and the temperature decreases. This decrease in temperature may be calculated if the flow is assumed to be isentropic. The temperature of the wall and the throttle plate at region 3 will be higher than the air temperature at region 2 because of heating effects in the boundary layer.

If no evaporation of droplets is assumed to occur, the wall temperature may be calculated and then corrected for cooling by evaporation of a water film on the wall, as demonstrated in reference 24. This calculation consists essentially in estimating the wall temperature assuming dry air, estimating the water-vapor pressure at region 2 with the assumption of no evaporation, and then finding the wet-bulb temperature corresponding to this vapor pressure and the dry-wall temperature.

If the throttle barrel is insulated, the approximate wall temperature can be easily estimated with the aid of the Mollier diagram for water-air mixtures in reference 25. The water droplets and the air are assumed to be in equilibrium and the temperature at region 2 is found by assuming a wet isentropic expansion from the pressure at region 1 to the pressure at region 2. The wall temperature is found by assuming that 90 percent of the enthalpy drop from region 1 to region 2 is recovered in the boundary layer and the pressure at region 3 equals the pressure at region 2. The air after it passes the throttle loses its velocity in turbulent region 4. The approximate temperature at region 4 can be found from the Mollier diagram when the pressures at regions 1 and 4 are known by assuming a constant-enthalpy process between the two regions. Greater accuracy may be obtained by correcting the enthalpy for the difference

in velocities at regions 1 and 4. This analysis is approximate because the water droplets and the air do not stay in equilibrium during the expansion process.

The estimated upper temperature limit at which throttling ice occurs is shown in figure 4 for throttle pressure ratios from 0.96 to 0.53. Values are shown for an inlet pressure of 28.86 inches of mercury absolute and relative humidities of 60, 80, and 100 percent. Throttle pressure ratios corresponding to the approximate power settings for glide, low cruise, high cruise, normal rated, and take-off are indicated.

Neither of the two methods of calculating wall temperature is strictly in accord with the actual processes within the carburetor. A very important consideration that cannot be accurately evaluated is the transfer of heat through the metal parts.

In systems such as most light airplanes use, the throttle is downstream of the fuel nozzles and is thus also subject to fuel-evaporation icing, as discussed in the following section.

FUEL-EVAPORATION ICING

Fuel-evaporation icing occurs when fuel is introduced into the air stream and the extraction of the latent heat of vaporization from the air stream and the surrounding metal surfaces is sufficient to reduce the temperatures below freezing. The lowering of the temperature condenses and freezes water vapor in the air or on the metal surfaces.

The theoretical cooling effect of gasoline, when complete evaporation of a stoichiometric mixture of gasoline and air is assumed, is approximately 37° F (reference 26). The localized cooling effect may be much greater in regions where the fuel-air ratio is very rich. Such regions may be close to the fuel spray or where fuel impinges on surfaces of the carburetor.

An accurate analytical evaluation of the maximum localized cooling effect of gasoline has not been made. An approximate method is mentioned in reference 24 in which the gasoline is assumed to be a single compound and the vapor pressures and the latent heat of this compound are used to compute a wet-bulb temperature for a fuel-air mixture. This wet-bulb temperature is the theoretical temperature of a wall wetted by gasoline.

Another approximate and less-accurate method of computing the temperature reduction can be made by assuming the existence of a local concentration of the lightest fractions of the fuel. If this light fraction is assumed to be isopentane, the local cooling effect may be greater than 150° F.

Experiments with carburetors have shown fuel-evaporation icing at inlet-air temperatures as high as 102° F, indicating a local temperature reduction of at least 70° F.

Ice that forms as a result of fuel evaporation builds up at several critical locations. Float-type carburetors, which mix fuel with the air within the venturi, cause fuel evaporation to occur during the throttling process and make the throttle region especially critical to icing. Pressure-type carburetors, which incorporate a fuel nozzle located in close

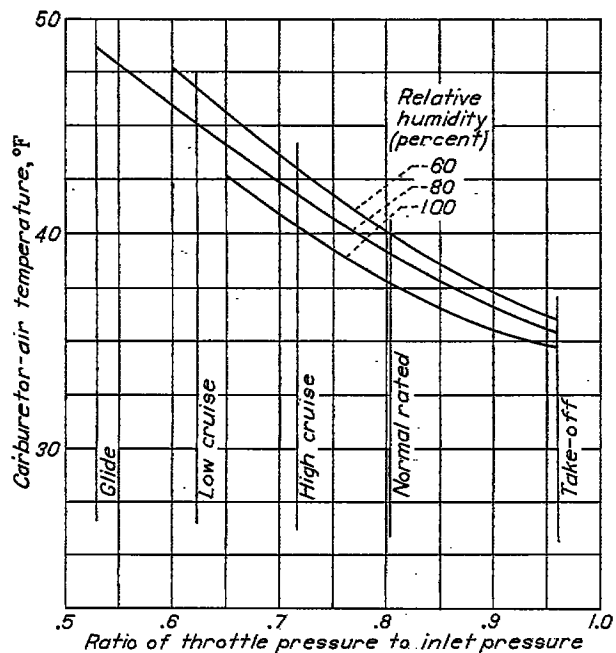

FIGURE 4.—Calculated carburetor-air temperature for several relative humidities that result in wet throttle-surface temperature of 32° F for various throttle pressure ratios. Inlet pressure, 28.86 inches mercury absolute.

proximity to a wake-producing protuberance, have been observed to cause eddying of the fuel spray in sufficient quantity to cause ice formation on the protuberances. Butterfly-type throttles or fuel nozzles mounted on a central

web are particularly susceptible to the effects of fuel recirculation. Figure 5 shows fuel eddying that occurs in a system utilizing butterfly-type throttles and a wall-mounted fuel nozzle. Accretions of ice also form on wall-mounted fuel nozzles in sufficient quantities to reduce fuel flow seriously.

METHODS AND TECHNIQUES

Research conducted by the NACA included investigations of icing and de-icing characteristics for several large engine carburetor-supercharger combinations, for induction-system inlets and ducts, and for light-airplane induction systems. The carburetor-supercharger studies for large engines included experiments with (1) a laboratory installation of the carburetor and the supercharger inlet without the remainder of the engine, (2) a laboratory installation of a complete engine, and (3) an engine during flight.

Air-inlet and duct investigation.—A study was made of the icing characteristics and the means for protection of a typical inlet and duct combination for a large transport aircraft by subjecting the installation (fig. 6) to simulated icing conditions in the NACA Lewis icing research tunnel. Icing of the filter and inlet combination of a light airplane was similarly investigated. (See references 13 and 20.)

Several experimental inlets, designed to remove free water from the charge air by providing inertia separation of the water droplets, were investigated both for aerodynamic and icing characteristics of the scoop, the duct, and the carburetor inlet.

Carburetor-supercharger installations without engine.—The icing characteristics of carburetor-supercharger combinations were determined in the laboratory by inducing air flow through the carburetor and supercharger-inlet section either by a suction pump connected to the induction system

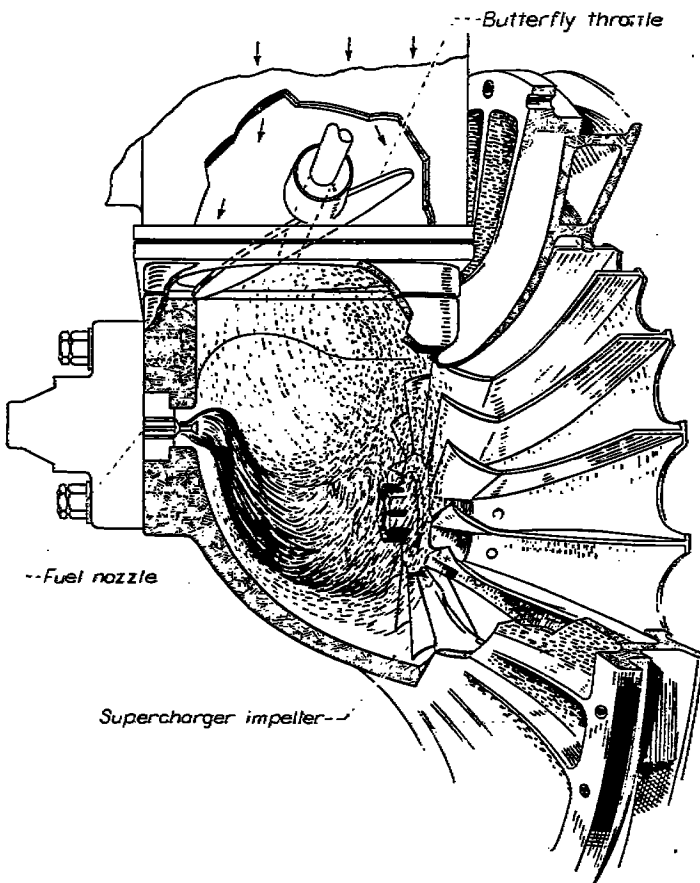

FIGURE 5.—Eddying fuel spray in system utilizing butterfly-type throttles and wall-mounted fuel nozzle.

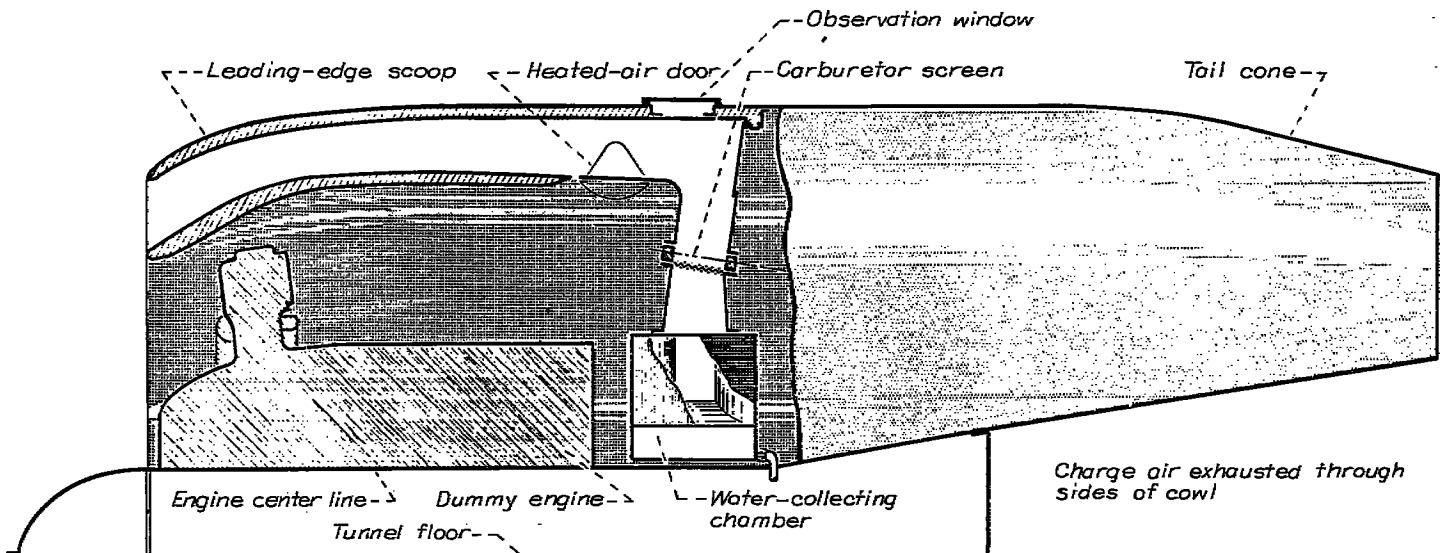

FIGURE 6.—Schematic diagram of induction-system installation with conventional air scoop in Lewis icing research tunnel.

(reference 7) or by operation of the supercharger impeller (reference 14). A representative installation is illustrated in figure 7. The temperature and the pressure of the sup-

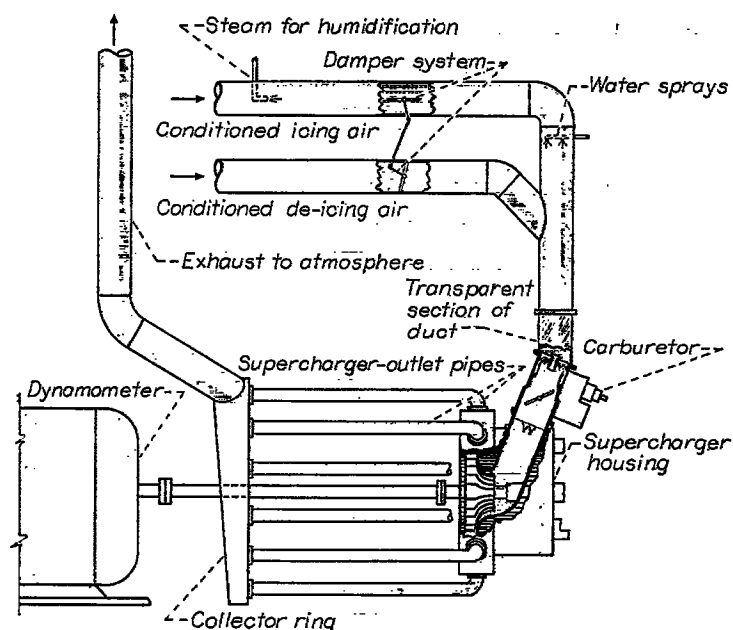

FIGURE 7.—Schematic diagram of typical induction-system icing research equipment.

plied air were carefully controlled and measured at the carburetor inlet. Moisture content of the air was regulated by steam jets to control humidity and by water sprays to provide water in excess of saturation. Instrumentation was provided to measure rates of air flow, fuel flow, and simulated-rain injection, as well as carburetor and supercharger pressures, carburetor metering pressures, and other variables affected by icing.

In addition to the study of the effect of icing characteristics, the effectiveness of de-icing fluids and heated charge air as de-icing agents was also determined. The de-icing data were obtained by causing ice to form in the induction system until a predetermined air-flow decrease occurred. After the air flow had been reduced to the predetermined value, the de-icing air was turned on by reversing the hot and cold air dampers shown in figure 7 and the time for recovery of air flow and fuel metering was recorded. The effectiveness of the de-icing agent was evaluated on the basis of the time required to produce recovery of 95 percent of the maximum air flow corrected for density changes at a given throttle setting.

A study was also made of the effect of icing on the fuel distribution from the supercharger-outlet ports of a radial engine.

Dynamometer installation on complete engine.—The icing limits for a complete engine equipped with a carburetor-supercharger combination corresponding to one of the combinations used without the engine were determined on a

dynamometer stand. This investigation established the effect of a controlled ice formation on the power output and the operating characteristics of a complete engine and enabled correlation of the carburetor-supercharger-combination results with those obtained when such factors as engine vibration and heat dissipation from the operating engine were introduced.

Flight investigation.—An illustration of the induction system of one of the engines of a two-engine turbosupercharged fighter airplane, which was used to determine the effects of icing conditions on the system during both flight and ground investigations (references 16 and 17), is shown in figure 8. This engine was similar to the engine used for the dynamometer installation.

Icing conditions were simulated by spraying appropriate quantities of water into the carburetor scoop and into the intercooler cooling-air duct. Instrumentation was provided to obtain relative humidity, temperature, and pressure of the charge air at the carburetor deck. Fuel and air flows were determined from measurements of the metering pressures of the carburetor.

Light-airplane carburetor-inlet manifold combinations.—Investigations of light-airplane induction-system icing were conducted in the laboratory in a manner similar to that used for the large carburetor-supercharger installations. An exhaust system was used to induce a flow of conditioned air through the carburetor and manifold combinations. The icing characteristics of two typical light-airplane engine induction systems were investigated using carburetors and manifolds of engines in the horsepower ranges from 65 to 85 and 165 to 185. The smaller system consisted of a float-type carburetor with an unheated manifold and the larger system consisted of a single-barrel pressure-type carburetor with an oil-jacketed manifold.

ICING OF INDUCTION-SYSTEM ELEMENTS

Investigation has shown that some elements of an induction system are critically affected by very small quantities of ice, whereas other elements have a comparatively large icing tolerance. Protection that may be provided for some elements against the occurrence of one type of ice at given atmospheric conditions may not necessarily prevent malfunctioning or engine failure caused by other types of icing on other elements. Experiments have been made using many configurations under a variety of icing conditions to ascertain the critical location of ice formations with regard to each of the components of the particular system and to determine methods by which complete induction-system icing protection can be achieved.

INLETS AND DUCTS

With respect to icing, there are two important characteristics of inlets. The first characteristic to be considered is the icing of the inlet lips. Impact ice forms on the lips and impairs the aerodynamic efficiency of the inlet. In addition,

the possibility that large pieces of ice may break loose from the inlet lips and pass into the carburetor presents a hazard to proper carburetor operation. Exposed inlets are particularly subject to impact icing, such as that shown in figure 9(a).

The second characteristic is the ability of the inlet to prevent the passage of free water into other parts of the induction system. The ice formed by this free water may block air passages (fig. 9(b)) and hinder carburetor functioning. The direct-ram types of inlet (figs. 1(a) and 1(b)) have practically no water-separation effectiveness but protected inlets may prevent most of the free water from entering the system.

The principle of inertia separation can be applied in several ways to minimize the intake of water or other forms of precipitation into the induction system. For operating conditions in which ram loss is not a critical factor, the so-called ice guard in the form of a streamlined shield placed ahead of the air scoop or a reversible air scoop that could be rotated to provide a sheltered nonramming inlet are devices that have been proposed for water separation.

An efficient inlet design similar to that shown in figure 1(c) has been developed, which accomplishes inertia separation of most of the water droplets from the charge air by causing the air stream to turn sharply to enter the duct. The path of a water droplet in a curved air stream is de-

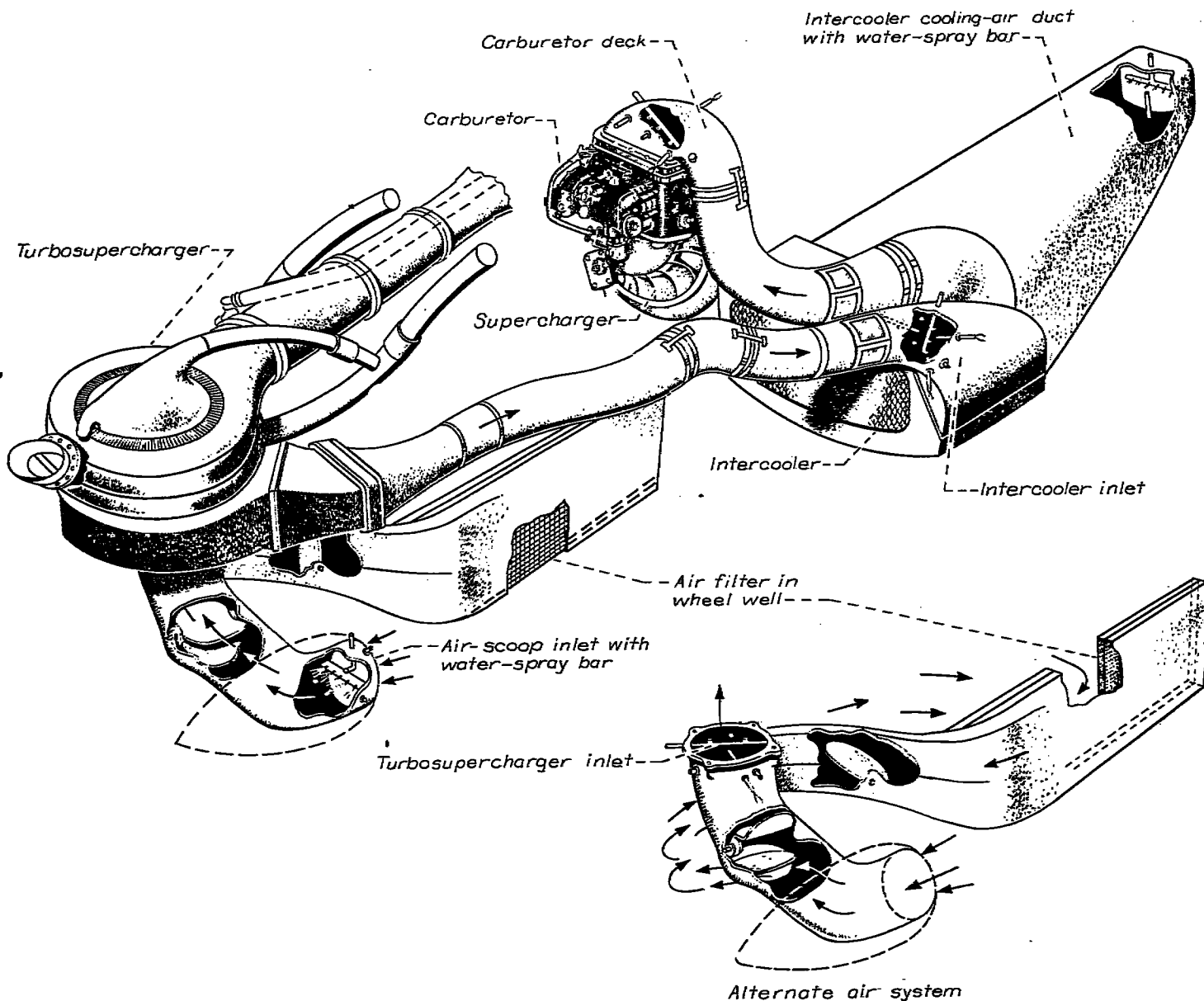

FIGURE 8.—Engine induction system of airplane used for flight icing investigations.

terminated by (1) the momentum of the droplet, which is a function of mass and velocity, (2) the drag force exerted by the air stream, and (3) the curvature of the air stream. Thus, a very small droplet moving with a low velocity along a streamline of small curvature will follow the streamline with little deviation. As the mass or the velocity of the droplet or the curvature of the air stream increases, the deviation of the droplet path from the original streamline will also increase. If these factors become sufficiently large in an air inlet, the droplet will separate from the entering air stream. Droplet paths near surfaces are difficult to calculate and the impingement of water can be more readily determined by experimental methods.

Most induction systems involve a sharp bend or elbow in the air passage ahead of the carburetor. Partial separation



(a)

C-23087

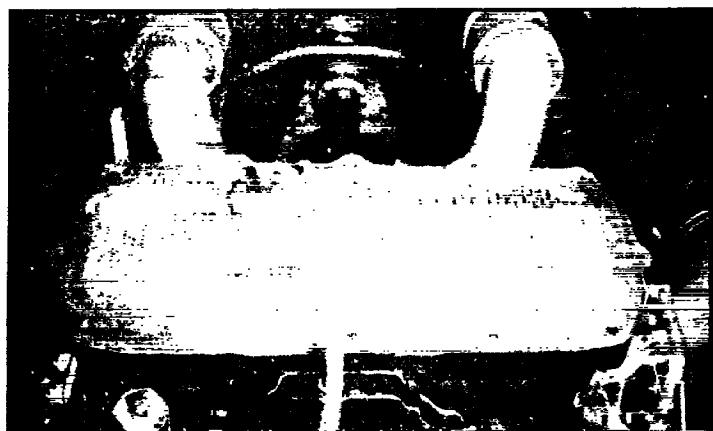

(b)

C-9804

- (a) Impact ice on scoop and duct walls.
(b) Impact ice on carburetor screen.

FIGURE 9.—Typical impact icing of induction-system parts

of water or snow can be accomplished by locating a plenum chamber or trap in the rear wall of this elbow. The separation efficiency of this type device is low, however, for small droplets and will vary considerably with different induction-system configurations. Furthermore, the device offers no impact-ice protection for the portion of the passage ahead of the elbow.

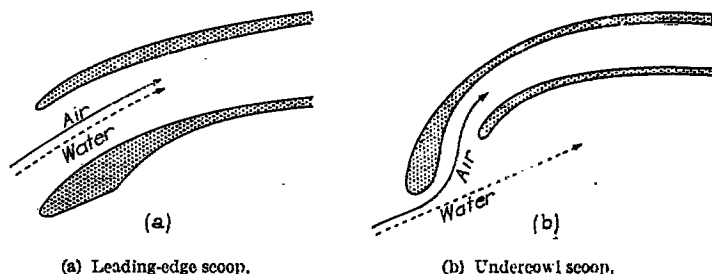

(a) Leading-edge scoop.

(b) Undercowl scoop.

FIGURE 10.—Air and water-droplet paths for conventional and undercowl scoops.

Investigations in the Lewis icing research tunnel have been conducted to determine the rate at which two types of inlet collect water. One of the inlets was a conventional ram-type inlet (fig. 1(b)), and the other was an undercowl scoop similar to that shown in figure 1(c). The front lip of the undercowl scoop was curved downward until the leading edge coincided with the former position of the leading edge of the lower lip on the conventional scoop. The rear lip was located as high and as far forward as possible to obtain the sharpest turn of the air streamlines without reducing the inlet area. Thus, as illustrated in figure 10, air and water droplets passed directly into the conventional scoop; but, in the undercowl scoop, most of the water droplets passed through the engine cooling-air passage.

The results of the tunnel investigation indicate that the undercowl scoop is very effective in removing water droplets of the size that may be encountered in rain or mist, admitting less than 5 percent of the water entering the conventional scoop and maintaining better ram recovery than the conventional scoop at all angles of attack for simulated cruise-power conditions and at high angles of attack for simulated-climb conditions. Typical results obtained in the investigation are shown in the following table where

collection efficiency

$$\frac{\text{actual rate of water intake}}{(\text{volume flow of air}) (\text{water concentration})}$$

	Ram-type inlet	Undercowl scoop
Tunnel-air velocity, ft/sec.....	235	235
Angle of attack, deg.....	4	4
Volume flow, cu ft/sec.....	26.2	26.2
Liquid-water content, grams/cu m.....	1	1
Droplet size (max.), microns.....	85-120	85-120
Collection efficiency, percent.....	84	4
Ram recovery (dry air), percent.....	76	91

Carburetor-screen icing experienced with the undercowl scoop was negligible compared with the excessive and rapid formations experienced with the conventional scoop under similar conditions. Photographs of the comparative ice formations are shown in figure 11. Examination of the inertia-separation duct following exposure to icing conditions

in the icing research tunnel showed that some secondary inertia separation takes place, as evidenced by light ice deposits on the top of the duct beginning just downstream of the inlet. The magnitude and the extent of such secondary separation depends on the effectiveness of primary separation, the air velocity in the duct, the droplet size, and the radius of curvature of the duct passage. Secondary separation aids in the elimination of water from the carburetor air but may

possible for the rear lip. Complete elimination of water is difficult to achieve with an inertia-separation system, especially when very small droplets are encountered.

Flight operating experiences of a multiengine transport, with one engine equipped with an undercowl inlet similar to that shown in figure 1(c), have demonstrated that this type of inlet provided protection against icing under conditions where heat or alcohol was necessary to prevent icing in the other engines. Statistical measurements conducted during several years show that the droplets encountered in these flights were probably less than 30 microns in diameter (reference 23).

AUXILIARY SUPERCHARGED SYSTEMS

The icing characteristics of an induction system incorporating a supercharger ahead of the carburetor are affected by the heat input of the compressor, the inertia-separating characteristics of the system, and the heat losses. The heat input by the turbosupercharger in the flight investigation of a twin-engine fighter airplane (reference 17) resulted in a temperature rise of approximately 36° F at take-off power (manifold pressure, 50 in. Hg absolute) at a pressure altitude of 3500 feet. Although the intercooler-outlet flaps were fully closed, this temperature rise of the charge air was reduced 50 percent in passing through the intercooler. It has been found that good inlet-control flaps must be provided to prevent circulation within the duct and excessive cooling resulting from local circulation at the face of the intercooler.

Some turbosupercharged induction systems accomplish effective water separation and reduce the susceptibility of icing. The system used for flight investigation (reference 17), however, was subject to impact icing, and in one instance the alternate air valve, which was close to the scoop inlet, became frozen in the closed position and no warm air was available for ice protection. The intercooler of this configuration was at the lowest point in the induction system, and water that was blown along the duct as far as the intercooler collected in the lower intercooler header instead of blowing over to the carburetor. A small amount of water did reach the carburetor, however, when a heavy rain was simulated and the engine was operated at high power.

The water-separation ability of auxiliary supercharged induction systems will depend on the particular configuration. Reduction in the quantity of water that arrives at the carburetor and the heat supplied by the compressor will make conditions for icing less severe at the carburetor deck than when an exposed ramming scoop leads directly to the carburetor.

CARBURETOR-SUPERCHARGER COMBINATIONS

Impact, throttling, and fuel-evaporation icing characteristics of several carburetor-supercharger combinations have been investigated as a function of the carburetor-inlet air conditions. A study has been made of the effect of various factors, such as configuration of the system, throttle design,

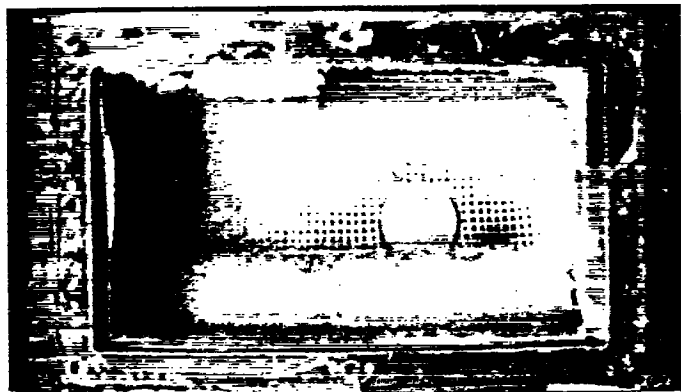

(a)

C-10051

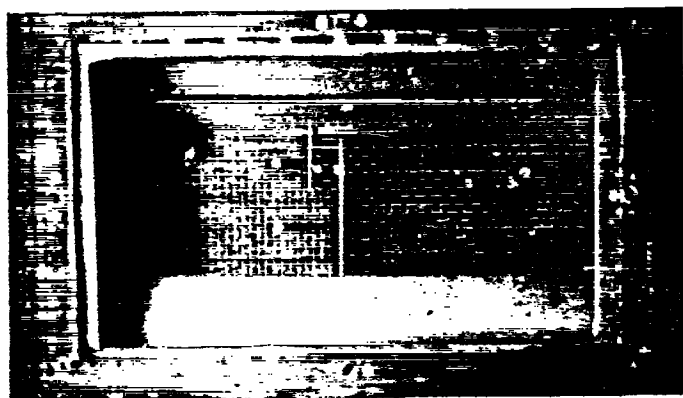

(b)

C-10055

(a) Leading-edge scoop.
 (b) Undercowl scoop.

FIGURE 11.—Comparison of carburetor-screen icing experienced with conventional and undercowl scoops. Air temperature, 25° F; airspeed, 160 miles per hour; air flow to engine, 12,000 pounds per hour; icing time, 15 minutes.

cause ice formations that become the critical restriction in the system if the design does not incorporate sufficient cross-sectional area for some icing tolerance. A high degree of primary separation minimizes the danger of ice formation due to secondary separation. The design of an undercowl scoop requires some compromise between good water-separation characteristics and adequate ram recovery. Experiments have indicated that maximum water separation can be achieved by providing a large circumferential width, a small front and rear gap between the lips, and a location as high as

fuel-discharge system, and power conditions on the icing characteristics. The photographs in figures 9(b), 12(a), and 12(b) show typical impact icing on the carburetor screen and fuel-evaporation icing on the throttles and in the supercharger-inlet elbow, respectively.



(a)

C-7590



(b)

C-7589

- (a) Underside of throttles.
(b) Supercharger-inlet elbow.

FIGURE 12.—Typical fuel-evaporation-ice formations.

Representative limiting curves of serious and visible icing are plotted on the basis of carburetor-air temperature with relation to humidity ratio in figure 13. Lines of constant enthalpy, relative humidity, and liquid-water content are also shown. Although the term *humidity ratio* applies strictly to the ratio of water vapor and air, for convenience the liquid-water content has also been included in the humidity-ratio term herein.

Fuel-evaporation icing occurs throughout the entire region below the visible-icing-limit curve. Serious fuel-evaporation icing shown in the area below the serious-icing-limit curve represents icing that results in an air-flow reduction of 2 percent or a fuel-air-ratio change of 6 percent within 15 minutes. In addition to fuel-evaporation icing in the

serious-icing range, throttling and impact icing also occur. Experimentally determined serious throttling icing has been found to occur only at air temperatures below 39° F with humidity ratios in excess of saturation; impact icing is encountered at carburetor-air temperatures of less than 32° F with humidity ratios also in excess of saturation.

The icing characteristics with the effects of various factors were experimentally investigated for the nine configurations shown in figure 14.

Serious-icing limits.—The experimentally observed limits of serious icing for several carburetor-engine configurations operated at simulated-cruise power are presented in figure 15. The effect of humidity ratio on systems of different design is readily discernible. Serious icing was observed at a relative humidity as low as 41 percent at 66° F for a system with butterfly throttles, X-bar fuel nozzle directly below the throttle, and unheated turning vanes (configuration C). For a system with variable throttle and no turning vanes (configuration B), no serious icing was observed at relative humidities of less than saturation at any temperature above 32° F. Serious icing, which occurred in the systems shown in figure 15, nearly always consisted of a combination of fuel-evaporation and throttling ice.

Throttles and other protuberances.—Aerodynamic cleanliness of the induction system has an important bearing on the icing characteristics of the system. Throttles, unheated turning vanes, or other protuberances such as impact tubes, boost venturis, altitude compensators, and fuel-discharge nozzles are susceptible to the accretion of one or more of the three types of icing. Serious icing is shown in figure 15 to be prominent in systems containing turbulence-producing protuberances near the fuel spray, such as X-bar fuel nozzles (configurations A and C), or obstacles downstream of the fuel spray, such as turning vanes (configurations C and D).

Throttle setting.—The effect of throttle setting is shown in figure 16, where the limits of serious icing are given for three of the systems at low cruise and rated powers. When higher power was used and the throttles were further open, turbulence near the fuel nozzle was reduced. Thus systems C and E containing butterfly-type throttles were much less susceptible to serious icing at humidity ratios less than saturation than they were at the lower power condition. Thus, the limit for serious icing for system C was raised from a minimum of 41-percent relative humidity at low cruise power to a minimum of approximately 90-percent relative humidity for all temperatures at rated power, and serious icing at humidity ratios of less than saturation was completely eliminated in system E at the higher power condition. Configuration E, in which there are no turning vanes, also shows improved icing characteristics at high power for humidity ratios greater than saturation with a reduction in the upper limit of icing of approximately 15° F. Configurations C and D, utilizing turning vanes, became more susceptible to serious icing at high power for humidity ratios greater than saturation because the increased water

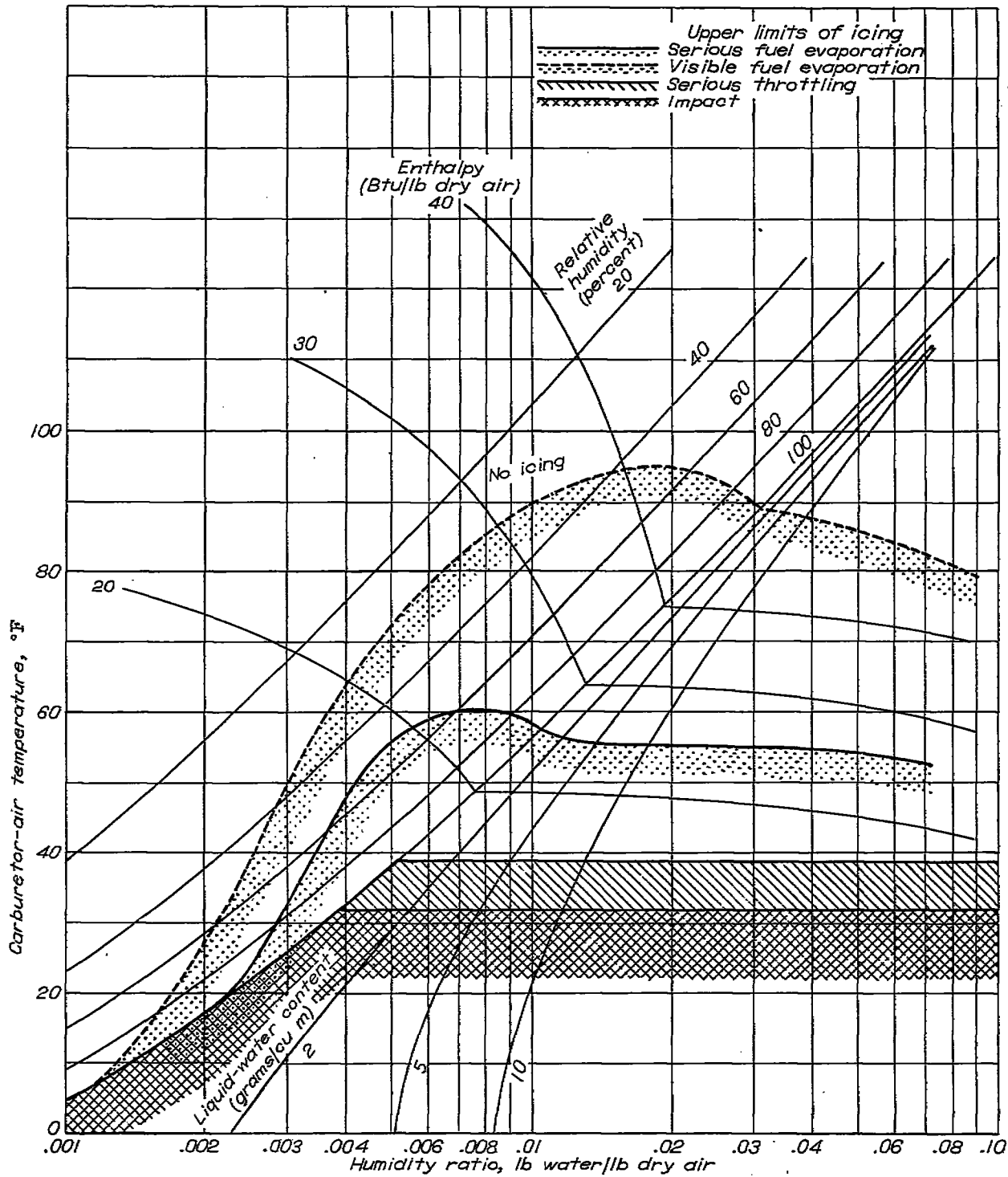

FIGURE 13.—Representative limits of visible and serious icing in engine induction system. Carburator-deck pressure, 23.86 inches mercury absolute.

available at the higher mass air flows resulted in icing of the turning vanes and thereby produced critical restriction to air flow; the upper limit of serious icing was therefore raised by approximately 5° to 10° F. A more detailed observation of the effect of throttle position on the formation of serious icing is given in references 19 and 27.

Type of throttle.—In configuration B, where variable-venturi throttles permitted relatively smooth, unobstructed flow of the throttled air stream to the impeller inlet, the condensate from throttling and fuel evaporation in clear-air conditions was carried away from the critical-icing areas before it could build up to dangerous ice formations. In

this type of system, serious icing was encountered only when water flowed over carburetor and duct surfaces. Favorable icing characteristics were shown for liquid-water contents up to 3 grams per cubic meter (fig. 15). Butterfly-type throttles, such as used in configuration E, caused turbulence in the wake of the throttles, which resulted in serious-ice formations on the throttles and the adjacent walls. (See fig. 16.)

Engine size.—The effect of the size of similar carburetor-engine combinations on serious-icing limits when the engines were operated at comparable fractions of rated power is shown in figure 17. No appreciable difference in the icing limits was observed when a variable-area venturi throttle

together with a fuel-discharge nozzle bar was used (configurations B and F) or when a fuel-injection slinger ring was used at the impeller (configurations G and H). The displacement of each of the larger systems F and H was approximately 1.4 times that of the comparable smaller systems B and G.

Fuel-metering systems.—The type of fuel-metering equipment used in an engine is frequently the principal factor governing the critical-icing characteristics of the induction system. In some systems, the carburetor is the part of the induction system least able to tolerate even small amounts of any of the three types of icing. In general, fuel metering is affected by the formation of ice on or near the pressure-

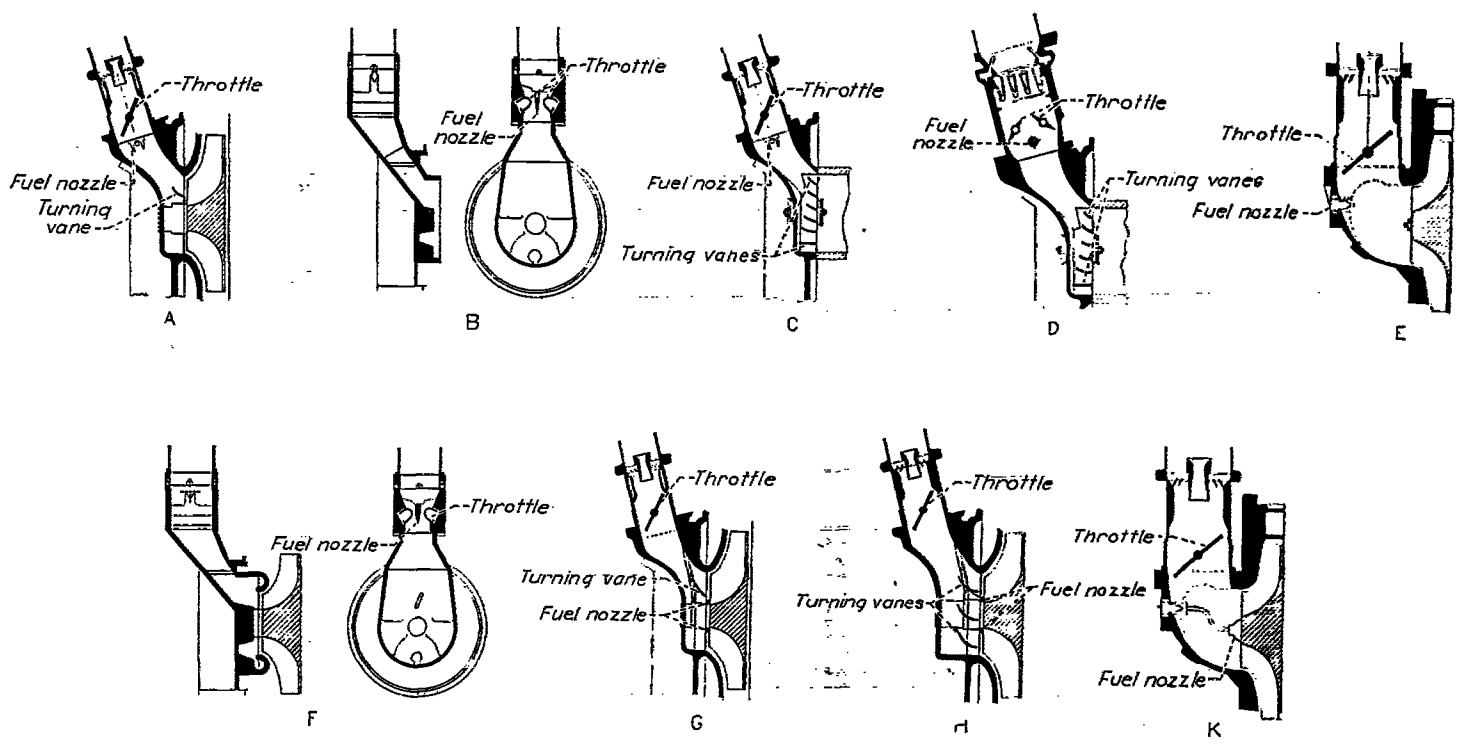

Configuration	Carburetor		Fuel-nozzle type and location	Engine size and type
	Air-passage shape	Throttle type		
A	Twin barrel	Butterfly	X bar downstream of throttle	14-cylinder, radial.
B	Rectangular	Variable venturi	Bar between venturis	9-cylinder, radial.
C	Twin barrel	Butterfly	X bar downstream of throttle	14-cylinder, radial.
D	Rectangular	Twin rectangular	Bar downstream and between throttles	14-cylinder, radial.
E	Twin barrel	Butterfly	Nozzle in supercharger-inlet elbow	12-cylinder, V.
F	Rectangular	Variable venturi	Nozzle bar between venturis	14-cylinder, radial.
G	Twin barrel	Butterfly	Slinger ring at impeller	14-cylinder, radial.
H	Triple barrel	Butterfly	Slinger ring at impeller	18-cylinder, radial.
K	Twin barrel	Butterfly	Slinger ring at impeller	12-cylinder, V.

FIGURE 14.—Carburetor-engine configurations A to K used in determining induction-system icing characteristics.

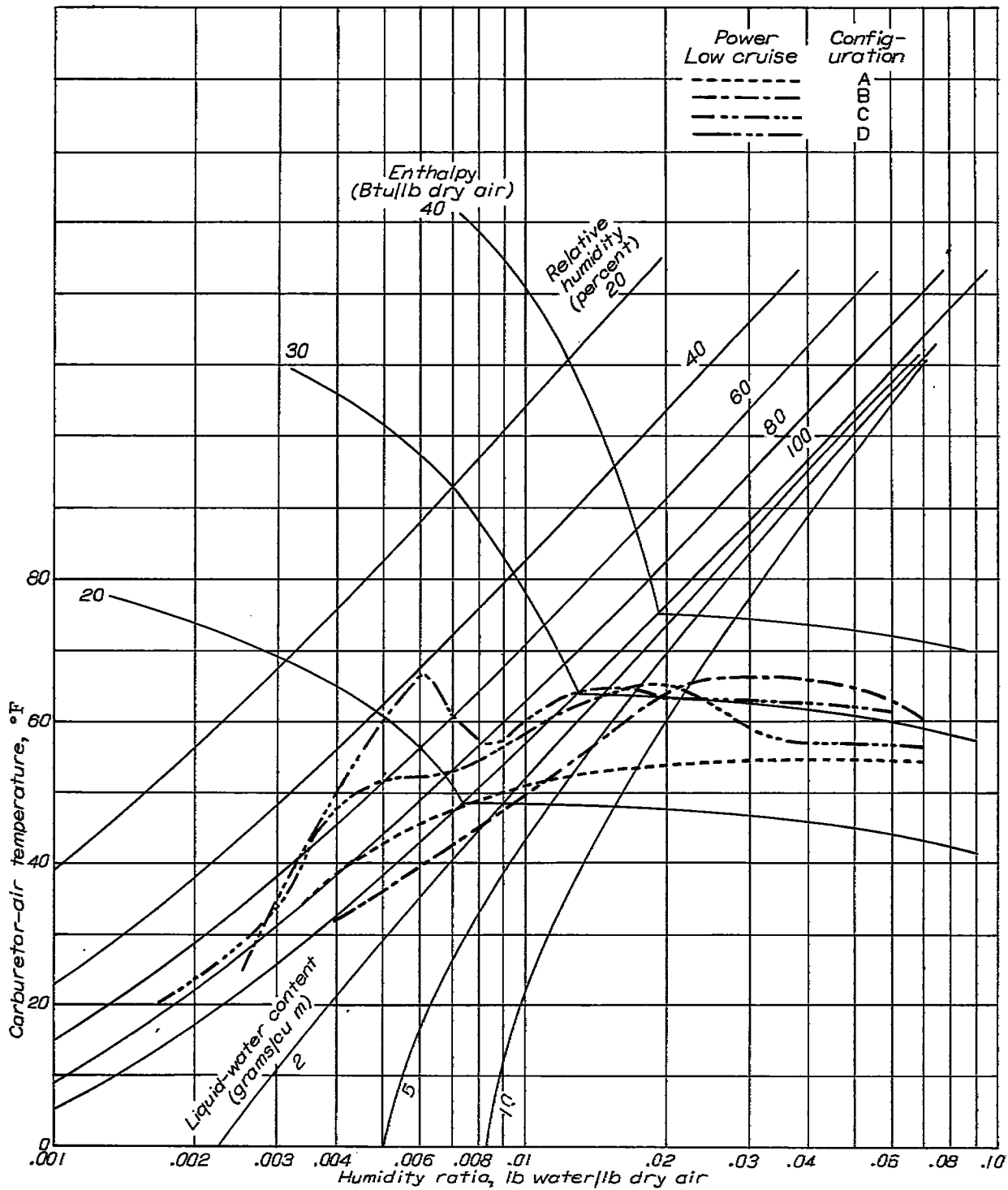

FIGURE 15.—Limiting serious-icing conditions for several different carburetor-engine configurations at simulated low-cruise power.

sensing elements or in the small passages of the air-metering side of the carburetor. Icing of the throttle causes reduction in air flow and in severe cases may sufficiently alter the air and the fuel-air-ratio distribution to the cylinders to cause engine roughness.

Another problem closely associated with carburetor icing,

which displays similar symptoms and must be given careful consideration in design, is water accumulation within the metering passages of the carburetor. For engines that have been designed to operate near the minimum satisfactory limits of fuel-air ratio with critical metering differential pressures, water accumulation in the metering passages of the carbu-

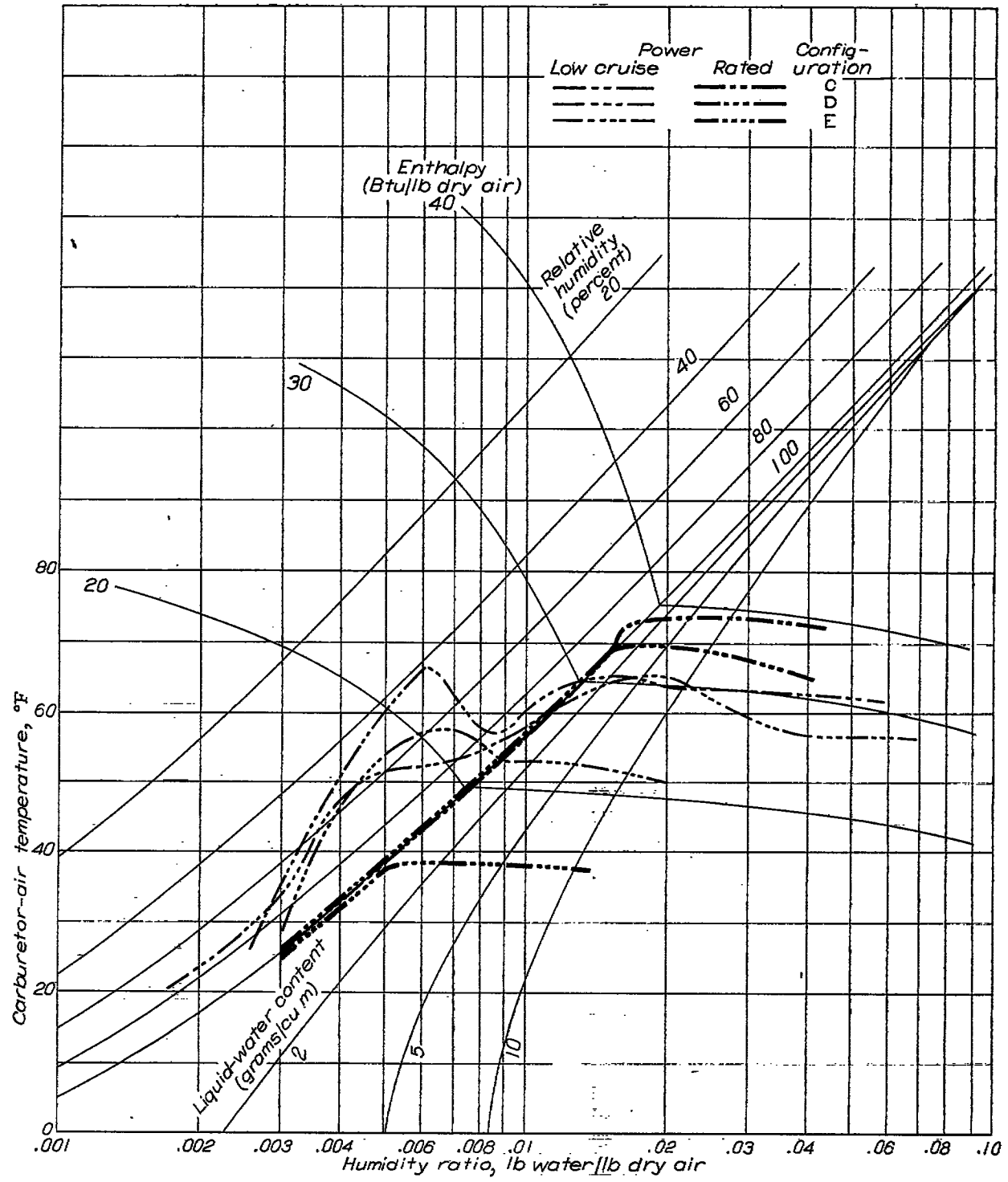

FIGURE 16.—Effect of throttle setting on serious-icing limits of three carburetor-engine configurations.

retor due to direct water intake or melting ice will cause erratic operation and may result in abrupt and complete engine stoppage. Sluggishness in restoring proper fuel-air ratio after completely de-icing the system is also an indication of this trouble. Some carburetors are more sensitive

than others, but generally the effects of water in a carburetor are unpredictable. Fuel-metering systems that incorporate adequate water drains or that avoid the use of exposed pressure-sensing elements and air-circulating passages can eliminate this problem.

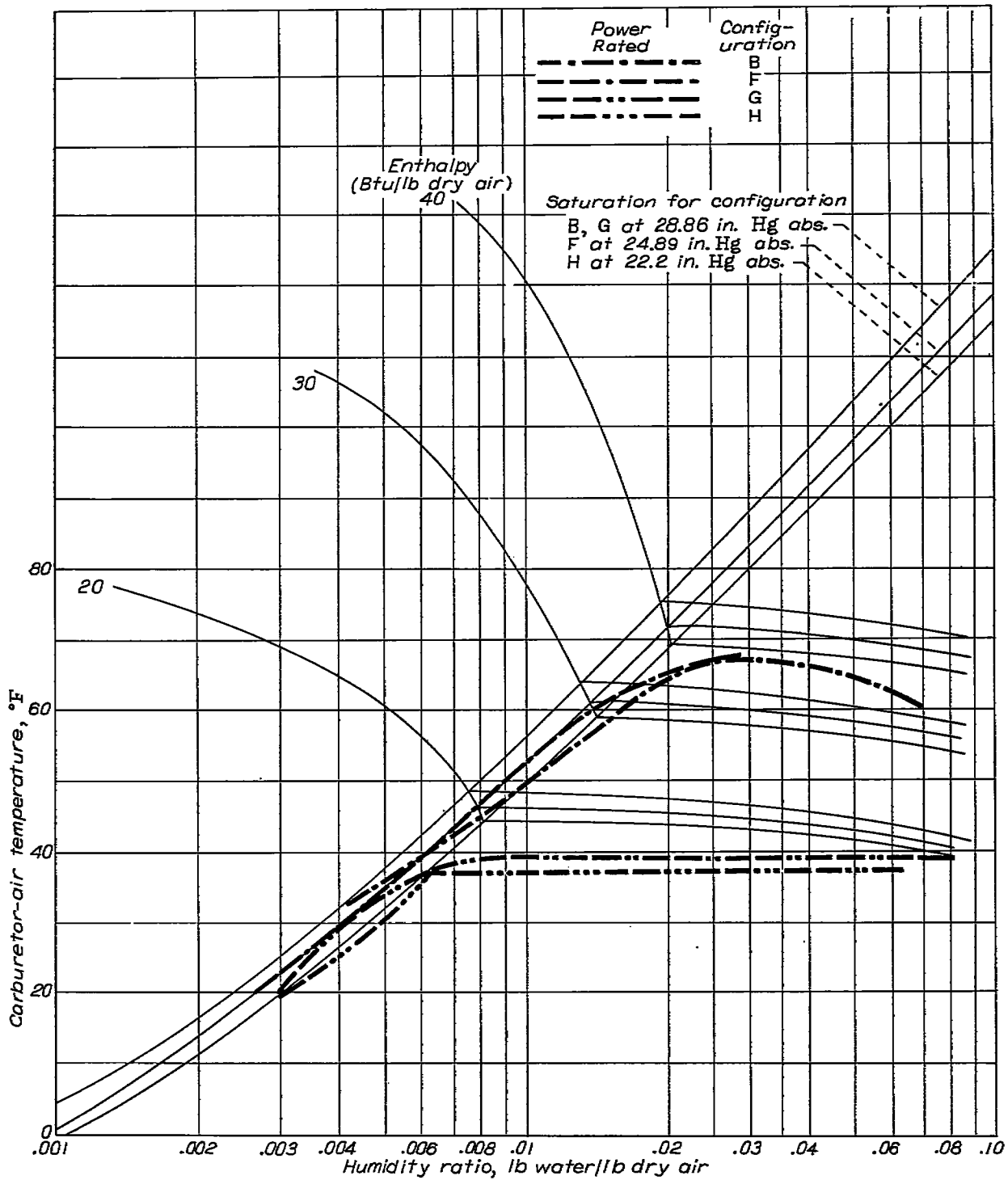

FIGURE 17.—Effect of engine size on limiting serious-icing conditions for similar carburetor-engine configurations operated at comparable fractions of rated power.

Location and type of fuel-discharge system.—Location of the point of fuel discharge and the type of fuel-discharge system used are very important in the design of an ice-free system. A system in which the fuel spray contacts only adequately heated or otherwise suitably protected parts will be free from fuel-evaporation icing. Examples of such

systems are those incorporating injection into the supercharger impeller, injection into the cylinder inlet pipes, which are heated either by supercharging or by conduction from the engine, or direct injection into the cylinder (references 10, 18, and 27).

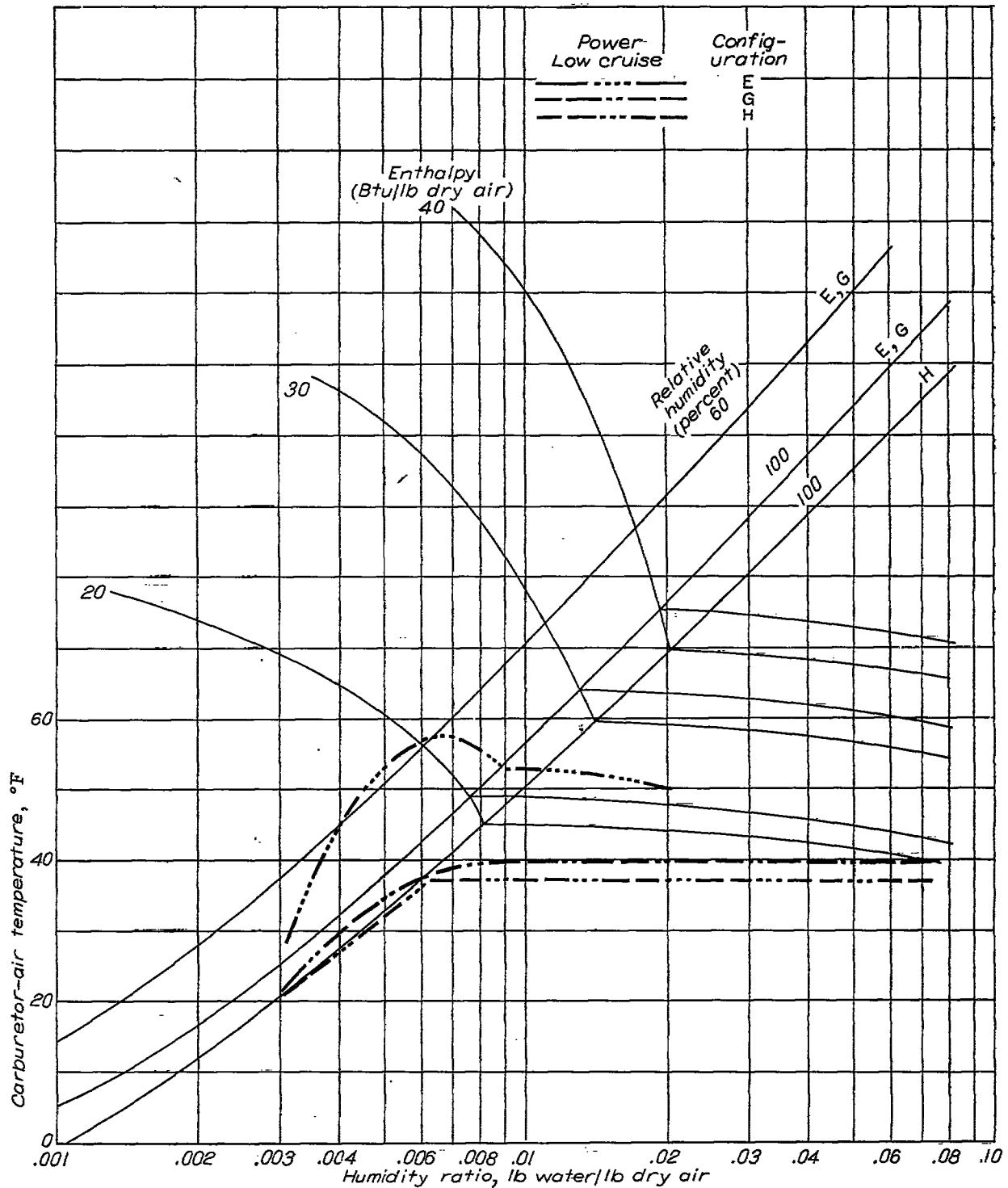

FIGURE 18.—Icing characteristics obtained with two systems having impeller fuel injection (configurations G and H) compared with system having fuel discharge below throttle (configuration E).

A comparison of the limiting serious-icing conditions for a system with fuel injection near the throttles (configuration E) and for two systems in which the fuel is injected from a slinger ring at the supercharger impeller inlet (configurations G and H) is presented in figure 18. Configuration E was modified (configuration K) to incorporate an impeller fuel-injection system similar to that used in configurations G and H. A complete determination of the limits of icing was

not made, but visual observation during the course of the investigation showed that no fuel-evaporation ice was present. The curve representing the icing limits for configuration K should therefore be similar to those for configurations G and H. The maximum temperature at which icing occurs for configuration E is approximately 57° F, compared with approximately 38° F for configurations G and H (and probably K).

OPERATING VARIABLES

Some of the operating factors that affect the icing of an induction system are: (1) throttle position during the icing condition, (2) mixture setting selected, (3) correct or incorrect use of carburetor heat, (4) water injection for power increase, and (5) pilot operating technique.

Operation at conditions requiring small throttle openings is conducive to throttling and fuel-evaporation icing, which has been discussed. Flight at high altitudes requires large throttle openings and therefore has reduced susceptibility to icing. Similarly, the susceptibility to icing at high-power settings is small because of the wide throttle opening at these conditions.

The use of a manifold pressure regulator that acts to maintain the manifold pressure by opening the throttle as ice forms and restricts the flow may cause the throttle to be moved to the wide-open position before the pilot has any indication that ice is forming in the induction system. This type of operation may therefore be hazardous.

The effect of mixture setting on icing is negligible because in the leanest setting all the fuel is not evaporated and increased fuel-air ratio does not result in further temperature reduction. Control of the mixture setting may give an extra margin of safety during icing because ice formation within the carburetor often results in a leaner mixture and the engine can be operated for a longer time by changing to a richer mixture-control setting.

Incorrect use of carburetor heat can change a nonserious dry-snow condition into a serious-icing condition by melting the snow and causing additional moisture to be made available for the throttling and fuel-evaporation icing processes.

The results of an investigation reported in reference 21 indicate that water injection with fuel for purposes of increasing maximum power output creates serious-icing conditions. The use of water-ethanol fuel mixtures resulted in no icing of serious consequence for temperatures as low as -20°F .

Engine operation in which the throttle setting is constant for long periods of time has resulted in ice accretions of serious magnitude in icing conditions that would not ordinarily be considered serious. Idling for some time before take-off may also have the same result. Extended operation in an icing condition has caused the throttle to become inoperative because of ice accumulations around the throttle shaft both in the laboratory (reference 15) and in flight investigations (reference 28).

FUEL VOLATILITY

Another factor that affects the icing characteristics of an induction system is the volatility of the fuel. In the laboratory investigation of the icing characteristics of an induction system (reference 15), the use of S-4 reference fuel (isooctane) with no light fractions caused less fuel-evaporation icing than AN-F-22 fuel in a similar length of time. The AN-F-22 fuel consisted of fractions, 85 percent of which were more volatile than S-4 reference fuel. The AN-F-28, Amendment-2 fuel, more like S-4 fuel in volatility, also produced less air-

flow drop due to icing than did AN-F-22 fuel in a similar period.

MIXTURE DISTRIBUTION

During the laboratory investigation of a carburetor-supercharger combination with spinner-type fuel injection as used on a double-row radial engine (configuration H), a study was made of the effect of ice on the distribution of fuel-air mixture to the various inlet pipes. The mixture distributions obtained with both dry air and impact icing at a carburetor-air temperature of 25°F are shown in figure 19. A consider-

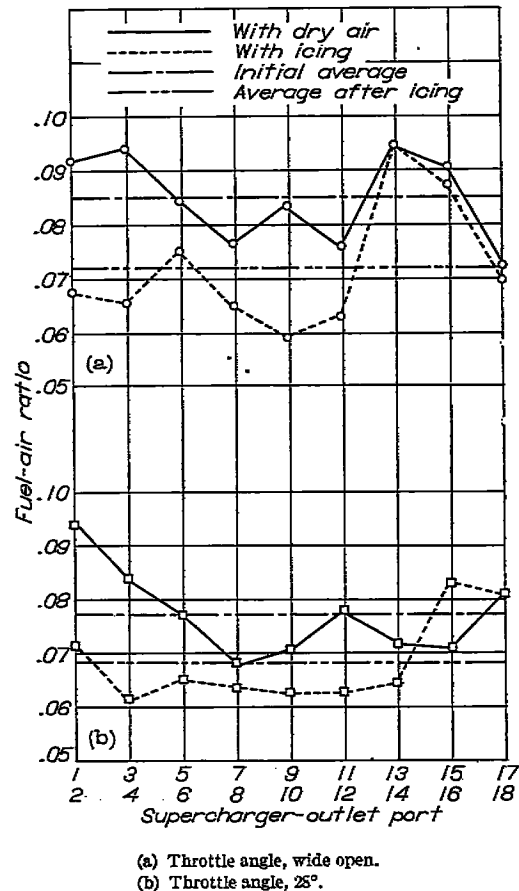

FIGURE 19.—Effect of icing on mixture distribution. Air temperature, 25°F ; air flow, 7000 pounds per hour reduced to 6500 pounds per hour by icing.

able spread in fuel-air ratio between the richest and leanest cylinders was observed under both nonicing and icing conditions. The spread between the richest and leanest cylinders was from 0.094 to 0.068 under nonicing conditions at a throttle angle of 28° (fig. 19(b)), and varied from 0.095 to 0.059 under impact-icing conditions at wide-open throttle (fig. 19(a)). At the wide-open throttle setting, icing lowered the average fuel-air ratio and increased the spread in fuel-air ratio. Icing lowered the average fuel-air ratio at the 28° throttle setting, but the spread in fuel-air ratio was not as great as that occurring without icing. The most significant effect of impact icing at the carburetor is the reduction in over-all fuel-air ratio with the resultant possibility that the fuel-air ratio to one or more of the leanest cylinders might be well below the lower limit of combustion. The serious re-

duction of fuel-air ratio under icing conditions was attributed to the accumulation of water or ice in the air-metering passages of the carburetor. The change in mixture-distribution pattern and spread in fuel-air ratio delivered to the various inlet pipes was attributed to changes in the air-flow distribution due to local ice deposits.

The effect of ice blockage of the carburetor screen on carburetor metering and mixture distribution is, in general, unpredictable and varies with change in air-flow profile. In order to simulate the blocking effect of large pieces of ice, which are sometimes dislodged from upstream duct walls and deposited on the carburetor screen, various sections of the screen were blocked for part of the mixture-distribution investigation (reference 10). The results obtained showed that on an engine with the supercharger impeller rotating in a clockwise direction, blocking of 25 percent of the screen adjacent to the left edge produced the greatest effect. The fuel-air ratio spread between the richest and leanest cylinders increased to 0.029, as compared with 0.020 (reference 10) and 0.026 obtained with no blocking (fig. 19). An increase in average deviation from the over-all fuel-air ratio of approximately 0.002 was also experienced, but was not considered large enough to be serious.

LIGHT-AIRPLANE INDUCTION SYSTEMS

The limiting icing conditions at low cruise power of two light-airplane carburetor-manifold combinations (reference 20) are shown in figure 20. Configuration L is a conventional updraft float-type carburetor with an unheated manifold for engines of 65 to 85 horsepower, and configuration M is a small updraft pressure-type carburetor with an oil-jacketed manifold for engines of 165 to 185 horsepower. The curves shown in figure 20 for configuration M represent conditions for which no heat was supplied to the manifold and provide a comparison of the icing characteristics of the float-type and pressure-type carburetors under similar conditions.

Both carburetors were susceptible to icing at glide power (fig. 20) primarily because of the design of the idling fuel-discharge systems: the float-type system because of ice formation around the idle-fuel discharge holes, and the pressure-type system because of extreme variations of the fuel-air ratio. In the pressure carburetor (configuration M), icing on or near the throttles seriously affects fuel-air ratio because the fuel flow in the idling range is controlled by a mechanical linkage to the throttle mechanism and the fuel flow is a function of the throttle position rather than a function of the air flow. Eddying fuel in the turbulent wake of the nearly closed throttle caused fuel-evaporation icing at the throttle plate, which restricted the air flow, whereas the fuel flow remained unchanged.

Heating the manifold with oil at 170° F circulating through the jacket eliminated serious icing at low cruise power and reduced the visible-icing range to carburetor-air temperatures below 60° F.

INDICATION AND DETECTION OF ICING

The presence of ice in an induction system may be relayed to the pilot in different ways, depending on the type of carburetor-engine combination, the ice location, and the supplemental equipment used on the installation. For airplanes operating at a constant pressure altitude and throttle setting, an air-flow loss due to blocking by ice formations results in a reduction in the manifold pressure. A torquemeter also provides indication of power loss due to icing on airplanes equipped with this apparatus. Aircraft engines having fixed-pitch propellers indicate power loss due to icing by a reduction in engine speed. Icing that occurs on the fuel-metering parts of the system may be indicated by a change in fuel flow, if a flowmeter is provided, and is evidenced by surging, engine roughness, backfiring, and, in extreme cases, complete engine stoppage. Operation at reduced power or idling is frequently impossible if icing occurs on the metering parts of the carburetor. For engines equipped with automatic manifold pressure regulators, the presence of ice in the air passage is not evident until the throttle has reached the wide-open position unless a throttle-position indicator is used. The manifold pressure regulator may therefore be hazardous in the presence of icing because further power is unavailable until de-icing can be accomplished.

Numerous instruments have been designed for the particular purpose of detecting ice in aircraft-engine induction systems. These instruments have utilized several different principles of operation (reference 5) including interruption of a light beam focused on a photocell, the blocking of special air passages to upset a pressure-differential system, a comparison of pressure drop through an ice-free air passage and the induction system, and the change in capacitance between charged plates due to icing.

None of these ice detectors is entirely satisfactory because of the difficulty in locating the sensing elements in positions in which they will register any type of icing that may occur in the system at the respective critical location. An instrument that would detect only one type of icing at its particular area of susceptibility would have limited utility. Several ice detectors have been developed that are sufficiently sensitive to ice formation, but are erratic and indicate falsely. The pressure-differential and capacitance systems have required high sensitivity. Under such circumstances, water in the pressure tubes or on the charged plates may produce an erroneous indication of icing. A suitable ice detector must be an extremely reliable instrument to retain pilot confidence. Failure of the detector to indicate ice might cause the pilot to delay or to neglect carburetor heat or other protective means and possibly prevent adequate corrective measures.

In general, the use of ice-warning devices has been unsatisfactory and none has been accepted for general use. For those systems not fully protected, a direct indicating unit is needed to replace the close observation that is required to detect the effects of icing.

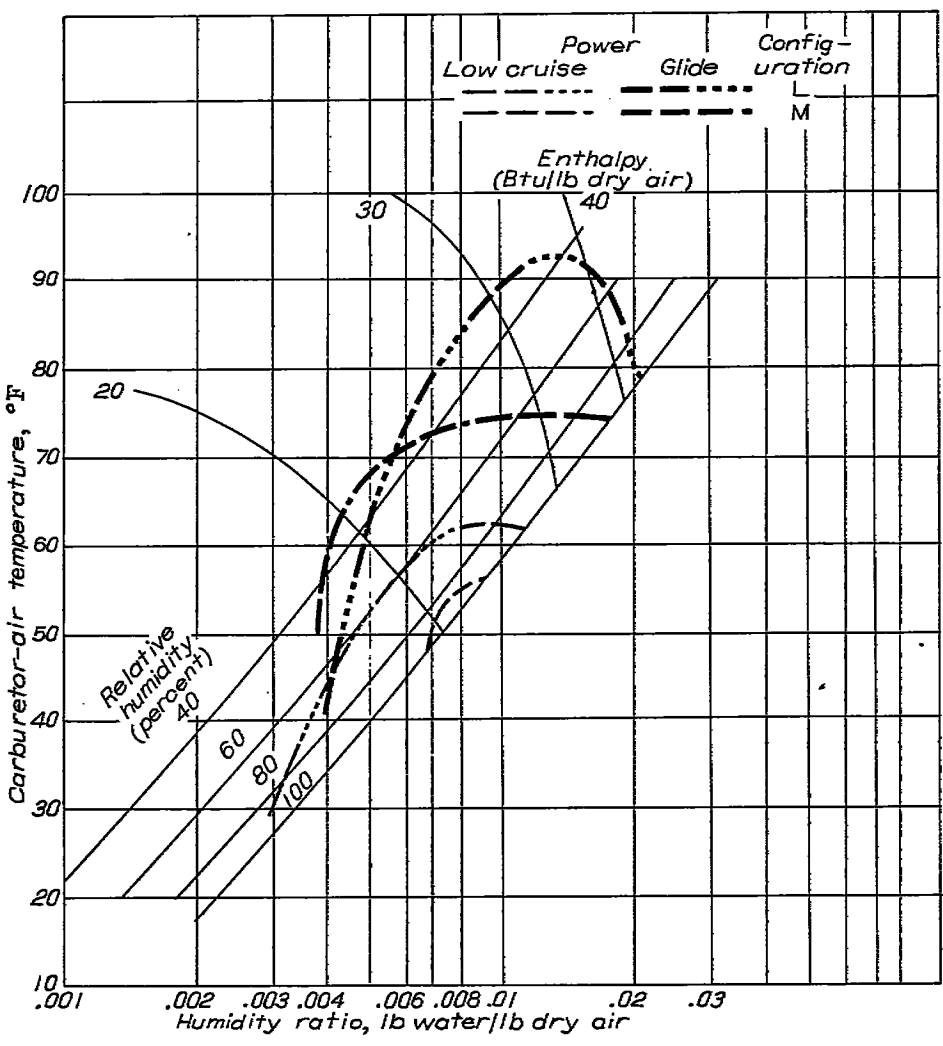
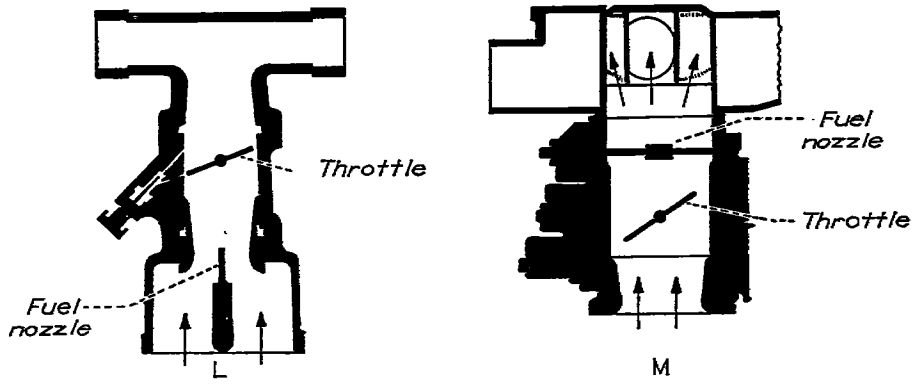

FIGURE 20.—Limiting serious-icing conditions for two light-airplane carburetor-manifold combinations.

ICE PREVENTION AND REMOVAL

Analysis of the factors that cause induction-system icing indicates two general methods for combating the icing problem: (1) design of an inherently ice-free system, and (2) application of measures to remove and to prevent ice formations. The first method is the most logical solution to the problem because the pilot need not be concerned with

malfunctioning of anti-icing equipment. In some installations, however, removal and prevention of ice formations may be more convenient than to provide an inherently ice-free system. A combination of both methods will frequently provide a satisfactory arrangement. The most suitable means of ice protection will be determined by the design features and use of a particular aircraft.

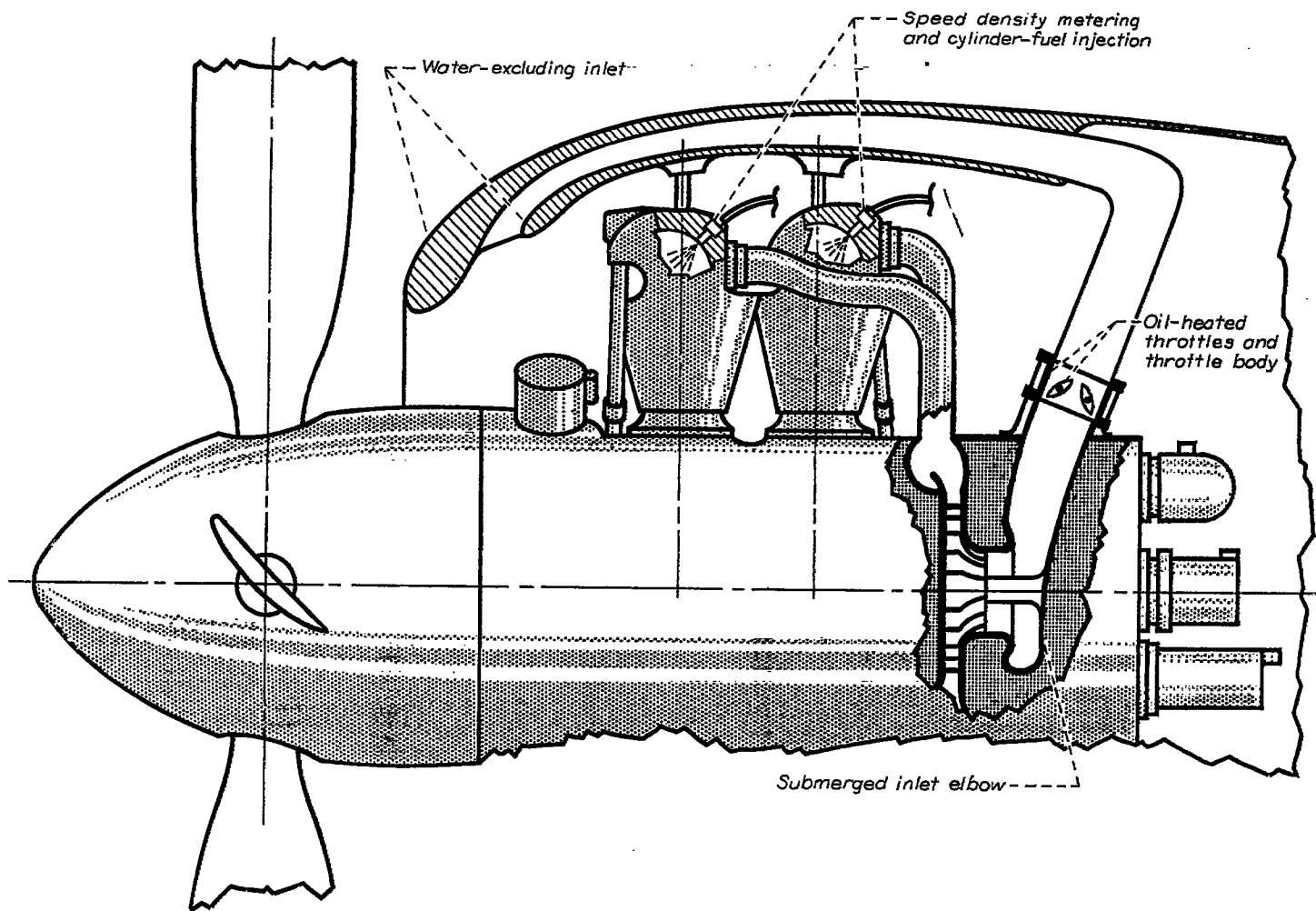

FIGURE 21.—Schematic diagram of induction system incorporating ice-prevention features.

ELEMENTS OF ICE-FREE SYSTEMS

An induction system incorporating features to reduce the intake of free water into the system, to prevent throttling icing, and to eliminate fuel-evaporation icing is illustrated in figure 21.

Elimination of impact ice.—Impact icing can be prevented if the free water is eliminated from the air that contacts or flows through the induction system. As pointed out in the discussion of icing of inlets and ducts, a system that incorporates some type of inertia separation can be made to eliminate most of the free water from the inlet air. The elimination of free water in the system will eliminate the icing conditions represented by the area to the right of the saturation line in figure 13. Complete water elimination is very difficult to achieve, but sufficient protection can be afforded by careful and proper design of an inertia-separation system that will maintain high ram recovery and insure safe engine operation in impact-icing conditions.

Elimination of throttling ice.—Throttling ice can be eliminated by locating the throttling device in a warmed region, such as between the engine-stage supercharger and the

cylinders, or by the application of heat to the conventional throttle, throttle body, and downstream surfaces (fig. 21).

Double opposed throttles or variable venturi throttles in rectangular carburetors were found to be relatively free from throttling ice as compared with the butterfly-type throttle. Many British carburetors and throttle bodies with butterfly-type throttles, however, are automatically protected from icing by the forced circulation of hot engine oil through carburetor jackets and hollow throttle plates. Throttling ice can be eliminated without resorting to special heating by locating the more desirable types of throttle in a warm region of the induction system.

Elimination of fuel-evaporation ice.—Fuel-evaporation ice, which occurs when removal of the latent heat of vaporization of fuel cools the air stream and surrounding metal parts below freezing, may be effectively prevented by injecting the fuel at any location beyond which the passage surfaces are maintained above freezing. Thus, injection of the fuel directly into each cylinder (fig. 21) will obviously preclude the possibility of fuel-evaporation icing. In engines with centrifugal superchargers, fuel-evaporation ice can be eliminated by introducing the fuel at or downstream of the

face of the impeller in a manner that will avoid splashback of the fuel from the impeller blades, such as can occur if the injection device is stationary (reference 18). The use of impeller fuel injection limits icing to throttling and impact types that occur below 40° F (fig. 18).

MEASURES TO PREVENT OR REMOVE ICE

Heated air.—The entire induction system can be protected from icing by heating the charge air with an attendant sacrifice of full throttle power. The amount of heat required for ice protection must be sufficient to raise the temperature above the limiting conditions and will therefore vary considerably with different induction systems. In order to determine the specific requirements of a particular installation, the air conditions required to prevent icing in that installation must be determined. Thus, the maximum values of temperature at which icing occurs in each induction system are also the minimum values of carburetor-inlet-air temperature required to insure adequate protection against icing in the respective systems (figs. 15, 16, and 18).

For adequate ice prevention in an induction system where all three types of ice can occur, the hot-air system must be capable of maintaining the charge-air enthalpy as high as 34 Btu per pound of air above 0° F at cruise-power condition (fig. 15). This value represents a temperature rise in dry air of 150° F. At the glide-power condition for the light-airplane induction system incorporating a float-type carburetor, the hot-air system must be capable of maintaining the charge-air enthalpy at approximately 42 Btu per pound of air.

In induction systems incorporating design features that tend to reduce the icing hazard, a commensurate reduction in preheat capacity for ice prevention is warranted. For example, considering all the induction systems shown in figure 15, the prevention of water intake would permit a reduction of the requisite enthalpy from 34 to 29 Btu per pound of air; the use of impeller fuel injection with an unprotected inlet (fig. 18) would permit a reduction to 25 Btu per pound of air; a system that excludes water and also uses impeller fuel injection would require only 15.5 Btu per pound of air for ice prevention.

The existence of local induction-system-icing conditions is not always easy to anticipate and considerable ice may form below the carburetor, particularly at low power, before engine operation is impaired. This ice, although it may not be detrimental at low air flows, may seriously restrict the maximum power obtainable for emergency. In order to permit rapid increase to emergency power, a hot-air de-icing system must be capable of providing rapid air-flow recovery from a severely iced condition. The quantity of heat required for emergency de-icing must therefore be considered in establishing heating requirements for the de-icing air.

The enthalpy requirements for emergency de-icing of induction-system configurations F and H are plotted in figure 22 as a function of the time required to recover 95 percent of the respective initial air flows. The quantity of

heat required for emergency de-icing is higher than that required for ice prevention. For example, a comparison of figures 17 and 22 (configuration H) indicates that the minimum heat required for emergency de-icing of the carburetor-supercharger assembly (95-percent air-flow recovery within 25 sec) is approximately 28 Btu per pound of

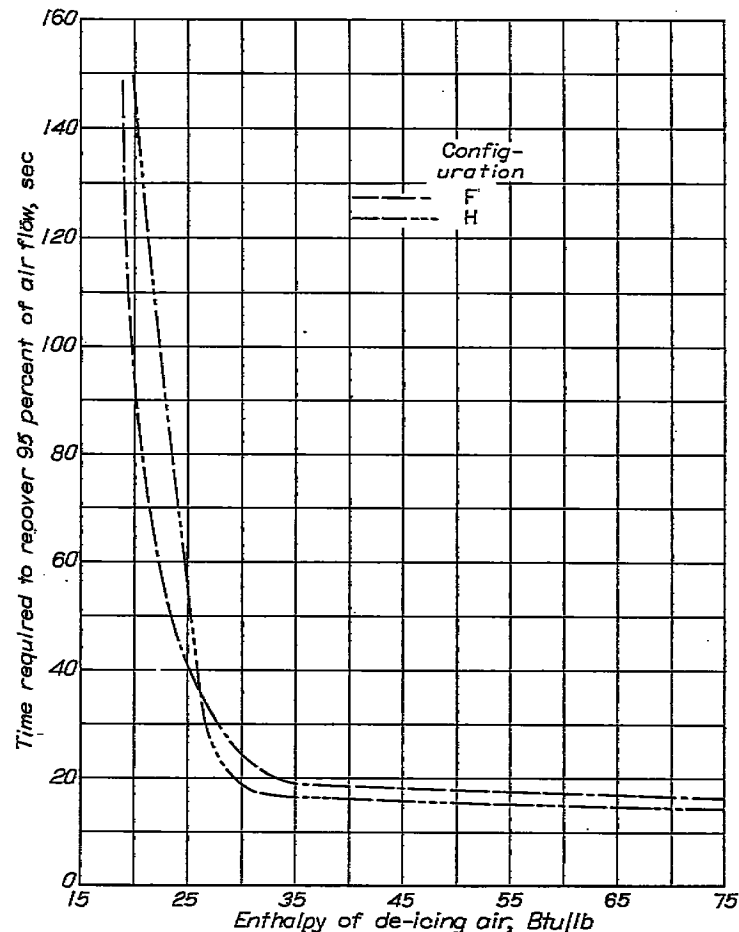

FIGURE 22.—Variation of air-flow recovery time with de-icing air enthalpy for two induction systems at low cruise power with an air-flow loss due to icing of 2000 pounds per hour.

air as compared with 18 Btu per pound of air required for ice prevention of this system. Lag of the heating system will increase the required time to obtain full recovery. It can be observed from figure 22 that heat in excess of the amount required for recovery in approximately 25 seconds does not appreciably reduce the recovery time.

Insufficient air heating may result in an icing condition that is more dangerous than would occur if no heat were used. In the case of an aircraft flying through fine dry snow and using no carburetor heat, most of the snow would pass through the induction system without adhering to the surfaces. The addition of a small quantity of heat would cause the snow to become wet and stick to the passage walls and protuberances, which would result in serious blockage of air flow or altered fuel metering. Stratification of the cold and heated air resulting from poor design or part opening of the air-heat valve for ice prevention may also have adverse effects on fuel metering.

One extensively employed method for obtaining heated air consists of an alternate air inlet located at the rear of the engine or in the accessory compartment. Such a system has the advantage of being relatively light and simple. The heat capacity available, however, may be insufficient for adequate protection; and when warm air is taken from behind the engine cylinders or from behind a coolant radiator, the possibility of high local moisture concentrations within the engine cowl requires careful selection of the location and the design of the alternate inlet. Adequate protection must also be provided to prevent freezing of the hot-air control valve.

The heat from the engine exhaust can be utilized by means of exhaust-gas heat exchangers built into the main induction system or by the use of mufflers or shrouds around the exhaust system to supply hot air through the alternate air system. When a rapid descent or landing approach has been made or when considerable power has been lost because of ice in the induction system, the heat available from the exhaust system might be insufficient for adequate protection.

The bleeding of exhaust gas directly into the intake air in carburetor-equipped engines is another possible source of heat. In some types of induction system, this method presents a fire hazard and in addition may contaminate the air-metering parts.

In general, charge-air heating may provide adequate protection from all types of icing downstream of the introduction point of hot air if sufficient heat is available for all conditions of operation. Such a system requires proper pilot attention and operation. The alternate system must be designed to provide the quantity of heat required for protection of the carburetor at the moisture conditions of the inlet air. In addition, the hot-air damper must be protected from icing.

Several methods of obtaining heated air are available. The selection of a suitable method remains the designer's choice for each particular installation. Precaution should be taken in the design of the heated-air control doors, however, to insure that the control forces required to operate the doors are minimized. The high air velocity through the cold ram-air scoop required to maintain cruise mass air flow at altitude may make the control force required to operate the doors several times that required at sea level.

Heating of induction-system parts.—Application of sufficient heat to all surfaces within the induction system will eliminate all forms of induction-system ice. This method of ice protection affords certain advantages over the use of a hot-air system: (1) Surface heating results in a small rise in the temperature of the charge air and a negligible loss in ram-pressure recovery so that the accompanying loss in altitude performance is correspondingly low; (2) the protection can be applied continuously; (3) ice prevention can be accomplished with a smaller total quantity of heat than is required with a heated-air system; and (4) control of the heat can be made automatic.

The following example, although greatly simplified, serves to illustrate the relative quantities of heat required by the two systems. Assume a 7-inch-diameter duct through which air at a temperature of 25° F with a free-water content

of 0.0004 pound per pound of dry air (approximately 0.5 gram/cu m) and at standard sea-level pressure is flowing at a rate of 4600 pounds per hour. The surface of the duct is considered to be wet and maintained at 32° F. This induction system would require 200 Btu per hour per foot of length and, if the inlet duct were 5 feet long, would require a total of 1000 Btu per hour to keep the surface above freezing. If all the air flowing at a rate of 4600 pounds per hour were heated to prevent freezing, 9800 Btu per hour would be required.

The principal disadvantage of a surface-heating system is that the surfaces within the induction system must be warmed above freezing for the entire length unless other means of protection are provided. Otherwise, ice may melt from the heated surfaces only to freeze again on unprotected areas farther downstream. The installation required for suitable protection may thus become very complex.

Protection of the air-inlet duct might require a rather elaborate heating system, particularly if the duct is a complex configuration. The advantages gained in engine performance because of small losses in air density, reduced quantity of heat required, and elimination of pilot attention to the operation of hot-air doors, however, may in many cases be sufficient to offset any difficulties incurred in the application of a surface-heating system.

Heating of carburetor-air-metering parts presents an exceedingly difficult problem, which can be treated more efficiently by elimination of the parts subject to icing or by relocation of the parts to a warm region. Elimination of the conventional exposed fuel-metering elements, venturis, and impact tubes, which are subject to icing and are difficult to protect, has been accomplished (reference 29) with the development of a fuel-metering device known as the RAE speed density meter. The metering is determined by engine speed, manifold pressure, manifold temperature, and exhaust back pressure.

Oil-jacketed carburetors with oil-heated throttles have had extensive use in British installations. Tests at the Royal Aircraft Establishment (reference 22) indicated that an adequately jacketed carburetor can be maintained relatively free of throttling and fuel-evaporation ice with charge air at a temperature of 40° F flowing at a rate of approximately 4200 pounds per hour by the expenditure of approximately 45 Btu per minute. The results obtained with electrically heated throttle plates that were installed in an otherwise unheated carburetor (reference 19) agreed with the British investigation, which indicated that heat must be applied to both the throttle barrels and the throttle butterfly. The throttle plates were kept entirely free of ice under the most severe icing conditions with a heat input of approximately 51 Btu per minute for charge air at a temperature of 40° F flowing at 4600 pounds per hour, but considerable quantities of ice did accumulate on the walls of the throttle barrels.

De-icing by means of fluids.—Antifreeze fluid-injection systems are normally installed to supplement other protective systems that may be deficient under some operating conditions or for emergency de-icing if the normal protective methods are not applied in time.

Desirable characteristics of de-icing fluids are as follows:

- (1) large freezing-point depression when mixed with water,
- (2) high water solubility, (3) low vapor pressure to minimize evaporation, (4) low latent heat of vaporization, (5) noncorrosive, (6) no adverse effect on engine operation, and (7) noninflammable. Because most de-icing fluids now used are inflammable, such systems are regarded as operational hazards.

Included among the de-icing fluids used have been ethanol and isopropanol. Commercial de-icing fluids consist of a mixture of ethanol, methanol, denaturants, and sometimes a rust inhibitor. Ethanol and isopropanol are very similar in physical properties, but the ethanol provides greater freezing-point depression. Addition of some types of de-icing fluid to the charge air reduces the octane rating of the mixture and may cause detonation with consequent reduction in the power available and in severe cases may damage the engine.

Variations in different induction systems of the method and the point of injection and the type of de-icing fluid used are critical factors in fluid de-icing. In order to obtain the most effective ice removal, the de-icing fluid should be sprayed into the air stream as close as possible to the ice formation so that a large concentration of undiluted fluid will reach the ice formation. In most applications, fluid is sprayed into the air immediately above the carburetor and removes only those ice formations downstream of that location.

The de-icing fluid flow rate for ice removal varies with different induction systems and the type of ice being removed.

For a relatively clean system involving few protuberances or irregularities in the carburetor and air passage (configuration B, fig. 14) with an air flow of approximately 4000 pounds per hour (cruise power) at a carburetor-air temperature of 40° F, a de-icing-fluid flow of 1 to 2 percent of the air flow was required to insure removal of throttling and fuel-evaporation ice within approximately 5 minutes after initial application (reference 6). The fluid de-icing-investigation of configuration D showed similar recovery times for conditions of icing-air temperature and fluid flows comparable to those used for the investigation of configuration B at cruise-power conditions. For rated-power conditions with impact icing at 25° F, full recovery within 5 minutes could not be accomplished in configuration D with fluid flows as high as 1 percent of the air flow (reference 8). An investigation of a larger induction system showed that de-icing-fluid flows in excess of 1 percent of the air flow were required to remove impact icing alone.

The use of alcohol vapor as a de-icing agent has also been investigated (reference 6). This method gave slow recoveries and part of its small success may be ascribed to the release of latent heat to the air stream by the vapor when it condensed.

An analytical method has been developed by which it is possible to determine the theoretical minimum amount of alcohol required to prevent carburetor icing or to compare the merits of fluids of different composition. This method, which is developed in reference 24, is based on the determina-

tion of the amount of alcohol required to lower the freezing point of water to the minimum surface temperature existing in the system, considering the adiabatic temperature drop due to throttling, the kinetic rise in the surface boundary layer, and the cooling effect of the evaporation of the de-icing fluid. Only the minimum rate of de-icing fluid can be determined by this method because perfect distribution of the fluid has been assumed.

British investigators have reported considerable success in eliminating fuel-evaporation icing by injecting alcohol with the fuel at a rate of from 2 to 5 percent of the fuel-consumption rate. Alcohol may be added in bulk to the fuel supply, provided that the alcohol is kept free of water to prevent separation of the alcohol and the fuel.

In general, a fluid de-icing system is inadequate and unreliable as a sole means of ice protection and should be considered only an emergency de-icing method. The recoveries obtained with heated air are usually much faster than those obtained with de-icing fluids. If a fluid de-icing system is to be used, it should be carefully designed both to satisfy the particular ice-prevention requirements of the induction system in which it is to be installed and to minimize the potential fire hazard common to this system of protection. Precautions must also be taken to insure positive shut-off of the alcohol system on engine shut-down to prevent accumulation of alcohol vapor in the induction system. The results of many fluid de-icing experiments indicate that the requirements of each individual induction system must be separately determined with particular scrutiny of the spray characteristics of the nozzles used and the distribution of the fluid.

CONCLUSIONS AND RECOMMENDATIONS FOR DESIGN AND OPERATION

The elimination of factors that cause induction-system icing appears to present the most logical solution to the problem. In some installations, however, a method of preventing and removing ice may be more feasible rather than providing an inherently ice-free induction system. On the basis of the information contained herein and a review of pertinent literature, the following recommendations and conclusions are cited for reference in the design and operation of induction systems:

1. The intake of free moisture, snow, and ice particles into the induction system should be reduced to minimize the formation of impact ice and to reduce the seriousness of fuel-evaporation and throttling ice. Most of the free-moisture intake can be prevented by the use of inertia-separation methods.
2. Induction-system passages should be aerodynamically clean and free from protuberances, carburetor screens, and exposed metering parts that might serve as collecting points for ice.
3. Air-metering devices should be located in a warm or dry region. Air-metering devices located in regions where free moisture may be present in the air should be designed to exclude water from the metering passages or should incorporate adequate drainage and protection against freezing of the entrained water.

4. Provisions should be incorporated to maintain surfaces of the throttle and the throttle body above freezing.

5. Fuel should be injected in a region at and beyond which the passage surfaces are maintained above freezing to prevent fuel-evaporation icing. The fuel must also be injected so as to avoid splashback or eddying of fuel into colder regions.

6. A satisfactory heated-air system must be capable of supplying not only sufficient heat for ice prevention, but also must be capable of furnishing the additional heat required for emergency ice removal. Alternate heated air must be applied before engine power is reduced to the extent that the required heat for de-icing is unavailable. Stratification of heated air in the duct, such as will occur with part opening of the heated-air damper, may seriously affect fuel metering and effectiveness of icing protection.

7. In general, the performance of fluid de-icing systems is unpredictable and slow and their use is not recommended as sole means of protection. If a fluid de-icing system is to be used for emergency protection, it should be carefully designed both to satisfy the particular ice-prevention requirements of the induction system in which it is to be installed and to minimize the potential fire hazard common to this system of protection.

LEWIS FLIGHT PROPULSION LABORATORY,
 NATIONAL ADVISORY COMMITTEE FOR AERONAUTICS,
 CLEVELAND, OHIO, June 20, 1949.

REFERENCES

1. Sparrow, Stanwood W.: "Airplane Crashes: Engine Troubles." A Possible Explanation. NACA TN 55, 1921.
2. Anon.: The Loss of the "Cavalier". The Aeroplane, vol. LVI, no. 1454, April 5, 1939, pp. 432-433.
3. Posner, D. L.: A Review of Service Experience with Aircraft Powerplant Installations. Paper presented before Ann. Meeting I. A. S. (Detroit), May 26-27, 1947.
4. Weick, Fred E.: Powerplant Failures—Causes and Cures. Aviation Week, vol. 50, no. 10, March 7, 1949, pp. 21-22, 24-25.
5. Kimball, Leo B.: Icing Tests of Aircraft-Engine Induction Systems. NACA ARR, Jan. 1943.
6. Essex, Henry A.: De-Icing of an Aircraft Engine Induction System. NACA ARR 3H13, 1943.
7. Essex, Henry A., and Galvin, Herman B.: A Laboratory Investigation of Icing and Heated-Air De-Icing of a Chandler-Evans 1900 CPB-3 Carburetor Mounted on a Pratt & Whitney R-1830-C4 Intermediate Rear Engine Section. NACA ARR E4J03, 1944.
8. Galvin, Herman B., and Essex, Henry A.: Fluid De-Icing Tests on a Chandler-Evans 1900 CPB-3 Carburetor Mounted on a Pratt & Whitney R-1830-C4 Intermediate Rear Engine Section. NACA ARR E4J06, 1944.
9. Galvin, Herman B., and Essex, Henry A.: A Laboratory Investigation of the Icing Characteristics of the Bendix-Stromberg Carburetor Model PD-12F5 with the Pratt & Whitney R-1830-C4 Intermediate Rear Engine Section. NACA ARR E4J18, 1944.
10. Coles, Willard D.: Laboratory Investigation of Ice Formation and Elimination in the Induction System of a Large Twin-Engine Cargo Aircraft. NACA TN 1427, 1947.
11. Lyons, Richard E., and Coles, Willard D.: Laboratory Investigation of Icing in the Carburetor and Supercharger Inlet Elbow of an Aircraft Engine. III—Heated Air as a Means of De-Icing the Carburetor and Inlet Elbow. NACA MR E5L19, 1945.
12. Chapman, Gilbert E.: A Preliminary Investigation of the Icing Characteristics of a Large Rectangular-Throat Pressure-Type Carburetor. NACA MR E6G11, 1946.
13. von Glahn, Uwe, and Renner, Clark E.: Development of a Protected Air Scoop for the Reduction of Induction-System Icing. NACA TN 1134, 1946.
14. Mulholland, Donald R., Rollin, Vern G., and Galvin, Herman B.: Laboratory Investigation of Icing in the Carburetor and Supercharger Inlet Elbow of an Aircraft Engine. I—Description of Setup and Testing Technique. NACA MR E5L13, 1945.
15. Essex, Henry A., Keith, Wayne C., and Mulholland, Donald R.: Laboratory Investigation of Icing in the Carburetor and Supercharger Inlet Elbow of an Aircraft Engine. II—Determination of the Limiting-Icing Conditions. NACA MR E5L18a, 1945.
16. Essex, Henry A., Zlotowski, Edward D., and Ellisman, Carl: Investigation of Ice Formation in the Induction System of an Aircraft Engine. I—Ground Tests. NACA MR E6B23, 1946.
17. Essex, Henry A., Ellisman, Carl, and Zlotowski, Edward D.: Investigation of Ice Formation in the Induction System of an Aircraft Engine. II—Flight Tests. NACA MR E6E16, 1946.
18. Mulholland, Donald R., and Chapman, Gilbert E.: Laboratory Investigation of Icing in the Carburetor and Supercharger Inlet Elbow of an Aircraft Engine. VI—Effect of Modifications to Fuel-Spray Nozzle on Icing Characteristics. NACA MR E6A23, 1946.
19. Chapman, G. E., and Zlotowski, E. D.: Laboratory Investigation of Icing in the Carburetor and Supercharger Inlet Elbow of an Aircraft Engine. IV—Effect of Throttle Design and Method of Throttle Operation on Induction-System Icing Characteristics. NACA MR E5L27, 1946.
20. Coles, Willard D.: Investigation of Icing Characteristics of Typical Light-Airplane Engine Induction Systems. NACA TN 1790, 1949.
21. Renner, Clark E.: Laboratory Investigation of Icing in the Carburetor and Supercharger Inlet Elbow of an Aircraft Engine. V—Effect of Injection of Water-Fuel Mixtures and Water-Ethanol-Fuel Mixtures on the Icing Characteristics. NACA MR E5L28, 1945.
22. Clothier, W. C.: Ice Formation in Carburetors. R. A. S. Jour., vol. XXXIX, no. 297, Sept. 1935, pp. 761-806.
23. Jones, Alun R., and Lewis, William: Recommended Values of Meteorological Factors to be Considered in the Design of Aircraft Ice-Prevention Equipment. NACA TN 1855, 1949.
24. Hardy, J. K.: Kinetic Temperature of Wet Surfaces. A Method of Calculating the Amount of Alcohol Required to Prevent Ice, and the Derivation of the Psychrometric Equation. NACA ARR 5G13, 1945.
25. Hensley, Reece V.: Mollier Diagrams for Air Saturated with Water Vapor at Low Temperatures. NACA TN 1715, 1948.
26. Taylor, C. Fayette, and Taylor, Edward S.: The Internal Combustion Engine. International Textbook Co. (Scranton, Pa.), 1938, pp. 158-161.
27. Skoglund, Victor J.: Icing of Carburetor Air Induction Systems of Airplanes and Engines. Jour. Aero. Sci., vol. 8, no. 12, Oct. 1941, pp. 437-464.
28. Glaister, E.: A Review of the Icing Susceptibility of Engine Induction Systems. Rep. No. Eng. 4120, British R. A. E., Oct. 1944.
29. Anon.: The Rolls-Royce "Griffon" Aero Engine. Engineering, vol. 161, no. 4178, Feb. 8, 1946, pp. 128-130.