

REPORT 985

A RADAR METHOD OF CALIBRATING AIRSPEED INSTALLATIONS ON AIRPLANES IN MANEUVERS AT HIGH ALTITUDES AND AT TRANSONIC AND SUPERSONIC SPEEDS

By JOHN A. ZALOVCIK

SUMMARY

A method of calibrating the static-pressure source of a pitot static airspeed installation on an airplane in level flight, dives, and other maneuvers at high altitude and at transonic and supersonic speeds is described. The method principally involves the use of radar-phototheodolite tracking equipment. The various sources of error in the method are discussed and sample calibrations are included.

INTRODUCTION

The speed of aircraft is still most readily determined by means of a pitot-static installation. The pitot-static installation may consist of a single tube containing both total-pressure and static-pressure elements or it may consist of a pitot tube and a separate source of static pressure in the form, perhaps, of a fuselage static-pressure vent. A pitot tube can usually be easily located to measure the correct total pressure at subsonic speed of the aircraft. At supersonic speeds the pitot tube should be located ahead of shock waves emanating from any part of the airplane if the usual normal-shock relations are to be used to evaluate the airspeed. At low supersonic speeds approaching a Mach number of 1.0, shock waves emanating from the airplane and passing in front of the pitot tube may be tolerable since the loss in total pressure due to shock at such speed is negligible. The principal difficulty in the determination of airspeed from measurements with a pitot-static installation lies in the measurement of the correct static pressure. For installations intended primarily for transonic and supersonic speeds the static-pressure source should be located, if possible, in a region where compressibility shocks are absent or, if present, where they are sufficiently weak to avoid large discontinuities in the variation of static pressure, and hence indicated Mach number, with airspeed. Greater freedom in the selection of a suitable location of the static-pressure source exists at subsonic speeds; however, in general the location chosen for transonic and supersonic speeds is also satisfactory for subsonic speeds. Since the static-pressure source does not always provide an exact measure of free-stream static pressure, the error in static pressure may be determined by calibration or by computation for some special cases. For installations in which

intense compressibility shocks pass over the static-pressure source, a single-value calibration may be impossible to obtain.

In the past the maximum level-flight speeds of airplanes were attained at relatively low altitudes and the calibration of the static-pressure source could therefore be made in level flight by a number of methods such as those described in reference 1. Because of the present trend toward high speeds at high altitudes, however, the low-altitude calibration procedures are not suitable for use on airplanes, particularly in maneuvers, at transonic and supersonic speeds. A method was therefore devised at the Langley Aeronautical Laboratory of the NACA for obtaining calibrations at high altitudes in level flight, dives, and other maneuvers. This method has been in use at the Langley Laboratory for some time and the results of one such calibration were reported in reference 2. Inasmuch as this method is probably to be used more frequently in the future, it is described in greater detail herein than in reference 2.

SYMBOLS

p'	static pressure indicated by pitot-static installation
p	free-stream static or atmospheric pressure
p_t	free-stream total pressure for subsonic flow and total pressure behind normal shock for supersonic flow
q_c	impact pressure ($p_t - p$)
ρ	density
M	Mach number
M'	indicated Mach number
h	altitude
r	slant range
R	radius of earth; gas constant
n	index of refraction
θ	elevation angle
α	angle of ray of light as measured above horizon
T	absolute temperature, °F
γ	ratio of specific heats (1.4)
m	distance along a normal from a point on apparent ray of light to actual ray of light
Subscripts:	
0	sea level
1	altitude of 35,332 feet
s	standard atmosphere
a	arbitrary altitude

APPARATUS

Airplane equipment.—For the calibration tests the airplane should be equipped with the following instruments: a pitot-static installation, a recording normal accelerometer, an airspeed recorder, a recording altimeter, a chronometric timer, and a radio to communicate the timing signals to the ground equipment. The airspeed recorder is used to record the impact pressure, or the difference between total and static pressures, measured by the pitot-static installation. The recording altimeter is used to record the static pressure measured by the static-pressure source. A measure of free-stream temperature by means of a calibrated thermometer is also very desirable but not absolutely necessary. The airspeed recorder and the recording altimeter should be the only instruments connected to the static-pressure source and should be located as near to it as possible in order to minimize the pressure lag of the recording system. The magnitude of the pressure lag may be determined by methods described in reference 1. If the lag is appreciable, corrections must be made to the measured static pressure.

Ground equipment.—The required ground equipment consists of a radar unit, a phototheodolite, and a chronograph. The radar unit is directed on a target through the use of the phototheodolite. The radar unit is equipped with a motion-picture camera to photograph the radar scope, a target camera, and an elevation-scale camera. The scope photographs give the slant range and the target photographs, the correction to the elevation scales. The three cameras and the airplane equipment are synchronized by means of a chronograph that records timing impulses from the ground cameras and the airplane timer.

CALIBRATION PROCEDURE AND ACCURACY

The calibration procedure consists essentially in surveying the atmospheric pressure over the desired range of altitude and then flying the airplane to be calibrated through this region and recording the static pressure measured by the static-pressure source. The static-pressure error of the pitot-static installation is the difference between atmospheric pressure and the static pressure measured by the static-pressure source.

The survey of atmospheric pressure may be made with the airplane being calibrated or with another airplane similarly instrumented. In either case the airplane is tracked with the radar-phototheodolite unit while measurements of static pressure are being made with the static-pressure installation at airplane speeds for which a calibration is available or may be obtained by other techniques such as described in reference 1. The atmospheric pressure so determined is in error by the static-pressure error of the static-pressure source and must be corrected for it. Because of the variation of atmospheric pressure with time, the survey should be repeated frequently (for instance, between calibrating maneuvers if necessary) when the calibration tests are expected to take a long time. Variations in sea-level atmospheric pressure with time of as much as 0.3 inch of water per hour are possible under some conditions.

When the airplane is also equipped with a thermometer for determining free-stream temperature, measurements of temperature are made simultaneously with the measurements of static pressure during the surveys. From the variation of free-stream temperature with altitude, a fairing of the static-pressure data with altitude may be obtained since

$$p = p_a e^{-\int_{h_a}^h \frac{dh}{RT}}$$

where p_a is arbitrarily selected for the best fairing of the data.

In the calibration maneuvers the airplane should be flown through the region surveyed (slant range, elevation, and azimuth) or as near to it as possible. For maneuvers in which the airplane cannot be restricted to the region surveyed as a result of the high speed of the airplane, corrections may be necessary to the data obtained in the survey and in the maneuver for the following: refraction of light, curvature of the earth, error in alinement of the phototheodolite reference plane with the horizon, and the variation of atmospheric pressure at a given altitude with distance along the earth's surface. The error in altitude due to refraction of light, as determined from equations derived in the appendix and the notation in figure 1, is presented in figure 2 and the error due to the earth's curvature is given in figure 3. A check of the sea-level atmospheric pressure as measured at U. S. weather stations 10 to 30 miles apart indicated that on days with surface winds of 20 to 25 miles per hour the horizontal pressure gradients may be as much as 0.05 inch of water per mile along the earth's surface. At an altitude of 10,000 feet, weather maps indicated horizontal pressure gradients as much as 0.02 inch of water per mile.

An SCR-584 radar unit with phototheodolite and cameras (scope, target, and elevation scales) has an estimated accuracy of about ± 45 feet in slant range and ± 0.2 mil in elevation for a single observation. For a series of observations where the data may be faired, the accuracy, of course, is improved. The error in altitude due to the error in slant range and elevation angle is shown in figure 4. Consistent errors in the tracking equipment should have no effect on the accuracy of the calibration, provided that these errors occur throughout the calibration procedure.

An NACA recording altimeter has a random error of about $\pm \frac{1}{4}$ percent of full-scale value for a single observation. This error corresponds to errors of ± 1 and ± 0.2 inch of water for altimeters built to measure pressures including sea-level pressure and to measure pressures at and above an altitude of 40,000 feet, respectively. The combined maximum probable error in a single observation due to errors in measuring static pressure and in determining altitude (± 45 ft or ± 0.2 in. of water at 40,000 ft) is ± 1 inch of water for the altimeter with a range including sea-level pressure and ± 0.3 inch of water for the altimeter with a range for altitudes above about 40,000 feet. Since in the calibration procedure a series of observations is made over a range of altitude, the fairing of the data reduces the magnitude of the error.

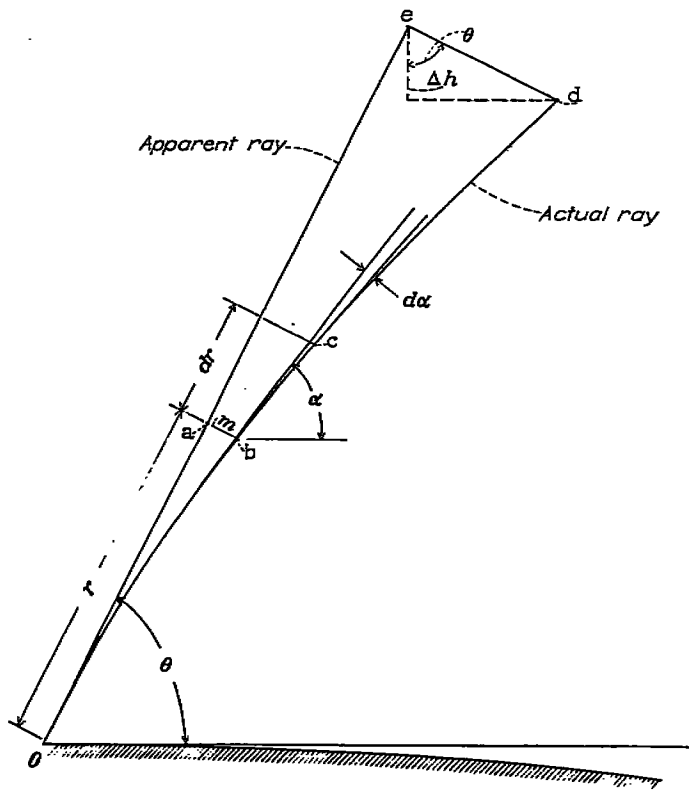

FIGURE 1.—Refraction of light in earth's atmosphere. See appendix for derivation of amount of refraction.

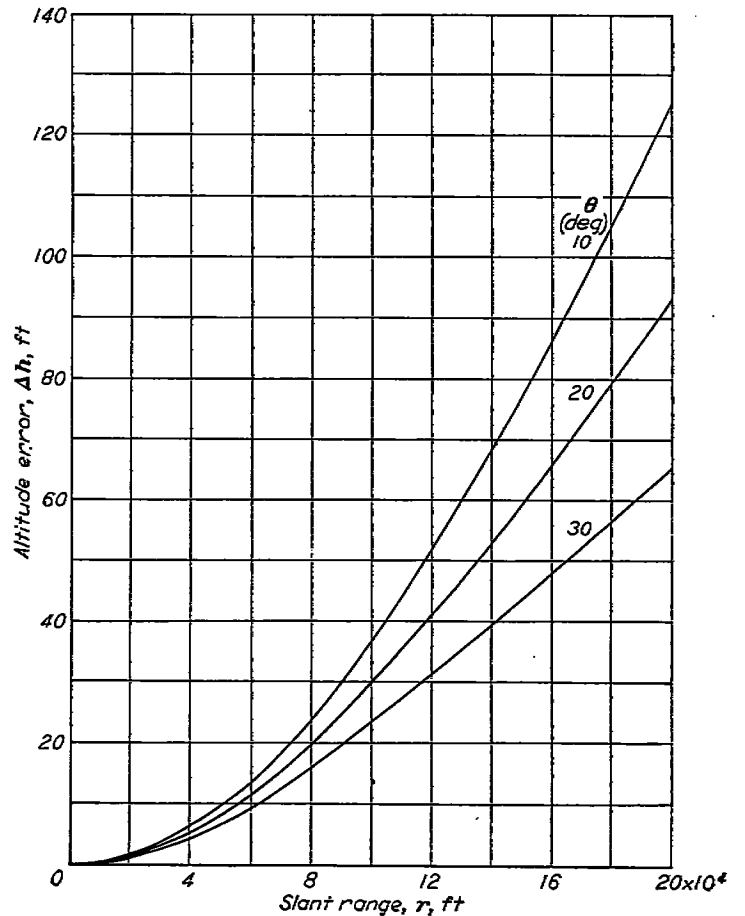

FIGURE 2.—Error in altitude due to refraction of light.

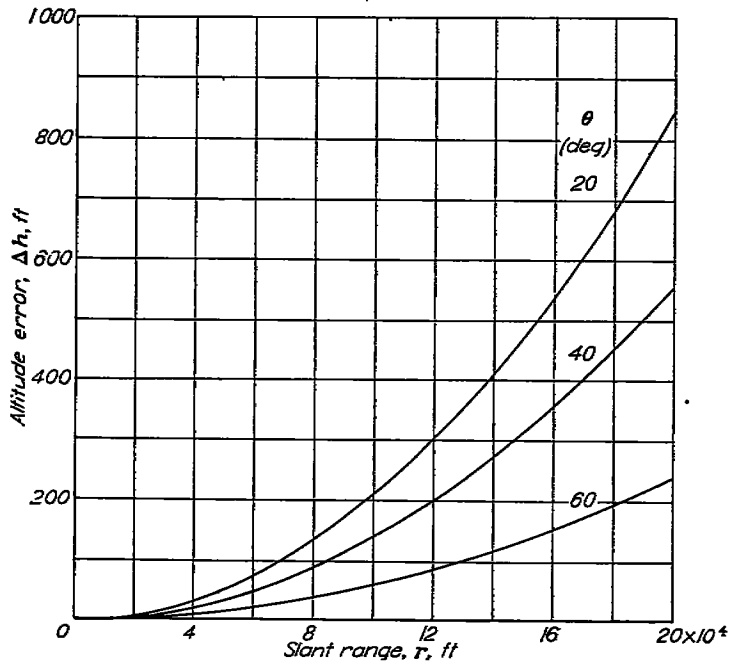
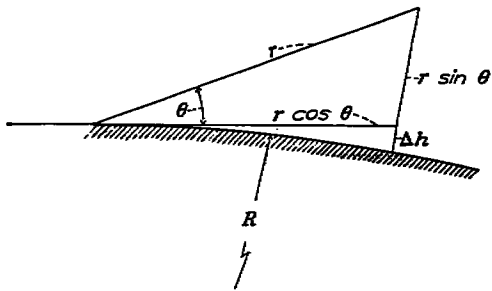

FIGURE 3.—Error in altitude due to curvature of the earth.

$$\Delta h \approx \frac{1}{2} \frac{(r \cos \theta)^2}{R}$$

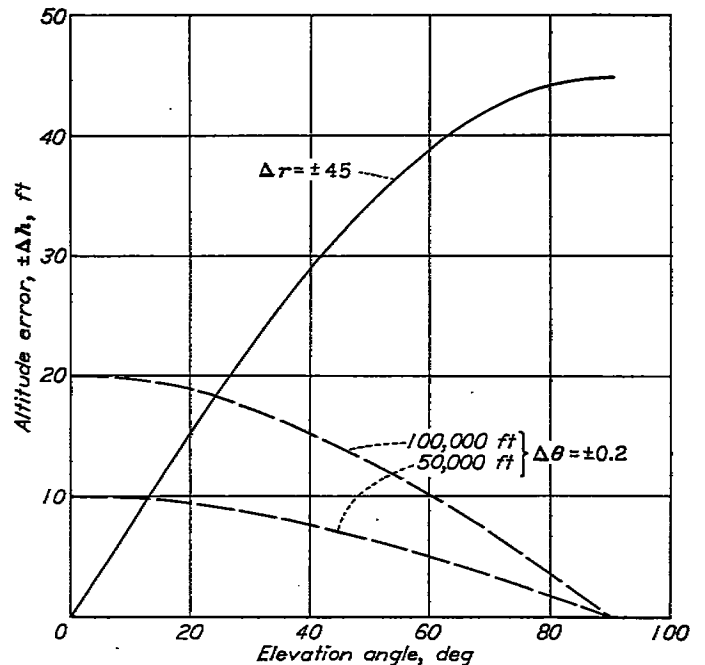
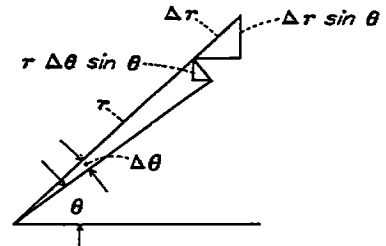

FIGURE 4.—Error in altitude due to error in slant range, $\Delta r = \pm 45$ feet, and to error in elevation angle, $\Delta \theta = \pm 0.2$ mil.

The error in Mach number due to an error in determining the altitude and the error in static pressure corresponding to an error in Mach number are derived in the appendix and presented in figures 5 and 6, respectively. The rate of change of atmospheric pressure with altitude for NACA standard atmosphere is shown in figure 7 for the convenience of the reader in making conversions from error in altitude to error in static pressure.

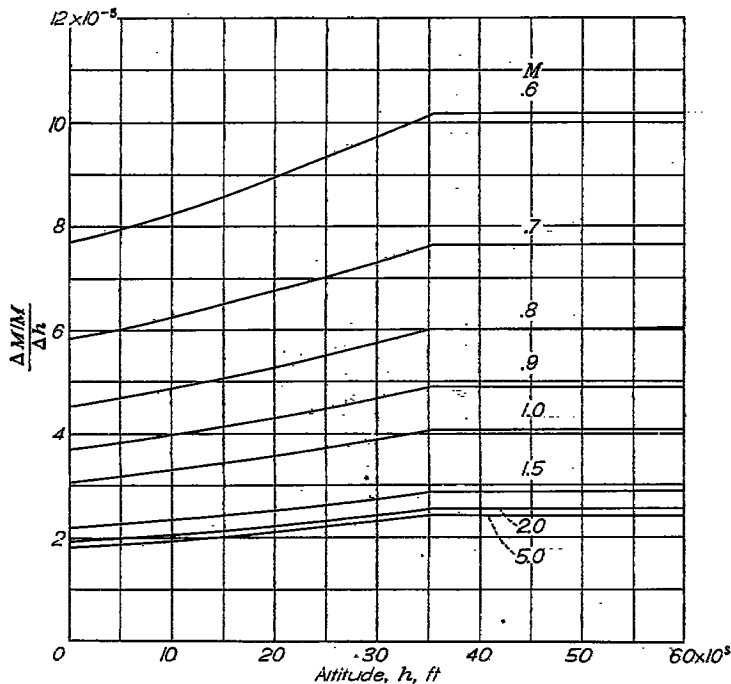

FIGURE 5.—Error in Mach number due to an error in altitude.

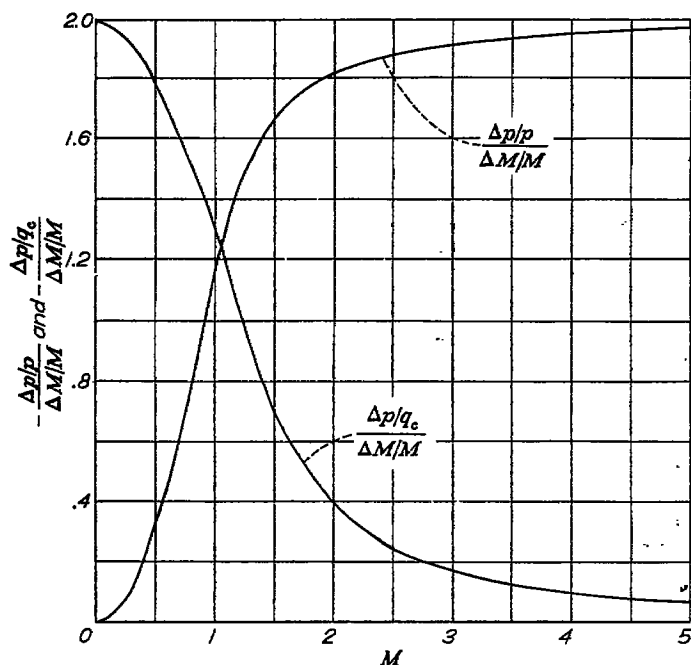

FIGURE 6.—Error in static pressure corresponding to an error in Mach number. At $M > 1$ the value of q_c includes loss through normal shock.

SAMPLE CALIBRATION

The method and some results of a calibration of an airspeed installation ahead of the nose of an airplane in dives and pull-outs are described in the following paragraphs. The results of a calibration of a wing-tip installation previously reported in reference 2 are also given herein for the convenience of the reader. Sketches of the fuselage-nose and wing-tip airspeed installations are presented in figure 8.

The calibration procedure for the tests of the fuselage-nose installation consisted first in obtaining a survey in a climb at an indicated airspeed of about 250 miles per hour over a

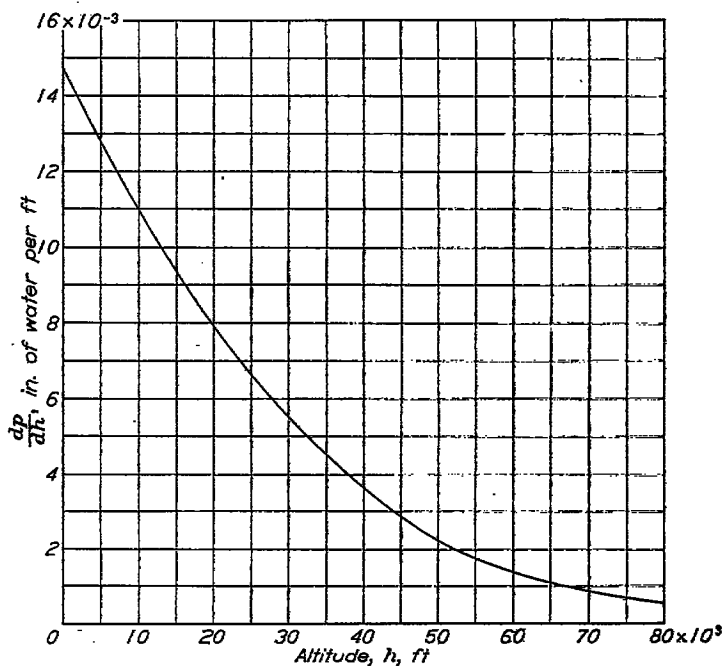
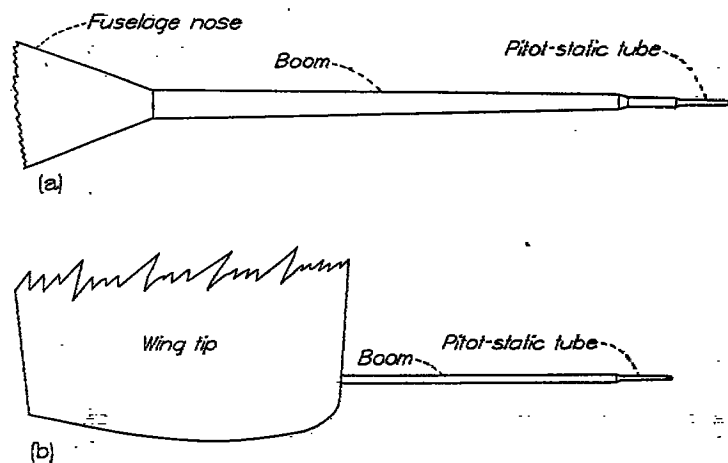

FIGURE 7.—Rate of change of atmospheric pressure with altitude for NACA standard atmosphere.



(a) Fuselage-nose airspeed installation.
 (b) Wing-tip airspeed installation.

FIGURE 8.—Airspeed installations calibrated by radar method.

range of altitude from about 21,000 to 36,000 feet in order to establish the relation of atmospheric pressure to actual altitude. In the survey simultaneous records were taken of static pressure, impact pressure, and normal acceleration in the airplane and of elevation angle and range of the airplane with the tracking unit. The airplane was then dived to a Mach number of about 0.94 and pulled out with 2g normal acceleration within the range of altitude surveyed; continuous and simultaneous records of static pressure, impact pressure, normal acceleration, range, and elevation angle were made during these maneuvers. A survey of static pressure was then repeated in a descent over the same range of altitude and in a climb preceding the second dive and pull-out which covered the same flight conditions as the first dive and pull-out. A few runs were also made in level flight.

The results of the surveys of atmospheric pressure are shown in figure 9 in which the difference between atmospheric pressure p and NACA standard atmospheric pressure p_s is plotted against altitude h . The static pressure obtained in the climbs and during the descent was corrected to atmospheric pressure by use of the static-pressure error of the airspeed installation as determined from a low-speed calibration. The calibration was made up to a Mach number of about 0.66 by a method (reference 1) in which level-flight runs are made past a landmark or a reference airplane of known pressure altitude, and an altimeter is used to measure the static pressure indicated by the airspeed installation.

The static-pressure error in the dive and pull-out was found by taking the difference between the static pressure measured at a given altitude in the dive and pull-out and the atmospheric pressure determined from the pressure surveys at the same altitude. Measurements of static pressure, impact pressure, and normal acceleration were used to evaluate the Mach number and lift coefficients corresponding to the determined static-pressure error. The results of the calibration in the dives and pull-outs are presented in figure 10. A small but consistent error (corresponding to an error of about 130 ft in altitude) between the two dives is apparent in the results and no explanation for it has been found.

The results of the calibration tests of the airplane with the wing-tip airspeed installation previously described and reported in reference 2 are shown in figures 11 and 12 without any further descriptions of the test procedure since it was very similar to that described for the airplane with the fuselage-nose airspeed installation.

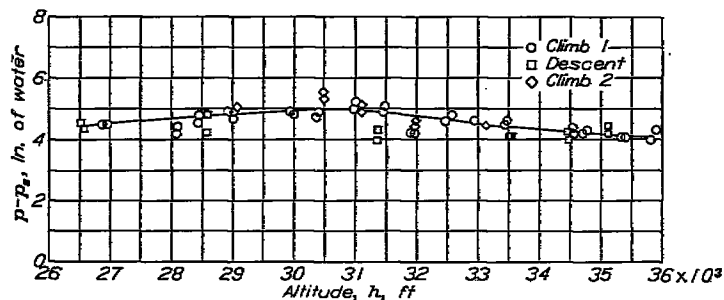
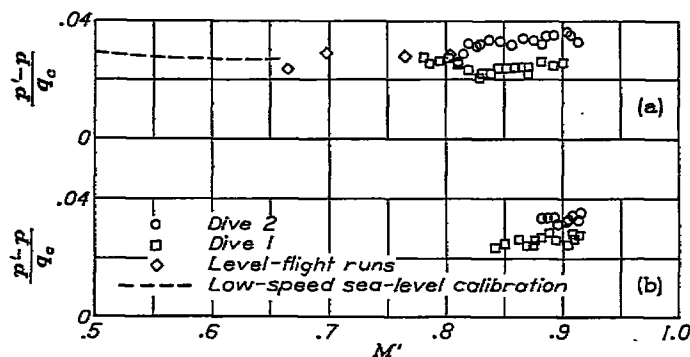

FIGURE 9.—Variation with altitude of the difference between atmospheric pressure and NACA standard atmospheric pressure from surveys for the airplane with fuselage-nose airspeed installation.



(a) Lift coefficient from 0 to 0.1.
 (b) Lift coefficient from 0.1 to 0.2.

FIGURE 10.—Variation of static-pressure error with indicated Mach number for the airplane with the fuselage-nose airspeed installation.

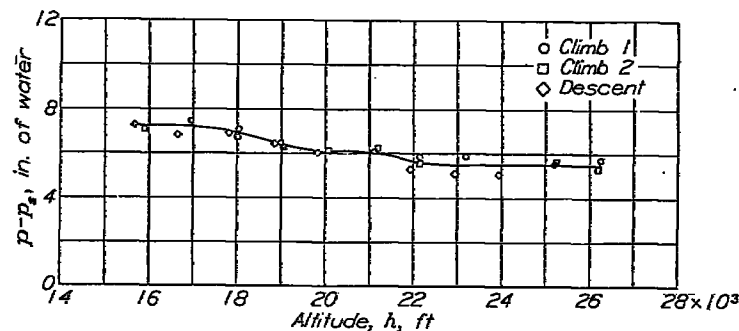
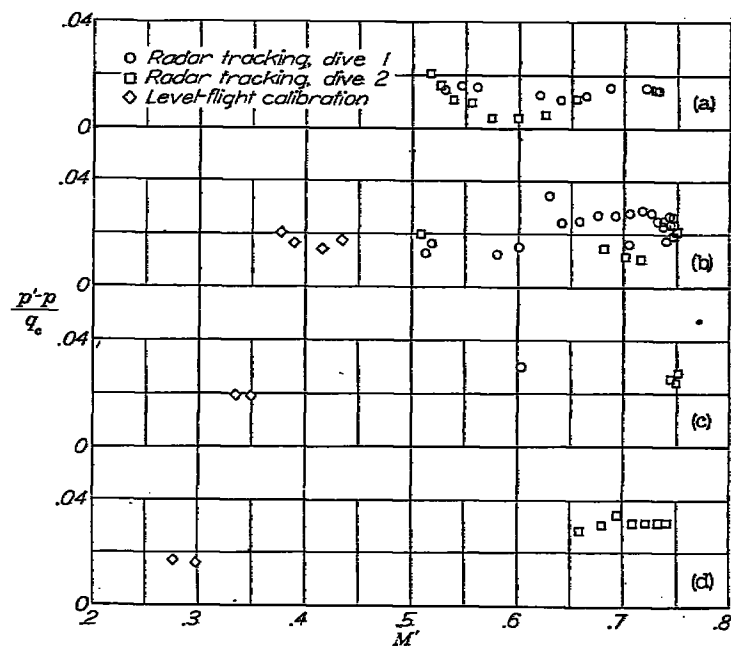

FIGURE 11.—Variation with altitude of the difference between atmospheric pressure and NACA standard atmospheric pressure as determined from surveys for the airplane with wing-tip airspeed installation.



(a) Lift coefficient from 0.03 to 0.10.
 (b) Lift coefficient from 0.10 to 0.20.
 (c) Lift coefficient from 0.20 to 0.30.
 (d) Lift coefficient from 0.30 to 0.40.

FIGURE 12.—Variation of static-pressure error with indicated Mach number for several ranges of airplane lift coefficient for airplane with wing-tip airspeed installation.

CONCLUDING REMARKS

A method is described for calibrating the static-pressure source of a pitot-static airspeed installation on an airplane in maneuvers at high altitude and at transonic and supersonic speeds. In this method, radar tracking equipment is used to establish the geometric altitude of the airplane in surveys of atmospheric pressure made at speeds for which the airspeed calibration is known and in maneuvers under

conditions for which the calibration is desired. No corrections for reflection of light, curvature of the earth, and horizontal atmospheric pressure gradient are necessary to the measured quantities if the maneuver is made in or near the region surveyed.

LANGLEY AERONAUTICAL LABORATORY,
 NATIONAL ADVISORY COMMITTEE FOR AERONAUTICS,
 LANGLEY FIELD, VA., August 31, 1949.

APPENDIX

CALCULATION OF ERRORS

Error in Mach number due to error in determining altitude.—The relations given herein were used to determine the error in Mach number resulting from an error in altitude (see fig. 5).

The NACA standard atmospheric pressure for altitudes below 35,332 feet is

$$p = p_0(1 - 6.89 \times 10^{-6}h)^{5.256} \quad (1)$$

and for altitudes above 35,332 feet is

$$p = p_1 e^{-\frac{h-h_1}{58.371}} \quad (2)$$

Bernoulli's equation for a compressible fluid for $M \leq 1.0$ is

$$p_t = p \left(1 + \frac{\gamma-1}{2} M^2 \right)^{\frac{\gamma}{\gamma-1}} \quad (3)$$

and the relation (reference 3) for $M \geq 1.0$ is

$$p_t = \frac{\gamma+1}{2} p M^2 \left[\frac{(\gamma+1)M^2}{4\gamma M^2 - 2(\gamma-1)} \right]^{\frac{1}{\gamma-1}} \quad (4)$$

where $\gamma=1.4$. After the derivative of equation (3) is taken, dp_t equated to zero, and the result combined with the derivatives of equations (1) and (2), the following expressions result: For altitudes equal to or less than 35,332 feet,

$$\frac{\Delta M/M}{\Delta h} = \frac{1+0.2M^2}{1.4M^2} \frac{36.214 \times 10^{-6}}{1-6.89 \times 10^{-6}h} \quad (5)$$

and for altitudes equal to or greater than 35,332 feet,

$$\frac{\Delta M/M}{\Delta h} = -4.79 \times 10^{-5} \frac{1+0.2M^2}{1.4M^2} \quad (6)$$

Similarly, for $M \geq 1.0$ the expression for altitudes equal to or less than 35,332 feet is

$$\frac{\Delta M/M}{\Delta h} = \left(\frac{1}{\frac{4.0}{5.6M^2 - 0.8} - 2} \right) \frac{36.214 \times 10^{-6}}{1 - 6.89 \times 10^{-6}h} \quad (7)$$

and for altitudes equal to or greater than 35,332 feet,

$$\frac{\Delta M/M}{\Delta h} = \frac{1}{\frac{4.0}{5.6M^2 - 0.8} - 2} 4.79 \times 10^{-5} \quad (8)$$

Static-pressure error corresponding to error in Mach number.—After differentiation of equation (3) for $M \leq 1.0$, the following expression for static-pressure error corresponding to an error in Mach number (see fig. 6) is obtained:

$$\frac{\Delta p}{p} = -\frac{1.4M^2}{1+0.2M^2} \frac{\Delta M}{M} \quad (9)$$

or

$$\frac{\Delta p}{q_c} = -\left[\frac{1}{(1+0.2M^2)^{3.5} - 1} \right] \frac{1.4M^2}{1+0.2M^2} \frac{\Delta M}{M} \quad (10)$$

After differentiation of equation (4) for $M \geq 1.0$, the following expression is obtained:

$$\frac{\Delta p}{p} = \left(\frac{4.0}{5.6M^2 - 0.8} - 2 \right) \frac{\Delta M}{M} \quad (11)$$

or

$$\frac{\Delta p}{q_c} = \left(\frac{4.0}{5.6M^2 - 0.8} - 2 \right) \frac{1}{1.2M^2 \left(\frac{5.76M^2}{5.6M^2 - 0.8} \right)^{2.5} - 1} \frac{\Delta M}{M} \quad (12)$$

Error in altitude due to refraction of light.—The equation for refraction of light from reference 4, with change in notation, is (also see fig. 1)

$$d\alpha = \cot \alpha \frac{dn}{n} \quad (13)$$

where

$$n = 1 + 294.38 \times 10^{-6} \frac{\rho}{\rho_0} \quad (14)$$

Equation (13) may be approximated as

$$d\alpha = \cot \theta \, dn \quad (15)$$

For NACA standard atmosphere for $h \leq 35,332$ feet,

$$\frac{\rho}{\rho_0} = (1 - 6.89 \times 10^{-6} h)^{4.256} \quad (16)$$

and for $h \geq 35,332$ feet,

$$\frac{\rho}{\rho_1} = e^{-\frac{h-h_1}{53.3T_1}} \quad (17)$$

In equations (16) and (17) the following expression for h may be substituted:

$$h = r \sin \theta$$

A study of figure 1 shows that

$$\frac{d^2 m}{dr^2} = \frac{d(\theta - \alpha)}{dr} = -\frac{d\alpha}{dr}$$

or

$$m = - \int_0^r \int_0^r \cot \theta \, dn \, dr$$

Since $\Delta h = m \cos \theta$,

$$\Delta h = - \cos \theta \int_0^r \int_0^r \cot \theta \, dn \, dr \quad (18)$$

Integration of equation (18) yields for $h \leq 35,332$ feet,

$$\Delta h = -29.438 \times 10^{-5} \frac{\cos^2 \theta}{\sin \theta} \left\{ \frac{27.62 \times 10^3}{\sin \theta} \left[1 - (1 - 6.89 \times 10^{-6} r \sin \theta)^{5.256} \right] - r \right\} \quad (19)$$

and for $h \geq 35,332$ feet,

$$\Delta h = \Delta h_1 + 29.438 \times 10^{-5} (r - r_1) \frac{\cos^2 \theta}{\sin \theta} + 1.875 \cot^2 \theta \left(e^{-\frac{r-r_1}{53.3T_1} \sin \theta} - 1 \right) \quad (20)$$

REFERENCES

1. Huston, Wilber B.: Accuracy of Airspeed Measurements and Flight Calibration Procedures. NACA Rep. 919, 1948.
2. Zaloveik, John A., and Wood, Clotaire: Static-Pressure Error of an Airspeed Installation on an Airplane in High-Speed Dives and Pull-Outs. NACA RB L5K29a, 1946.
3. Taylor, G. I., and Maccoll, J. W.: The Mechanics of Compressible Fluids. Two-Dimensional Flow at Supersonic Speeds. Vol. III of Aerodynamic Theory, div. H, ch. IV, secs. 2 and 3, W. F. Durand, ed., Julius Springer (Berlin), 1935, pp. 236-242.
4. Chauvenet, William: A Manual of Spherical and Practical Astronomy. Vol. I—Spherical Astronomy. J. B. Lippincott Co., 1891, pp. 136 and 139.