

NACA TN No. 1485

18 MAR 1948

NATIONAL ADVISORY COMMITTEE FOR AERONAUTICS

TECHNICAL NOTE

No. 1485

FATIGUE STRENGTH AND RELATED CHARACTERISTICS
OF AIRCRAFT JOINTS

II - FATIGUE CHARACTERISTICS OF SHEET AND RIVETED JOINTS OF
0.040-INCH 24S-T, 75S-T, AND R303-T275 ALUMINUM ALLOYS
By H. W. Russell, L. R. Jackson, H. J. Grover, and W. W. Beaver

Battelle Memorial Institute



Washington

February 1948

~~NACA LIBRARY
LANGLEY MEMORIAL AERONAUTICAL
LABORATORY
Langley Field, Va.~~

NATIONAL ADVISORY COMMITTEE FOR AERONAUTICS

TECHNICAL NOTE NO. 1485

FATIGUE STRENGTH AND RELATED CHARACTERISTICS OF AIRCRAFT JOINTS

II - FATIGUE CHARACTERISTICS OF SHEET AND RIVETED JOINTS OF

0.040-INCH 24S-T, 75S-T, AND R303-T275 ALUMINUM ALLOYS

By H. W. Russell, L. R. Jackson, H. J. Grover, and W. W. Beaver

SUMMARY

The results of a series of fatigue tests of aluminum-alloy sheet materials and of simple riveted joints in these materials are presented. The materials tested were 24S-T Alclad, 24S-T bare, 75S-T Alclad, R303-T275 clad, and R303-T275 bare. All sheets were of the 0.040-inch gage.

Unnotched sheet specimens, specimens notched by a drilled hole, and specimens with scratches were tested in direct-stress fatigue. It was found that:

- (1) Bare materials notched or unnotched had greater fatigue strengths at long lifetimes than corresponding clad materials
- (2) The 75S-T Alclad and the R303-T275 clad although stronger statically than the 24S-T Alclad were generally somewhat weaker in long-life fatigue
- (3) Although shallow scratches did not affect the fatigue strengths of the clad materials scratches deeper than the minimum depth of cladding were detrimental

Several types of riveted joint in the sheet materials were also tested in direct-stress fatigue. It appeared that:

- (1) The long-life fatigue strengths of single-row lap joints of the different materials were in the same relative order as the notch fatigue strengths of the materials
- (2) Increasing the number of rows of rivets in a lap joint decreased the fatigue strength in pounds per rivet
- (3) Stiffened lap joints and butt joints had a considerably higher ratio of long-life fatigue to static strength than simple lap joints

Tests at 375° F on notched and unnotched sheet and on riveted joints showed little decrease in fatigue strength from room-temperature values.

Tests of cumulative damage of the various types of specimen gave results in reasonable accordance with estimations based on the endurance lifetime at each stress level.

INTRODUCTION

This paper is a summary of an investigation of the fatigue properties of sheet and riveted joints in aluminum alloys. Reports of previous investigations (references 1 to 5) have given tension-tension fatigue strengths of 24S-T Alclad sheet and of spot-welded and riveted lap joints in that material. The present investigation was planned to extend these fatigue studies in the following respect: (1) the inclusion of other high-strength aluminum alloys, (2) tests on additional types of joints, (3) survey tests of the effects of elevated temperatures on fatigue properties of the sheet materials and joints considered, and (4) tests of fatigue damage.

The experimental equipment and techniques have been described in detail in preceding reports (see particularly references 1 and 2). In the present work, the range of stress for some sheet materials was extended to include some compressive stresses. In these cases, specimens were restrained from buckling by the use of "guide plates." (See reference 6.)

The sections of this paper are developed in the following order:

(1) A description is given of direct-stress fatigue tests of sheet materials - 24S-T bare, 24S-T Alclad, 75S-T Alclad, R303-T275 bare, and R303-T275 clad - in the 0.040-inch gage. The tests included unnotched specimens (both transverse and longitudinal), specimens notched by drilled holes, and specimens with surface scratches.

(2) Results for fatigue tests of riveted lap joints and riveted butt joints with various stiffeners are given, as well as the results of a few tests of multi-arc-welded butt joints. All joints were of 0.040-inch sheet.

(3) Fatigue test results are presented for specimens of the sheet materials and for riveted joints at elevated temperature (375° F).

(4) The results of some tests of cumulative fatigue damage of sheet materials and of various joints in these materials are summarized.

In each section, the results of tests are presented with relatively little discussion. In the CONCLUSIONS test results are recapitulated and discussed with reference to present knowledge of the fatigue properties of materials and joints used in aircraft construction.

This investigation was conducted at the Battelle Memorial Institute under the sponsorship and with the financial assistance of the National Advisory Committee for Aeronautics.

RESULTS OF DIRECT-STRESS FATIGUE TESTS OF

SHEET MATERIALS

Part of the basic information required for the application of fatigue data to the design of aircraft is a knowledge of the relative performance of materials used in aircraft parts under repeated loads. In this section, fatigue data are given for various materials in the form of 0.040-inch sheet.

Unnotched Sheet Specimens

Table 1 shows static-tensile-strength properties of the sheet materials used for the fatigue tests. Figure 1(a) shows the unnotched sheet specimen used. Figures 2 to 6 show the results of direct-stress fatigue tests on specimens cut and loaded in the direction of rolling of the sheet; the results are plotted directly from the experimental data in the form of constant R (ratio of minimum load to maximum load) curves. Figures 7 to 9 give results, in the form of S-N curves, of direct-stress fatigue tests of specimens of clad sheet materials cut and loaded transverse to the direction of rolling of the sheet.

Some of the more outstanding results apparent in figures 2 to 9 are:

- (1) At long lifetimes, the bare materials have considerably higher fatigue strengths than the clad materials. The differences in long-life fatigue strengths of bare and of clad materials are greater than differences in static strengths or differences in short-lifetime fatigue strengths.
- (2) Although the static strengths of both 75S-T Alclad and R303-T275 clad are higher than the strength of 24S-T Alclad, the fatigue strengths are generally slightly lower. This may be partly due to the importance of the cladding in determining the fatigue strength. However, results for bare R303-T275 shows that, even in the absence of cladding, the latter material is not so strong in fatigue as would be expected from comparison of its static strength with that of 24S-T sheet.
- (3) Fatigue strengths of clad materials appear to be but slightly lower in the transverse direction than in the longitudinal direction.

Specimens Notched by Drilled Holes

Inasmuch as sheet materials used in aircraft are usually notched (by cutouts, joints, and changes in section), the fatigue notch sensitivities of sheet materials are important in design considerations. Accordingly, each of the five sheet materials mentioned previously was tested in notch fatigue. Figure 1(b) shows the specimen used; the notch was a single 0.375-inch hole drilled in the center of a $1\frac{1}{2}$ -inch-wide test section. All specimens were cut and loaded in the direction of rolling.

Table 2 shows static ultimate strengths of the notched sheet specimens. Comparison with table 1 indicates a reduction in nominal static strength of about 10 to 13 percent for the 24S-T and about 1 to 3 percent for the other materials.

Figures 10 to 14 show the results of direct-stress fatigue tests on these notched specimens. Comparison of these results with results for unnotched specimens is indicated in table 3. Some of the more outstanding results apparent in these figures and table 3 are:

- (1) The reduction in strength due to the hole is, for all materials, more serious in fatigue than in static loading. The fatigue-strength reduction is greater at long lifetimes than at short lifetimes; for a given lifetime, the reduction is greatest for low R values. The reduction in fatigue strength approaches (at low R and long lifetime) that estimated from the geometrical stress-concentration factor, but, in these tests, never reaches this value.
- (2) The reduction in nominal fatigue strength due to the drilled hole is greater for bare sheets of R303-T275 than for bare sheets of 24S-T. The fatigue strength reduction for clad high-strength alloy is, however, not significantly greater than that for 24S-T Alclad. Apparently, at high stresses, the cladding can yield so as to reduce the stress concentration produced by the hole.

Effect of Surface Scratches

It would be expected that some scratches on Alclad sheet would have a damaging effect on the fatigue strength of the sheet, and it is important to know what severity of scratch would be cause for rejection.

Andrews and Stickley (reference 7) investigated the effect of scratches on 0.064-inch-thick 24S-T Alclad sheet and concluded that scratches were not damaging unless they extended through the cladding.

In general, the results summarized here on 24S-T Alclad confirm their observation. Data have also been obtained on 75S-T Alclad and 24S-T bare sheet. In a number of cases, damage was observed when the scratch did not penetrate the nominal depth of cladding. It was found, however, that the cladding was not uniform in thickness, and, in all cases when damage was observed, the scratch was deep enough to be within the range between the minimum and maximum depth of cladding. Thus, in all cases, a portion of the scratch might have penetrated below the cladding.

The type of test piece used was the same as for tensile fatigue tests of unnotched sheet. (See fig. 1(c).) In all cases, a single scratch was made at the center of the test section and perpendicular to the direction of loading. At the location of the scratch, the test piece was 1 inch wide; all scratches were 1/2 inch long and centered within the 1-inch section so that they did not extend to the edge of the test piece.

In making a scratch, the test piece was carefully located on a movable table actuated by a screw similar to the cross feed on a lathe. The scratching tool, loaded through a lever with a definite weight, was then lowered onto the test piece, and the table moved 1/2 inch.

Two types of scratching tool were used - a steel needle and a sapphire phonograph cutting needle. Both tools had a radius of approximately 0.003 inch and produced scratches which varied in radius from 0.0027 to 0.0033 inch. The depth of scratch produced by varying the force on the tool is given in table 4. Some typical microsections of scratches are shown in figure 15.

Two methods of measuring the scratch depth were used. The first method consisted in focusing a metallographic microscope on the sheet at high magnification, and then measuring the amount of adjusting-screw movement necessary to bring the bottom of the scratch into focus. By this method it was possible to examine the scratch throughout its entire length and thus observe depth variations. The second method, used whenever feasible, was to section the piece after testing and measure the scratch depth on the section. In most cases the two methods agreed very well.

The results of fatigue tests on specimens with scratches are summarized in table 5 and figures 16 to 18. From these figures and this table it will be noted that:

(1) On the 0.040-inch Alclad material, the depth of cladding varies from 0.0011 to 0.002 inch and, on the 0.102-inch Alclad, the depth varies from 0.0025 to 0.0034 inch.

(2) As long as the depth of the scratch is smaller than the minimum depth of cladding (0.0011 inch for 0.040-inch-thick sheet and 0.0025 inch on 0.102-inch-thick sheet) no damage results.

(3) When the scratch is deeper than the minimum depth of cladding, there may or may not be damage. However, when damage does result, it is usually quite large, and the safest procedure would be to reject all sheets containing scratches deeper than the minimum cladding depth.

RESULTS OF DIRECT-STRESS FATIGUE TESTS OF SIMPLE JOINTS OF 0.040-INCH SHEET MATERIALS

Among the most important stress-raisers in aircraft construction are various types of joint. Riveted joints are most commonly used in load-bearing parts; accordingly, an investigation was made of the fatigue behavior of various sheet materials under the stress concentrations existing in riveted joints. A study was also made of stress-coat patterns on loaded riveted joints. Figures 19 to 22 are photographs of stress-coat patterns on some of the riveted joints tested in fatigue.

In particular, figure 19 shows a lap joint with a single row of rivets. Bending at the lap is clearly indicated by the prominence of cracks at a distance below the rivets in contrast with the relatively crack-free lacquer immediately below the rivets. In contrast, figure 20, a photograph of a butt joint, shows much less evidence of bending stresses.

Figure 21 shows two sides of a sheet-efficiency specimen, two equally loaded sheets held together by a line of rivets. (See fig. 23.) Differences in lines of stress concentration are quite noticeable. Figure 22 clarifies the reason for this difference by showing: the stress-coat patterns on single sheets around drilled holes (fig. 22(a)), around drilled and dimpled holes (fig. 22(b)), and around rivet heads (fig. 22(c)). Apparently, on the side of the sheet on which rivets are headed over, the combination of the dimple and the headed rivet produces a stiffening around the hole and alters the stress pattern from that around a drilled hole or that around the rivet on the flush side.

Single-Row Flush-Riveted Lap Joints in Various Alloys

Direct-stress fatigue tests have been made of single-row flush-riveted lap joints of 0.040-inch sheets of the following materials: 24S-T Alclad, 24S-T bare, 75S-T Alclad, R303-T275 clad, and R303-T275 bare. The specimen design is shown in figure 24(a).

The riveting procedure for these specimens was as follows:

- (1) Sheets were drilled with a No. 30 drill, and the edges of holes deburred.

- (2) Each sheet of a given joint was dimpled separately with a conventional dimpling tool.
- (3) AL7S-T rivets, AN426, type AD4-5, were driven with the riveter.

It should be noted that no special precautions were used for the high-strength alloys.

Figures 25 and 26 show cross sections through rivets in each of the materials. It was anticipated that the high-strength alloys might show internal cracks produced by dimpling. Such cracks were found only in the R303-T275 bare material. (See fig. 26.)

Table 6 gives static strengths for the riveted lap-joint specimens, and figures 27 to 30 show the results of fatigue tests. Figure 31 shows typical static and fatigue failures for lap joints. From table 6 and figures 27 to 30, several interesting results may be noted:

- (1) Joints of 24S-T bare sheet are generally stronger in fatigue than joints of 24S-T Alclad. This is in accordance with the results for the sheet materials.
- (2) Joints of R303-T275 bare and joints of the same alloy clad have roughly the same fatigue strengths. However, it should be remembered that cold dimpling apparently produced internal cracks in the bare sheet, and these may have contributed to low fatigue strength.
- (3) Joints of 75S-T Alclad appeared weaker in fatigue than joints of 24S-T Alclad. Joints of R303-T275 clad were about as strong as those of 24S-T, but not so much stronger as might have been expected on the basis of the higher static strength of the R303-T275 clad sheet.

While these results are true for the particular specimens tested, they may not be representative for joints produced with other riveting techniques.

Single-Row Flush-Riveted Lap Joints Made with Various Fabrication Techniques

In order to examine the importance of details of fabrication on the fatigue strength of flush-riveted joints, specimens of 24S-T Alclad and of 75S-T Alclad were fabricated in different laboratories and tested in direct-stress fatigue.

These specimens were of the type shown in figure 24(a) and were all made of 0.040-inch sheet. Table 7 shows the several dimpling procedures

used and gives the static strengths of the specimen groups. Figures 32 and 33 show typical cross sections through rivets.

The results of fatigue tests are shown, graphically, in figures 34 and 35. These tests were not intended to examine in detail the effects of different fabrication procedures, and the results should not be viewed with this expectation. The tests should allow an estimation of the magnitudes of variation in fatigue strengths among lots of riveted joints of generally acceptable static strengths. It appears that:

- (1) There is more variation in long-life fatigue strengths of joints of 75S-T Alclad than for joints of 24S-T Alclad.
- (2) The long-life fatigue strengths vary as much as ± 20 percent at 1,000,000 cycles, and are not in the same order as the static strengths.

Multi-Row Flush-Riveted Lap Joints of 24S-T Alclad and of 75S-T Alclad

There has been considerable evidence that increasing the number of rows of spot welds or of rivets in lap joints of 24S-T Alclad sheet does not proportionately increase the fatigue strength. A few tests have been made to investigate this situation for flush-riveted lap joints of 0.040-inch sheets of 24S-T Alclad and of 75S-T Alclad sheet materials.

Figure 24 shows the test pieces used. Table 8 gives static strengths of the joints, and figures 36 to 38 show the fatigue test results, in the form of load-life curves, for joints with two rows and joints with three rows of rivets.

Table 9 summarizes the results in a form suitable for comparing the strengths of joints with different numbers of rows of rivets. It appears that increasing the number of rows of rivets increases both static and fatigue strength of the joint, but decreases the strength per rivet. This decrease in strength per rivet is particularly noticeable under conditions of low load ratio and long-life fatigue.

In view of the importance of fabrication details, it is believed that the present tests are insufficient to afford definite design rules as to the effect of rivet pattern upon fatigue strength. The results do confirm other indications (note references 5 and 8) that increasing the number of rows of fasteners in a lap joint does not afford a proportional increase in fatigue strength of the joint.

Butt Joints and Stiffened Lap Joints of 24S-T Alclad

Although simple lap joints have been widely used in laboratory tests of comparative fatigue strengths, such joints are not actually used in

airframe construction. Airframe joints of sheet material nearly always involve some sort of stiffener (such as a wing spar or girder). Accordingly, a few tests were made to evaluate the effect of various stiffeners upon the fatigue strengths of riveted joints of 0.040-inch 24S-T Alclad sheets.

Figure 39 shows sketches of the various stiffened lap joints and butt joints tested. Table 10 gives static strength values and figures 40 and 41 show, in the form of load-life curves, the results of direct-stress fatigue tests in tension at $R = 0.40$.

As indicated in table 10, these joints had, with one exception, static-strength values within a narrow range (4550 to 4810 lb). The exception was a butt joint with double strap plates. Possibly additional friction gave this joint some of its additional strength (strength 7060 lb).

However, as shown in figures 40 and 41, the long-life fatigue strengths varied more widely. At 1,000,000 cycles (and in tension at $R = 0.40$) the unstiffened lap joints withstood about 1250 pounds, while lap joints with very heavy (3-in.-long, 0.250-in.-thick) stiffeners supported about 2600 pounds. At this same lifetime, butt joints with the single heavy (0.250-in.-thick) strap plate had a fatigue strength of nearly 3000 pounds; while butt joints with the two lighter strap plates had a fatigue strength of about 3500 pounds. Thus, stiffening riveted joints, while but slightly affecting the static strength, produced a marked increase in long-life fatigue strength. This effect is probably due to decreasing local high stresses resulting from bending at the lap. It should be noted that the amount of such bending varies with the length of specimen (all specimens in the present tests had an unsupported length of about 12 in.) and with the axiality of loading the over-all specimen. The present results hold only for the particular test specimens and loading conditions employed; however, the results show the importance of local bending stresses in affecting fatigue strength of riveted joints. The differences in fatigue strength are great enough to warrant further investigations of joints more closely approaching the conditions in aircraft structures.

A few specimens of multi-arc-welded joints of 24S-T Alclad were furnished through the courtesy of Mr. C. W. Stewart of the Curtiss-Wright Research Laboratory. Panels of sheet were welded and test pieces cut from these as indicated in figure 42. Half of the test pieces were given a solution heat treatment (30 min at 925° F) and aged 5 days at room temperature before testing. The remaining specimens were stress-relieved (10 hr at 370° F) before testing.

Figure 43 shows the direct-stress fatigue test results for the multi-arc-welded specimens. Reheat treatment after welding apparently decreased scatter and slightly decreased the long-time fatigue strength. Figure 44 shows cross sections of specimens after fatigue failure. Failure was in the heat-affected region near a weld bead.

Table 11 summarizes the results of fatigue tests in tension at $R = 0.40$ for several types of joint. Rated in terms of increasing fatigue strengths at 1,000,000 cycles the joints are: riveted lap joint, stiffened riveted lap joint, riveted butt joint with single strap plate, riveted butt joint with double strap plate, and multi-arc-welded butt joint.

Sheet-Efficiency Tests of Flush-Riveted 24S-T Alclad

In several aircraft applications, sheet materials are riveted together under circumstances in which the rivets need not carry large dynamic loads from one sheet to another, but in which weakening of a sheet by the rivet holes may be important in reducing the strength of the sheet.

In order to examine the effect of rivets upon the fatigue strength of the sheet material, specimens like that shown in figure 23 were tested in fatigue. Each specimen consisted of two sheets of 0.040-inch 24S-T Alclad held together with seven rivets in the test section. Attempts were made to load the sheets equally. The equality of loading was checked by using "stress-coat" lacquer and SR-4 strain gages, and it was estimated that sheets were equally loaded to within ± 10 percent.

Figure 45 shows the results of direct-stress fatigue tests on such specimens. A comparison of the results as given in table 12 shows a loss in ultimate tensile strength of about 22 percent, and a loss in fatigue strength of about 30 percent. This is more than is reasonably attributable to unequal load distribution and must be partly due to stress concentrations at rivet holes.

EFFECT OF ELEVATED TEMPERATURE ON THE FATIGUE STRENGTHS OF SHEET AND FLUSH-RIVETED JOINTS OF 24S-T ALCLAD AND 75S-T ALCLAD

With increasing use of heat for de-icing, it becomes important to know whether elevated temperatures may seriously impair the fatigue strengths of airframe structures. The following tests were designed to survey this possibility and to observe any major effects that might occur.

Many of the elevated-temperature fatigue tests of aluminum alloys reported in the literature have involved long-time preheating to a "stabilized state" (see, for example, reference 9). The present tests were made by holding each specimen at temperature for 1 hour before fatigue testing and testing at temperature. The single elevated

temperature chosen was 375° F. While this test is not so severe as possible, it should show up any serious loss of fatigue strength likely to occur because of relatively short-time heating by de-icers.

Specimens were heated, both before and during fatigue testing, in a small electric furnace built for such tests of sheet specimens. The temperature was controlled by means of a Foxboro controller operated by a thermocouple inside the furnace next to the center of the test piece. Temperatures were held constant to ±5° F and temperature gradients were very small near the center of each specimen (where failure occurred).

Table 13 shows static strengths at 70° and 375° F of the various specimens. All specimens were weaker than at room temperature, the loss in strength ranging from 5 to 17 percent for 24S-T Alclad specimens and from 14 to 27 percent for the 75S-T Alclad specimens.

Figures 46 and 47 show for 24S-T Alclad and 75S-T Alclad, respectively, the results of some direct-stress fatigue tests of unnotched sheet specimens; the extent of scatter is apparent, and the results of room-temperature tests on similar specimens are indicated in these figures. Table 14 gives results of a few fatigue tests at 375° F of sheet specimens notched by drilled holes. (See fig. 1(b).)

Within the experimental scatter, there appears to be little loss in fatigue strength due to the increased temperature. At the longer lifetimes, and especially for 75S-T Alclad, there is an indication of lower fatigue strength at lifetimes of the order of 1,000,000 cycles. It may be noted that such a lifetime means a total of 12 hours at temperature. (The machines used in these tests ran 1500 cpm.)

Table 15 lists results of several fatigue tests at 375° F of riveted joints of 24S-T Alclad and of 75S-T Alclad sheets of 0.040-inch gage. Comparison of lifetimes observed in these tests with lifetimes (taken from averaging curves) for room-temperature tests shows a general trend for the joints to have shorter lives at the elevated temperature. There is considerable variation, however, and the few tests described are insufficient to determine the extent of weakening. As indicated in figure 48 for lap joints of 24S-T Alclad, the average fatigue strength decrease is not so great as the decrease in static strength.

The general result of these survey tests on the elevated-temperature fatigue strengths of 24S-T Alclad and 75S-T Alclad, both with and without notches, is that no large decrease in fatigue strength was found for short-time heating up to 375° F. The decrease in fatigue strength was generally less than experimental error and was definitely less than the decrease in static ultimate strength observed for the specimens tested.

RESULTS OF TESTS FOR FATIGUE DAMAGE

Service loading of sheet materials in aircraft is seldom limited to cycles of a single range of alternating stress. The range of alternating stress usually varies considerably in magnitude during flight, maneuvers, landing, and taxiing. Thus, the effect of a few repetitions of high stress on the fatigue strength at low stress levels becomes of considerable importance. (See reference 10.) Tests for such damage, made during the course of this investigation, are described in this section.

Effect of Repeated Loadings on Static Strength

Table 16 shows static-ultimate-strength values for several specimens which had undergone many cycles of repeated direct stress. In most cases, this number of cycles was very small compared with the estimated lifetime at the given load. As indicated in table 16, static strengths were generally within ±3 percent of the strengths of similar specimens which had not undergone repeated stressing; there was evidence neither of damage nor of strengthening sufficient to affect the static tensile ultimate.

Results of Fatigue-Damage Tests at Two Load Levels

Table 17 shows the results of several tests in which each specimen was run at one load level for some fraction of its endurance lifetime at that level and then was run to failure at another load. The data are arranged to illustrate the application of a very simple assumption of fatigue damage (see references 11 and 12); namely, that every cycle at any load produces damage proportional to the ratio of the number of cycles run at that load to the endurance lifetime at the load. Thus, if n_1 and n_2 are the numbers of cycles run at two load levels at which the endurance lifetimes are N_1 and N_2 , respectively, failure should occur when

$$\frac{n_1}{N_1} + \frac{n_2}{N_2} = 1 \quad (1)$$

The results in table 17 show, for the average of all tests, a "calculated" damage at failure of 99.7 percent and values for individual specimens as high as 134 percent and as low as 50 percent.

Conclusions from such tests should be interpreted with due appreciation of the scatter inherent in most fatigue test results. Figure 49 shows

an estimated scatter band for a few tests of unnotched specimens of 24S-T Alclad at a constant mean stress of 40,000 psi, and figure 50 shows some of the damage tests with reference to this scatter band. The end points for the tests shown in figure 50 lie within the scatter band.¹ Within the error of the experiments, therefore, the test results generally conform to the calculation of damage based upon equation (1).

Results of Tests for Damage Due to Repeated

Stressing at Several Load Levels

Several reports (references 12 to 14) contain discussion of service stresses due to gust loading of aircraft wings. Such loadings generally involve many repetitions of low stresses and fewer repetitions of high stresses. A few riveted joints have been tested in fatigue under this general type of variation in magnitude of repeated stresses.

In particular, the loading indicated in table 1 of reference 12 was approximated. Each test consisted in running a specimen, at a constant mean load (21.2 percent of its static ultimate), at various maximum loads. The number of cycles run at each maximum load was in proportion to the frequency of occurrence of gusts which might produce such loading (under the conditions noted in reference 12). In the laboratory tests, the different load levels were not applied at random, but two limiting cases were chosen. In one case, high loads were applied first and successively lower loads in order; in the other case, this sequence was reversed. Specimens which did not fail during the schedule of repeated loadings were tested statically to find possible evidence of reduced static strength.

Tables 18, 19, and 20 give the results of these tests. On the average, the estimated damage at failure was 102 percent. The value for specimen 13 - 43 in table 20 is omitted from this average since failure in this case was uncertain. Individual cases vary from 75 percent to 161 percent; however, the base curves for virgin specimens (shown in figs. 51 to 53) are hardly adequate for more accurate analysis than 130 percent. Much more extensive investigation is needed for analysis of the details of damage, and strengthening, in fatigue. (See reference 3.) In general, however, the results described here and similar results from investigations (reference 11) indicate that, for aluminum-alloy sheet specimens, the cumulative damage behavior implied in equation (1) is a useful approximation.

¹ Despite additional error due to values of N having been based upon a mean curve in the center of the scatter band. (See fig. 49.)

CONCLUSIONS

Direct-stress fatigue tests of 0.040-inch-thick specimens of several aluminum-alloy sheet materials and of various riveted joints in these sheet materials have been made. From the results of these tests, the following conclusions were reached in regard to the fatigue properties of the sheet materials:

1. At long lifetimes, the bare materials, both with and without a stress-raiser, had considerably higher fatigue strengths than corresponding clad materials.

2. At short lifetimes, the difference in fatigue strengths of bare and clad material was less. In the presence of a stress-raiser such as a 3/8-inch hole, the short-life fatigue strength of the clad material may actually be higher than that of the bare. Apparently, at high stresses, the cladding can yield so as to reduce the stress concentration produced by the hole, while, at low stresses, the cladding reduces the fatigue strength.

3. Although the static strengths of 75S-T Alclad and R303-T275 clad were higher than that of 24S-T Alclad, the long-life fatigue strengths were generally lower. This may have been partly due to the importance of cladding in determining fatigue strength. However, results for bare R303-T275 showed that, even in the absence of cladding, this material was not so strong in fatigue as might have been expected in view of its static strength.

4. Shallow scratches did not seem detrimental to the fatigue strength of Alclad sheet materials. Scratches deeper than the minimum depth of cladding may, however, cause quite large reduction in fatigue strength.

5. The clad materials, both with and without a stress-raiser, appeared to have almost the same fatigue strength at 375° F as at room temperature.

6. Results of several tests for fatigue damage of 24S-T Alclad and of 75S-T Alclad were compatible with the simple approximation that damage due to any alternating stress is proportional to the ratio of the number of cycles at such stress to the endurance lifetime at that stress.

In regard to the fatigue properties of riveted joints it was found that:

1. Single-row riveted lap joints of the various sheet materials showed long-life fatigue strengths decreasing in the following order: 24S-T bare, 24S-T Alclad, R303-T275 clad, 75S-T Alclad, and R303-T275 bare. The R303-T275 bare specimens had internal cracks produced during dimpling.

2. Comparison of specimens dimpled by different operators and including various processes - coin dimpling, spin dimpling, and hot dimpling - showed fatigue strengths varying as much as ± 10 percent. The variation in fatigue strengths was not in the same order as the variation in static strengths.

3. Lap joints with several rows of rivets were stronger in fatigue than joints with single rows, but the strength in pounds per rivet decreased as the number of rows increased.

4. Butt joints and stiffened lap joints were generally considerably stronger in fatigue than simple lap joints, although there was relatively little difference in static strength.

5. Equally loaded sheets, joined by rivets which carried little shear load, were about 30 percent weaker in fatigue strength than plain sheets. At least part of this weakening was due to stress concentrations around the rivets.

6. Riveted joints had not much lower fatigue strengths at 375° F than at room temperature.

7. Cumulative damage of riveted joints appeared to be approximately predictable in terms of the percent of endurance lifetimes run at each stress level.

All tests were limited to 0.040-inch sheet and, except for 24S-T Alclad, to a single lot of each material. However, there is some reason to believe the results are generally typical for the materials concerned over some range of sheet thicknesses. It might be noted, however, that only one type of notch was used in the present tests and that somewhat different results might be obtained by using a notch giving much higher stress concentration.

Battelle Memorial Institute
Columbus, Ohio, February 15, 1946

REFERENCES

1. Russell, H. W., and Jackson, L. R.: Progress Report on Fatigue of Spot-Welded Aluminum. NACA ARR, Feb. 1943.
2. Russell, H. W., Jackson, L. R., Grover, H. J., and Beaver, W. W.: Fatigue Characteristics of Spot-Welded 24S-T Aluminum Alloy. NACA ARR No. 3F16, 1943.
3. Russell, H. W.: Fatigue Strength and Related Characteristics of Spot-Welded Joints in 24S-T Alclad Sheet. NACA ARR No. 3L01, 1943.
4. Russell, H. W., Jackson, L. R., Grover, H. J., and Beaver, W. W.: Fatigue Strength and Related Characteristics of Joints in 24S-T Alclad Sheet. NACA ARR No. 4E30, 1944.
5. Russell, H. W., Jackson, L. R., Grover, H. J., and Beaver, W. W.: Fatigue Strength and Related Characteristics of Aircraft Joints. I - Comparison of Spot-Weld and Rivet Patterns in 24S-T Alclad Sheet - Comparison of 24S-T Alclad and 75S-T Alclad. NACA ARR No. 4F01, 1944.
6. Brueggeman, W. C., and Mayer, M., Jr.: Guides for Preventing Buckling in Axial Fatigue Tests of Thin Sheet-Metal Specimens. NACA TN No. 931, 1944.
7. Andrews, H. J., and Stickley, G. W.: Effect of Scratches on Fatigue Strength of Alclad Sheet. Aviation, vol. 42, no. 6, June 1943, pp. 154-155, 157.
8. Jackson, L. R., Wilson, W. M., Moore, H. F., and Grover, H. J.: The Fatigue Characteristics of Bolted Lap Joints of 24S-T Alclad Sheet Materials. NACA TN No. 1030, 1946.
9. Wyman, L. L.: High Temperature Properties of Light Alloys (NA-137). I - Aluminum. OSRD No. 3607, Serial No. M-251, War Metallurgy Div., NDRC, April 15, 1944.
10. Bennett, J. A.: Effect of Fatigue-Stressing Short of Failure on Some Typical Aircraft Metals. NACA TN No. 992, 1945.
11. Miner, Milton A.: Cumulative Damage in Fatigue. Jour. Appl. Mech., vol. 12, no. 3, Sept. 1945, pp. A159-A164.
12. Jackson, L. R., and Grover, H. J.: The Application of Data on Strength under Repeated Stresses to the Design of Aircraft. NACA ARR No. 5H27, 1945.

13. Rhode, Richard V., and Donely, Philip: Frequency of Occurrence of Atmospheric Gusts and of Related Loads on Airplane Structures. NACA ARR No. L4T21, 1944.
14. Putnam, A. A.: An Analysis of Life Expectancy of Airplane Wings in Normal Cruising Flight. NACA ARR No. L5F27a, 1945.

TABLE 1. - STATIC PROPERTIES OF SHEET MATERIALS USED IN FATIGUE TESTS

[Test section, 1.000 by 0.040 in.; gage length, 2 in.]

| Material | Direction (a) | Specimen | Ultimate tensile strength (psi) | Tensile yield strength, 0.2 percent elongation (psi) | Elongation in 2 in. (percent) | |
|----------------|----------------|--------------|---------------------------------|--|-------------------------------|-------------------------|
| 24S-T Alclad | Parallel | 1-32 | 69,600 | 51,900 | 15.3 | |
| | | 1-33 | 69,100 ^b 69,350 | 51,800 ^b 51,850 | 14.5 ^b 14.9 | |
| | Transverse | 27-15 | 67,700 | 46,850 | 16.1 | |
| | | 27-16 | 67,100 ^b 67,400 | 46,750 ^b 46,800 | 15.3 ^b 15.7 | |
| 24S-T bare | Parallel | 1A-18 | 74,000 | 54,240 | 16.0 | |
| | | 1A-19 | 73,400 ^b 73,700 | 53,760 ^b 54,000 | 16.0 ^b 16.0 | |
| | | 75S-T Alclad | 7-19 | 81,200 | 70,300 | 10.4 |
| 75S-T Alclad | Parallel | 7-20 | 81,200 ^b 81,200 | 70,000 ^b 70,150 | 10.4 ^b 10.4 | |
| | | Transverse | 28-13 | 80,800 | 68,350 | 10.6 |
| | 28-14 | | 79,500 ^b 80,150 | 67,680 ^b 68,020 | 9.3 ^b 9.9 | |
| | R303-T275 clad | Parallel | 9-19 | 75,400 | 64,800 | 7.3 |
| | | | 9-20 | 75,500 ^b 75,450 | 64,600 ^b 64,700 | 8.0 ^b 7.7 |
| | | Transverse | 29-9 | 74,400 | 67,200 | 7.2 |
| 29-10 | | | 74,900 ^b 74,650 | 67,200 ^b 67,200 | 7.8 ^b 7.5 | |
| R303-T275 bare | Parallel | 9A-19 | 82,400 | 71,330 | 8.2 | |
| | | 9A-20 | 83,200 ^b 82,800 | 72,990 ^b 72,160 | 9.2 ^b 8.7 | |

TABLE 2. - STATIC PROPERTIES OF ALUMINUM SHEET ALLOYS CONTAINING A SINGLE HOLE

[Test section, 1½ in. wide; diameter of hole, 0.375 in.]

All tests of 0.040-in.-thick sheet. Loads calculated on net section. Specimens cut in direction of rolling.

| Material | Sample | Ultimate tensile strength (psi) | Elongation in 2 in. (percent) |
|----------------|----------------|---------------------------------|-------------------------------|
| 24S-T Alclad | 5-18 | 61,200 | 4.9 |
| | 5-19 | 62,200 | 4.9 |
| | 5-20 | 62,100 ^a 61,833 | 4.9 |
| 24S-T bare | 5A-19 | 67,100 | 4.6 |
| | 5A-20 | 67,600 ^a 67,350 | 4.4 4.5 |
| 75S-T Alclad | 8-9 | 78,500 | 3.1 |
| | 8-10 | 78,500 ^a 78,500 | 3.2 3.15 |
| R303-T275 clad | 10-9 | 74,200 | 3.2 |
| | 10-10 | 72,200 ^a 73,200 | 2.6 2.9 |
| | R303-T275 bare | 10A-9 | 82,400 |
| 10A-10 | | 82,400 ^a 82,400 | 2.2 2.5 |

^aAverage.



^aDirection of loading with respect to direction of rolling of sheet.

^bAverage.

TABLE 3. - REDUCTIONS IN FATIGUE STRENGTH DUE TO DRILLED HOLES IN VARIOUS SHEET MATERIALS

[Test section, 1.500 by 0.040 in.; diameter of hole, 0.375 in. Specimens cut in direction of rolling. Theoretical stress-concentration factor for the specimen is about 2.45. (See reference 8.)]

| Material | Static-strength reduction ratio (1) | Fatigue-strength reduction ratio for indicated load ratios and lifetimes (2) | | | | | | | | |
|----------------|-------------------------------------|--|-----------------|-----------------|--------------------|-----------------|-----------------|--------------------|-----------------|-----------------|
| | | R = -0.50 (compression) | | | R = 0.25 (tension) | | | R = 0.60 (tension) | | |
| | | 10 ⁴ | 10 ⁵ | 10 ⁶ | 10 ⁴ | 10 ⁵ | 10 ⁶ | 10 ⁴ | 10 ⁵ | 10 ⁶ |
| 24S-T Alclad | 1.13 | 1.8 | 2.1 | 1.9 | 1.4 | 1.7 | 1.8 | 1.2 | 1.5 | 1.8 |
| 24S-T bare | 1.10 | --- | --- | --- | --- | 1.8 | 1.9 | 1.2 | 1.5 | 1.7 |
| 75S-T Alclad | 1.03 | 1.7 | 1.9 | --- | 1.8 | 1.8 | 1.9 | 1.2 | 1.8 | 1.6 |
| R303-T275 clad | 1.03 | --- | --- | --- | 1.7 | 1.9 | 1.9 | 1.1 | 1.7 | 1.3 |
| R303-T275 bare | 1.01 | --- | --- | --- | --- | 2.2 | 2.2 | 1.4 | 2.0 | 2.0 |

¹Ultimate tensile strength of unnotched sheet divided by nominal (net section) ultimate tensile strength of drilled sheet. See tables 1 and 2.

²Maximum stress supported by unnotched sheet for a given lifetime at a given load ratio divided by nominal (net section) maximum stress supported by drilled specimen for same lifetime at same load ratio. Values taken from curves in figs. 2 to 6 and 10 to 14.



TABLE 4. - DEPTH OF SCRATCH PRODUCED BY VARIOUS METHODS

| Material | Cutting tool | Force on tool (lb) | Depth of scratch (in.) |
|--------------|--------------------------|--------------------|------------------------|
| Alclad sheet | Steel or sapphire needle | 1.22 | 0.0013 ± 0.0003 |
| Alclad sheet | Steel needle | 5.22 | .0039 ± .0002 |
| Alclad sheet | Steel needle | 9.02 | .0053 ± .0005 |
| Bare 24S-T | Steel or sapphire needle | 1.22 | .0014 ± .0001 |



**TABLE 5.- EFFECT OF SCRATCHES ON FATIGUE STRENGTH IN TENSION
 AT R = MINIMUM LOAD/MAXIMUM LOAD = 0.25**

[Specimens cut in direction of rolling. See figs. 2, 3, and 4
 for data on undamaged sheet.]

| Material | Specimen | Depth of scratch, non-destructive measurement | | Depth of scratch measured after failure (in.) | Depth of Alclad (in.) | Stress (psi) | Number of cycles | Reduction of maximum stress (percent) | Cutting tool used | Weight on beam (lb) | |
|---------------------------|---------------------------|---|-----------------|---|-----------------------|--------------|------------------|---------------------------------------|-------------------|---------------------|---|
| | | Mean (in.) | Average (in.) | | | | | | | | |
| 24S-T bare 0.040 in. | 2A-28 | 0.00110 ± 0.00008 | 0.00111 | ----- | ----- | 55,000 | 68,000 | 15.2 | Sapphire | 0 | |
| | 29 | .00142 ± .00624 | .00132 | 0.00156 | ----- | 50,000 | 82,400 | 19 | -----do----- | 0 | |
| | 30 | .00161 ± .00161 | .00152 | .00152 | ----- | 47,000 | 4,064,100 | None ¹ | -----do----- | 0 | |
| | 37 | .00157 ± .00008 | .00153 | ----- | ----- | 58,000 | 16,300 | 17.0 | -----do----- | 0 | |
| | 38 | .00134 ± .00007 | .00138 | ----- | ----- | 53,000 | 56,200 | 18.3 | -----do----- | 0 | |
| | 39 | .00130 ± .00011 | .00126 | .00152 | ----- | 45,000 | >11,846,900 | None ¹ | -----do----- | 0 | |
| | 1 | .00166 ± .00023 | .00168 | ----- | ----- | 55,000 | 62,500 | 14.6 | Steel needle | 0 | |
| | 2 | .00142 ± .00023 | .00164 | ----- | ----- | 50,000 | 101,700 | 19 | -----do----- | 0 | |
| | 3 | .00158 ± .00024 | .00155 | ----- | ----- | 60,000 | 26,400 | 14.5 | -----do----- | 0 | |
| | 24S-T Alclad 0.040 in. | 2-50 | .00371 ± .00024 | .0039 | .0039 | 0.0018 | 40,000 | 62,000 | 29.0 ₁ | -----do----- | 2 |
| 51 | | .00371 ± .00056 | .00373 | .00373 | .0020 | 30,000 | 874,000 | None ¹ | -----do----- | 2 | |
| 52 | | .00390 ± .00050 | .0039 | .0039 | .0018 | 35,000 | 371,000 | None ¹ | -----do----- | 2 | |
| 53 | | .00493 ± .00019 | .00497 | .00497 | .0022 | 30,000 | 203,500 | 27.0 | -----do----- | 2 | |
| 27 | | .00583 ± .00087 | .0056 | .0056 | .0018 | 30,000 | 87,500 | 42.0 | -----do----- | 3.9 | |
| 28 | | .00477 ± .00091 | .0049 | .0049 | .0022 | 40,000 | 34,800 | 44.4 | -----do----- | 3.9 | |
| 31 | | .00229 ± .00032 | .00232 | .0022 | .0018 | 40,000 | 241,400 | None ¹ | Sapphire | 0 | |
| 32 | | .00193 ± .0004 | .00185 | .0018 | .0017 | 48,000 | 60,000 | 15.0 | -----do----- | 0 | |
| 33 | | .00114 ± .00026 | .00143 | .0014 | .0017 | 55,000 | 33,900 | 11.0 | -----do----- | 0 | |
| 34 | | .00162 ± .00028 | .00165 | .0020 | .0024 | 32,000 | 654,000 | None ¹ | -----do----- | 0 | |
| 35 | | .00166 ± .00015 | .00164 | .0009 | .0020 | 30,000 | 618,100 | 5.0 | -----do----- | 0 | |
| 75S-T Alclad 0.040 in. | | 7-36 | .00111 ± .00015 | .00110 | .0015 | .0011 | 40,000 | 216,500 | None ¹ | Steel needle | 0 |
| | | 37 | .00105 ± .00025 | .00101 | .0009 | .0019 | 35,000 | 365,000 | None ¹ | -----do----- | 0 |
| | 38 | .00517 ± .00075 | .00512 | .0058 | .0014 | 40,000 | 39,200 | 35.0 | -----do----- | 3.9 | |
| | 39 | .00499 ± .00030 | .00510 | .0048 | .0015 | 35,000 | 90,200 | 43.0 | -----do----- | 3.9 | |
| 24S-T Alclad 0.102 in. | 16-1 | .00576 ± .00079 | .00588 | ----- | .00304 | 40,000 | 36,600 | 35.4 | -----do----- | 3.9 | |
| | 2 | .00568 ± .00062 | .00574 | .0069 | .00288 | 30,000 | 290,800 | 19.0 | -----do----- | 3.9 | |
| | 5 | .00559 ± .00061 | .00569 | .0062 | .00343 | 35,000 | 87,800 | 31.0 | -----do----- | 3.9 | |
| | 6 | .00371 ± .00071 | .00407 | .0035 | .00260 | 40,000 | 18,500 | 41.0 | -----do----- | 2.0 | |
| | 8 | .00388 ± .00014 | .00427 | .0043 | .00266 | 35,000 | 120,900 | 25.2 | -----do----- | 2.0 | |
| | 9 | .00422 ± .00071 | .00423 | .0051 | .00275 | 30,000 | 251,900 | 23.0 | -----do----- | 2.0 | |
| | 10 | .00140 ± .00045 | .00147 | .0008 | .0025 | 35,000 | 357,400 | None ¹ | -----do----- | 0 | |
| | 11 | .00130 ± .00051 | .00126 | .0012 | .0027 | 40,000 | 185,200 | None ¹ | -----do----- | 0 | |

¹Did not fail through scratch.

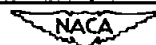

TABLE 6.- STATIC-TENSION ULTIMATE LOADS FOR SINGLE-ROW RIVETED LAP JOINTS OF VARIOUS SHEET MATERIALS

[Each specimen made of 0.040-in. sheet, $4\frac{1}{2}$ in. wide, containing eight rivets. (See fig. 24(a) and text for further details.)]

| Material | Specimen | Load to static failure (a) | |
|----------------|----------|-------------------------------|------------------|
| | | (lb) | (lb/rivet) |
| 24S-T Alclad | 12-10 | 4630 | 579 |
| | 20 | 4750 | 594 |
| | 30 | 4625 | 578 |
| | 40 | 4745 | 593 |
| | 50 | 4685 | 586 |
| | 60 | 4600 | 575 |
| | | ^b 4672 | ^b 584 |
| 24S-T bare | 12A-9 | 4330 | 541 |
| | 10 | 4075 | 509 |
| | | ^b 4202 | ^b 525 |
| 75S-T Alclad | 13- 9 | 5100 | 637 |
| | 10 | 4850 | 606 |
| | | ^b 4975 | ^b 622 |
| R303-T275 clad | 15- 9 | 4775 | 597 |
| | 10 | 4860 | 607 |
| | | ^b 4818 | ^b 602 |
| R303-T275 bare | 15- 9 | 5080 | 635 |
| | 10 | 4820 | 602 |
| | | ^b 4950 | ^b 619 |

^aAll failures by rivet shear.

^bAverage.

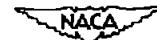

**TABLE 7.- STATIC-TENSION ULTIMATE LOADS FOR SINGLE-ROW RIVETED LAP JOINTS
 PREPARED AT DIFFERENT LABORATORIES USING VARIOUS DIMPLING TECHNIQUES**

[Each specimen made of 0.040-in. sheet, $4\frac{1}{2}$ in. wide,
 containing eight AN426AD rivets. (See fig. 24(a).)]

| Material | Test | Dimpling | Riveting | Load to static failure (1) | |
|----------------|------|--|--------------------|-------------------------------|------------|
| | | | | (lb) | (lb/rivet) |
| 24S-T Alclad | 12 | Conventional tool (see text) (done at B. M. I.) | At B. M. I. | 4672 | 584 |
| | 12N | Coin dimpling tool (done at North American) | At B. M. I. | 4682 | 608 |
| | 37 | Conventional tool (see text) (done at Curtiss-Wright) | At Curtiss-Wright | 4700 | 588 |
| | 34 | Spin dimpling tool (done at Glenn L. Martin) | At Glenn L. Martin | 3770 | 471 |
| 75S-T Alclad | 13 | Conventional tool (done at B. M. I.) | At B. M. I. | 4975 | 622 |
| | 13N | Coin dimpling tool (done at North American) | At B. M. I. | 5307 | 663 |
| | 38 | Conventional tool (done at Curtiss-Wright) | At Curtiss-Wright | 5335 | 667 |
| | 39 | Hot dimpling on a.-c. spot welder (Curtiss-Wright) | At Curtiss-Wright | 5815 | 731 |
| XA75S-T Alclad | 35 | Spin dimpling tool (done at Glenn L. Martin) | At Glenn L. Martin | 4070 | 509 |

¹All static failures by rivet shear; static-strength values are averages for two specimens of each group.



**TABLE 8. - STATIC-TENSION ULTIMATE LOADS FOR MULTI-ROW RIVETED
 LAP JOINTS OF 24S-T ALCLAD AND 75S-T ALCLAD**

| Material | Number of rows | Specimens | Load to static failure (a) | |
|--------------|----------------|---------------|---------------------------------------|------------|
| | | | (lb) | (lb/rivet) |
| 24S-T Alclad | 1 | (b) | ^c 4672 | 584 |
| 24S-T Alclad | 2 | 31-5 31-6 | 8360 8440 ^c 8400 | 525 |
| 24S-T Alclad | 3 | 32-1 32-2 | 9120 9080 ^c 9100 | 379 |
| 75S-T Alclad | 1 | (b) | ^c 4975 | 622 |
| 75S-T Alclad | 2 | 36-9 36-10 | 10,000 9,650 ^c 9,925 | 620 |

^aAll failures were by rivet shear.

^bSee table 6.

^cAverage.



**TABLE 9. - COMPARISON OF FATIGUE STRENGTHS OF LAP-JOINT
 SPECIMENS WITH DIFFERENT NUMBERS OF ROWS OF RIVETS**

| Material | Test Condition | Maximum strength values (1) | | | | | |
|------------------------|--------------------------|-----------------------------|--------|--------|------------|--------|--------|
| | | (lb) | | | (lb/rivet) | | |
| | | 1 row | 2 rows | 3 rows | 1 row | 2 rows | 3 rows |
| 24S-T Alclad | Static | 4600 | 8400 | 9925 | 575 | 525 | 414 |
| | In tension, R = 0.25 at: | | | | | | |
| | 10 ⁴ cycles | 3700 | 5900 | 6000 | 463 | 369 | 250 |
| | 10 ⁵ cycles | 2000 | 3000 | 3300 | 250 | 188 | 138 |
| | 10 ⁶ cycles | 930 | 1700 | 2050 | 104 | 106 | 85 |
| | R = 0.40 at: | | | | | | |
| | 10 ⁴ cycles | 4000 | 7000 | 7300 | 500 | 438 | 304 |
| 10 ⁵ cycles | 2500 | 3600 | 4200 | 313 | 225 | 175 | |
| 10 ⁶ cycles | 1300 | 2000 | 2400 | 163 | 125 | 100 | |
| 75S-T Alclad | Static | 4975 | 9925 | ---- | 622 | 620 | --- |
| | In tension, R = 0.40 at: | | | | | | |
| | 10 ⁴ cycles | 4050 | 5000 | ---- | 506 | 313 | --- |
| | 10 ⁵ cycles | 1700 | 3000 | ---- | 213 | 188 | --- |
| 10 ⁶ cycles | 900 | 1500 | ---- | 113 | 94 | --- | |

¹The fatigue-strength values were read from the curves shown in figs. 27, 28, 36, 37, and 38.



TABLE 10.- STATIC STRENGTHS OF RIVETED LAP JOINTS WITH STIFFENERS AND OF RIVETED BUTT JOINTS

[All joints $\frac{1}{2}$ in. wide. Each lap joint had one row and each butt joint two rows of eight rivets spaced $\frac{1}{2}$ in. between centers.]

| Specimen type | Specimen | Load to static failure | |
|---|----------|------------------------|------------|
| | | (lb) | (lb/rivet) |
| Simple lap joint (no stiffener) | (a) | ^b 4672 | 584 |
| Lap joint with 3-in. stiffener of 0.250-in. gage (fig. 39(a)) | 18-1 | 4620 | 568 |
| | 18-2 | 4480 | |
| | | ^b 4550 | |
| Lap joint with 3-in. stiffener of 0.51-in. gage (fig. 39(a)) | 24-6 | 4580 | 601 |
| | 24-7 | 5040 | |
| | | ^b 4810 | |
| Butt joint with single 3-in. strap of 0.250-in. gage (fig. 39(b)) | 19-1 | 4330 | 601 |
| | 19-2 | 5280 | |
| Butt joint with double 3-in. strap of 0.040-in. gage (fig. 39(b)) | 33-11 | 7100 | 758 |
| | 33-12 | 7020 | |
| | | ^b 7060 | |

^aSee table 6.
^bAverage.



TABLE 11.- SUMMARY OF FATIGUE STRENGTHS IN TENSION AT R = 0.40 OF VARIOUS TYPES OF JOINT

[All strengths in lb/linear in. of joint.]

| Type of joint | Static strength | Fatigue strengths in tension at R = 0.40 and at indicated cycles | | | |
|---|-----------------|--|-----------------|-----------------|-----------------|
| | | 10 ⁴ | 10 ⁵ | 10 ⁶ | 10 ⁷ |
| Riveted lap joint; no stiffener; one row of rivets | 1040 | 890 | 555 | 289 | 244 |
| Riveted lap joint; no stiffener; two rows of rivets | 1865 | 1560 | 800 | 443 | ---- |
| Riveted lap joint; no stiffener; three rows of rivets | 2020 | 1620 | 935 | 533 | ---- |
| Riveted lap joint; heavy stiffener (3 in. long, 0.250 in. thick); one row of rivets | 1010 | ---- | 889 | 600 | 489 |
| Riveted butt joint; single 0.250-in.-thick strap plate | 1070 | ---- | 845 | 645 | 555 |
| Riveted butt joint; two 0.040-in.-thick strap plates | 1570 | ---- | 1070 | 777 | ---- |
| Multi-arc-welded joint (solution-heat-treated after welding) | 2070 | 2060 | 1680 | 1220 | 1160 |
| Unnotched sheet; no joint | 2710 | 2580 | 2260 | 1400 | 1290 |



TABLE 12.- RESULTS FROM SHEET-EFFICIENCY TESTS

[All values were read from smooth curves plotted in figs. 2 and 45.]

| Test condition | Strength of sheet (psi) | Nominal strength of riveted sheets (psi) | Reduction in strength (percent) |
|-------------------------------------|-------------------------|--|---------------------------------|
| Static | 68,000 | 52,500 | 21.6 |
| Fatigue in tension at R = 0.40 for: | | | |
| 10 ⁴ cycles | ----- | 52,000 | ---- |
| 10 ⁵ cycles | 57,500 | 38,500 | 33.0 |
| 10 ⁶ cycles | 37,500 | 26,500 | 29.3 |
| 10 ⁷ cycles | 31,000 | 24,000 | 22.6 |
| Fatigue in tension at R = 0.60 for: | | | |
| 10 ⁴ cycles | ----- | ----- | ---- |
| 10 ⁵ cycles | 65,000 | 46,000 | 29.2 |
| 10 ⁶ cycles | 48,000 | 35,000 | 27.1 |
| 10 ⁷ cycles | 42,000 | 31,000 | 26.2 |

NACA

TABLE 13.- STATIC STRENGTHS OF SHEET SPECIMENS AND OF RIVETED JOINTS AT 70° AND 375° F

[Each specimen tested at 375° F was held at this temperature for 1 hr preceding the test.]

| Material | Specimen type | Ultimate tensile strength at - | |
|--------------|--|--------------------------------|-------------------------|
| | | 70° F | 375° F |
| 24S-T Alclad | Unnotched sheet | 69,350 psi | 59,550 psi |
| | Sheet with central drilled hole | ^a 61,833 psi | ^a 57,900 psi |
| | Lap joint with one row of rivets | 4672 lb | 3910 lb |
| | Butt joint with two 0.040-in. strap plates | 7060 lb | 6740 lb |
| 75S-T Alclad | Unnotched sheet | 81,200 psi | 59,350 psi |
| | Sheet with central drilled hole | ^a 78,500 psi | ^a 64,700 psi |
| | Lap joint with one row of rivets | 4975 lb | 4300 lb |
| | Lap joint with two rows of rivets | 9925 lb | 7620 lb |

^aNet section.

NACA

TABLE 14.- RESULTS OF FATIGUE TESTS AT 375° F OF SHEET SPECIMENS NOTCHED BY DRILLED HOLES

[All tests in tension at R = 0.40; specimens of type shown in fig. 1(b). Each specimen held at 375° F for 1 hr preceding test and then during test.]

| Material | Specimen | Maximum stress (psi) (1) | Cycles to failure at - | |
|--------------|----------|--------------------------------|------------------------|--------------|
| | | | 375° F | 70° F (2) |
| 24S-T Alclad | 30-9 | 40,000 | 40,700 | 50,000 |
| | 30-3 | 40,000 | 54,900 | |
| | 30-10 | 30,000 | 97,300 | 200,000 |
| | 30-1 | 30,000 | 279,500 | |
| | 30-2 | 25,000 | 785,100 | 550,000 |
| 75S-T Alclad | 41-3 | 40,000 | 30,500 | 50,000 |
| | 41-4 | 28,000 | 154,300 | 300,000 |

¹Stress in psi based on net section through hole.
²Values read from curves in figs. 10 and 12.



TABLE 15.- RESULTS OF FATIGUE TESTS AT 375° F OF VARIOUS RIVETED JOINTS IN 0.040-INCH ALUMINUM-ALLOY SHEET

[All tests in tension at R = 0.40. Each specimen held at 375° F for 1 hr preceding test and during test.]

| Material | Type of joint | Maximum load (lb) | Cycles to failure at - | |
|----------------|--|----------------------|------------------------|---------------|
| | | | 375° F | 70° F, (1) |
| 24S-T Alclad | Lap joint with one row rivets (fig. 24(a)) | 2,700 | 33,800 | 65,000 |
| | | 2,600 | 51,900 | 80,000 |
| | | 2,500 | 48,700 | 100,000 |
| | | 2,200 | 71,300 | 130,000 |
| | | 2,000 | 154,200 | 180,000 |
| | | 1,700 | 187,300 | 310,000 |
| | | 1,500 | 424,000 | 500,000 |
| | | 1,200 | >1,232,700 | 1,300,000 |
| 24S-T Alclad | Butt joint, two strap plates each 0.040 in. (fig. 39(b)) | 5,400 | 27,000 | 28,000 |
| | | 5,000 | 92,000 | 72,000 |
| | | 4,300 | 188,800 | 210,000 |
| | | 3,800 | 413,600 | 400,000 |
| XA75S-T Alclad | Lap joint, spin dimpled (fig. 24(a)) | 2,400 | 16,300 | 25,000 |
| | | 2,000 | 36,500 | 45,000 |
| | | 1,700 | 64,100 | 120,000 |
| 75S-T Alclad | Lap joint, coin dimpled (fig. 24(a)) | 2,600 | 20,900 | 19,000 |
| | | 1,600 | 116,000 | 200,000 |

¹Evaluated from curves in figs. 27, 35, and 41.



**TABLE 16.- STATIC STRENGTH OF ALUMINUM-ALLOY SHEET SPECIMENS
 AFTER FATIGUE TESTING**

| Type of specimen | Condition and extent of fatigue loading | | | | Ultimate measured static properties (psi) | Change from original ultimate strength (percent) (b) |
|---------------------------|---|-------------------|------------------|------------------------------|---|--|
| | Max. stress (psi) | Load ratio, R (a) | Number of cycles | Estimated lifetime (percent) | | |
| 24S-T Alclad, unnotched | 16,000 | -0.50 | 9,418,000 | 10 | 66,000 | -5 |
| | 25,000 | .25 | 10,055,700 | 30 | 65,000 | -6 |
| | 53,500 | .50 | 90,000 | 40 | | |
| | 44,700 | .60 | 13,602,000 | 300 | 65,000 | -6 |
| 24S-T Alclad, with hole | 17,000 | .40 | 17,874,800 | (c) | 60,600 | -2 |
| 24S-T bare, unnotched | 48,000 | .25 | 13,614,500 | (c) | 74,500 | 1 |
| | 25,000 | -.50 | 24,976,600 | (c) | 70,260 | -5 |
| | 35,000 | .02 | 9,090,600 | (c) | 73,680 | 0 |
| | 37,000 | .02 | 12,955,000 | (c) | 72,860 | -1 |
| | 55,000 | .50 | 15,598,200 | (c) | 73,870 | 0 |
| 24S-T bare, with hole | 20,000 | .25 | 9,181,500 | (a) | 66,300 | -2 |
| | 33,000 | .50 | 20,747,100 | (c) | 68,500 | 2 |
| | 38,000 | .60 | 11,296,500 | (c) | 67,100 | 0 |
| | 27,000 | .40 | 20,962,400 | (c) | 66,100 | -2 |
| 75S-T Alclad, unnotched | 70,000 | .75 | 10,441,200 | (c) | 81,500 | 0 |
| | 48,000 | .50 | 20,339,000 | (c) | 81,500 | 0 |
| | 60,000 | .75 | 20,295,200 | (c) | 82,300 | 3 |
| | 38,000 | .40 | 12,767,800 | (c) | 81,900 | 1 |
| | 23,000 | .40 | 13,140,300 | (c) | 82,100 | 0 |
| 24S-T Alclad, with hole | 17,000 | .25 | 10,398,300 | (c) | 78,500 | 0 |
| R303-T275 clad, unnotched | 40,000 | .60 | 12,268,000 | 1 | 74,600 | -1 |
| | 25,000 | .40 | 10,728,100 | 0 | 75,600 | 0 |
| | 26,000 | .25 | 17,757,500 | 0 | 75,300 | 0 |
| | 32,000 | .40 | 12,861,500 | ^d 6 | 75,300 | 0 |
| R303-T275 clad, with hole | 32,000 | .60 | 12,641,800 | 0 | 73,500 | 0 |
| R303-T275 bare, unnotched | 50,000 | .40 | 12,780,400 | 0 | 82,600 | 0 |
| | 60,000 | .60 | 18,968,100 | 0 | 82,300 | 0 |
| R303-T275 bare, with hole | 29,000 | .60 | 11,641,500 | 0 | 81,100 | -2 |

^aPositive values indicate tension; negative values, compression.

^bNegative values indicate a decrease in strength; positive values, an apparent increase.

^cLifetime so far beyond the range of testing, it is indefinite.

^dQuestionable value.



**TABLE 17.- RESULTS OF FATIGUE-DAMAGE TESTS AT TWO
 LOAD LEVELS**

| Specimen | Loading conditions | | Number of cycles run, n | Lifetime, N (1) | Lifetime, 100 n/N (percent) | Total lifetime to failure (percent) |
|--|--------------------|--------------------|-------------------------------|-----------------------|-----------------------------------|--|
| | Max. load (psi) | Mean load (psi) | | | | |
| 24S-T Alclad sheet speci- mens: | | | | | | |
| 3-2 | 57,000 61,000 | 45,000 45,000 | 40,000 110,700 | 280,000 105,000 | 14 101 | 115 |
| 3-4 | 62,000 57,000 | 40,000 40,000 | 15,000 103,000 | 42,000 105,000 | 36 98 | 134 |
| 3-5 | 52,500 57,000 | 40,000 40,000 | 120,000 90,600 | 260,000 105,000 | 46 86 | 132 |
| 3-6 | 53,000 62,000 | 40,000 40,000 | 100,000 34,300 | 240,000 42,000 | 42 82 | 124 |
| 3-7 | 48,600 57,000 | 40,000 40,000 | 1,705,500 (2) | 1,800,000 ----- | 95 | 95 |
| Simple riveted lap joints in 24S-T Alclad: | (1b) | (1b) | | | | |
| 12-49 | 2,760 1,840 | 975 975 | 3,000 72,900 | 9,000 85,000 | 33 86 | 119 |
| 12-51 | 2,760 1,840 | 975 975 | 7,500 37,400 | 9,000 85,000 | 83 44 | 127 |
| 12-53 | 1,840 2,760 | 975 975 | 44,000 3,000 | 85,000 9,000 | 52 33 | 85 |
| 12-55 | 1,840 2,760 | 975 975 | 60,000 100 | 85,000 9,000 | 71 1 | 71 |
| Simple riveted lap joints in 75S-T Alclad: | (1b) | (1b) | | | | |
| 13-48 | 2,985 1,990 | 1,055 1,055 | 1,320 17,000 | 6,500 33,000 | 20 52 | 72 |
| 13-49 | 1,990 2,985 | 1,055 1,055 | 14,400 1,100 | 33,000 6,500 | 43 17 | 50 |
| 13-50 | 1,990 2,985 | 1,055 1,055 | 18,300 1,050 | 33,000 6,500 | 56 16 | 72 |

¹See figs. 49, 51, and 52 for constant-mean-load curves for determination of N.
²Failed while loading.

**TABLE 18.- DAMAGE TO SINGLE-ROW FLUSH-RIVETED LAP JOINTS
 OF 24S-T ALCLAD BY FATIGUE AT VARIOUS LOAD LEVELS**

[All tests run at a constant mean load of 975 lb,
 21.2 percent of the static ultimate.]

| Specimen | Maximum load | | Number of cycles | Endurance lifetime (percent) (a) | Result |
|----------|--------------|--------------------|------------------|----------------------------------|---|
| | (lb) | (percent ultimate) | | | |
| 12-46 | 2,700 | 58.8 | 19 | <0.1 | No failure; static test showed no loss in static strength |
| | 2,400 | 52.0 | 192 | 1 | |
| | 2,080 | 45.2 | 1,920 | 6 | |
| | 1,770 | 38.4 | 19,200 | 28 | |
| | 1,450 | 31.8 | 207,500 | 52 | |
| | 1,130 | 24.6 | 1,670,000 | 8 b ₈₈ | |
| 12-45 | (c) | (c) | (c) | (c) b ₈₈ | End rivet cracked |
| 12-57 | (c) | (c) | (c) | (c) b ₈₈ | No failure; no decrease in static strength |
| 12-61 | 2,700 | 58.8 | 23 | <0.1 | Rivets cracked; static strength lowered about 8 percent |
| | 2,400 | 52.0 | 230 | 1 | |
| | 2,080 | 45.2 | 2,300 | 7 | |
| | 1,770 | 38.4 | 23,000 | 26 | |
| | 1,450 | 31.5 | 249,000 | 62 | |
| | 1,130 | 24.6 | 2,004,000 | 10 b ₁₀₆ | |
| 12-69 | 1,130 | 24.6 | 3,340,000 | 16 | Failed in fatigue on second run |
| | 1,450 | 31.5 | 374,500 | 92 b ₁₀₈ | |
| 12-65 | 2,700 | 58.8 | 29 | <0.1 | Failed in fatigue on last run |
| | 2,400 | 52.0 | 288 | 2 | |
| | 2,080 | 45.2 | 2,880 | 9 | |
| | 1,770 | 38.4 | 28,800 | 32 | |
| | 1,450 | 31.5 | 311,300 | 78 | |
| | 1,130 | 24.6 | 2,505,000 | 13 b ₁₃₄ | |
| 12-68 | 2,700 | 58.8 | 38 | <0.1 | Failed in fatigue on last run |
| | 2,400 | 52.0 | 384 | 2 | |
| | 2,080 | 45.2 | 3,840 | 12 | |
| | 1,770 | 38.4 | 38,400 | 43 | |
| | 1,450 | 31.5 | 415,000 | 104 b ₁₆₁ | |

^aSee fig. 51 for constant-mean-load base curve.

^bTotal.

^cSame conditions as for 12-46, but loads run in reverse order.



TABLE 19.- DAMAGE TO TWO-ROW FLUSH-RIVETED LAP JOINTS OF 24S-T ALCLAD BY FATIGUE AT VARIOUS LOAD LEVELS

[All tests run at a constant mean load of 1840 lb, 21.2 percent of the static ultimate.]

| Specimen | Maximum load | | Number of cycles | Endurance lifetime (percent) (a) |
|----------|--------------|--------------------|------------------|----------------------------------|
| | (lb) | (percent ultimate) | | |
| 31-26 | 5,104 | 58.8 | 19 | < 0.1 |
| | 4,514 | 52.0 | 185 | 1.4 |
| | 3,923 | 45.2 | 1,850 | 6.6 |
| | 3,333 | 38.4 | 18,500 | 24.7 |
| | 2,734 | 31.5 | 143,800 | 48.0 |
| | | | | b81 |
| 31-30 | (c) | (c) | (c) | (c) |
| | | | | b82 |
| 31-20A | (a) | (a) | (a) | (a) |
| | | | | b103 |
| 31-27 | 2,734 | 31.5 | 199,800 | 66.6 |
| | 3,333 | 38.4 | 6,000 | 8.6 |
| | | | | b75 |
| 31-28 | 2,734 | 31.5 | 199,800 | 66.6 |
| | 3,333 | 38.4 | 6,500 | 9.6 |
| | | | | b76 |

^aSee fig. 53 for constant-mean-load base curve.
^bTotal.

^cSame conditions as for 31-26. Results: At last load (2734 lb) ran 146,600 cycles or 49.0 percent of endurance lifetime.

^dSame conditions as for 31-26. Result: At last load (2734 lb) ran 210,000 cycles or 70.0 percent of endurance lifetime.



TABLE 20.- DAMAGE TO RIVETED LAP JOINTS OF 75S-T ALCLAD BY FATIGUE AT VARIOUS LOAD LEVELS

[All tests run at constant mean load of 1,055 lb, 21.2 percent of static ultimate.]

| Specimen | Maximum load | | Number of cycles | Endurance lifetime (percent) (a) | Result |
|----------|--------------|--------------------|------------------|----------------------------------|--|
| | (lb) | (percent ultimate) | | | |
| 13-35 | 2,920 | 58.8 | 6 | < 0.1 | Did not fail; not yet tested statically |
| | 2,587 | 52.0 | 62 | 1 | |
| | 2,248 | 45.2 | 620 | 3 | |
| | 1,910 | 38.4 | 6,200 | 16 | |
| | 1,567 | 31.5 | 67,000 | 67 | |
| | 1,222 | 24.6 | 540,000 | 5 | |
| | | | | b92 | |
| 13-37 | (c) | (c) | (c) | (c) | Did not fail; no decrease in static strength |
| | | | | b92 | |
| 13-39 | 2,920 | 58.8 | 12 | < 0.2 | Failed in fatigue on last run |
| | 2,587 | 52.0 | 124 | 1 | |
| | 2,248 | 45.2 | 1,240 | 7 | |
| | 1,910 | 38.4 | 12,400 | 31 | |
| | 1,567 | 31.5 | 79,100 | 79 | |
| | | | | b118 | |
| 13-43 | 1,222 | 24.6 | 1,080,000 | 11 | Cracked through rivets on second run; did not separate; static strength lowered 35 percent |
| | 1,567 | 31.5 | 134,000 | 134 | |
| | 1,910 | 38.4 | 12,400 | 31 | |
| | 2,248 | 45.2 | 1,240 | 7 | |
| | 2,587 | 52.0 | 124 | 1 | |
| | 2,920 | 58.8 | 12 | < 0.2 | |
| | | | | | |

^aSee fig. 52 for constant-mean-load base curve.
^bTotal.

^cSame as for 13-35, but loads run in reverse order.



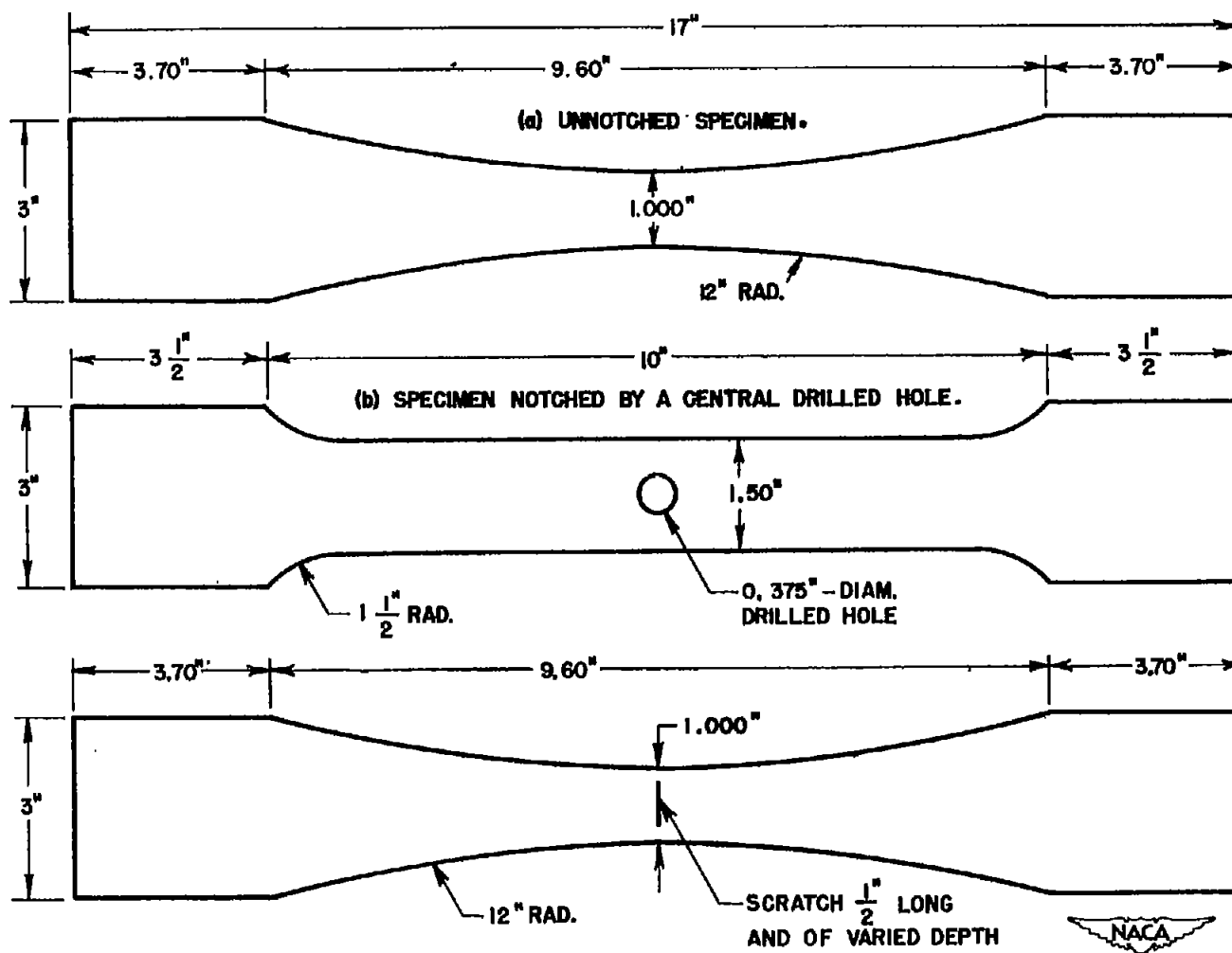

(c) SPECIMEN WITH SCRATCH IN CENTER SECTION.
Figure 1.- Sheet specimens used in fatigue tests.

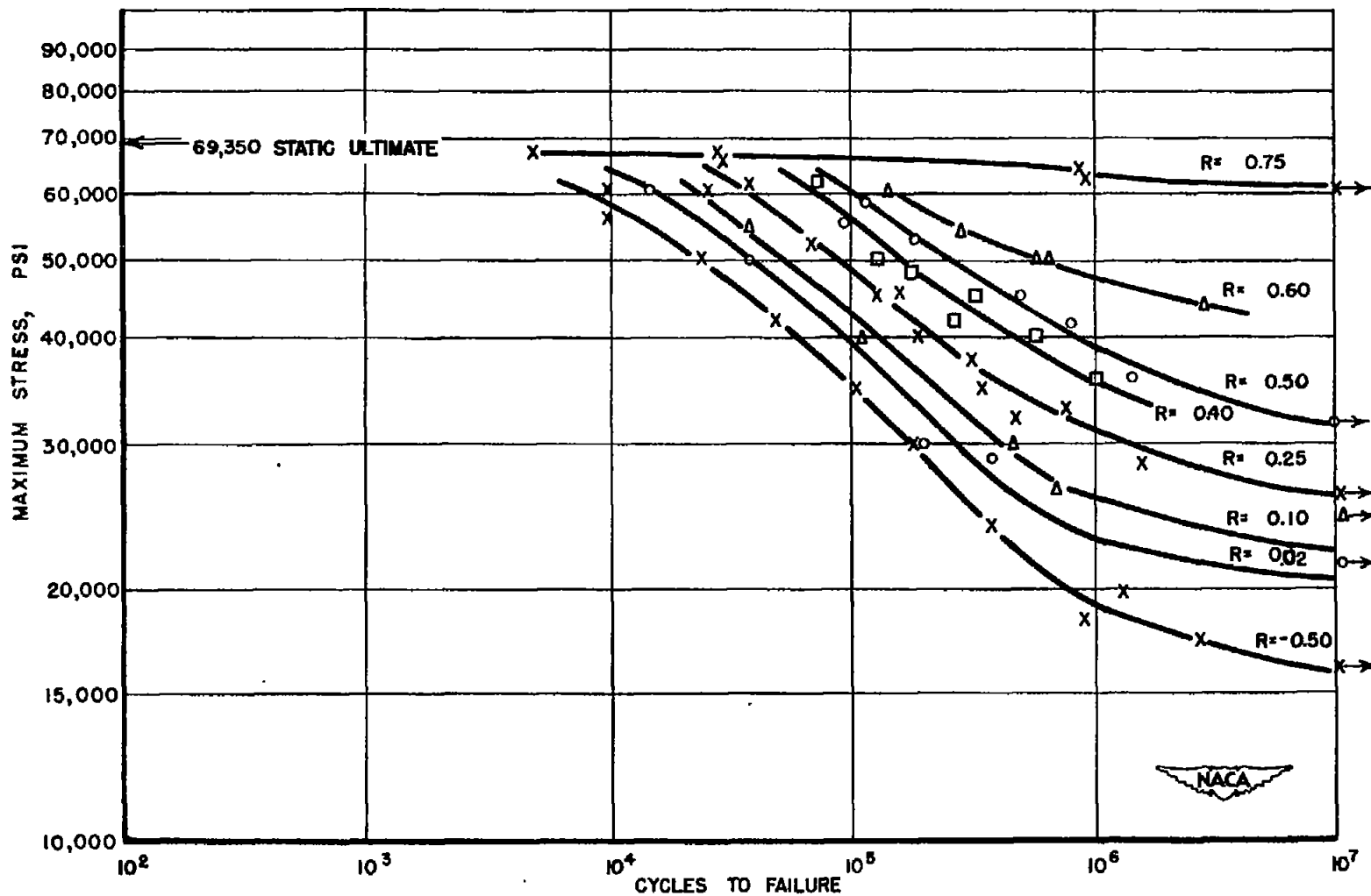

Figure 2.- Direct-stress fatigue strength of 0.040-inch 24S-T Alclad sheet. Test section 1.0 inch wide. Specimens cut in the direction of rolling. (R = min. load/max. load. Positive values indicate tension; negative values, compression.)

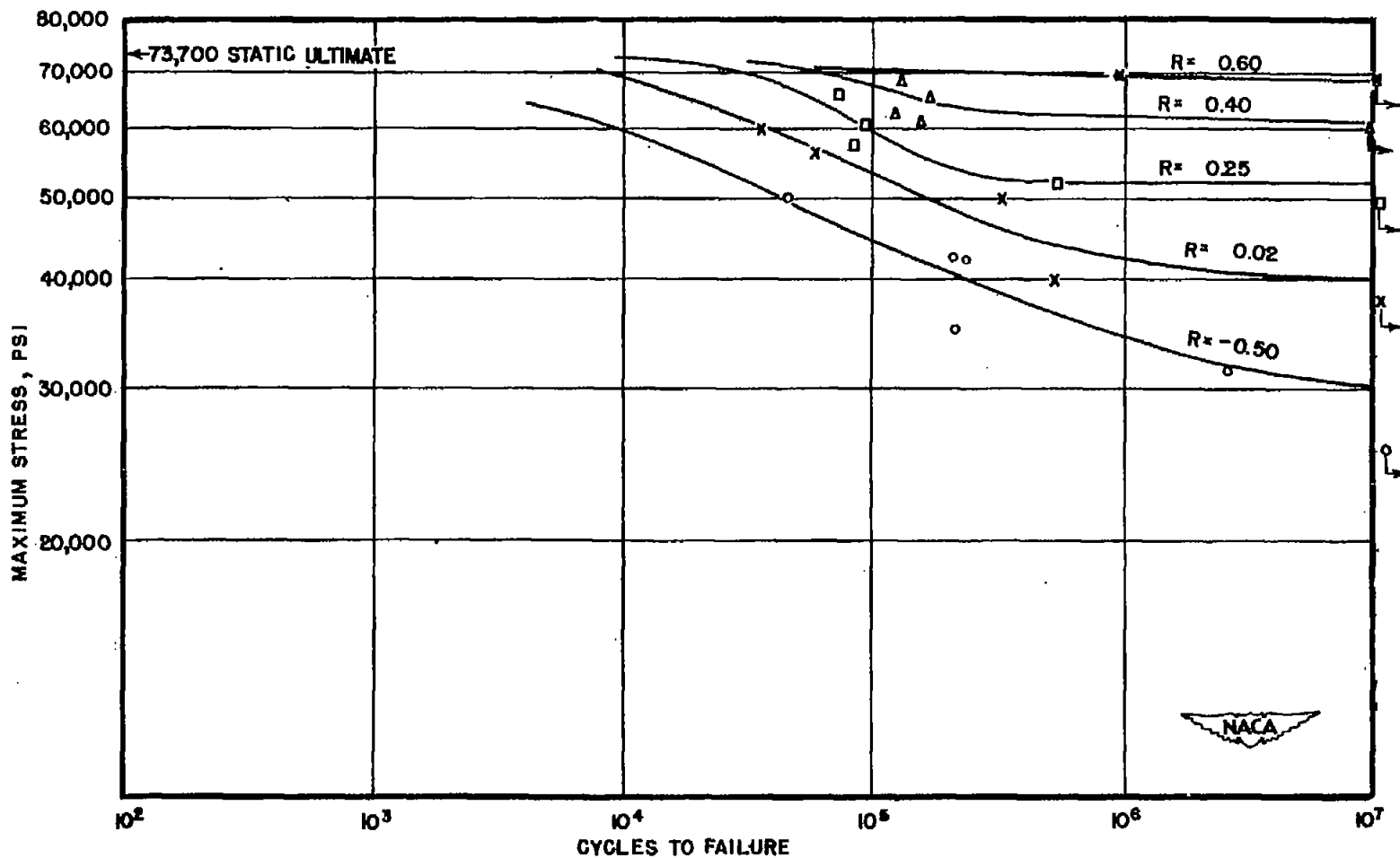

Figure 3.- Direct-stress fatigue strength of 0.040-inch 245-T bare sheet. Test section 1.0 inch wide. Specimens cut in the direction of rolling. (R = min. load/max. load. Positive values indicate tension; negative values, compression.)

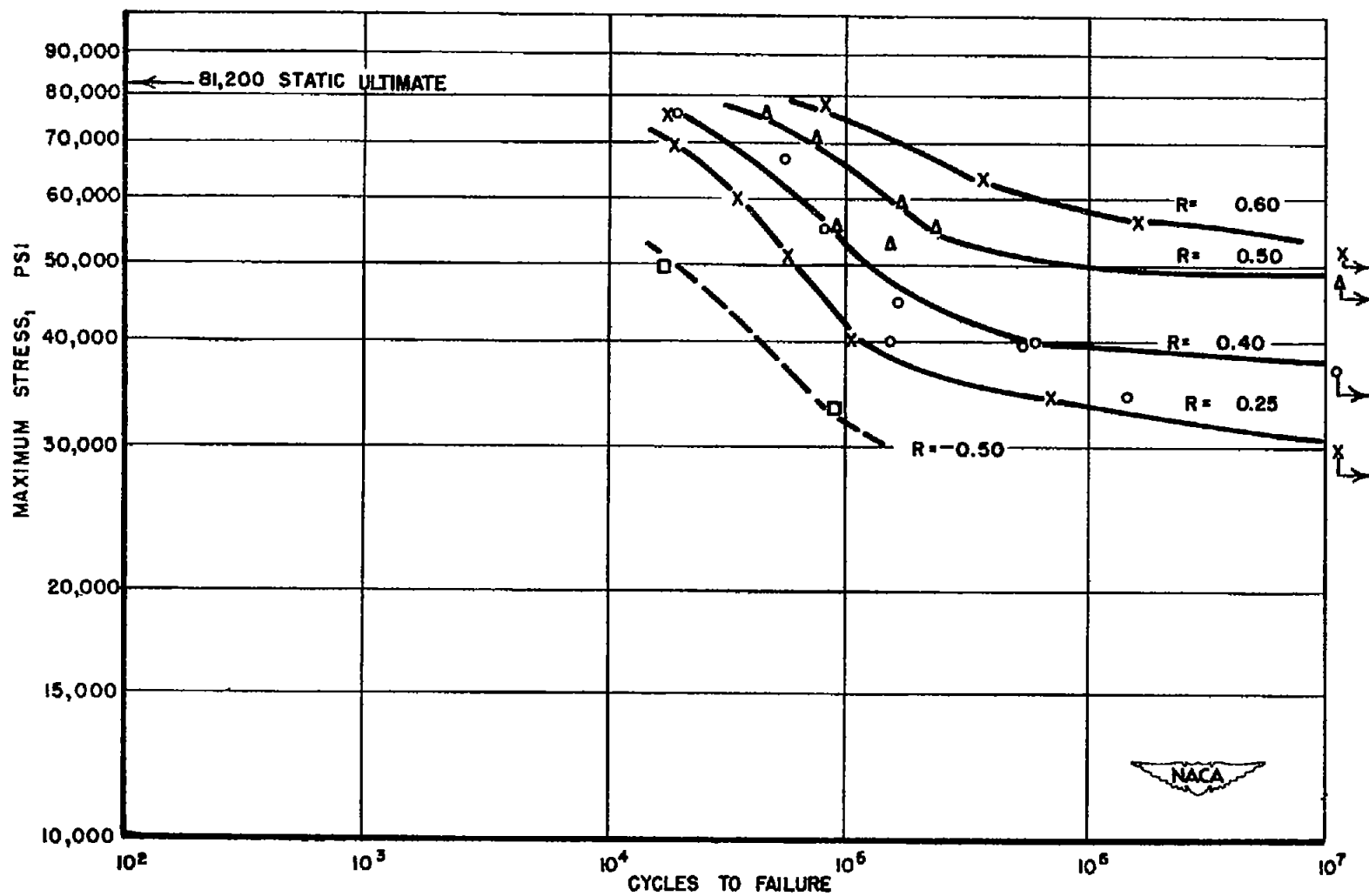

Figure 4.- Direct-stress fatigue strength of 0.040-inch 75S-T Alclad sheet. Test section 1.0 inch wide. Specimens cut in the direction of rolling. (R = min. load/max. load. Positive values indicate tension; negative values, compression.)

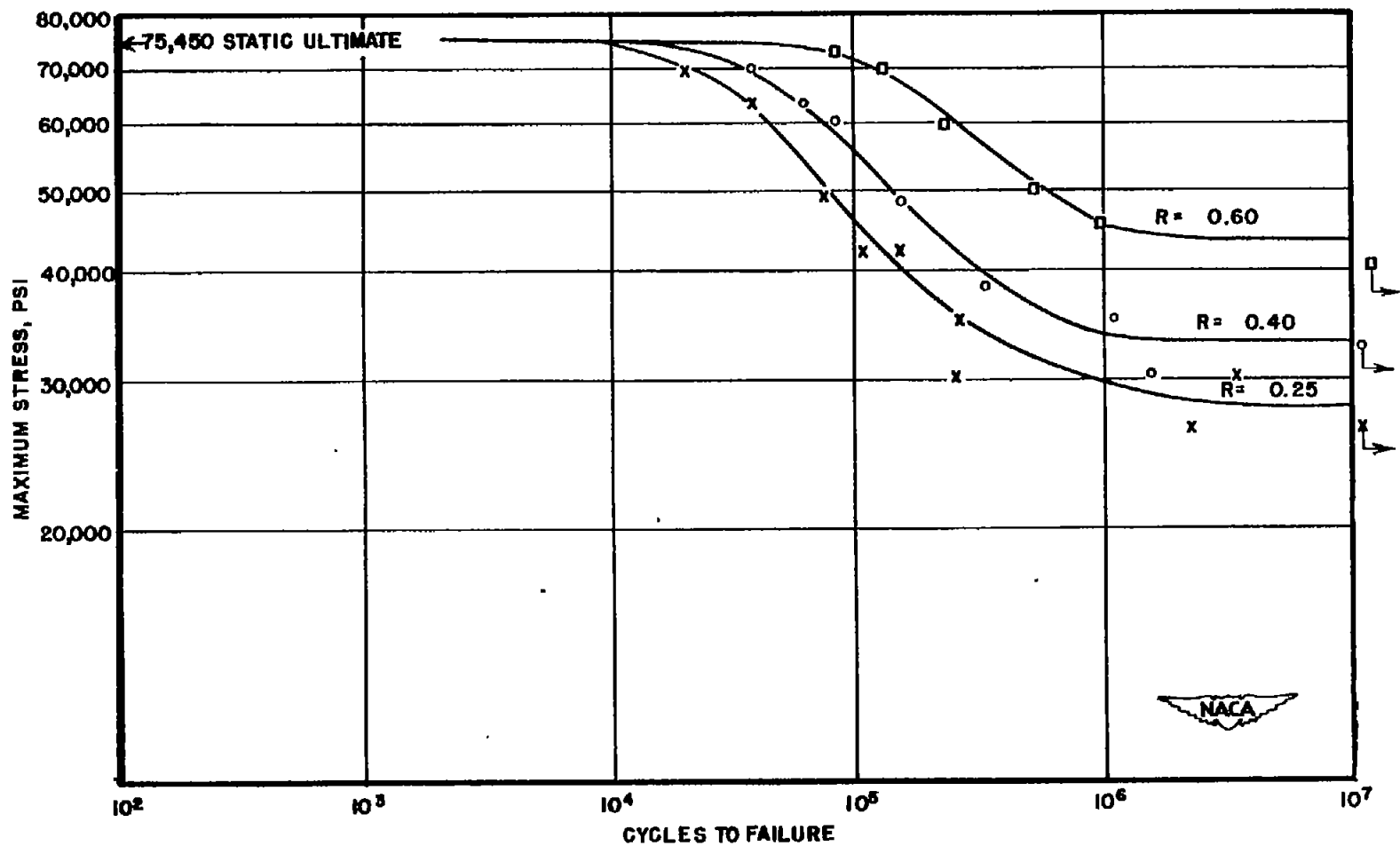

Figure 5.- Direct-stress fatigue strength of 0.040-inch R303-T275 clad sheet. Test section 1.0 inch wide. Specimens cut in the direction of rolling. (R = min. load/max. load. Positive values indicate tension.)

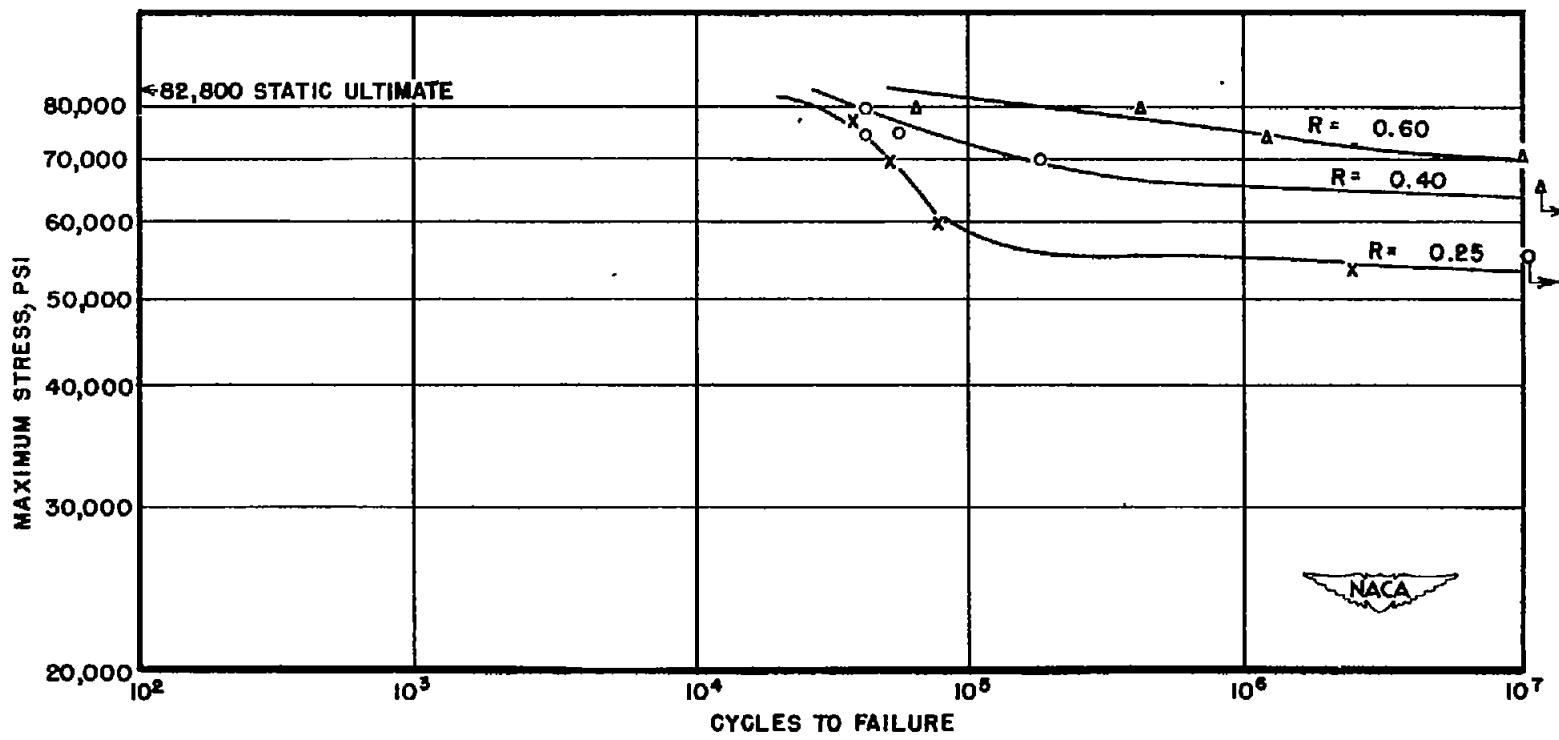

Figure 6.- Direct-stress fatigue strength of 0.040-inch R303-T275 bare sheet. Test section 1.0 inch wide. Specimens cut in the direction of rolling. (R = min. load/max. load. Positive values indicate tension.)

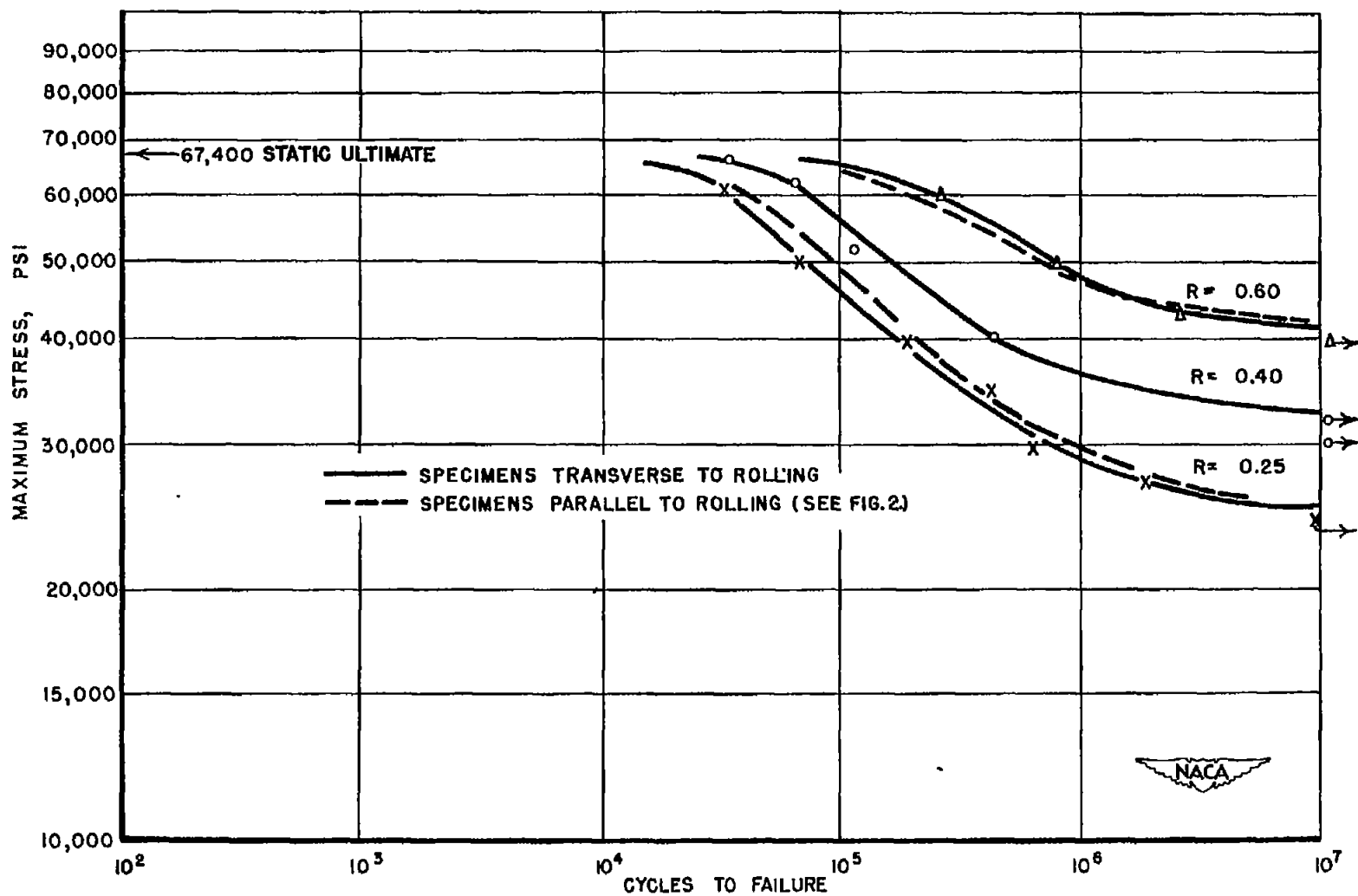

Figure 7.- Direct-stress fatigue strength of 0.040-inch 24S-T Alclad sheet. Test section 1.0 inch wide. Specimens cut transverse to direction of rolling. (R = min. load/max. load. Positive values indicate tension.)

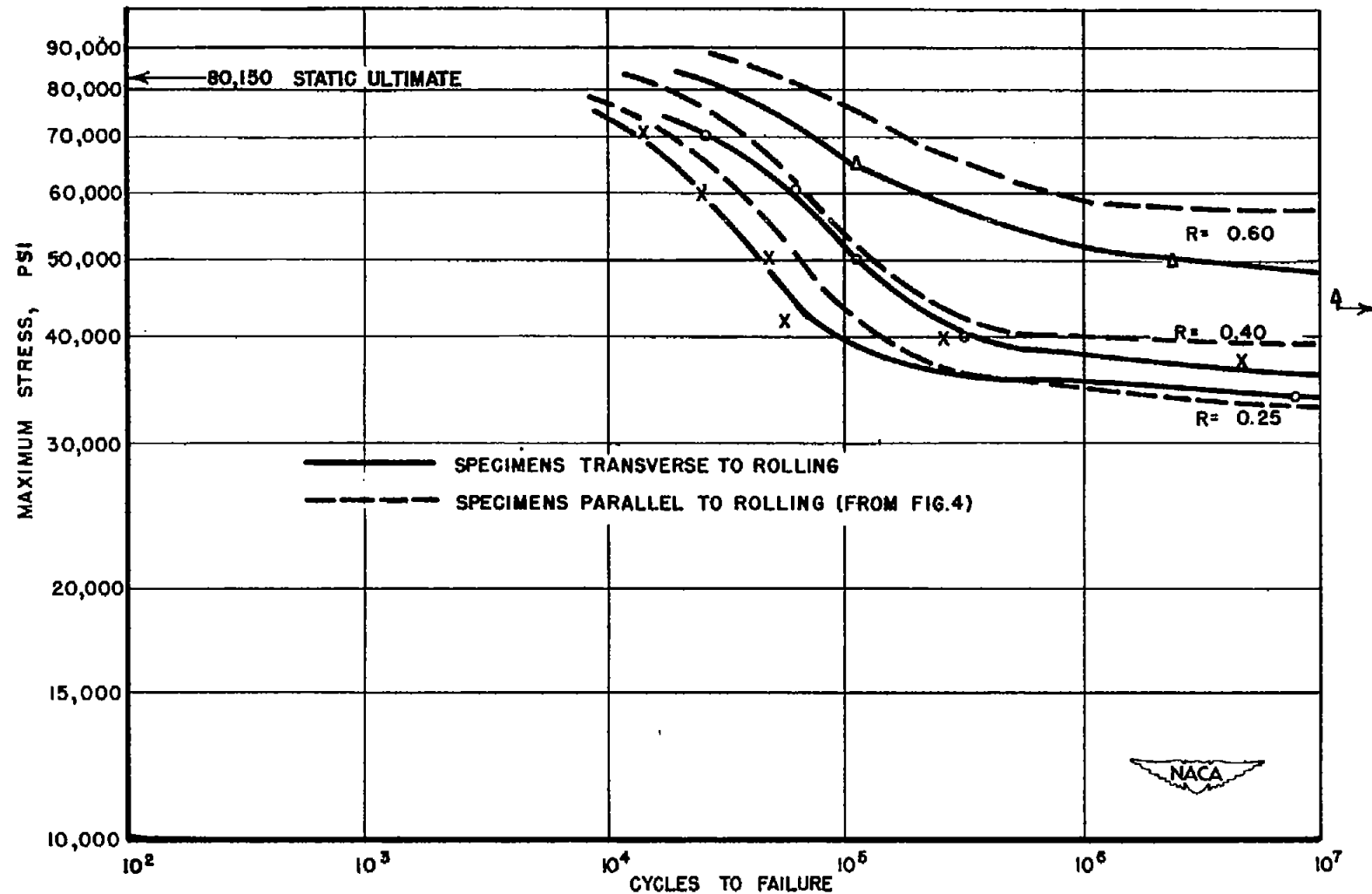

Figure 8.- Direct-stress fatigue strength of 0.040-inch 75S-T Alclad sheet. Test section 1.0 inch wide. Specimens cut transverse to rolling. (R = min. load/max. load. Positive values indicate tension.)

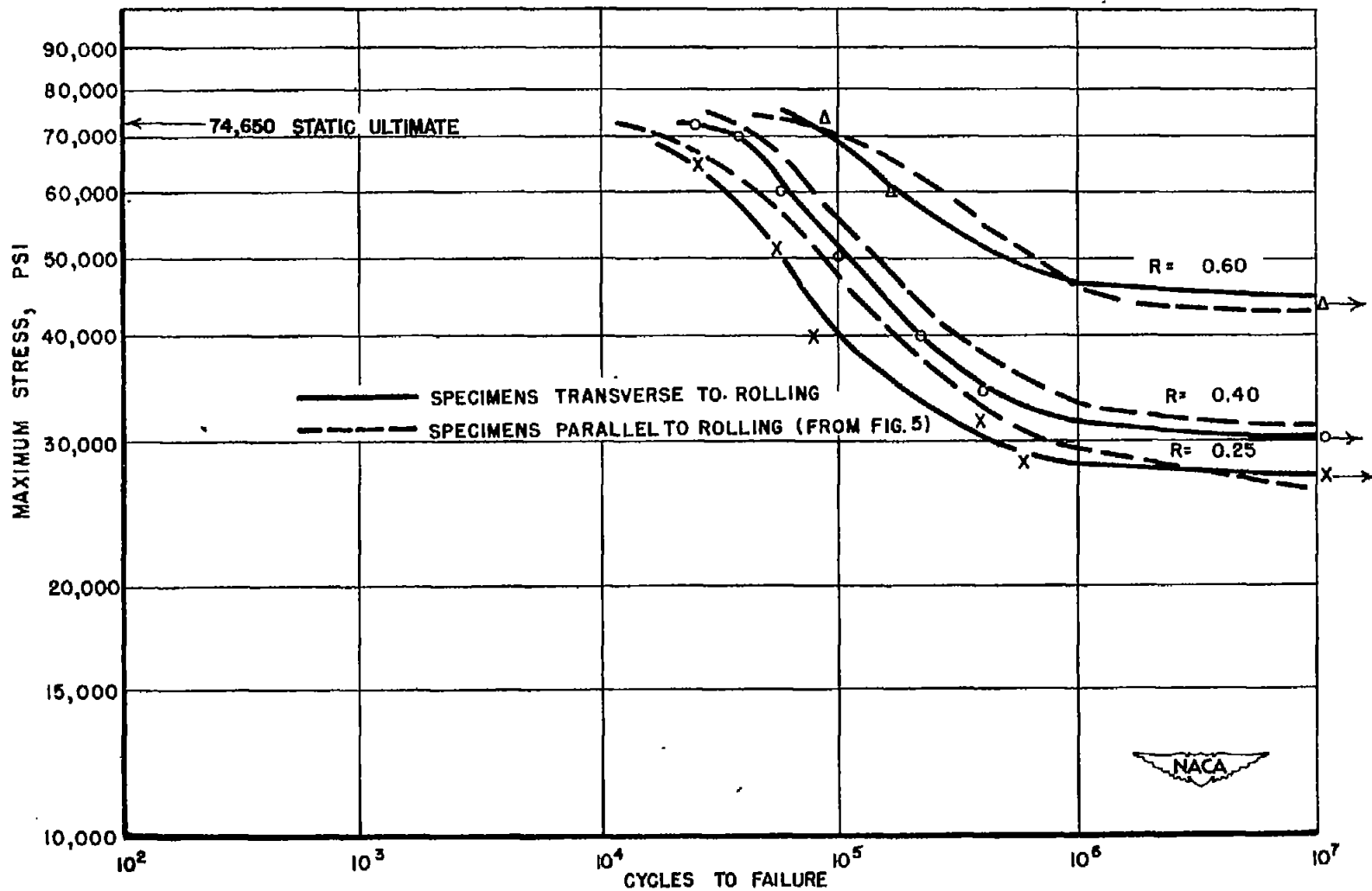

Figure 9.- Direct-stress fatigue strength of 0.040-inch R303-T275 clad sheet. Test section 1.0 inch wide. Specimens cut transverse to direction of rolling. (R = min. load/max. load. Positive values indicate tension.)

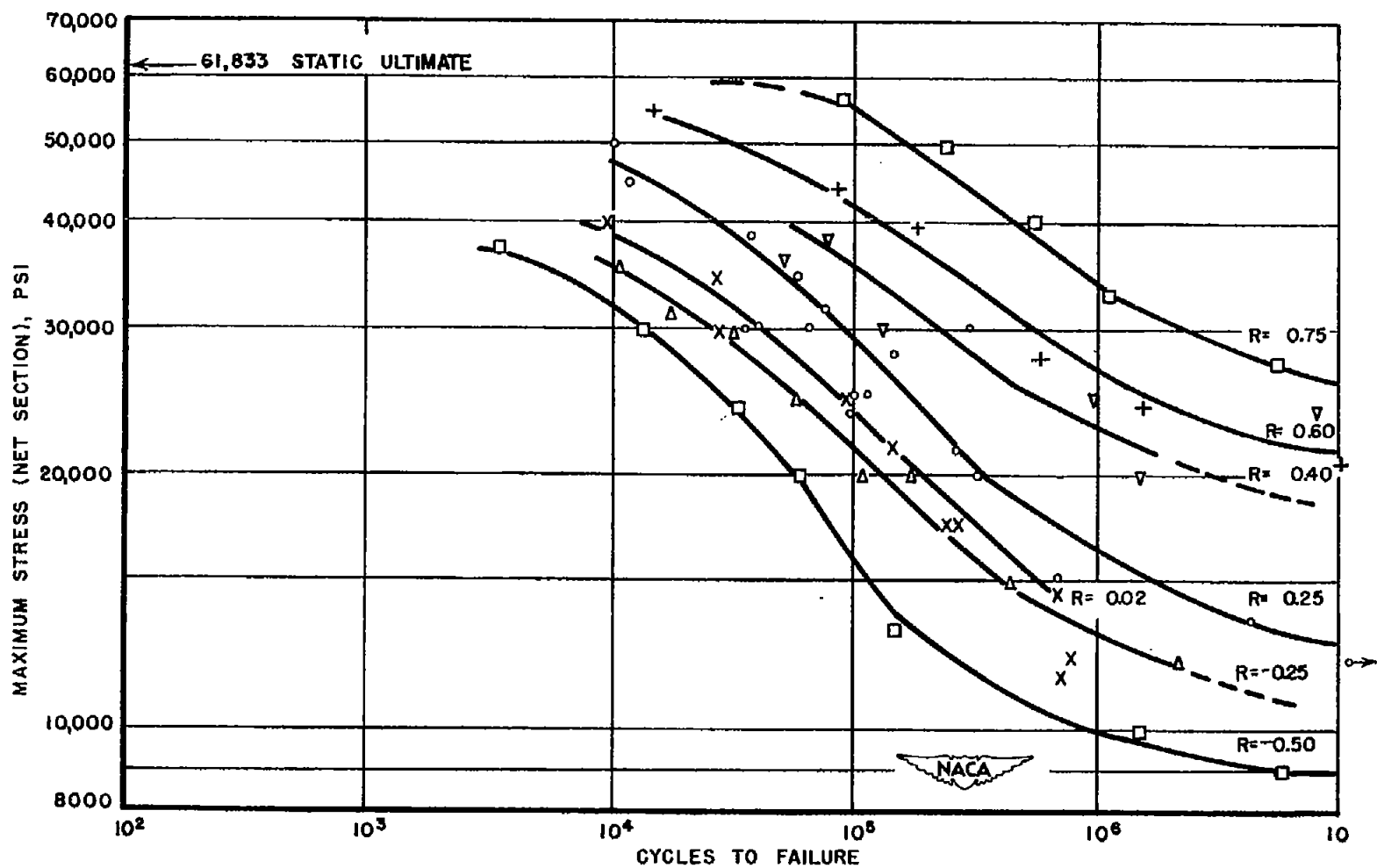

Figure 10.- Direct-stress fatigue strength of 0.040-inch 24S-T Alclad sheet. Test section 1.5 inches wide with 0.375-inch-diameter hole. Specimen cut in the direction of rolling. (R = min. load/max. load. Positive values indicate tension; negative values, compression.)

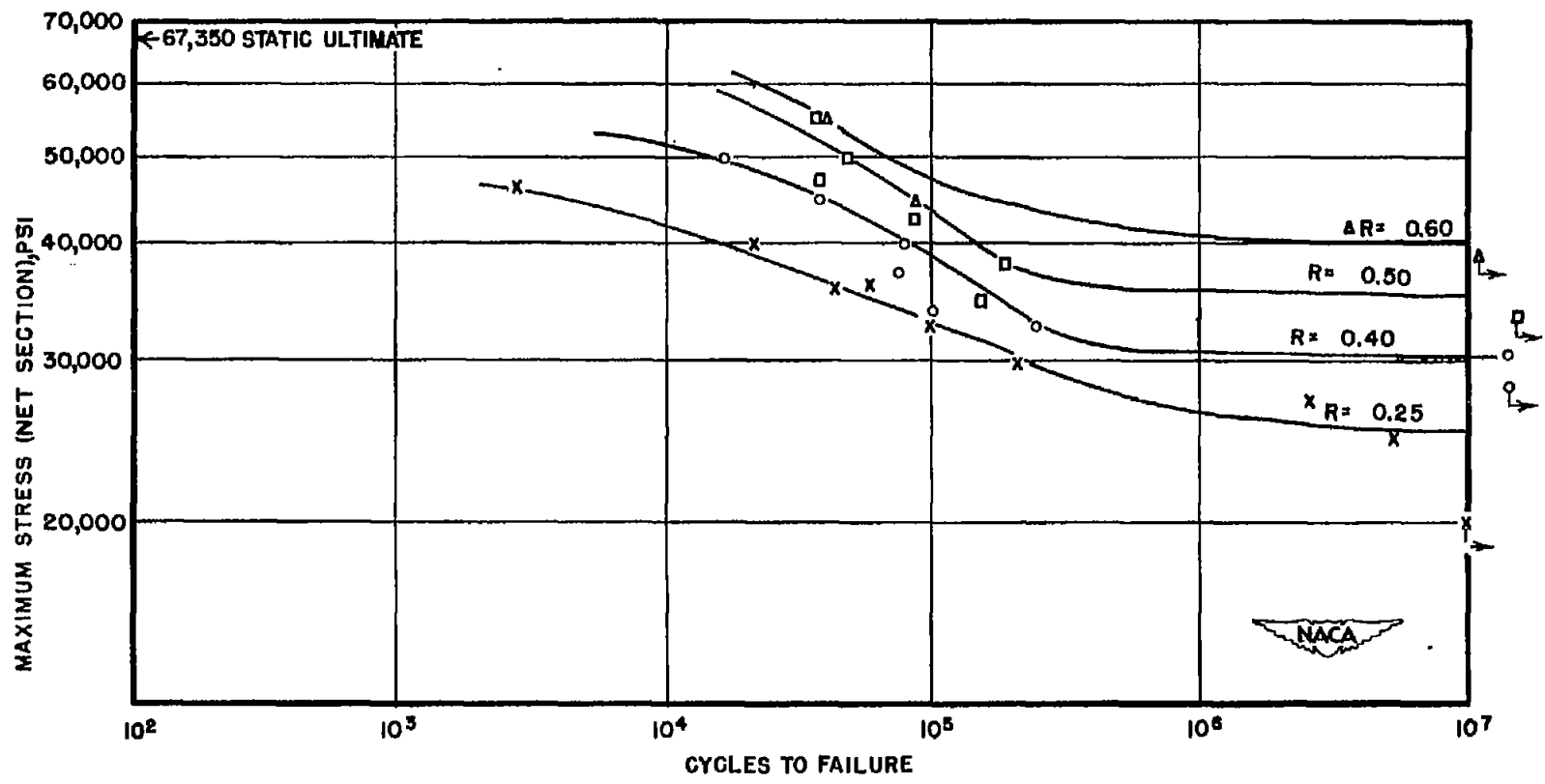

Figure 11.- Direct-stress fatigue strength of 0.040-inch 243-T bare sheet. Test section 1.5 inches wide with 0.375-inch-diameter hole. Specimens cut in the direction of rolling. (R = min. load/max. load. Positive values indicate tension.)

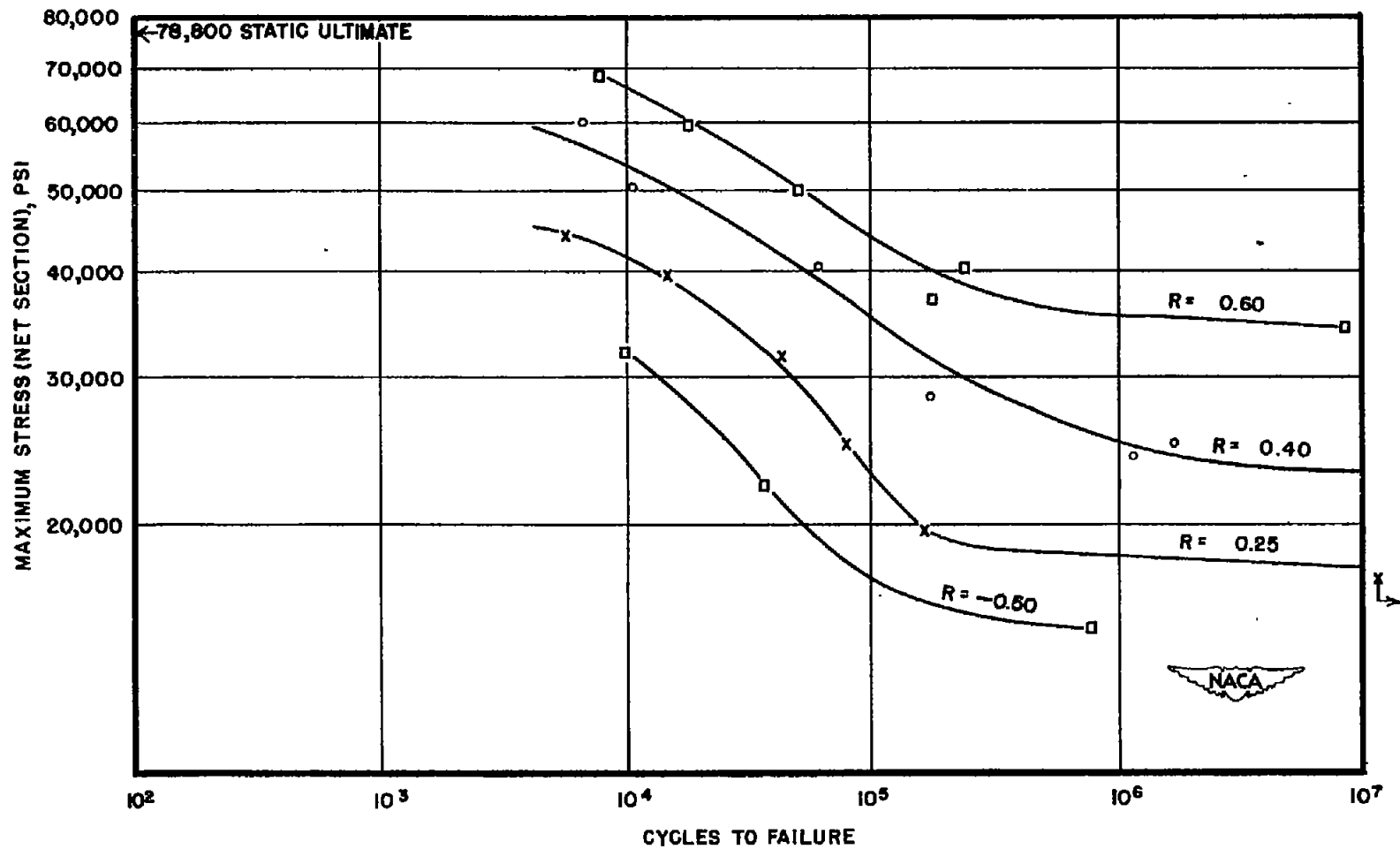

Figure 12.- Direct-stress fatigue strength of 0.040-inch 75S-T Alclad sheet. Test section 1.5 inches wide with 0.375-inch-diameter hole. Specimens cut in the direction of rolling. (R = min. load/max. load. Positive values indicate tension; negative values, compression.)

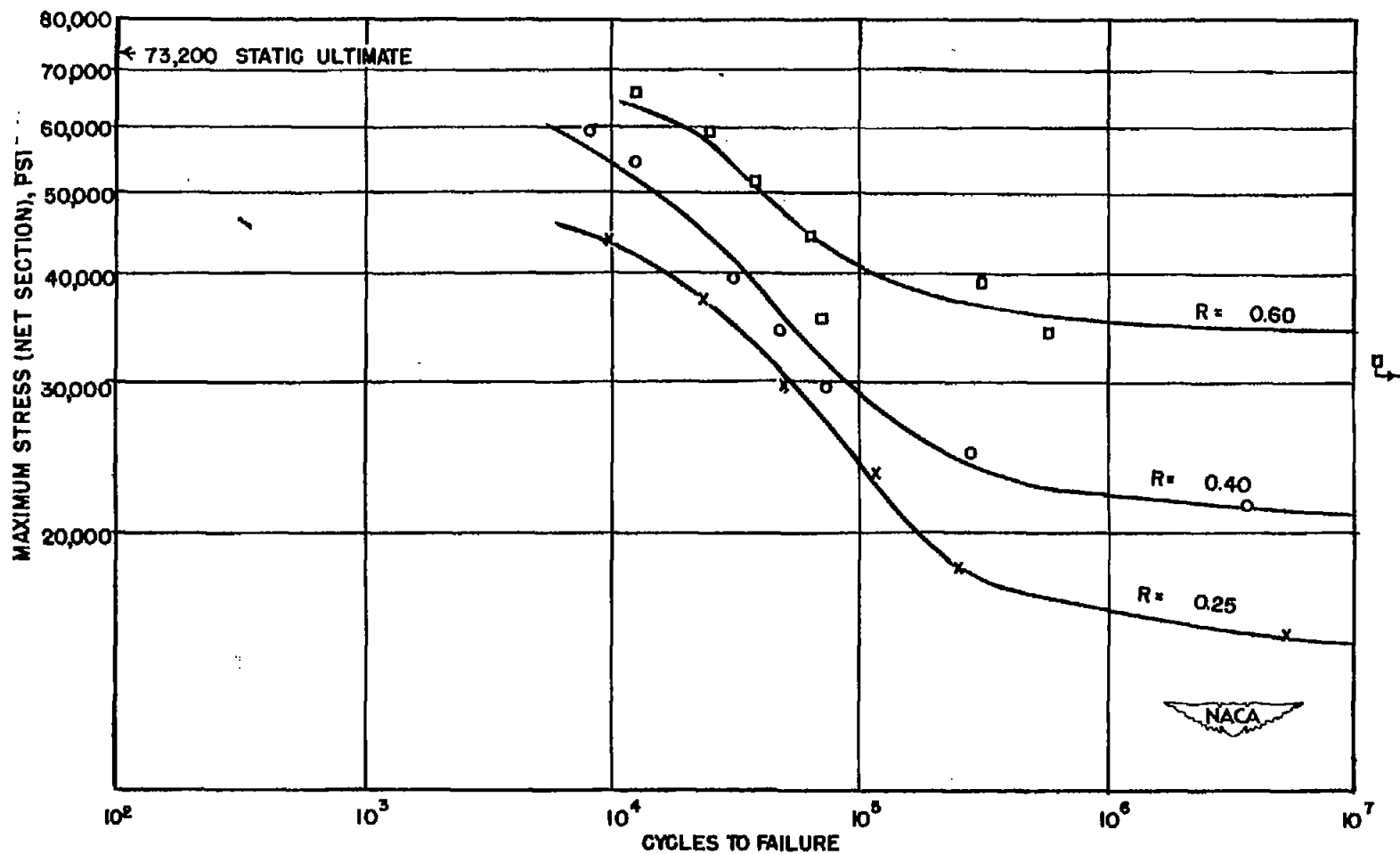

Figure 13.- Direct-stress fatigue strength of 0.040-inch R303-T275 clad sheet. Test section 1.5 inches wide with 0.375-inch-diameter hole. Specimens cut in the direction of rolling. (R = min. load/max. load. Positive values indicate tension.)

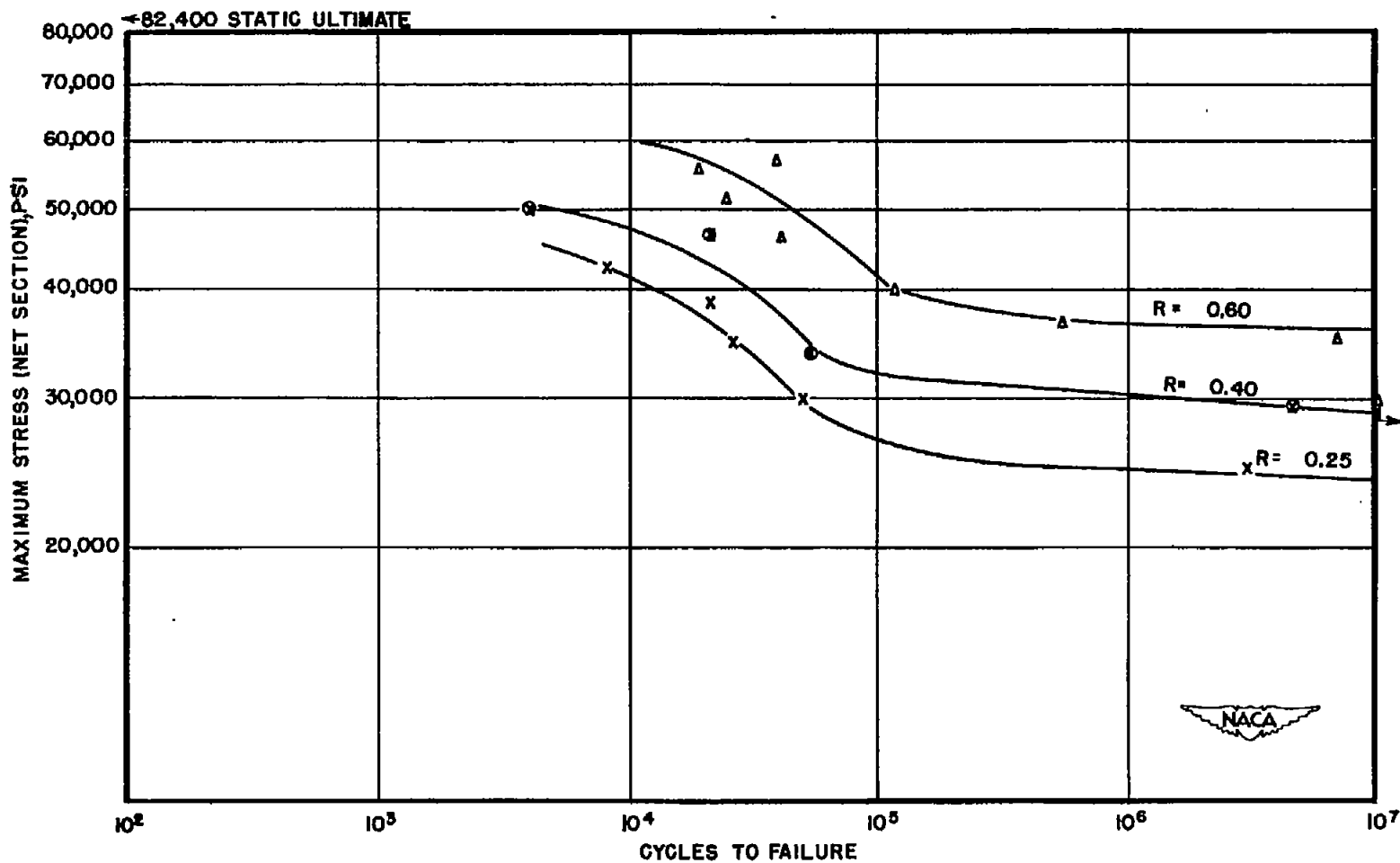

Figure 14.- Direct-stress fatigue strength of 0.040-inch R303-T275 bare sheet. Test section 1.5 inches wide with 0.375-inch-diameter hole. Specimens cut in the direction of rolling. (R = min. load/max. load. Positive values indicate tension.)

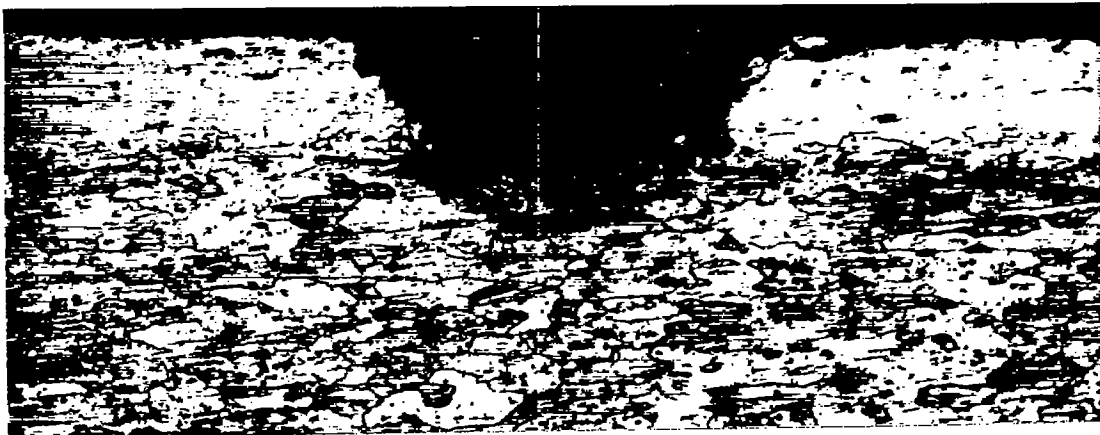
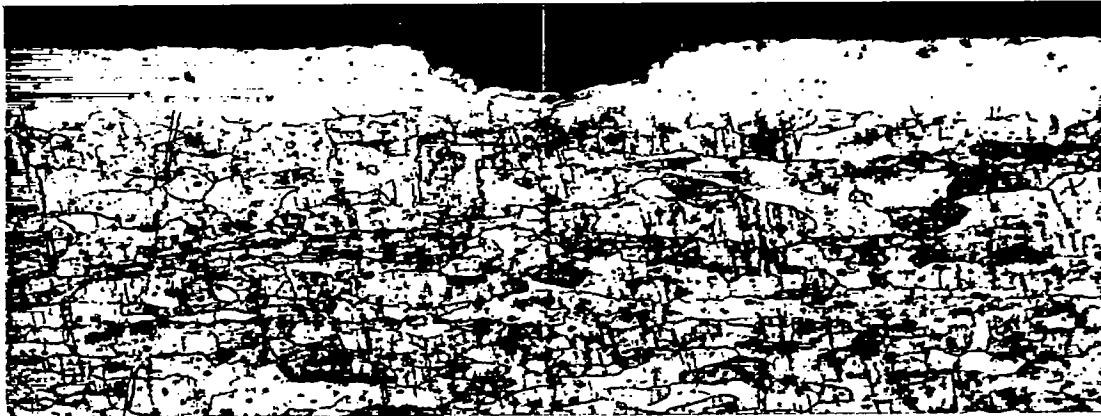

Figure 15.- Typical microsections of scratches in 0.040-inch 24S-T Alclad sheet. (Magnification, 250X.)

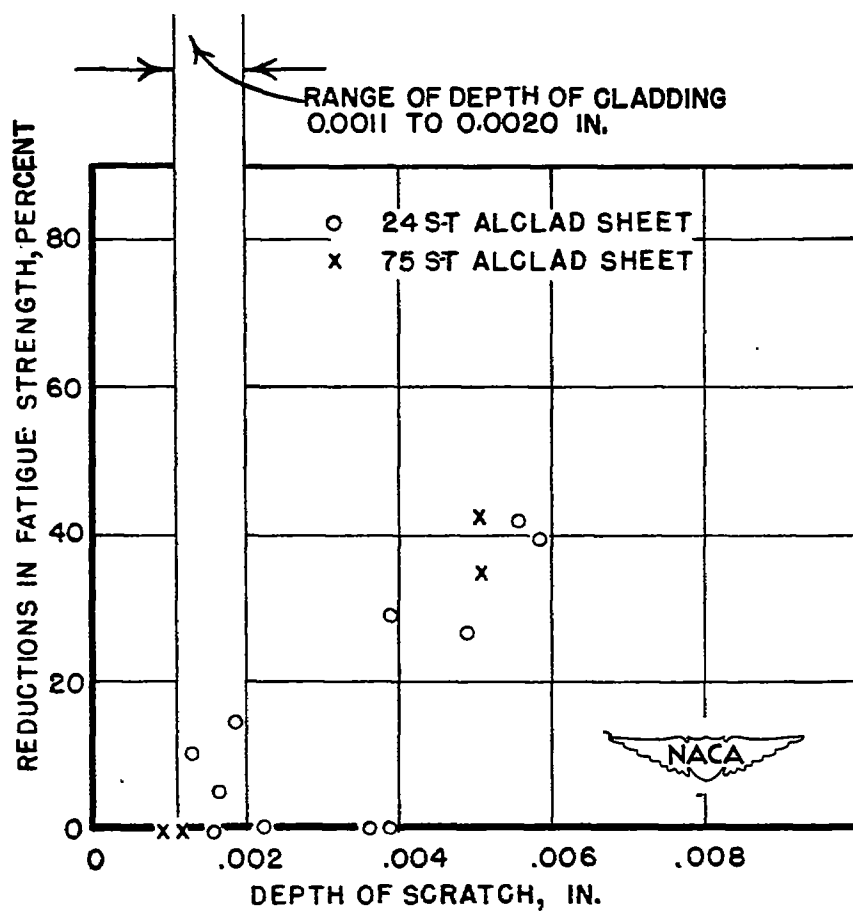

Figure 16.- Effect of scratches of various depths on the fatigue strength of 0.040-inch-thick 24S-T Alclad sheet and 75S-T Alclad sheet.

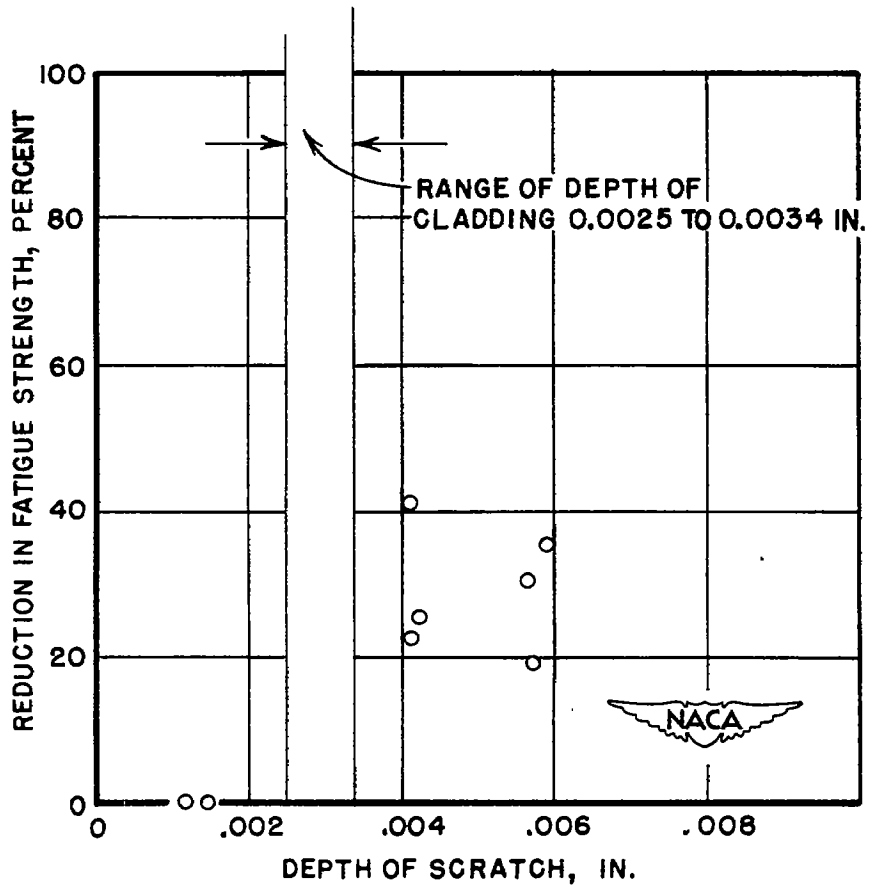

Figure 17.- Effect of scratches of various depths on the fatigue strength of 0.102-inch-thick 24S-T Alclad sheet.

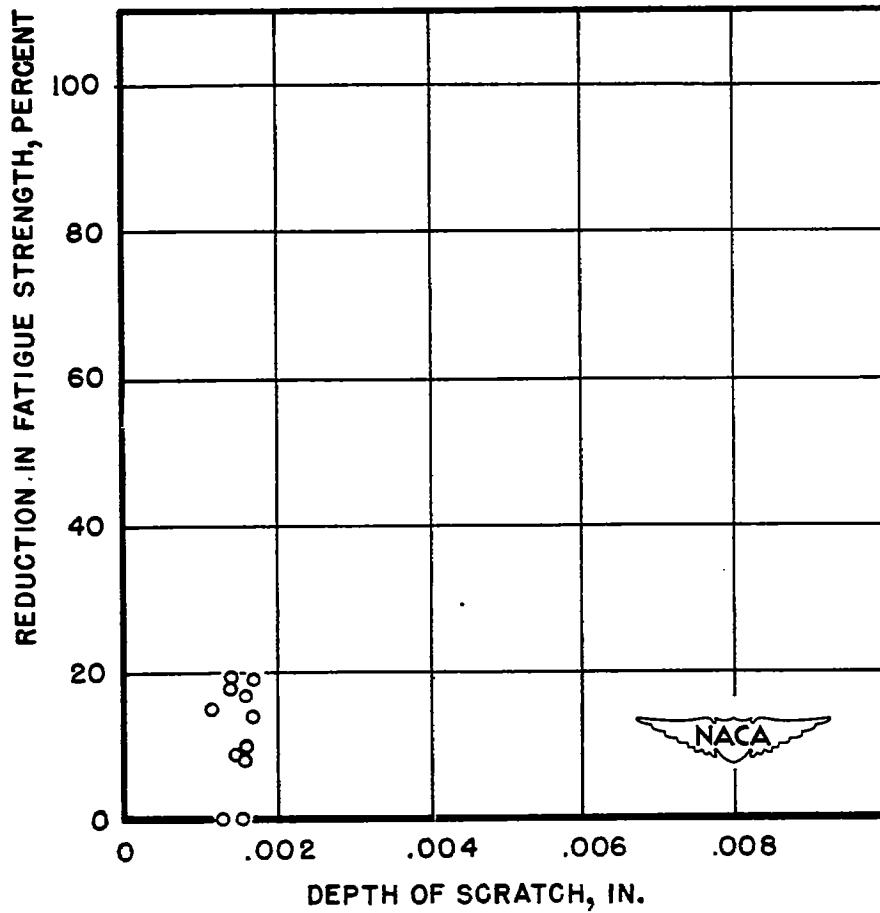

Figure 18.- Effect of scratches of various depths on the fatigue strength of 0.040-inch-thick 24S-T bare sheet.

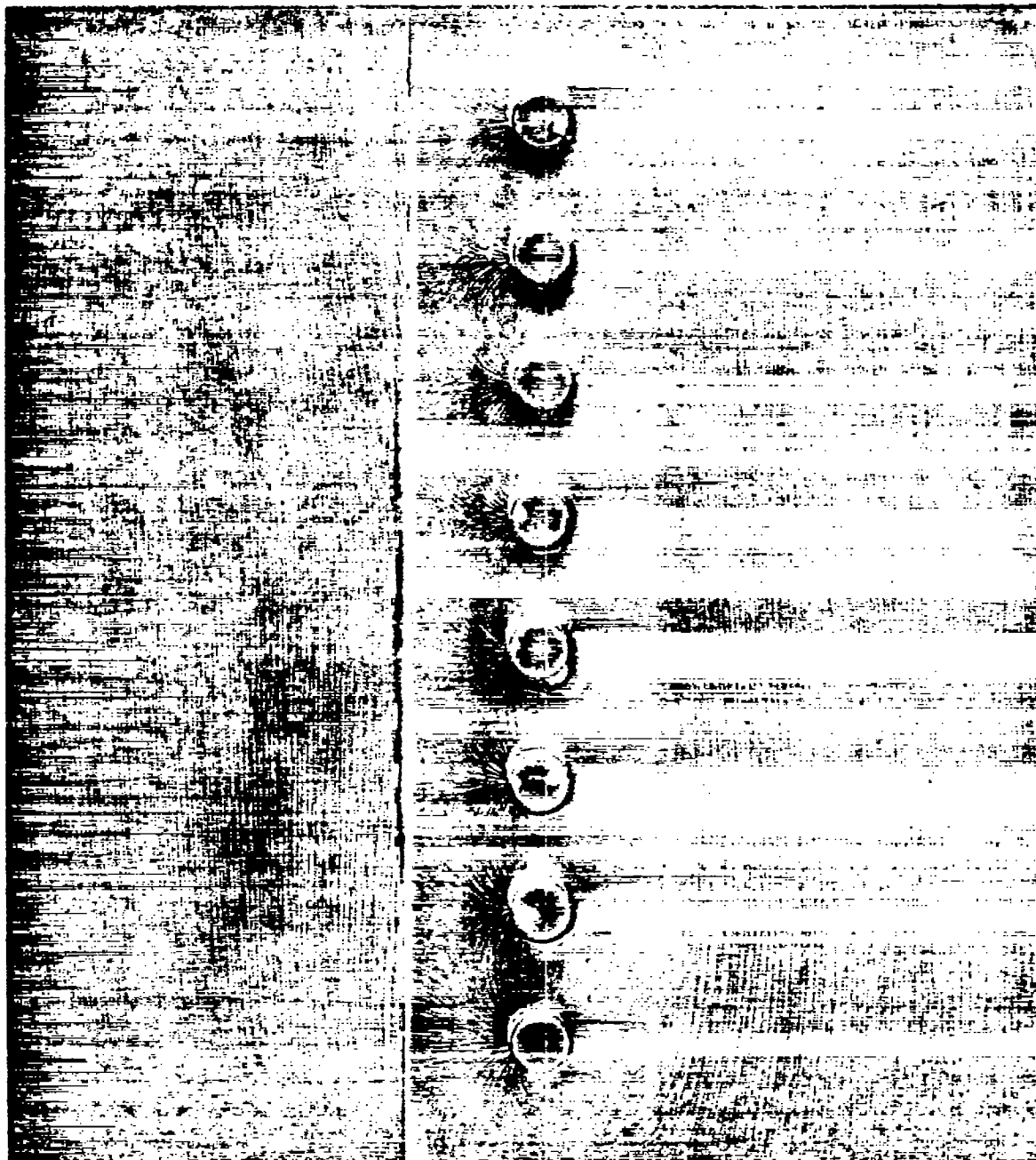

Figure 19.- Stress-coat pattern in a lap joint with a single row of rivets.

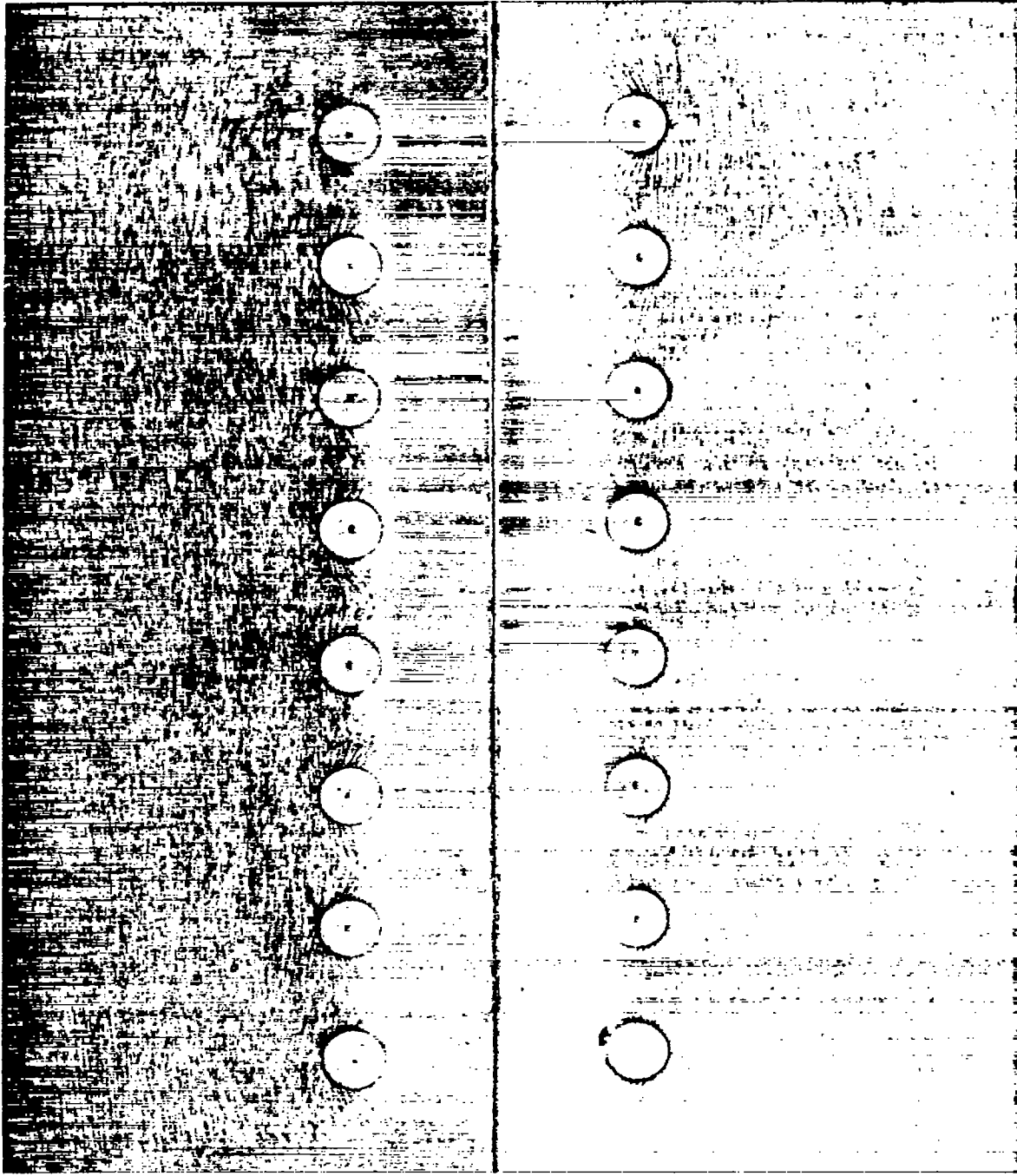
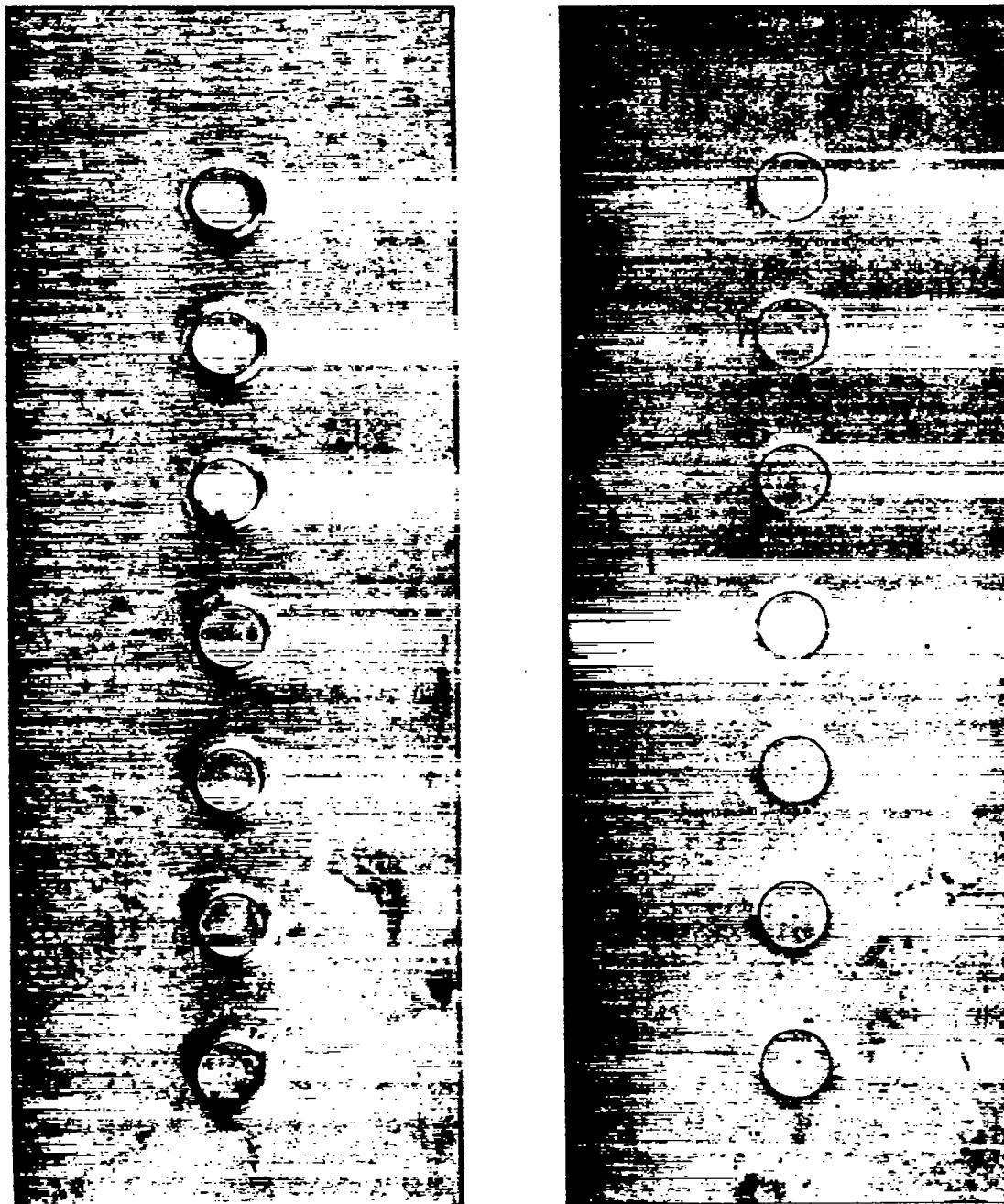

Figure 20.- Stress-coat pattern in a riveted butt joint.



(a) Head side.

(b) Flush side.

Figure 21.- Stress-coat pattern in a sheet-efficiency specimen.

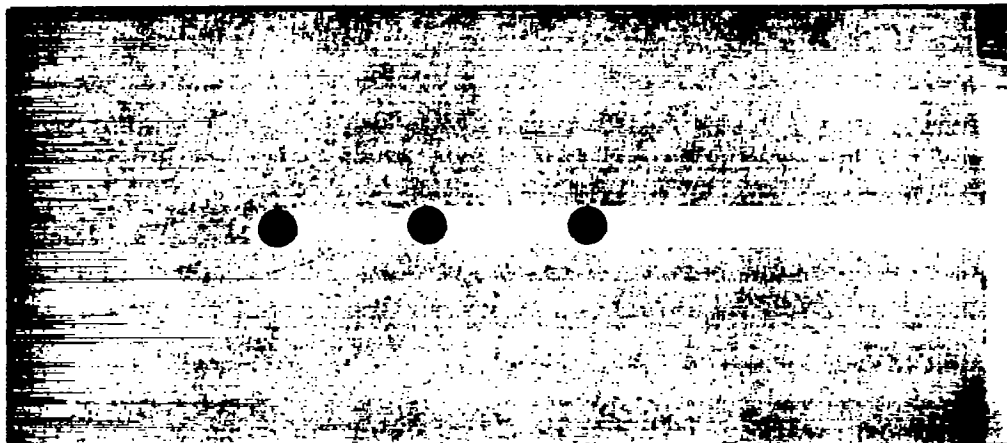

(a) Around drilled holes.

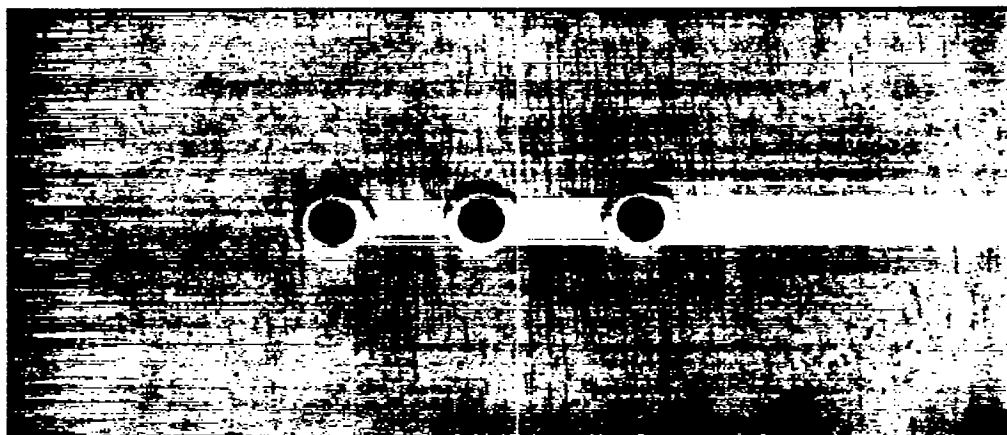

(b) Around drilled and dimpled holes.

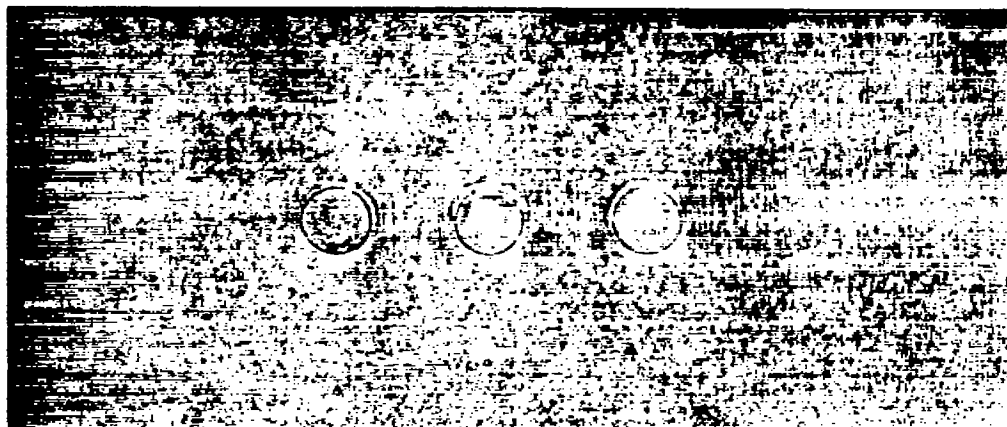

(c) Around rivet heads.

Figure 22.- Stress-coat patterns on single sheets.



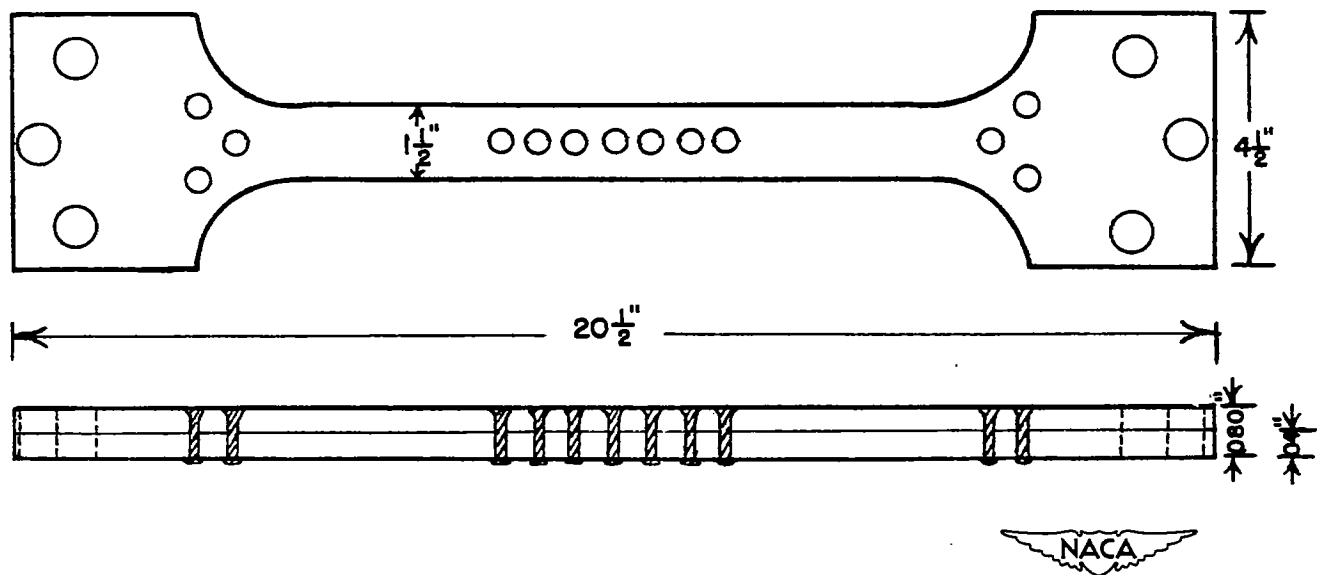

Figure 23.- Specimen used for sheet-efficiency tests. (Sheets, 0.040-in. 24S-T Alclad. Rivets, AN 426 AD4-5, spaced $\frac{1}{2}$ in. apart in test section.)

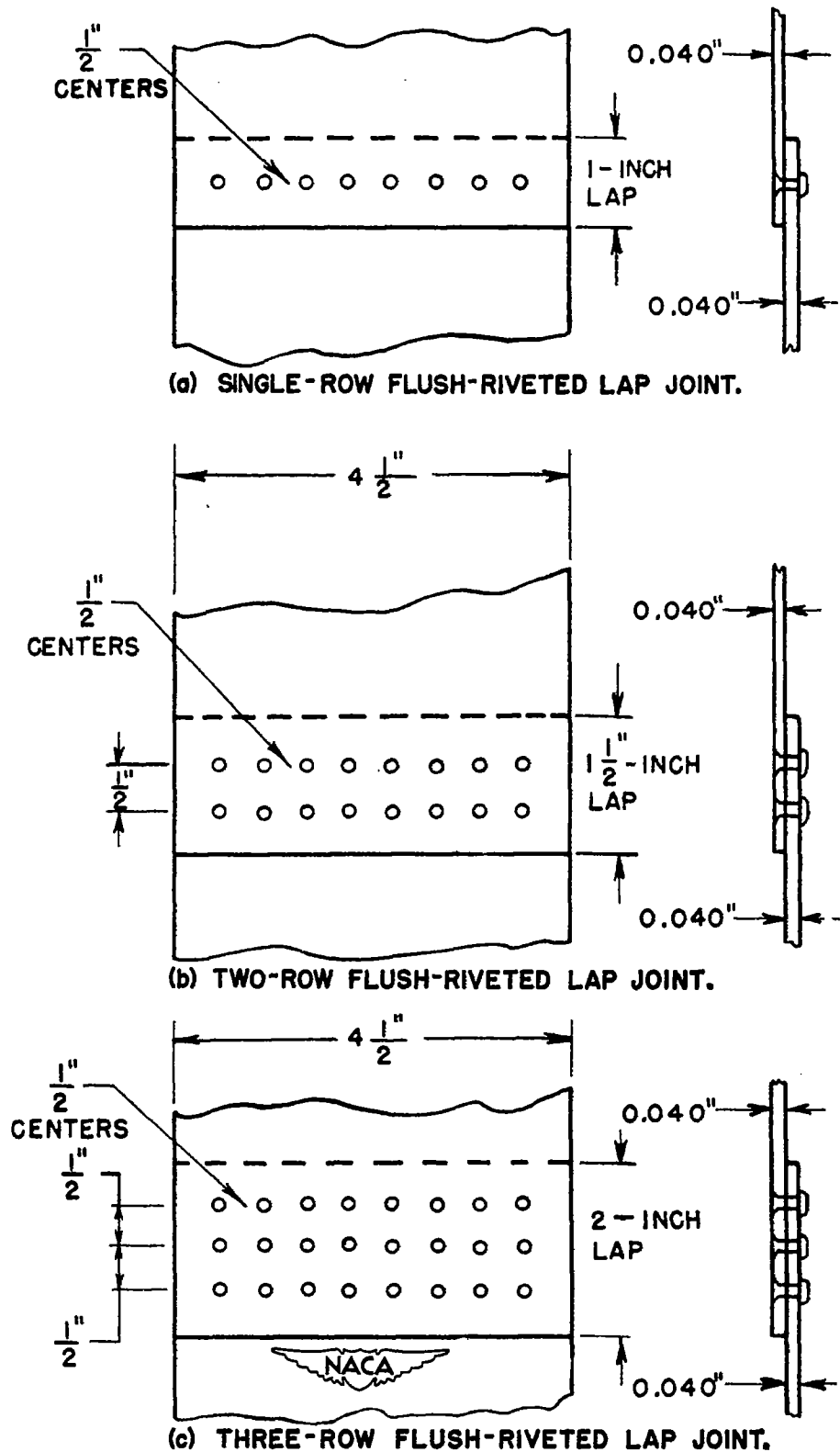
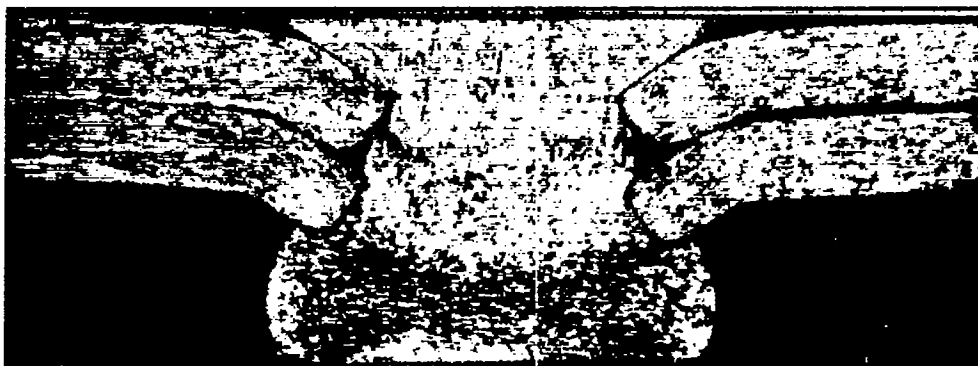
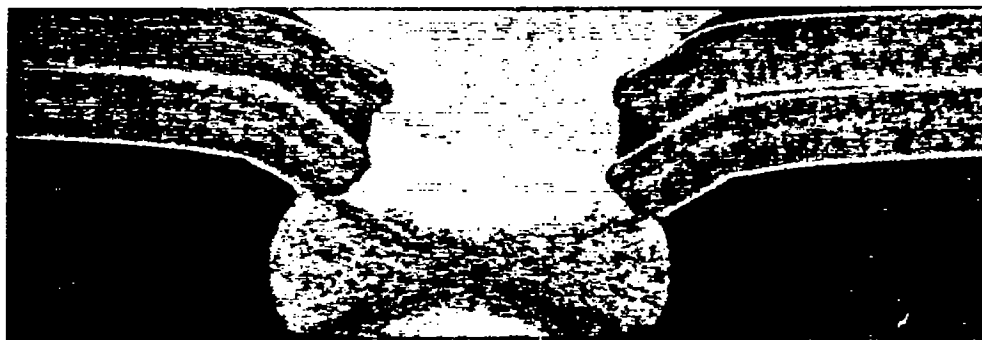

Figure 24.- Riveted lap-joint fatigue test specimens. (Length between grips about 12 in.)



(a) 24S-T bare.



(b) 24S-T Alclad.

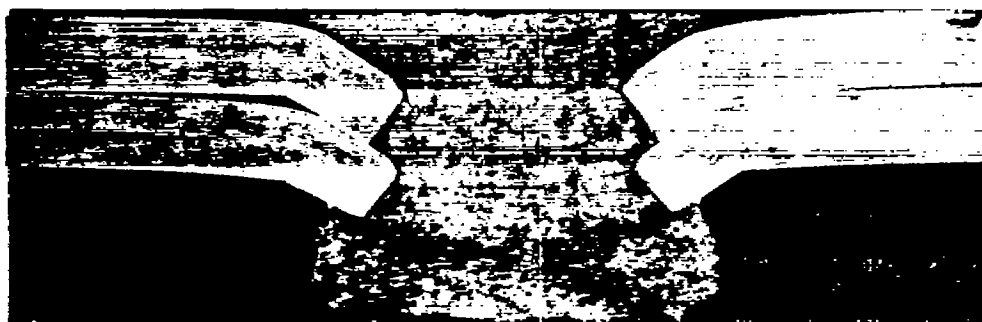

(c) 75S-T Alclad.

Figure 25.- Cross sections through rivets in 24S-T sheet (bare and Alclad) and 75S-T Alclad sheet.

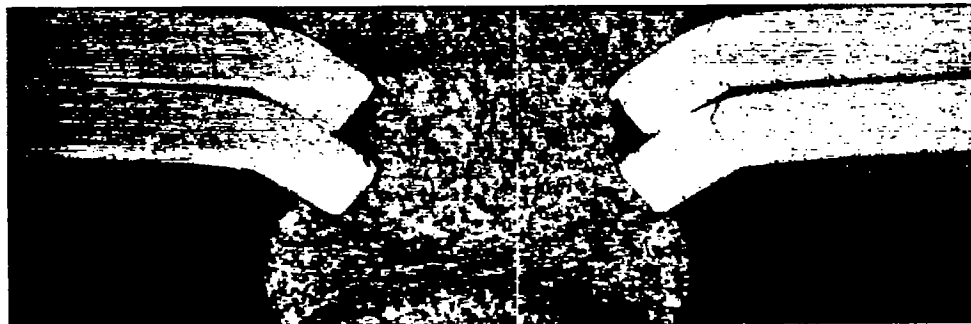

(a) R303-T275 bare.



(b) R303-T275 clad.

Figure 26.- Cross sections through rivets in R303-T275 sheet (bare and clad).



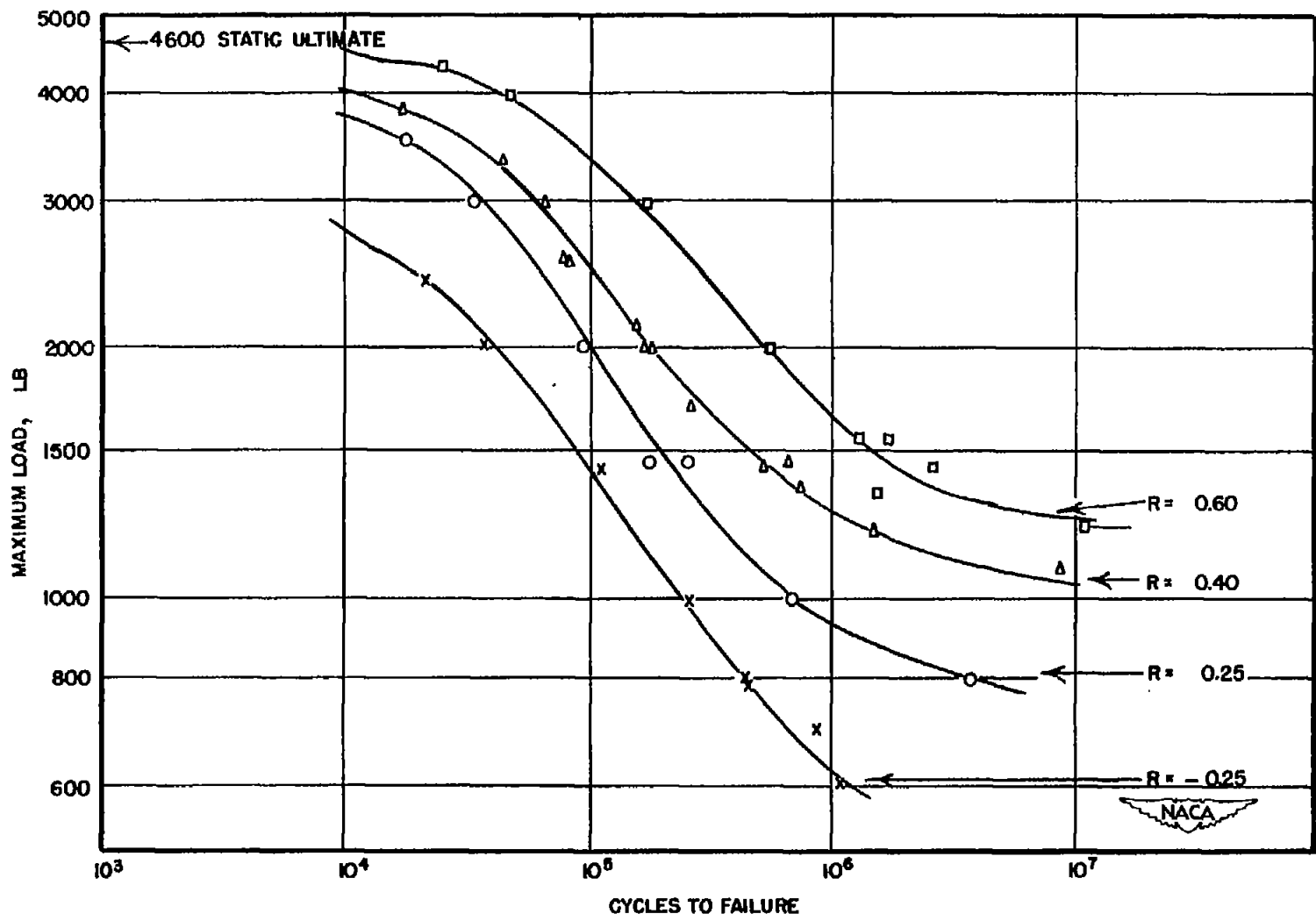

Figure 27.- Direct-stress fatigue strength of riveted lap joints of 0.040-inch 24S-T Alclad sheet with a single row of eight rivets. (R = min. load/max. load. Positive values indicate tension; negative values, compression.)

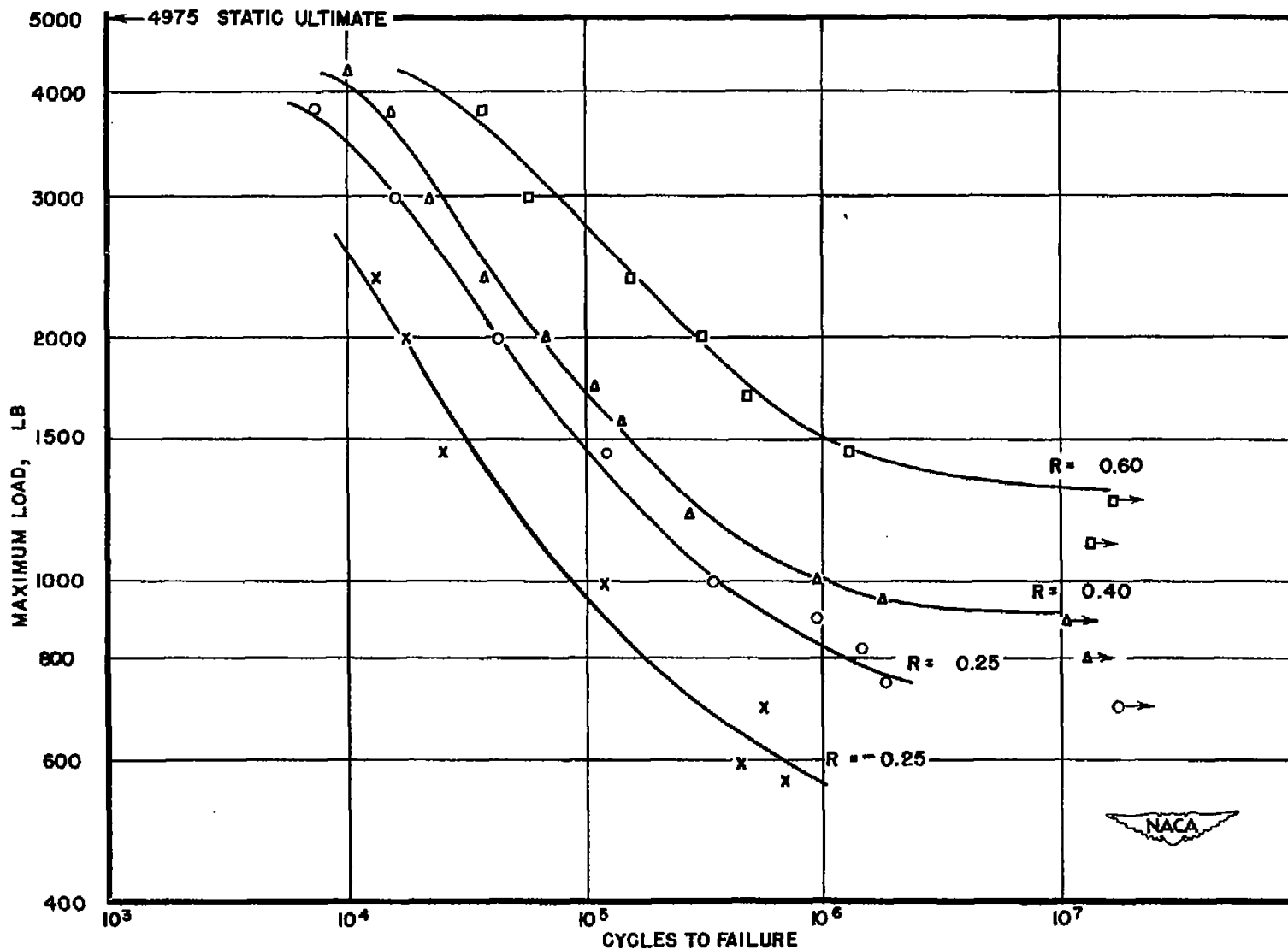

Figure 28.- Direct-stress fatigue strength of riveted lap joints of 0.040-inch 75S-T Alclad sheet with a single row of eight rivets. (R = min. load/max. load. Positive values indicate tension; negative values, compression.)

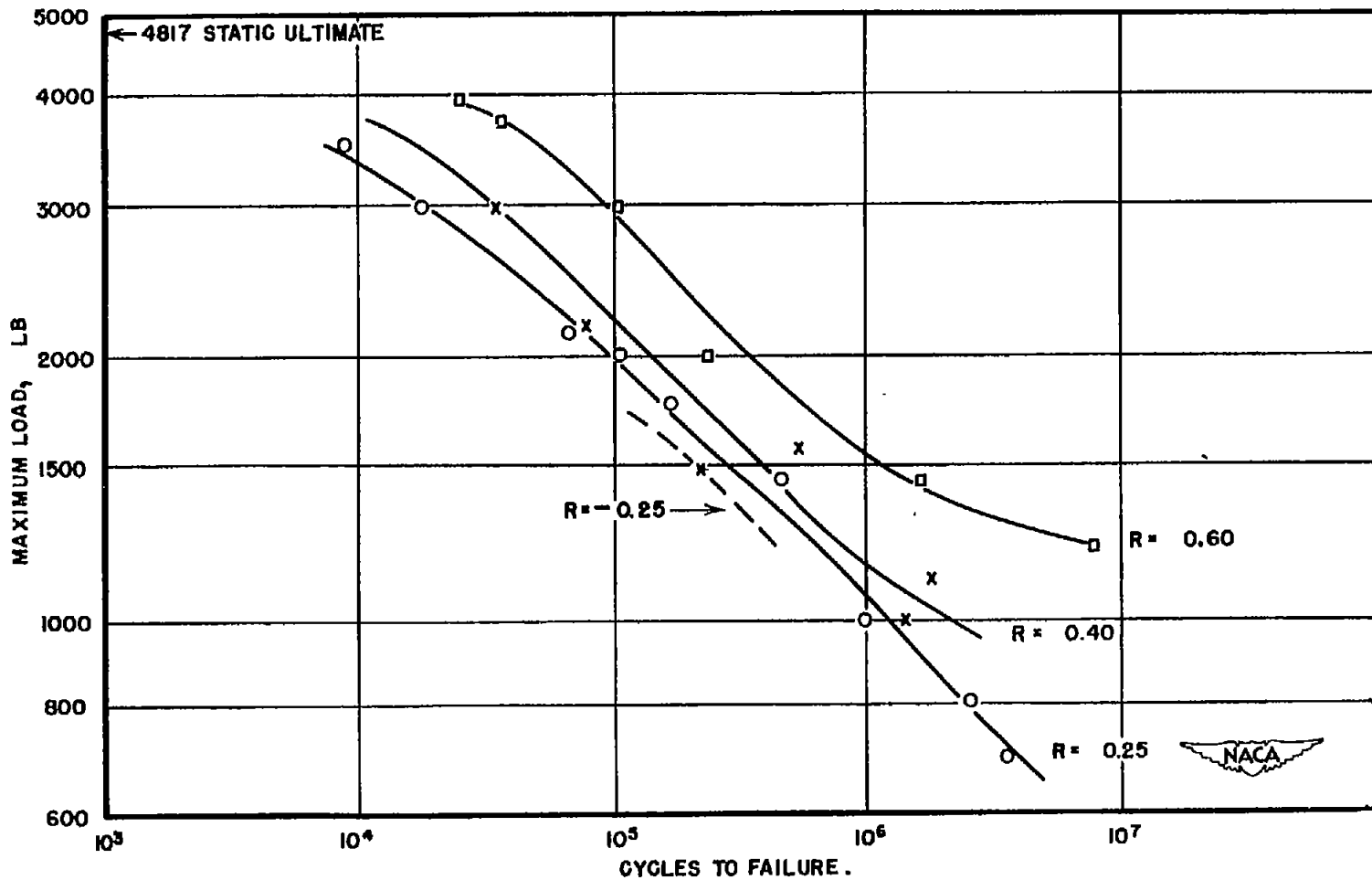

Figure 29.- Direct-stress fatigue strength of riveted lap joints of 0.040-inch R303-T275 clad sheet with a single row of eight rivets. (R = min. load/max. load. Positive values indicate tension; negative values, compression.)

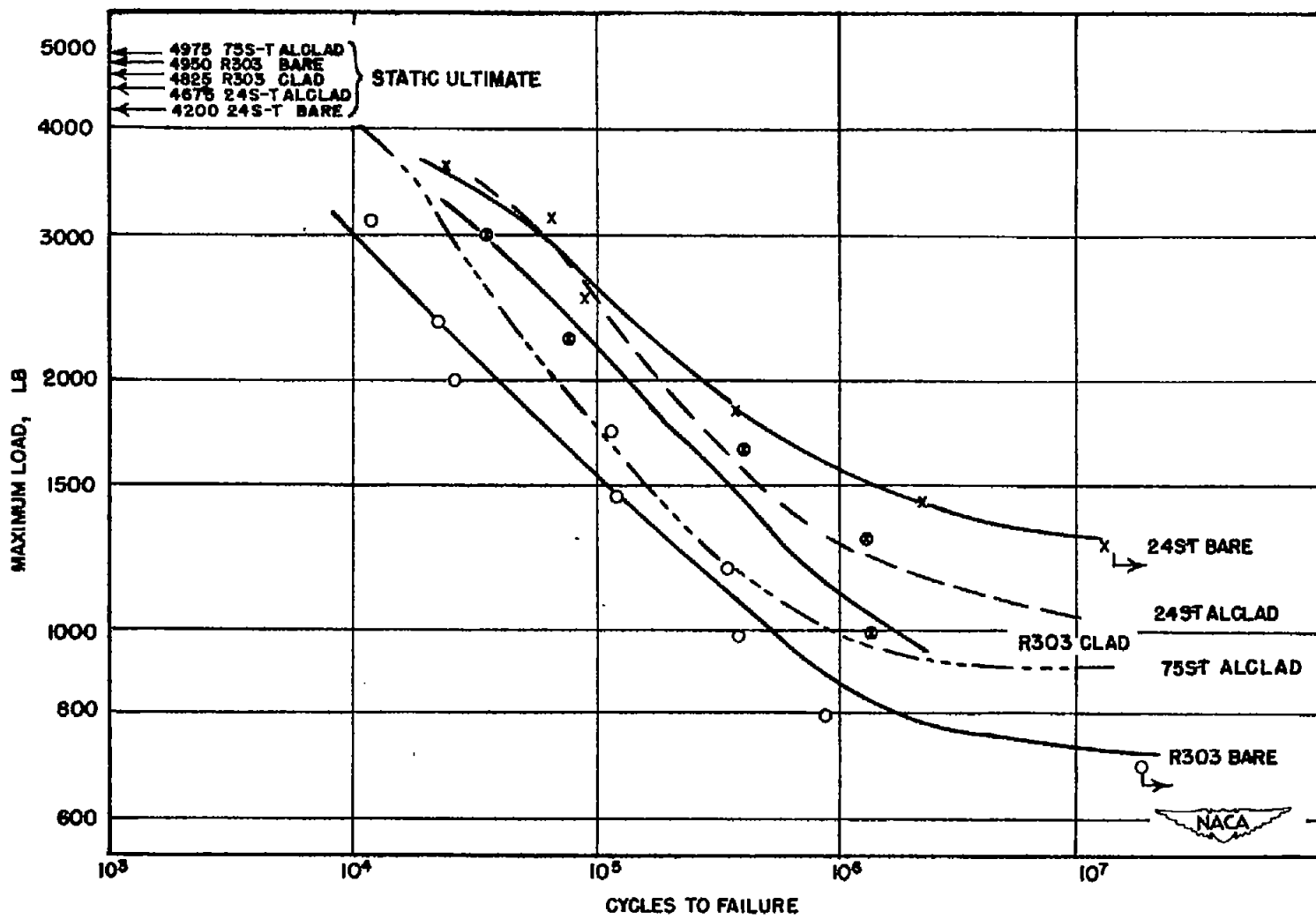
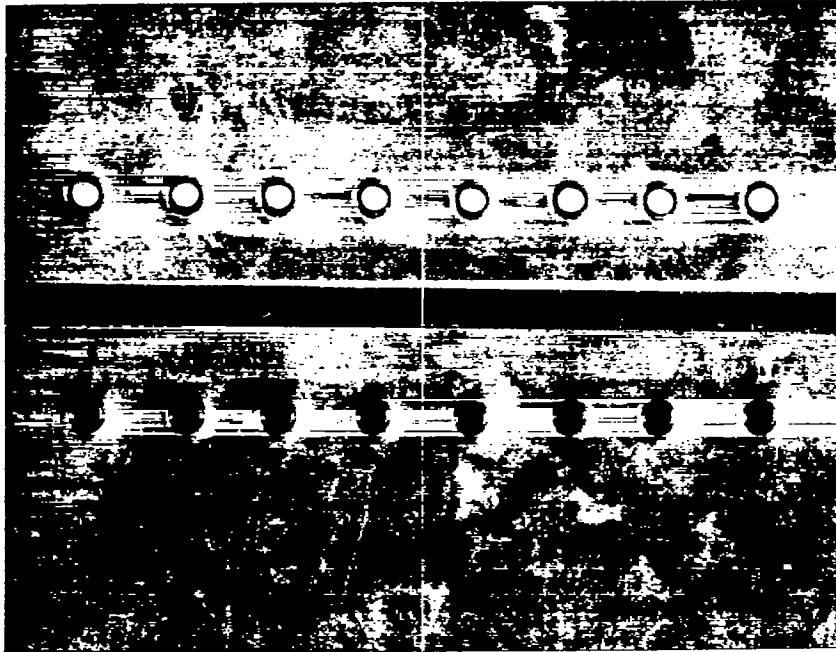
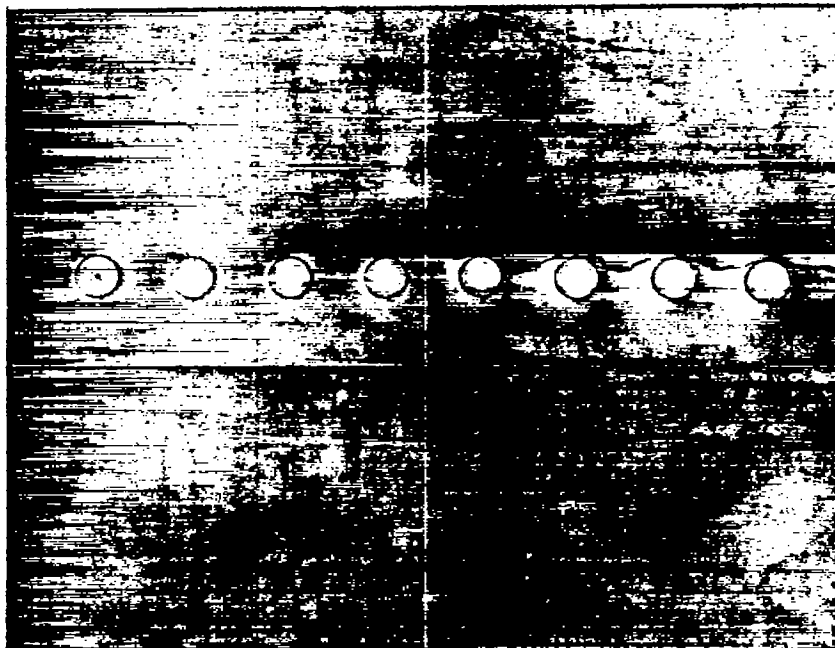

Figure 30.- Comparison of fatigue strengths of simple riveted lap joints of 0.040-inch sheets of various alloys with a single row of eight rivets. (R = min. load/max. load = 0.40, in tension.)



(a) Static failure by rivet shear.



(b) Fatigue failure by propagation of crack through sheet materials.

Figure 31.- Typical failures.



(a) Rivet from joint made by coin dimpling.
(Loaded at 125 lb/rivet; lifetime,
2,397,000 cycles.)



(b) Rivet from joint made with conventional
dimpling. (Loaded at 150 lb/rivet;
lifetime, 570,000 cycles.)

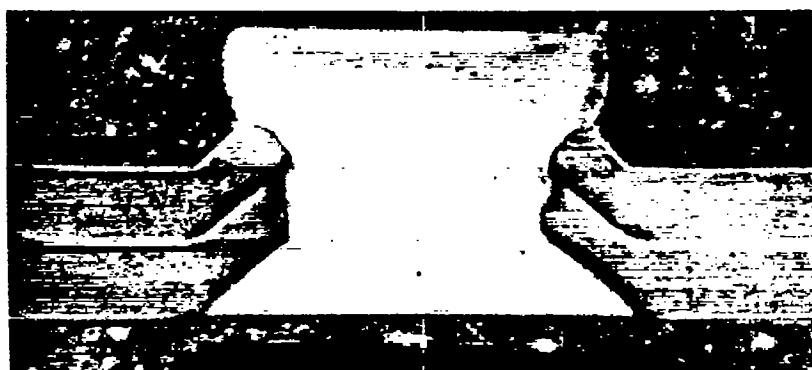

(c) Rivet from joint made by spin dimpling.
(Loaded at 337 lb/rivet; lifetime,
43,000 cycles.)

Figure 32.- Cross sections through rivets in 24S-T Alclad sheet. Specimens failed in fatigue tests in tension at $R = 0.40$ and are representative both of rivets and of fatigue failures.

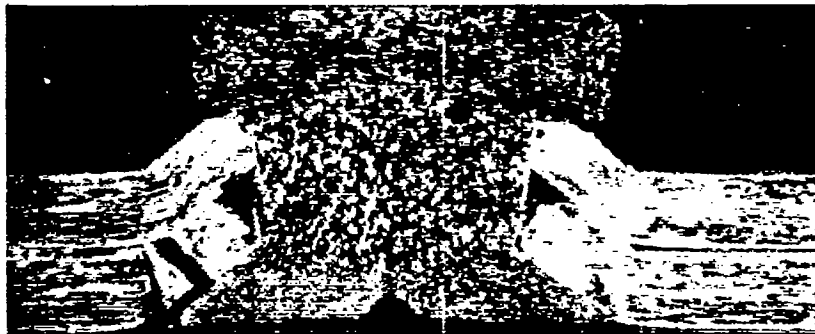

(a) Rivet from joint made by coin dimpling.
(Loaded at 150 lb/rivet; lifetime,
2,579,300 cycles)

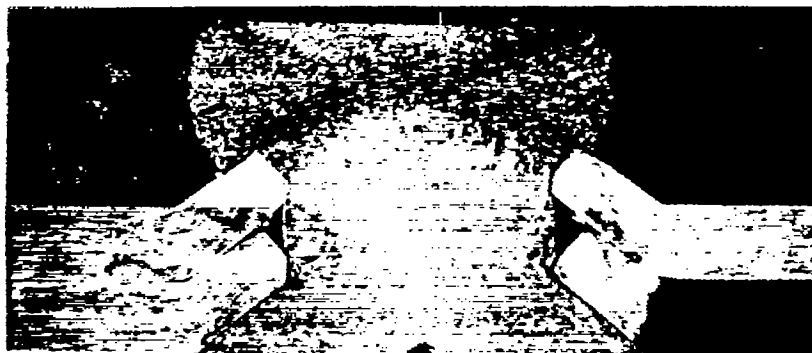

(b) Rivet from joint made with conventional
dimpling. (Loaded at 125 lb/rivet;
lifetime, 2,245,800 cycles)

Figure 33.- Cross sections through rivets in 75S-T Alclad sheet. Specimens failed in fatigue tests in tension at $R = 0.40$, and are representative both of rivets and of fatigue failures.

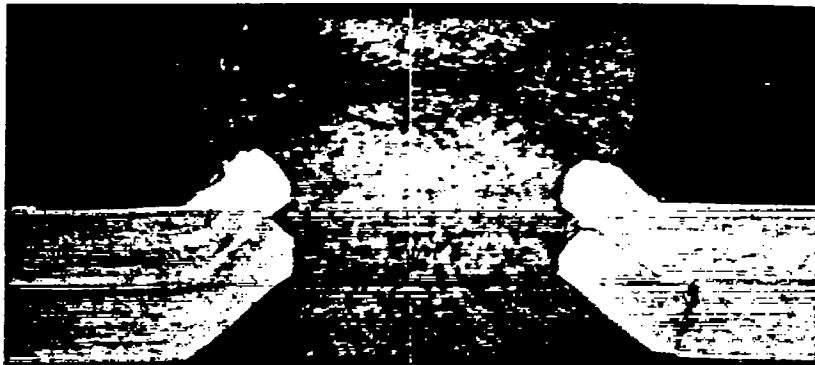

(c) Rivet from joint made by hot dimpling.
(Loaded at 212 lb/rivet; lifetime,
69,500 cycles.)

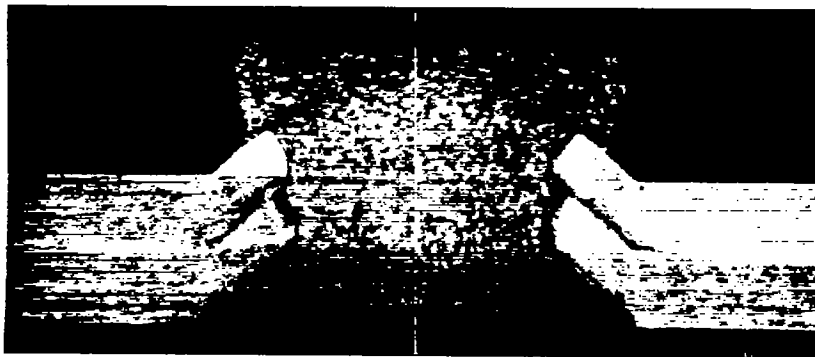

(d) Rivet from joint made by spin dimpling.
(Loaded at 137 lb/rivet; lifetime,
1,813,300 cycles.)



Figure 33.- Concluded.

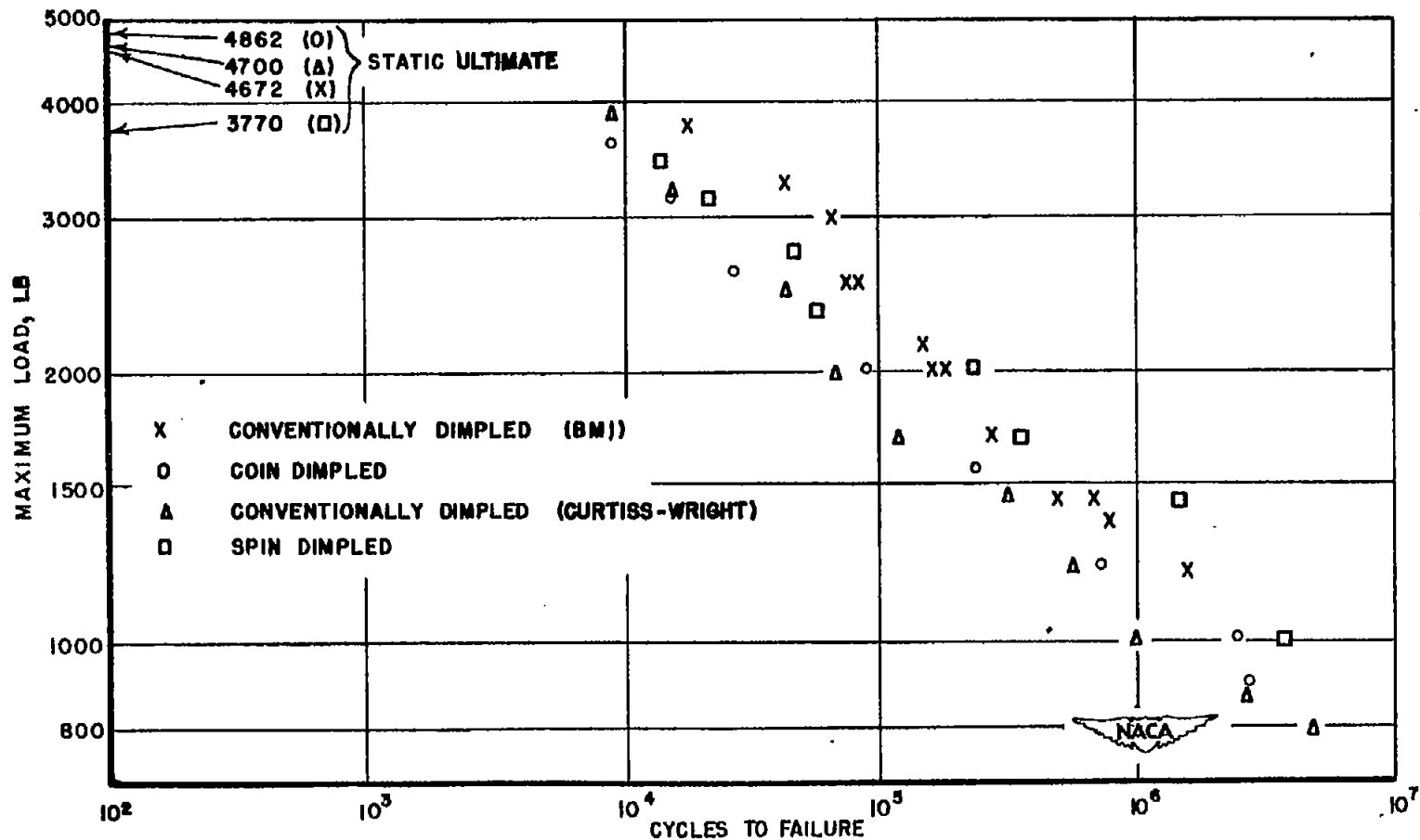

Figure 34.- Results of direct-stress fatigue tests for several sets of single-row flush-riveted lap joints of 24S-T Alclad sheet. (R = min. load/max. load = 0.40, in tension.)

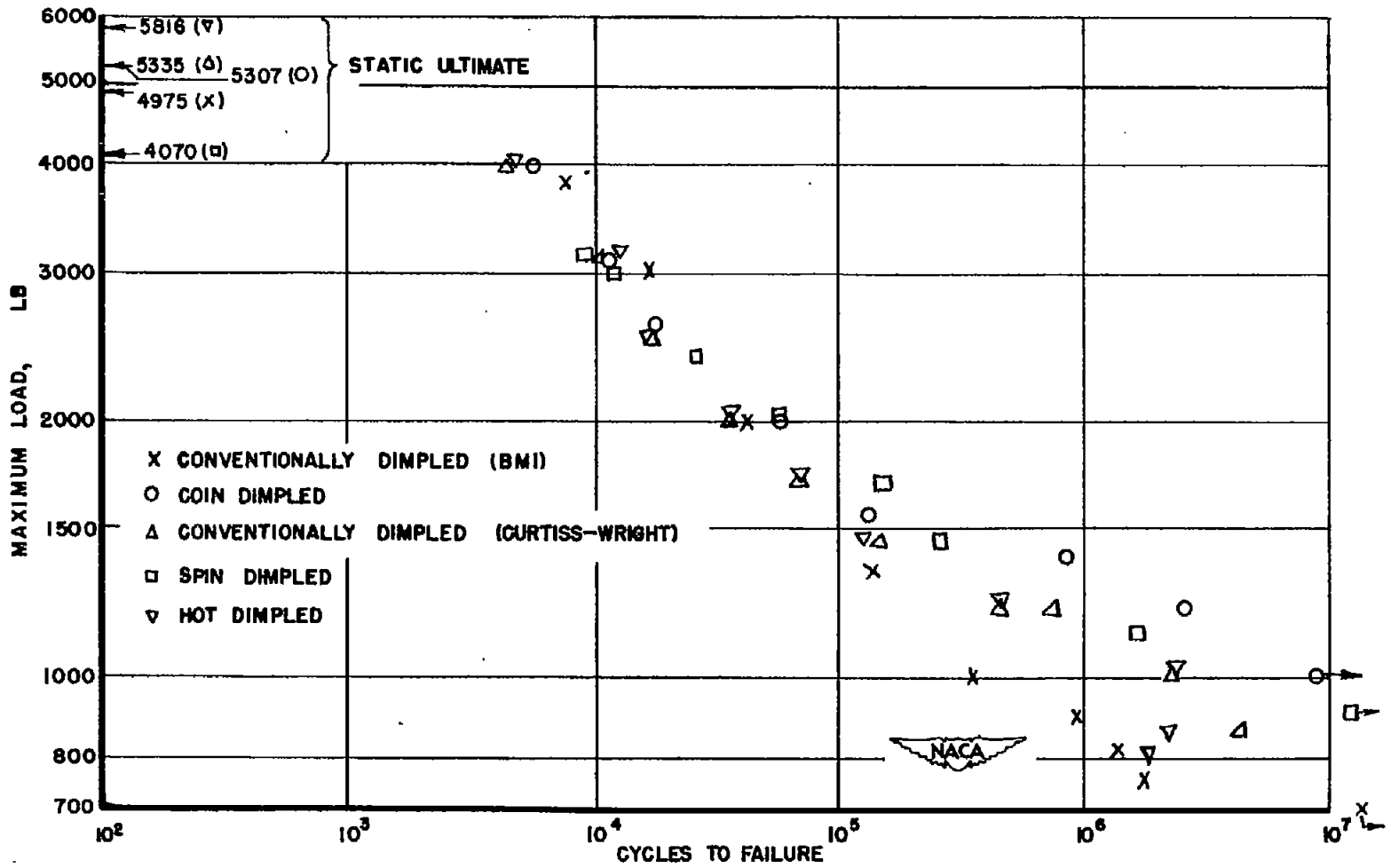

Figure 35.- Results of direct-stress fatigue tests for several sets of single-row flush-riveted lap joints of 75S-T Alclad sheets. (R = min. load/max. load = 0.40, in tension.)

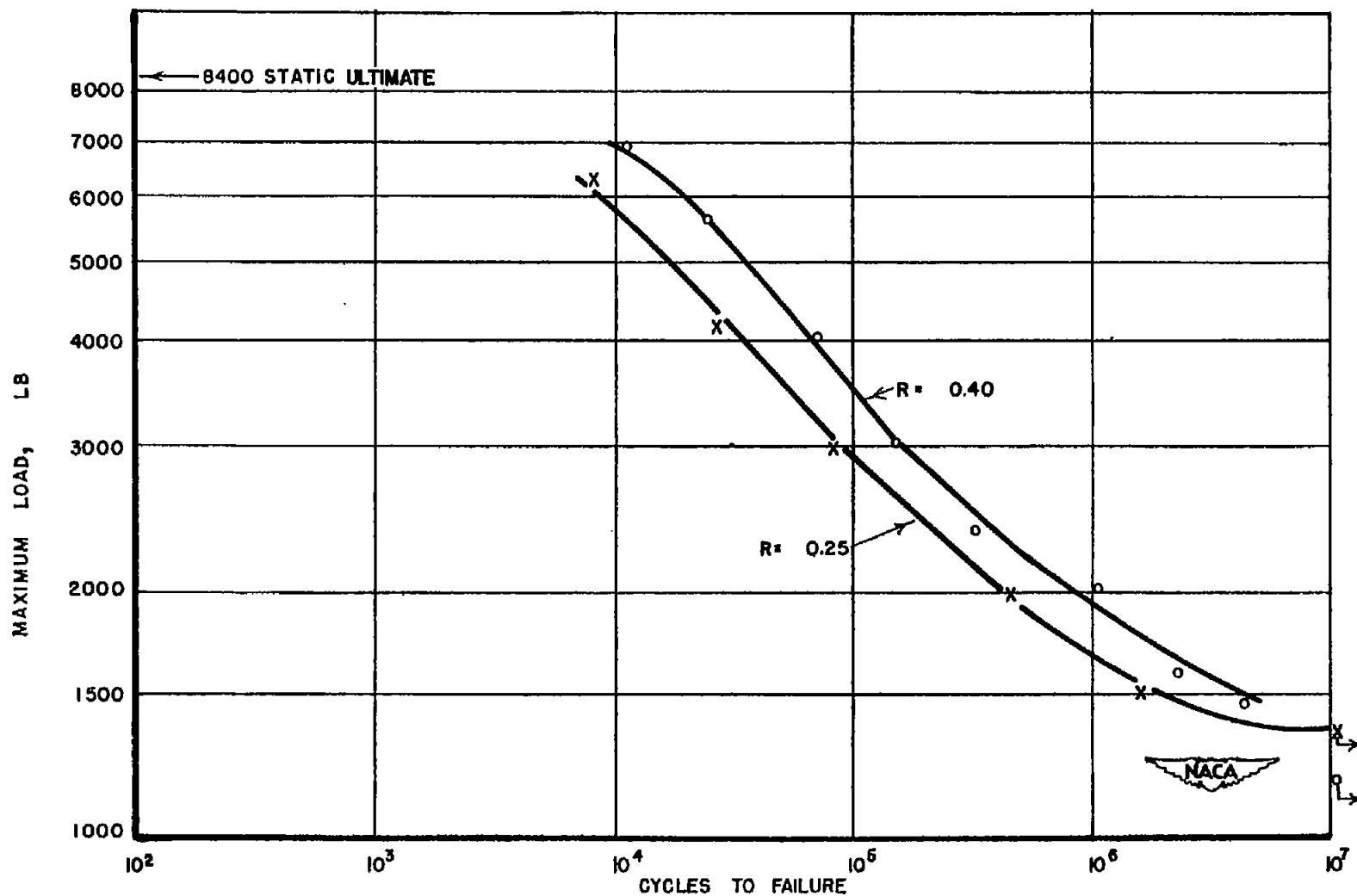

Figure 36.- Direct-stress fatigue strength of lap joints of 24S-T Alclad with two rows of flush rivets. Joints $4\frac{1}{2}$ inches wide; each row contains eight rivets $\frac{1}{2}$ inch apart; rows $\frac{1}{2}$ inch apart. (R = min. load/max. load. Positive values indicate tension.)

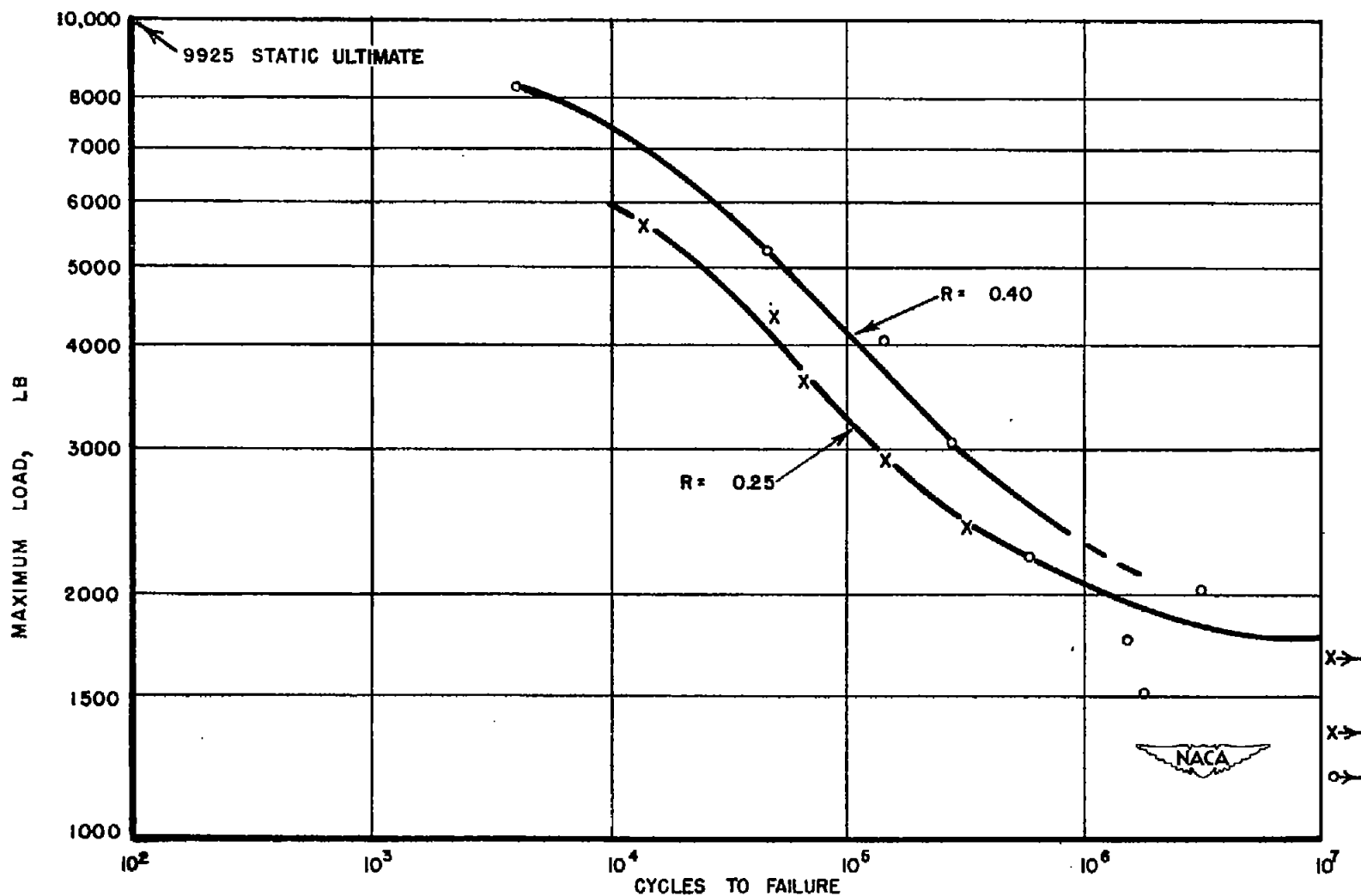

Figure 37.- Direct-stress fatigue test results for lap joints of 24S-T Alclad with three rows of flush rivets. Joints $4\frac{1}{2}$ inches wide; each row contains eight rivets $\frac{1}{2}$ inch apart; rows $\frac{1}{2}$ inch apart. (R = min. load/max. load. Positive values indicate tension.)

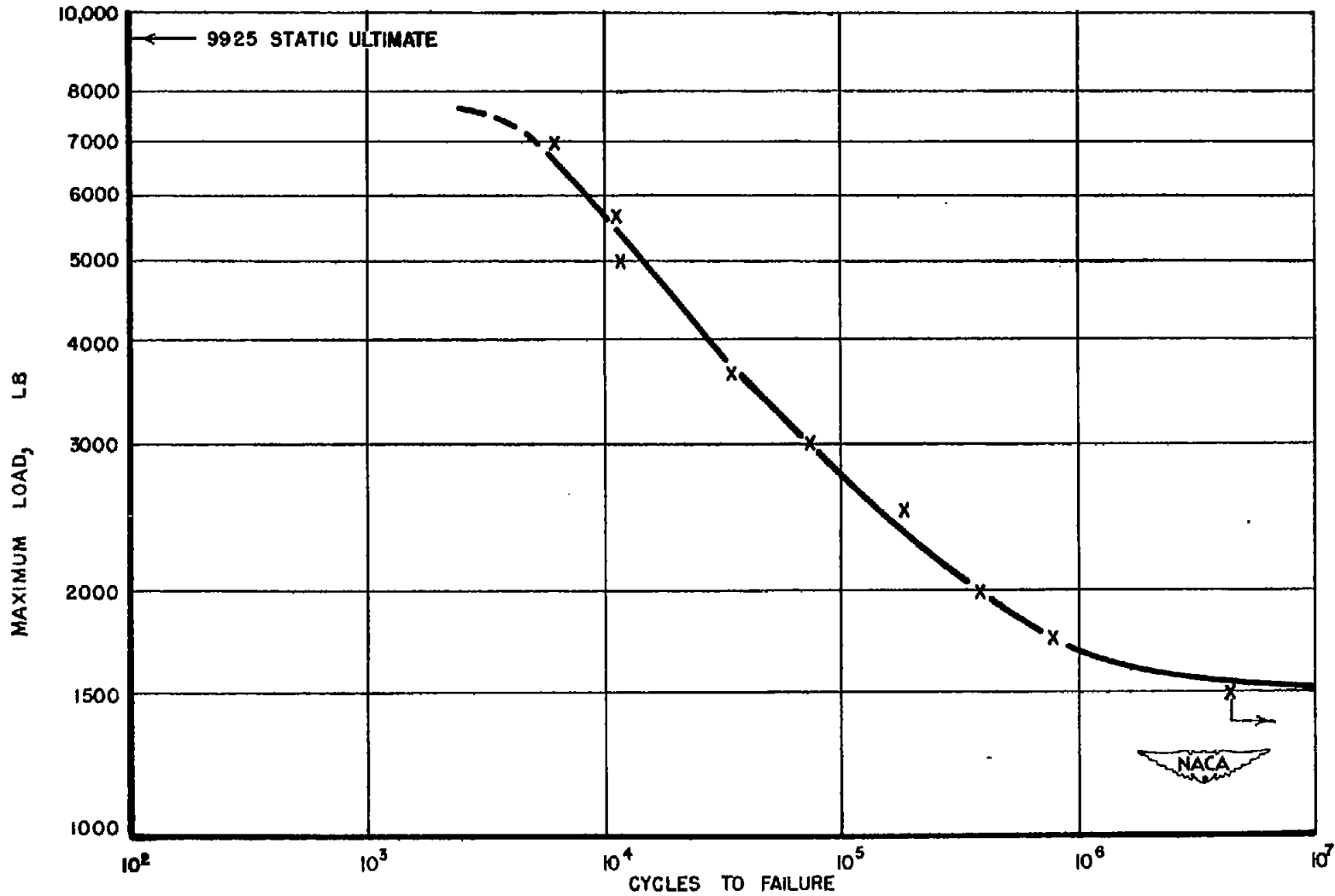
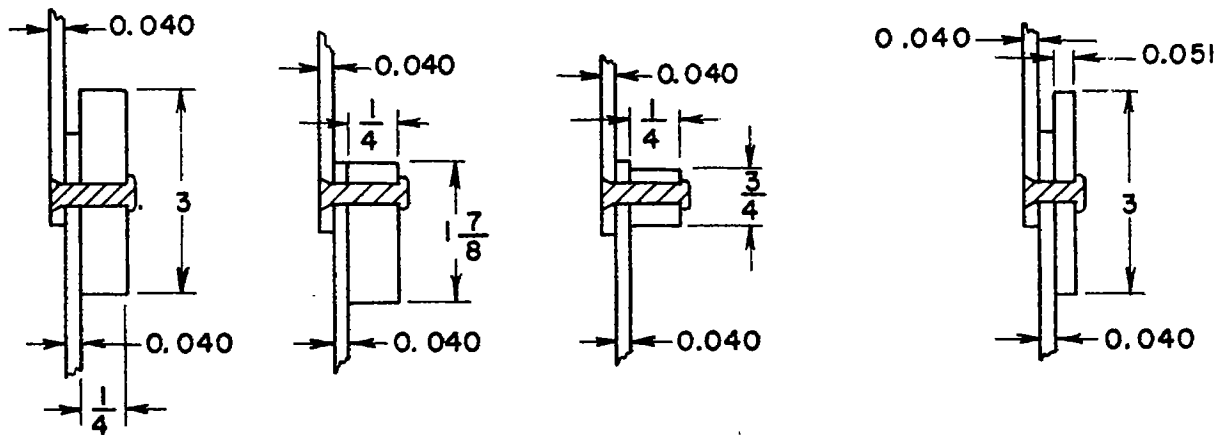
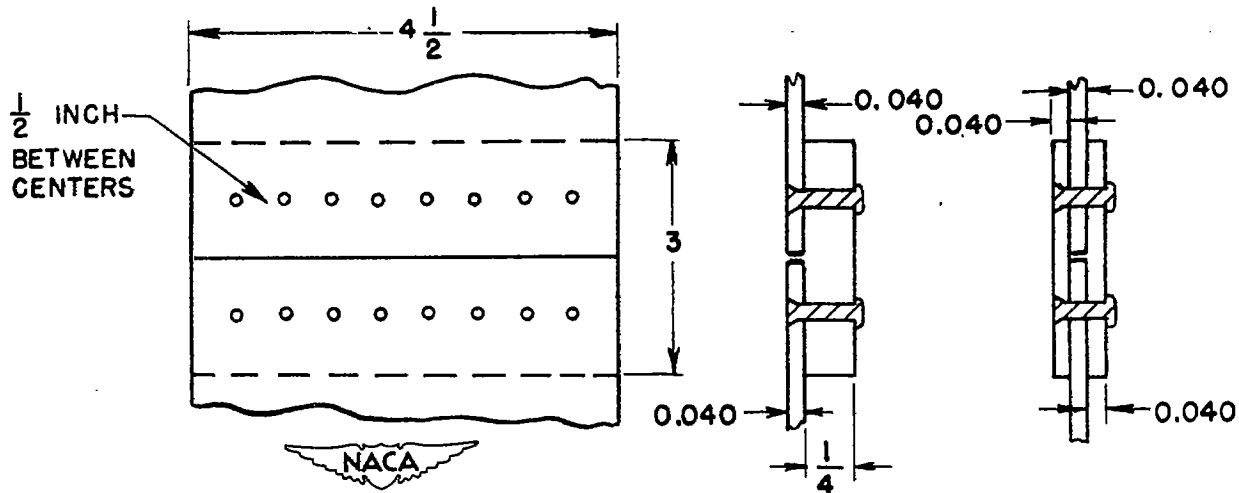

Figure 38.- Direct-stress fatigue test results for lap joints of 75S-T Alclad with two rows of flush rivets. Joints $4\frac{1}{2}$ inches wide; each row contains eight rivets $\frac{1}{2}$ inch apart; rows $\frac{1}{2}$ inch apart. (R = min. load/max. load = 0.40, in tension.)



(a) STIFFENED LAP JOINTS (0.040 - 0.040 WITH 0.250 AND 0.051 STIFFENERS).



(b) BUTT JOINTS (0.040 - 0.040 WITH 0.250 STRAP PLATE AND WITH TWO 0.040 STRAP PLATES).

Figure 39.- Schematic diagrams of riveted specimens. (Dimensions in in.)

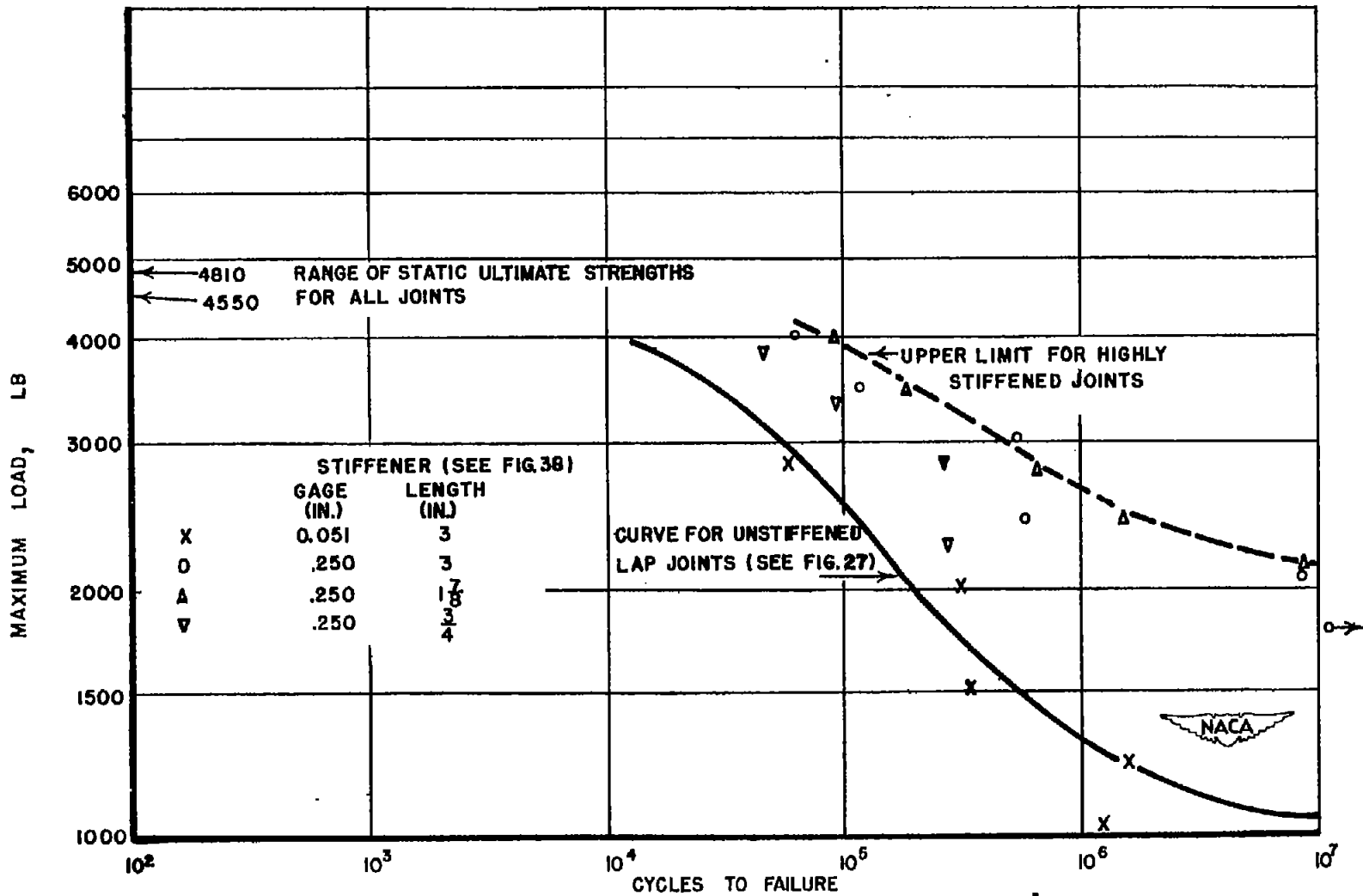

Figure 40.- Direct-stress fatigue test results for riveted lap joints of 0.040-inch 24S-T Alclad with various stiffeners. (R = min. load/max. load = 0.40, in tension.)

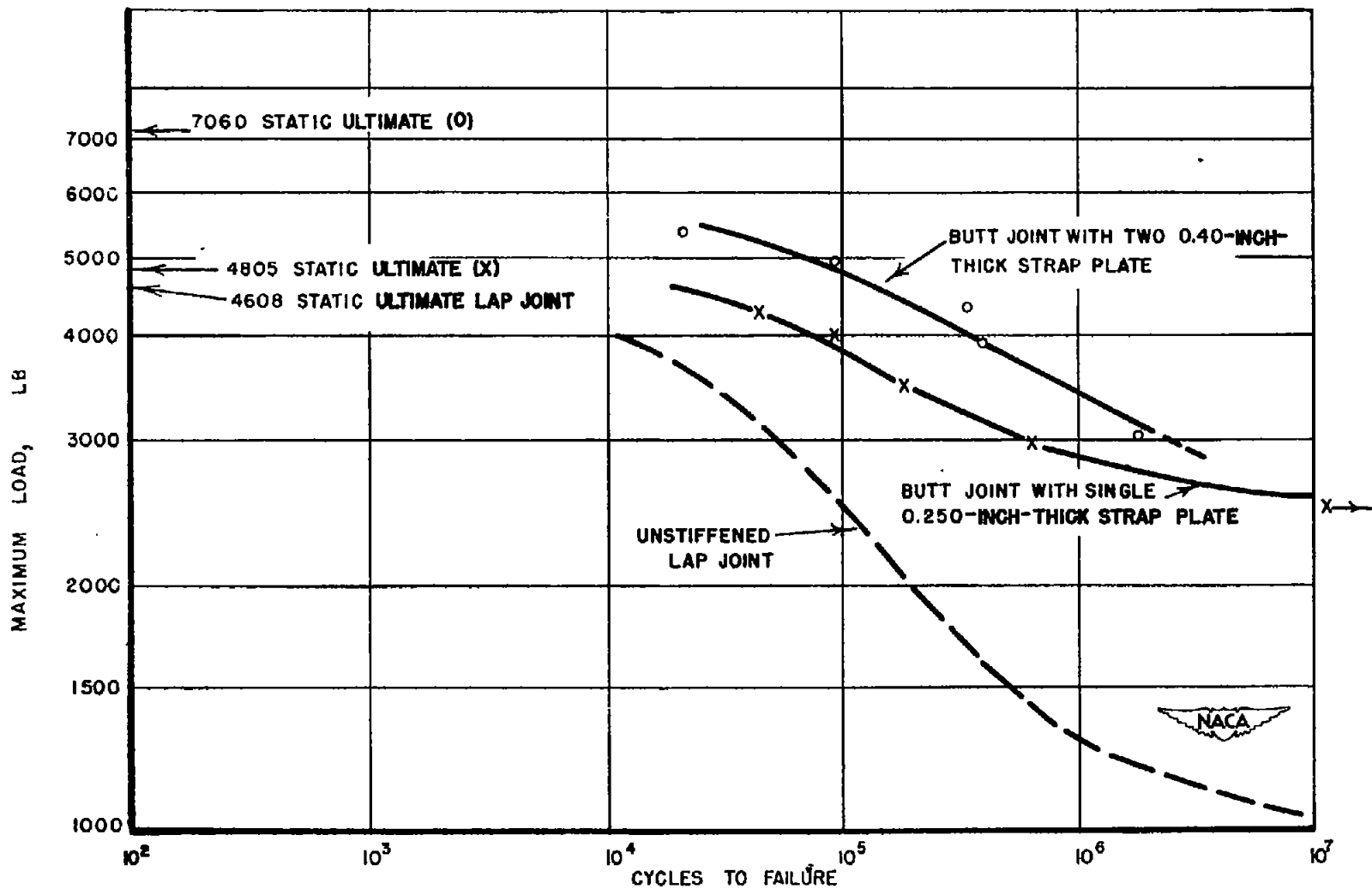

Figure 41.- Direct-stress fatigue test results for riveted butt joints of 0.040-inch 24S-T Alclad with various stiffeners. (R = min. load/max. load = 0.40, in tension.)

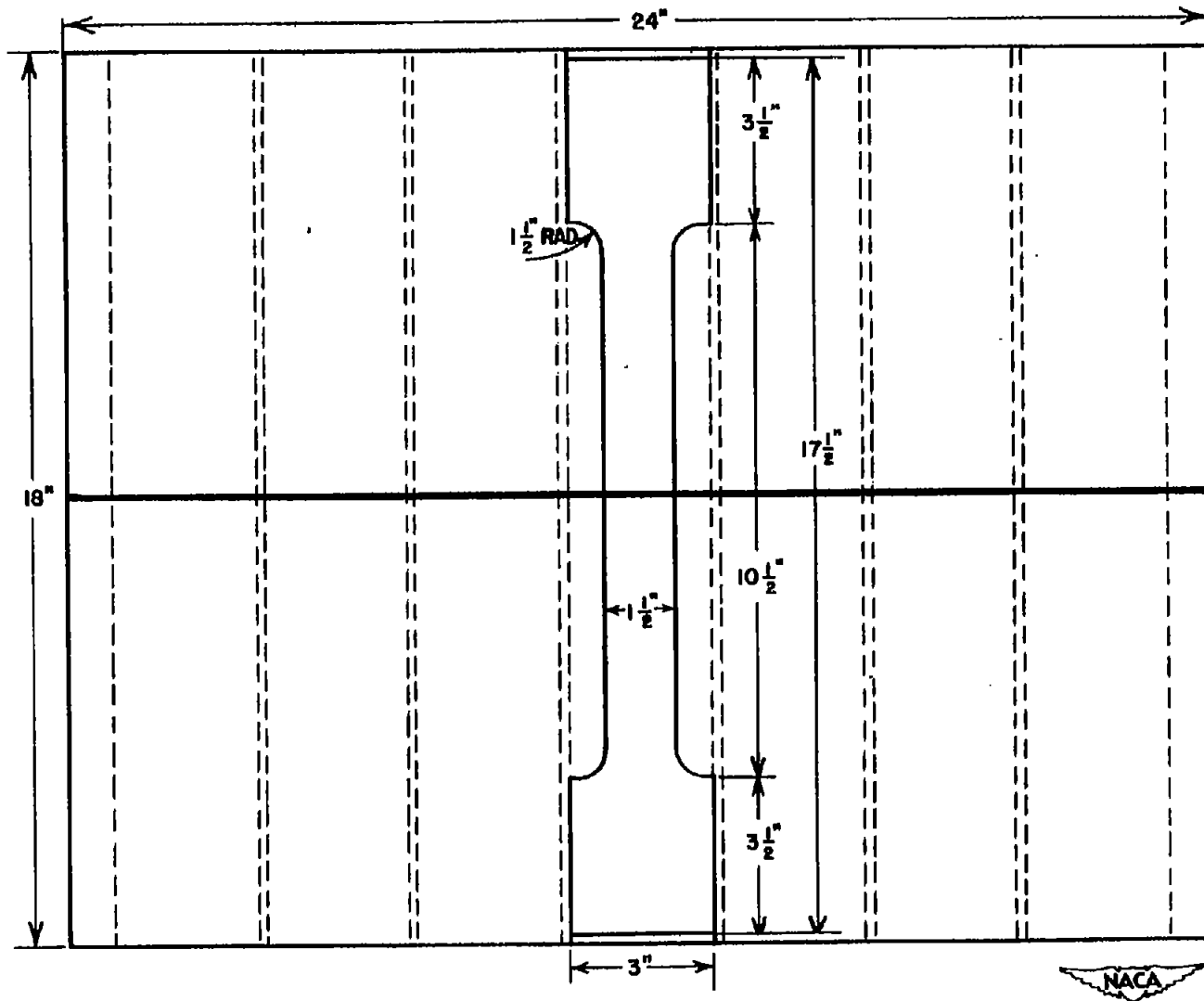

Figure 42.- Multi-arc-welded joint and fatigue test specimen.

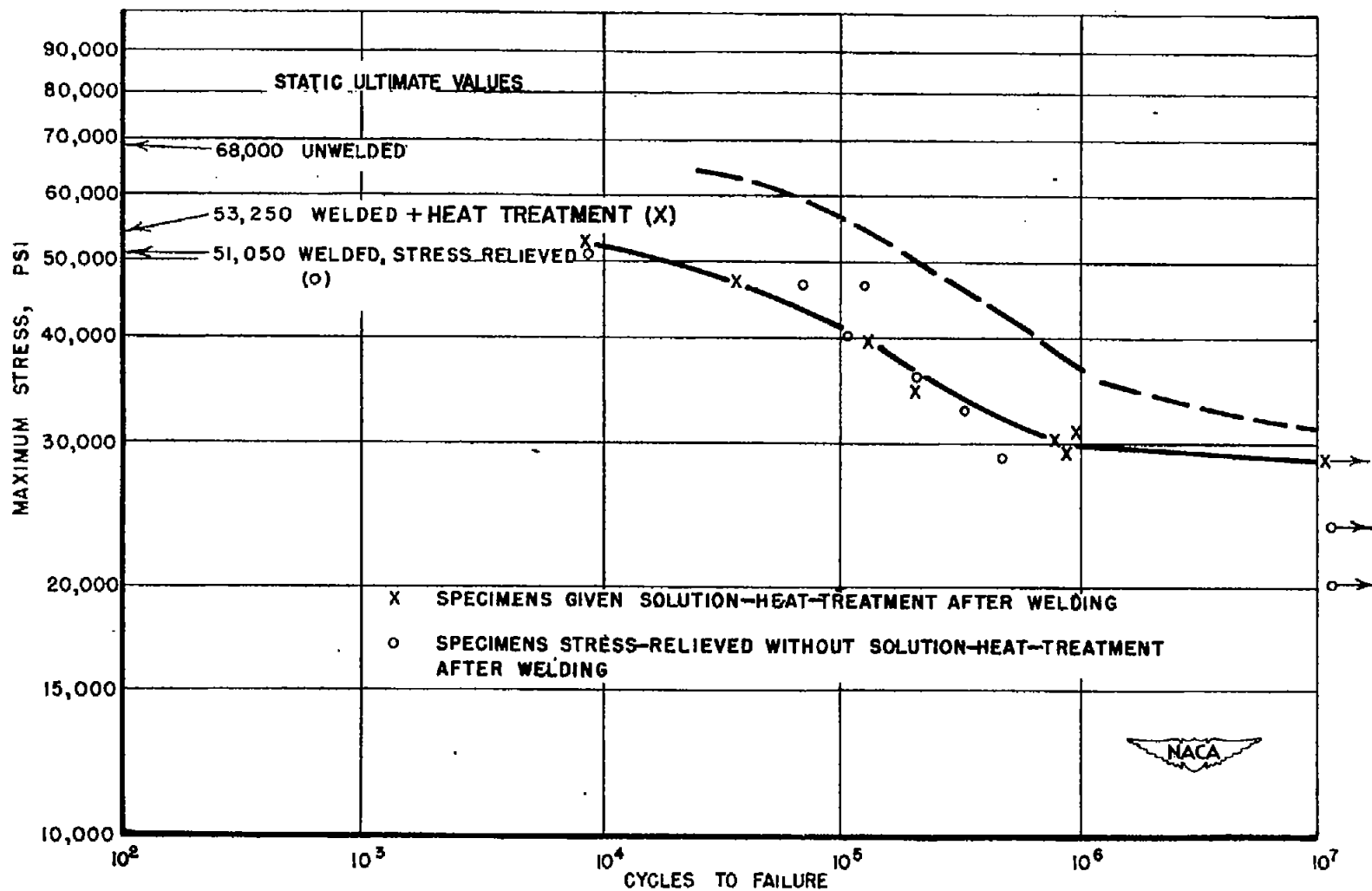
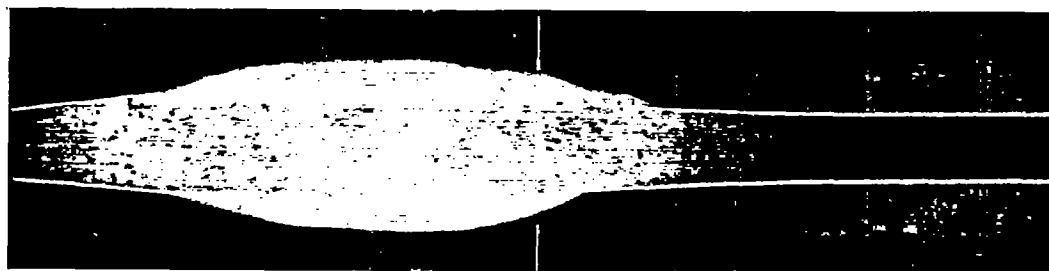
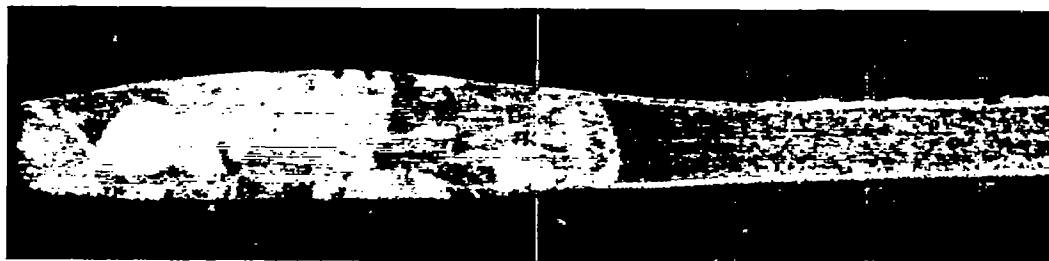

Figure 43.- Direct-stress fatigue test results for multi-arc-welded specimens of 0.040-inch 24S-T Alclad. (R = min. load/max. load = 0.40, in tension.)



(a) Stress-relieved but not solution-heat-treated after welding. Maximum load, 28,000 psi; $R = 0.40$, in tension; cycles to failure, 480,200.



(b) Stress-relieved and solution-heat-treated after welding. Maximum load, 40,000 psi; $R = 0.40$, in tension; cycles to failure, 126,900.

Figure 44.- Cross sections of multi-arc-welded specimens after failure by fatigue. (Each specimen failed in heat-affected region adjacent to weld.)

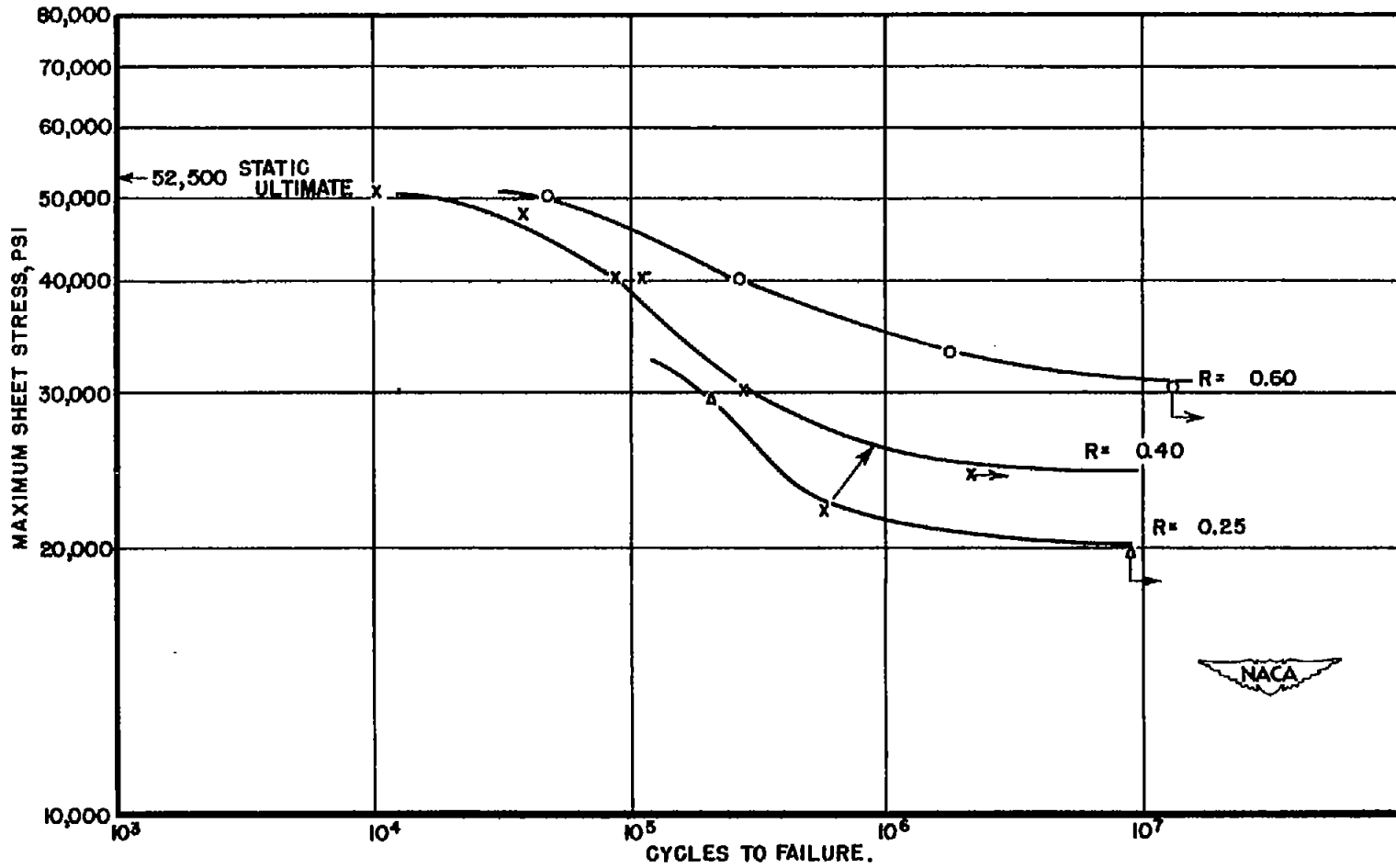

Figure 45.- Direct-stress fatigue test results for sheet efficiency of riveted 0.040-inch sheets of Alclad 24S-T. See figure 23 for details of specimen. (R = min. load/max. load. Positive values indicate tension.)

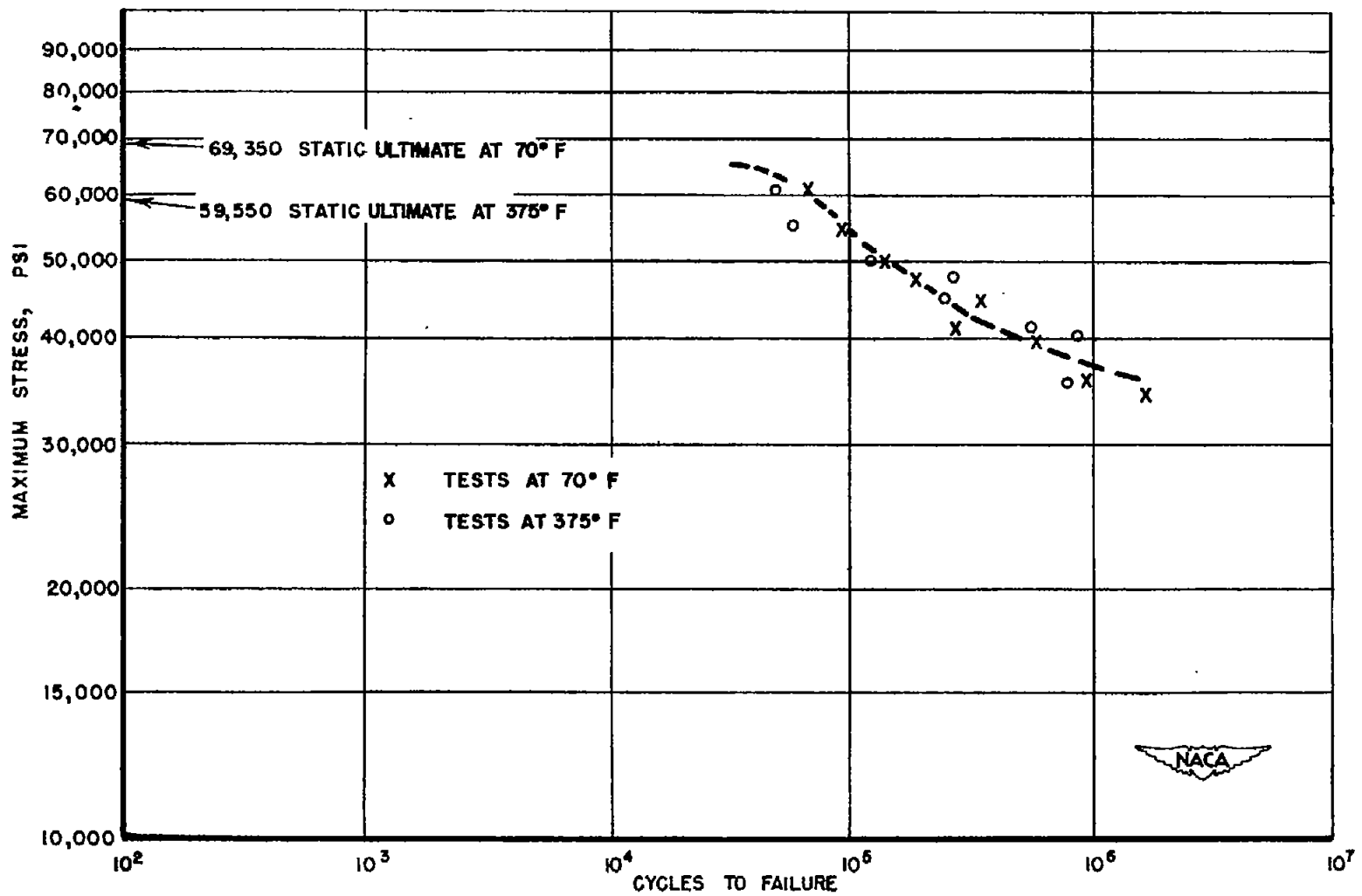

Figure 48.- Results of fatigue tests of 24S-T Alclad sheet at 375° F. Test section, 1.000 by 0.040 inch. Each specimen held at temperature for 1 hour preceding test and tested at temperature. (R = min. load/max. load = 0.40, in tension.)

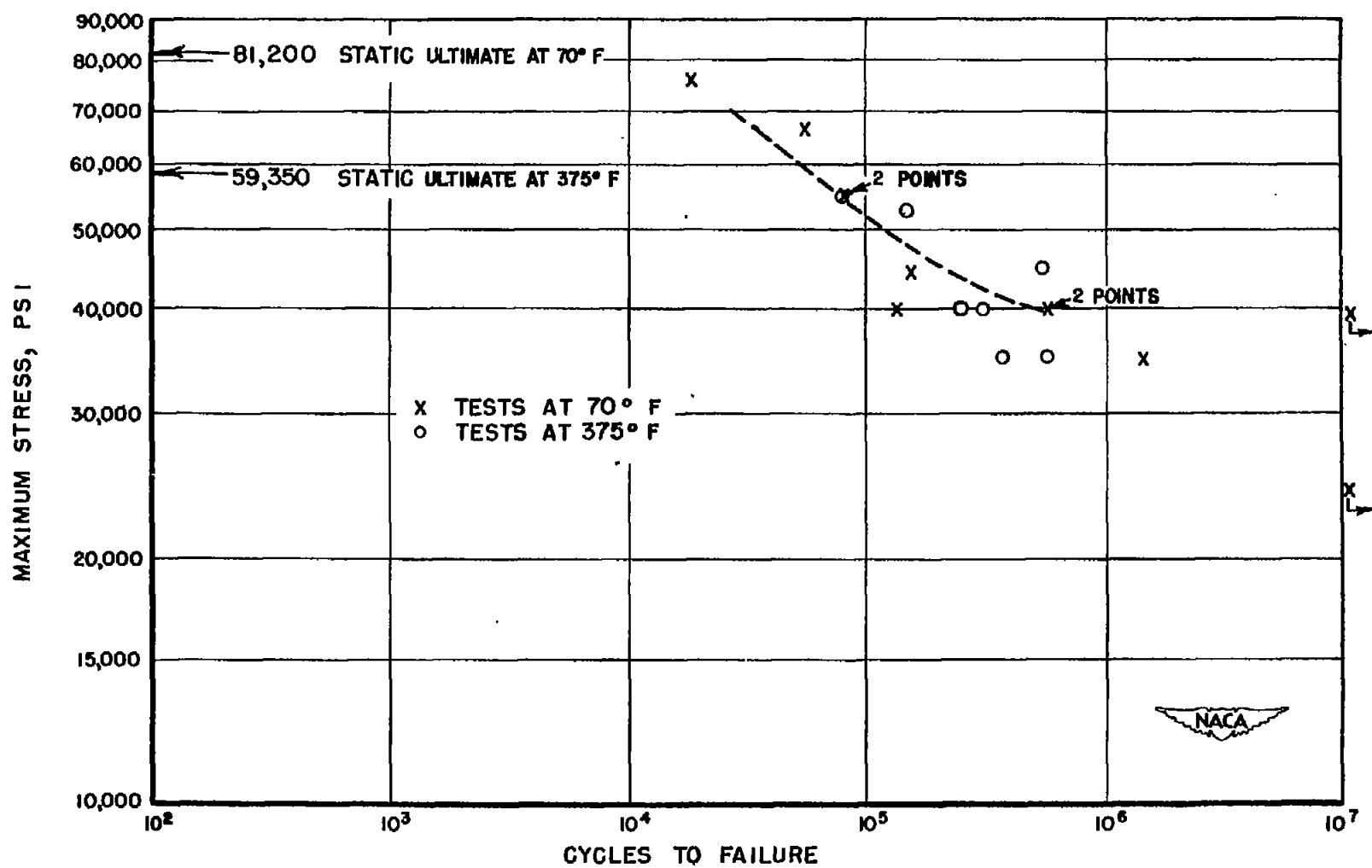

Figure 47.- Results of fatigue tests of 75S-T Alclad sheet at 375° F. Test section, 1,000 by 0.040 inch. Each specimen held at temperature for 1 hour preceding test and tested at temperature. (R = min. load/max. load = 0.40, in tension.)

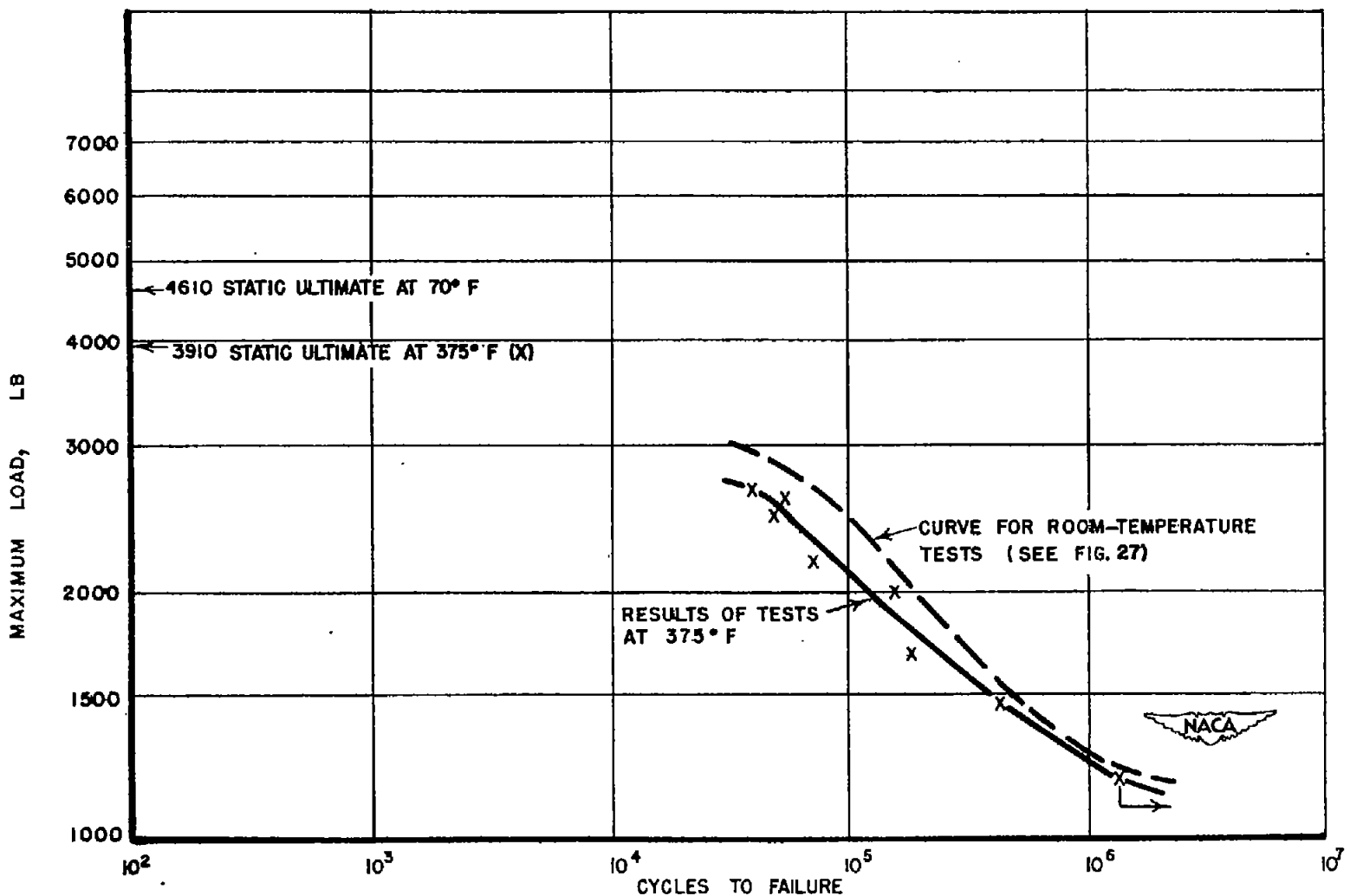

Figure 48.- Results of fatigue tests at 375° F for single-row riveted lap joints of 24S-T Alclad sheet. (R = min. load/max. load = 0.40, in tension.)

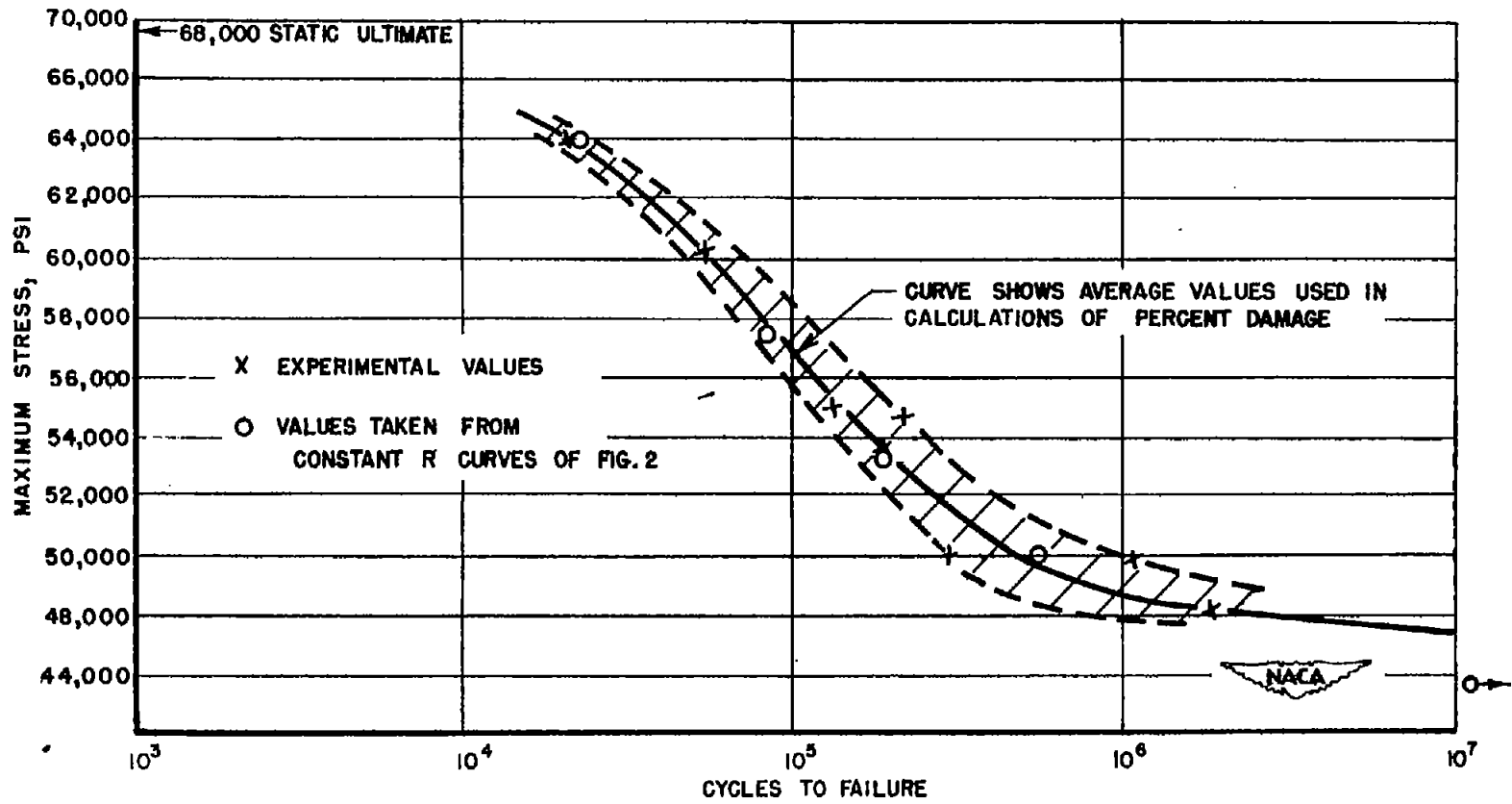

Figure 49.- Scatter band of fatigue strengths of unnotched sheet specimens of 24S-T Alclad tested at a constant mean of 40,000 psi.

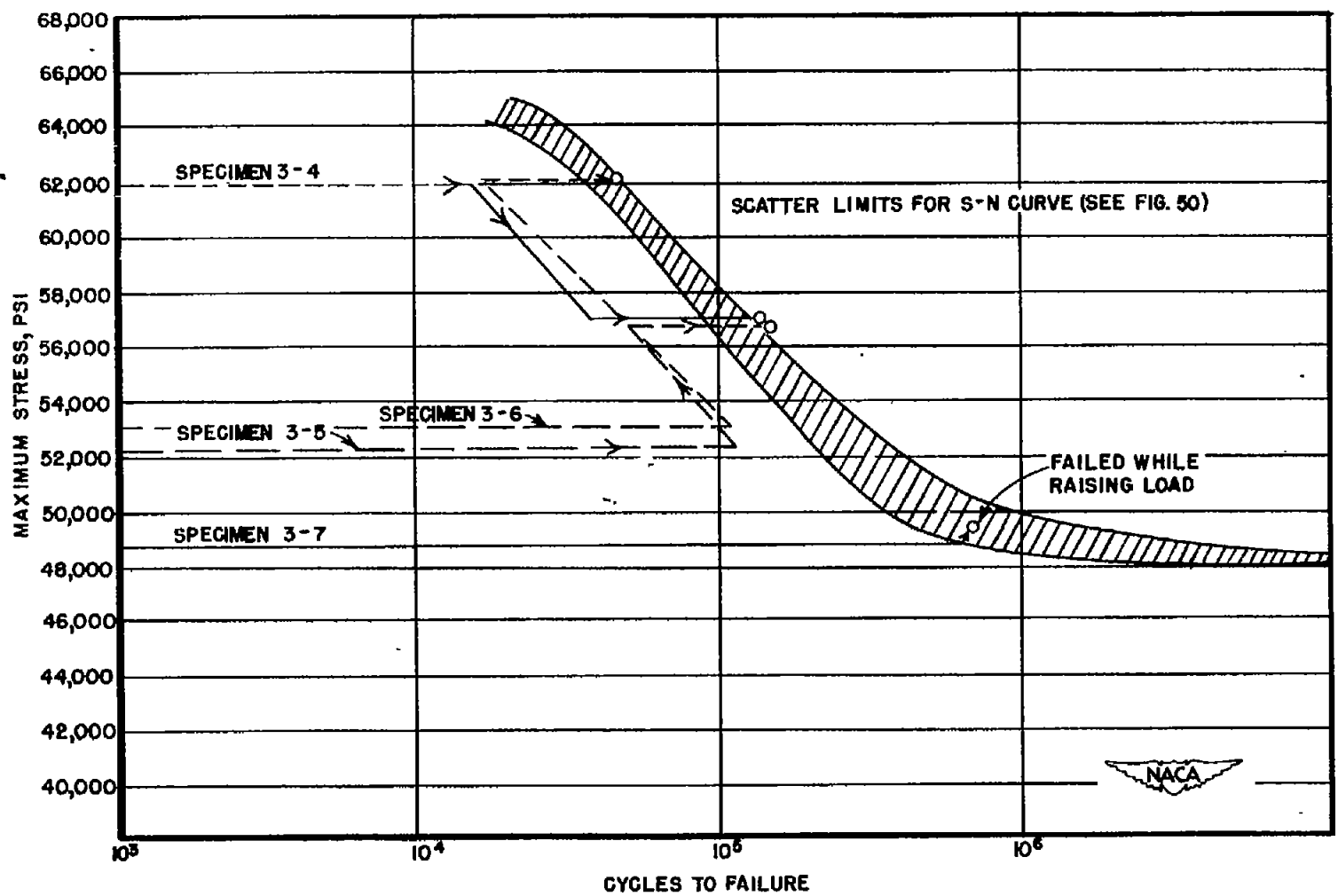

Figure 50.- S-N curves showing results of simple damage tests for specimens of 0.040-inch 24S-T Alclad. All tests at constant mean of 40,000 psi.

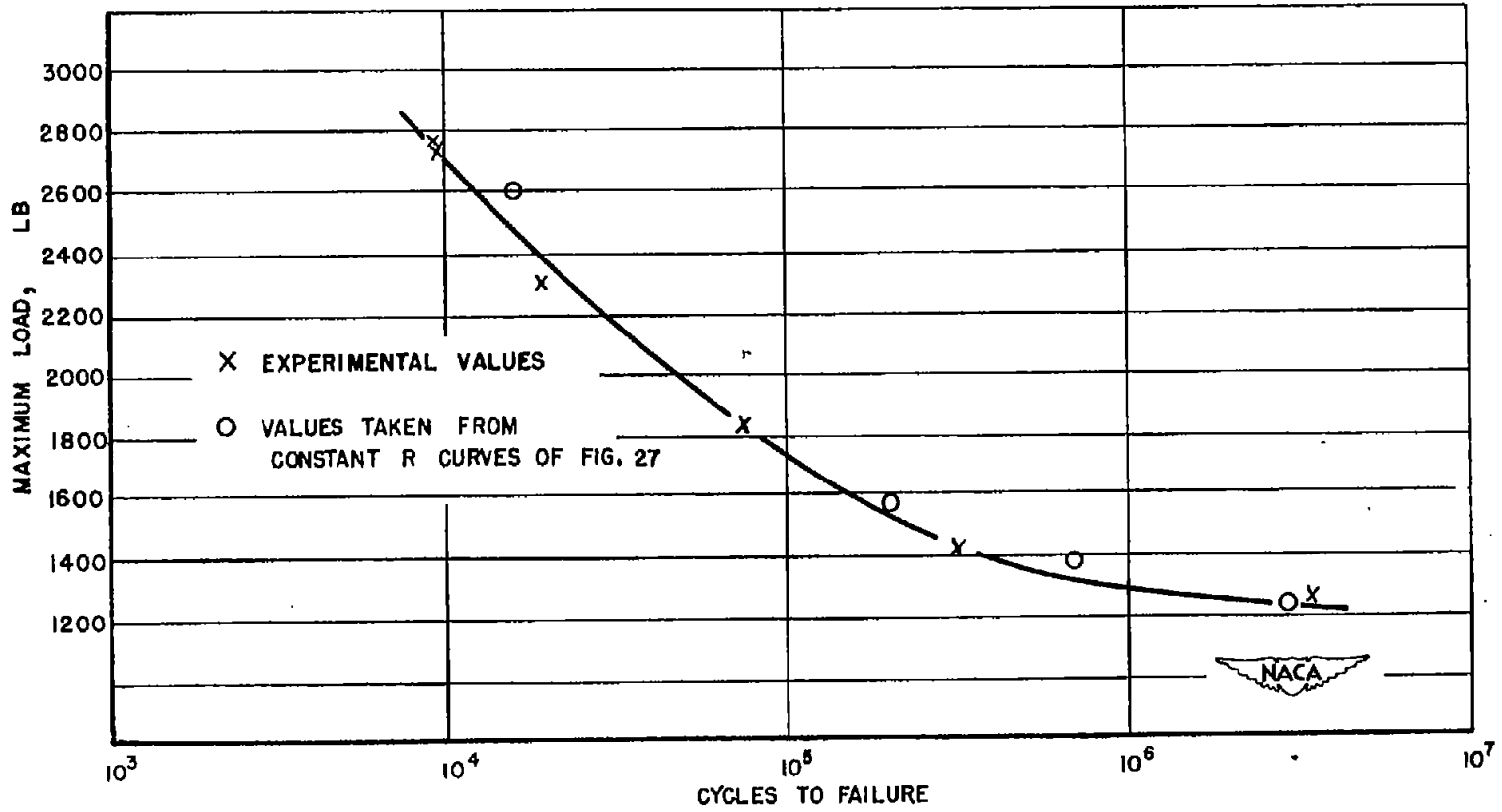

Figure 51.- Constant-mean-load fatigue curve for lap joints of 24S-T Alclad with a single row of flush rivets. Mean load, 975 pounds.

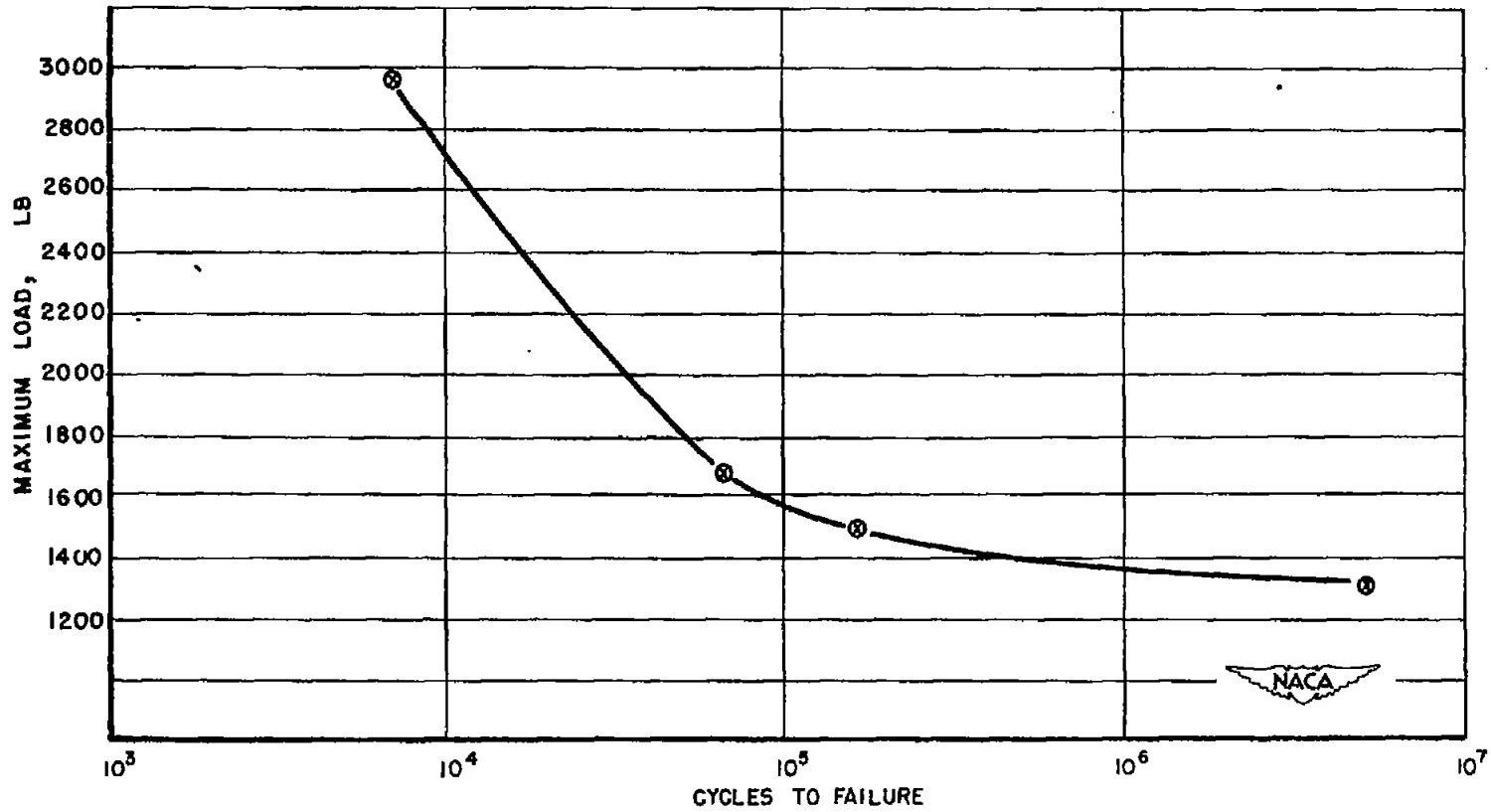

Figure 52.- Constant-mean-load fatigue curve for lap joints of 75S-T Alclad with a single row of flush rivets. Mean load, 1055 pounds. Points taken from constant R curves of figure 28.

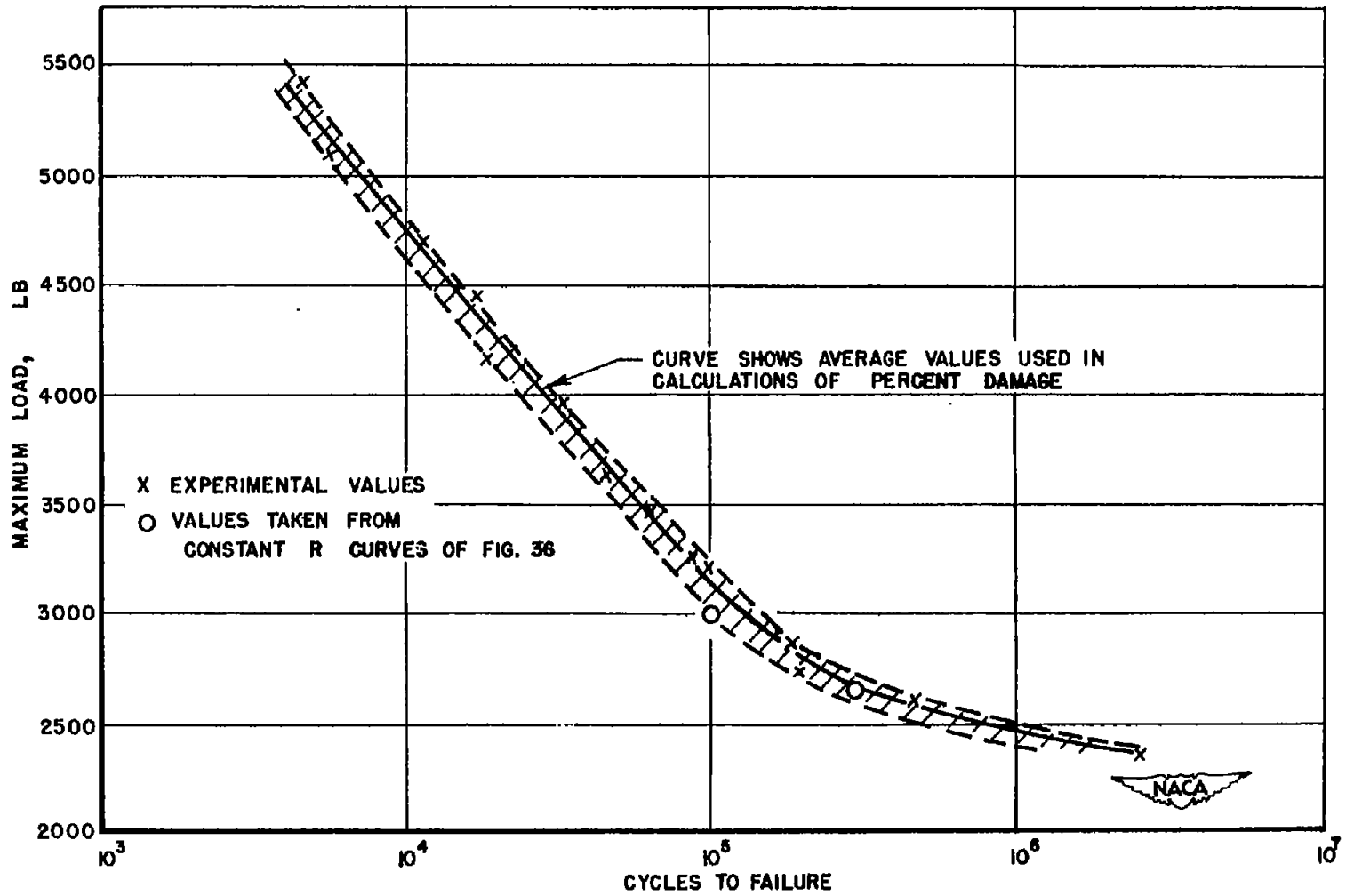

Figure 53.- Scatter band of fatigue strength of lap joints of 24S-T Alclad with two rows of flush rivets. Mean load, 1840 pounds.