

1603

NATIONAL ADVISORY COMMITTEE FOR AERONAUTICS

TECHNICAL NOTE

No. 1603

APPLICATION OF STATISTICAL METHODS TO STUDY
OF GAS-TURBINE BLADE FAILURES

By Charles A. Hoffman and G. Mervin Ault

Flight Propulsion Research Laboratory
Cleveland, Ohio

8115



Washington
June 1948

AFMBC
TECHNICAL LIBRARY
2311

310,59,44



NATIONAL ADVISORY COMMITTEE FOR AERONAUTICS

TECHNICAL NOTE NO. 1603

APPLICATION OF STATISTICAL METHODS TO STUDY
OF GAS-TURBINE BLADE FAILURES

By Charles A. Hoffman and G. Mervin Ault

SUMMARY

An investigation was conducted to determine the applicability of statistical methods as an approach to the evaluation of materials for use in gas turbines by determining the frequency distribution of time until failure of gas-turbine blades. Gas-turbine blades of a cast cobalt-base heat-resistant alloy were run in gas-turbine wheels of approximately $12\frac{1}{2}$ -inch total diameter. The wheels were operated at accelerated-life conditions: a rotor speed of 22,500 rpm and an indicated turbine-inlet-gas temperature of 1850° F.

Two wheels, each incorporating 142 inserted blades of this alloy were tested. In one wheel the entire complement of blades failed. In the other wheel 64 of the blades were failed. The complete frequency distribution of time until blade failure is presented for the first wheel and cumulative frequency curves are presented for both wheels. The blades in the first wheel had an average life of 25.52 hours with a standard deviation of 11.49 hours.

The need for representative performance-life figures as supplied by statistical methods of analysis for use in comparative evaluation and for correlation of performance data with laboratory properties, especially during research and development, is indicated. Use of time for initial failure to evaluate material performance will probably yield results that differ from those obtained by the use of a representative average value.

INTRODUCTION

Gas-turbine cycle efficiency and power output are dependent to a large extent upon the gas temperature used. The maximum allowable temperature is limited by the capacity of the materials, particularly that of highly stressed parts such as turbine blades

to perform satisfactorily for a sufficient period of time to result in a practical over-all economy. Life expectancies of turbine parts currently are short even at relatively low operating temperatures. New materials have been developed and older ones have been improved in an attempt to increase life expectancy. As such materials become available, a comparative indication of their potential performance must be obtained.

Routine laboratory tests are usually applied to newly available materials to rate them upon the basis of stress-rupture strength, creep rate, fatigue life, and other properties. These laboratory-determined properties are valuable in the selection and development of materials in that they furnish a relatively fundamental basis for comparison and study. The data are difficult to apply directly for service use, however, because they fail to indicate the effects of the complex conditions of stress, temperature, and atmosphere that exist in service.

In order to approach service conditions, simulated service tests, simplified to reduce the number of and improve the control of operating variables, are extensively employed for evaluation of materials before use in service applications. The value and the applicability of these data for the manufacturers of turbines and materials increase as the test conditions approach those of the intended application.

The role played by particular laboratory-determined properties with respect to the service life as shown by service and simulated-service operations is important in the selection and the development of new materials. The performance characteristics that limit the life of a material for a particular service application must be known; the material may then be improved in those properties, or another material with better properties may be substituted. The usual method of correlation of properties determined by laboratory evaluation with performance in service is to examine carefully service-failed parts in order to classify the type of failure. If the failure can be attributed to a particular mechanism such as fatigue or stress rupture, a material may be chosen that is suitable in this respect as indicated by laboratory investigation.

Statistical methods of correlation may be used in this analysis. Dr. Bruce S. Old (formerly of the Office of Coordinator of Research and Development, Navy Department), has attempted application of these methods to turbine-blade failures by means of multiple correlation with laboratory properties. Old gathered laboratory and service-type data from a large number of sources comprising several gas turbines

and their materials. The results of this attempted correlation were promising but not entirely satisfactory because of many voids and lack of repetition of important data. Further work in mathematical correlation may lead to increased blade life by supplying information as to which laboratory-determined properties currently correlate with the performance of materials.

Statistical methods may also be applied to the comparative evaluation of materials in the laboratory and in service by applying sampling procedures and by using standard methods for the determination of average performance characteristics and for the indication of reliability of results. Comparative evaluations are not generally based upon statistical sampling procedures at present. General methods of applicable sample analysis and correlation analysis are presented in, among others, references 1 (pp. 1-46), 2 (pp. 82-348, 434-460), and 3 (pp. 74-128).

Investigations were conducted at the NACA Cleveland laboratory to determine the applicability of statistical methods as an approach to the evaluation of materials when formed into a particular service shape and operated at accelerated-life conditions. This investigation is reported herein.

APPARATUS

A unit consisting essentially of a gas turbine and a combustion chamber was used for the quasi-service operation of turbine blades. Figure 1 illustrates the setup.

The combustion air was taken from a central combustion-air supply and was led into the combustion-chamber supply line. The air flowed first through an orifice that was used to measure air flow, then through an air-flow-control valve and into the combustion chamber, where fuel (62-octane gasoline) was sprayed into the combustion air and burned. Fuel flow was measured by a rotameter and controlled by a needle valve. Initial ignition was obtained with a spark plug.

The hot gases flowed from the combustion chamber through an inlet duct, where the static pressure and the temperature were measured, into the turbine case. The turbine-inlet-gas temperature was measured with a shielded chromel-alumel thermocouple at a point $11\frac{1}{2}$ inches upstream of the turbine inlet.

The hot gases passed from the turbine inlet, through the nozzles, past the rotor blades, and then into the exhaust line and into an exhaust system maintained at a pressure slightly below atmospheric.

Rotor speed and turbine inlet-gas temperature were registered on a recording tachometer and recording potentiometer, respectively. The control system was so designed as to require a 5-minute scavenging of the system before the start of combustion in the burner.

The turbine unit was mounted with the axis of rotation horizontal within a water-cooled drum (figure 1(b)). The waste-gate outlet of the turbine was capped. The turbine inlet was connected to the combustion chamber by the inlet duct, which passed through an opening in the side of the drum. A water-jacketed plate was fitted to the front side of the drum and an exhaust line was bolted to this plate. The space comprising the front and back halves of the drum was separated by a steel divider. The back half of the drum was supplied with air to cool the instrumentation and the back side of the turbine.

The over-all diameter of turbine disk and blades was approximately $12\frac{1}{2}$ inches. The blades were fastened by a dovetail arrangement and were secured in the disk slots by peening the bucket-root rolls. Each disk contained 71 long-necked and 71 short-necked blades spaced alternately. Photographs of a long-necked and a short-necked blade are shown in figure 2.

The turbine shaft was not externally loaded.

PROCEDURE

Wheel-and-shaft assemblies were assigned identification numbers in the order used: the first assembly to be operated was called wheel 1; the second, wheel 2. All wheel-and-shaft assemblies were obtained from the Army Air Forces, and, upon receipt, were inspected for external and internal flaws by a fluorescent-oil and a radiographic method, respectively.

Wheel 1, upon receipt, contained blades of the following nominal composition and was operated with these blades:

C	Ni	Fe	Cr	Mo	Co
0.15-0.35	1.75-3.25	0.5-2.0	25.5-29.5	5.0-6.0	Remainder

The original blades contained in wheel 2 were replaced by blades of the same nominal composition as wheel 1 but from a different source. Before these blades were assembled to wheel 2, they were also checked for internal and external flaws by radiographic and fluorescent-oil methods, respectively.

877

The shrouds of the blades of wheel 2 were of greater thickness than those of wheel 1. This difference resulted in greater centrifugal stress for the blades of wheel 2. The blades were installed in the disks, and the wheel-and-shaft assemblies were set into turbines in accordance with applicable Army Air Force technical orders. Before the initial run of the wheel-and-shaft assemblies, the assemblies with their respective rotating components installed were dynamically balanced.

During operation of the unit, the turbine was motored at a rotor speed of approximately 6000 rpm until the time-delay relay in the control circuit permitted the initiation of combustion in the combustion-chamber. This period of operation was designated motor time. Combustion was then started and a rotor speed of 22,500 rpm and a turbine-inlet-gas temperature of 1850° F were attained in about 3 minutes. This period of attaining operating conditions was designated power time.

The turbine was maintained at these conditions until a failure occurred (condition time).. Such an occurrence was immediately apparent, for coincident with the failure the pitch of the sound emitted by the unit changed. Combustion was then terminated, and the wheel speed rapidly fell to about 6000 rpm; the turbine was motored at this speed until it reached room temperature. During condition time, the specified turbine speed was maintained within ± 200 rpm and the specified turbine-inlet-gas temperature, within an indicated $\pm 15^\circ$ F.

Upon blade failure, the turbine was removed from the unit and disassembled. The blades that had failed were removed from the disks in the manner prescribed by applicable Army Air Force technical orders. Replacement blades, new or used, were inserted in the manner previously mentioned. Failure-time data were taken only on the original complement of blades and not on replacement blades. Blade fragments thrown from the wheel occasionally nicked the remaining blades. In no case were the injuries considered of sufficient importance to warrant removal of the nicked blades. Wheels were rebalanced by removing material from the rim of the disk whenever an appreciable amount of unbalance developed.

The appearance of wheel 1 after a total of $28\frac{1}{2}$ hours of power and condition time is shown in figure 3(a). The blade-root portion and fragments from wheel 1 after a total of $28\frac{1}{2}$ hours of power and condition time are shown in figure 3(b). These photographs are

representative of the failures experienced with the exception of one blade that exhibited local necking. The damaged condition of the fragments thrown from the wheel is the result of the impact of the fragments upon the water-cooled drum.

At each overhaul, the condition of each blade was logged. Occurrence of failure, presence and extent of cracking, and presence and extent of stretching were recorded for each blade. In addition, motor time, power time, condition time, and total power and condition time were recorded for each run of each wheel. In addition, photographs of the front and the back of the turbine wheels were taken at each overhaul.

At the inception of the program, severely cracked blades, as well as completely fractured blades were considered as failures, because presumably a severely cracked blade would fail in a short time after the crack was noticed. As a result, fewer shutdowns caused by blade fractures were expected, which would extend operating time and reduce total overhaul time. This practice was subsequently discontinued, however, and only fractured blades were considered failures.

METHODS OF EVALUATING BLADE PERFORMANCE

Several methods exist for the selection of the group of failures to be used for the comparative evaluation of materials that have been operated under simulated service conditions. The time for the first failure is frequently taken as a representation of the performance of a material. For example, if two materials were to be compared for use as turbine blades, two wheels might be assembled, each bladed with one of the materials. The wheels would be operated at the same conditions until blade failure occurred. The time for initial failures of the blades of each material would be noted and used as a basis for comparison. This procedure may be satisfactory for selection of materials for final power-plant rating. For the evaluation of materials during research and development, however, knowledge of the properties of the average blade and of the potential performance of a material are necessary.

A more complete understanding of the behavior of the material may be obtained if the wheels are operated until all blades on each wheel have failed and the failures are considered as a group. Two or more materials may then be compared on a basis representative of the lot, such as average life. The failures can be considered as a frequency distribution by grouping the failures into equal

time intervals and plotting the results in the form of figure 4. The choice of time interval, usually one of convenience, is found by dividing the range of time of failure (difference between longest life and shortest life) by the number of groups desired. Fewer groups are used when the number of failures studied is small.

Any one of several comparative distributions is possible for blades of a material B that is to be evaluated with respect to those of material A of figure 4(a). The dotted curves of figures 4(b), 4(c), and 4(d) illustrate a few of these distributions in order to indicate the possible relations of initial failure to average life in the analysis of turbine-blade failures. The first example (fig. 4(b)) shows a distribution of B that has the same dispersion of failures or deviations from average as A. First failures, represented by the portion of the curve near the origin, as in figure 4(b), would possibly be suitable for comparison of the two, because average properties, near the peak of the curve, show the same absolute differences as initial failures. Figure 4(c) illustrates a distribution of B that has the same average as A but the dispersion is different. Here comparison of time of initial failures would not be representative of average life. Figure 4(d) illustrates distributions that have different dispersions and different averages, both greater, than A. For curve B_1 the difference in initial failures understates the difference in averages; the difference in averages is much greater than the difference in early failures. Qualitatively, however, the initial failures may be indicative of the relative average properties. For curve B_2 , an interpretation obtained from only a consideration of initial failures is opposite that obtained from a consideration of averages.

In addition to these possibilities of misinterpretation of data, numerous other possibilities of error exist if the distributions are unsymmetrical. Initial failures generally are indicative of the relative average blade performance only when the distributions have the same dispersion; yet only absolute differences in initial failure times and average lives are the same. Percentage differences in initial failure times are greater than percentage differences in average lives.

It is evident that the consideration of the complete distribution of material performance or of at least an average property and a term for deviation aids in the comparative evaluation of materials for research and development by supplying an estimation of quantitative differences in average performance. A significant correlation of initial failures in simulated service tests with

laboratory-determined properties would not necessarily be expected, as it would represent an attempt to correlate average properties as determined by laboratory tests to the properties of the worst blades in simulated service tests. Again, to attempt correlation using an average-life property and a term for deviation from service-type tests would be preferable.

The use of the arithmetic mean for expression of central tendency of the distribution is satisfactory. Its only important disadvantage is that it is adversely affected by the occurrence of extreme values, blades of unusually long or short life, and in such cases the results obtained may not be truly representative. Use of the mode also has advantages. By definition the mode is the most frequent value, the maximum ordinate of a smooth distribution curve. The mode is therefore the most typical blade. For accurate determination, an ideal frequency curve of known equation must be fitted to the data and the ordinate corresponding to the maximum must be chosen. If desired, the mode may be roughly approximated by several other methods (reference 2, pp. 125, 487-488, and reference 3, pp. 23-25).

Standard deviation is commonly used as a measurement of dispersion. It is the root mean square of the deviation from the arithmetic mean as defined by

$$\sigma = \sqrt{\frac{\sum(x^2)}{n}}$$

where

σ standard deviation

x individual deviations from arithmetic mean

n total number of items

As a measure of dispersion, one standard deviation of time on both sides of the average life (arithmetic mean) includes approximately 68 percent of the failures; two standard deviations, approximately 95 percent of the failures, and three standard deviations practically all, or 99.7 percent, of the failures (reference 3, p. 38). This approximation holds true for symmetrical or slightly skew distributions. Knowledge of the standard deviation is necessary to permit estimation of lot performance from a small sample.

As stated, the initial plan in this investigation was to replace both fractured blades and severely cracked blades because inspection

of the wheel during initial runs revealed that a few blades were badly cracked (figure 3(a)). The assumption was therefore made that these cracked blades would fail very soon and removal of blades which had cracks longer than half the blade width would speed the program by lengthening the interval between wheel removals. The criterion of failure of the material was therefore considered to be fracture or severe cracking. The number of failures recorded during a given time period was the total of all replaced. Operation in this manner was found to allow periods of operation as long as 5.4 hours without shutdown for overhaul. At shutdown as many as nine fractured blades and as many as 13 cracked blades were replaced. The use of these data in the plotting of distribution curves was found to be difficult. The time interval chosen for plotting the frequency-distribution curve was necessarily large because the length of time between shutdowns was very large. The use of time intervals less than the length of time between shutdowns occasionally resulted in time intervals with a frequency of zero. An unsuccessful attempt was made to adjust the data of the cracked blades to approach more closely their actual fracture times. The data of the completely fractured blades were studied to determine the average time elapsed between a severe crack and a complete fracture, but these elapsed times had a very wide range and a reliable correction factor could not be determined. In addition, the exact time when a given amount of cracking occurred was impossible to determine.

Because of difficulties in handling the adjustment of cracked blades removed, the procedure was so changed after 28.3 hours and 103 failures for wheel 1 and 7.7 hours and 32 failures for wheel 2 that only fractured blades were replaced. The criterion for failure was then fractured blades. With this method, the time of failure was certain. From the failures of the remaining blades, an attempt was made to approximate failure life of the cracked blades that had been removed so that the time for failure could be adjusted in the plotting of a frequency-distribution curve. The data were found to be insufficient to allow adjustment; therefore, the time of replacement of cracked blades was considered the time for failure and they were then treated in the same manner as fractured blades.

RESULTS AND DISCUSSION

Wheel 1. - The failures for wheels 1 and 2 are summarized in tables I and II, respectively. The blade failures experienced appeared to be of the stress-rupture type, in combination with other effects. The distribution of blade failures for wheel 1 are shown in figure 5. The abscissa is the total of power and condition times

because occasionally a blade failure occurred during the approach to test conditions. To consider only condition time would suggest that blade failure had occurred without the application of additional time at stress (zero time at test conditions). In plotting the results, the time interval of 5 hours beginning at 1, 6, and 11 hours etc. was arbitrarily chosen. At the conditions used, the average life (mean) for the blades of wheel 1 was 25.52 hours with a standard deviation of 11.49 hours. Reference 2 (p. 125) gives an empirical relation whereby the mode may be roughly approximated. It is expressed by the equation

$$\text{mode} = \text{mean} - 3 (\text{mean} - \text{median})$$

The median is the life of the middle most blade of the 142 investigated, that is, the life of the 71st or 72nd blade failed. The median was 25.53 hours. By substitution into the equation, the mode for wheel 1 was found to be about 25.55 hours. The insignificance of the difference (0.03 hr) between the mean and the mode indicates that the distribution is effectively a normal one.

The deviation is great, which indicates considerable differences in the performance of the individual blades. These differences apparently may result from dimensional differences among the blades that cause a wide variation in stress. An exploration of the possible dimensional differences in the blades of this wheel yielded no data that could be significantly correlated to explain the large range in blade life, which indicates that this effect was of secondary importance. Possibly the large deviation may be explained by the presence of minute faults in the blade material - faults too small to be resolved by the usual inspection methods. Although a radiographic inspection method is used for detection of internal flaws and a fluorescent-oil method for external cracks, the size of the flaws detected is limited by the resolving power of the inspection equipment. Considerable improvement in blade performance could probably be made by reducing the dispersion of failure times by the use of better inspection techniques and improved processing. The existence of blades with a life of 70 hours, as shown at the upper end of the distribution curve, suggests this life as a goal for the blades of wheel 1 that may be reached by preliminary elimination and improvement of the blades that fail early.

Comparison of wheels 1 and 2. - Wheel 2 was included to present data for comparison with wheel 1. Obviously, if the blade lives of wheels 1 and 2 were to be compared on the basis of time for initial failure, an incorrect conclusion would result as to what the average performance might be. The first blade failure of

877

wheel 1 occurred after 3.92 hours and the first of wheel 2 after 5.59 hours. If the wheels are compared on this basis, the probable life of wheel 2 is indicated as being 43 percent greater than that of wheel 1. The error in this conclusion may be seen by comparing the materials by means of a cumulative-frequency curve (fig. 6), which is a plot of total blades surviving against running time. The life of the average blade of wheel 2 is suggested as less than that of wheel 1, contrary to the analysis suggested by consideration only of initial failures. Although the blades in wheel 2 had heavier shrouds and consequently were more highly stressed, the time of initial failure of the wheel was greater than that of wheel 1, and the possible error resulting from the use of initial failure is thereby emphasized.

Evaluation of methods. - The use of distribution curves to study blade failures can be of great value. First, they clearly define the performance of the average blade. If an unusually wide dispersion exists excessive latitude in dimensional tolerances or need of improvement in production control is indicated. In addition, the deviation to the right suggests a goal, or the potentiality of the material, that may be achieved if causes of early failures can be determined and eliminated.

The operation of a wheel until all the blades have failed is expensive. If in any particular investigation a great many blades are found to fracture soon after cracking, thus causing frequent shutdowns for overhaul, or if cracking is to be considered failure, operating time probably may safely be reduced by replacing the cracked blades when the unit is shut down for replacement of fractures blades. The unit should be stopped at regular intervals and the wheel inspected for the presence of cracked blades. The approximate time of cracking will then be determined. The length of time between shutdowns for inspections should be determined by the scatter of failures. For a wheel showing a relatively wide scatter of blade failures, such as wheel 1, a greater time interval between inspection shutdowns could be chosen than for a wheel exhibiting a narrow range of scatter of failures, like wheel 2. If the average life of the material is desired, every blade on the wheel must be failed, as each one failed increases the average life of the total failed.

The cost of obtaining the average life for material evaluation and correlation may be reduced by using a much smaller sample than the 142 blades used in wheel 1. For example, one wheel may have blades of several materials. The number of materials that may be tested on one wheel is dependent upon the size of the sample desired

for each material. The choice of sample size is dependent upon how reliable an average is desired and the expected deviation of the distribution. In order to obtain the same reliability of the average, a smaller sample would be required of a material exhibiting a relatively narrow scatter, such as suggested by the cumulative frequency-distribution curve for wheel 2, than for a material exhibiting a wide scatter such as that of wheel 1. When using several materials on one wheel, failure of each blade on the wheel would still be necessary but failure of all the blades would result in simultaneous data for several materials. The reliability of the average computed from the data for each sample can be estimated by standard statistical procedures, which involves the use of "t" tables (reference 1, pp. 14-33, reference 2, 434-443, and reference 3, 113-128). If more data are found necessary for a particular material, another sample may be run along with several other materials on a new wheel.

If some material is chosen as a standard and it is desired merely to determine whether some other materials are better than the standard as far as average life is concerned, methods of sequential analysis may be applied with a further saving in operating time.

CONCLUSIONS

A study of statistical methods and an analysis of the results of bucket-failure investigation indicates that:

1. The time for first failure may not in general be taken as an accurate indication of the performance of the average blade.
2. A need exists for representative performance-life values as supplied by statistical methods of analysis for use in comparative evaluation and correlation, especially during research and development, to avoid the errors that may result from consideration of initial failures only or by the use of too few tests.
3. The use of better inspection techniques and improved processing may narrow wide distributions and increase life expectancies. Research on methods of improving the life of the first blade to fail is needed.

Flight Propulsion Research Laboratory,
National Advisory Committee for Aeronautics,
Cleveland, Ohio, December 14, 1947.

REFERENCES

1. Ezekiel, Mordecai: Methods of Correlation Analysis. John Wiley and Sons, Inc., 2d ed., 1945.
2. Yule, G. Udny, and Kendall, M. G.: An Introduction to the Theory of Statistics. Charles Griffin and Co., Ltd., 12th ed., 1940.
3. Arkin, Herbert, and Colton, Raymond R.; An Outline of Statistical Methods. Barnes and Noble, Inc., 4th ed., 1939.

877

TABLE I - SUMMARY OF BLADE FAILURES FOR WHEEL 1

Run	Power plus condition time (hr)	Cumulative total of power plus condition time (hr)	Blades replaced			
			Fractured	Cracked	Total	Cumulative total
1	3.92	3.92	1	0	1	1
2	4.17	8.09	1	1	2	3
3	.13	8.22	2	1	3	6
4	.18	8.40	1	1	2	8
5	2.63	11.03	1	1	2	19
6	.78	11.81	1	1	2	19
7	.70	12.51	2	0	2	21
8	3.84	16.35	8	2	10	31
9	.15	16.50	1	11	12	43
10	5.38	21.88	10	9	19	62
11	3.42	25.53	9	7	16	78
12	2.20	27.73	13	8	21	99
13	.54	28.27	3	1	4	103
14	.26	28.53	1		1	104
15	.77	29.30	1		1	105
16	.35	29.65	1		1	106
17	1.32	30.97	2		2	108
18	.15	31.12	4		4	112
19	1.25	32.37	2		2	114
20	.73	33.10	4		4	118
21	1.43	34.53	3		3	121
22	1.02	35.55	1		1	122
23	2.73	37.28	2		2	124
24	.45	37.73	1		1	125
25	1.78	39.53	1		1	126
26	1.53	41.05	3		3	129
27	.22	41.27	1		1	130
28	.15	41.42	1		1	131
29	1.90	43.32	1		1	132
30	.53	43.85	2		2	134
31	1.37	45.22	2		2	136
32	.10	45.32	1		1	137
33	.55	45.87	1		1	138
34	3.31	49.18	1		1	139
35	13.29	61.47	1		1	140
36	9.35	70.82	1		1	141
37	1.20	72.02	1		1	142

877



TABLE II - SUMMARY OF BLADE FAILURES FOR WHEEL 2

Run	Power plus condition time (hr)	Cumulative total of power plus condition time (hr)	Blades replaced			
			Fractured	Cracked	Total	Cumulative total
1	5.59	5.59	1	0	1	1
2	.23	5.82	1	0	1	2
3	.11	5.93	1	1	2	4
4	.10	6.03	1	0	1	5
5	.09	6.12	2	0	2	7
6	.12	6.24	1	0	1	8
7	.09	6.33	1	0	1	9
8	.07	6.40	2	0	2	11
9	.20	6.60	4	0	4	15
10	.11	6.77	1	0	1	16
11	.11	6.77	1	0	1	17
12	.12	6.89	2	0	2	19
13	.22	7.11	1	4	5	24
14	.20	7.31	1	3	4	28
15	.12	7.43	1	0	1	29
16	.15	7.58	1	0	1	30
17	.10	7.68	1	1	2	32
18	.05	7.73	1		1	33
19	.22	7.95	11		11	44
20	.07	8.03	1		1	45
21	.09	8.12	2		2	47
22	.10	8.28	1		1	48
23	.05	8.27	2		2	50
24	.10	8.37	1		1	51
25	.07	8.52	1		1	52
26	.06	8.58	1		1	53
27	.14	8.72	2		2	55
28	.06	8.78	1		1	56
29	.10	8.88	1		1	57
30	.05	8.93	1		1	58
31	.10	9.03	2		2	60
32	.07	9.10	1		1	61
33	.10	9.20	1		1	62
34	.10	9.37	1		1	63
35	.05	9.42	1		1	64



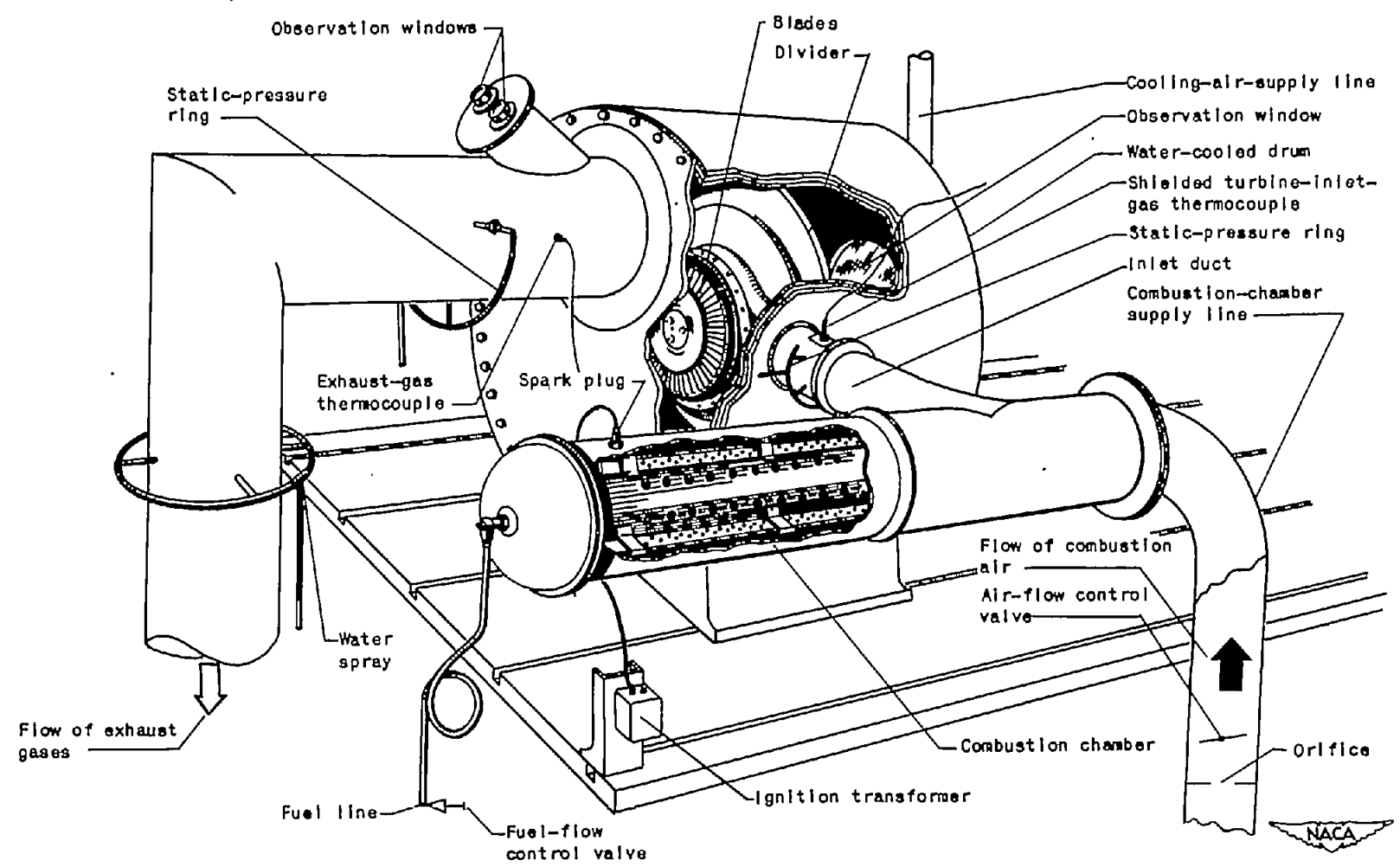

(a) Schematic diagram, side view.
 Figure 1. - Setup for turbine-blade-failure investigation.

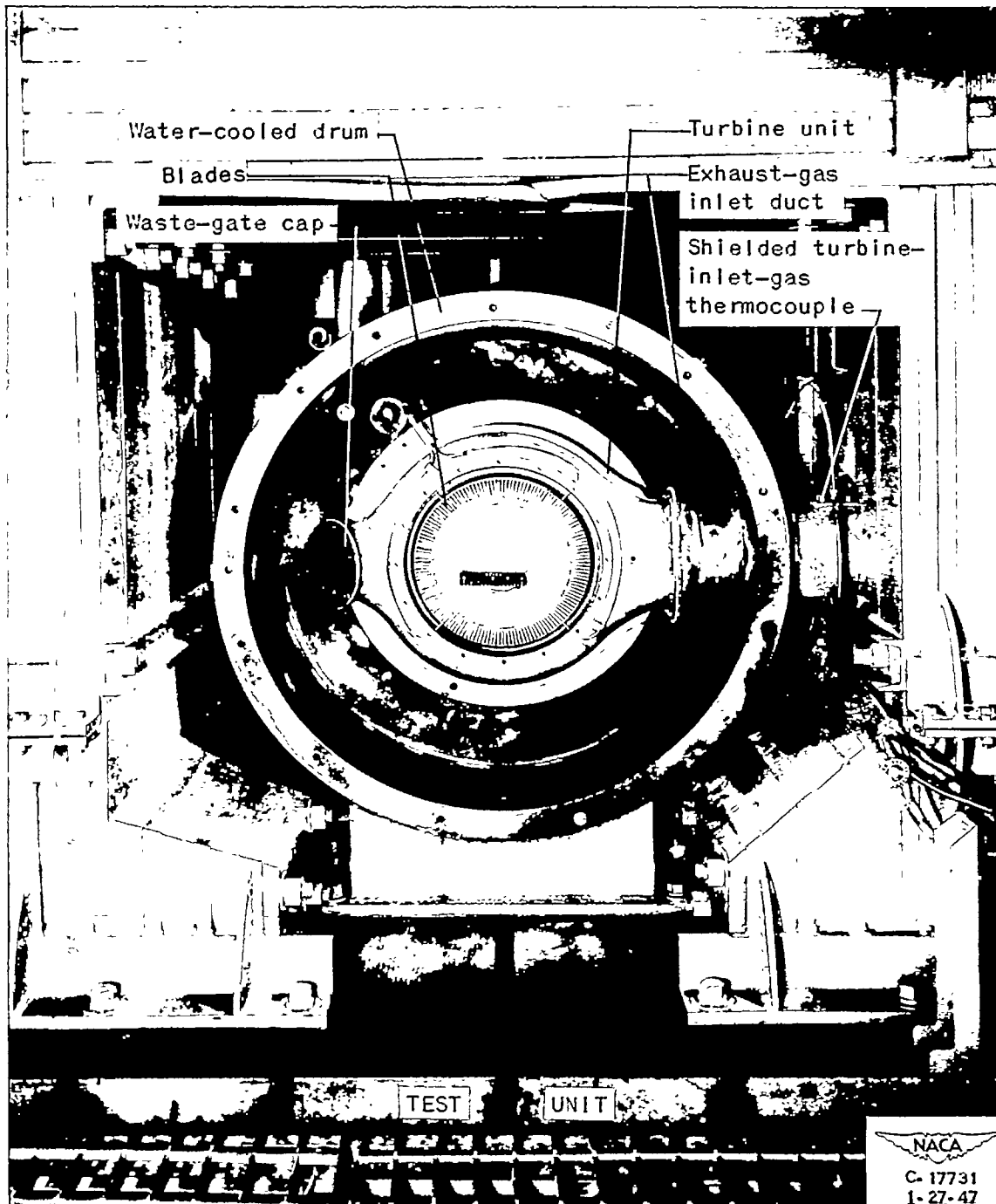

(b) Photograph, front view.

Figure 1. - Concluded. Setup for turbine-blade-failure investigation.

877

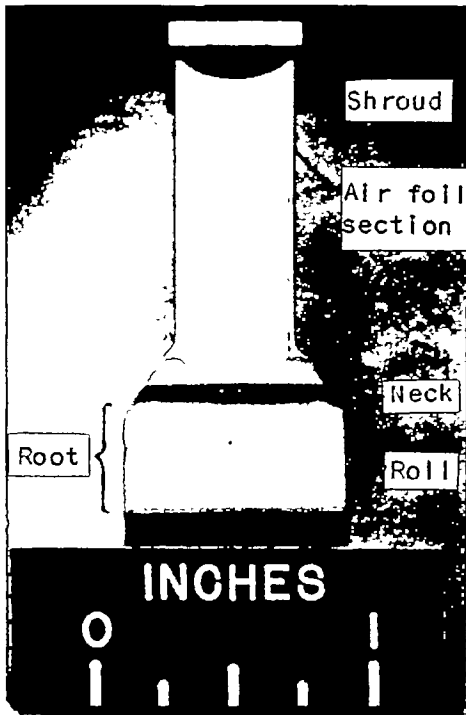

(a) Long-necked turbine blade, front view.

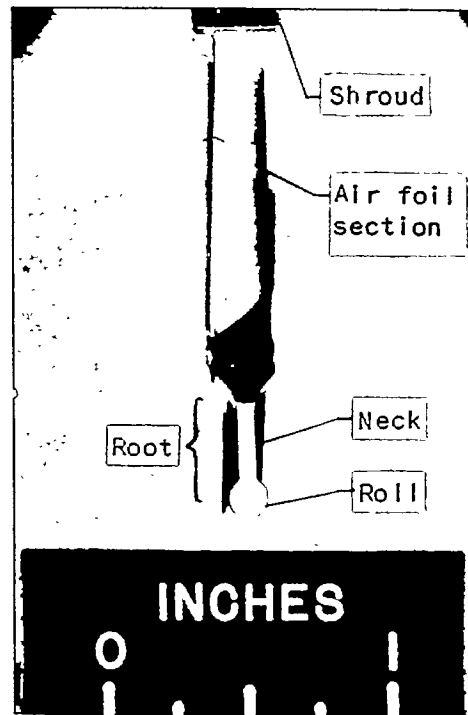

(b) Long-necked turbine blade, side view.

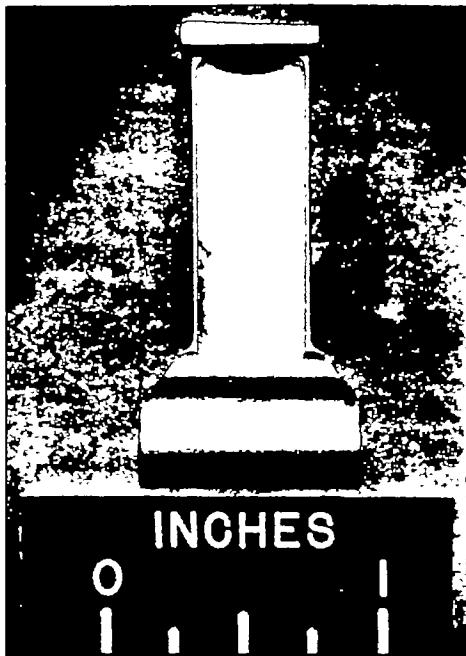

(c) Short-necked turbine blade, front view.

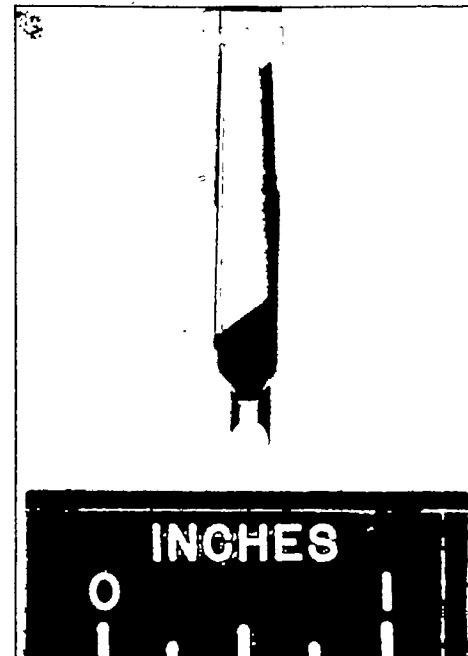

(d) Short-necked turbine blade, side view.

NACA
C-18398
4-25-47

Figure 2. - Typical gas-turbine blades used in investigation, shown as received.

877

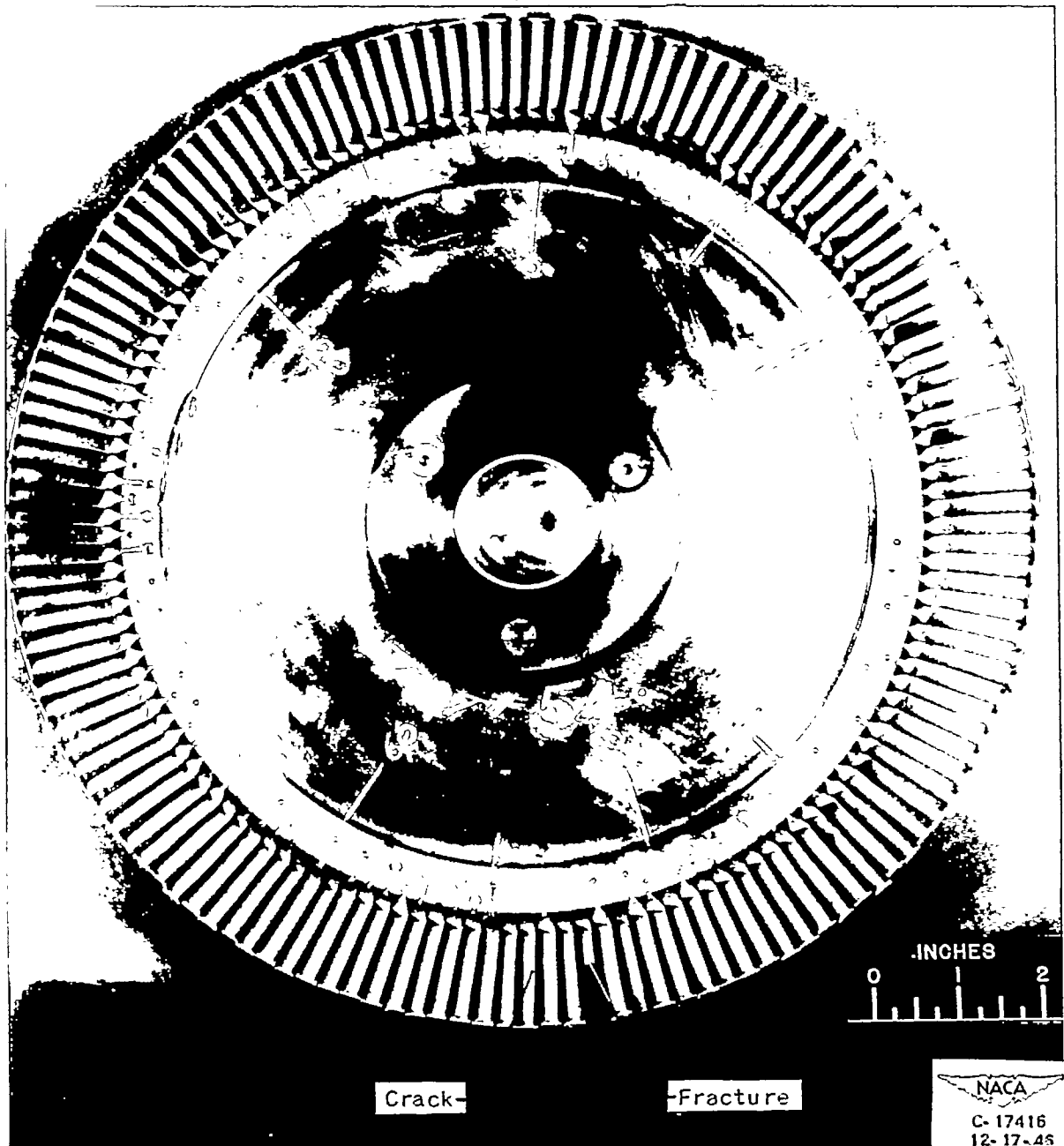

(a) Turbine wheel showing cracked and fractured blades.

Figure 3. -- Damage to blades of wheel 1 after $28\frac{1}{2}$ hours of power and condition time.

877

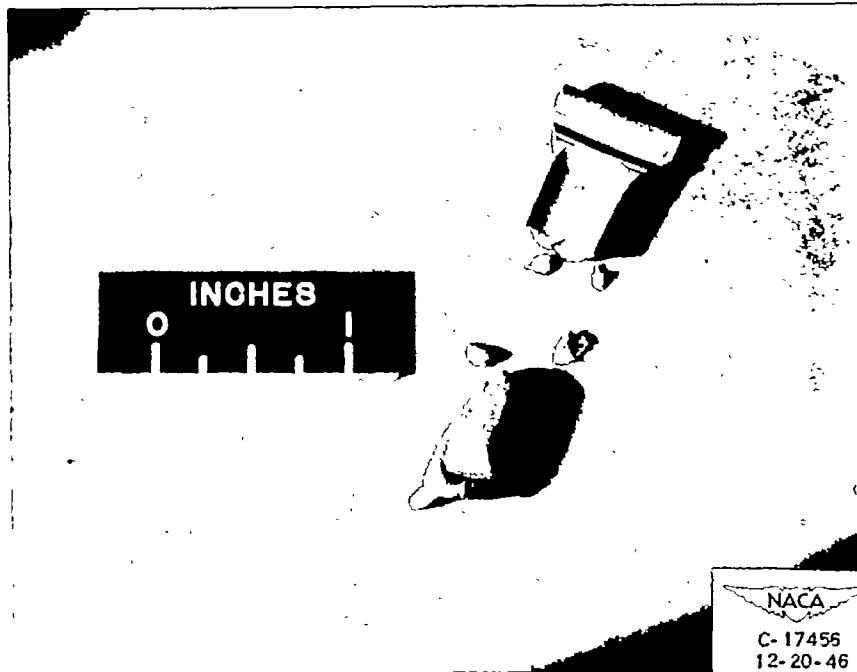

(b) Fragments of fractured blades.

Figure 3. - Concluded. Damage to blades of wheel 1 after $28\frac{1}{2}$ hours of power and condition time.

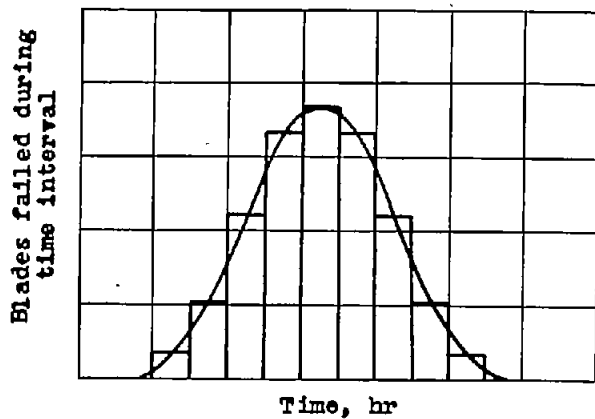

(a) Sample frequency distribution of material A.

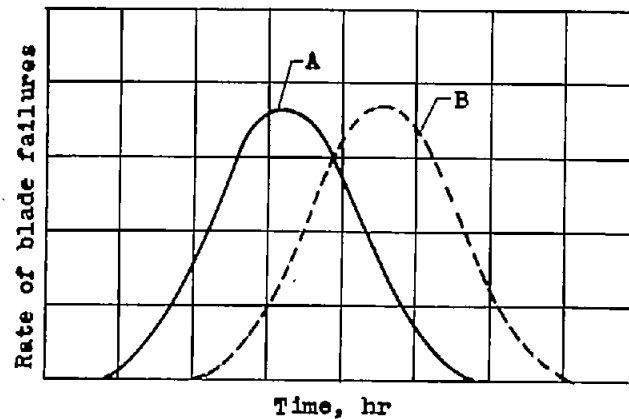

(b) Initial failures representative of average lives for materials A and B.

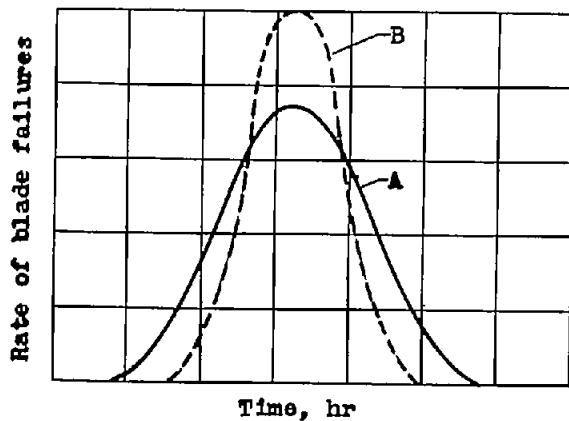

(c) Initial failures not representative of average lives because of different dispersions for materials A and B.

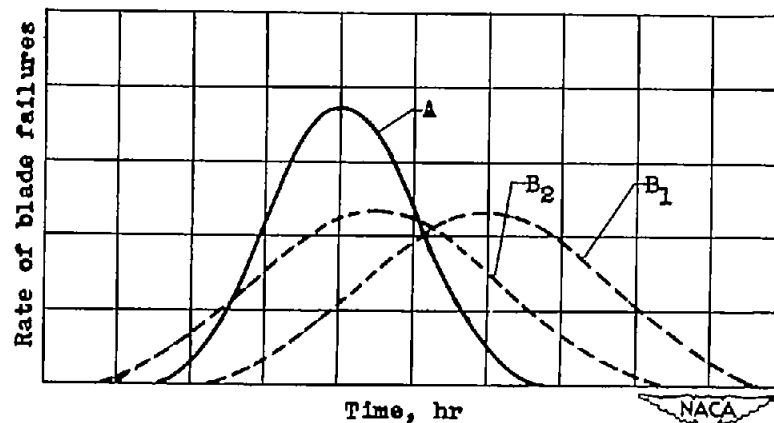

(d) Initial failures not representative of average lives because of different dispersions and different averages for materials A, B₁, and B₂.

Figure 4. - Possible relations of time for initial failure to average life.

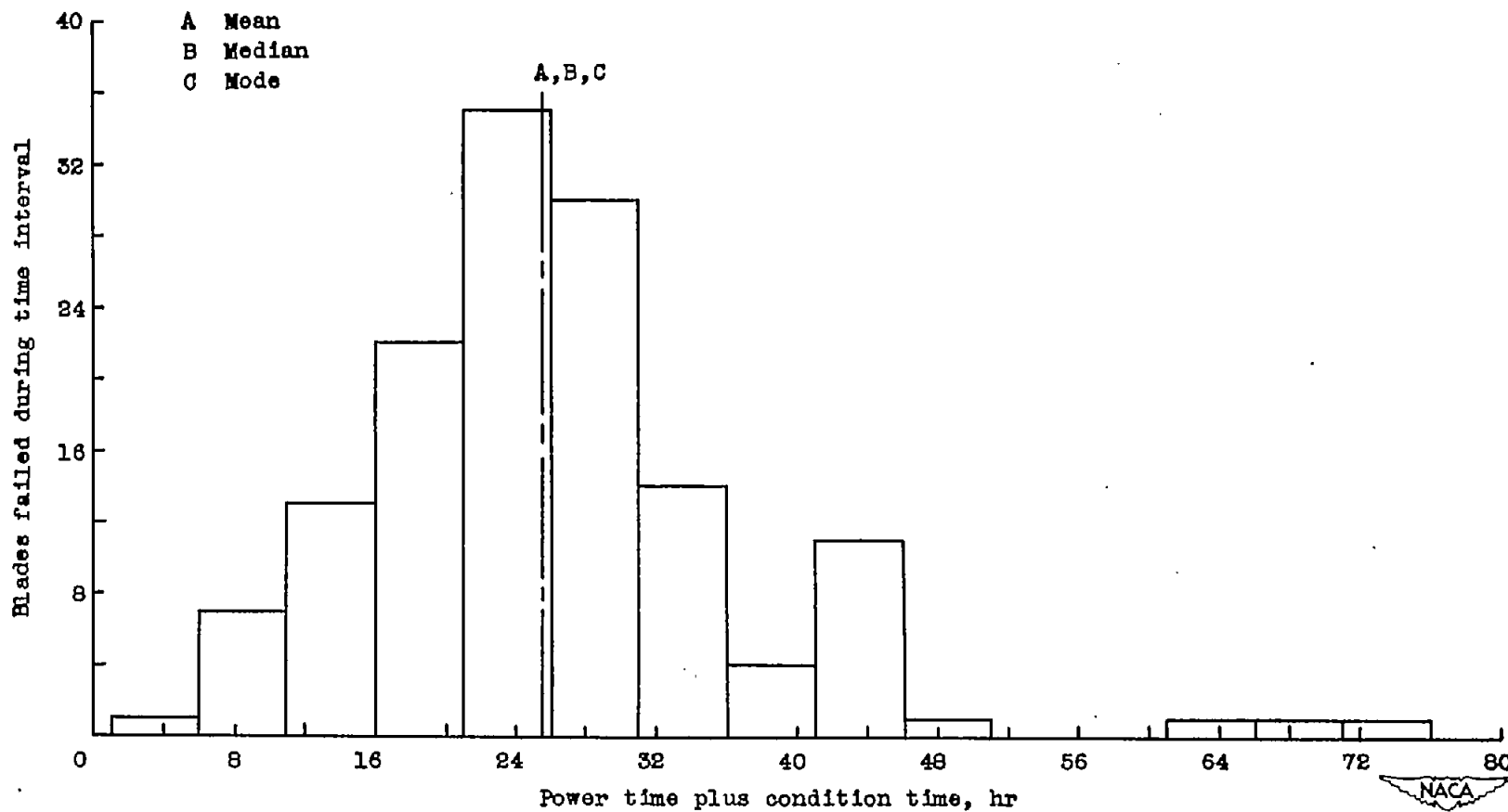

Figure 5. - Distribution of time to blade failure for wheel 1.



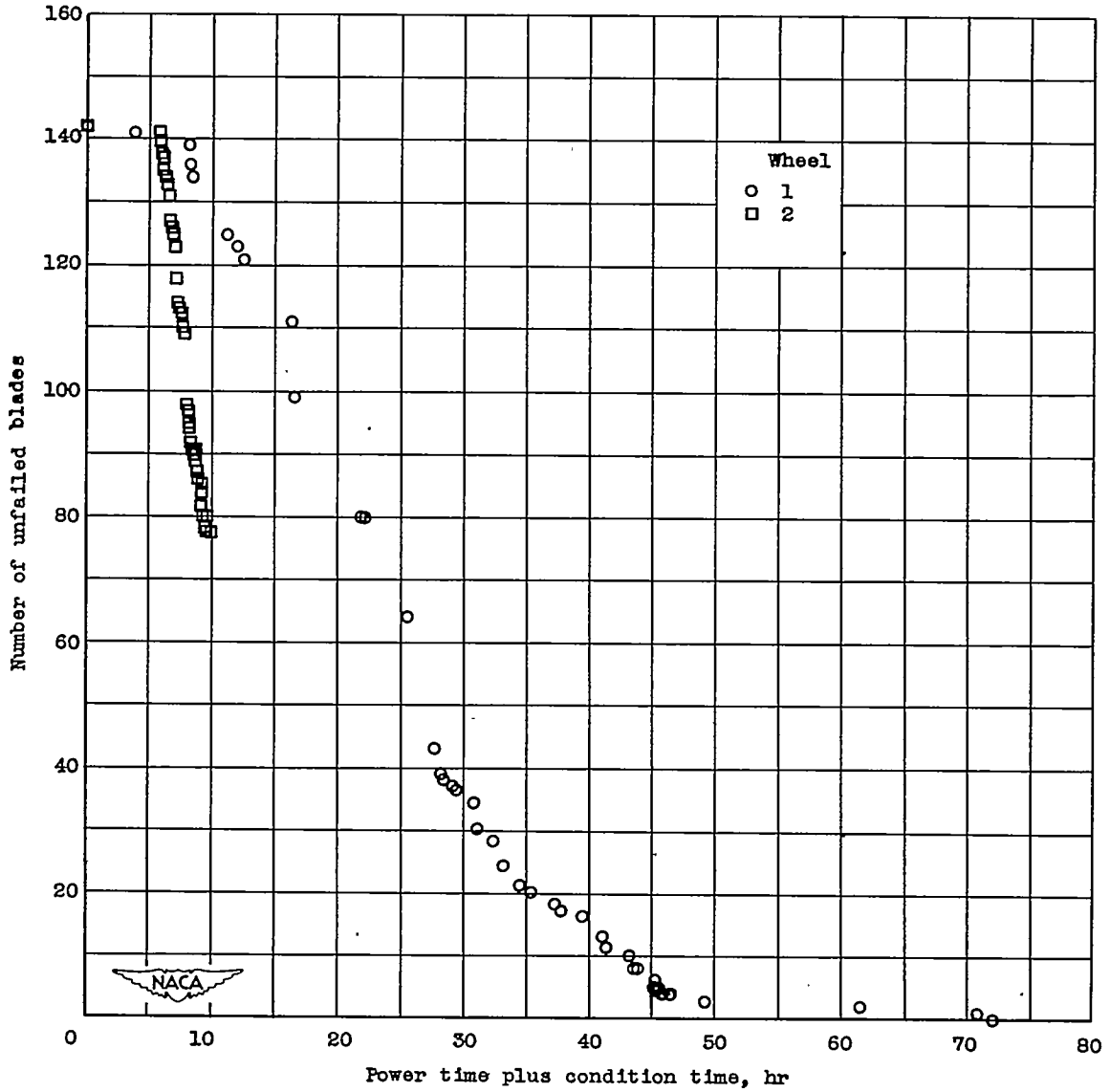

Figure 6. - Cumulative-frequency curves of time for blade failures.