

9168

NACA TN 2530

0065474



# NATIONAL ADVISORY COMMITTEE FOR AERONAUTICS

TECHNICAL NOTE 2530

WIND-TUNNEL INVESTIGATION OF SIX SHIELDED TOTAL-PRESSURE  
TUBES AT HIGH ANGLES OF ATTACK

SUBSONIC SPEEDS

By Walter R. Russell, William Gracey, William Letko,  
and Paul G. Fournier

Langley Aeronautical Laboratory  
Langley Field, Va.



Washington  
November 1951

AFMFC  
TECHNICAL LIBRARY  
AFL 2811

TECHNICAL NOTE 2530

WIND-TUNNEL INVESTIGATION OF SIX SHIELDED TOTAL-PRESSURE  
TUBES AT HIGH ANGLES OF ATTACK

SUBSONIC SPEEDS

By Walter R. Russell, William Gracey, William Letko,  
and Paul G. Fournier

SUMMARY

The effect of inclination of the air stream on the measured pressures of six shielded total-pressure tubes (all designed for end-mounting on a horizontal boom) has been determined for an angle-of-attack range of approximately  $-30^{\circ}$  to  $65^{\circ}$ . The tests were conducted at a Mach number of 0.26 in the Langley stability tunnel and at Mach numbers of 0.50, 0.70, 0.90, and 0.95 in the Langley high-speed 7- by 10-foot tunnel.

The results of the tests showed that curved venturi entries are less sensitive to inclination of the air stream than the conical entry of the standard Kiel design. Of the three curved entries tested, the tube having the bluntest entry proved the least sensitive to inclination. The critical angle (that is, the angle at which the total-pressure error equals 1 percent of the impact pressure) for this tube was  $\pm 63.2^{\circ}$  at a Mach number of 0.26.

The tests also showed that the critical angle of a shielded tube could be extended to higher positive angles of attack by means of a slant profile. The critical angle of a tube having a conical entry with a  $10^{\circ}$  slant profile, for example, was found to average  $9^{\circ}$  greater than that of a similar tube having a square profile. Although the critical angle of this tube at angles of yaw was less than that at angles of attack, the critical angle in yaw was equal to that of the tube with the square profile.

Tests of the effect of varying the position of the total-pressure probe in the shield showed that, in general, no advantage was to be gained by changing from the position used in the standard Kiel design. Limited tests of the effect of varying the internal diameter of the shield

showed that an increase in the diameter of the throat corresponding to an increase in the internal area of 50 percent resulted in a relatively small increase ( $2.5^{\circ}$ ) in the critical angle.

The effect of Mach number on the sensitivity of the tubes to inclination was shown to be appreciable. An increase in Mach number from 0.26 to 0.90, for example, resulted in a decrease in the critical angle of most of the tubes of about  $4^{\circ}$ .

## INTRODUCTION

The National Advisory Committee for Aeronautics is conducting a series of wind-tunnel investigations to determine the effect of inclination of the air stream on the measured pressures of a number of total-pressure tubes through a wide range of angle of attack in both the subsonic and supersonic speed ranges. These investigations are being conducted for the purpose of providing fixed or rigid total-pressure tubes for use on present-day high-performance airplanes having the capability of maneuvering to high angles of attack at supersonic speeds. In a previous paper (reference 1) the results of tests of 39 total-pressure tubes through an angle-of-attack range of  $\pm 45^{\circ}$  at subsonic speeds were presented. A subsequent paper (reference 2) presented the calibrations of 20 of these tubes at supersonic speeds.

The results of these tests indicated that the tube which remained insensitive to inclination of the air stream over the greatest range of angle of attack was a shielded total-pressure tube (Kiel type) designed for end-mounting on a horizontal boom. This tube remained insensitive (to within 1 percent of the impact pressure) over an angle-of-attack range of  $\pm 41.5^{\circ}$  at subsonic speeds and  $\pm 37^{\circ}$  at supersonic speeds. Other tests (reference 3) on small-scale shielded total-pressure tubes designed for engine and duct survey work indicated that a significant increase in the range of insensitivity could be achieved by the use of a curved rather than a conical venturi entry of the Kiel design (described in reference 4).

As a means of determining the effectiveness of the curved entry on a tube of the size suitable for airspeed measurements and, at the same time, determining the effect of varying other pertinent dimensions of the Kiel design, additional wind-tunnel tests have been conducted on a number of different configurations of the shielded total-pressure tube.

This paper presents the results of the tests of these tubes at several Mach numbers ranging from 0.26 to 0.95.

SYMBOLS

D	outside diameter of shield
d	inside diameter of shield
a	distance from leading edge of probe to leading edge of shield
H	total pressure of free stream
H'	total pressure measured by tube
$\Delta H$	total-pressure error ( $H' - H$ )
$q_c$	free-stream impact pressure
M	free-stream Mach number
$\alpha$	angle of attack of total-pressure tube, degrees
$\psi$	angle of yaw of total-pressure tube, degrees
$\alpha_{cr}$	angle of attack at which $\frac{\Delta H}{q_c} = 0.01$
$\psi_{cr}$	angle of yaw at which $\frac{\Delta H}{q_c} = 0.01$

APPARATUS AND TESTS

Six shielded total-pressure tubes designed for end-mounting on a horizontal boom were tested during this investigation. Design details and dimensions of tube 1-a, the design of which was based on the Kiel shielded total-pressure tube (reference 4), are given in figure 1. Pertinent details and dimensions of tube 1-a, as well as of the other tubes, are given in table I and in the calibration charts at the end of the paper. In addition, enlarged sections of the various shield entries are presented in figure 2 for comparison purposes.

The calibration curves for tube 1-a were used as a basis for comparing the effects of changing various design features. The design features which were investigated include the shape of the shield entry, the position of the total-pressure probe relative to the leading edge of the shield, the inside diameter of the shield, and the shape of the profile of the shield. The vent area of all the tubes tested was 1.5 times the frontal area and the outside diameter was 1 inch.

The tests were conducted at  $M = 0.26$  in the 6- by 6-foot test section of the Langley stability tunnel and at  $M = 0.50, 0.70, 0.90,$  and  $0.95$  in the Langley high-speed 7- by 10-foot tunnel.

The tube support used in the stability-tunnel investigation was a U-tube swivel mechanism (fig. 3) mounted on the side wall of the tunnel. This support was designed with the axis of rotation of the swivel arm in line with the leading edge of the total-pressure tube so that the total-pressure entry would remain at the same point in the air stream for all angles of attack. Possible errors caused by deflection of the support mechanism were investigated and were found to be negligible.

The tubes were tested at a Mach number of  $0.26$  through an angular range of  $-30^\circ$  to  $65^\circ$  in  $5^\circ$  increments. For each setting of the tube the total-pressure error was determined by measuring the pressure difference between the test tube and a fixed pitot-static tube mounted on the opposite side of the tunnel. The accuracy of the measurements of  $\Delta H/q_c$  was estimated to be within  $\pm 0.002$ .

In the Langley high-speed 7- by 10-foot tunnel the total-pressure tubes were mounted on a sting which was supported by a vertical strut in the diffuser section of the tunnel (fig. 4). The angle of attack was varied by a combined rotation and translation of the sting on the strut as shown in figure 4. The motion of the sting was such that the leading edge of the total-pressure tube remained at approximately the same point in the tunnel cross section for all angles of attack. The angular range of the sting was approximately  $\pm 13^\circ$ . In order to shift this range to higher angles of attack, couplings were inserted in the sting (fig. 4). Since the total-pressure error of the tubes was shown by the stability-tunnel tests to be negligible to within a few degrees of the critical angle, the tests in the 7- by 10-foot tunnel were restricted to a small angular range around the critical angles as determined by the stability-tunnel tests. The angle of attack was varied in  $5^\circ$  increments throughout the test range. In some cases readings at intermediate angles were also taken.

The Mach numbers at which the various tubes were tested in the 7- by 10-foot tunnel are given in table I. At each Mach number and angular setting, the total-pressure error was determined as the difference between the pressure measured by the test tube and the pressure in the settling chamber. The accuracy of the measurements of  $\Delta H/q_c$  varied with Mach number. At  $M = 0.50$ , the accuracy was estimated to be within  $\pm 0.0045$  and at  $M = 0.90$ , to within  $\pm 0.002$ . Errors resulting from deflection of the sting were estimated to be less than  $1/4^\circ$  for  $\alpha = 60^\circ$  at  $M = 0.90$ .

## RESULTS AND DISCUSSION

The results of the tests of the total-pressure tubes are presented in figures 5 to 13. A summary of the results is given in table I. The symbol  $\Delta H$  shown in these figures is defined by the relation  $\Delta H = H' - H$  where  $H'$  is the pressure registered by the tube at a given angle of attack and  $H$  is the free-stream total pressure. The total-pressure errors are presented as a fraction of the impact pressure  $q_c$  and are plotted as a function of the angle of attack  $\alpha$  (or angle of yaw  $\psi$ ) of the tubes. The basis for comparison of the tubes is the range of angle of attack over which the tube reads the total pressure correctly to within 1 percent of the impact pressure. This range is called the range of insensitivity and the angle at which the total-pressure error reaches 1 percent of the impact pressure is called the critical angle ( $\alpha_{cr}$  or  $\psi_{cr}$ ). For the five symmetrical tubes, the critical angles at negative angles of attack were assumed to be the same as those at positive angles.

The calibrations for tube 1-a (Kiel design) are given in figure 5 for Mach numbers of 0.26, 0.50, 0.70, and 0.90. This tube, which is similar to tube A-13 of references 1 and 2 except for a larger outside diameter  $D$ , has a range of insensitivity at  $M = 0.26$  of  $\pm 41.3^\circ$ . This range is almost identical to the range of tube A-13 of reference 1 at  $M = 0.26$ . As the Mach number is increased the range of insensitivity decreases until at  $M = 0.90$  the range is  $\pm 38.6^\circ$ .

The effect of varying the axial position of the total-pressure probe in the entrance cone of the Kiel design was determined for probe positions  $a/D$  of 0.456, 0.500, and 0.544 at a Mach number of 0.26 (figs. 5 and 6). The use of 0.544 as the value for the rearward position of the probe in this tube is somewhat arbitrary, because it is based on the position chosen for similar tests (discussed subsequently) on a tube with a slant profile. The value 0.456 was used for the forward position because it placed the probe at the same distance ahead of the standard position (0.500) as 0.544 had to the rear. Comparison of figures 5 and 6 shows that the ranges of insensitivity for the three probe positions, 0.456, 0.500, and 0.544, are  $\pm 41.5^\circ$ ,  $\pm 41.3^\circ$ , and  $\pm 40.1^\circ$ , respectively. As indicated by these results, moving the probe to the rear of the standard position decreases the critical angle by  $1.2^\circ$ , whereas the effect of moving the probe ahead of the standard position is negligible. No advantage is to be gained, therefore, in varying the position of the probe from that used in the standard Kiel design.

The effect of varying the inside diameter of the shield of the standard Kiel design may be seen by comparing the calibrations of tubes 1-a and 2-a or tubes 1-b and 2-b (figs. 5, 6, and 7). The value 0.591 for the internal diameter of tubes 2-a and 2-b represents an increase in the area of the vent passage through the throat of 50 percent above that of the standard



Kiel design. (Note that this increase in internal diameter is accompanied by small decrease in the angle of the entrance cone.) For probe position 0.500 (tubes 1-a and 2-a) this increase in size of the internal passage results in an increase in the range of insensitivity of from  $\pm 41.3^\circ$  to  $\pm 44.0^\circ$ . For probe position 0.544, the range is increased from  $\pm 40.1^\circ$  to  $\pm 42.5^\circ$ . The effect of increasing the area of the internal passage by 50 percent, therefore, is to increase the critical angle by about  $2.5^\circ$ .

The effect of probe position on the range of insensitivity of tube 2 is shown in figure 7. As indicated by this figure, the range of insensitivity of probe position 0.500 is  $\pm 44.0^\circ$ , while that for position 0.544 is  $\pm 42.5^\circ$ . The effect of moving the probe from 0.500 to 0.544, therefore, is to decrease the critical angle by  $1.5^\circ$ , which agrees well with the  $1.2^\circ$  decrease noted for tubes 1-a and 1-b.

The effect of varying the leading-edge profile of the shield may be seen by comparing the calibrations in figures 5, 6, 8(a), and 9. For probe position 0.500, the effect of changing the leading-edge profile from square to a  $10^\circ$  slant is to increase the critical angle of attack from  $41.3^\circ$  to  $51^\circ$  at  $M = 0.26$  and from  $38.6^\circ$  to  $46.5^\circ$  at  $M = 0.90$  (figs. 5 and 8(a)), an average increase of about  $9^\circ$ . When the position of the probe is set at 0.544, the  $10^\circ$  slant profile has the effect of increasing the critical angle from  $40.1^\circ$  to  $47.7^\circ$  at  $M = 0.26$  (figs. 6 and 9). The value 0.544 was chosen for the rearward position of the probe because this position placed the leading edge of the probe midway between the rear of the cone and the leading edge of the slanted shield (at the point of intersection with the center line of the tube) and thus corresponded to the probe position (0.500) of the standard Kiel design (tube 1-a). The results of these tests indicate that the effect of a  $10^\circ$  slant at  $M = 0.26$  is to increase the critical angle  $9.7^\circ$  for probe position 0.500 and only  $7.6^\circ$  for probe position 0.544. If probe position 0.544 can properly be considered as corresponding to the standard position (0.500) of the Kiel design, the results of these tests indicate that moving the probe forward of the "standard" position of the tube with the slant profile has a beneficial effect on the performance of this tube.

The angular range covered in these tests was not large enough to determine the critical negative angle of attack for the tubes with a slant profile. The results of the tests of an unvented, cylindrical tube (tube A-6) reported in reference 1, however, showed that the total range of insensitivity remains essentially constant when the profile is changed from square to a  $10^\circ$  slant. If the same result is assumed to hold for shielded tubes, the range of insensitivity for tube 3-a would be from  $-31.6^\circ$  to  $51^\circ$  at  $M = 0.26$  and from  $-30.7^\circ$  to  $46.5^\circ$  at  $M = 0.90$ . For tube 3-b the range would be  $-32.5^\circ$  to  $47.7^\circ$  at  $M = 0.26$ .

The characteristics of the tube with the slant profile at angles of yaw ( $\alpha = 0^\circ$ ) are shown in figure 8(b) for tube 3-a. At  $M = 0.90$  the range of insensitivity of this tube in yaw is  $\pm 38^\circ$ . This range is approximately

the same as that of tube 1-a, which has the same design features except for a square profile. A  $10^\circ$  slant profile, therefore, has the effect of extending the range of insensitivity to higher positive angles of attack ( $\psi = 0^\circ$ ) without loss in performance at angles of yaw ( $\alpha = 0^\circ$ ).

Calibrations of three tubes with curved entries are presented in figures 10 to 13. For each of these tubes  $a/D$  and  $d/D$  equal 0.500. The slope of the entry curve of tubes 4-a, 4-b, and 4-c is  $60^\circ$  at the leading edge and  $0^\circ$  at a distance  $0.500D$  behind the leading edge, while for tube 5 the slope is  $30^\circ$  at the leading edge and  $0^\circ$  at a distance  $D$  behind the leading edge. The entry for tube 6 is an adaptation of an NACA nose inlet. Tube 6 has a rounded leading edge while tubes 4-a, 4-b, 4-c, and 5 have sharp leading edges.

The results of the tests of tube 4-a at  $M = 0.26, 0.50, 0.70, 0.90,$  and  $0.95$  are presented in figure 10. For each of these Mach numbers the range of insensitivity is  $\pm 63.2^\circ, \pm 63.3^\circ, \pm 60.6^\circ, \pm 58.4^\circ,$  and  $\pm 58.0^\circ,$  respectively. Comparison of these values with those obtained with tube 1-a shows that the range of insensitivity of this tube is about  $20^\circ$  higher than that of the Kiel design.

The effect of probe position on the performance of a tube with a curved entry (tubes 4-a, 4-b, and 4-c) was determined for probe positions 0.456, 0.500, and 0.544 at a Mach number of 0.26 (figs. 10 and 11). As indicated by these calibrations, the range of insensitivity for the three probe positions was  $\pm 63.8^\circ, \pm 63.2^\circ,$  and  $\pm 63.8^\circ,$  respectively. It is apparent from these results that the effect of varying the position of the probe on a tube of this design is negligible for the range of positions tested.

Calibrations of tube 5 are given in figure 12 for Mach numbers 0.26 and 0.90. At  $M = 0.26$  the range of insensitivity is  $\pm 51.4^\circ$  whereas at  $M = 0.90$  the range is  $\pm 45.5^\circ$ . The critical angles, therefore, are about  $10^\circ$  higher than that of tube 1-a at  $M = 0.26$  and about  $7^\circ$  higher at  $M = 0.90$ .

The calibrations of tube 6 at  $M = 0.26$  and 0.90 are presented in figure 13. For each of these Mach numbers the range of insensitivity is  $\pm 53.9^\circ$  and  $\pm 50.6^\circ,$  respectively. The corresponding critical angles are approximately  $12^\circ$  greater than those of tube 1-a.

A comparison of the results of the tests of the three tubes with curved entries shows that the range of insensitivity increases as the bluntness of the entry increases. The range of the tube with the bluntest entry (tube 4-a), for example, is the highest ( $\pm 63.2^\circ$ ) while that of the tube with the least bluntness (tube 5) is the lowest ( $\pm 51.4^\circ$ ). The tests also show that in every case the range of insensitivity of tubes with curved entries is considerably greater than that of the conical entry of the Kiel design (tube 1-a).



The variation of tube sensitivity with Mach number is given in figure 14 for those tubes for which  $a/D$  and  $d/D$  equal 0.500. As shown by this figure, the critical angles for all the tubes decrease with increasing Mach number. The magnitude of the decrease, however, is not the same for each of the tubes, because it varies from  $3^\circ$  for tube 1-a to  $6^\circ$  for tube 5 (for a Mach number range of 0.26 to 0.90). Furthermore, the variation of critical angle over the Mach number range is not the same for the two tubes (1-a and 4-a) for which data were obtained at more than two Mach numbers. The critical angle for tube 1-a, for example, varies linearly with Mach number, while that for tube 4-a is constant between  $M = 0.26$  and 0.50 and decreases as  $M$  increases to 0.95. Despite these differences, the results are still significant in showing that the effect of increasing Mach number is to cause a decrease in the critical angle and that the magnitude of the decrease may be appreciable (an average of over  $4^\circ$  for five tubes tested).

#### CONCLUDING REMARKS

A wind-tunnel investigation of six shielded total-pressure tubes has been conducted over an angle-of-attack range of approximately  $-30^\circ$  to  $65^\circ$  at Mach numbers of 0.26, 0.50, 0.70, 0.90, and 0.95.

The results of the tests showed that the shape of the venturi entry has pronounced effect on the range of angle of attack over which the tubes remain insensitive to inclination of the air stream. In this regard, curved entries were shown to be superior to the conical entry of the standard Kiel design. Of the three curved entries tested, the tube having the bluntest entry proved the least sensitive to inclination. The critical angle (that is, the angle at which the total-pressure error equals 1 percent of the impact pressure) for this tube was  $63.2^\circ$  at a Mach number of 0.26.

The tests also showed that the critical angle of a shielded tube could be extended to higher positive angles of attack by means of a slant profile. The critical angle of a tube having a conical entry with a  $10^\circ$  slant profile, for example, was found to average  $9^\circ$  greater than that of a similar tube having a square profile. Although the critical angle of this tube at angles of yaw was less than that at angles of attack, the critical angle in yaw was equal to that of the tube with the square profile.

Tests of the effect of varying the position of the probe in the shield showed that, in general, no advantage was to be gained by changing from the position used in the standard Kiel design. Limited tests of the effect of varying the internal diameter of the shield showed that an increase in the internal diameter corresponding to an increase in the internal area of 50 percent resulted in a relatively small increase ( $2.5^\circ$ ) in the critical angle.

The effect of compressibility on the sensitivity of the tubes to inclination was shown to be appreciable. An increase in Mach number from 0.26 to 0.90, for example, resulted in a decrease in the critical angles of most of the tubes of about  $4^{\circ}$ .

Langley Aeronautical Laboratory  
National Advisory Committee for Aeronautics  
Langley Field, Va., August 16, 1951

#### REFERENCES

1. Gracey, William, Letko, William, and Russell, Walter R.: Wind-Tunnel Investigation of a Number of Total-Pressure Tubes at High Angles of Attack. Subsonic Speeds. NACA TN 2331, 1951.
2. Gracey, William, Coletti, Donald E., and Russell, Walter R.: Wind-Tunnel Investigation of a Number of Total-Pressure Tubes at High Angles of Attack. Supersonic Speeds. NACA TN 2261, 1951.
3. Moffat, Marston: Report on Kiel Probes. Rep. No. PWA-576, Pratt & Whitney Aircraft, Oct. 17, 1945.
4. Kiel, G.: Total-Head Meter with Small Sensitivity to Yaw. NACA TM 775, 1935.

TABLE I. - ANGULAR RANGE OVER WHICH SHIELDED TOTAL-PRESSURE TUBES  
 REMAIN INSENSITIVE TO INCLINATION TO WITHIN 1 PERCENT  $q_c$

Tube	Figure	Shield entry shape	$\frac{a}{D}$	$\frac{d}{D}$	Range of insensitivity, deg, at -				
					M = 0.26	M = 0.50	M = 0.70	M = 0.90	M = 0.95
1-a	5	Conical	0.500	0.500	±41.3	±40.4	±39.5	±38.6	-----
1-b	6	Conical	.544	.500	±40.1	-----	-----	-----	-----
1-c	6	Conical	.456	.500	±41.5	-----	-----	-----	-----
2-a	7	Conical	.500	.591	±44.0	-----	-----	-----	-----
2-b	7	Conical	.544	.591	±42.5	-----	-----	-----	-----
3-a	8(a)	Conical, 10° slant profile	.500	.500	*-31.6, 51	-----	-----	*-30.7, 46.5	-----
3-a	8(b)	Conical, 10° slant profile	.500	.500	-----	-----	-----	ψ = ±38.0	-----
3-b	9	Conical, 10° slant profile	.544	.500	*-32.5, 47.7	-----	-----	-----	-----
4-a	10	Curved	.500	.500	±63.2	±63.3	±60.6	±58.4	±58.0
4-b	11	Curved	.544	.500	±63.8	-----	-----	-----	-----
4-c	11	Curved	.456	.500	±63.8	-----	-----	-----	-----
5	12	Curved	.500	.500	±51.4	-----	-----	±45.5	-----
6	13	Curved	.500	.500	±53.9	-----	-----	±50.6	-----

\*Estimated.



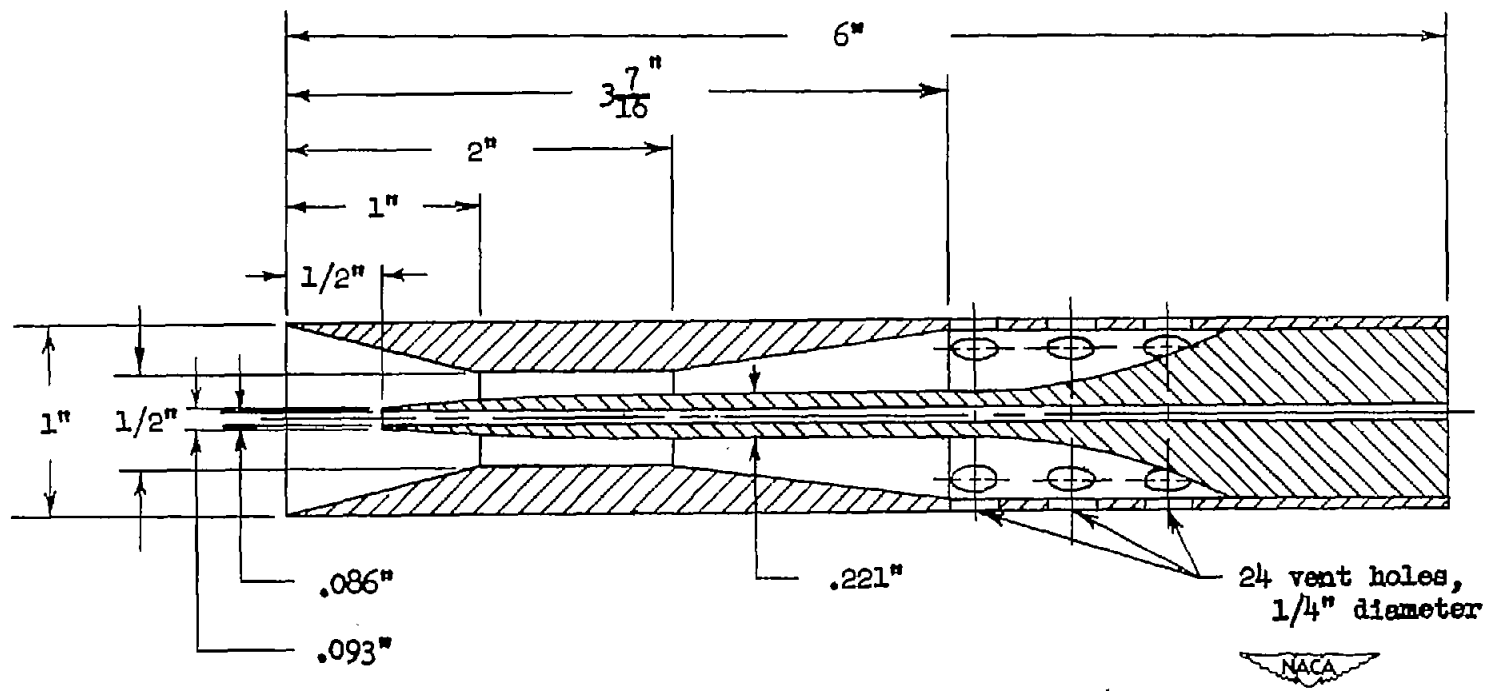

Figure 1.- Section view of shielded total-pressure tube 1-a.

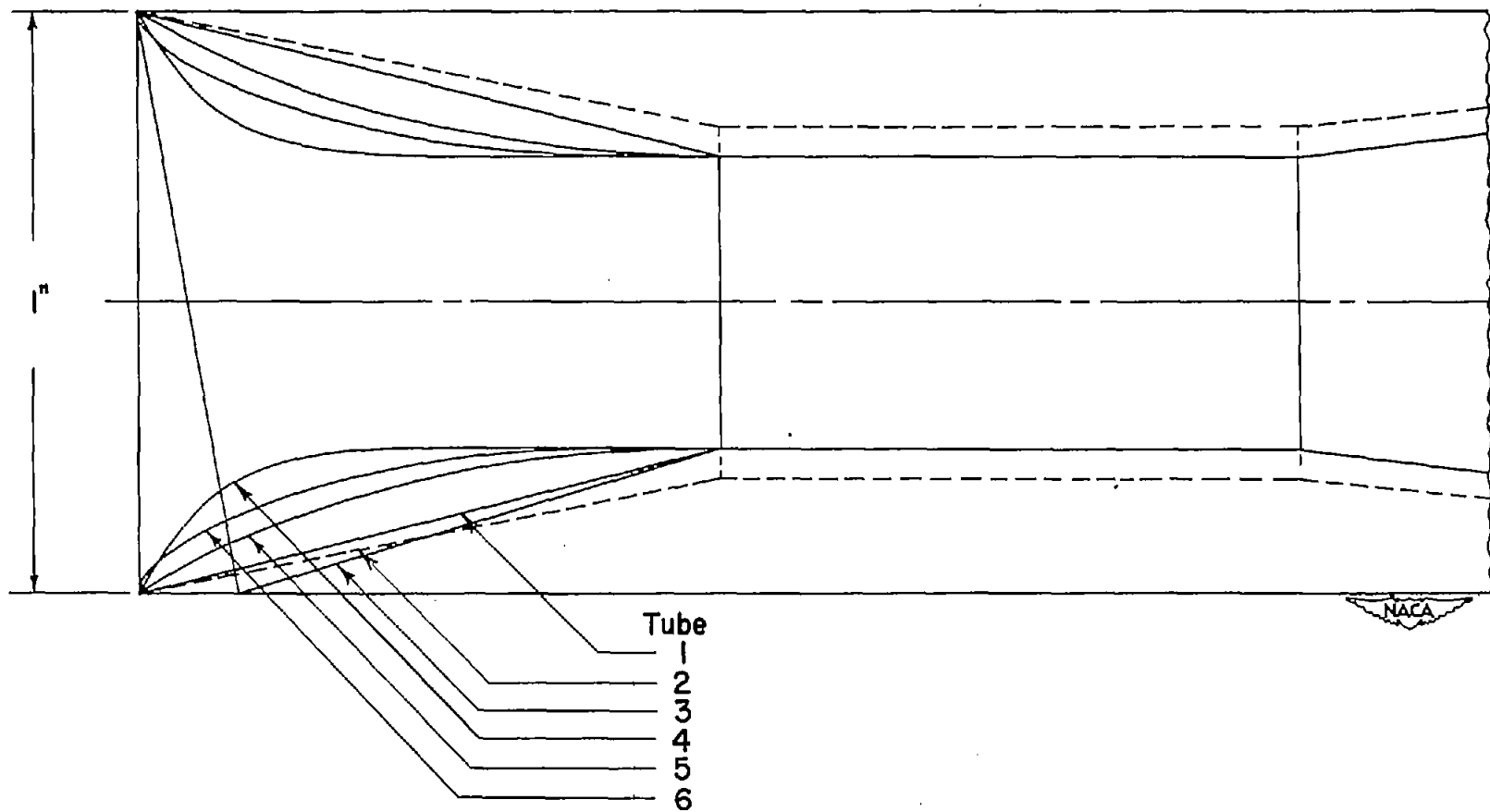

Figure 2.- Comparison of the shield entries of the six total-pressure tubes tested.

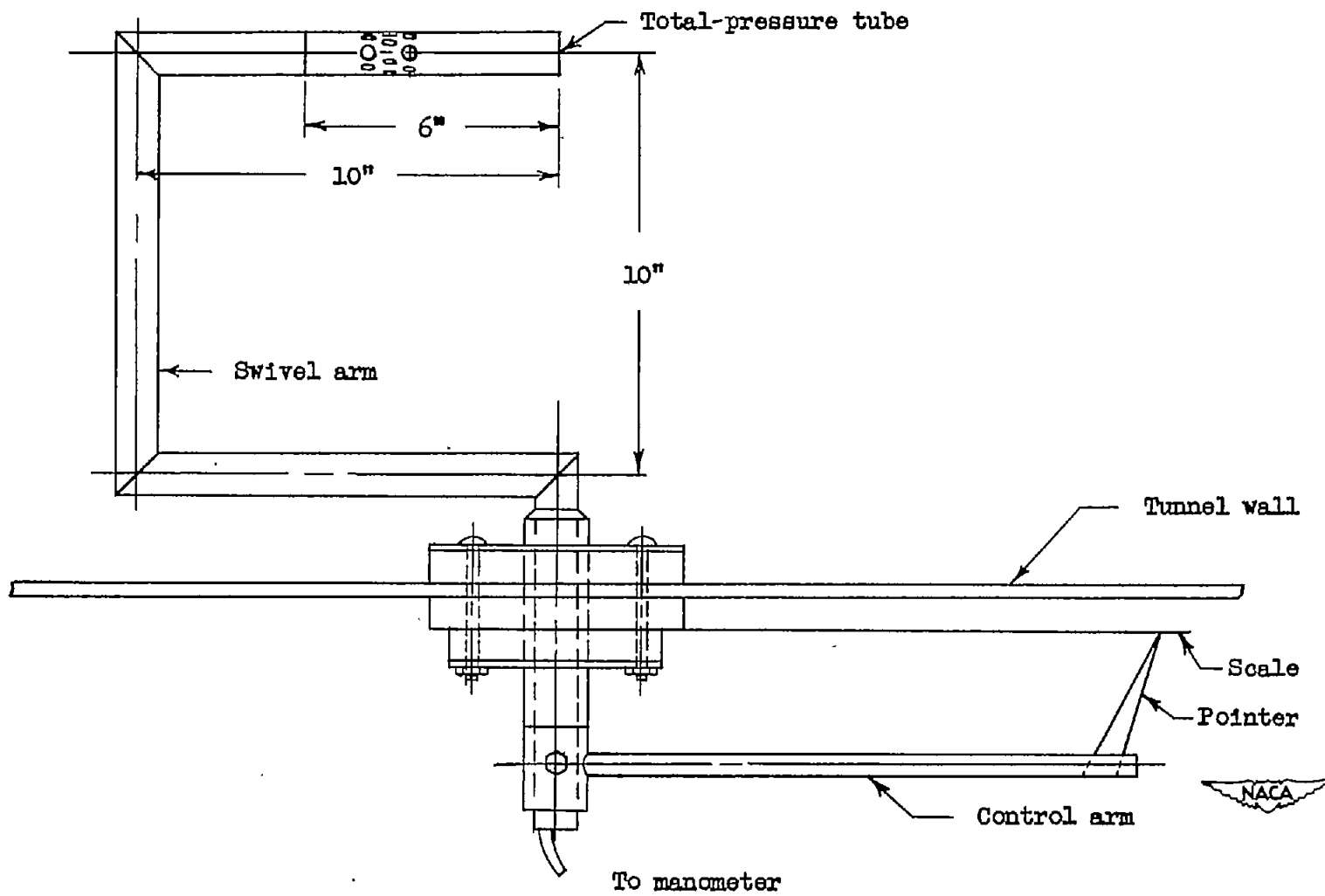

Figure 3.- Diagram of swivel mechanism used in Langley stability tunnel for changing angle of attack of total-pressure tubes.



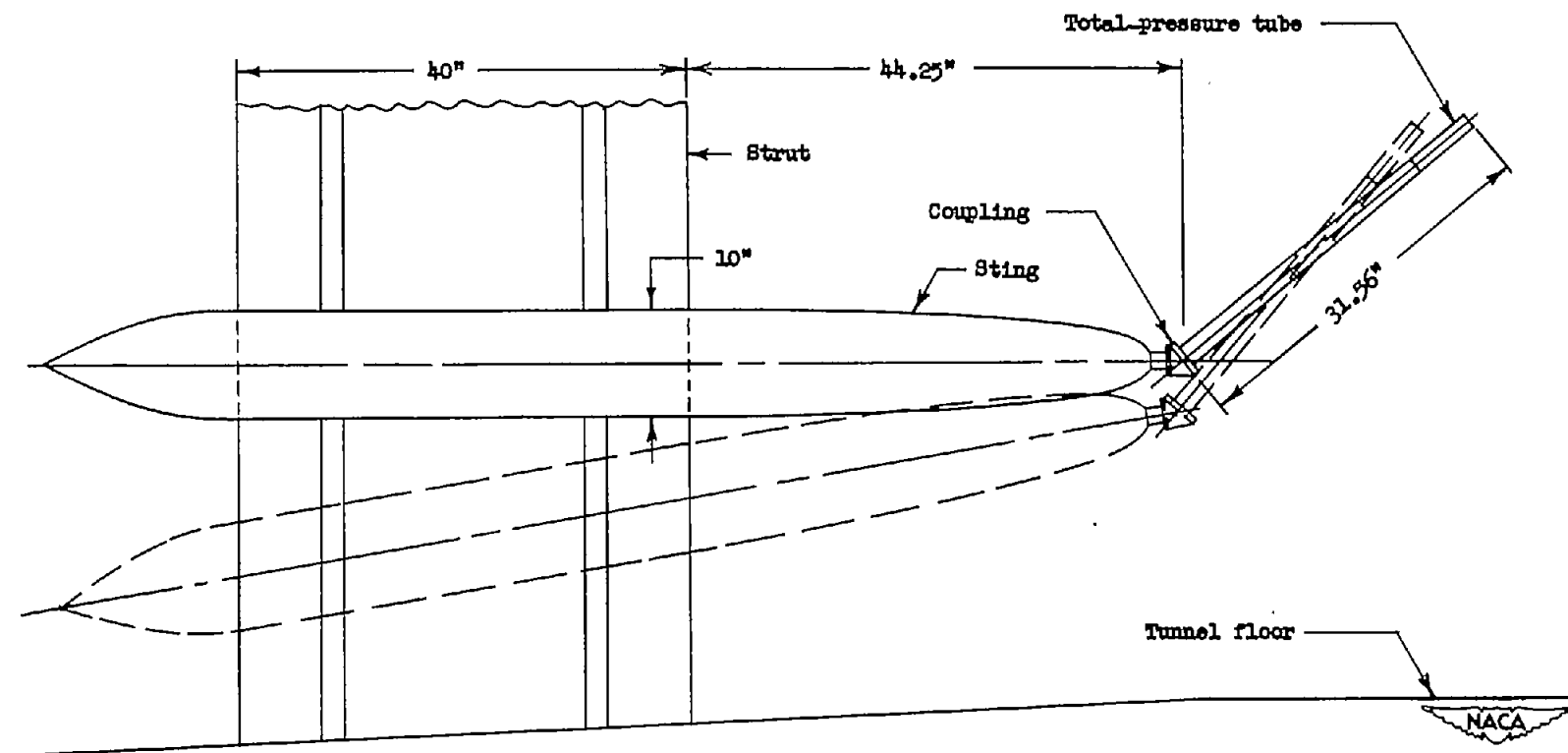

Figure 4.- Diagram of mechanism used in Langley high-speed 7- by 10-foot tunnel to support total-pressure tubes.

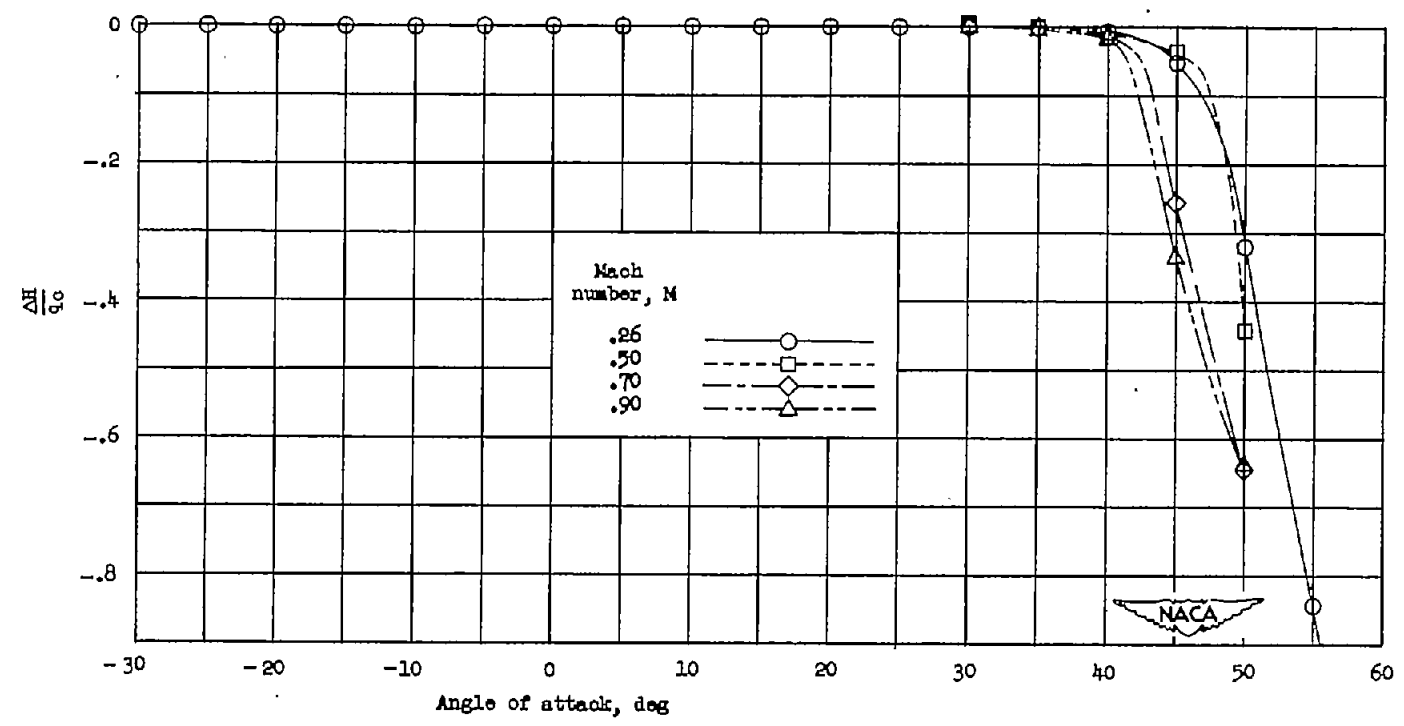
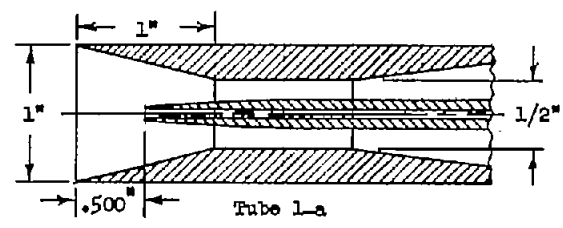

Figure 5.- Variation of total-pressure error with angle of attack. M = 0.26, 0.50, 0.70, and 0.90. Tube 1-a.

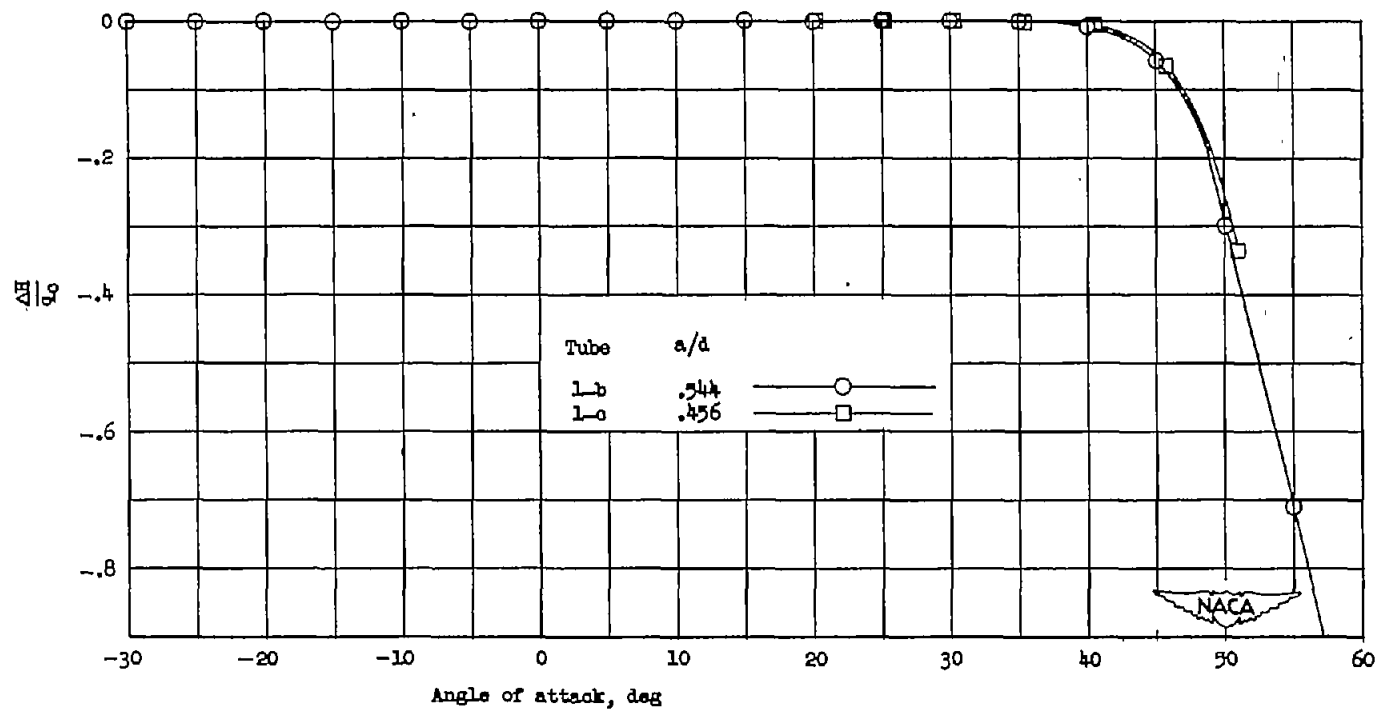
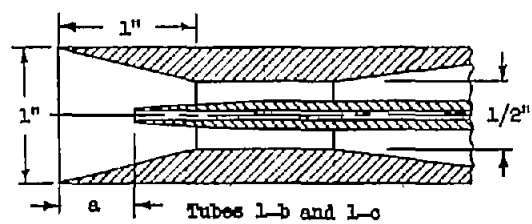

Figure 6.- Variation of total-pressure error with angle of attack.  $M = 0.26$ .  
 Tubes 1-b and 1-c.

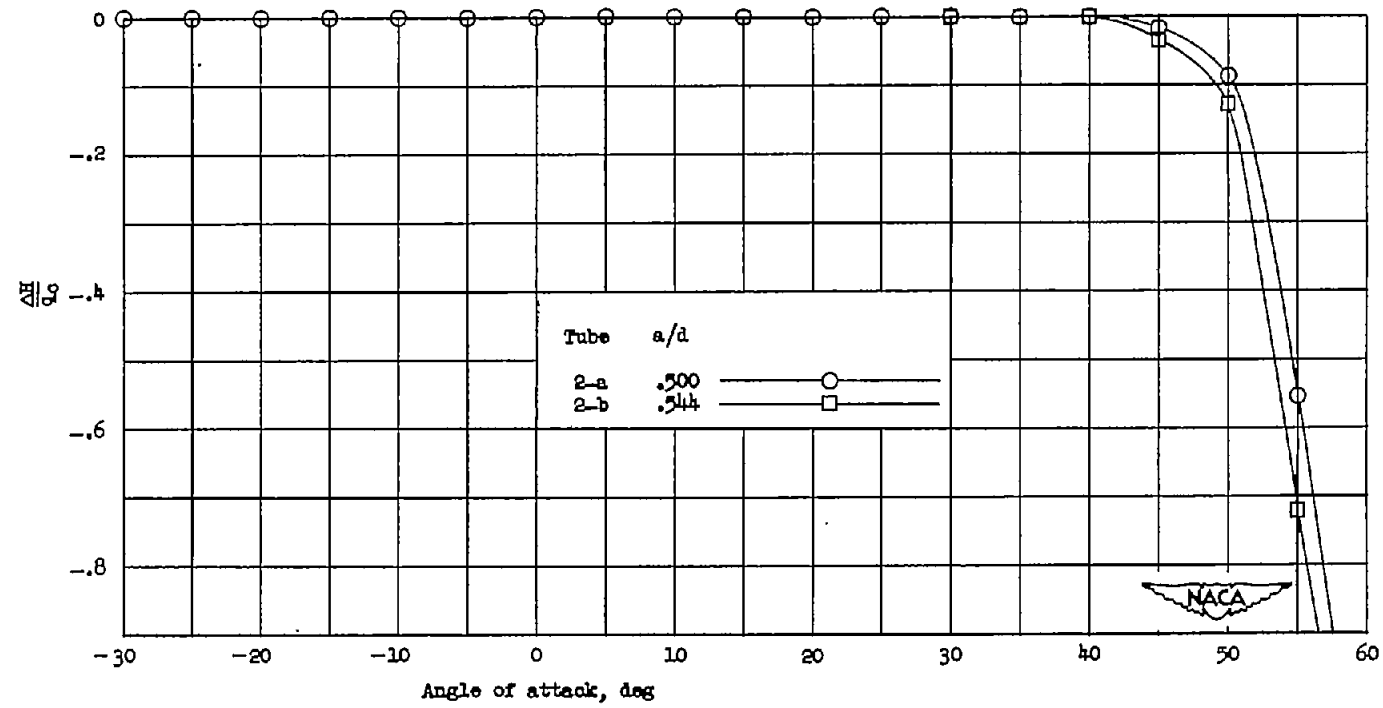
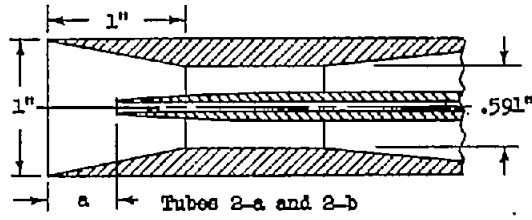
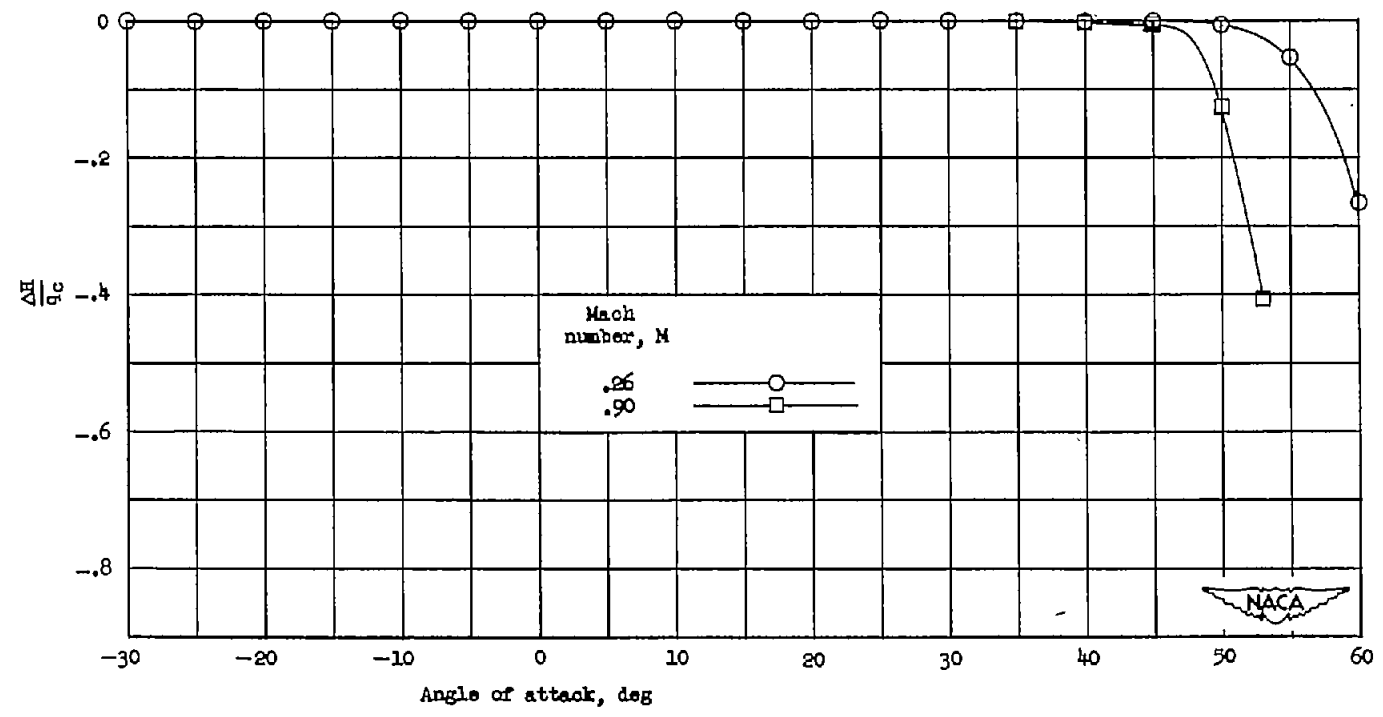
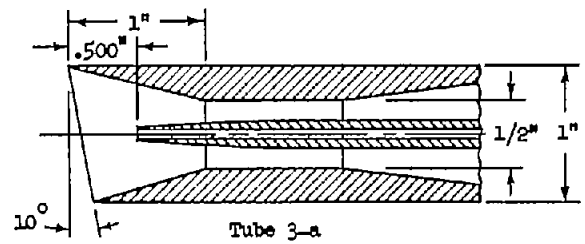
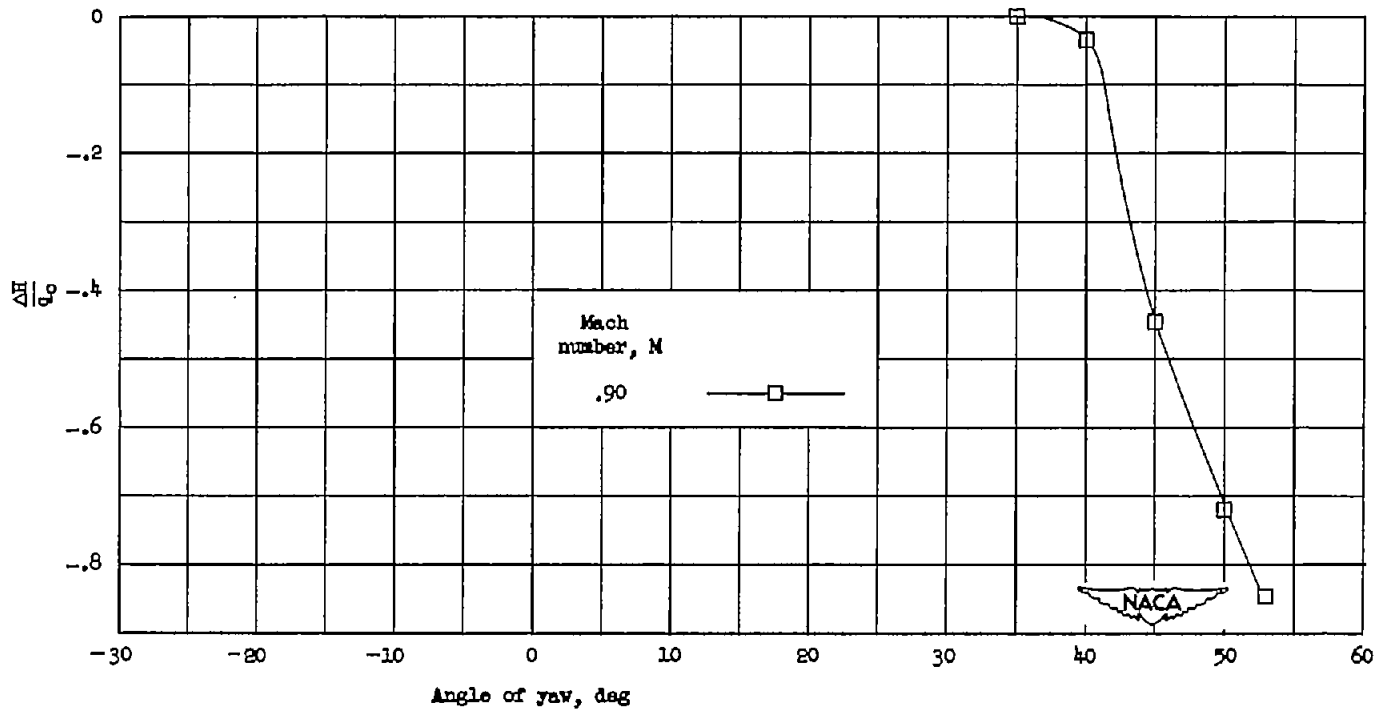

Figure 7.- Variation of total-pressure error with angle of attack.  $M = 0.26$ .  
 Tubes 2-a and 2-b.



(a) Angle of attack ( $\psi = 0^\circ$ ).

Figure 8.- Variation of total-pressure error with inclination to the air stream. M = 0.26 and 0.90. Tube 3-a.



(b) Angle of yaw ( $\alpha = 0^\circ$ ).

Figure 8.- Concluded.



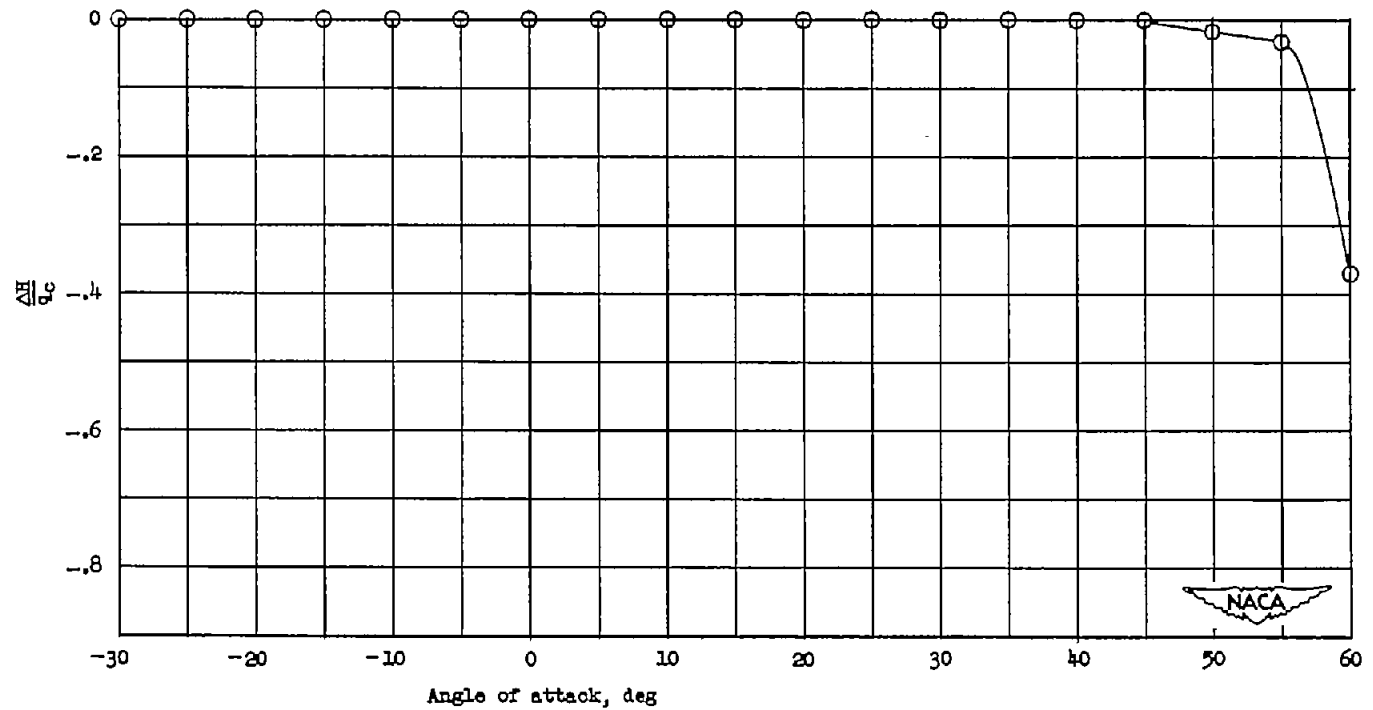
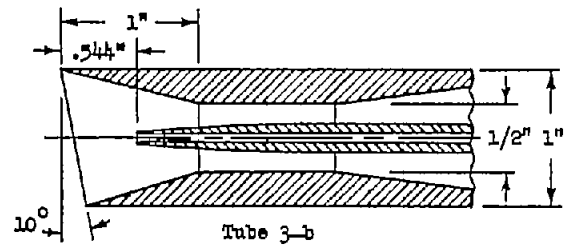

Figure 9.- Variation of total-pressure error with angle of attack ( $\psi = 0^\circ$ ).  
 M = 0.26. Tube 3-b.

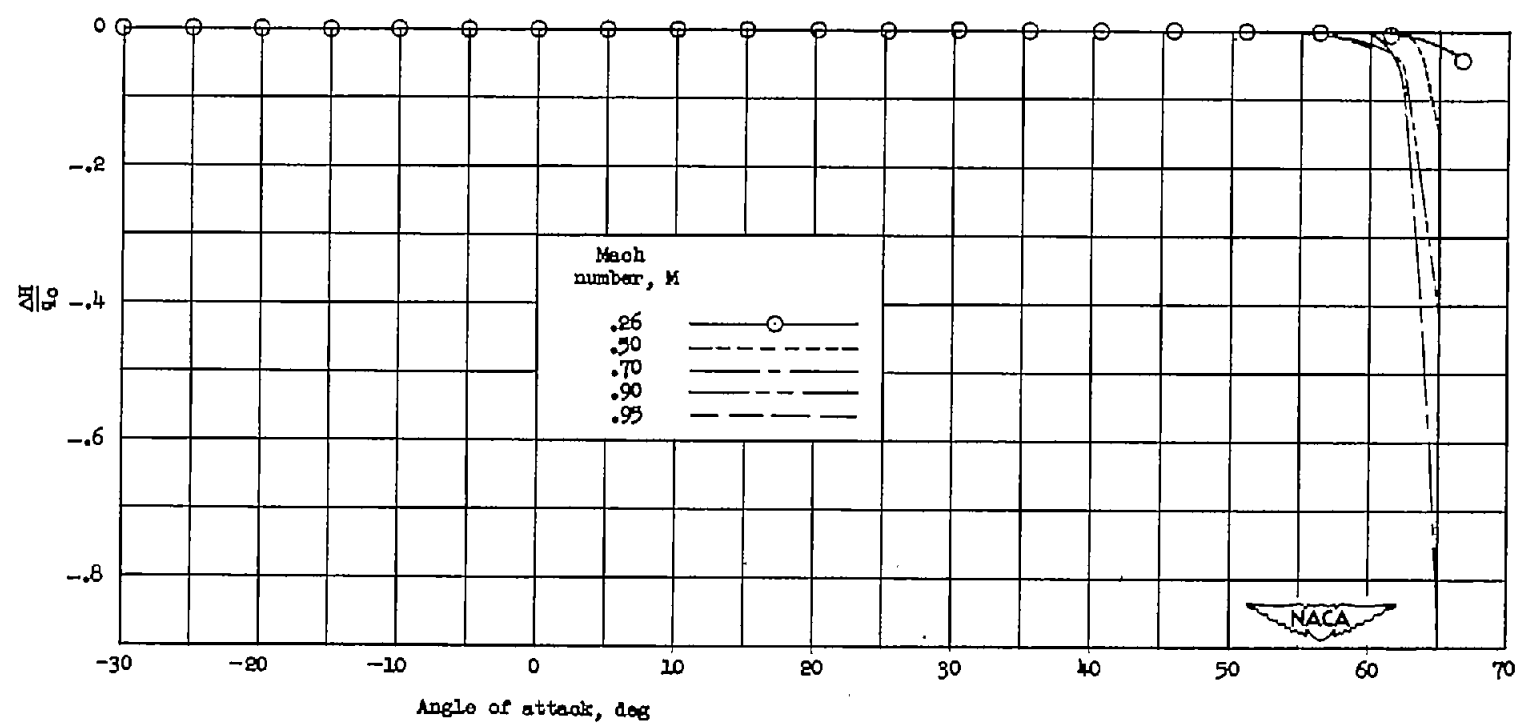
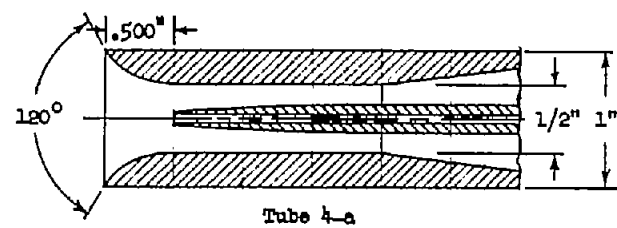

Figure 10.- Variation of total-pressure error with angle of attack.  
 M = 0.26, 0.50, 0.70, 0.90, and 0.95. Tube 4-a.

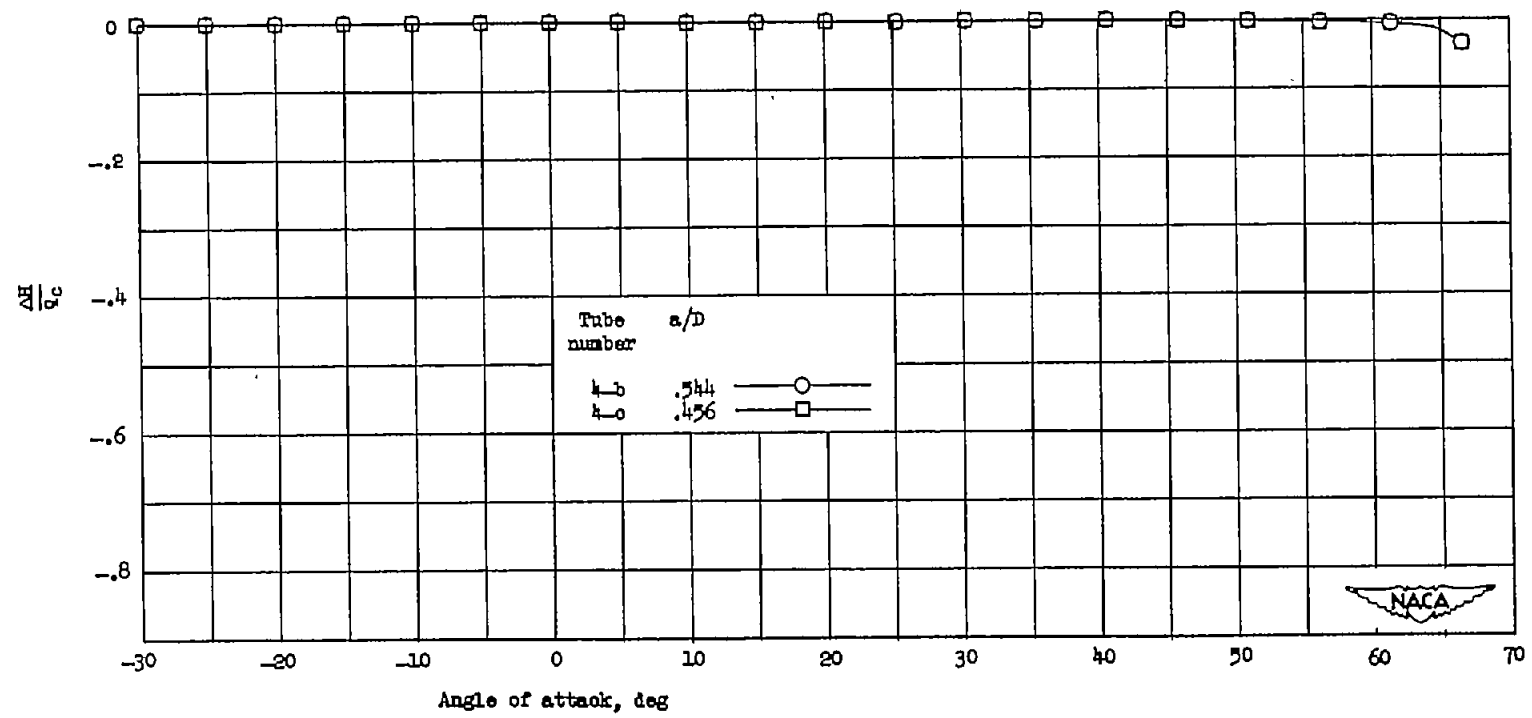
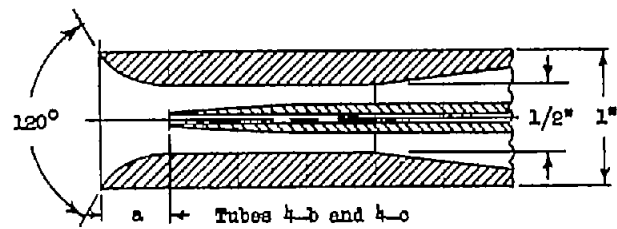

Figure 11.- Variation of total-pressure error with angle of attack.  
 M = 0.26. Tubes 4-b and 4-c.

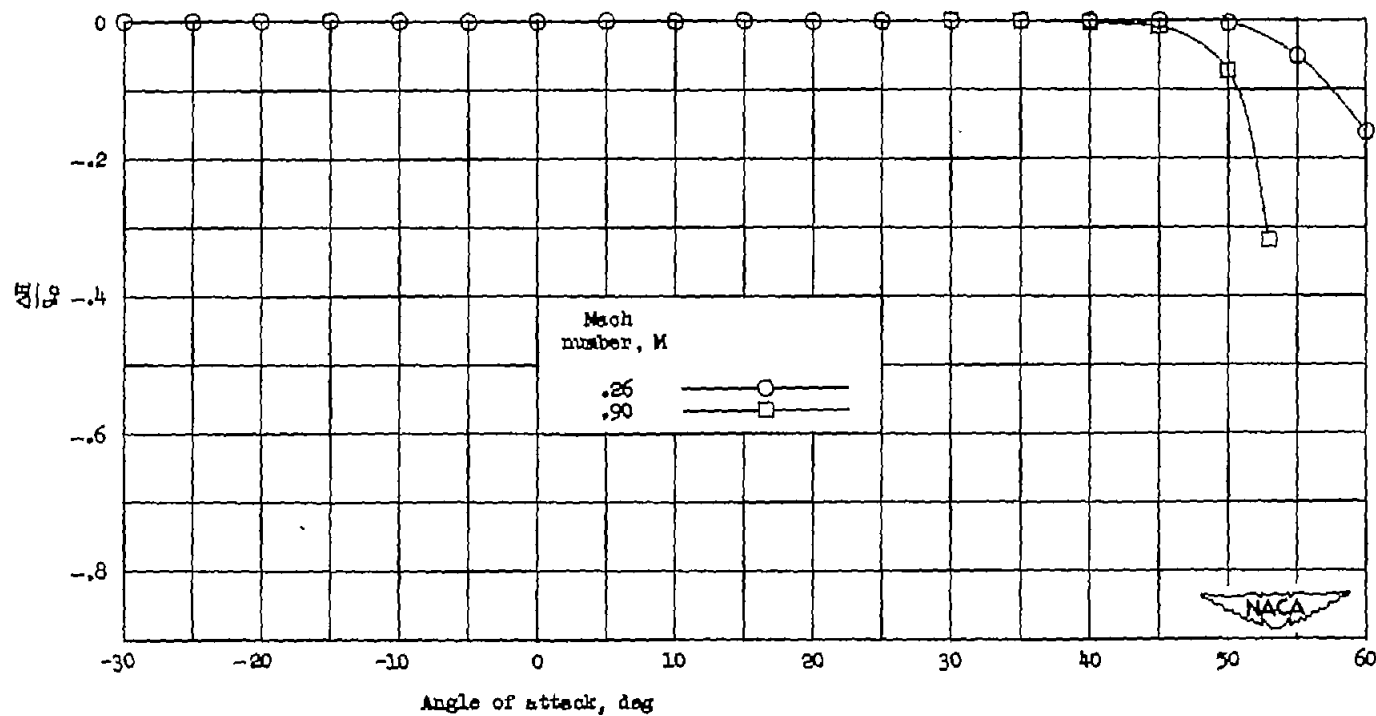
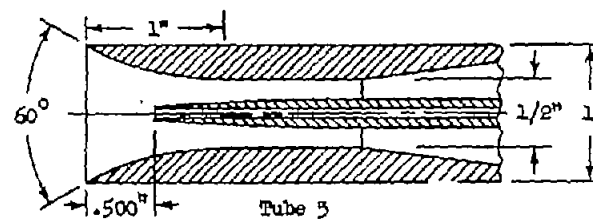

Figure 12.- Variation of total-pressure error with angle of attack.  
 M = 0.26 and 0.90. Tube 5.

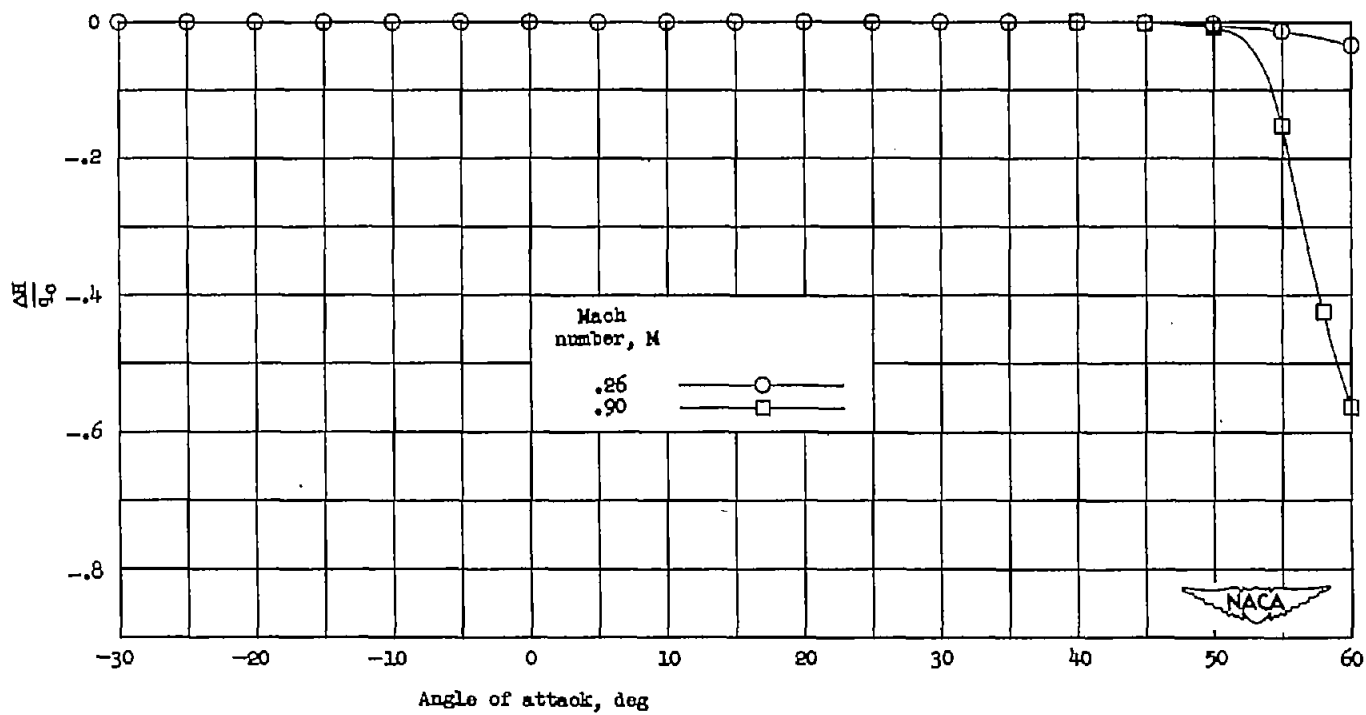
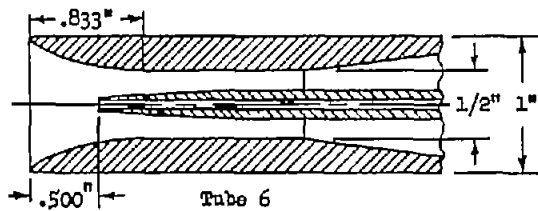

Figure 13.- Variation of total-pressure error with angle of attack.  
 M = 0.26 and 0.90. Tube 6.

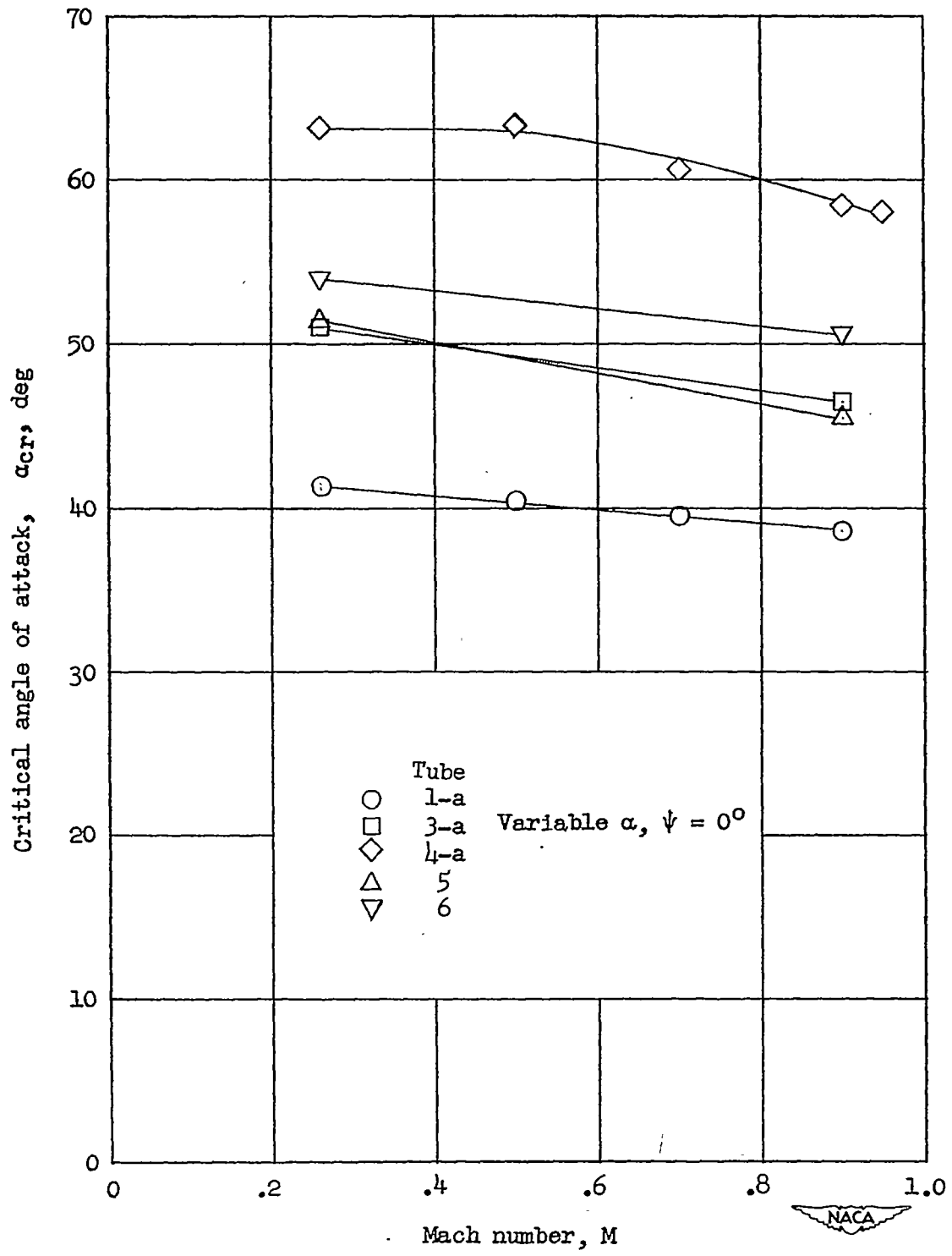

Figure 14.- Variation of critical angle with Mach number for tubes with a/D and d/D equal to 0.500.