

6006

NACA TN 2636

TECH LIBRARY KAFB, NM
0065715



NATIONAL ADVISORY COMMITTEE FOR AERONAUTICS

TECHNICAL NOTE 2636

INFLUENCE OF LUBRICANT VISCOSITY ON OPERATING
TEMPERATURES OF 75-MILLIMETER-BORE
CYLINDRICAL-ROLLER BEARING AT
HIGH SPEEDS

By E. Fred Macks, William J. Anderson
and Zolton N. Nemeth

Lewis Flight Propulsion Laboratory
Cleveland, Ohio



Washington
February 1952

AFM:C
TECHNICAL LIBRARY
AFL 2811



NATIONAL ADVISORY COMMITTEE FOR AERONAUTICS

TECHNICAL NOTE 2636

INFLUENCE OF LUBRICANT VISCOSITY ON OPERATING TEMPERATURES

OF 75-MILLIMETER-BORE CYLINDRICAL-ROLLER BEARING

AT HIGH SPEEDS

By E. Fred Macks, William J. Anderson, and
Zolton N. Nemeth

SUMMARY

A 75-millimeter-bore (size 215) cylindrical-roller inner-race-riding cage-type bearing was used in an experimental investigation of the effect of oil viscosity on bearing operating characteristics over a range of DN values (bearing bore in mm times shaft speed in rpm) from 0.3×10^6 to 1.2×10^6 . Kinematic viscosity at the inlet temperatures varied from 1.7 to 390 centistokes (absolute viscosities of 2.0×10^{-7} to 470×10^{-7} reyns).

A previously developed cooling-correlation analysis was extended to include fully the effect of varying lubricant viscosity. This improved correlation makes it possible to predict either the inner- or the outer-race bearing temperatures from single curves regardless of whether speed, load, oil flow, oil inlet temperature, oil inlet viscosity, oil-jet diameter, or any combination of these parameters is varied over wide ranges.

Minimum bearing temperatures resulted (with load, DN value, oil flow, and oil inlet temperature constant) when a low viscosity, low viscosity-index oil was used.

Minimum power rejection to the oil (at a constant bearing temperature) resulted when a low-viscosity oil was introduced at high inlet temperatures.

In the viscosity range investigated, bearing temperatures increased with increasing oil viscosity at constant DN, load, and oil flow. A higher oil flow of a more viscous oil was therefore required to maintain a constant bearing temperature.

At a constant bearing temperature, DN, and load, the power rejected to the oil increased with increasing oil viscosity. At constant bearing temperature, DN, and load, and when a specific oil was used for lubrication, the measured power rejected to the oil decreased with increasing oil inlet temperature within the range investigated.

2356

INTRODUCTION

The influence of oil viscosity on the effectiveness of cooling and lubricating high-speed rolling-contact bearings is of particular significance in turbojet and turboprop engine design. Not only must the high-speed engine bearings be lubricated, but a large portion of the bearing heat must be removed by the lubricant; the heat absorbed by the lubricant must, in turn, be removed to maintain safe operating temperatures. In order that the heat to be removed from the lubricant will be a minimum, it is desirable that as little heat as possible be generated by shearing the lubricant in the process of cooling and lubricating the bearings.

The information available in the literature on the bearing cooling effectiveness and the heat absorption characteristics of lubricants as functions of lubricant viscosity deals with bearing performance at relatively low speeds. The results therefore cannot be applied to the solution of bearing problems in aircraft gas-turbines because of the high operating speeds. The effect of very low oil flows on friction torque is reported in reference 1. The effects of higher oil flows on friction torque are considered in references 2 and 3. Information on the effect of oil viscosity and oil flow on operating temperatures, friction torque, and power dissipated at low speeds is contained in references 4 to 6.

High-viscosity oils are preferred for lubricating gears because of the greater load-carrying capacity. In many instances, however, the use of high-viscosity oils as lubricants for aircraft gas-turbine engines is prohibited by the wide temperature ranges over which these oils must function as lubricants and coolants. Whether or not a specific oil may be used depends on whether it is pumpable at the low-temperature limit of operation and on whether its high-temperature stability is satisfactory.

If oil is supplied to a bearing through a single small-diameter jet normal to the bearing face and directed at the cage-locating surface, a portion of the oil will be deflected and a portion of the oil will be transmitted through the bearing (reference 7). The deflected oil serves more specifically as a coolant than as a lubricant. (A small amount of oil may enter the bearing and then exit on the deflected-oil side.) The oil transmitted through the bearing serves both to lubricate and to cool the bearing; in addition, it may be a source of heat due to churning. The total heat rejected to the oil (for a specific bearing, DN, and load) as affected by oil inlet viscosity, oil inlet temperature, and oil flow is important to the engine designer.

This investigation was conducted to study the effects of oil viscosity on the operating characteristics of high-speed roller bearings. In particular, the effects of oil viscosity, oil flow, and oil inlet temperature on bearing-operating temperature and power rejected to the oil are reported herein. The effects of oil flow and oil inlet temperature on bearing-operating temperature have been studied (references 7 to 9) with a single medium-viscosity oil (oil C of this report). According

to the results of the present investigation, use of low-viscosity oils would have resulted in lower bearing temperatures. The significant work remaining consists in an investigation of the effects of oil viscosity on fatigue life and possibly on bearing breakdown load. A preliminary investigation of the effect of oil viscosity on fatigue life is reported in reference 6 but the results are not conclusive.

2356
A cylindrical-roller bearing (size 215) currently used as the turbine-roller bearing in an aircraft gas-turbine engine was used as the test bearing for this investigation. The controlled variables in this investigation were: load, 368 pounds; DN (bearing bore in mm multiplied by shaft speed in rpm), 0.3×10^6 to 1.2×10^6 ; and oil flow, 1.8 to 9 pounds per minute. Five different oils were used in the investigation in order to give a wide viscosity range. Kinematic viscosities at the inlet to the test bearing varied from 1.7 to 390 centistokes (absolute viscosities from 2.0×10^{-7} to 470×10^{-7} reyns) at oil inlet temperatures of 100° and 205° F.

High-speed rolling-contact bearings in aircraft gas-turbine engines are currently lubricated with an oil similar to oil B of this investigation. The operating conditions imposed on this type of bearing in actual engine service are as follows: DN, 0.3×10^6 to 0.86×10^6 , approximate gravity load, 375 pounds; and oil flow, 0.8 to 2 pounds per minute.

This investigation conducted at the NACA Lewis laboratory, is a continuation of the work reported in references 7 to 9.

APPARATUS

Bearing rig. - The bearing rig (fig. 1) used for this investigation is the same as that used in references 7 to 9. The bearing under investigation was mounted on one end of the test shaft, which was supported in cantilever fashion in order to observe bearing component parts and lubricant flow during operation. A radial load was applied to the test bearing by means of a lever and dead-weight system in such a manner that the outer race of the test bearing was essentially unaffected by small shaft deflections or by small shaft and load-arm misalignments.

The support bearings were lubricated in the manner described in reference 8. Oil was supplied to the support bearings at a pressure of 10 pounds per square inch through 0.180-inch-diameter jets, and at a temperature equal to that of the oil supplied to the test bearing (either 100° or 205° F).

The drive equipment is described in reference 8. The speed range of the test shaft is 800 to 50,000 rpm.

Test bearing. - One test bearing (size 215) was used for this investigation. The bearing dimensions were: bore, 75 millimeters; outside diameter, 130 millimeters; and width, 25 millimeters. The bearing was equipped with a one-piece inner-race-riding cage the composition of which was copper, 61 percent; zinc, 38 percent, and lead, 1 percent.

Temperature measurement. - The method of temperature measurement is described in reference 8. Iron-constantan thermocouples were located at 60° intervals around the outer-race periphery at the axial center line of the bearing under investigation. A copper-constantan thermocouple was pressed against the bore of the inner race at the axial midpoint of the test bearing; the thermocouple electromotive force was transmitted from the rotating shaft by means of small slip rings located on the end of the test shaft (reference 10).

Lubrication system. - The general make-up of the lubrication system was the same as that described in reference 8 except for changes which were made to increase the upper limit of the oil-supply pressure to the test bearing from 90 to 400 pounds per square inch.

Oil shields were added to both sides of the test bearing so that both the deflected and the transmitted oil could be collected and weighed. Oil flow to the test bearing was determined by calibrated rotameters.

PROCEDURE

Lubrication of test bearing. - Lubricant was supplied to the test bearing through a single jet of 0.050-inch diameter. The jet was of the type-B design used in reference 9. The oil was directed normal to the bearing face and at the space between the cage and the inner race diametrically opposite the load zone.

Five oils designated herein as oils A, B, C, D, and E were used to lubricate the test bearing. Oil C was used in references 7 to 9. The properties of the five oils are given in figure 2. Oils A, B, D, and E were highly refined nonpolymer-containing petroleum-base lubricating oils. Oil C was a commercially prepared blend of a highly refined paraffin base with a small percentage of polymer added to improve the viscosity index.

Data for figure 2 (viscosity curves) were obtained by taking several samples of each oil used. A sample was taken at the start of each oil run, at the start of each day's run, and at the conclusion of all the tests made with a specific oil. Viscosities were obtained by standard laboratory procedures and the data plotted in figure 2 represent the mean for all the samples of each oil. The variation in viscosity for each of the five oils as found in the laboratory tests is given in table I.

2356

When tests of one oil were completed the oil system was pumped and drained dry; it was then thoroughly flushed and drained twice with clean varsol. A quantity of fresh test oil was then circulated through the system and allowed to drain completely. The test oil was then introduced to the system.

The oils were supplied to the test bearing at temperatures of 100° and 205° F and at pressures of from 20 to 400 pounds per square inch, which corresponded to oil flows of from 1.8 to 9 pounds per minute.

Test-bearing measurements. - The test-bearing measurements were obtained in the manner described in reference 8 and are given in table II.

RESULTS AND DISCUSSION

The results of the experimental investigation are presented in figures 3 to 9. As in references 7 to 9, bearing temperature was chosen as the principal criterion of operation because it gives a good indication of the effects of all the operating variables.

DN Value

Effect of DN on operating temperatures. - The effect of DN on the outer-race-maximum and inner-race temperatures is shown in figure 3 for five oils at a load of 368 pounds, an oil flow of 2.75 pounds per minute, and oil inlet temperatures of 100° and 205° F. The outer-race-maximum and inner-race temperatures obtained were approximately linear functions of DN for all five oils and the bearing temperatures at a given DN value increased with increasing oil viscosity.

The total spread in bearing temperatures was greater at a given DN for an oil inlet temperature of 100° F (fig. 3(a)) than for an oil inlet temperature of 205° F (fig. 3(b)). These results are consistent in that the spread in viscosities of the five oils is greater at 100° than at 205° F. The viscosity indices of oils A, B, D, and E are approximately the same and the curves for these oils at both oil inlet temperatures show a general tendency to increase in slope with increasing oil viscosity. This trend may be attributed to the fact that the heat generated by churning is a function not only of viscosity but also of DN. Thus, the difference in heat generation (bearing temperature) between oils E and A, for example, increased with increasing DN.

Oil C, however, gave slightly different results for both outer-race-maximum and inner-race temperatures at both oil inlet temperatures. Because of its high viscosity index, oil C has a smaller viscosity-temperature gradient (see fig. 2). At high temperatures, oil C therefore assumes the same viscosity values as more viscous oils with lower viscosity indices.

2356

Effect of DN on oil outlet temperatures. - The effect of DN on oil outlet temperatures for deflected and transmitted oil is shown in figure 4 for a load of 368 pounds, an oil flow of 2.75 pounds per minute, and oil inlet temperatures of 100° and 205° F.

From considerations of power loss in the bearing and power rejected to the oil, oil outlet temperatures of both deflected and transmitted oil should increase with increasing DN. Reference 7 and figure 4 of this report show that such is the case. The curves of figure 4 for all five oils are similar and oil outlet temperatures for both deflected oil and transmitted oil are approximately linear functions of DN. Oil outlet temperatures of the transmitted oil showed a greater spread than did the oil outlet temperatures of deflected oil.

Effect of DN on ratio of deflected oil flow to transmitted oil flow. - The effect of DN on the ratio of deflected flow to transmitted flow was determined at a load of 368 pounds, an oil flow of 2.75 pounds per minute, and oil inlet temperatures of 100° and 205° F (fig. 5). In general, the ratio of deflected flow to transmitted flow increased with increasing DN.

Oil Flow

Effect of oil flow on operating temperature. - The effect of oil flow on the outer-race-maximum and inner-race temperatures is shown in figure 6 at a DN value of 1.2×10^6 , a load of 368 pounds, and oil inlet temperatures of 100° and 205° F.

At oil inlet temperatures of 100° and 205° F, the outer-race-maximum and the inner-race bearing temperatures decreased with increasing oil flow; the rate of change of bearing temperature with oil flow also decreased with increasing oil flow. As in figure 3, for a specific oil flow, bearing temperature generally increased with increasing viscosity at all flows.

Effect of oil flow on oil outlet temperatures. - The effect of oil flow on the oil outlet temperatures of deflected oil and transmitted oil was determined at a DN of 1.2×10^6 , a load of 368 pounds, and oil inlet temperatures of 100° and 205° F. The effect of oil viscosity on deflected-oil outlet temperatures over the flow range investigated was slight because of the relatively short time that the deflected oil was in contact with the bearing. The effect, however, of oil viscosity on transmitted-oil outlet temperatures was greater because the transmitted oil was in more intimate contact with the bearing for longer time intervals and because of churning effects.

2356

The general trend of increasing oil outlet temperatures with increasing oil viscosity holds throughout the range of oil flows investigated (fig. 7).

Effect of oil flow on the ratio of deflected flow to transmitted flow. - The effect of oil flow on the ratio of deflected flow to transmitted flow was determined at a load of 368 pounds, a DN value of 1.2×10^6 , and oil inlet temperatures of 100° and 205° F (fig. 8). Figure 8 shows that, in general, the ratio of deflected flow to transmitted flow decreased with increasing oil flow.

Effect of deflected and transmitted flows on bearing temperature, and outlet temperatures of the deflected and transmitted oil. - The interrelation of deflected-oil flow, transmitted-oil flow, outlet temperatures of deflected and transmitted oil, and bearing outer-race-maximum temperature was determined at a load of 368 pounds, a DN of 1.2×10^6 and oil inlet temperatures of 100° and 205° F (fig. 9). The four plots of figure 9(a) form an integral unit, as do those of figure 9(b), and must be used together.

The plots of figure 9(a) and (b) are valuable because they enable one to determine the oil flows and consequent oil outlet temperatures which maintained a constant bearing outer-race-maximum temperature regardless of which of the five oils was used as a lubricant and coolant. Figure 9 was used for analysis purposes in that the data on power rejected to the oil and on power absorbed in churning the oil were obtained from this figure.

ANALYSIS OF EXPERIMENTAL RESULTS

Explanations of all phenomena observed are unavailable at this time; the following discussion may, however, lead to a better understanding of the results obtained.

Viscosity

Effect of viscosity on bearing operating temperature. - Lubrication with an oil of high viscosity has the effect of increasing the operating temperature of a bearing of the type investigated when load, DN value, and oil flow are kept constant. The effect of viscosity on the outer-race-maximum temperature at a load of 368 pounds, a DN value of 1.2×10^6 , oil inlet temperatures of 100° and 205° F, and oil flows of 3.1, 5.9, and 8.8 pounds per minute is shown in figure 10 (data obtained from figs. 2 and 6). Oil flow and oil inlet temperature had a negligible effect on the functional relation between bearing temperature and oil viscosity.

2356

There appear to be two basic causes of the higher operating temperatures that resulted from the use of high viscosity oils. The first of these involves heat transfer by conduction between the bearing and the coolant. The film coefficient of heat transfer is a function of the oil viscosity (references 7, 9, and 11) among other variables; this coefficient decreases with increasing oil viscosity. The second cause of higher bearing temperatures originates in the oil itself, that is, the shearing of the oil within the bearing. The power required to shear the oil increases directly with viscosity. At high flows of the transmitted oil, the power losses due to shearing and churning become appreciable when the highly viscous oils are used.

Effect of viscosity on heat generated in bearing. - At a given DN and oil inlet temperature, the oil outlet temperatures of both the deflected and the transmitted oil increased with increasing viscosity (fig. 4). This result is interesting in that it proves that the heat generated in the bearing increased with increasing oil viscosity. The higher oil outlet temperatures of the more viscous oils (at constant total flow) establish the fact that the power rejected to the oil increased with increasing oil viscosity. This, together with the fact that bearing temperatures were higher for the more viscous oils (fig. 3) (which meant a greater rate of heat transfer to the surroundings), proves that heat was generated at a rate which increased with increasing oil viscosity.

Effect of viscosity on oil outlet temperatures. - In figure 9 it is shown that for a constant DN, load, and bearing outer-race-maximum temperature, the deflected-oil outlet temperature decreased with increasing oil viscosity, whereas the transmitted-oil outlet temperature increased. These results support the argument presented in the analysis of the effect of viscosity on bearing operating temperature. The lower deflected-oil outlet temperatures that resulted when high viscosity oils were used at a constant bearing temperature and DN demonstrate that the film coefficient of heat transfer decreased with increasing oil viscosity. The higher transmitted-oil outlet temperatures that resulted when the high viscosity oils were used at a constant bearing temperature and DN demonstrate that heat generated by the shearing and the churning of the oil within the bearing increased with increase in oil viscosity.

Effect of viscosity on power rejected to oil. - The total power rejected to the oil is plotted as a function of oil viscosity for a load of 368 pounds and a DN of 1.2×10^6 in figure 11. Two examples are plotted, one for a bearing outer-race-maximum temperature of 240° F and an oil inlet temperature of 100° F, and the other for a bearing outer-race-maximum temperature of 300° F and an oil inlet temperature of 205° F. Data from figure 9 for oils A, B, C, and D were used to obtain figure 11. Data for oil E were not used because extrapolation would have been required. The method used in calculating the horsepower rejected to the oil is outlined in appendix A. In general, the heat load on the

N
U
U
S

2356

lubricating system tended to increase with an increase in oil viscosity. In some present turbojet engines, lubricant cooling constitutes a serious problem, and the use of high-viscosity lubricants for the high-speed bearings would serve only to aggravate the problem. For turboprop engines, it is desirable to lubricate gears with a high-viscosity lubricant, but to attempt to lubricate bearings with this same lubricant would result in high bearing operating temperatures.

In appendix B, a method of comparing the five oils used in this investigation with respect to power losses due to shearing or churning is derived. An absolute means of calculating the power loss due to shearing and churning could not be developed inasmuch as bearing friction torque was not measured. The method was applied to the two groups of data used in calculating total power rejected to the oil. The results of the calculations are plotted in figure 12 as horsepower generated in churning oil (B, C, D, or E) minus that generated in churning oil A against oil viscosity at the inlet temperature for the following conditions: a load of 368 pounds, a DN of 1.2×10^6 , oil inlet temperatures of 100° and 205° F, and bearing outer-race-maximum temperatures of 240° and 300° F. Power loss due to shearing and churning was found to increase with increasing oil viscosity. Not only do high-viscosity oils cause higher bearing temperatures because of their poor cooling properties, but they also increase the power that must be dissipated.

Oil Flow

Effect of oil flow on bearing operating temperature. - Because bearing temperature is high for a high viscosity oil at constant oil flow, a high flow of a high-viscosity oil is required to maintain a constant bearing temperature; this is shown in figure 13 for two cases: a bearing outer-race-maximum temperature of 240° F with an oil inlet temperature of 100° F and a bearing outer-race-maximum temperature of 300° F with an oil inlet temperature of 205° F. In each case, data from figure 6 for oils A, B, C, and D were used; use of the data for oil E would have required the extrapolation of curves. In figures 13(a) and 13(b), which are very similar, the oil flow necessary to maintain a constant bearing temperature appears to be a linear function of the log of the oil viscosity at the inlet temperature within the viscosity range investigated.

DN and Oil Flow

Effect of DN and oil flow on ratio of deflected flow to transmitted flow. - The effects of DN and oil flow on the ratio of deflected flow to transmitted flow are closely related and are therefore discussed and analyzed together.

Physical reasoning reveals that the ratio of deflected flow to transmitted flow will be a function of the angle θ (fig. 14) between the axis of rotation and the vector \bar{V}

$$\bar{V} = \bar{u} (\bar{V}_0 \cdot \bar{u}) - \bar{r} \times \bar{\omega} \quad (1)$$

where

\bar{V}_0 oil-velocity vector

\bar{u} unit vector in direction of axis of rotation

$\bar{\omega}$ rotational-velocity vector

\bar{r} radius vector drawn from any point on axis of rotation to point on bearing where oil jet strikes

If the oil jet is directed at the cage-locating surface, the ratio of deflected flow to transmitted flow will be a function also of the clearance between the cage-locating surface and the inner race at the point of impingement. The clearance is a complex function of DN and continuously varying cage loads so that its effect on the ratio of deflected flow to transmitted flow varies with time and is extremely difficult to determine.

This analysis reveals (as did the analyses of references 7 and 9) that the ratio of deflected flow to transmitted flow varies inversely with $\cos \theta$ and should therefore increase with increasing DN and decrease with increasing oil flow while other factors are held constant. The validity of the analysis is confirmed by figures 5 and 8. The one exception to the rule occurs in the DN curve for oil E at an oil inlet temperature of 100° F (see fig. 5(a)). The cause of this deviation cannot be stated specifically.

At the relatively low oil flows, the fact that the ratio of deflected flow to transmitted flow increases with increasing DN may constitute a disadvantage as regards cooling efficiency because at low transmitted-oil flows the power loss and consequent bearing-temperature rise caused by oil churning may not be significant compared with the cooling effectiveness of the oil which travels through the bearing. However, at very high transmitted-oil flows (such as might be obtained by partly submerging the bearing and forcing all oil through the bearing) the reverse may possibly be true. In reference 2, the operating temperature of roller bearings running in a pool of oil is reported to have increased as the oil level was raised to the level of the top of the lowest roller.

2356

Oil Inlet Temperature

2356

Effect of oil inlet temperature on power rejected to oil. - Calculations were made to determine the effect of oil inlet temperature on the power rejected to the oil at a constant bearing temperature, DN and load. The available data made it possible to make just two calculations for oils B, C, D, and E without extrapolating the curves of figure 9 to any great extent. The results of the calculations, shown in table III, demonstrate that for a constant bearing temperature the total power rejected to the oil decreased slightly with increasing oil inlet temperature. For each oil, the power rejected to the deflected oil decreased whereas the power rejected to the transmitted oil increased with increasing oil inlet temperature.

There are two possible explanations for the decrease in total measured power rejected to the oil: either the churning losses are lower at the higher oil inlet temperature, or the coefficients of heat transfer involved in the transfer of heat to the surroundings are influenced by oil inlet temperature. The first explanation appears implausible when it is noted that the ratio of transmitted oil flow at 205° F to that at 100° F was as high as 87 (oil B, table III). The increase in heat generation due to the higher transmitted-oil flow more than offset the decrease in heat generation due to the lower viscosity at 205° F. It may be concluded, then, that the heat-transfer coefficients are influenced by oil inlet temperature.

For all oils except oil E (table III), high oil flows were required at high oil inlet temperatures to maintain a constant bearing temperature. However, the very high viscosity of oil E at 100° F evidently caused churning losses which produced the very high bearing temperature.

The foregoing results and analysis lead to two general conclusions regarding bearing temperature and oil system heat load: For minimum bearing temperature (with DN, load, oil flow, and oil inlet temperature constant), the use of a low-viscosity, low viscosity-index oil is recommended. For minimum power rejection to the oil at a constant bearing temperature, a low-viscosity oil introduced at a high inlet temperature is recommended.

Cooling-Correlation Theory

A cooling-correlation analysis, which resulted in the development of cooling-correlation curves for both inner-race and outer-race temperatures, is presented in references 7 and 9.

The general equation developed is

$$\frac{\Delta T}{(DN)^a} = B \left(\frac{d^x}{M} \mu^z \right)^n \quad (2)$$

From this relation, the inner-race equation obtained is

$$\frac{T_{IR} - T_{OI}}{(DN)^{1.2}} = B_1 \left(\frac{d^{0.8}}{M} \mu^{0.7} \right)^{0.45} \quad (3)$$

the outer-race equation is

$$\frac{T_{OR} - T_{OI}}{(DN)^{1.2}} = B_2 \left(\frac{d^{0.5}}{M} \mu^{0.7} \right)^{0.36} \quad (4)$$

where

- B_1 and B_2 constants
- d oil-jet diameter (in)
- M oil flow (lb/min)
- ΔT difference between bearing temperature and oil inlet temperature
- T_{IR} inner race temperature ($^{\circ}F$)
- T_{OI} oil inlet temperature ($^{\circ}F$)
- T_{OR} outer race temperature ($^{\circ}F$)
- μ oil viscosity at inlet temperature (lb-sec/in²)

In references 7 and 9, the effects of d and T_{OI} are thoroughly investigated. These variables were found to correlate well with the theory. The study of viscosity is incomplete, however, because only one oil (oil C of this report) was used. Viscosity was varied from 11×10^{-7} to 53×10^{-7} reyns (reference 7) by varying the oil inlet temperature over the range 100° to 205° F. The viscosities of the five oils used in the present investigation varied from 2×10^{-7} to 470×10^{-7} reyns at the inlet temperatures and the influence of these oils on the degree of correlation is reported herein.

Inner-race cooling correlation. - The method of determining the exponents of the equation for the inner-race cooling correlation is given in reference 7. The exponents used in this reference were also found to give the best correlation for the present problem. The final cooling-correlation curve for the inner-race temperature is presented in figure 15; the degree of correlation is fair. The significance of

2356

the scatter in figure 15 is illustrated by the dashed lines on either side of the cooling-correlation curve. The dashed lines represent a temperature variation of $\pm 5^{\circ}$ F at a DN of 0.735×10^6 .

For convenience, the data are presented in two ways: Figure 15(a) is the inner-race cooling correlation curve with DN as parameter, and figure 15(b) is the inner-race cooling correlation curve with oil type as parameter. Examination of the degree of correlation of DN and of viscosity can thus be made independently.

The plots represent a useful method of obtaining a first approximation of bearing inner-race temperature and of determining the effect of DN, oil viscosity, oil flow, oil inlet temperature, and oil-jet diameter on bearing inner-race temperature. The estimated range of applicability of the inner-race cooling-correlation curve (fig. 15) is as follows: DN, 0.735×10^6 to 1.2×10^6 ; oil viscosity at inlet temperatures, 2×10^{-7} to 470×10^{-7} reyns; oil flow, 2 to 10 pounds per minute (corresponding to oil inlet pressures of 5 to 400 lb/sq in.); oil inlet temperature, 100° to 205° F; oil-jet diameter, 0.023 to 0.129 inch; and load, 300 to 1100 pounds. Even though these data were obtained at a load of 368 pounds, the final inner-race cooling curve may be used as a first approximation for loads from about 300 to 1100 pounds inasmuch as it is shown in reference 8 that the inner-race bearing temperature changes but slightly over this load range. Points for a DN of 0.3×10^6 are shown in figure 15(a) but the degree of correlation at this DN value is poor.

For the conditions investigated, the slope of the inner-race cooling correlation curve was 14.3×10^{-4} . This value is within 7.5 percent of the value of 15.4×10^{-4} obtained in reference 7.

Outer-race cooling correlation. - The final cooling-correlation curve for the outer-race-maximum temperature is presented in figure 16. The method given in reference 7 for determining the exponents was used and the exponents determined therein were also found to give the best correlation for the present data. The significance of the scatter in figure 16 is illustrated by the dashed lines on either side of the cooling-correlation curve. The dashed lines represent a temperature variation of $\pm 5^{\circ}$ F at a DN of 0.735×10^6 .

The data of figure 16 are presented in a manner similar to that of figure 15. Again, the degree of correlation is fair. The plot represents a useful method of obtaining a first approximation of bearing outer-race-maximum temperature and of determining the effect of DN, oil-jet diameter, oil viscosity, oil inlet temperature, and oil flow on bearing outer-race-maximum temperature.

The estimated range of applicability of the outer-race cooling-correlation curve (fig. 16) is the same as that of figure 15. Points for a DN of 0.3×10^6 are shown in figure 16(a) but the degree of correlation at this DN is poor.

For the conditions investigated, the slope of the outer-race cooling-correlation curve was found to be 4.3×10^{-4} ; this is within 3 percent of the value of 4.42×10^{-4} obtained in reference 7.

RESULTS AND CONCLUSIONS

The following results were obtained in an experimental investigation of a 75-millimeter-bore (size 215) cylindrical-roller cage-type bearing which was operated over a range of DN values (bearing bore in mm times shaft speed in rpm) from 0.3×10^6 to 1.2×10^6 and lubricated by five oils of varying viscosity that were introduced through a single jet:

1. A previously developed cooling-correlation analysis was extended to include fully the effect of varying viscosity on the validity of the following equation:

$$\frac{\Delta T}{(DN)^a} = B \left(\frac{d^x}{M} \mu^z \right)^n$$

where ΔT is the difference between the bearing temperature and oil inlet temperature, DN is the product of the bearing bore in millimeters and the shaft speed in rpm; B is a constant; d is the oil-jet diameter in inches; M is the oil flow in pounds per minute; and μ is the oil inlet viscosity in pound seconds per square inch. The correlation was fair over the viscosity range from 2.0×10^{-7} to 470×10^{-7} reyns at the inlet to the test bearing.

2. For both inner-race and outer-race temperatures, the best degree of correlation was obtained with the exponents previously derived and the same values of x were used for simplicity. The constants that apply to the present correlation as well as to the previous correlation (except in the case of B) are as follows:

Constant	Inner race	Outer race
a	1.2	1.2
B	14.3×10^{-4}	4.3×10^{-4}
x	0.8	0.5
z	.7	.7
n	.45	.36

8559

The values of B agreed with those previously obtained within 7.5 percent and 3 percent, respectively, for the inner-race and the outer-race correlation curves.

3. At a given DN, load, and oil flow bearing temperatures increased with increasing viscosity. A high oil flow of a more viscous oil is therefore required to maintain a constant bearing temperature. The rate of increase of bearing temperature with increasing DN was greater for an oil of high viscosity index. The lowest bearing temperatures therefore resulted when a low-viscosity, low viscosity-index oil was used.

4. At a constant bearing temperature, DN, and load, the power rejected to the oil increased with increasing viscosity. At a constant bearing temperature, DN, and load with lubrication by a specific oil, the measured power rejected to the oil decreased with increasing oil inlet temperature within the range investigated. Therefore, at a given bearing temperature, the power rejected to the oil will be lowest when the oil viscosity is low and the oil inlet temperature high. This conclusion may lack general validity and, in particular, may not be true if heat flows to the bearing from its surroundings.

5. The increase in heat load on the oil system with increasing viscosity, at a constant bearing temperature, was due mainly to increased power losses caused by churning within the bearing.

Lewis Flight Propulsion Laboratory
National Advisory Committee for Aeronautics
Cleveland, Ohio, November 5, 1951

2376

APPENDIX A

METHOD OF CALCULATING HORSEPOWER REJECTED TO THE OIL

The following symbols are used in this appendix:

- C specific heat, Btu/(lb)(°F)
- q rate of heat rejection, hp
- M oil flow, lb/min
- M_D deflected-oil flow, lb/min
- M_T transmitted-oil flow, lb/min
- T temperature, °R
- T_{OI} oil inlet temperature, °R
- T_{DO} deflected-oil outlet temperature, °R
- T_{TO} transmitted-oil outlet temperature °R

The basic equation involved is

$$dq = A M C dT \tag{A1}$$

where A is a constant.

Each of the five oils has a slightly different specific heat which varies with temperature. However, data published by Socony-Vacuum Oil Co. Inc. show that the following expression for the specific heat of the five oils is accurate to within 1 percent:

$$C = 0.195 + 0.000478 T \tag{A2}$$

When equation (A2) is substituted into equation (A1) and the resulting expression is integrated for both deflected oil and transmitted oil,

$$q = A \left[M_D \int_{T_{OI}}^{T_{DO}} (0.195 + 0.000478 T) dT + M_T \int_{T_{OI}}^{T_{TO}} (0.195 + 0.000478 T) dT \right]$$

9222

Evaluation of the integral and conversion to horsepower gives

$$q = 0.0235 \left\{ M_D \left[0.195(T_{DO} - T_{OI}) + 0.000239(T_{DO}^2 - T_{OI}^2) \right] + M_T \left[0.195(T_{TO} - T_{OI}) + 0.000239(T_{TO}^2 - T_{OI}^2) \right] \right\}$$

2356

APPENDIX B

BEARING HEAT BALANCE

The following symbols are used in this appendix:

- C specific heat of oil, Btu/(lb)(°F)
- H_{GB} heat generated due to bearing friction, Btu/min
- H_{GO} heat generated in churning oil, Btu/min
- H_{RD} heat removed by deflected oil, Btu/min
- H_{RR} heat removed by radiation to surroundings, Btu/min
- H_{RS} heat removed by conduction and convection to surroundings, Btu/min
- H_{RT} heat removed by transmitted oil, Btu/min
- M oil flow, lb/min
- M_D deflected-oil flow, lb/min
- M_T transmitted-oil flow, lb/min
- T temperature, °R
- T_B bearing temperature, °R
- T_{DO} deflected-oil outlet temperature, °R
- T_{OI} oil inlet temperature, °R
- T_R room temperature, °R

Bearing heat balance. - In a specific time interval, for equilibrium operation of a bearing, the heat generated in the bearing will equal the heat removed from the bearing. Then

$$H_{GB} + H_{GO} = H_{RS} + H_{RR} + H_{RD} + H_{RT} \quad (B1)$$

In the discussion that follows, the following assumptions are made:

- (1) H_{GB} is constant for a given DN and load for a specific bearing.

2356

(2) The total heat loss to the surroundings ($H_{RS} + H_{RR}$) is constant for given T_B and T_R .

With these assumptions the following equations will be qualitatively valid:

$$H_{RD} = M_D \int_{T_{OI}}^{T_{DO}} C dT \quad (B2)$$

and

$$H_{RT} = M_T \int_{T_{OI}}^{T_{TO}} C dT \quad (B3)$$

Substitution of equations (B2) and (B3) into equation (B1) yields

$$H_{GB} + H_{GO} = H_{RS} + H_{RR} + M_D \int_{T_{OI}}^{T_{DO}} C dT + M_T \int_{T_{OI}}^{T_{TO}} C dT \quad (B4)$$

Now for $T_B = 240^\circ F$ and $T_{OI} = 100^\circ F$, the following data can be obtained from figure 9:

Oil	Deflected-oil flow (lb/min)	Deflected-oil outlet temperature ($^\circ R$)	Transmitted-oil flow (lb/min)	Transmitted-oil outlet temperature ($^\circ R$)
A	2.2	617	0.03	662
B	3.35	607.5	.12	675
C	4.75	592.5	.39	683
D	5.05	590	.65	702

Substituting equation (A2) and the foregoing data into equation (B4), and integrating yield the following equation:

$$H_{GB} + (H_{GO})_A = (H_{RS}) + (H_{RR}) + 59.7 + 1.5 \quad (B5a)$$

$$H_{GB} + (H_{GO})_B = (H_{RS}) + (H_{RR}) + 75.4 + 6.8 \quad (B5b)$$

2356

$$H_{GB} + (H_{GO})_C = (H_{RS}) + (H_{RR}) + 72.6 + 23.6 \quad (B5c)$$

and

$$H_{GB} + (H_{GO})_D = (H_{RS}) + (H_{RR}) + 70.6 + 45.8 \quad (B5d)$$

From equations (B5a) through (B5d) the following relations are obtained:

$$\begin{aligned} (H_{GO})_B - (H_{GO})_A &= 21.0 \text{ Btu/min} \\ &= 0.494 \text{ horsepower} \end{aligned} \quad (B6a)$$

$$\begin{aligned} (H_{GO})_C - (H_{GO})_A &= 35.0 \text{ Btu/min} \\ &= 0.823 \text{ horsepower} \end{aligned} \quad (B6b)$$

and

$$\begin{aligned} (H_{GO})_D - (H_{GO})_A &= 55.2 \text{ Btu/min} \\ &= 1.30 \text{ horsepower} \end{aligned} \quad (B6c)$$

In a similar manner, the following data were obtained for $T_B = 300^\circ \text{ F}$ and $T_{OI} = 205^\circ \text{ F}$ from figure 9:

Oil	Deflected-oil flow (lb/min)	Deflected-oil outlet temperature ($^{\circ}\text{R}$)	Transmitted-oil flow (lb/min)	Transmitted-oil outlet temperature ($^{\circ}\text{R}$)
A	2.6	701	0.06	729
B	3.8	693	.18	738
C	7.0	680.5	.56	740
D	7.2	675.5	.65	750

$$H_{GB} + (H_{GO})_A = (H_{RS}) + (H_{RR}) + 48.8 + 2.0 \quad (B7a)$$

$$H_{GB} + (H_{GO})_B = (H_{RS}) + (H_{RR}) + 55.3 + 7.0 \quad (B7b)$$

$$H_{GB} + (H_{GO})_C = (H_{RS}) + (H_{RR}) + 56.0 + 22.3 \quad (B7c)$$

$$H_{GB} + (H_{GO})_D = (H_{RS}) + (H_{RR}) + 40.5 + 29.5 \quad (B7d)$$

2356

$$\begin{aligned} (H_{GO})_B - (H_{GO})_A &= 11.5 \text{ Btu/min} \\ &= 0.270 \text{ horsepower} \end{aligned} \tag{B8a}$$

$$\begin{aligned} (H_{GO})_C - (H_{GO})_A &= 27.5 \text{ Btu/min} \\ &= 0.645 \text{ horsepower} \end{aligned} \tag{B8b}$$

$$\begin{aligned} (H_{GO})_D - (H_{GO})_A &= 19.2 \text{ Btu/min} \\ &= 0.452 \text{ horsepower} \end{aligned} \tag{B8c}$$

REFERENCES

1. Styri, Haakon: Friction Torque in Ball and Roller Bearings. Mech. Eng., vol. 62, no. 12, Dec. 1940, pp. 886-890.
2. Rosenfeld, L.: Friction of Ball and Roller Bearings. Engineering, vol. 158, no. 4107, Sept. 29, 1944, pp. 257-258; cont., vol. 158, no. 4108, Oct. 6, 1944, pp. 278-280.
3. Brewer, A. F.: Bearing Lubrication Progress Paced by Cooperative Research. Aero. Digest, vol. 51, no. 2, Oct. 15, 1945, pp. 60-61; cont. 114, 118, 120.
4. Anon.: Being Practical About Oil Viscosity. Power, vol. 94, no. 9, Sept. 1950, p. 117.
5. Towle, A.: Some Problems in the Successful Development of a High-Duty Engine. Jour. Inst. Auto. Eng. (London), vol. XIV, no. 1, Oct. 1945, pp. v-vxiii.
6. Dawson, J. G.: Lubricating Problems of the Gas Turbine Engine. Shell Aviation News, no. 133, July 1949, pp. 14-22.
7. Macks, E. Fred, and Nemeth, Zolton N.: Investigation of 75-Millimeter-Bore Cylindrical-Roller Bearings at High Speeds. III - Lubrication and Cooling Studies - Oil Inlet Distribution, Oil Inlet Temperature, and Generalized Single-Oil-Jet Cooling-Correlation Analysis. NACA TN 2420, 1951.
8. Macks, E. Fred, and Nemeth, Zolton N.: Investigation of 75-Millimeter-Bore Cylindrical Roller Bearings at High Speeds. I - Initial Studies. NACA TN 2128, 1950.
9. Macks, E. Fred, and Nemeth, Zolton N.: Investigation of 75-Millimeter-Bore Cylindrical-Roller Bearings at High Speeds. II - Lubrication Studies - Effect of Oil-Inlet Location, Angle, and Velocity for Single-Jet Lubrication. NACA TN 2216, 1950.

2356

10. Tarr, Philip R.: Methods for Connection to Revolving Thermocouples. NACA RM E50J23a, 1951.
11. Jacob, Max: Heat Transfer, Vol. 1. John Wiley & Sons, Inc., 1949, pp. 543-566.
12. Getzlaff, Günter: Experiments on Ball and Roller Bearings under Conditions of High Speed and Small Oil Supply. NACA TM 945, 1940.
13. Wilcock, Donald F., and Jones, Frederick C.: Improved High-Speed Roller Bearings. Lubrication Eng., vol. 5, no. 3, June 1949, pp. 129-133.

2356

00007

TABLE I - VARIATION IN VISCOSITY OF OILS AS FOUND IN
 LABORATORY TESTS OF SAMPLES TAKEN



Oil	Kinematic viscosity at 100 °F (centistokes)			Maximum variation from mean (percent)
	Minimum	Mean	Maximum	
A	4.32	5.08	5.38	14.9
B	10.20	10.29	10.43	1.36
C	30.83	35.42	40.33	13.8
D	79.09	79.38	79.67	.37
E	357.6	370.9	388.4	4.7

TABLE II - PHYSICAL CHARACTERISTICS OF TEST BEARING^a



Bearing number	18	
Construction	One-piece inner-race-riding cage	
Number of rollers	18	
Roller length-diameter ratio	1	
Pitch diameter of bearing, (in.)	4.036	
Total running time, (hr)	Before	After
	Unknown	+86.5
^b Severity factor	Unknown	+6.28×10 ⁵
Roller diameter, (in.)	^c 0.5513	0.5513
Roller length, (in.)	^c 0.5510	0.5500
Diametral clearance between cage and roller, (in.)	^c 0.0087	0.006
Axial clearance between roller and inner-race flange, (in.)	^c 0.002	0.003
Axial clearance between roller and cage, (in.)	^c 0.006	0.008
Unmounted bearing:		
Diametral clearance, (in.)		
Bearing	0.0018	0.0015
Cage	.014	.0215
Eccentricity	.0001	.0000
Mounted bearing:		
Diametral clearance, (in.)		
Bearing	0.0004	0.0004
Cage	.013	.0205
Eccentricity	-----	-----

^aObtained as in reference 7.

^bSummation of products of difference between equilibrium maximum bearing temperature and oil inlet temperature for each operating condition and corresponding operating time in min. at that particular condition.

^cMeasurements obtained from sample bearing.

TABLE III - POWER REJECTED TO OIL



Oil	Oil inlet temperature (°F)	Bearing outer-race-maximum temperature (°F)	Flow of deflected oil (lb/min)	Flow of transmitted oil (lb/min)	Deflected-oil outlet temperature (°F)	Transmitted-oil outlet temperature (°F)	Power rejected, (hp)		
							To deflected oil	To transmitted oil	Total
B	100	272	1.8	0.01	173	225	1.47	0.01	1.48
	205		8.6	0.87	213	258	0.85	0.57	1.42
C	100	292	1.8	0.01	198	251	2.03	<0.01	2.03
	205		8.3	0.75	213	275	0.87	0.66	1.53
D	100	300	1.9	0.07	174	280	1.59	0.15	1.74
	205		7.2	0.65	216	290	0.97	0.70	1.67
E	100	340	3.9	0.14	134	315	1.47	0.36	1.83
	205		2.5	0.45	229	324	0.76	0.64	1.40

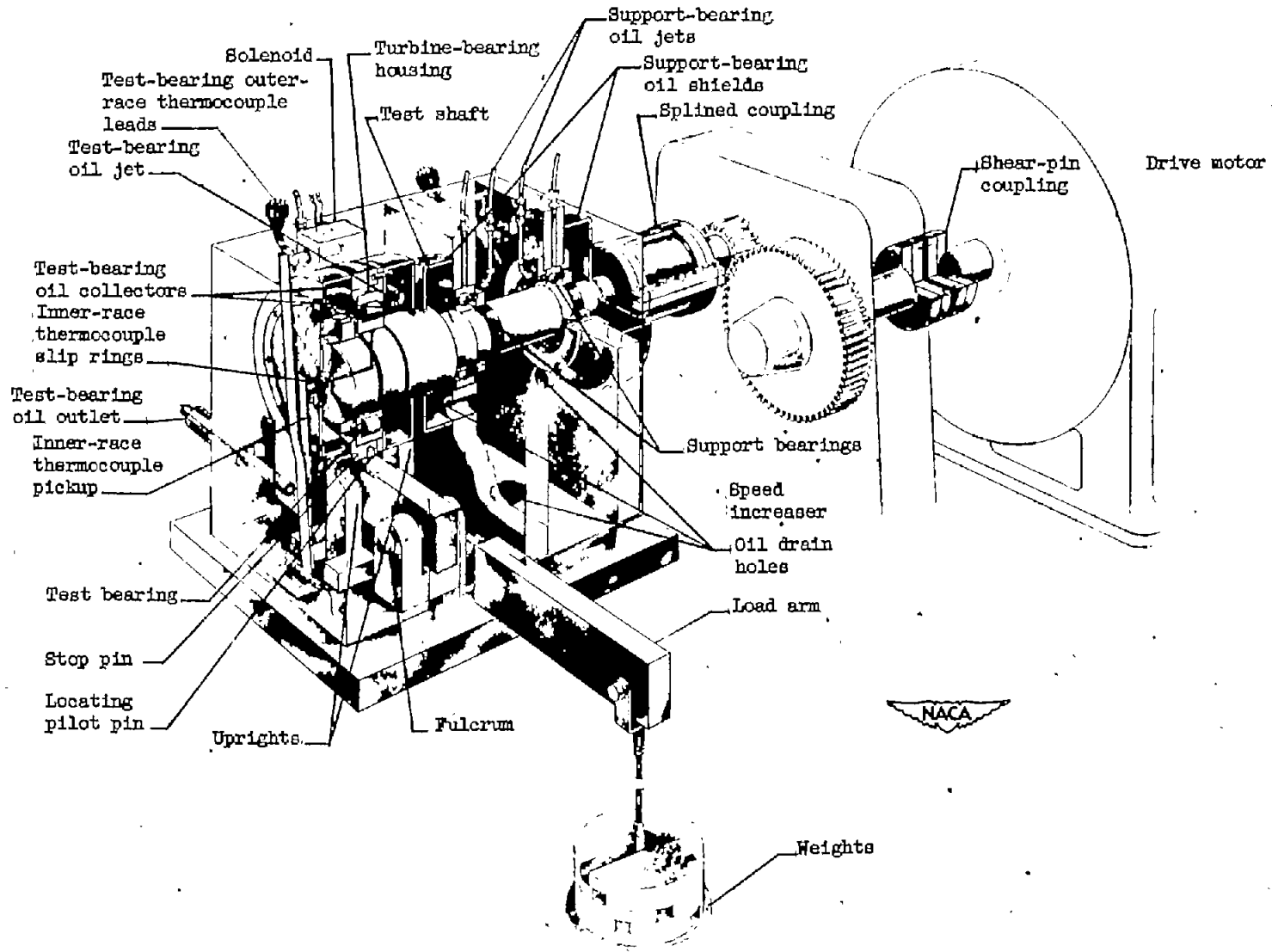

Figure 1. - Cutaway view of radial-load rig.

2356

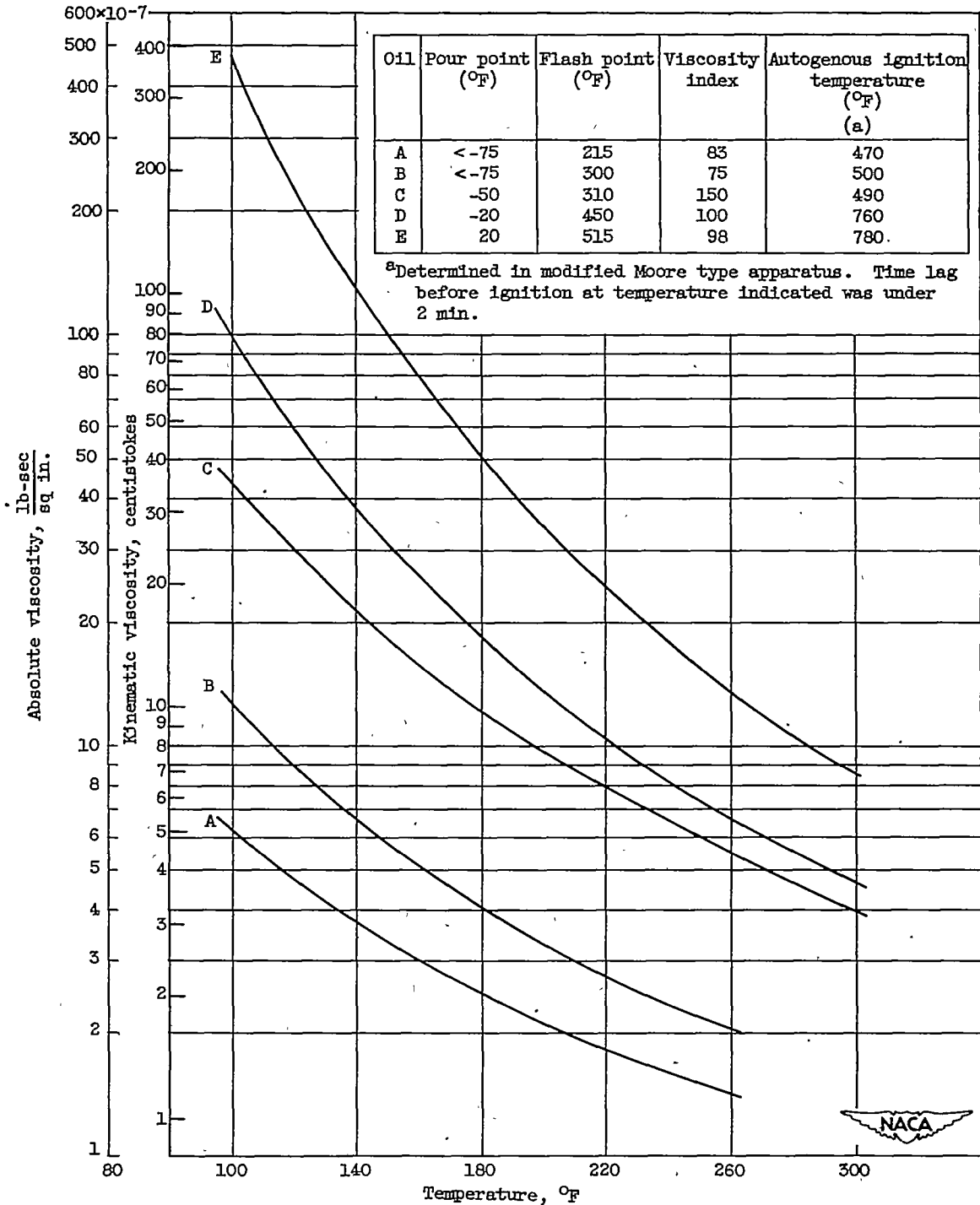

Figure 2. - Effect of temperature on kinematic and absolute viscosities of five test oils.

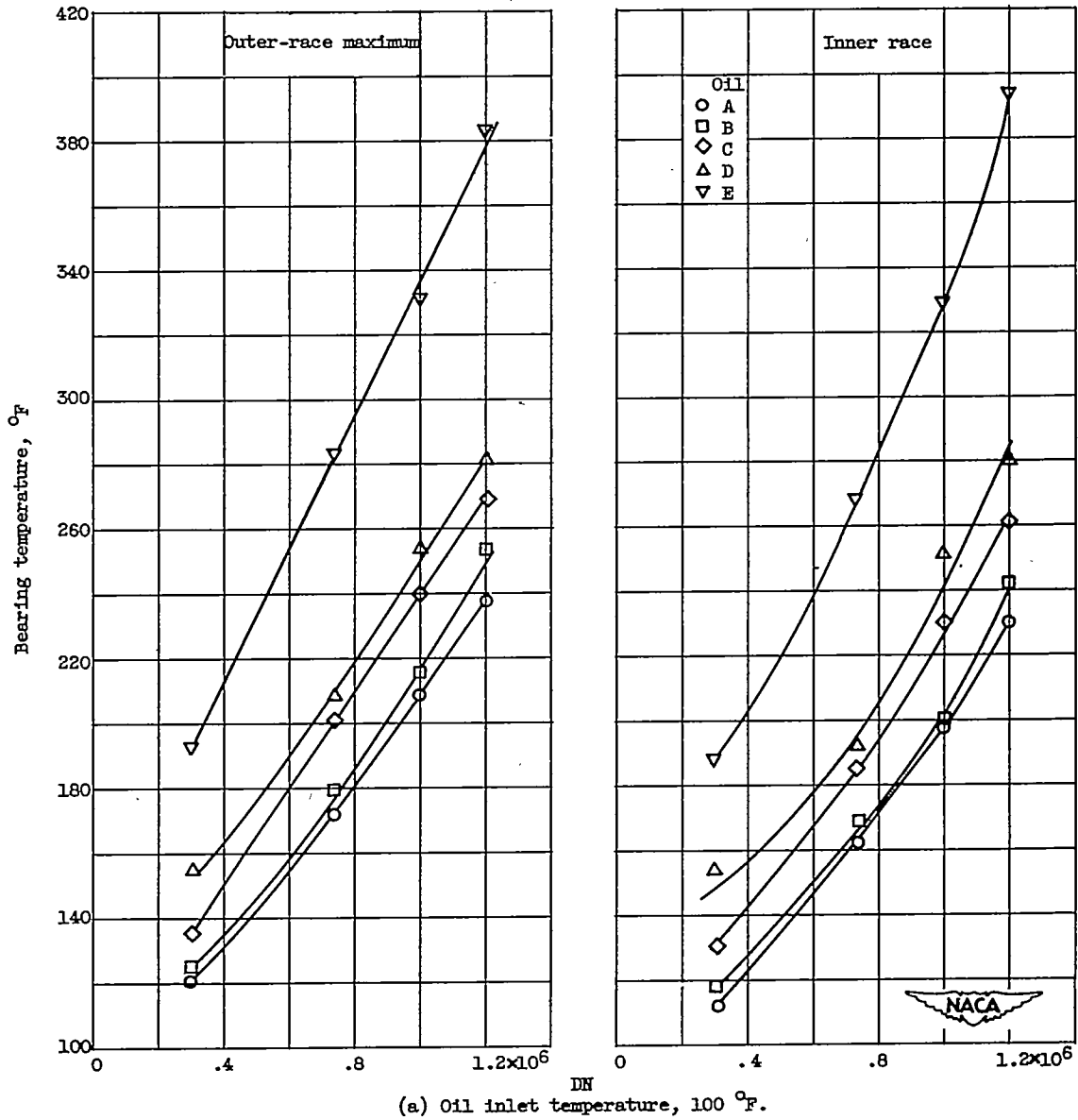

Figure 3. - Effect of DN on outer-race-maximum and inner-race temperatures of bearing 18. Load, 368 pounds; oil flow, 2.75 pounds per minute.

2356

2356

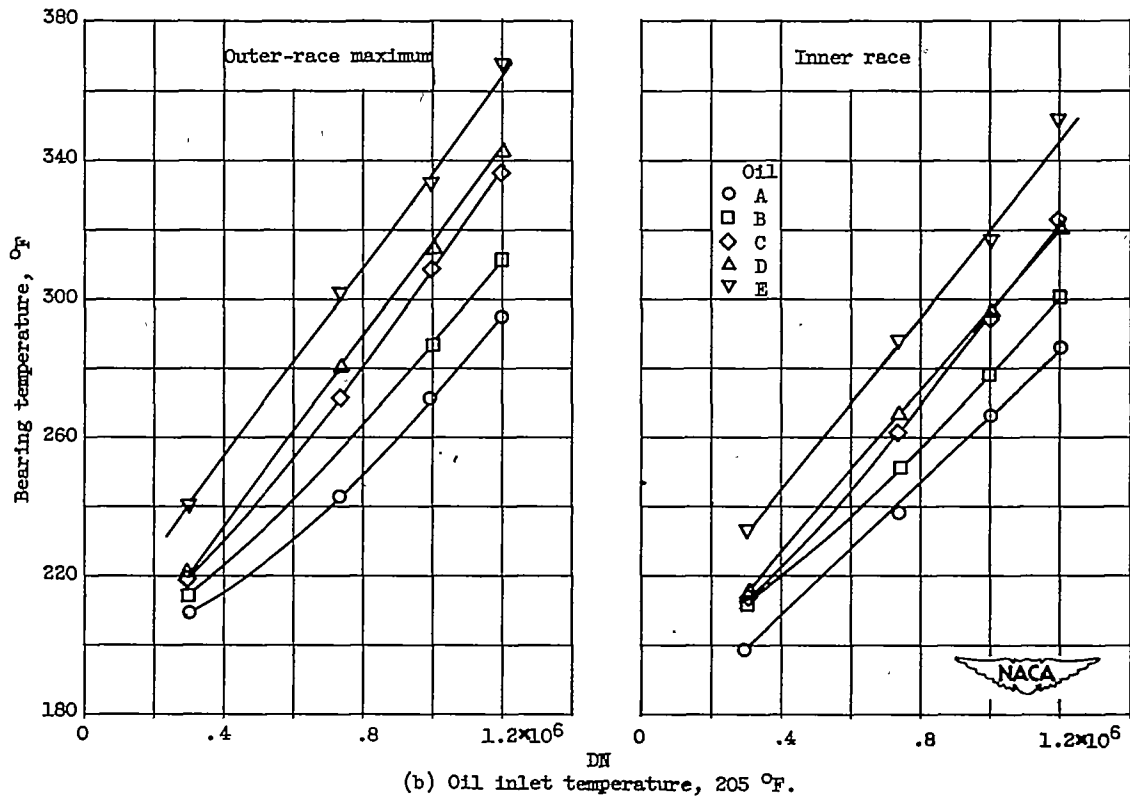
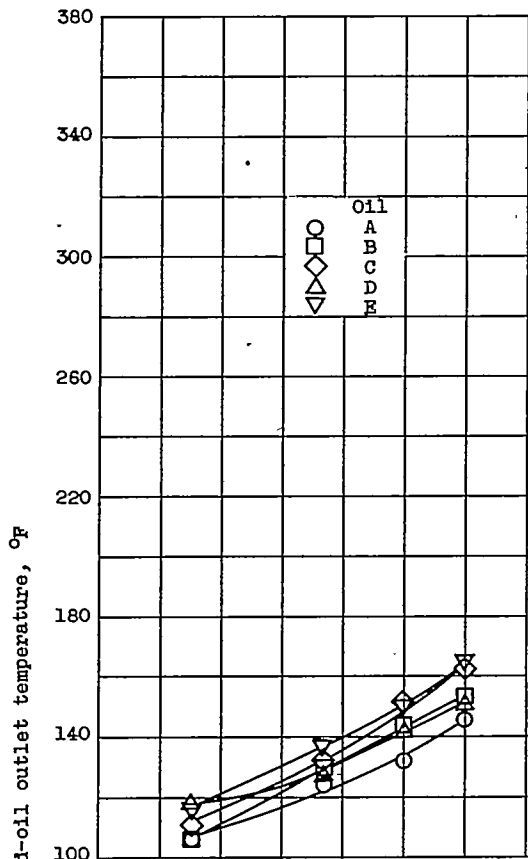
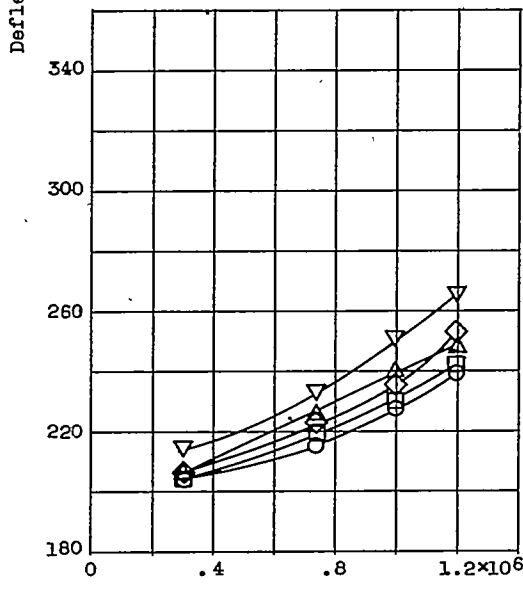
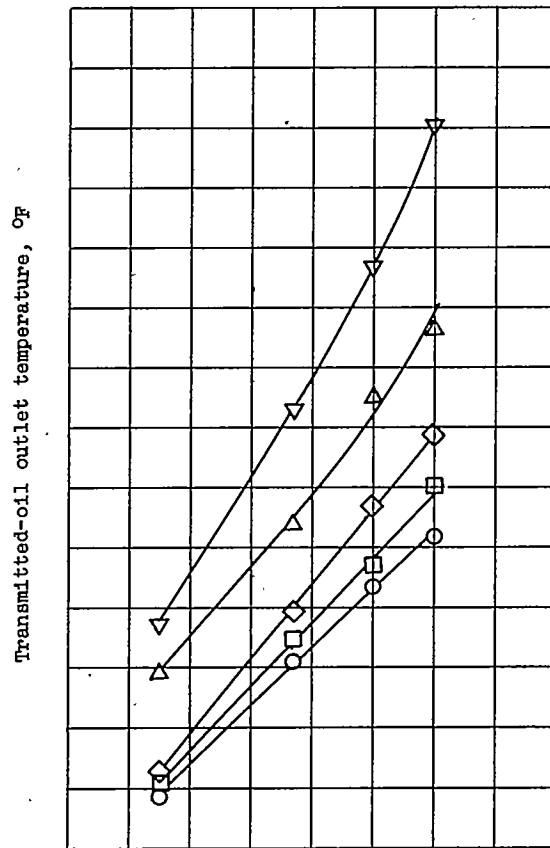

Figure 3. - Concluded. Effect of DN on outer-race-maximum and inner-race temperatures of bearing 18. Load, 368 pounds; oil flow, 2.75 pounds per minute.



(a) Oil inlet temperature, 100° F.



(b) Oil inlet temperature, 205° F.

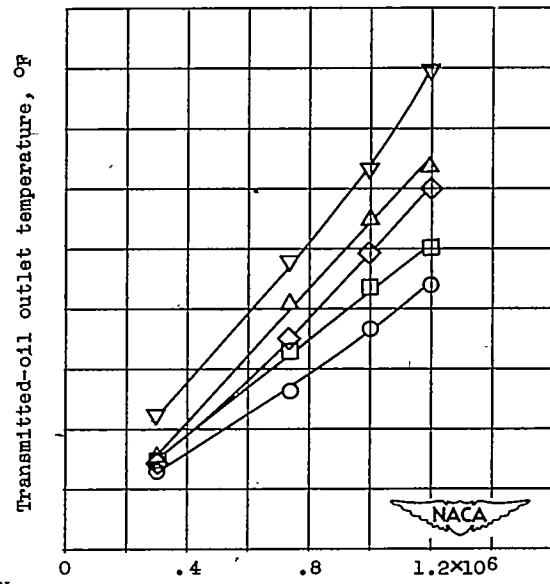
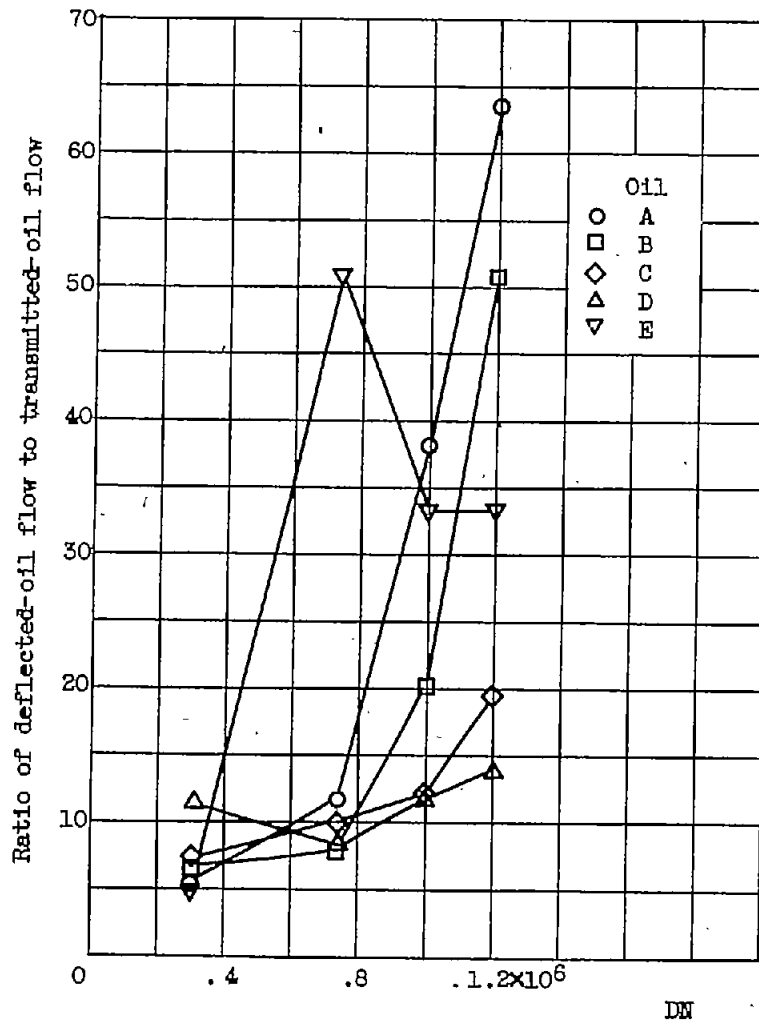
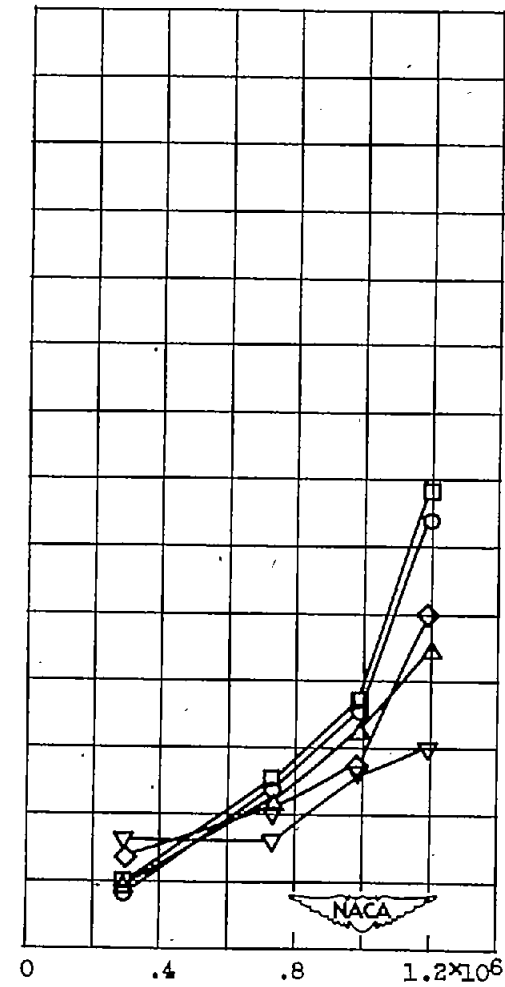

Figure 4. - Effect of DN on deflected- and transmitted-oil outlet temperatures. Load, 368 pounds; oil flow, 2.75 pounds per minute.





(a) Oil inlet temperature, 100 °F.



(b) Oil inlet temperature, 205 °F.

Figure 5. - Effect of DN on ratio of deflected- to transmitted-oil flow. Load, 368 pounds; oil flow, 2.75 pounds per minute; oil-jet diameter, 0.050 inch.

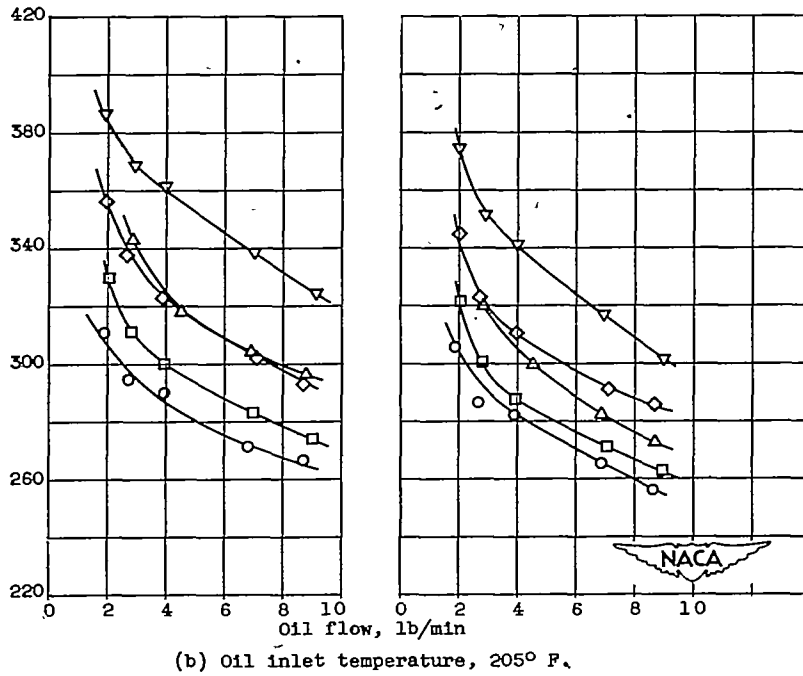
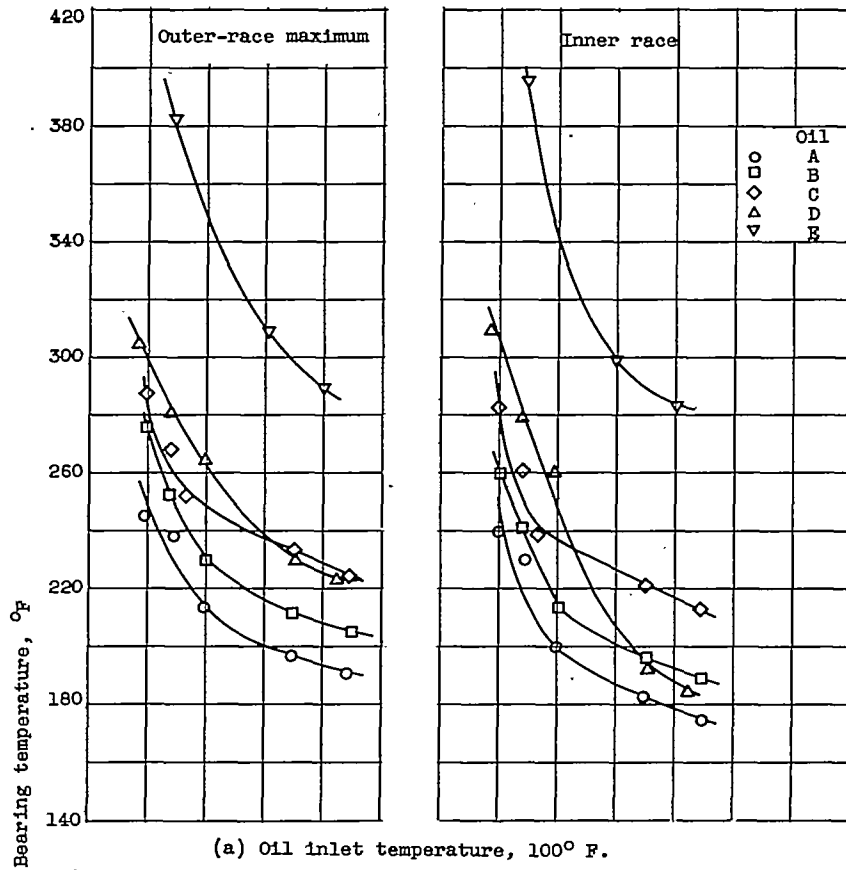

Figure 6. - Effect of oil flow on outer-race-maximum and inner-race temperatures of bearing 18. Load, 368 pounds; DN, 1.2×10^6 .

2356

2356

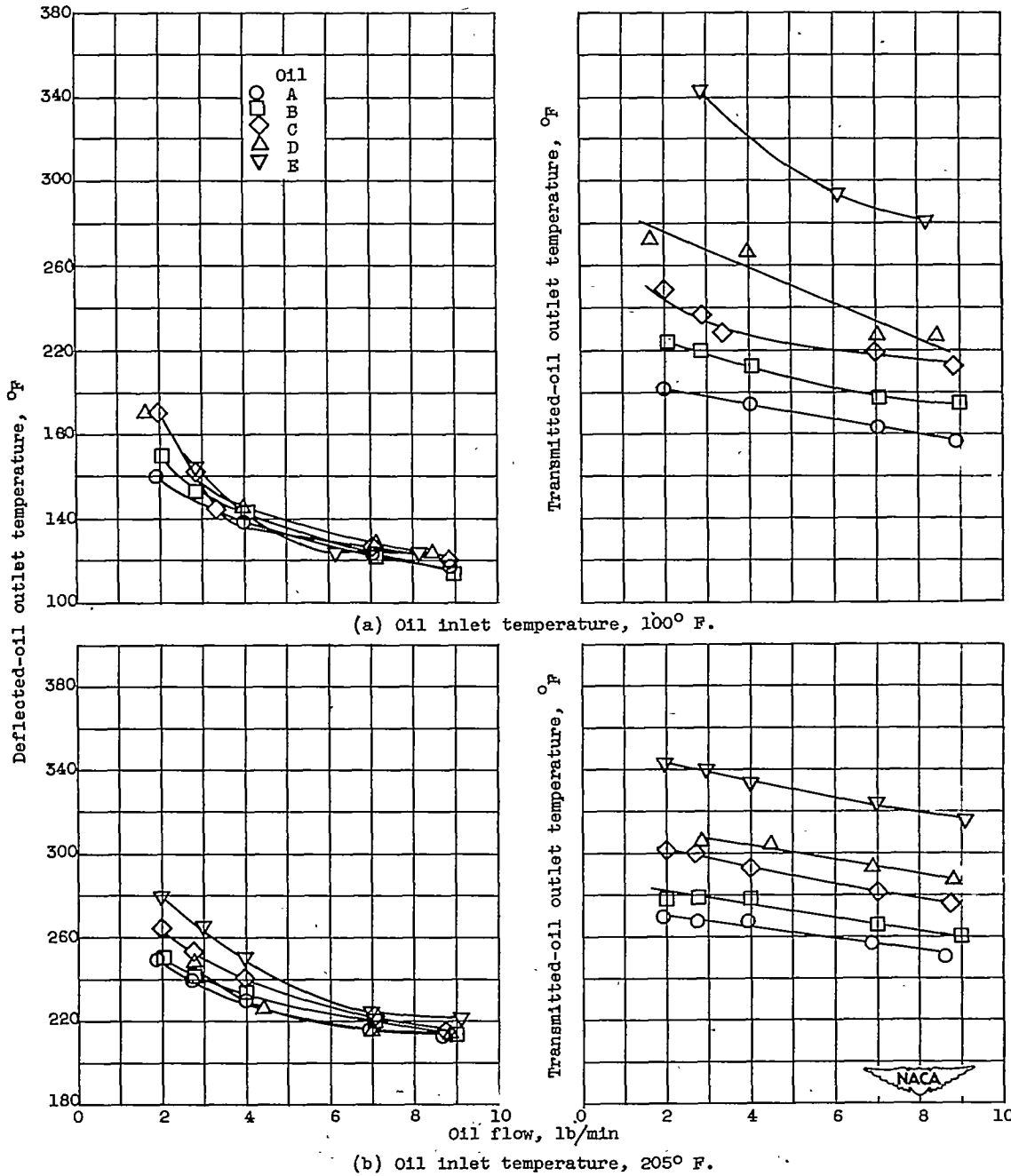

Figure 7. - Effect of oil flow on deflected- and transmitted-oil outlet temperatures. Load, 368 pounds; DN, 1.2×10^6 .

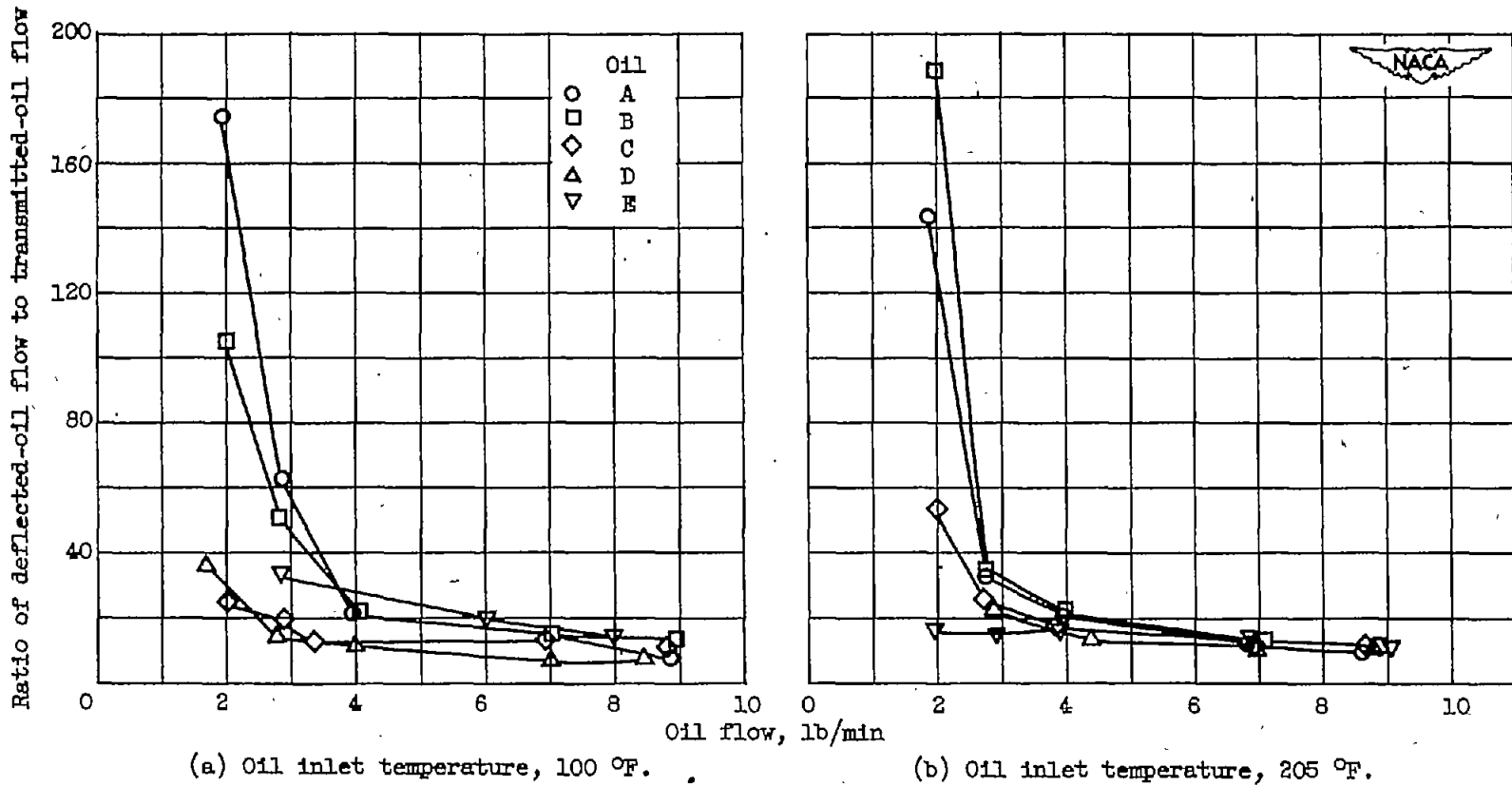

Figure 8. - Effect of oil flow on ratio of deflected- to transmitted-oil flow. Load, 368 pounds; DN, 1.2×10^6 ; oil-jet diameter, 0.050 inch.

2356

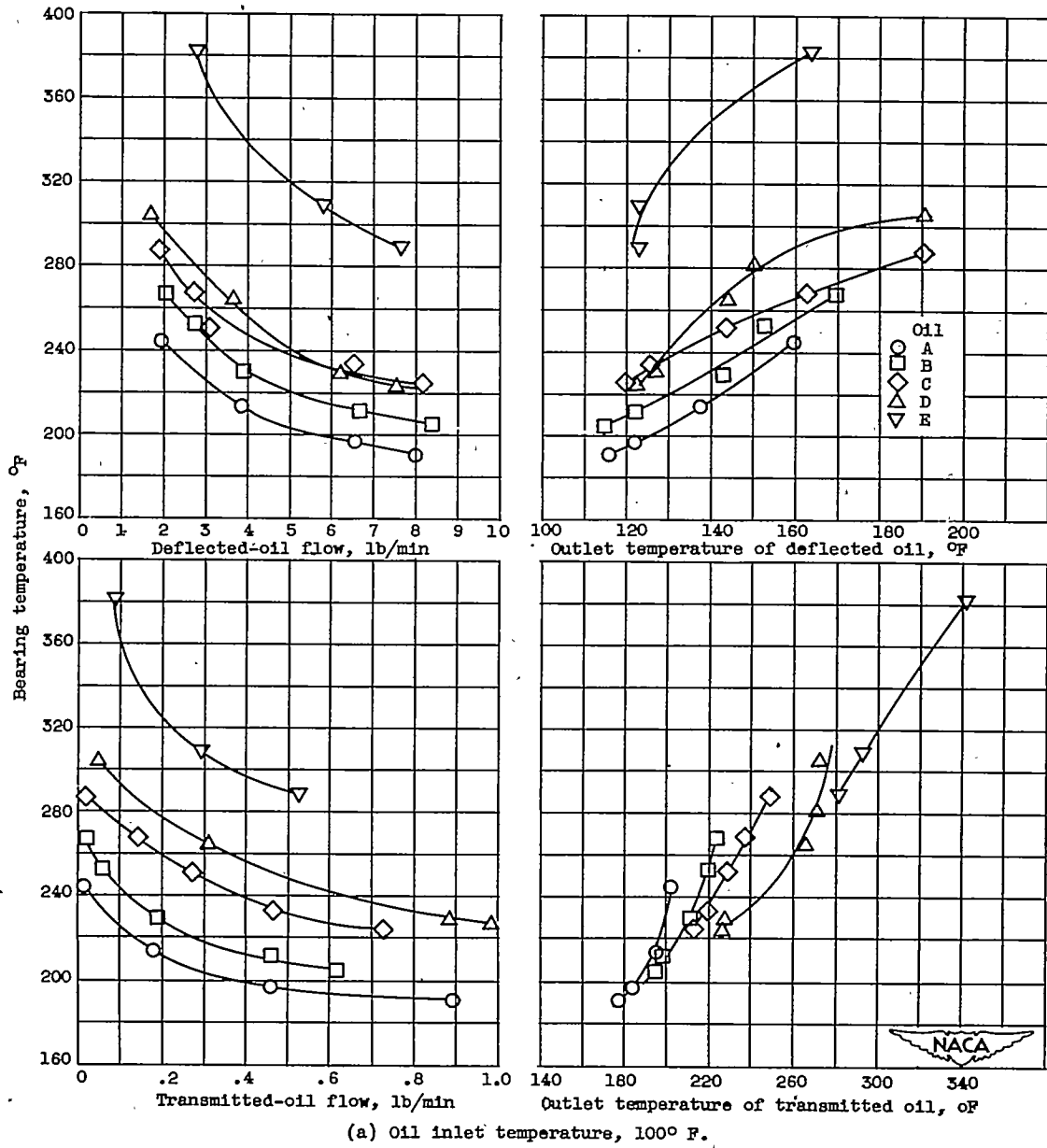

Figure 9. - Relation between deflected-oil flow, transmitted-oil flow, deflected- and transmitted-oil outlet temperature, and bearing outer-race-maximum temperature. Load, 368 pounds; DN, 1.2×10^6 .

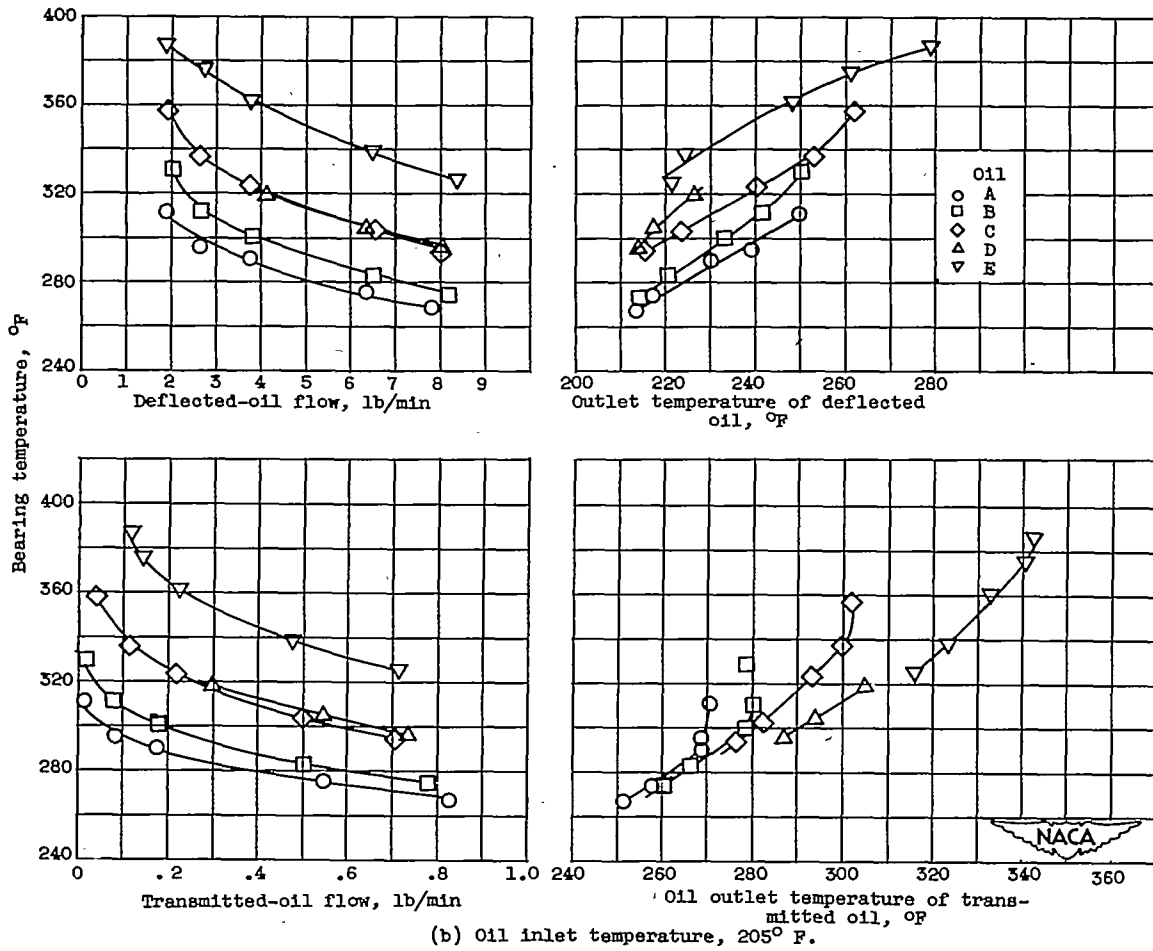
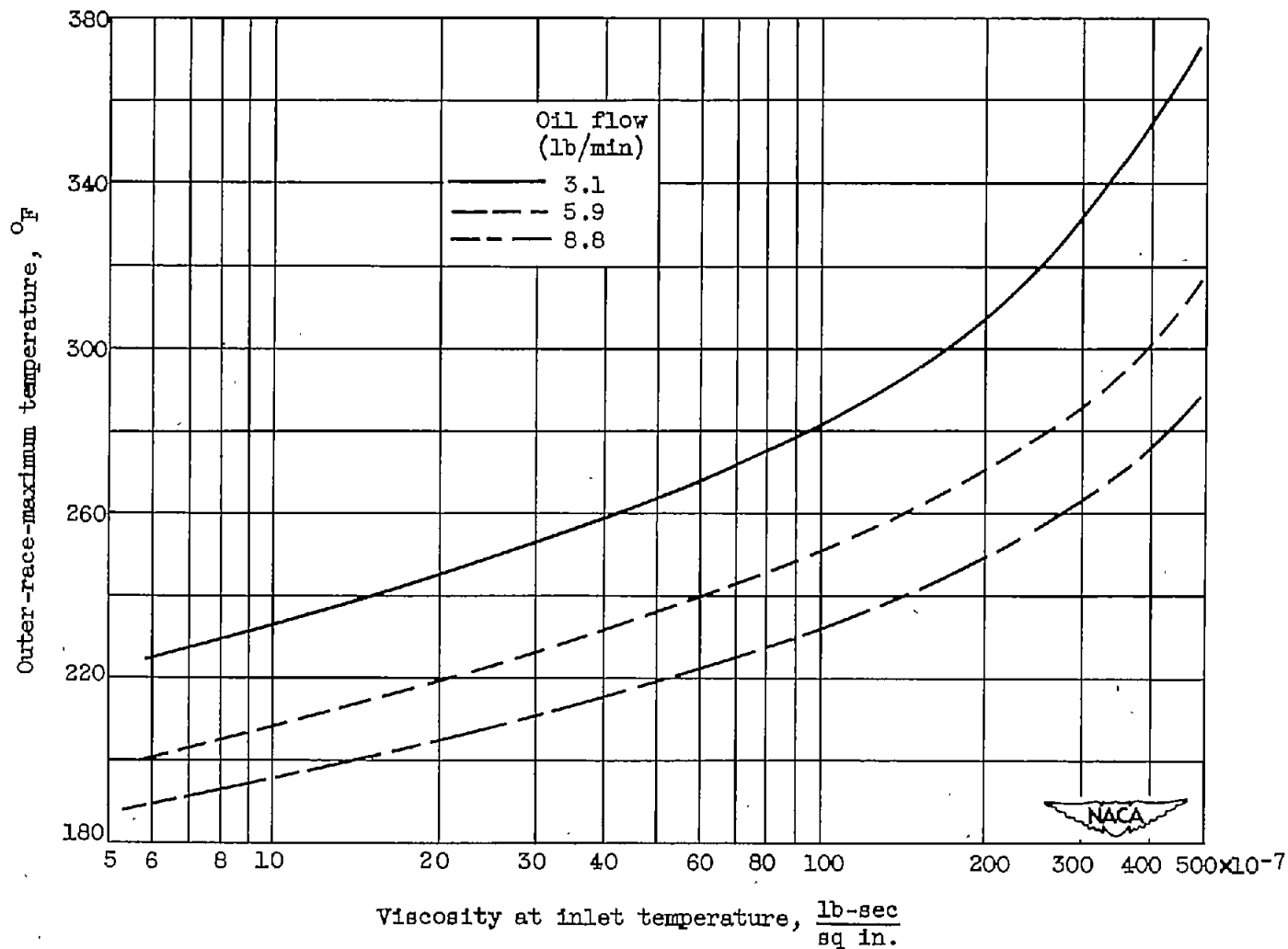

Figure 9. - Concluded. Relation between deflected-oil flow, transmitted-oil flow, deflected- and transmitted-oil outlet temperature, and bearing outer-race-maximum temperature. Load, 368 pounds; DN, 1.2×10^6 .

2356



(a) Oil inlet temperature, 100 °F.

Figure 10. - Effect of viscosity on outer-race-maximum temperature of bearing 18 (cross-plot of figs. 2 and 6(a)). Load, 368 pounds; DN, 1.2×10^6 .

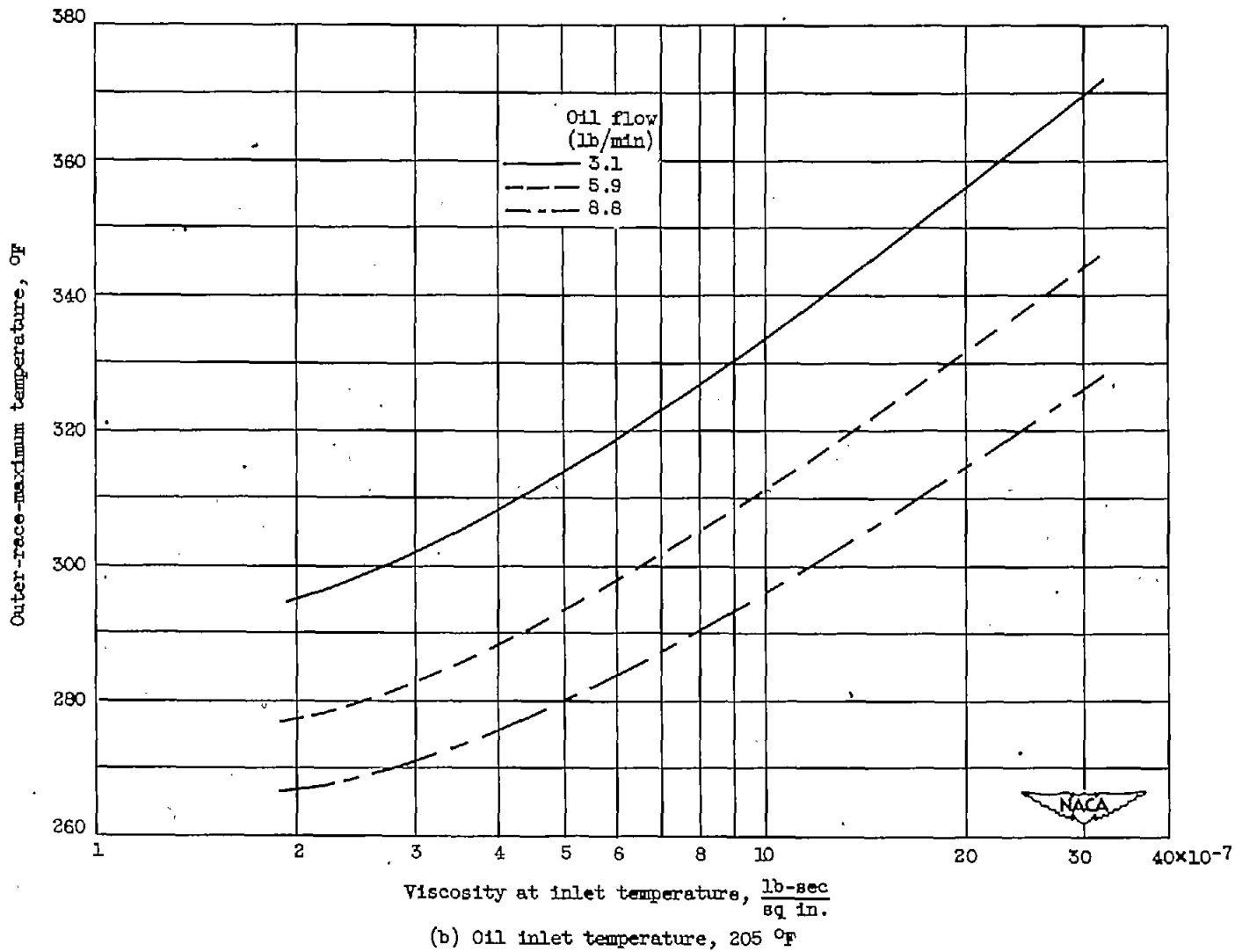

Figure 10. - Concluded. Effect of oil viscosity on outer-race-maximum temperature of bearing 18 (cross-plot of figs. 2 and 6(b)). Load, 368 pounds; $DM, 1.2 \times 10^6$.

2356

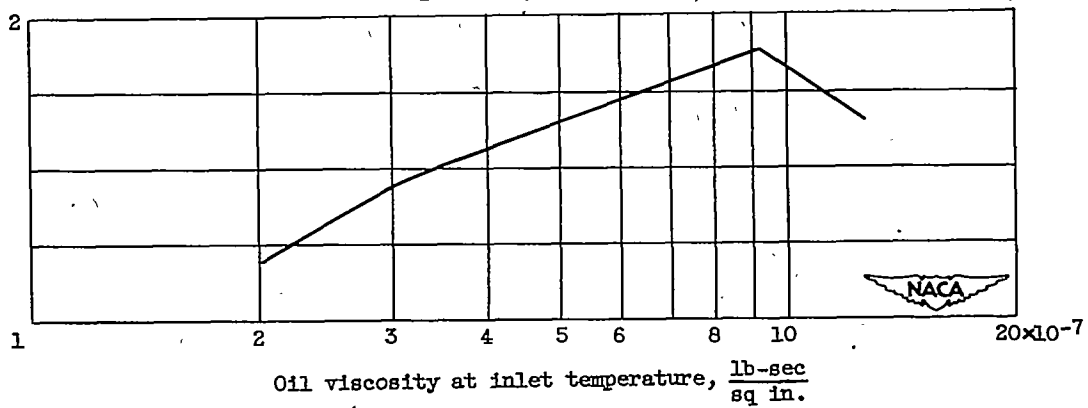
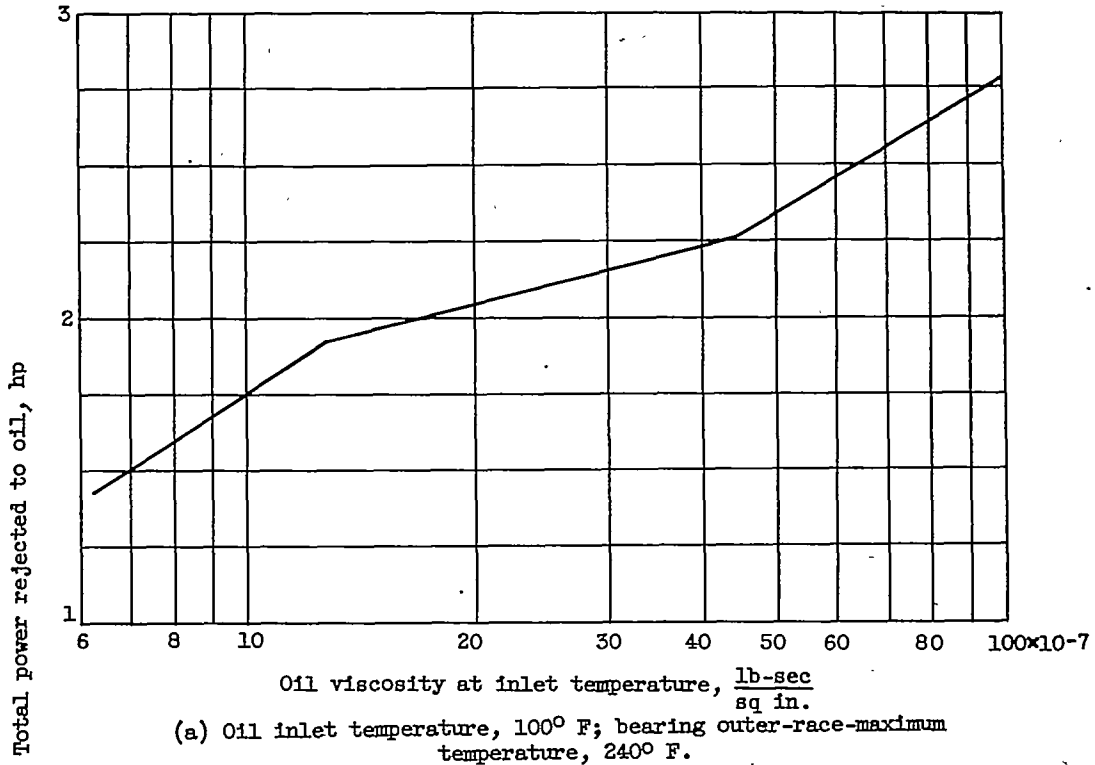
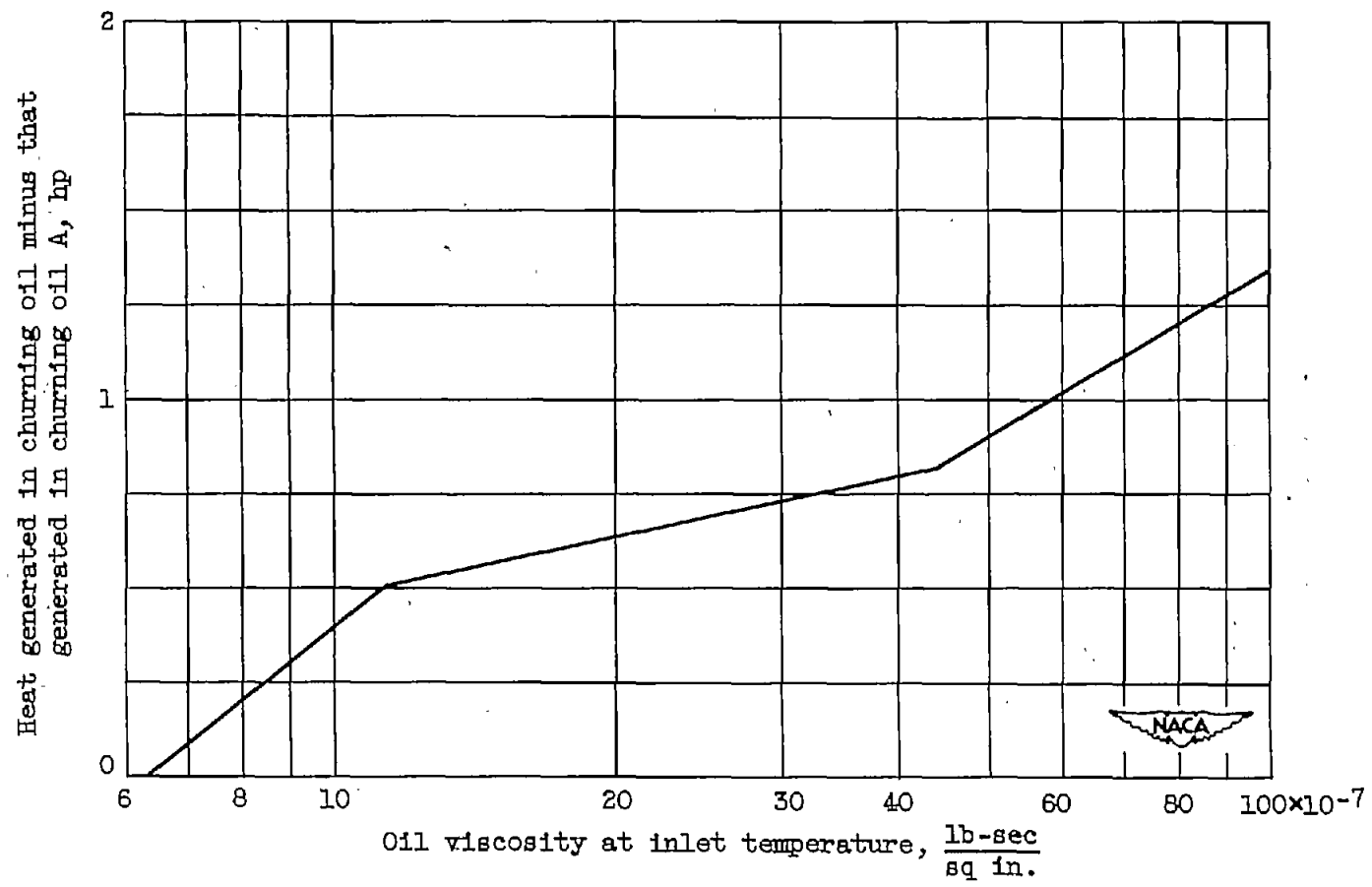
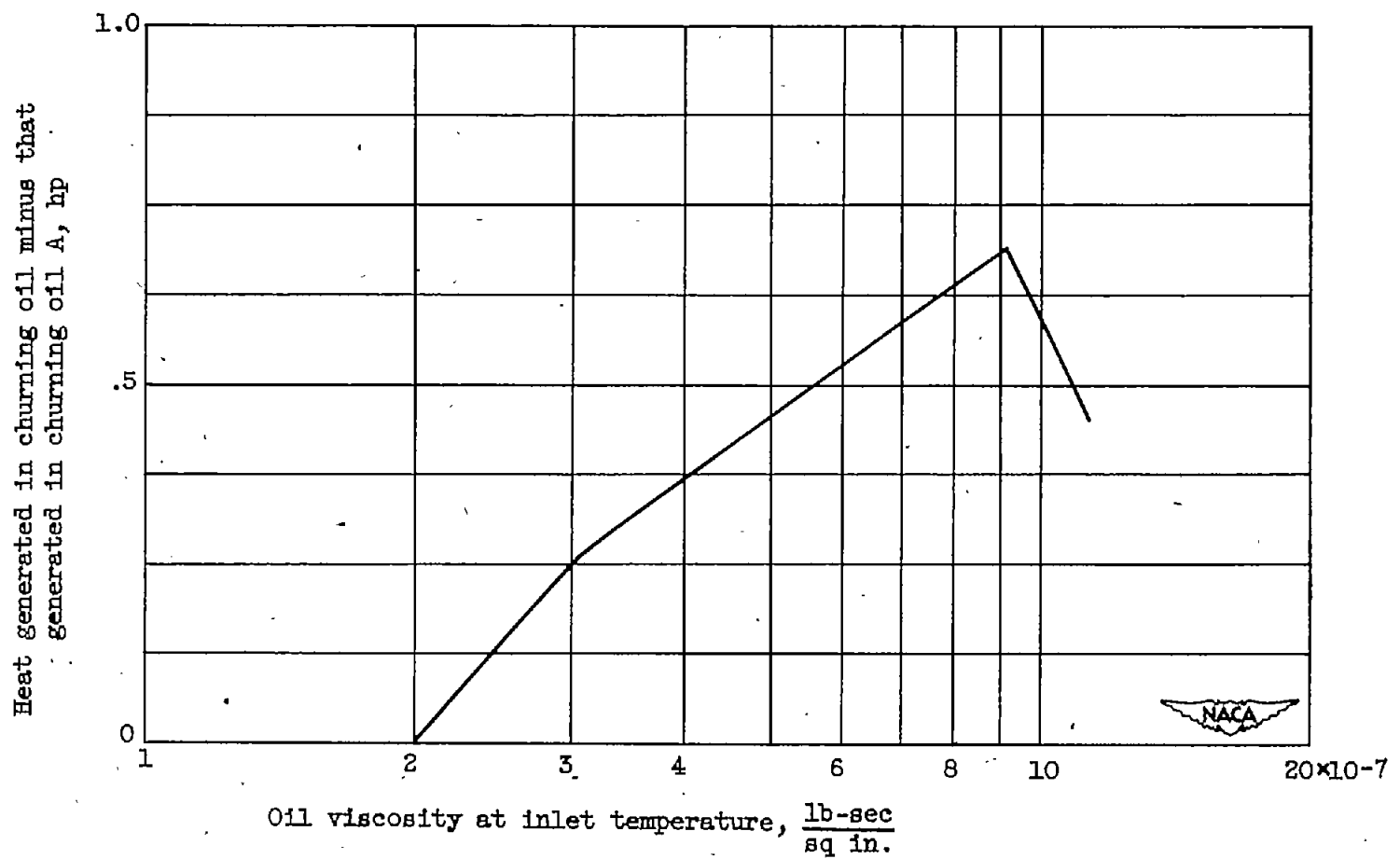

Figure 11. - Effect of oil viscosity on total power rejected to oil. Load, 368 pounds; DN, 1.2×10^6 .



(a) Oil inlet temperature, 100° F; bearing outer-race-maximum temperature, 240° F.

Figure 12. - Effect of viscosity on heat generated in churning oil. Load, 368 pounds; DN, 1.2×10^6 .



(b) Oil inlet temperature, 205° F; bearing outer-race-
maximum temperature, 300° F.

Figure 12. - Concluded. Effect of viscosity on heat generated in churning oil. Load, 368 pounds; DN, 1.2×10⁶.

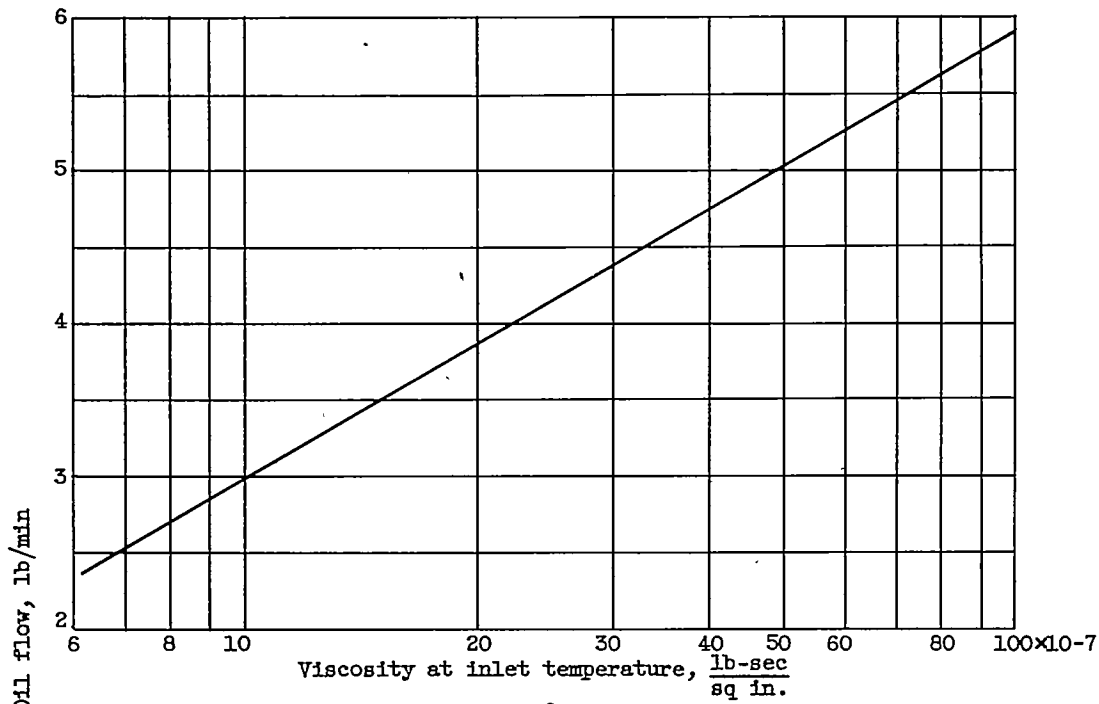

(a) Oil inlet temperature, 100° F; bearing outer-race-maximum temperature, 240° F.

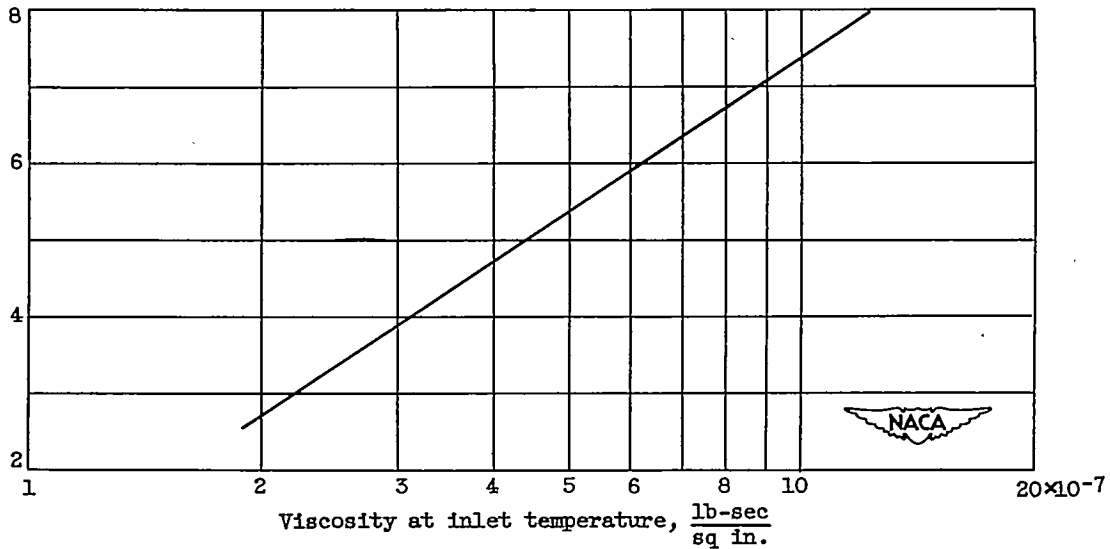

(b) Oil inlet temperature, 205° F; bearing outer-race-maximum temperature, 300° F.

Figure 13. - Effect of oil viscosity on oil flow required to maintain a constant bearing outer-race-maximum temperature. Load, 368 pounds; DN, 1.2x10⁶.

2356

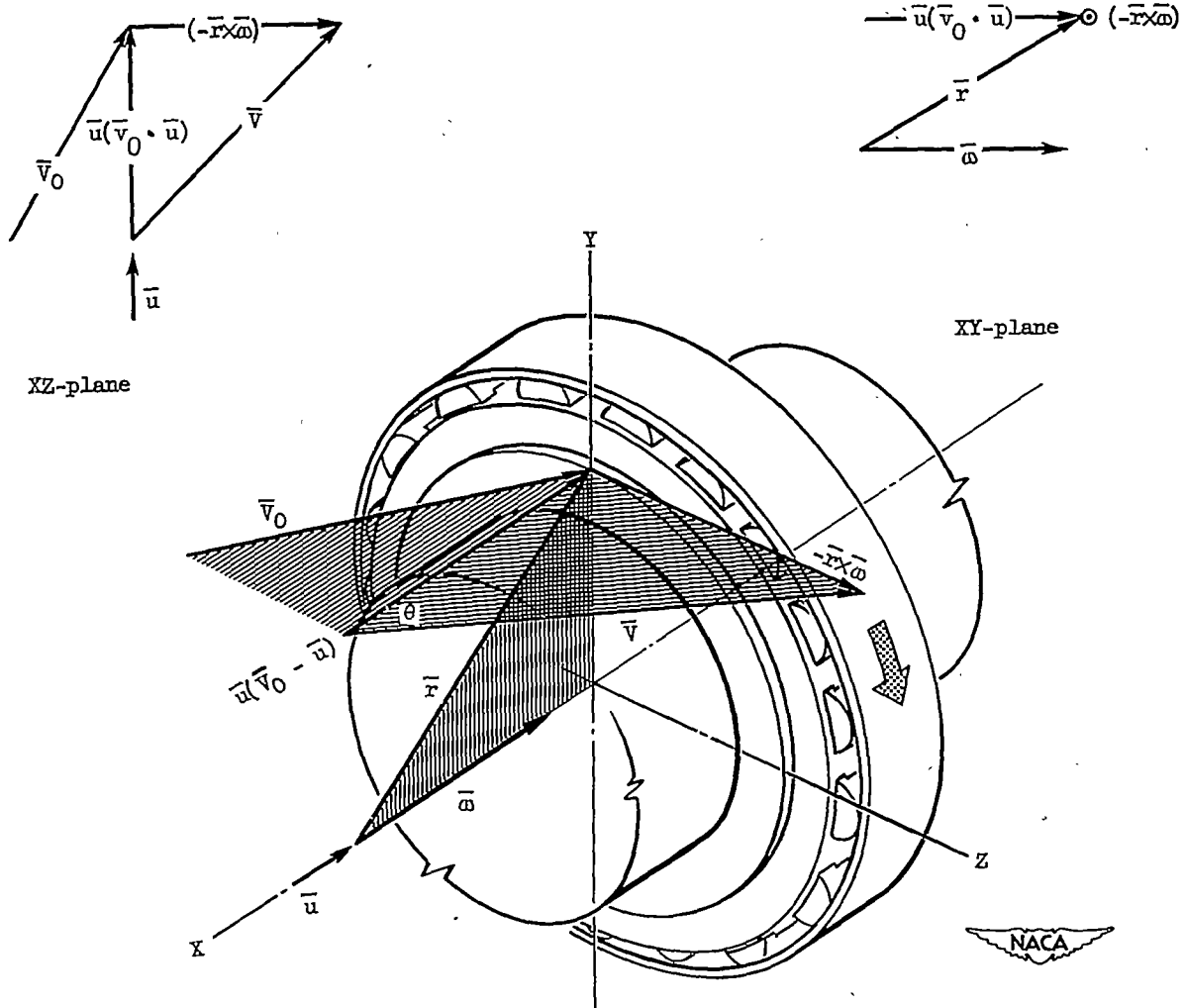

$$\frac{\text{Deflected-oil flow}}{\text{Transmitted-oil flow}} = \frac{1}{\cos \theta}$$

Figure 14. - Vector illustration of effect of oil-jet velocity vector \bar{V}_0 and bearing tangential-velocity vector $\bar{r} \times \bar{\omega}$ on ratio of deflected-oil flow to transmitted-oil flow.

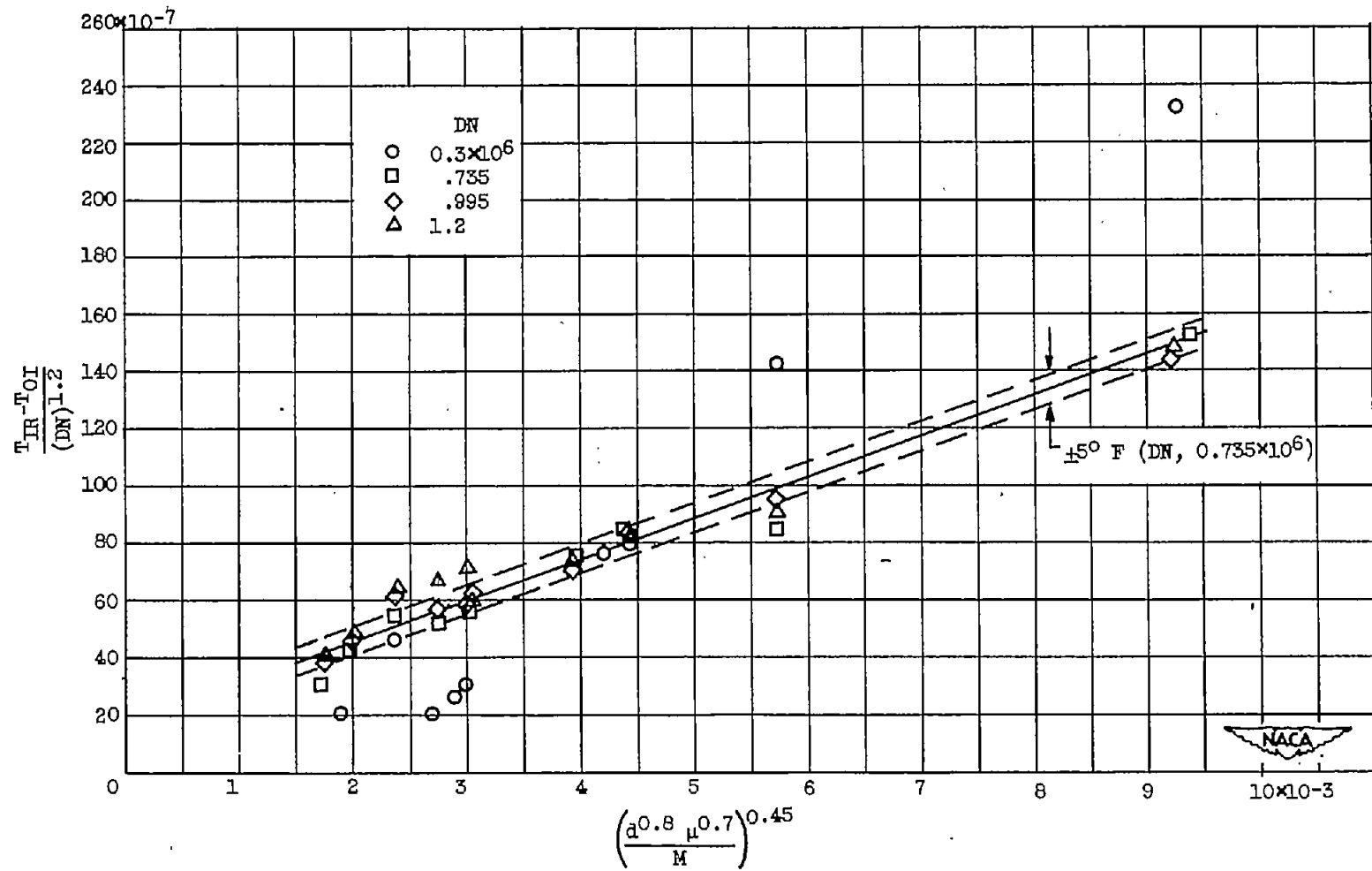

(a) DN as parameter

Figure 15. - Cooling-correlation curve for inner-race temperature of bearing 18. (Temperature T, °F; DN, bearing bore in mm times shaft speed in rpm; viscosity μ, lb-sec/sq in.; oil-jet diameter d, in.; oil flow M, lb/min.)

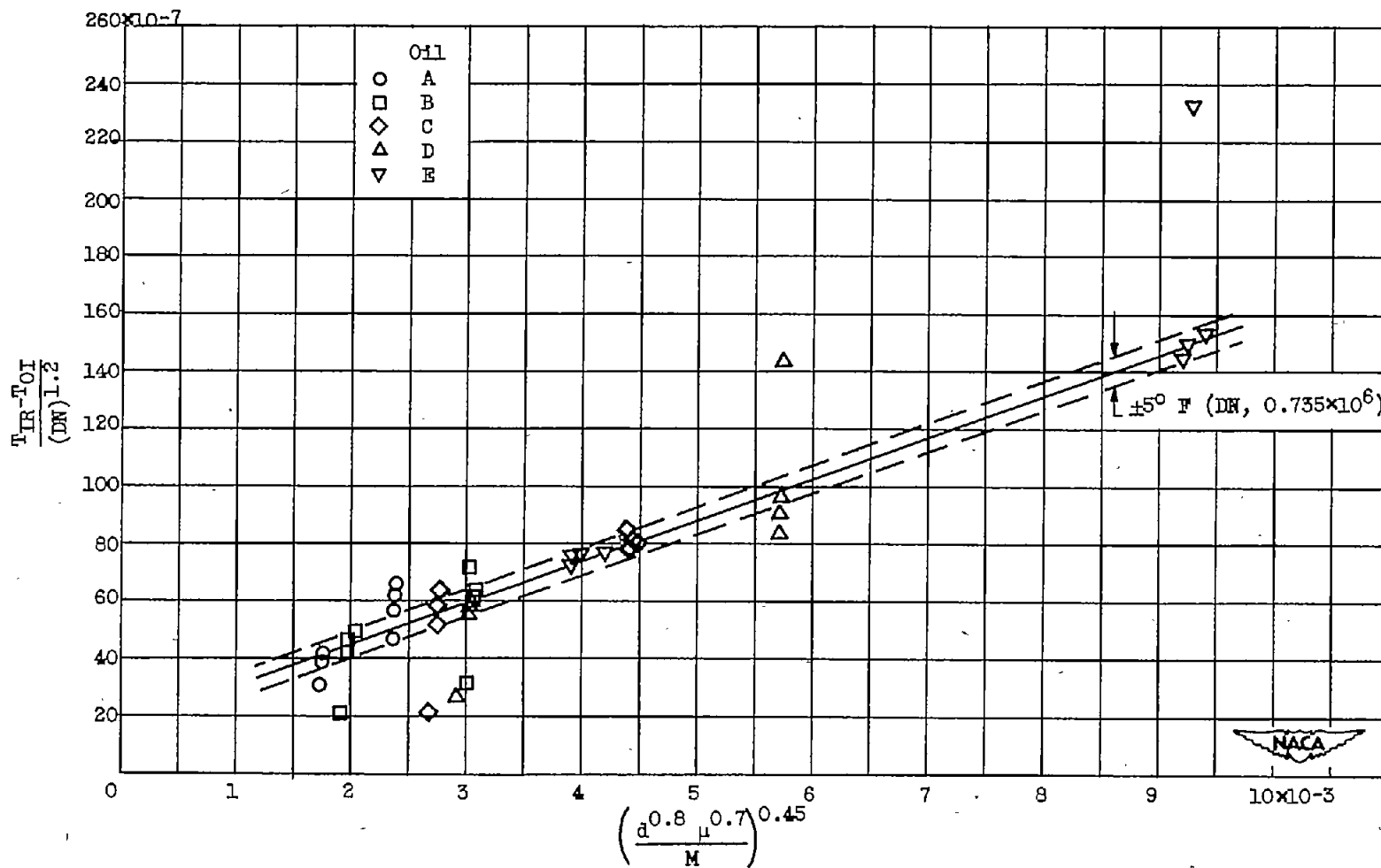

(b) Oil type as parameter.

Figure 15. - Concluded. Cooling-correlation curve for inner-race temperature of bearing 18. (Temperature T , $^\circ\text{F}$; DN , bearing bore in mm times shaft speed in rpm; viscosity μ , lb-sec/sq in.; oil-jet diameter d , in.; oil flow M , lb/min.)

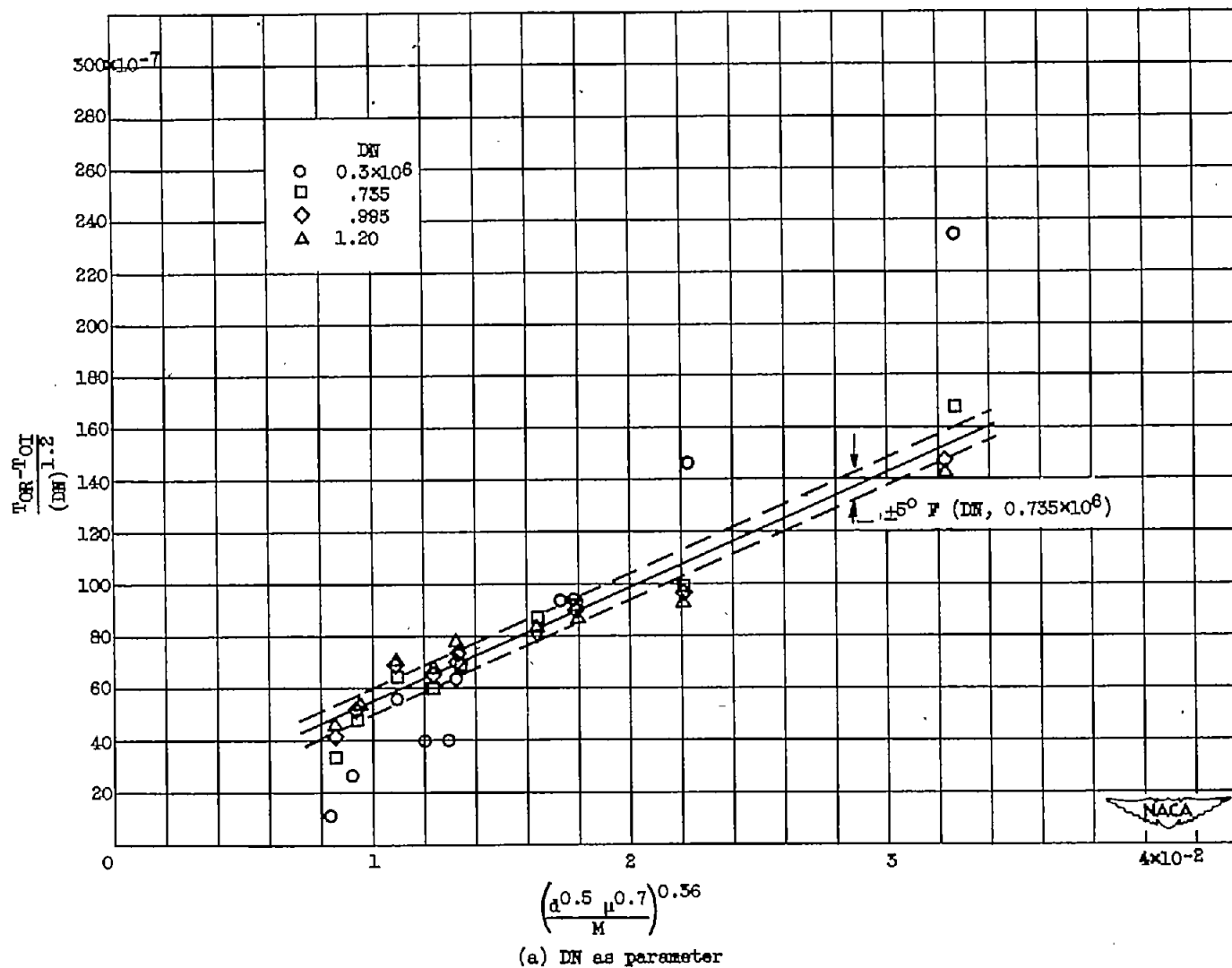
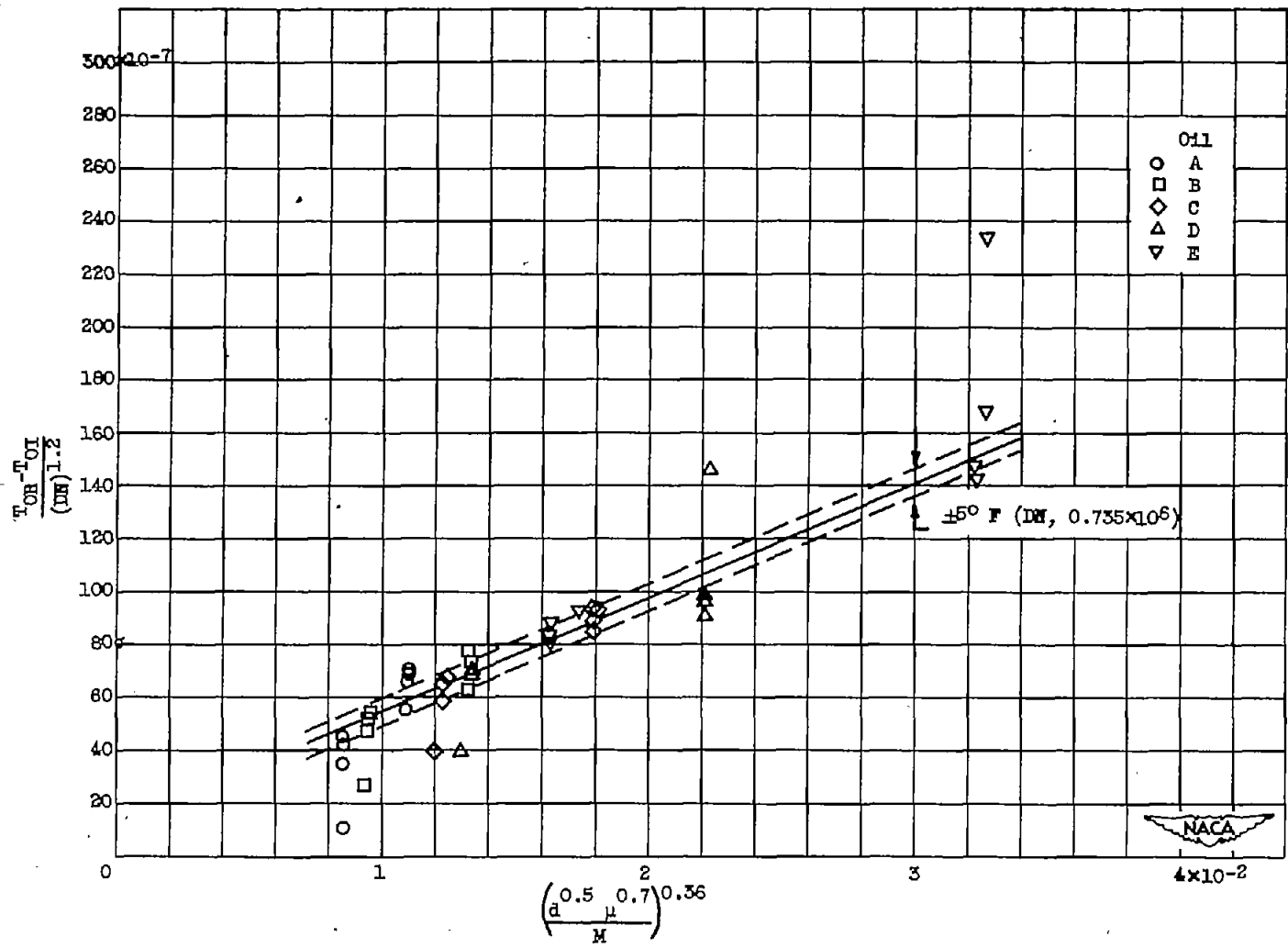

Figure 16. - Cooling-correlation curve for outer-race temperature of bearing 18. (Temperature T , °F; DN, bearing bore in mm times shaft speed in rpm; viscosity μ , lb-sec/sq in.; oil-jet diameter, in.; oil flow M , lb/min.)

NACA-Langley - 1-30-51 - 1000



(b) Oil type as parameter.

Figure 16. - Concluded. Cooling-correlation curve for outer-race temperature of bearing 18. (Temperature T , °F; DN , bearing bore in mm times shaft speed in rpm; viscosity μ , lb-sec/sq in.; oil-jet diameter d , in.; oil flow M , lb/min.)

NACA TN 2636