

NATIONAL ADVISORY COMMITTEE  
FOR AERONAUTICS

MAILED  
FEB 14 1928

THIS DOCUMENT PROVIDED BY THE ABBOTT AEROSPACE  
TECHNICAL LIBRARY FEB 16 1928  
ABBOTTAEROSPACE.COM

~~SECRET~~  
~~SECRET~~  
~~SECRET~~  
~~SECRET~~

TO: *Library, L.M.A.L.*

TECHNICAL NOTES

NATIONAL ADVISORY COMMITTEE FOR AERONAUTICS

---

No. 277

---

PRESSURE DISTRIBUTION ON WING RIBS OF THE VE-7  
AND TS AIRPLANES IN FLIGHT

PART II: PULL-UPS

By R. V. Rhode

**FILE COPY**

To be returned to  
the files of the Langley  
Memorial Aeronautical  
Laboratory

Washington  
January, 1928

NATIONAL ADVISORY COMMITTEE FOR AERONAUTICS.

TECHNICAL NOTE NO. 277.

PRESSURE DISTRIBUTION ON WING RIBS OF THE VE-7  
AND TS AIRPLANES IN FLIGHT.

PART II: PULL-UPS.

By R. V. Rhode.

Summary

This paper is the second of a series of notes, each of which presents the complete results of pressure distribution tests made at Langley Field by the National Advisory Committee for Aeronautics, on wing and tail ribs of the VE-7 and TS airplanes for a particular maneuver of flight. The results for pull-ups are presented in the form of curves which show the variation of pressure distribution, total loads, normal acceleration and center of pressure with respect to time.

Introduction

The data presented herein are the complete results of pressure distribution measurements made on wing and tail ribs of the VE-7 and TS airplanes in pull-ups. The results for the high speed pull-ups, in which the maximum loads were experienced, have already been given in Technical Report No. 257 (Reference 1), but because the purpose of that report primarily was to present the pressure distribution for the high and low angle of attack conditions with special attention paid to the maximum loads, only a

small part of the total data obtained was discussed. It is believed, however, that the pressure distribution for other maneuvers than those for which the maximum loads were experienced are of interest and value, and in order to present these results completely, this series of notes is being issued. The methods of testing, the apparatus, and a discussion of the accuracy of the results are given in Technical Report No. 257.

The locations of the points at which pressures were measured are shown in Figures 1 and 2. On the VE-7 airplane a rib in the upper wing only was investigated in addition to the tail rib. On the TS airplane, both upper and lower wing ribs were investigated, the two ribs chosen being in the same vertical plane. It should be pointed out here that too close an application of the results should be avoided since only a single rib in the span of each wing was investigated. The rib chosen in each case was located outside the slip stream and inside of the aileron to avoid disturbances as much as possible. The pressures on the wing ribs in the slip stream are probably of a greater magnitude than and a different distribution from those at the rib investigated, and those in the outer region of the wing, also, differ in magnitude and distribution because of the wing tip and aileron effects. Thus, the use of these results for estimating the loading over a complete airplane will give only approximate results.

## Results and Discussion

The results are presented in the form of curves of two kinds:

- (1) Those which show the instantaneous distribution of normal pressure along the chord at different stages of the maneuver, and
- (2) time-history curves, which show the variation with time of the values determined. Of this latter group, those curves showing variations of loads, moments, center of pressure, and normal force coefficient are derived by integration of the pressure curves. Normal acceleration, angle of attack, and air speed are obtained from direct measurements (Reference 1).

The values of angle of attack as measured in accelerated flight are not considered reliable, because of the probable interference effects upon the angle-of-attack head. The angle of attack as given in the time-history curves should therefore be considered as merely indicative rather than quantitative.

The results show that the air speed falls off only slightly up to the point of maximum load and that the wing loading, normal force coefficient, and normal acceleration reach their maximum values simultaneously. Maximum loads on the wing ribs occur from three-quarters of a second to one and one-quarter seconds after the pull-up is started, depending on the initial air speed. Maximum up-loads occur on the tail ribs about a quarter of a second later than the maximum wing-rib loads, but these are preceded by maximum down-loads which occur about a quarter of a second after the start of the maneuver. The sequence of events is thus:

(1) Maximum down-load on tail; (2) maximum up-load on wings; and (3) maximum up-load on tail. As a rule, in these tests down-loadings on the elevator were more intense than down-loadings on the stabilizer, although local pressures near the leading edge of the stabilizer were usually greater than local pressures on the elevator. The elevator never experiences an up-load, and up-loads on the stabilizer are never great.

On the TS airplane, where both upper and lower wing ribs were investigated, the lower wing loading was in all cases less than the upper wing loading.

The rather excessive forward travel of the center of pressure is deserving of special mention. On the R.A.F. 15 airfoil of the VE-7 airplane, the maximum forward position of the C.P. is found in a pull-up at 82 M.P.H. to be 21 per cent of the chord length from the leading edge. Monoplane wind tunnel tests give a maximum forward position of 28 per cent, which makes a difference of 7 per cent. Part of this difference can readily be accounted for by the effect of the biplane arrangement (Reference 2). In the level flight runs, for instance, a consistent difference between flight and monoplane wind tunnel results was found, but the discrepancy was entirely explained on the basis of biplane effect. Here, however, in accelerated flight, the center of pressure moves still farther forward, a phenomenon which has not as yet been satisfactorily explained. It is thought to be due in some way to the changing air flow about a rotating

airfoil. The question is worthy of further investigation because an error of 4 per cent in the location of the center of pressure means a considerable error in the design load factor of the wing truss.

### Conclusions

In general, it is concluded from these results that in pull-ups:

1. Maximum loads on upper and lower wing ribs occur simultaneously, but the upper wing load is always greater than the lower wing load.

2. The horizontal tail surfaces experience a considerable down-load which occurs previous to the maximum wing load.

3. The elevator never experiences an up-load, and the up-loading on the stabilizer is never great.

4. The intensity of the down-loading on the elevator is greater than on the stabilizer, but local pressures on the stabilizer are greater than those on the elevator.

5. The center of pressure on the upper wing of a biplane moves abnormally far forward by an amount which cannot be pre-estimated by existing wind tunnel data.

Langley Field, Va.,

November 14, 1927.

References and Bibliography

- Ref. 1. Crowley, Jr., J. W. : Pressure Distribution Over a Wing and Tail Rib of a VE-7 and of a TS Airplane in Flight. N.A.C.A. Technical Report No. 257. (1927)
- Ref. 2. Munk, Max M. : The Air Forces on a Systematic Series of Biplane and Triplane Cellule Models. N.A.C.A. Technical Report No. 256. (1927)
- Rhode, R. V. : Pressure Distribution on Wing Ribs of the VE-7 and TS Airplanes in Flight. Part I: Level Flight. N.A.C.A. Technical Note No. 267. (1927)

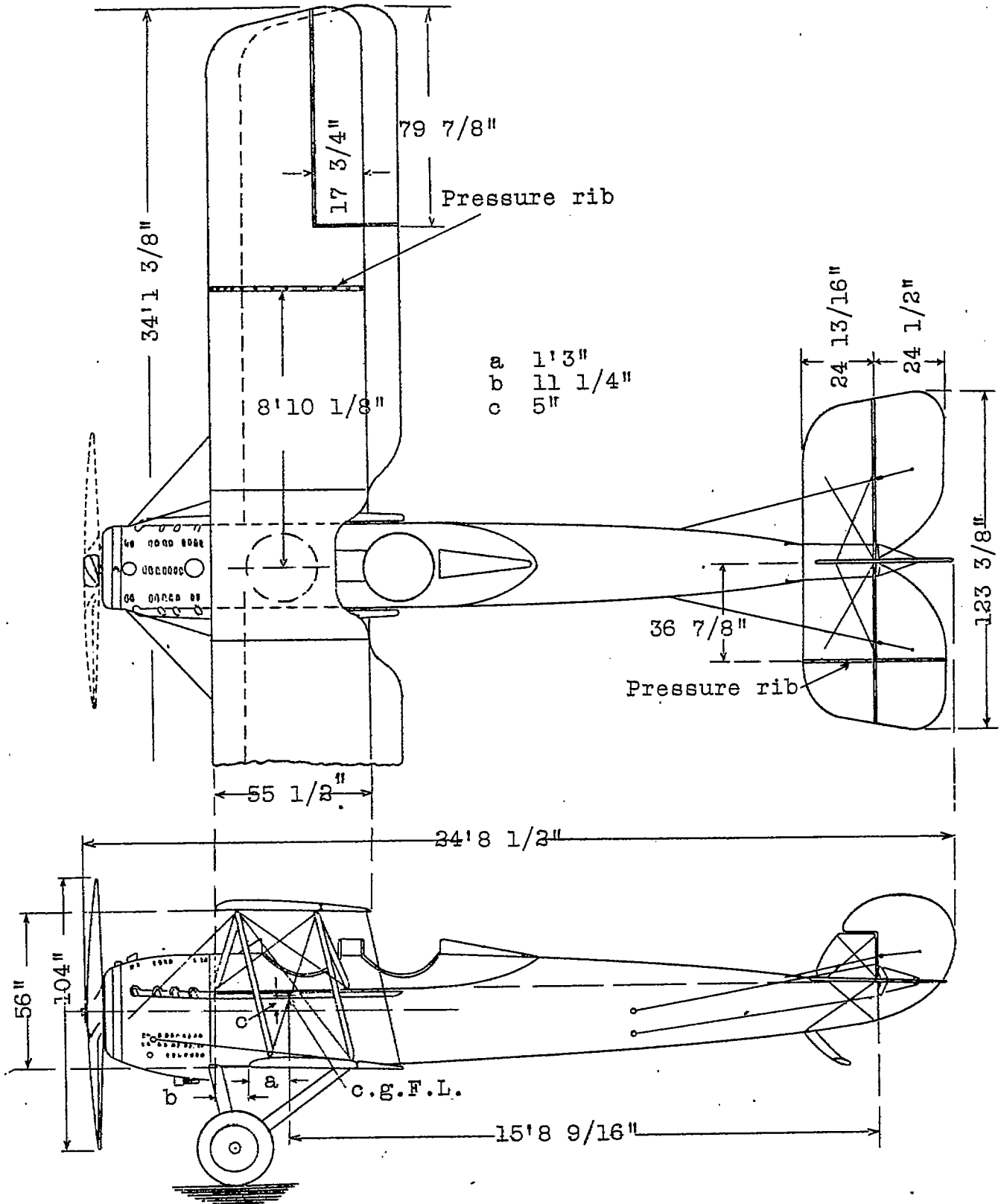

Fig.1 VE-7 airplane, showing location of false ribs.



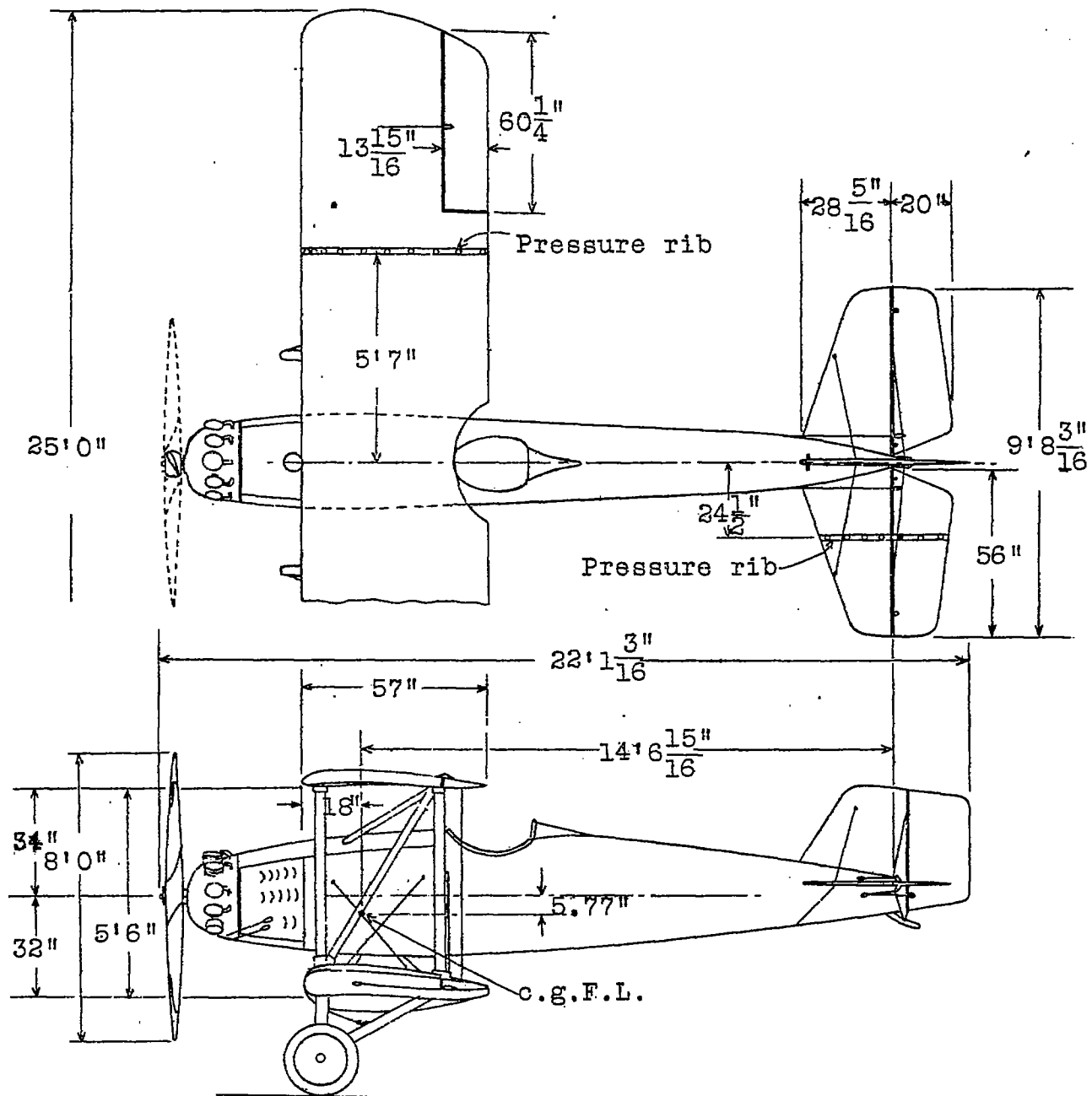

Fig. 2 T.S. airplane, showing location of false ribs.

N.A.C.A. Technical Note No.277

Fig.3

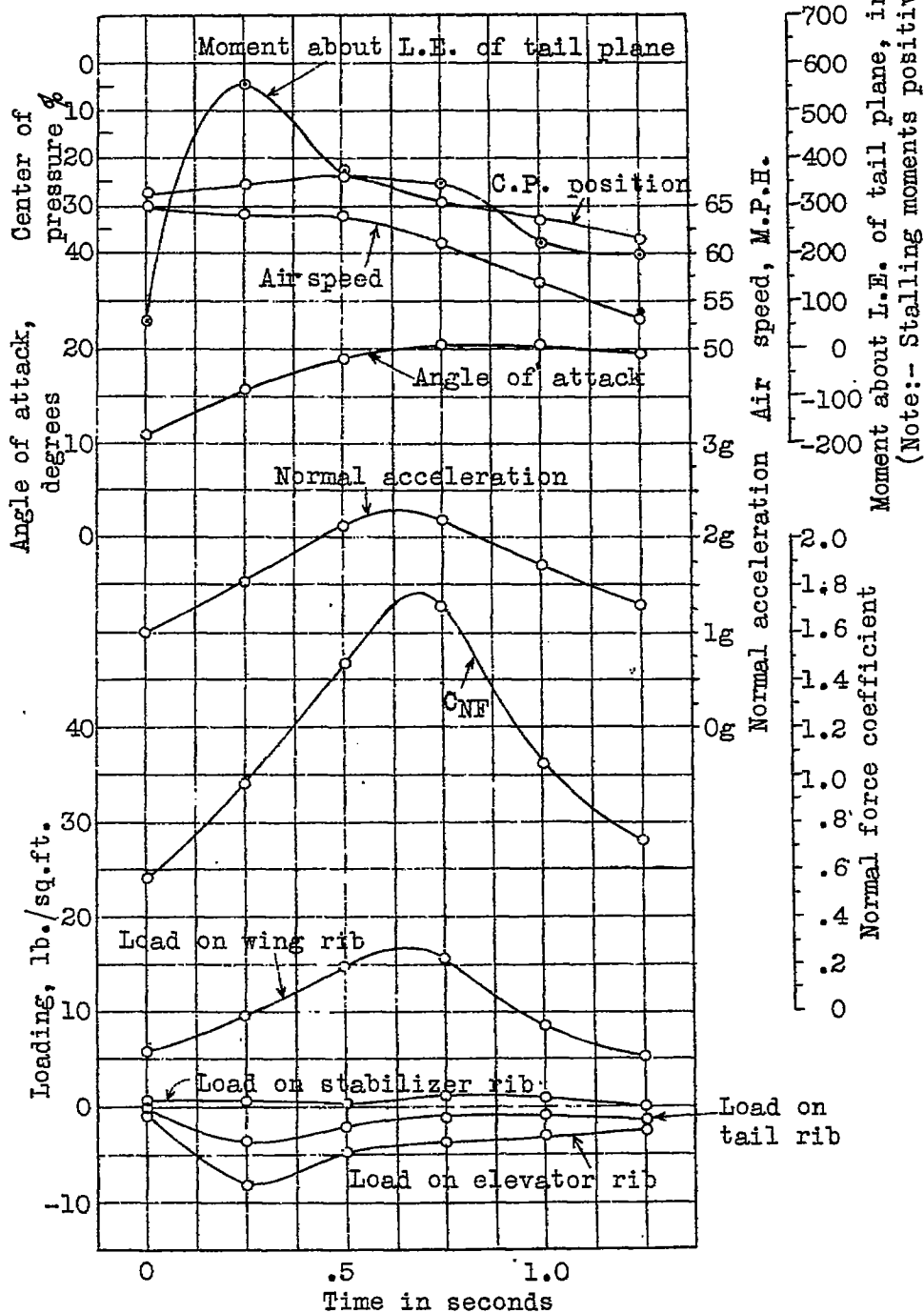
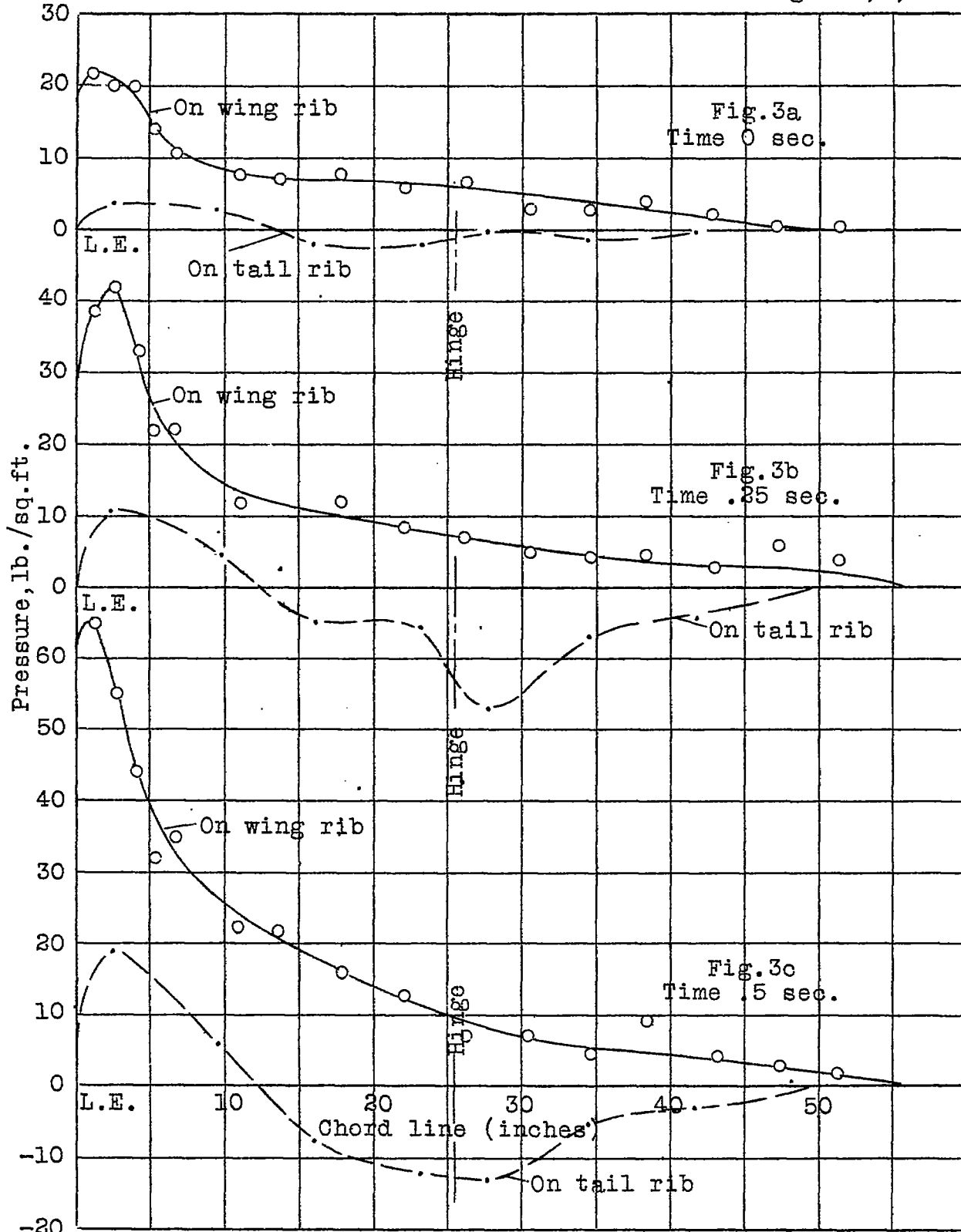
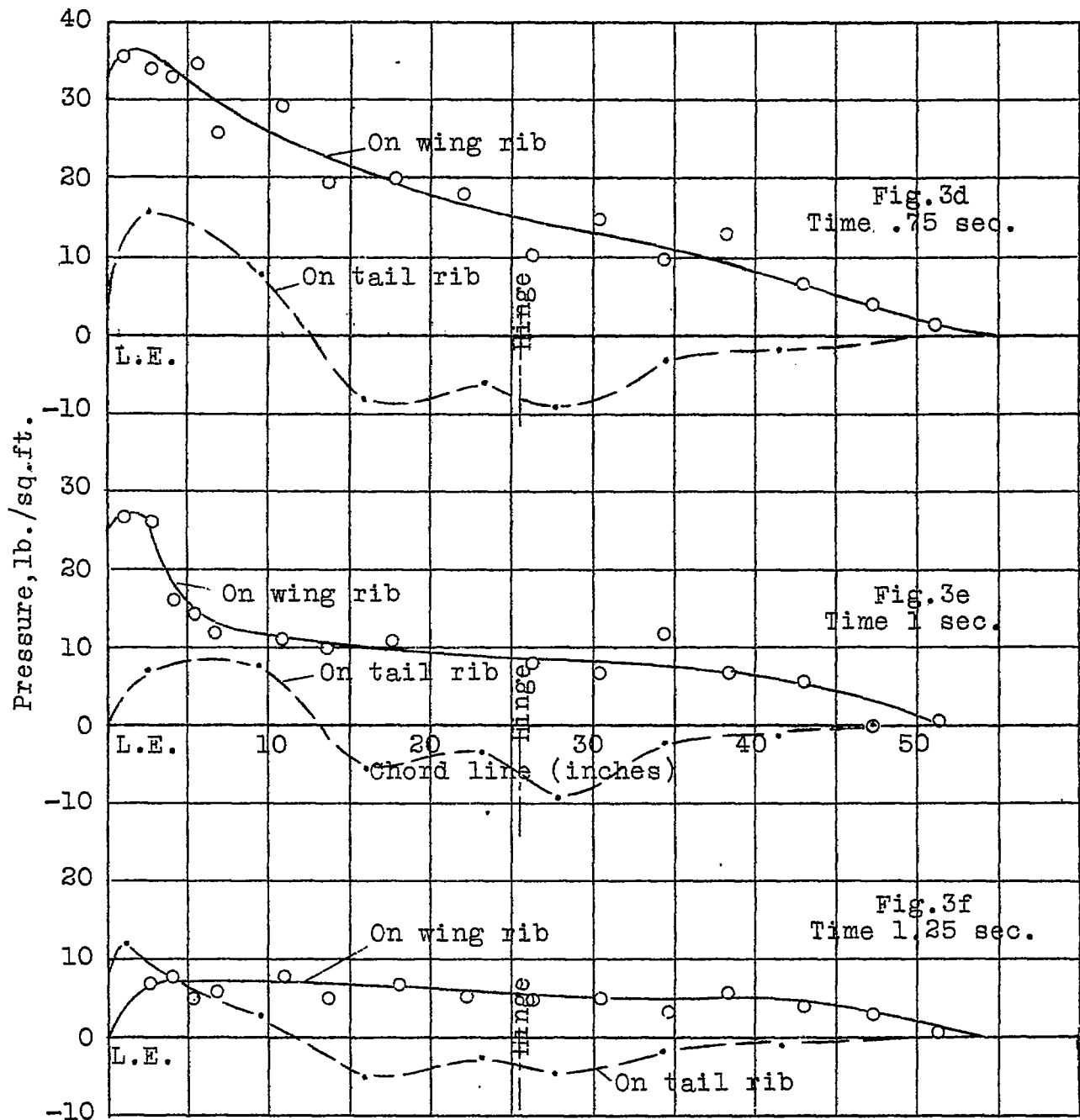

Fig.3 Pressure distribution on a VE-7 airplane in a pull up at 65 M.P.H.



Figs.3a,b,c Pressure distribution on VE-7 airplane in a pull-up at 65 M.P.H.



Figs.3d,e,f Pressure distribution on VE-7 airplane in a pull-up at 65 M.P.H.

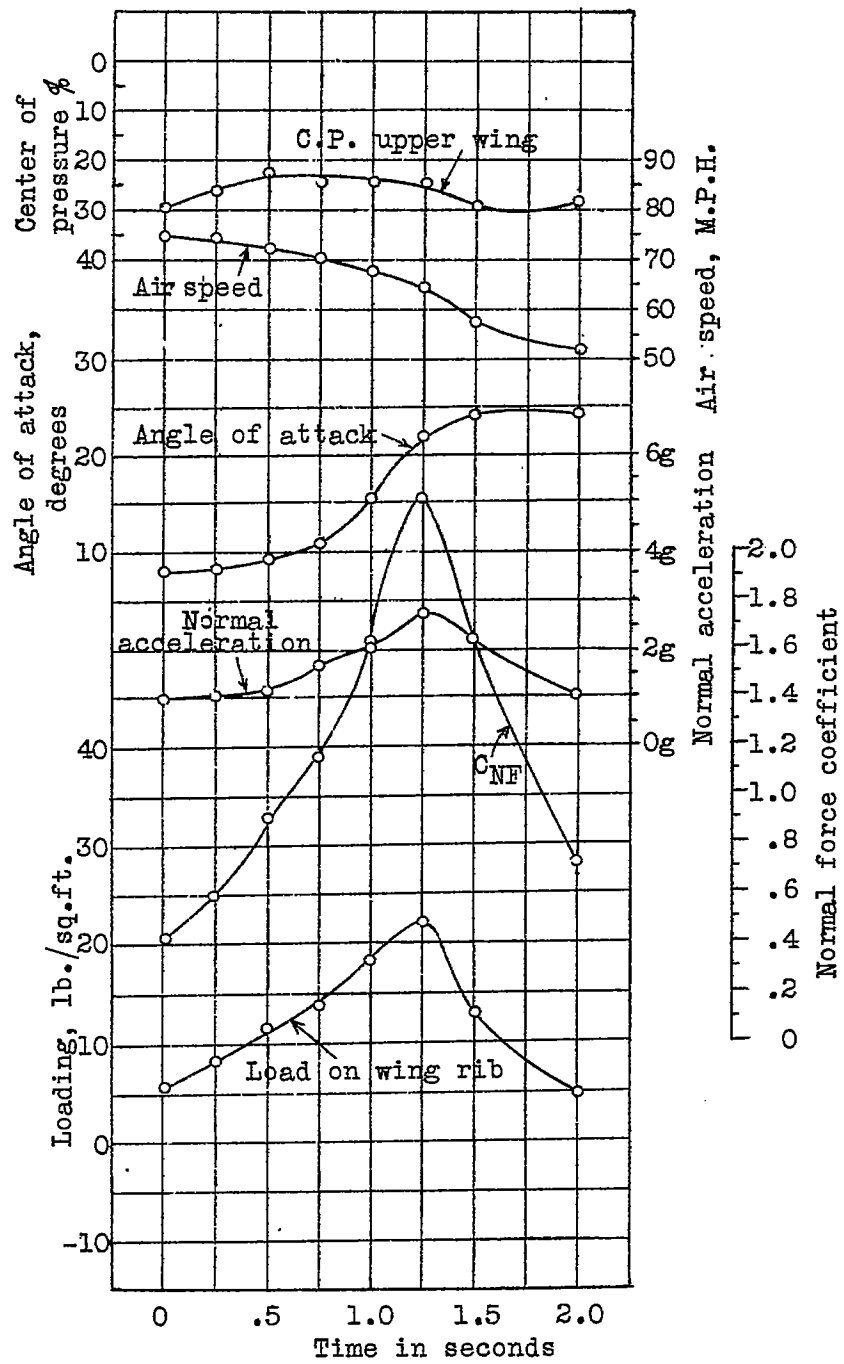
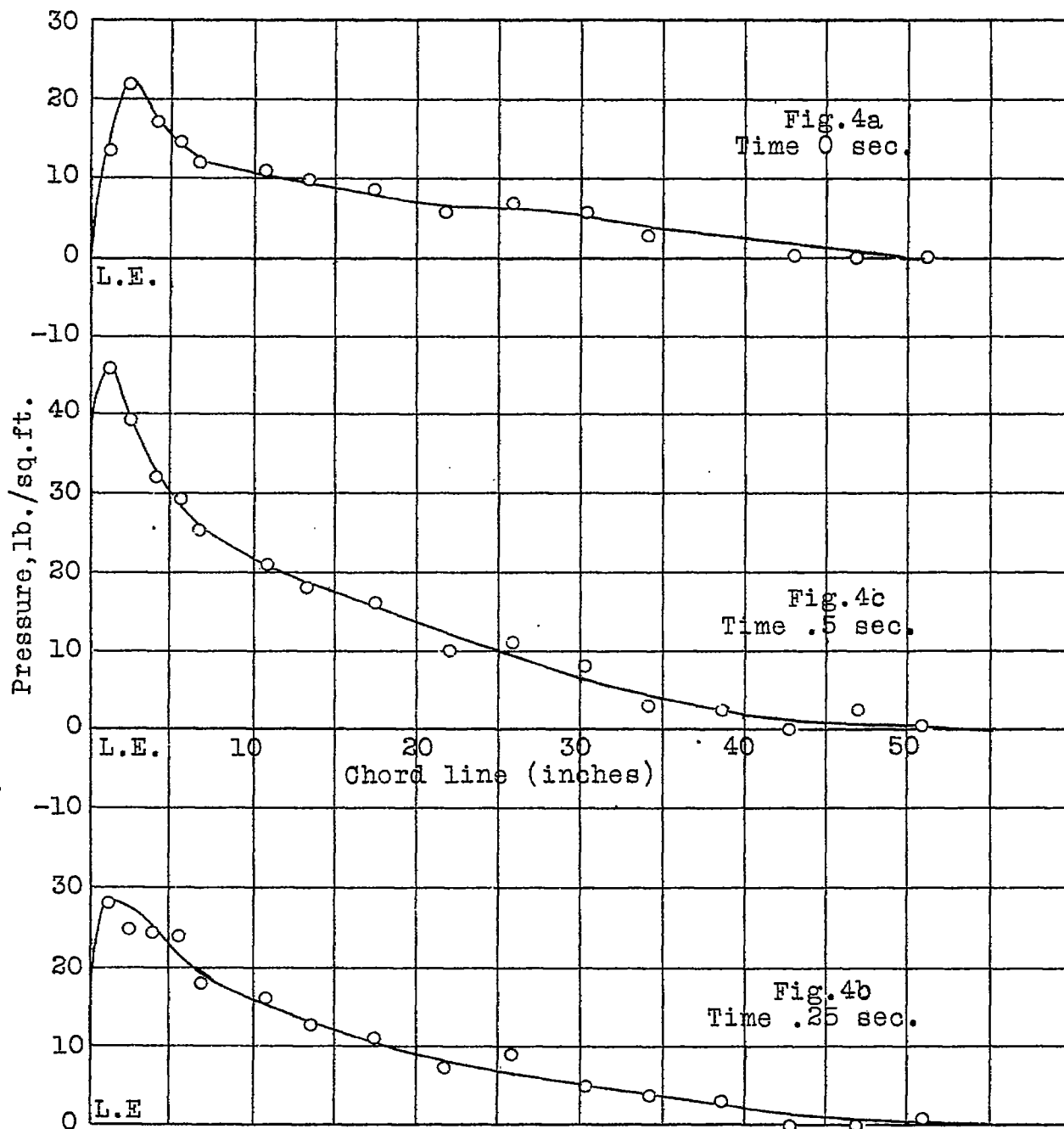

Fig.4: Pressure distribution on a VE-7 airplane in a pull up at 75 M.P.H.



Figs.4a,b,c Pressure distribution on VE-7 airplane in a pull-up at 75 M.P.H.

N.A.C.A. Technical Note No.277

Figs.4d,e

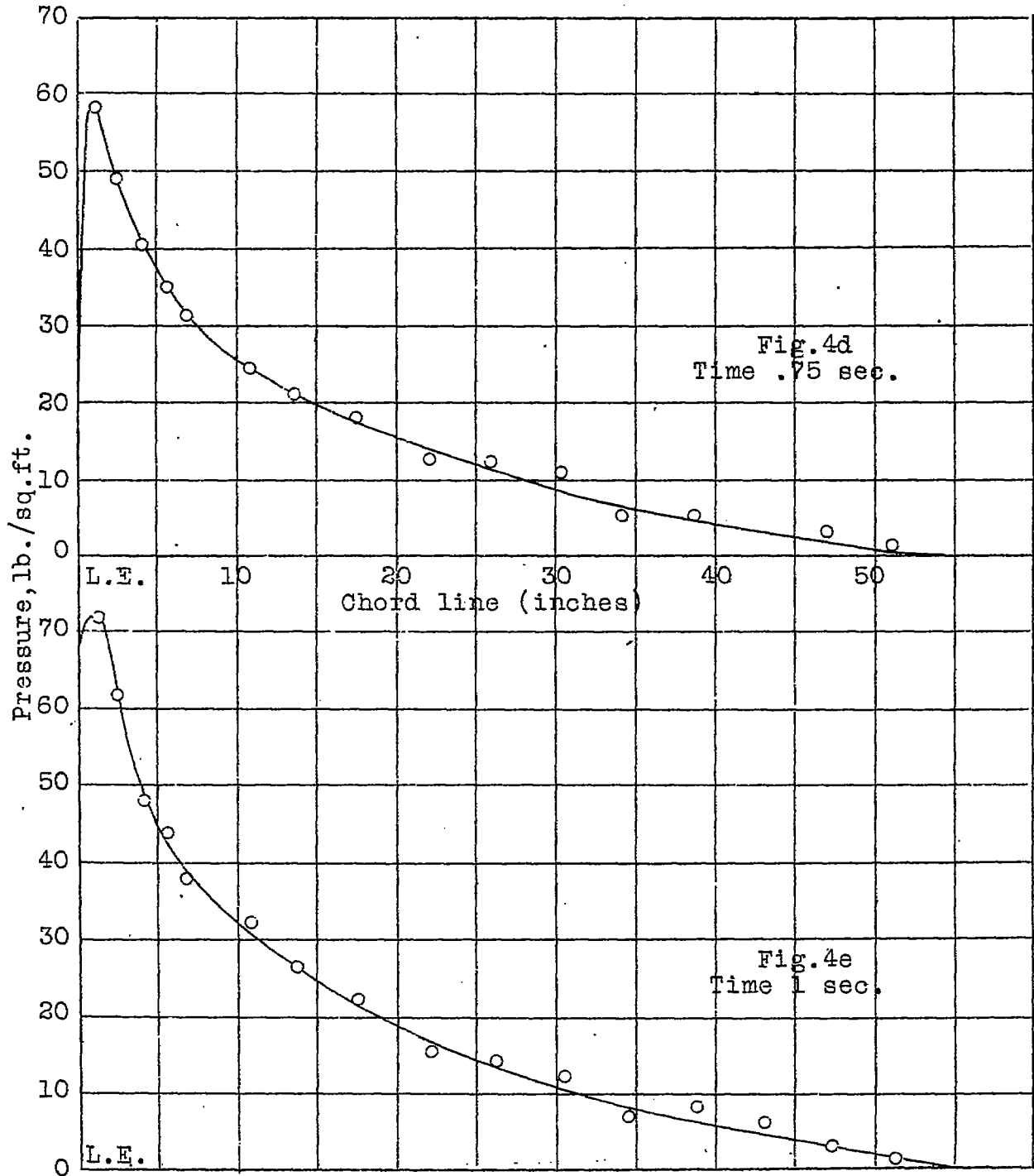

Figs.4d,e Pressure distribution on VE-7 airplane in a pull-up at 75 M.P.H.

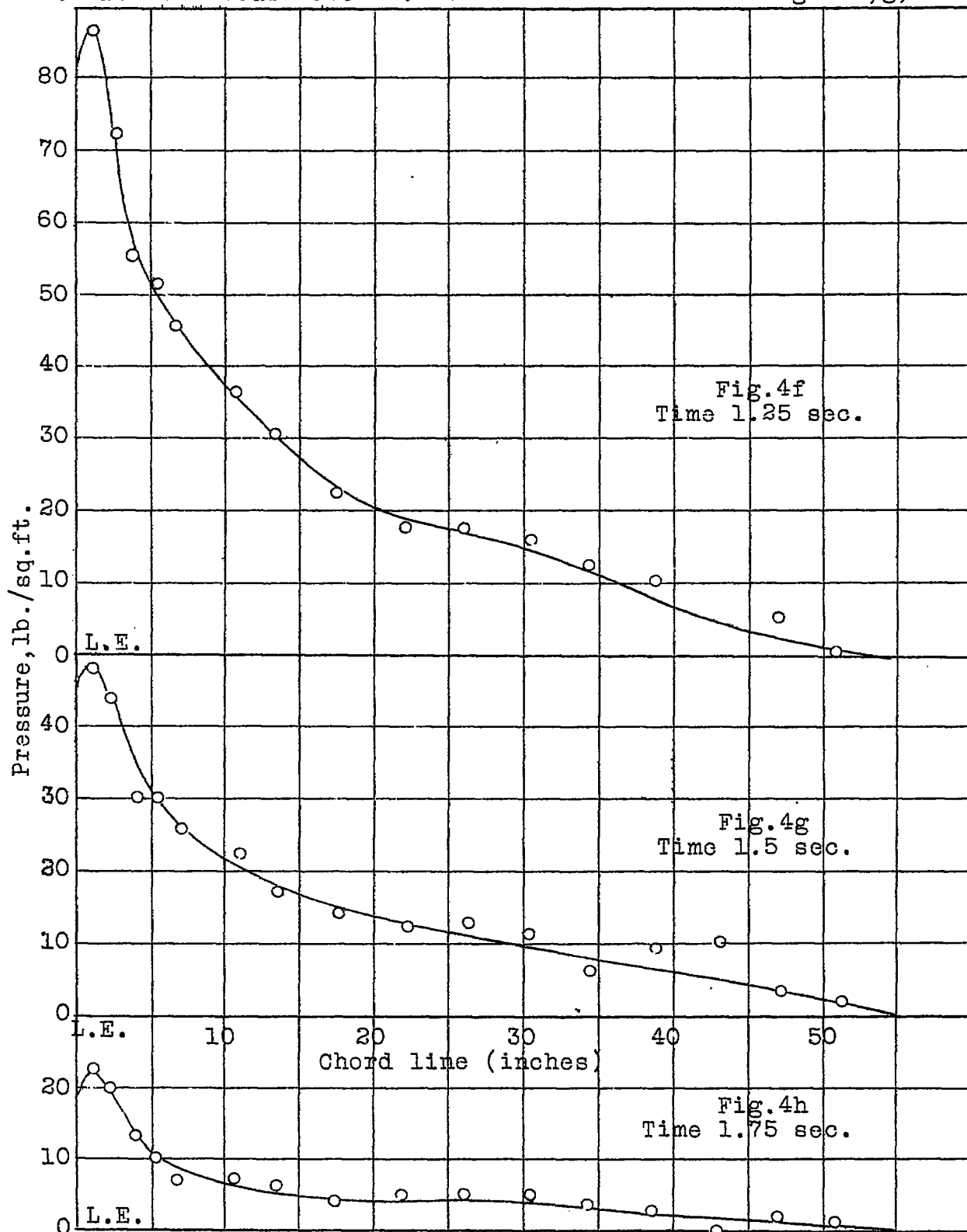

Figs.4f,g,h Pressure distribution on VE-7 airplane in a pull-up at 75 M.P.H.



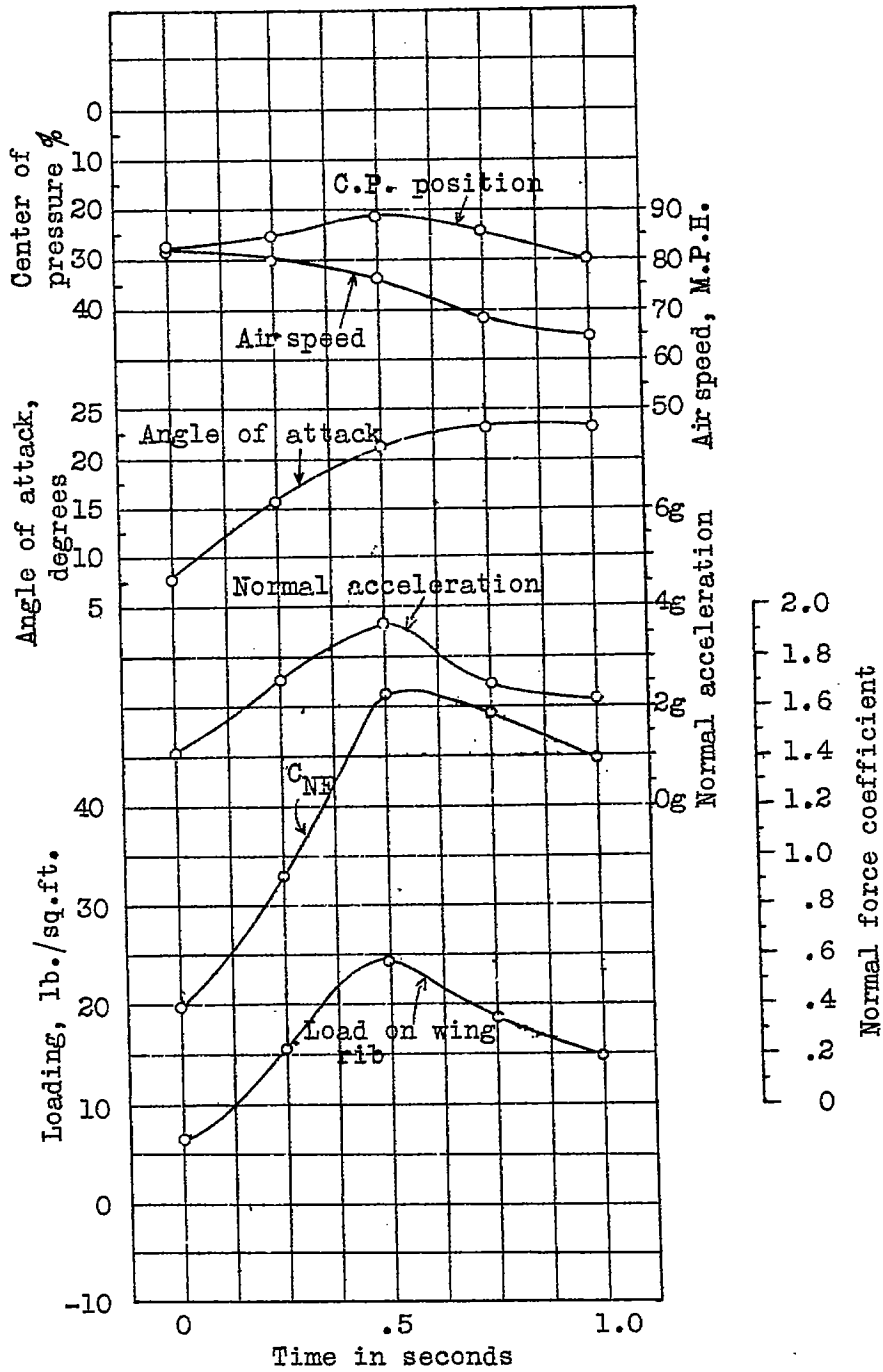
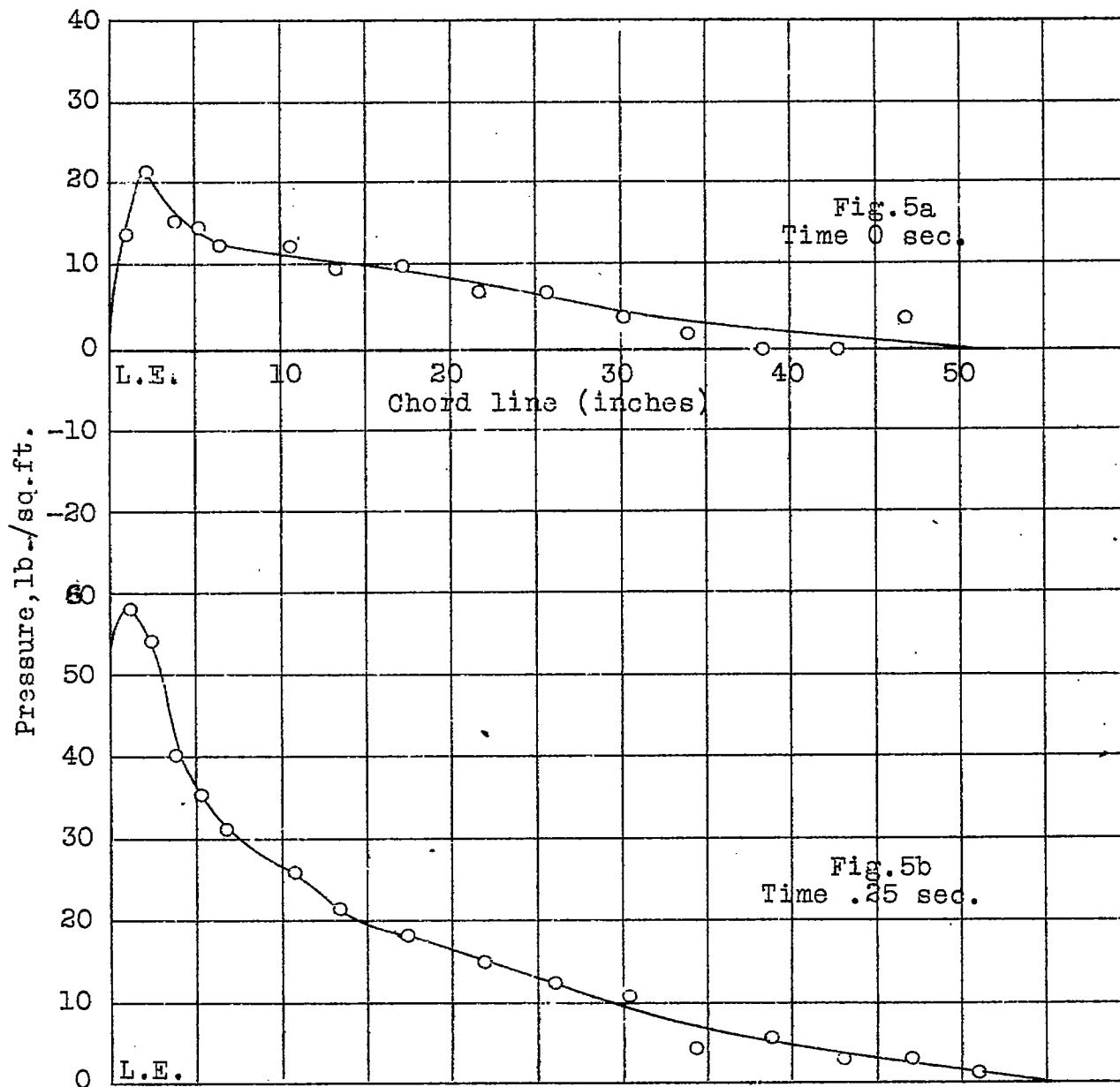

Fig.5 Pressure distribution on a VE-7 airplane in a pull up at 82 M.P.H.



Figs.5a,b Pressure distribution on VE-7 airplane in a pull-up at 82 M.P.H.

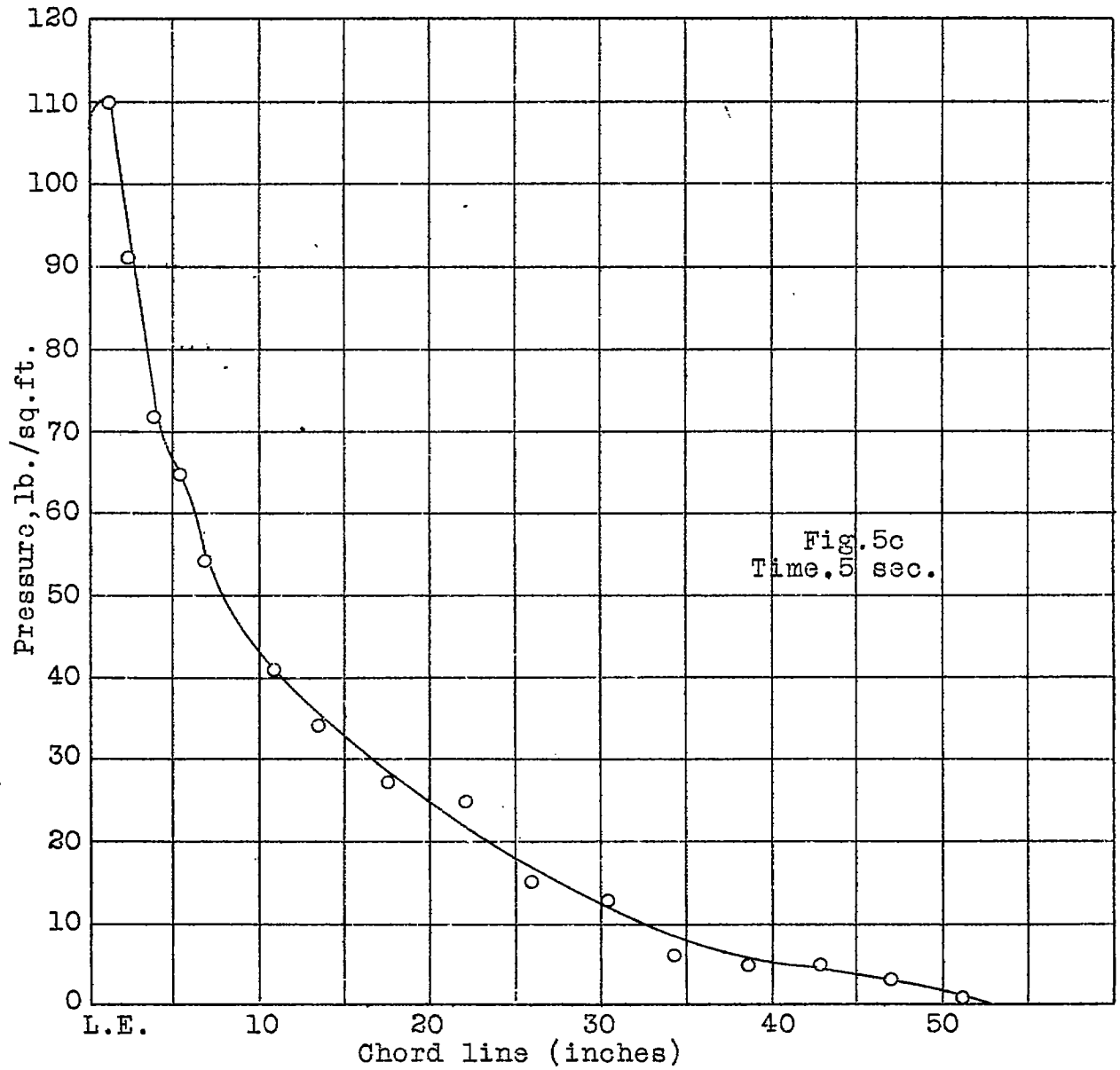

Fig.5c Pressure distribution on VE-7 airplane in a pull-up at 82 M.P.H.

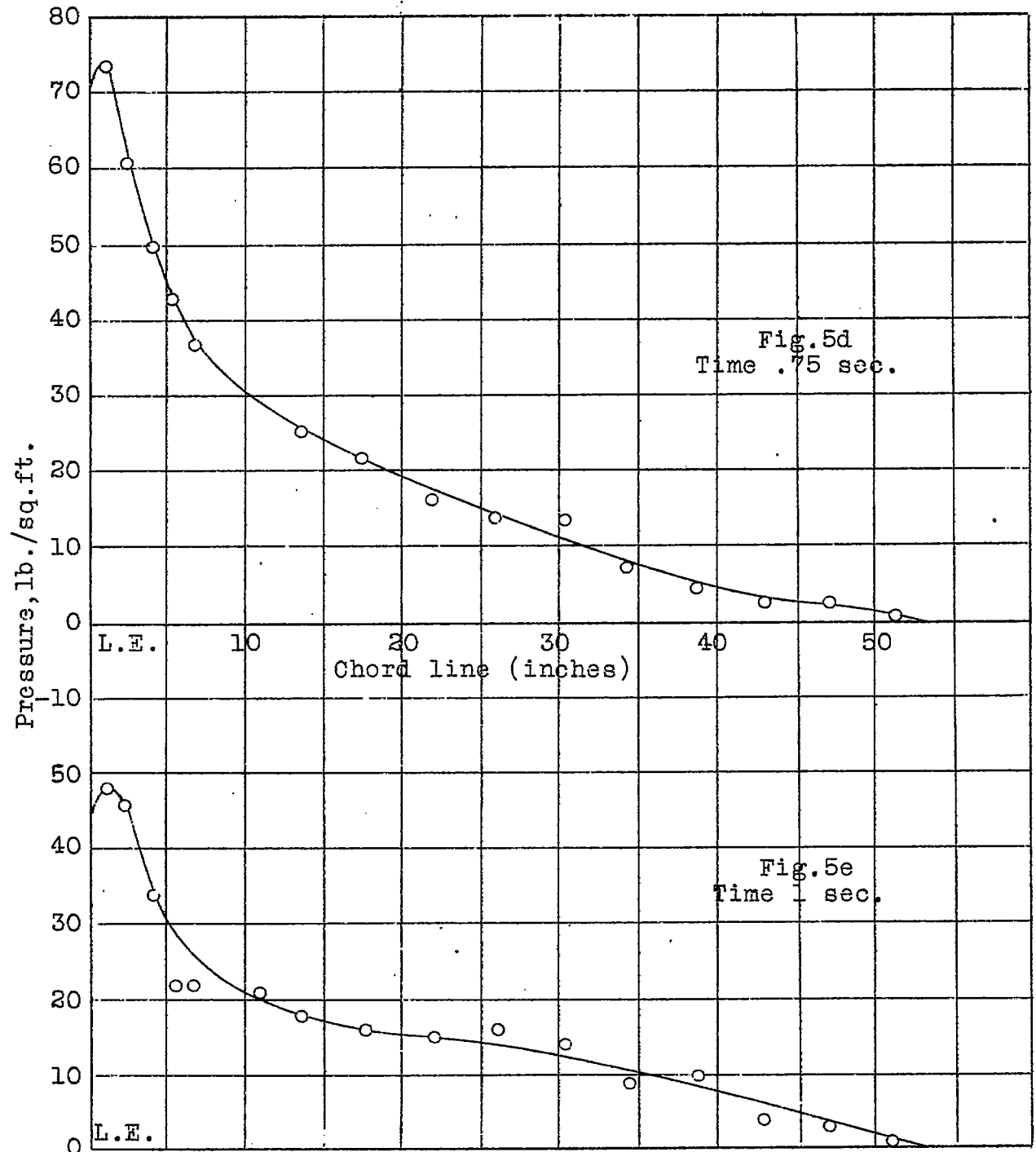

Fig.5d,e Pressure distribution on VE-7 airplane in a pull-up at 82 M.P.H.

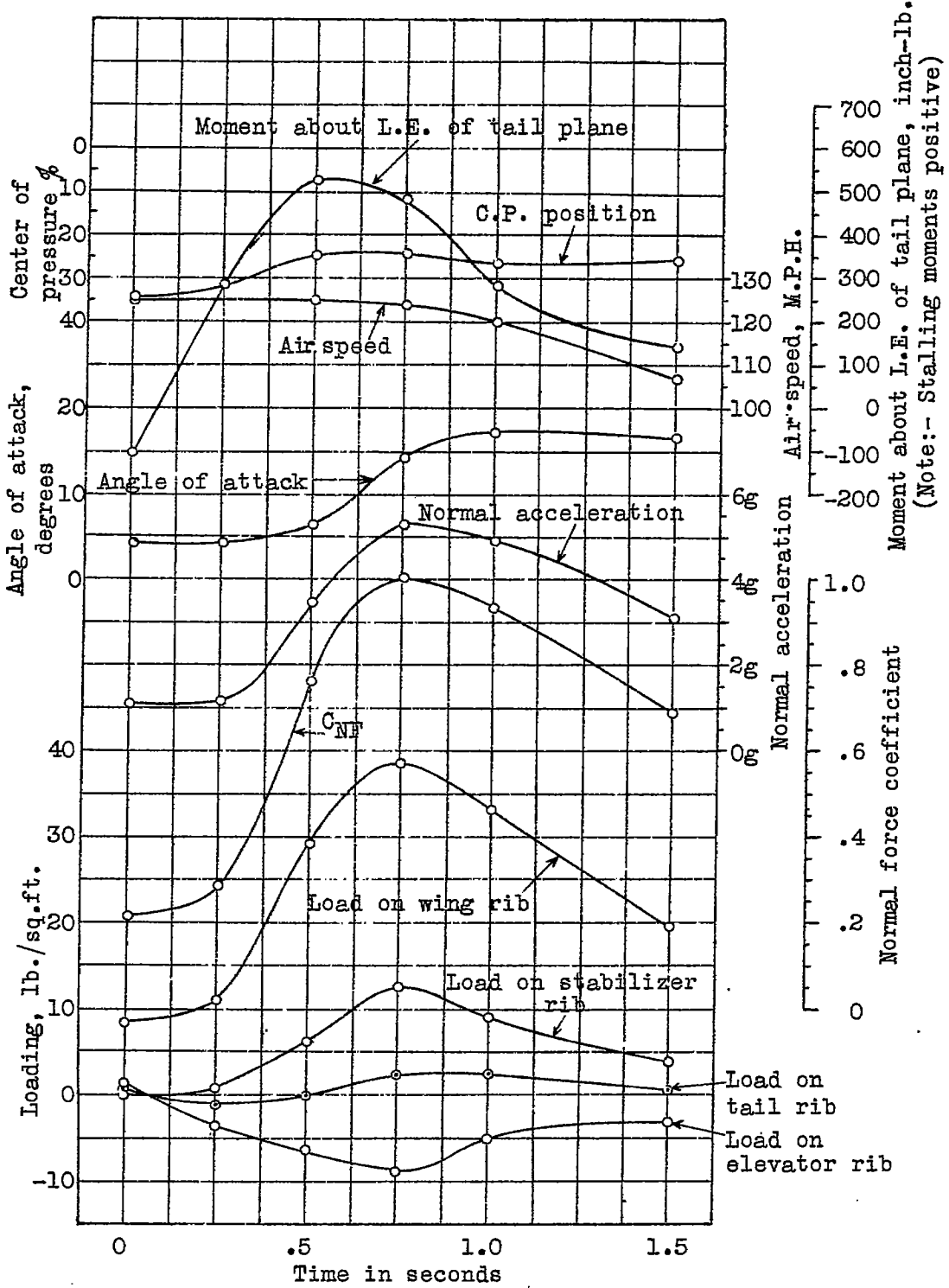
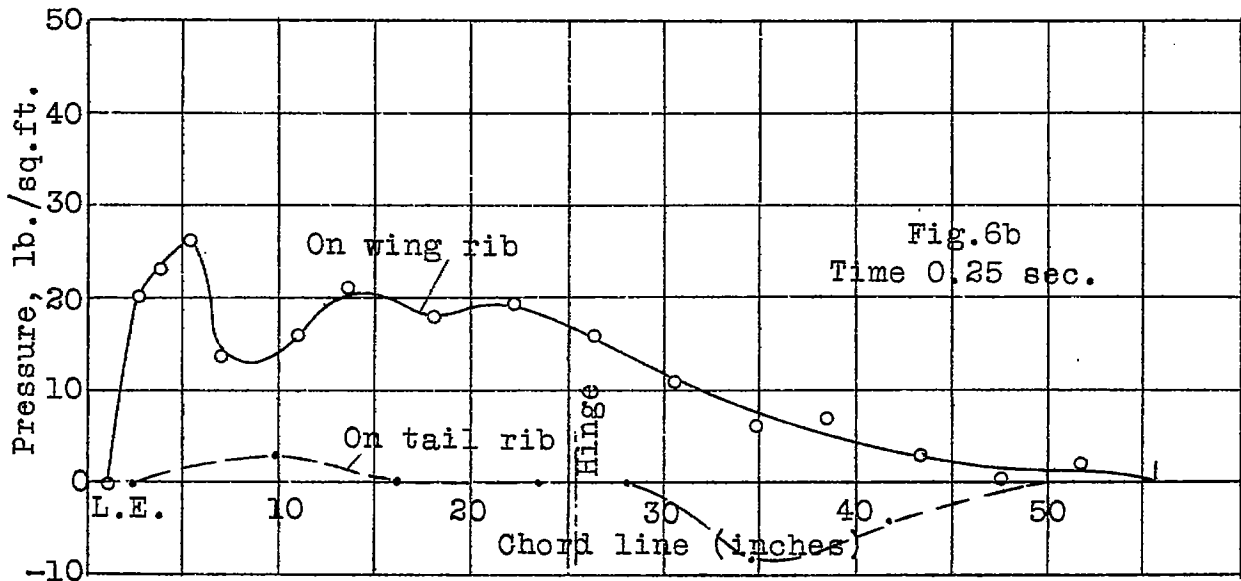
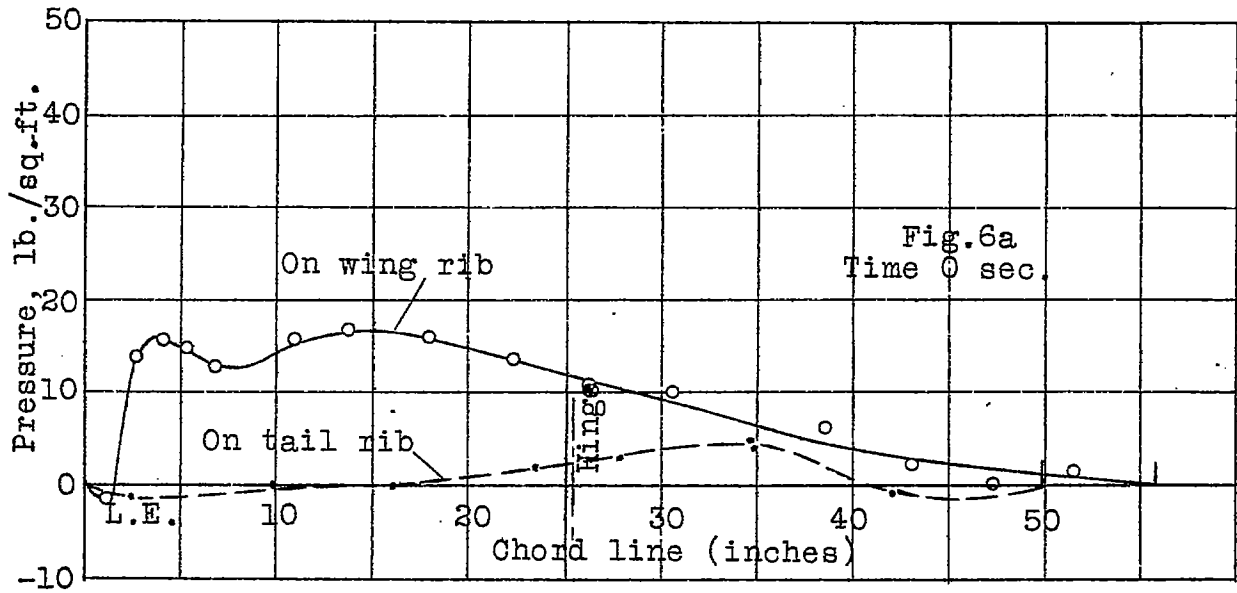

Fig.6 Pressure distribution on a VE-7 airplane in a pull up at 125 M.P.H.



Figs.6a, b Pressure distribution on VE-7 airplane in a pull-up at 125 M.P.H.

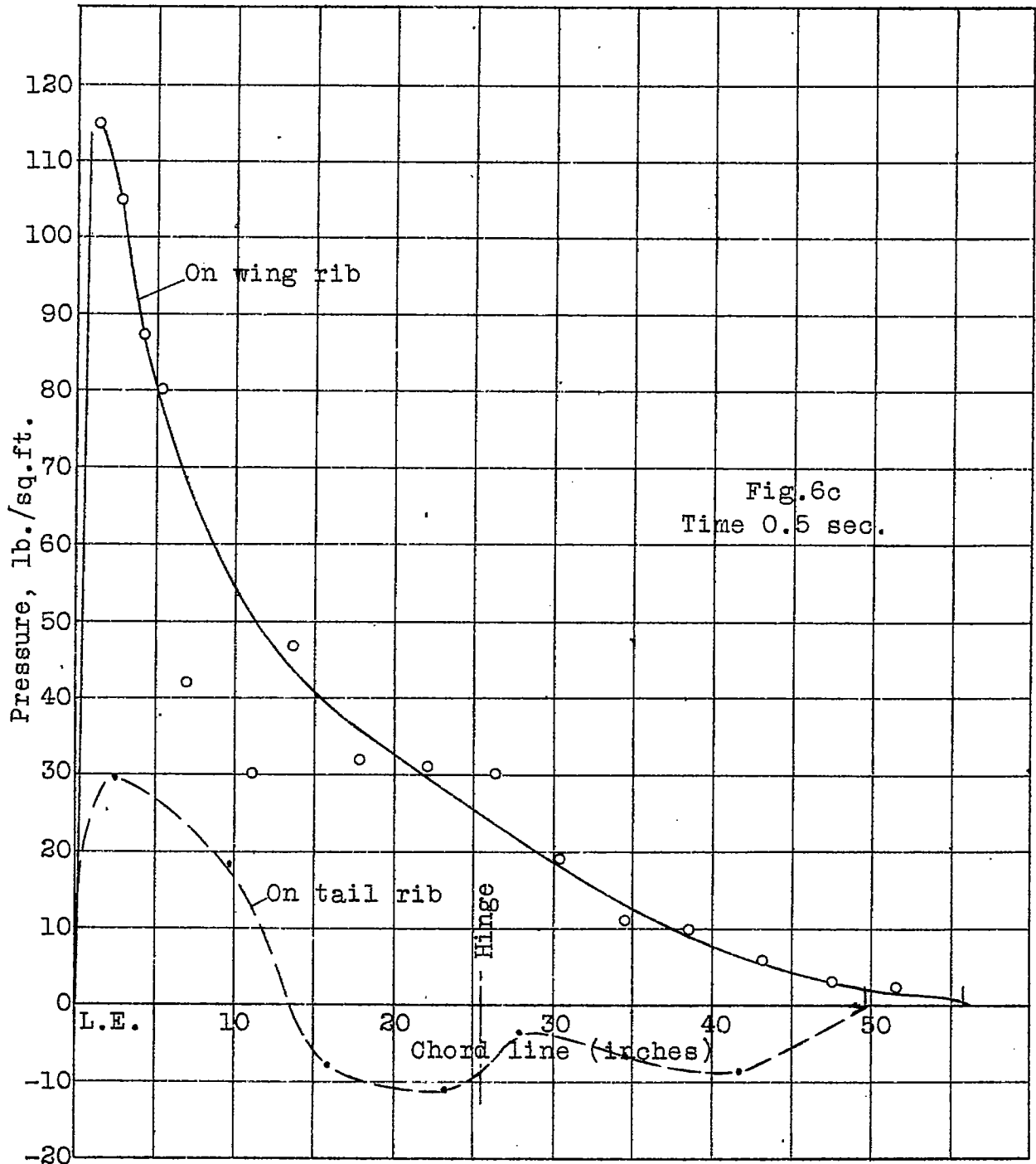
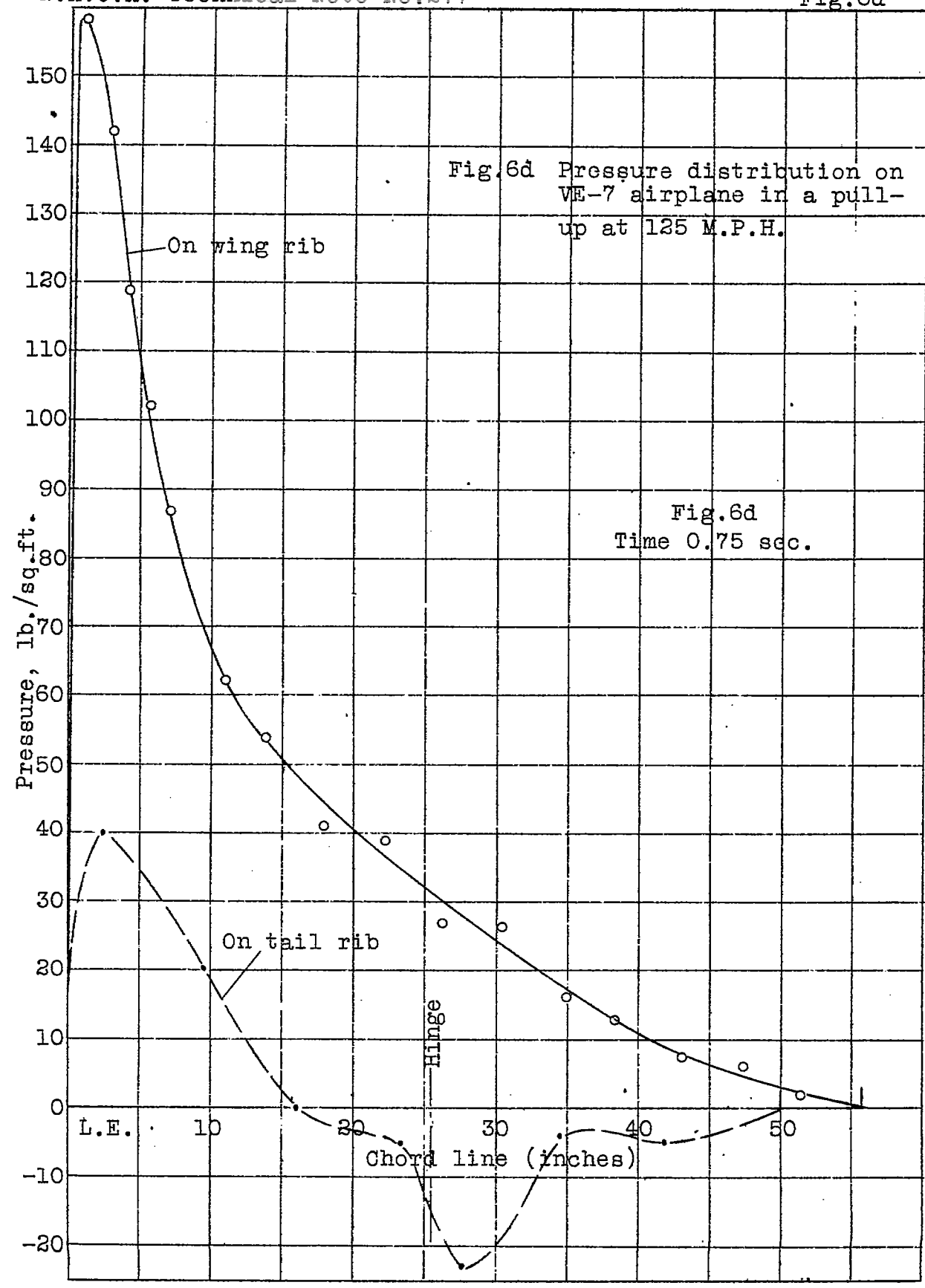

Fig.6c Pressure distribution on VE-7 airplane in a pull-up at 125 M.P.H.





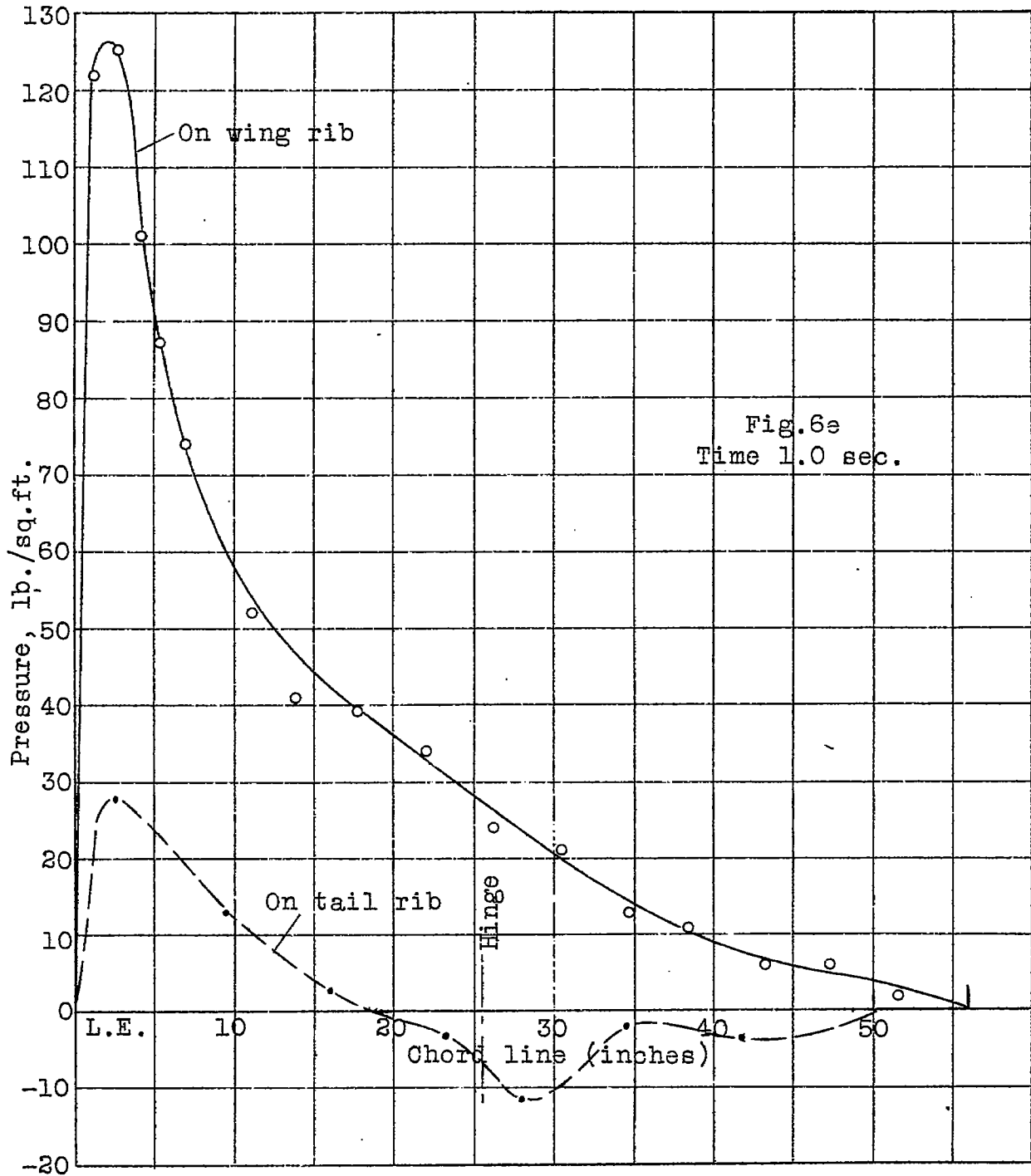

Fig.6e Pressure distribution on VE-7 airplane in a pull-up at 125 M.P.H.

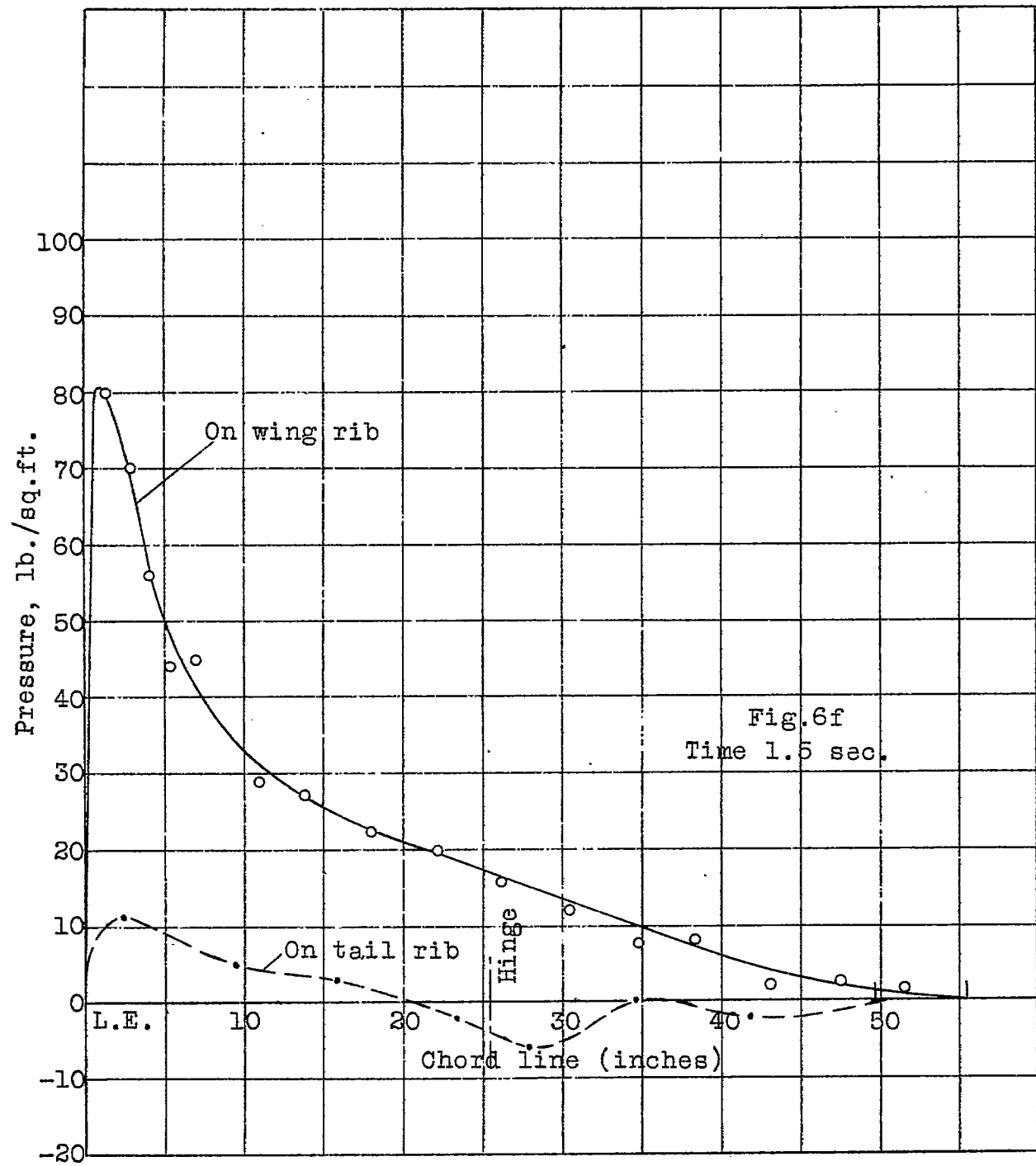

Fig.6f Pressure distribution on VE-7 airplane in a pull-up at 125 M.P.H.

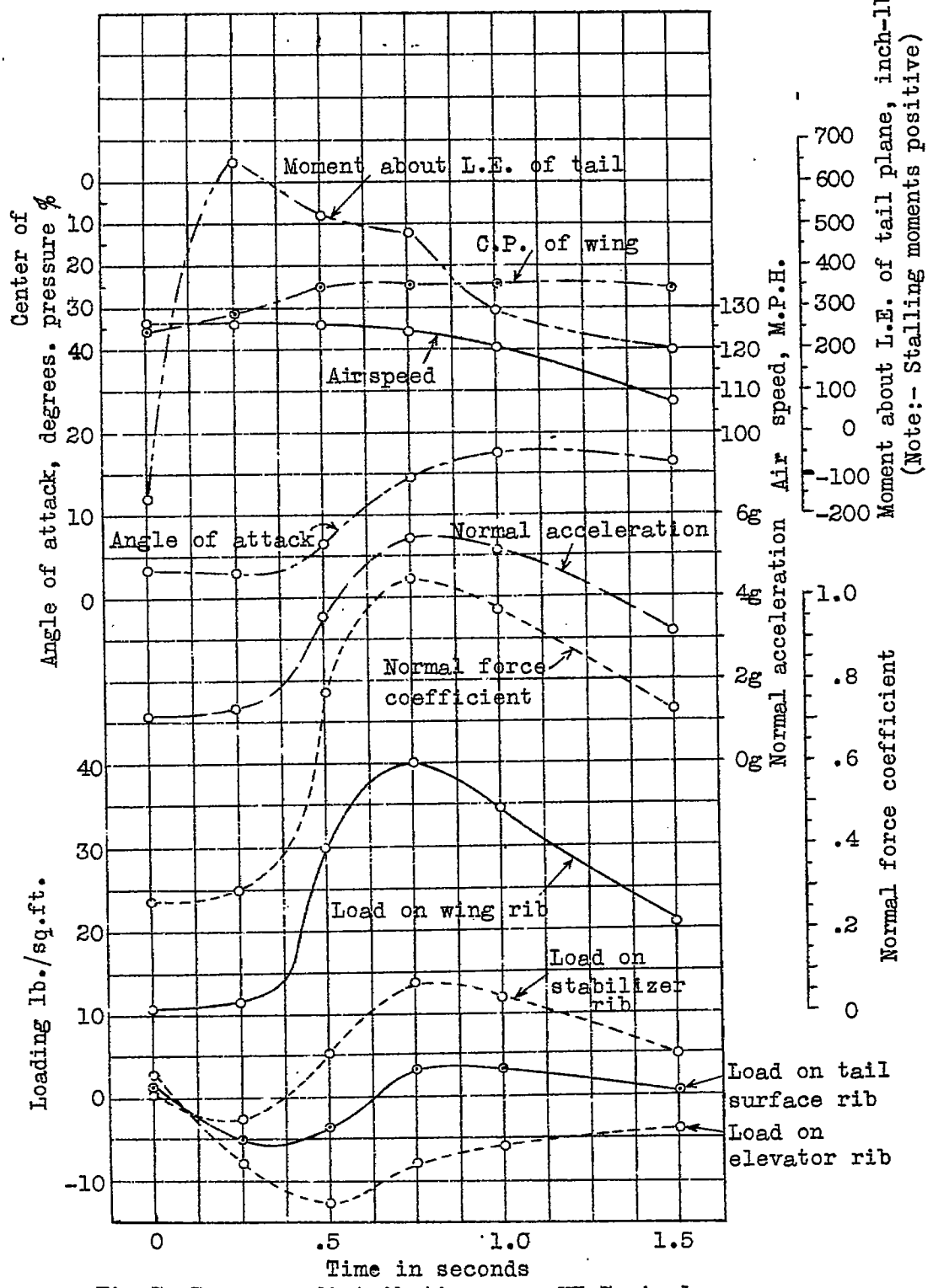

Fig.7 Pressure distribution on a VE-7 airplane in a pull up at 126 M.P.H.

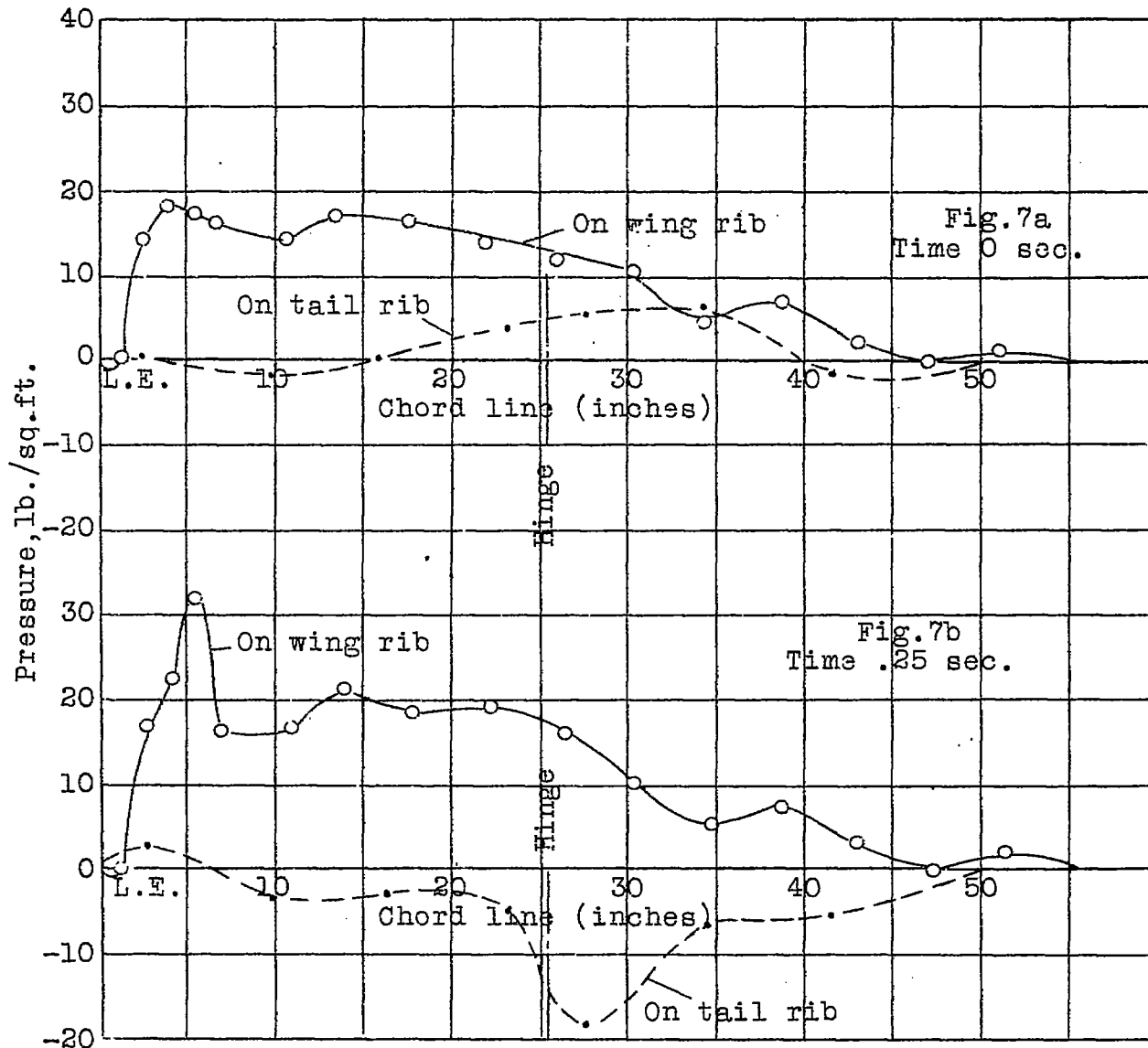

Fig.7a,b Pressure distribution on VE-7 airplane in a pull-up at 126 M.P.H.

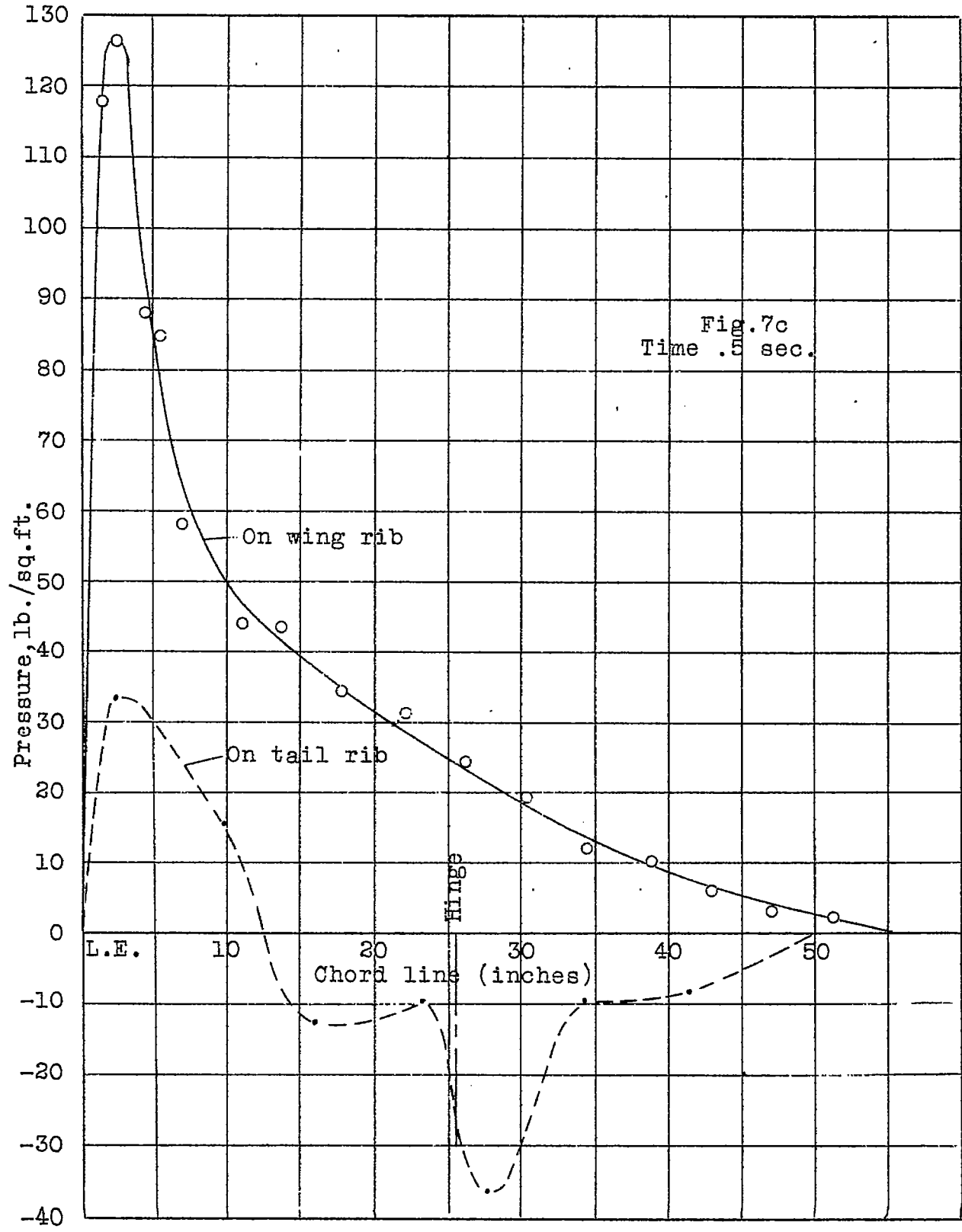
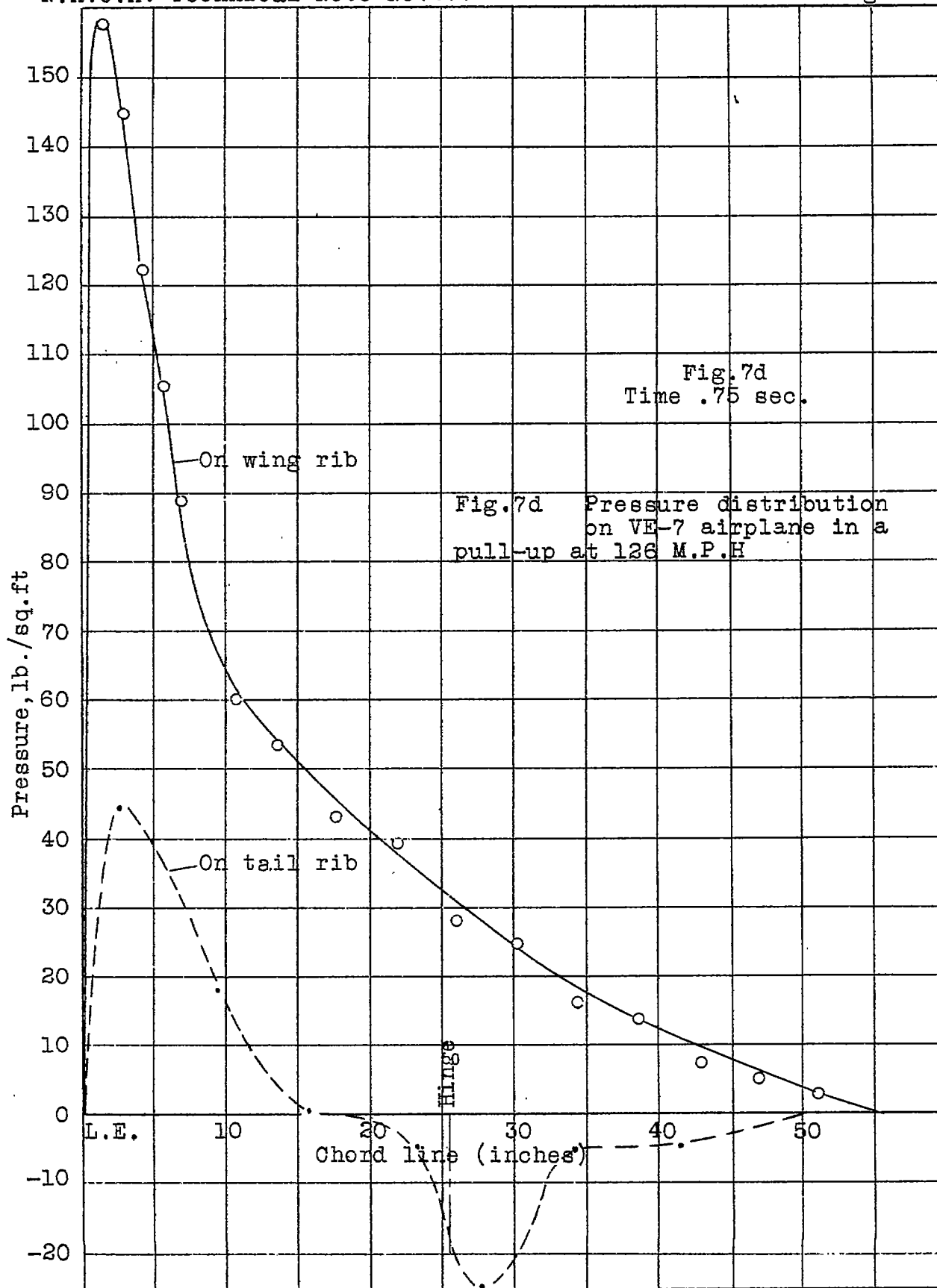

Fig.7c Pressure distribution on VE-7 airplane in a pull-up at 126 M.P.H.



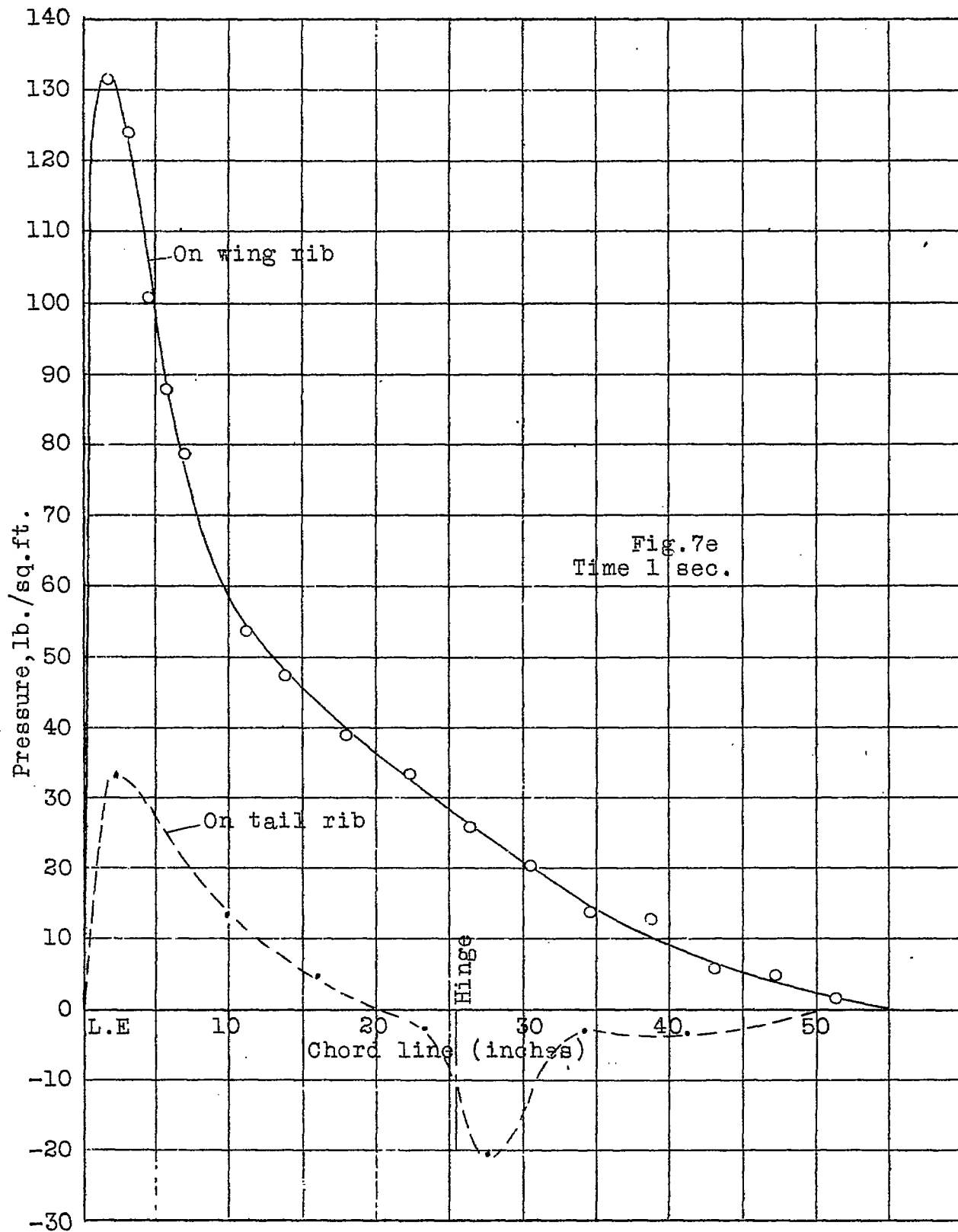

Fig.7e Pressure distribution on VE-7 airplane in a pull-up at 126 M.P.H.

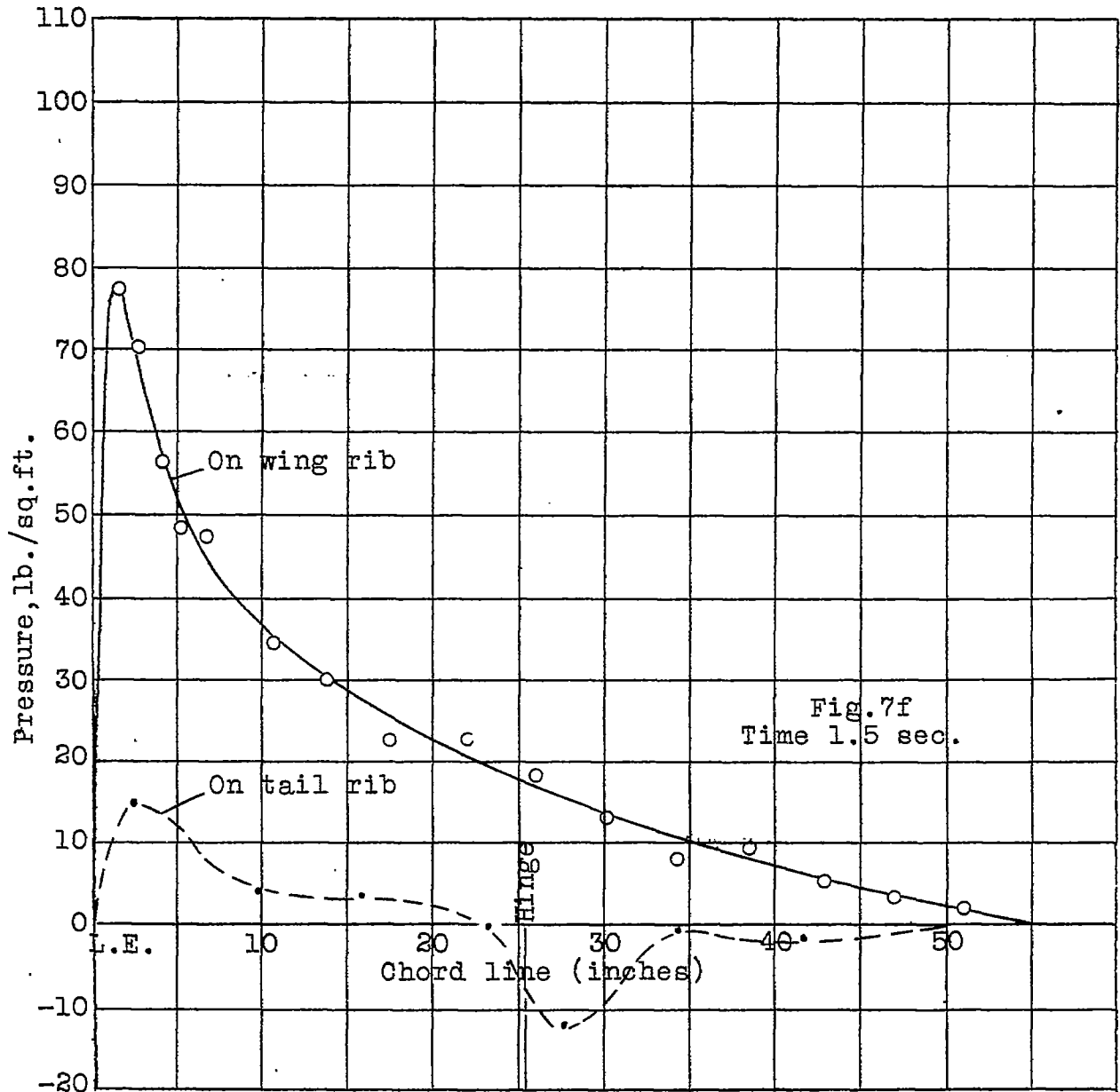

Fig. 7f Pressure distribution on VE-7 airplane in a pull-up at 126 M.P.H.



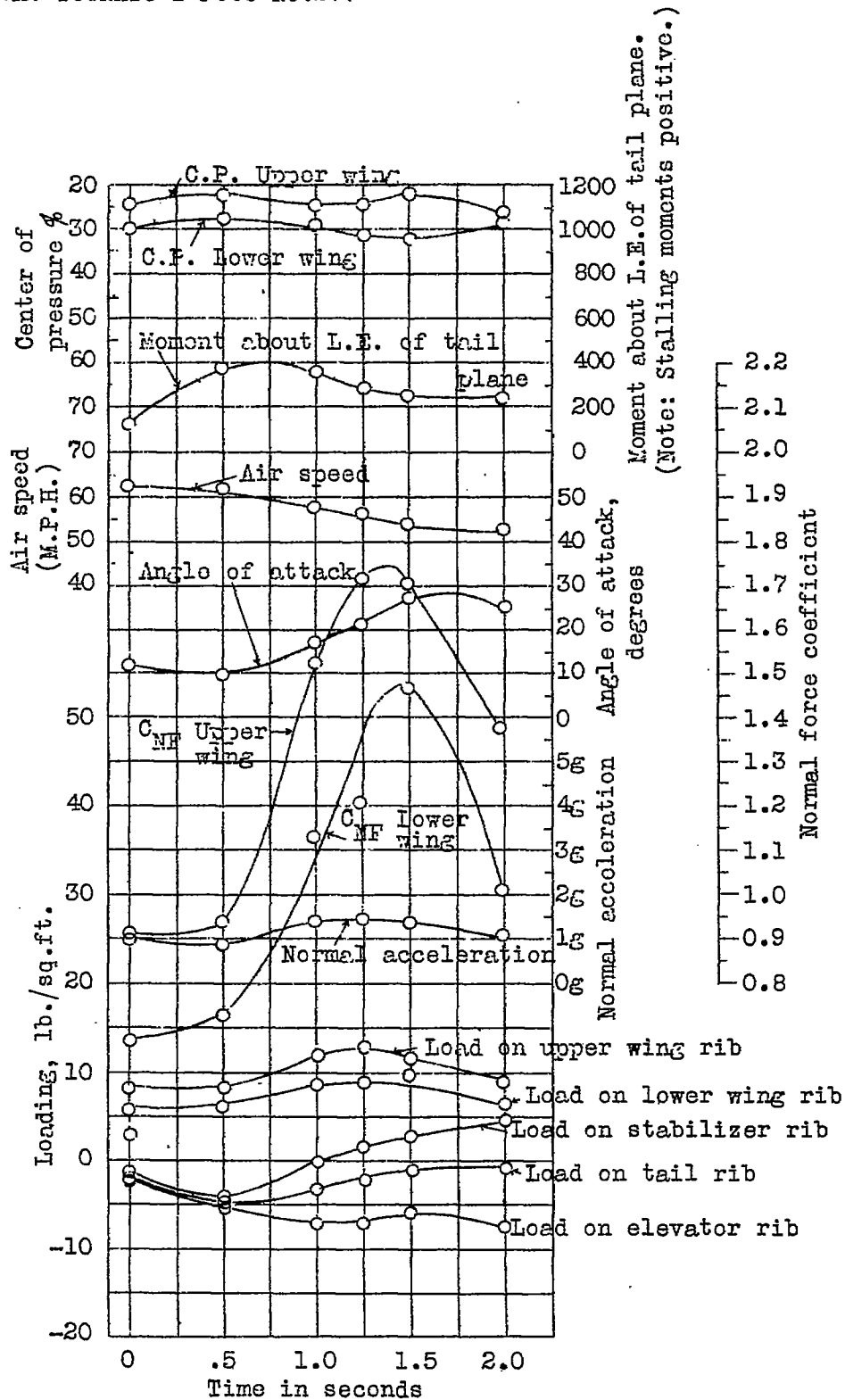
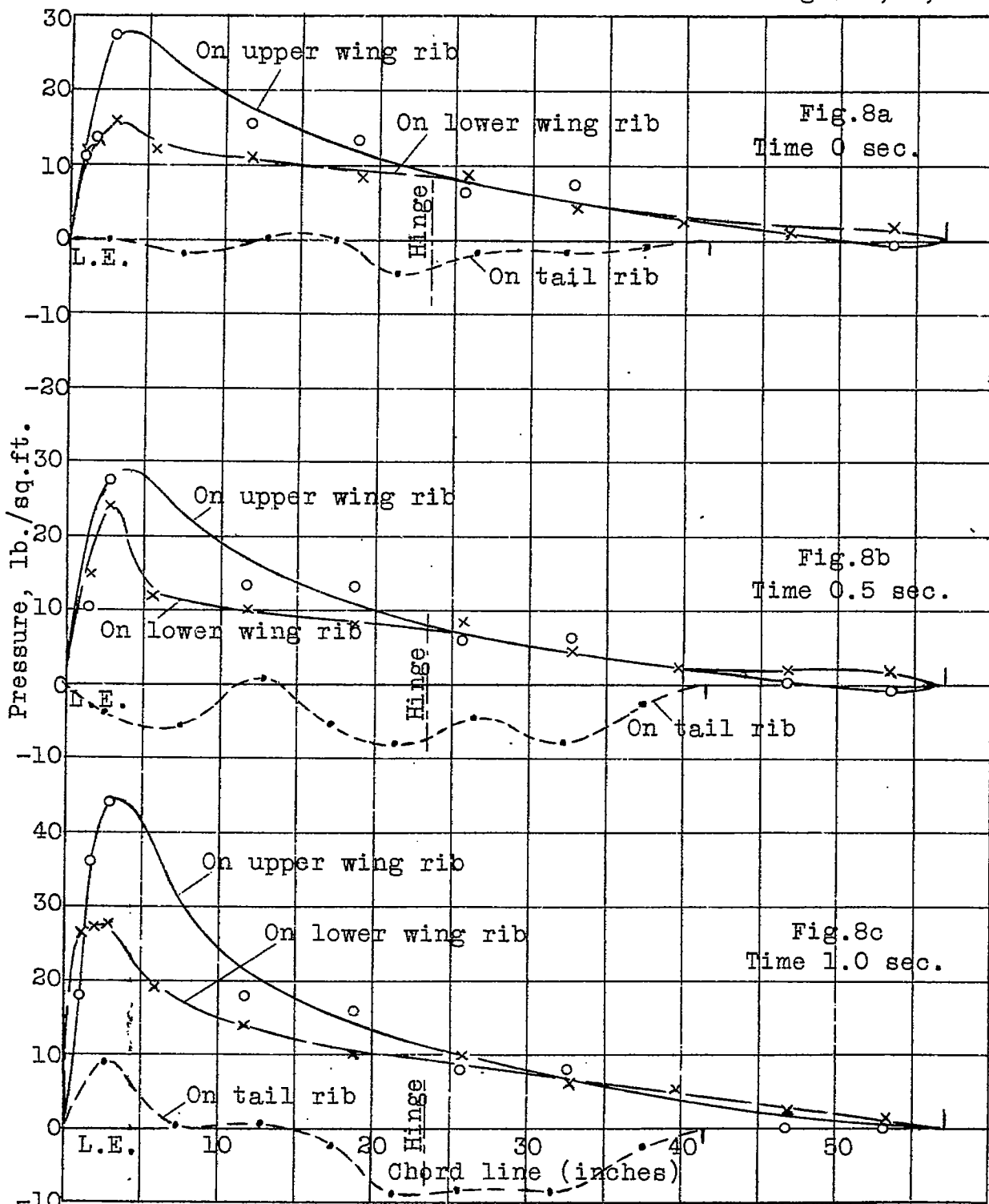

Fig. 8 Pressure distribution on a TS airplane in a pull up at 62 M.P.H.

N.A.C.A. Technical Note No.277

Figs.8a, b, c.



Figs.8a, b, c. Pressure distribution on TS airplane in a pull-up at 62 M.P.H.

N.A.C.A. Technical Note No.277

Figs.8d, e, 'f.

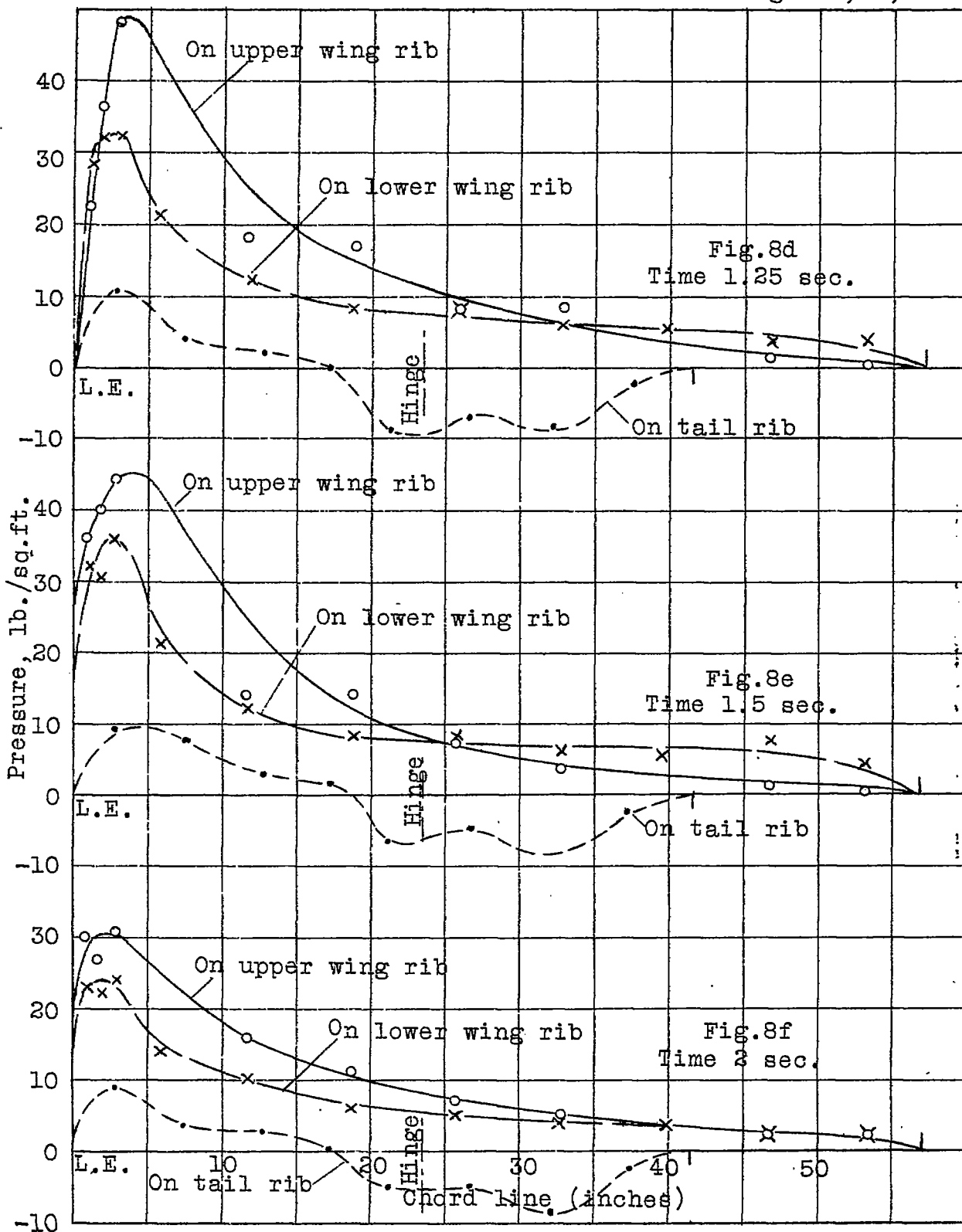

Figs.8d, e, f. Pressure distribution on TS airplane in a pull-up at 62 M.P.H.

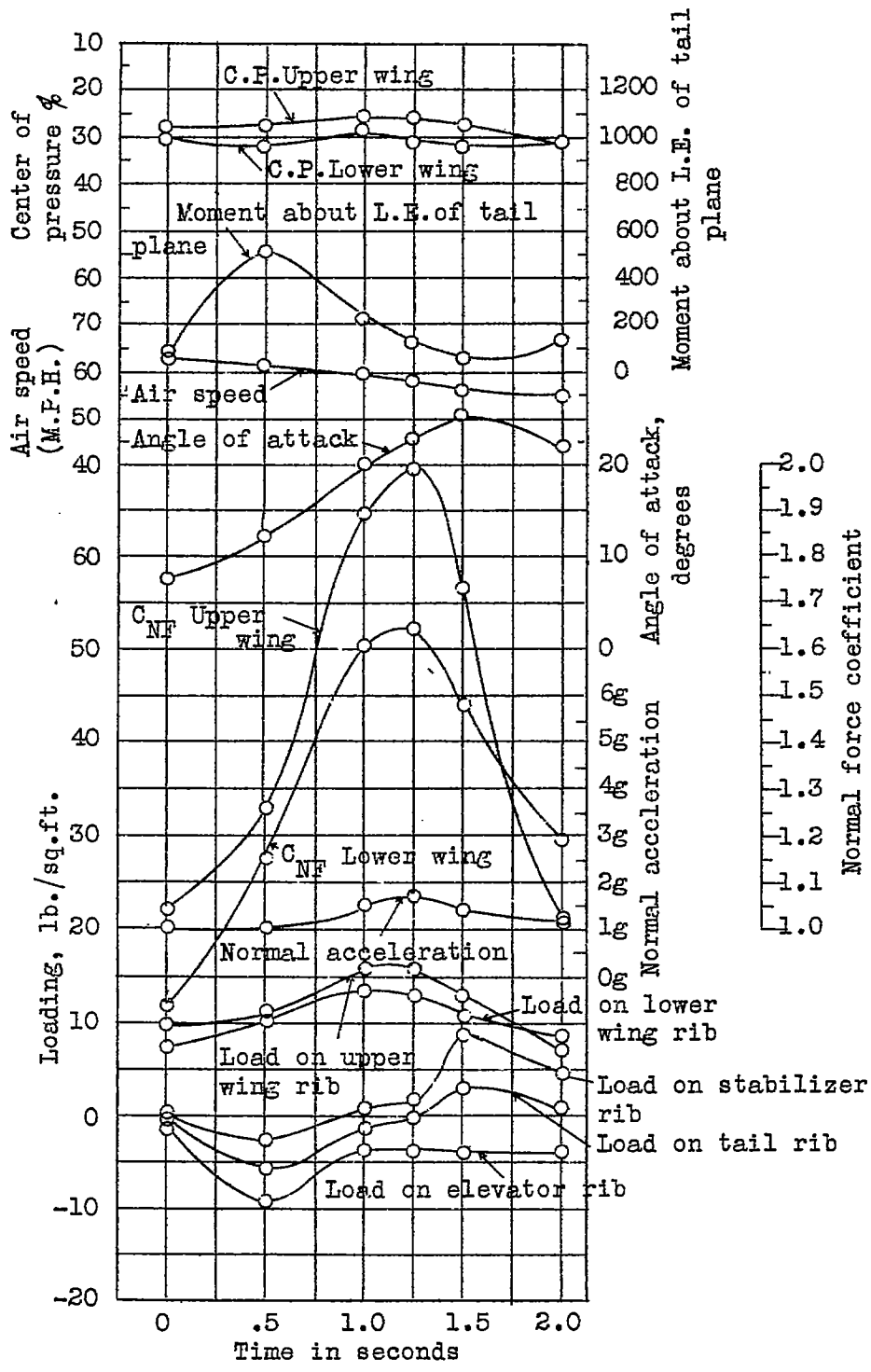
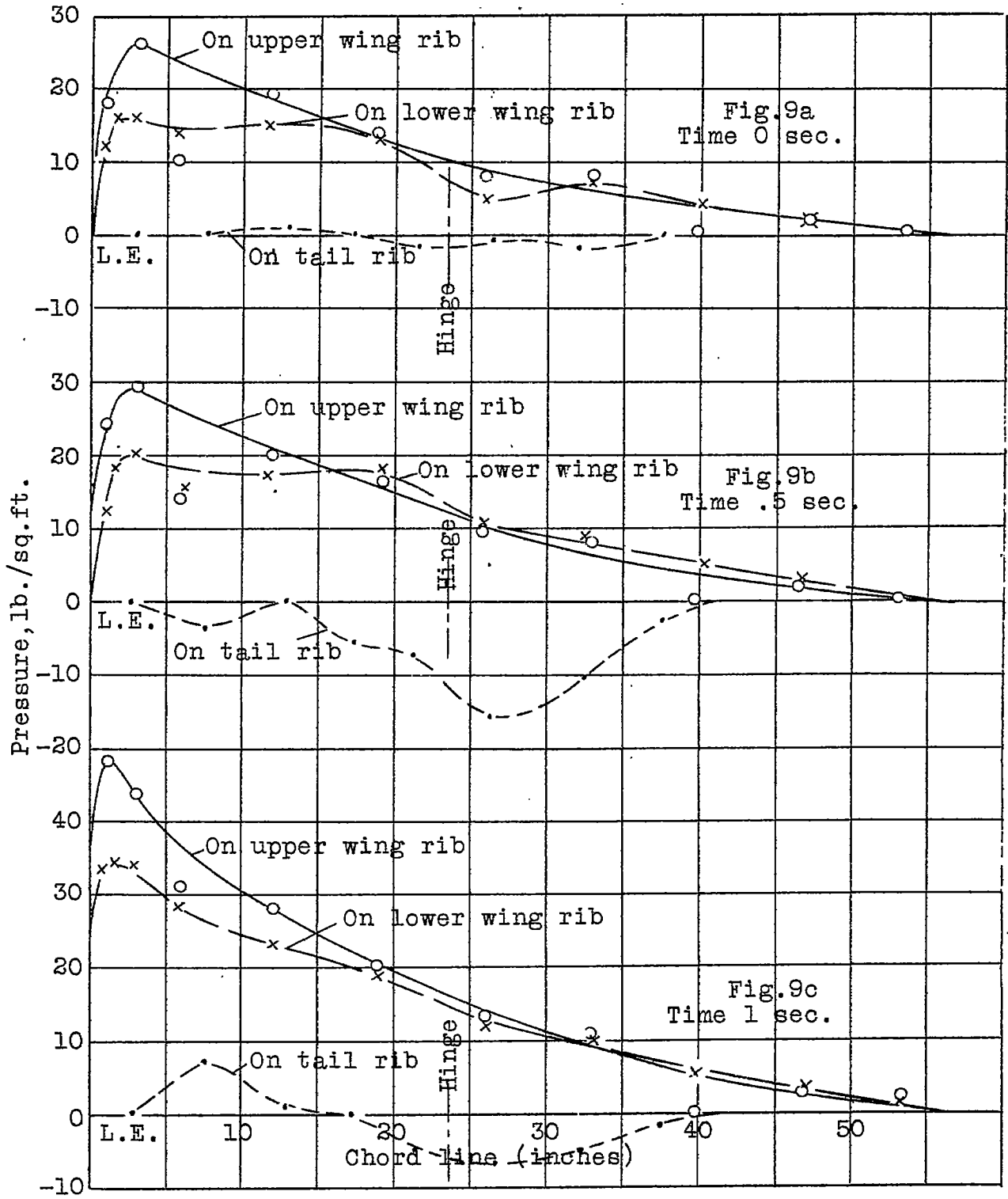
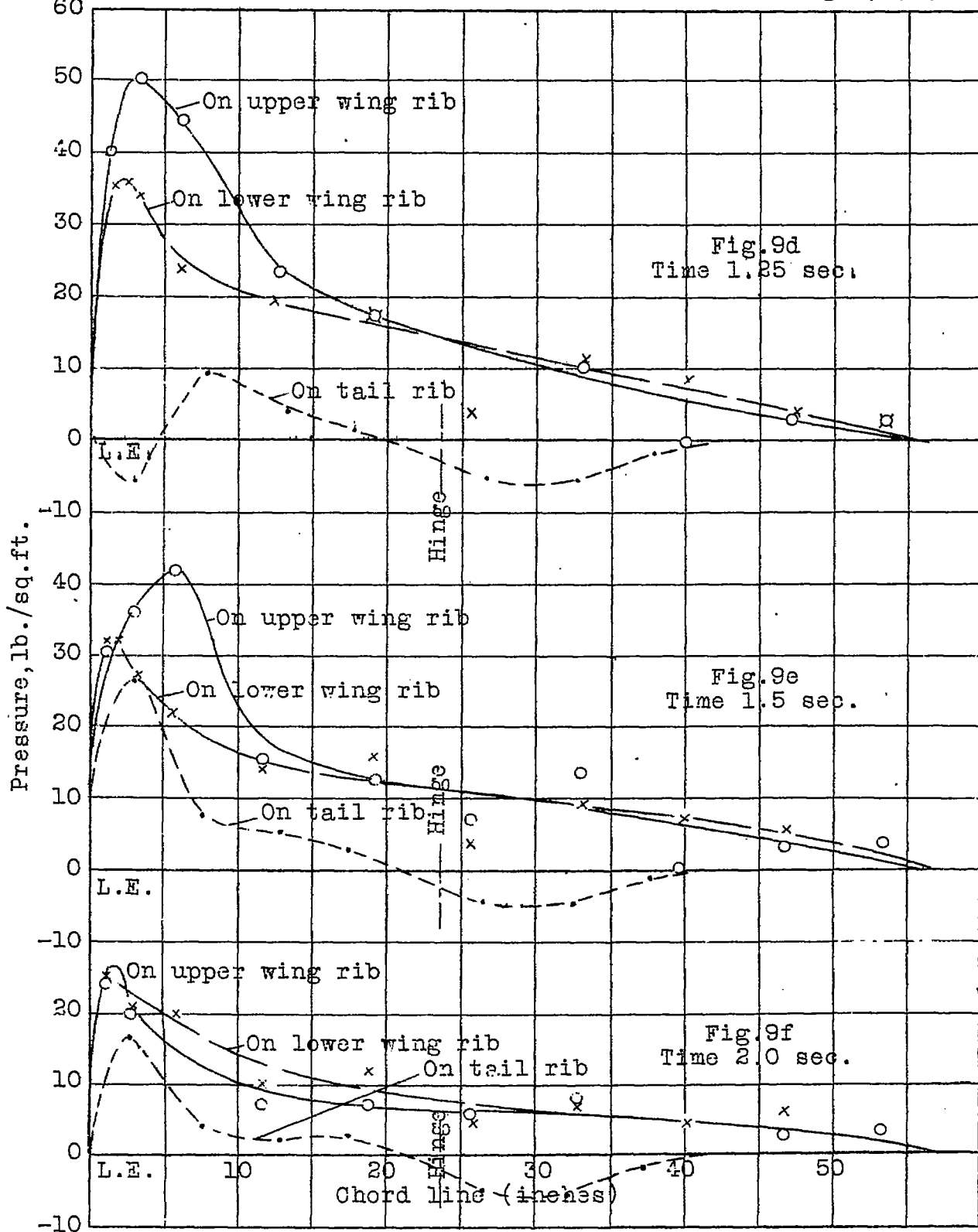

Fig.9 Pressure distribution on a TS airplane in a pull up at 63 M.P.H.



Figs.9a,b,c Pressure distribution on TS airplane in a pull-up at 63 M.P.H.



Figs.9d,e,f Pressure distribution on TS airplane in a pull-up at 63 M.P.H.

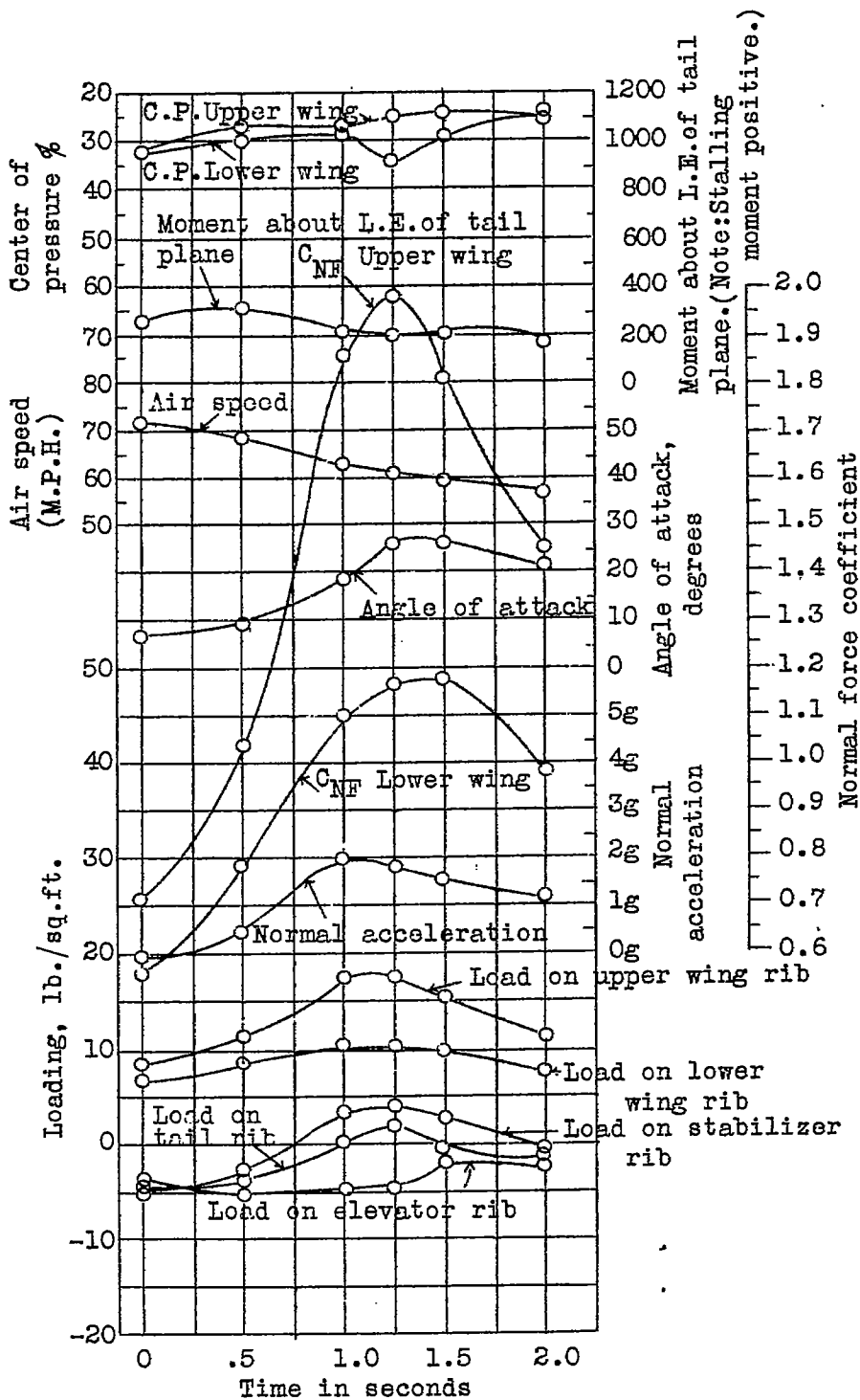
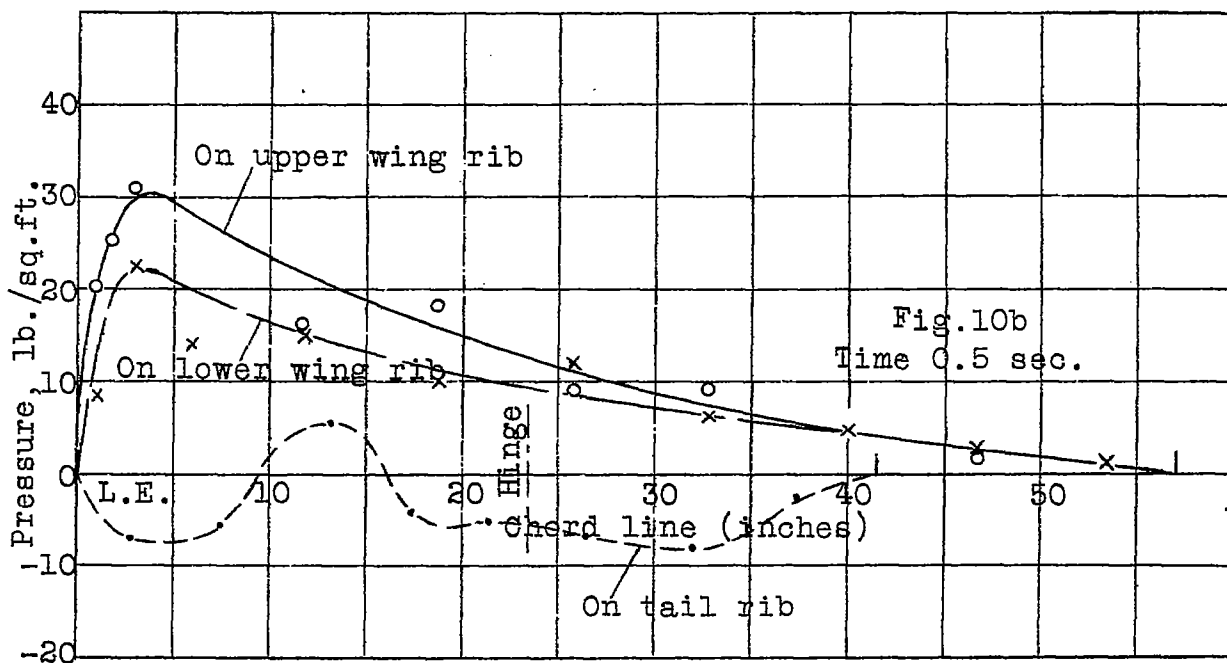
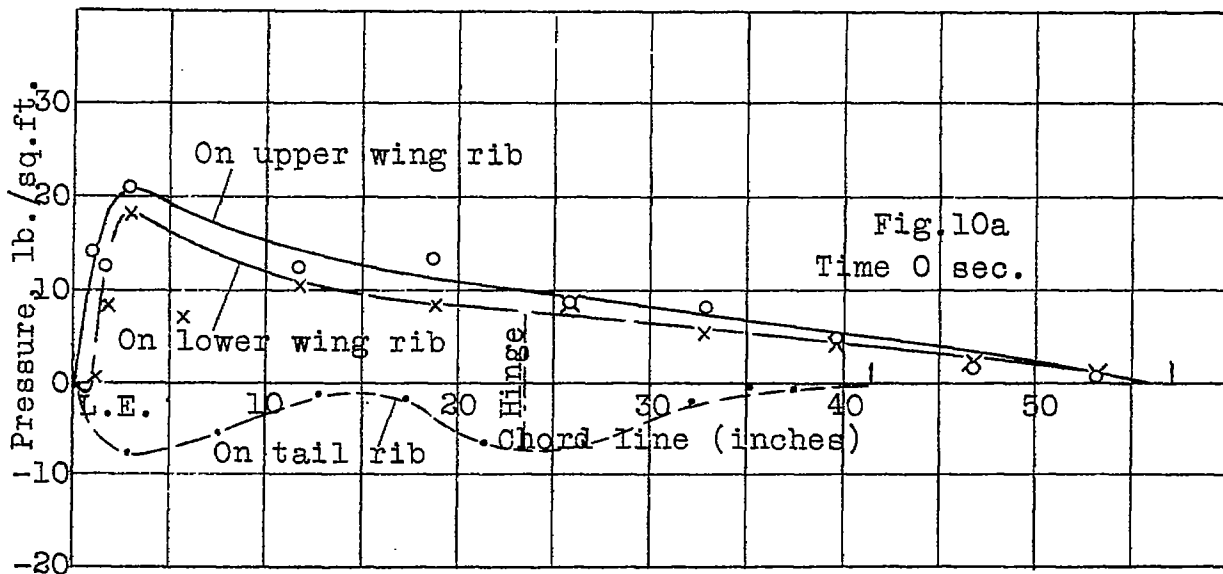
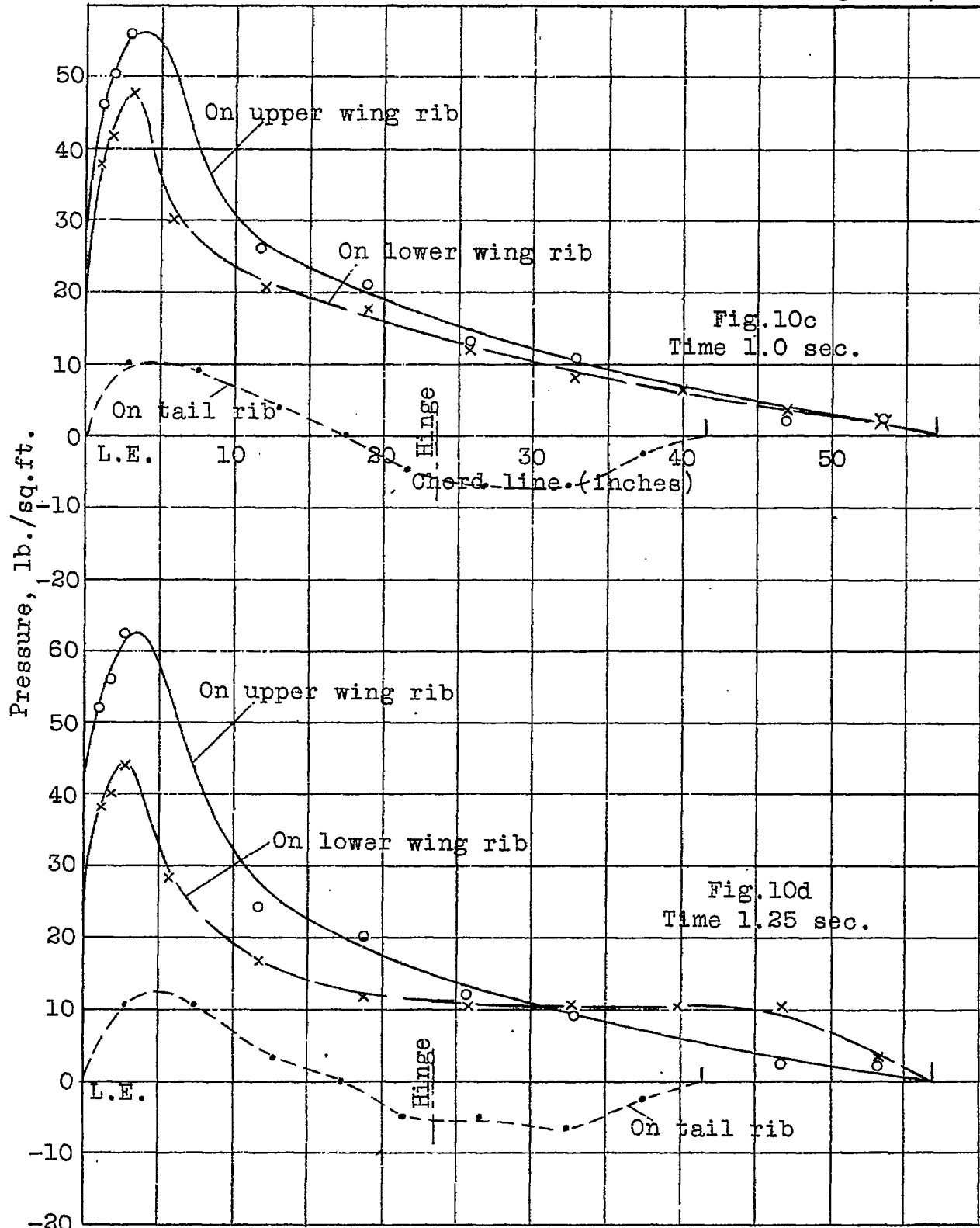

Fig.10 Pressure distribution on a TS airplane in a pull up at 71 M.P.H.



Figs.10a, b. Pressure distribution on TS airplane in a pull-up at 71 M.P.H.





Figs.10c, d. Pressure distribution on TS airplane in a pull-up at 71 M.P.H.

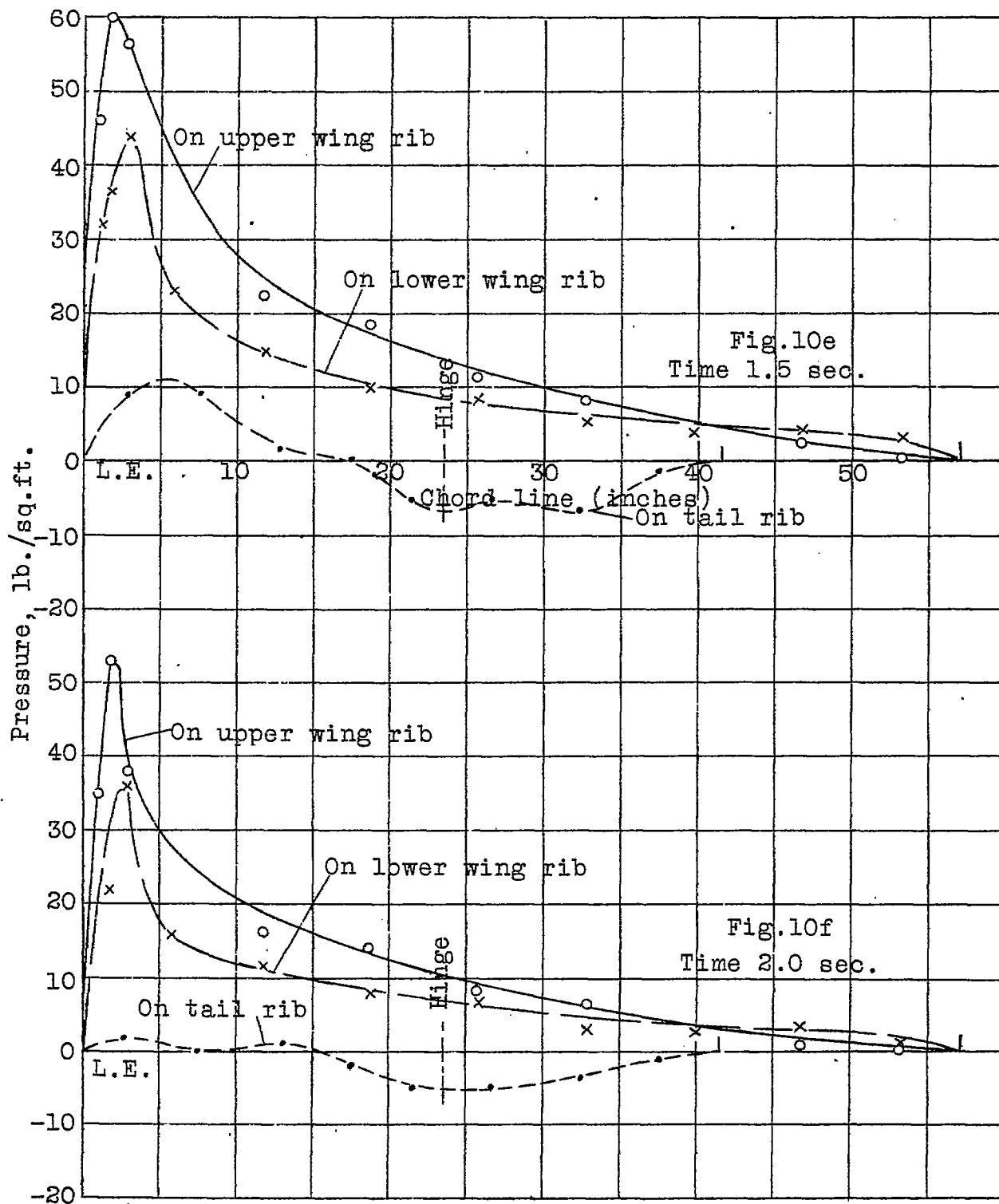

Figs. 10e, . f. Pressure distribution on TS airplane in a pull-up at 71 M.P.H.

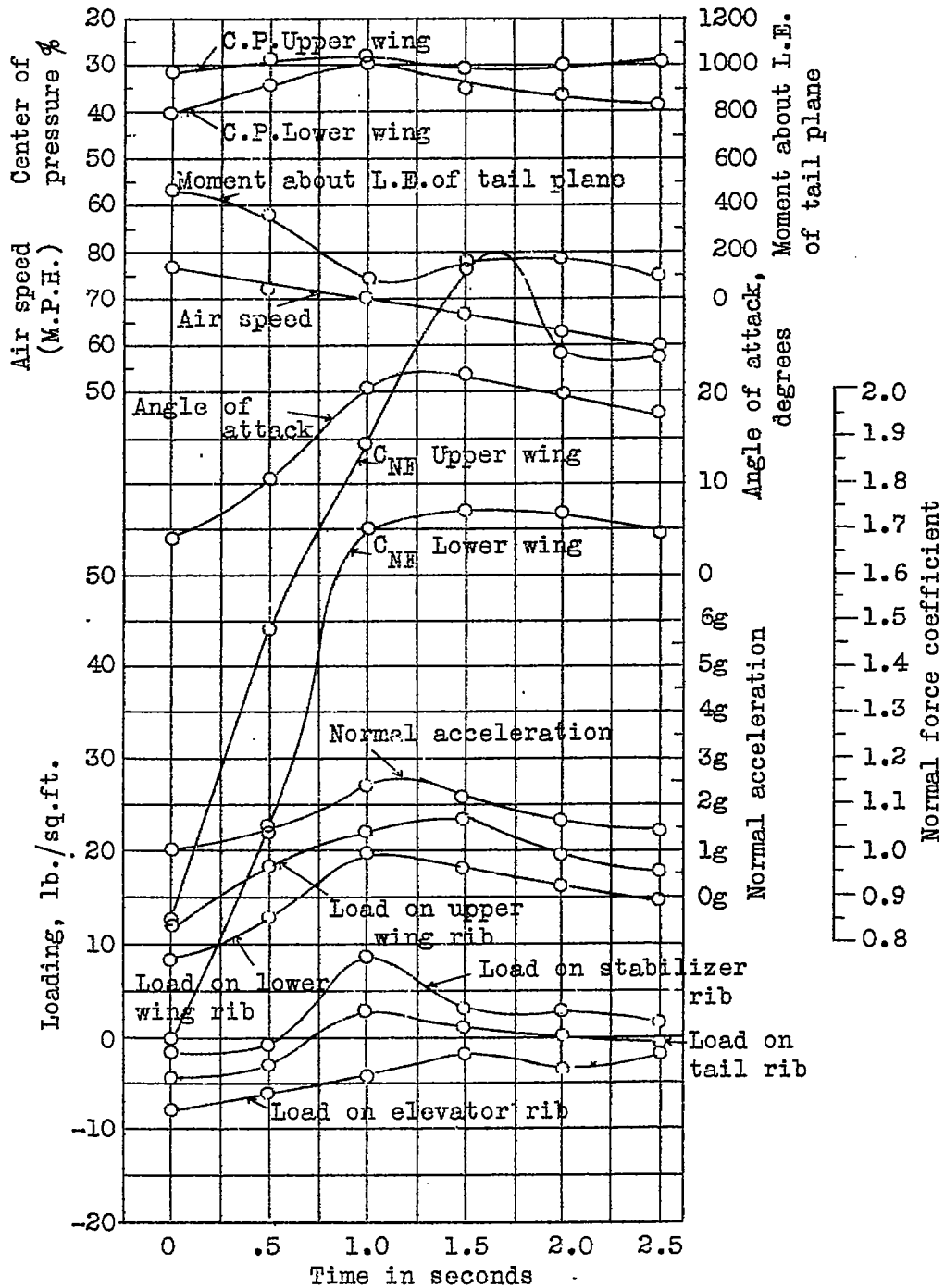
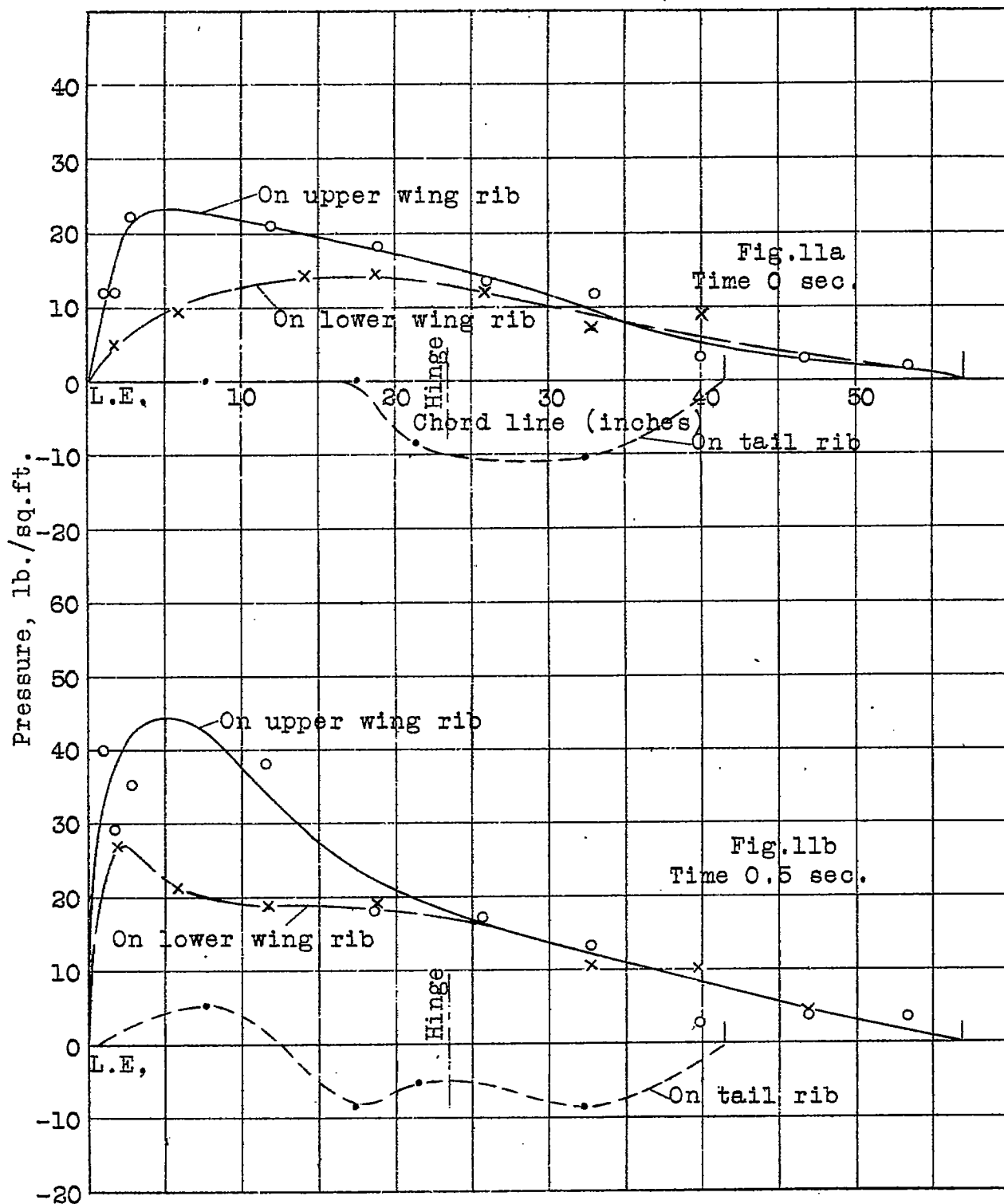
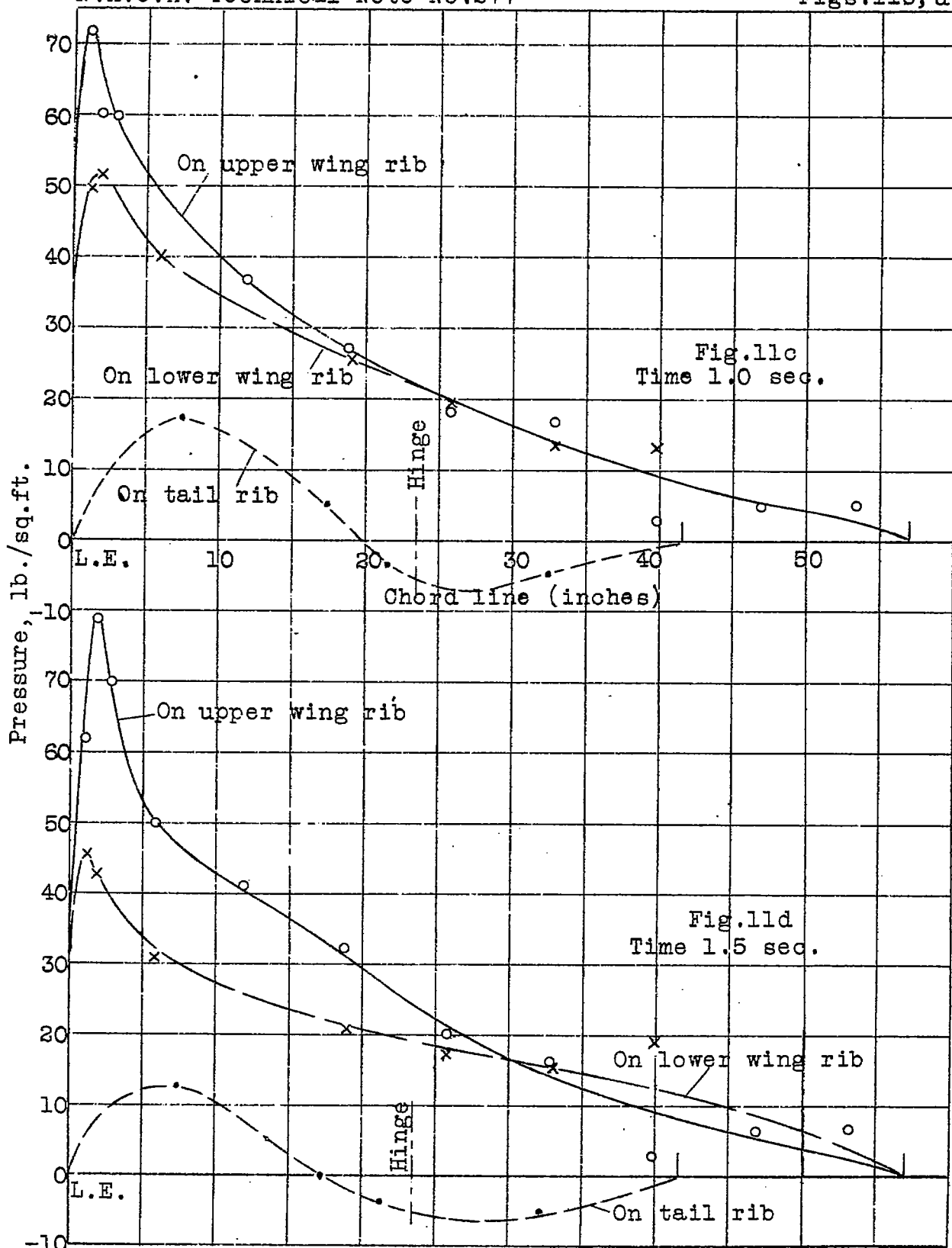

Fig.11 Pressure distribution on a TS airplane in a pull up at 77 M.P.H.



Figs.11a, b. Pressure distribution on TS airplane in a pull-up at 77 M.P.H.



Figs. 11c, d. Pressure distribution on TS airplane in a pull-up at 77 M.P.H.

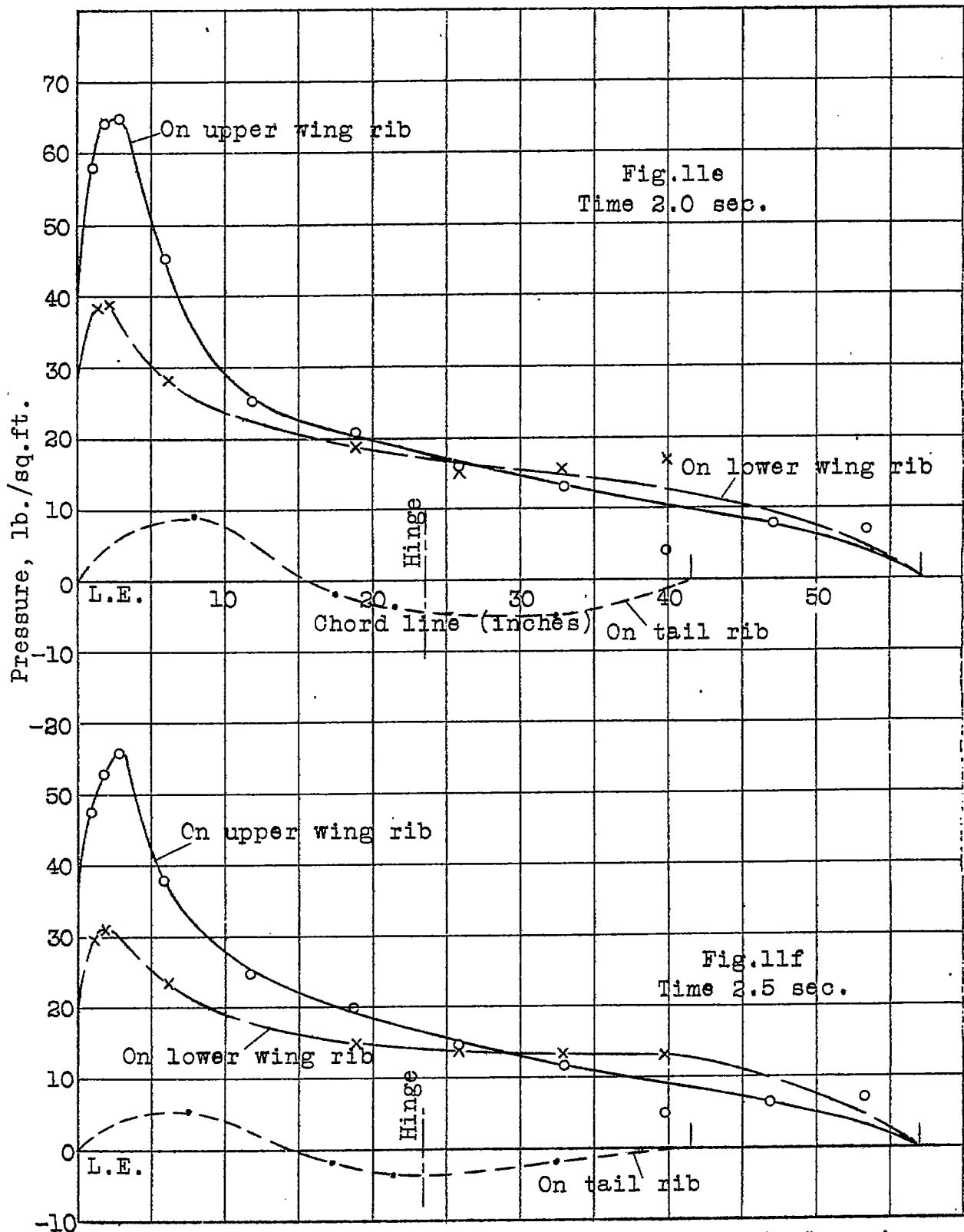

Figs.11e, f. Pressure distribution on TS airplane in a pull-up at 77 M.P.H.

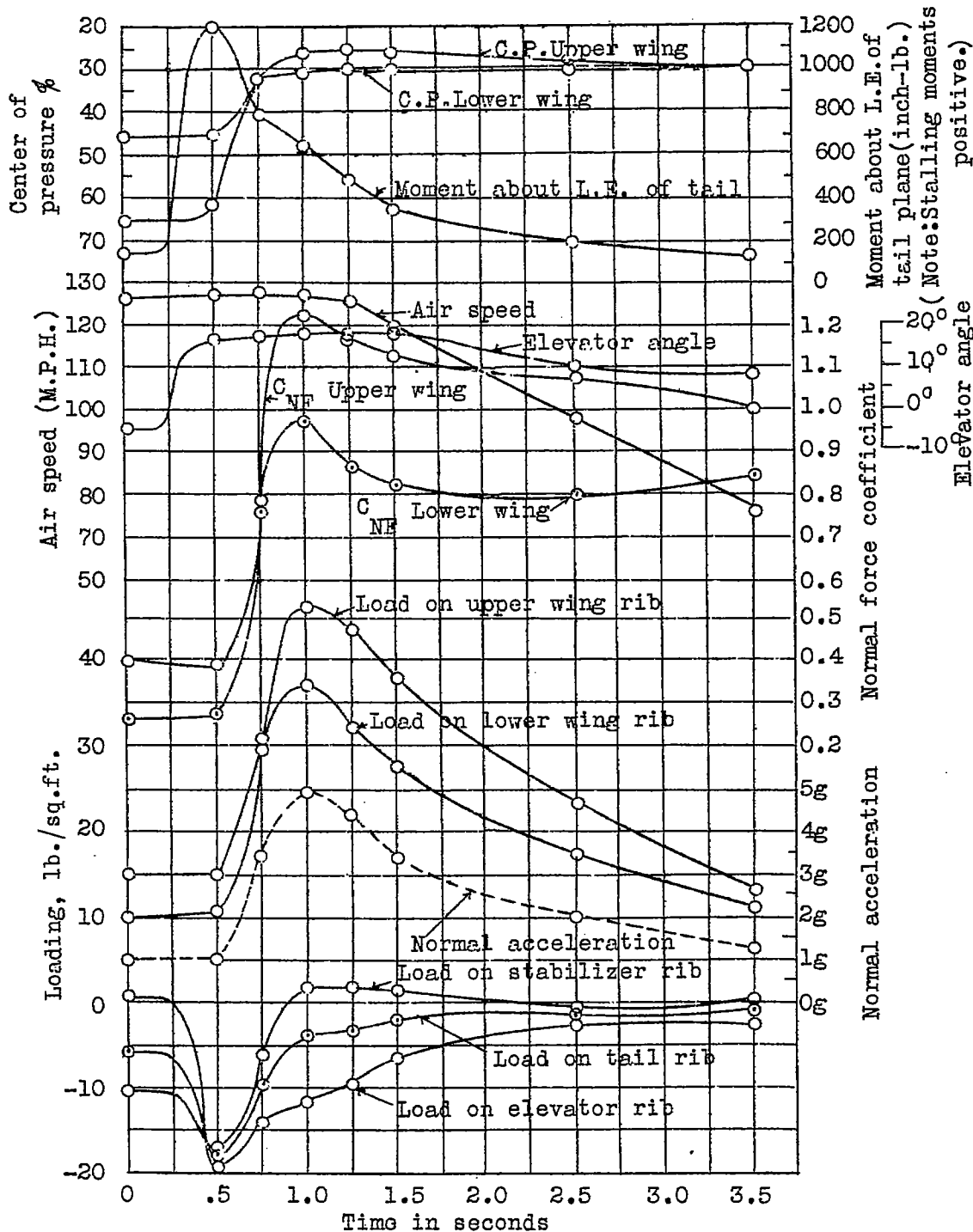

Fig.12 Pressure distribution on a TS airplane in a pull up with power on at 127 M.P.H.

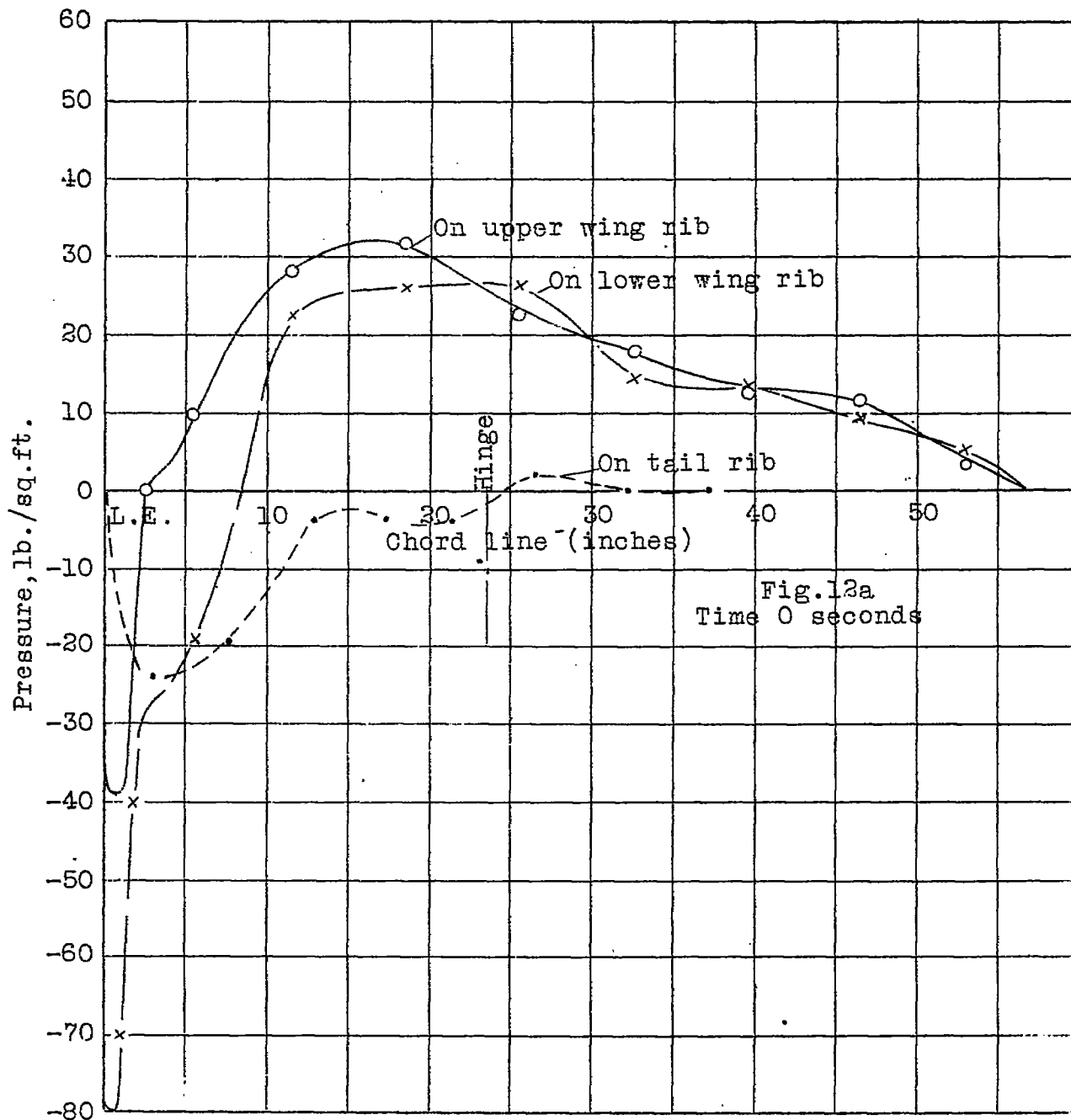

Fig. 12a Pressure distribution on TS airplane in a pull-up with power on at 127 M.P.H.



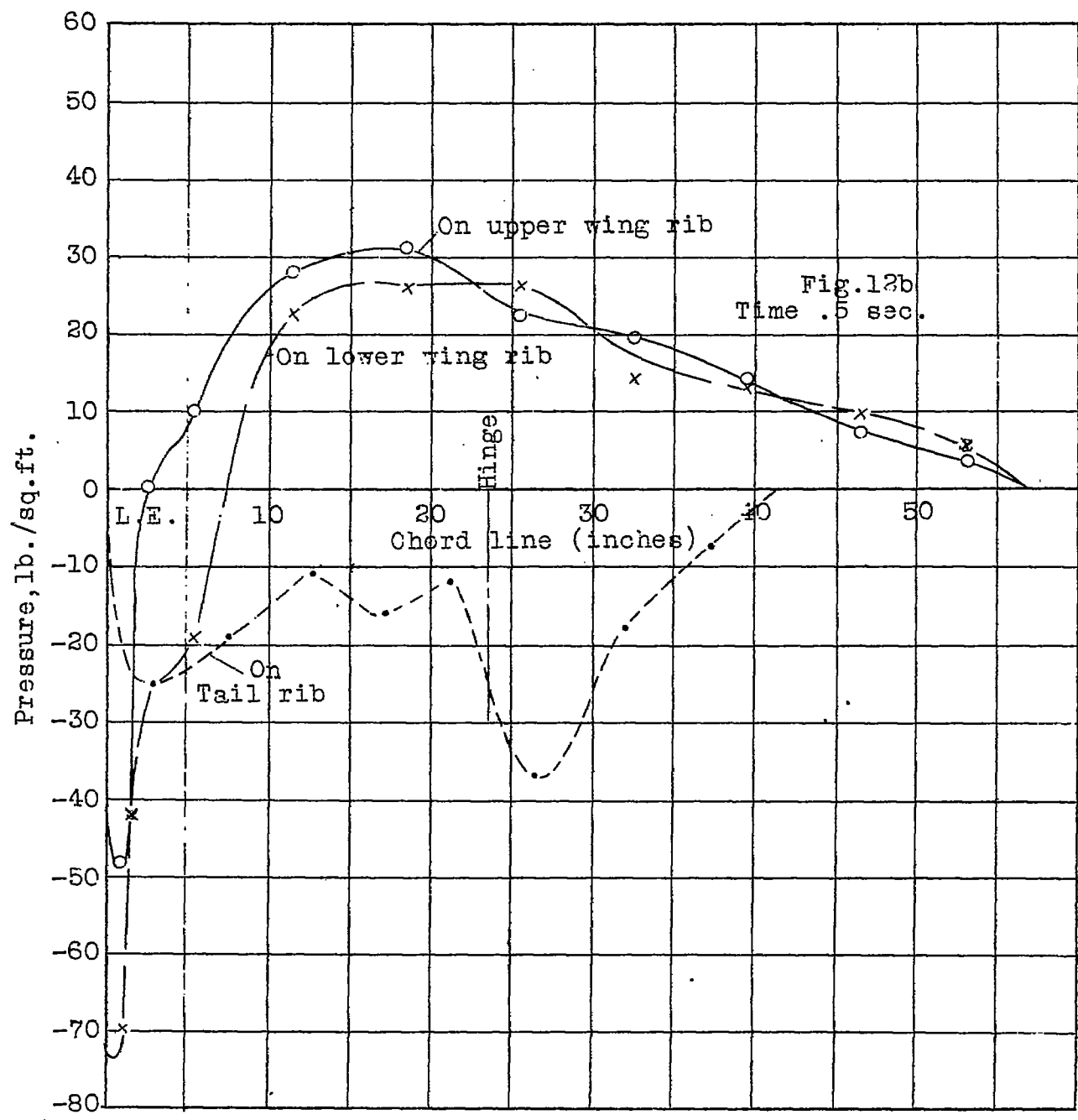

Fig.12b Pressure distribution on TS airplane in a pull-up with power on at 127 M.P.H.

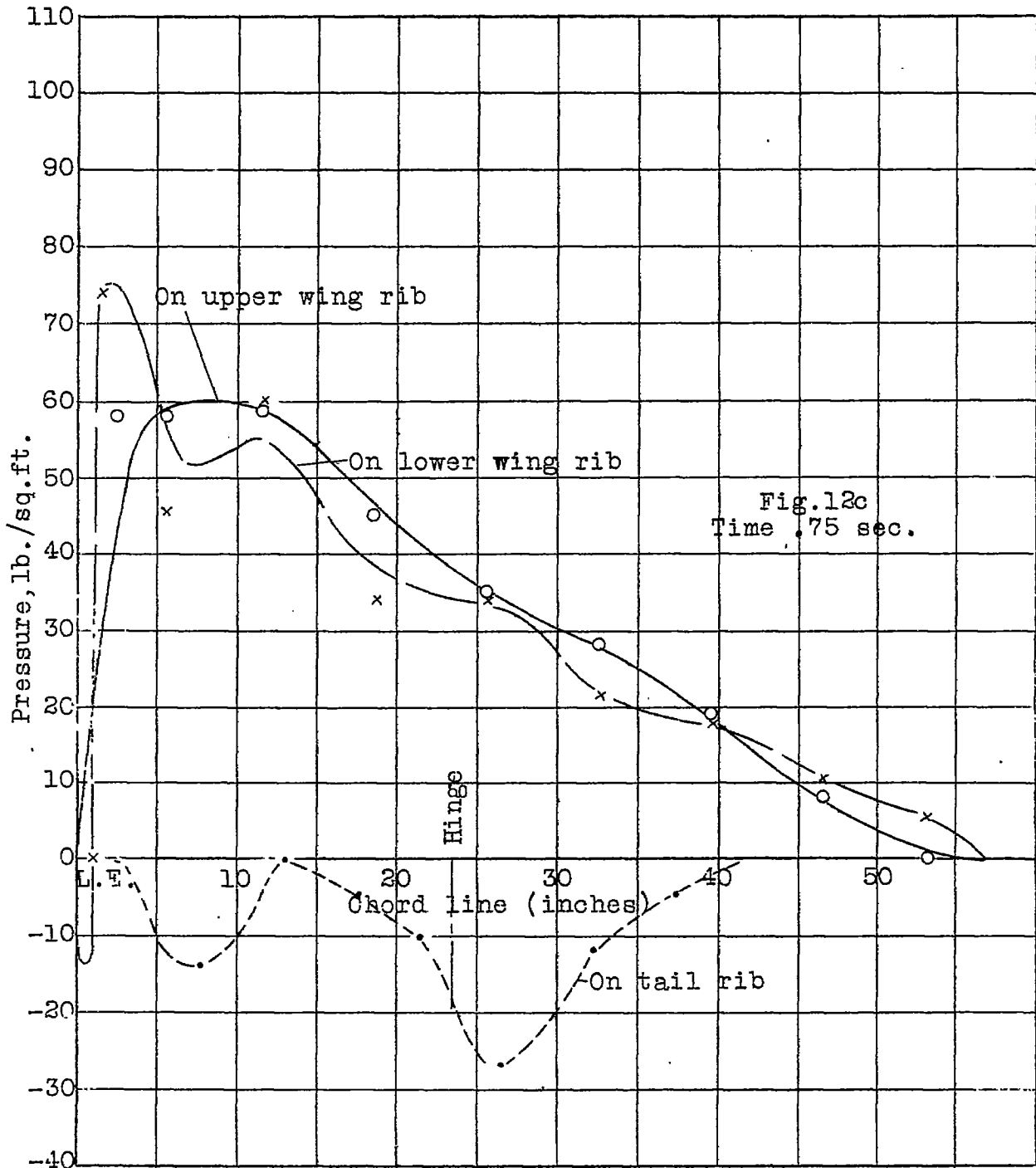

Fig.12c Pressure distribution on TS airplane in a pull-up with power on at 127 M.P.H.

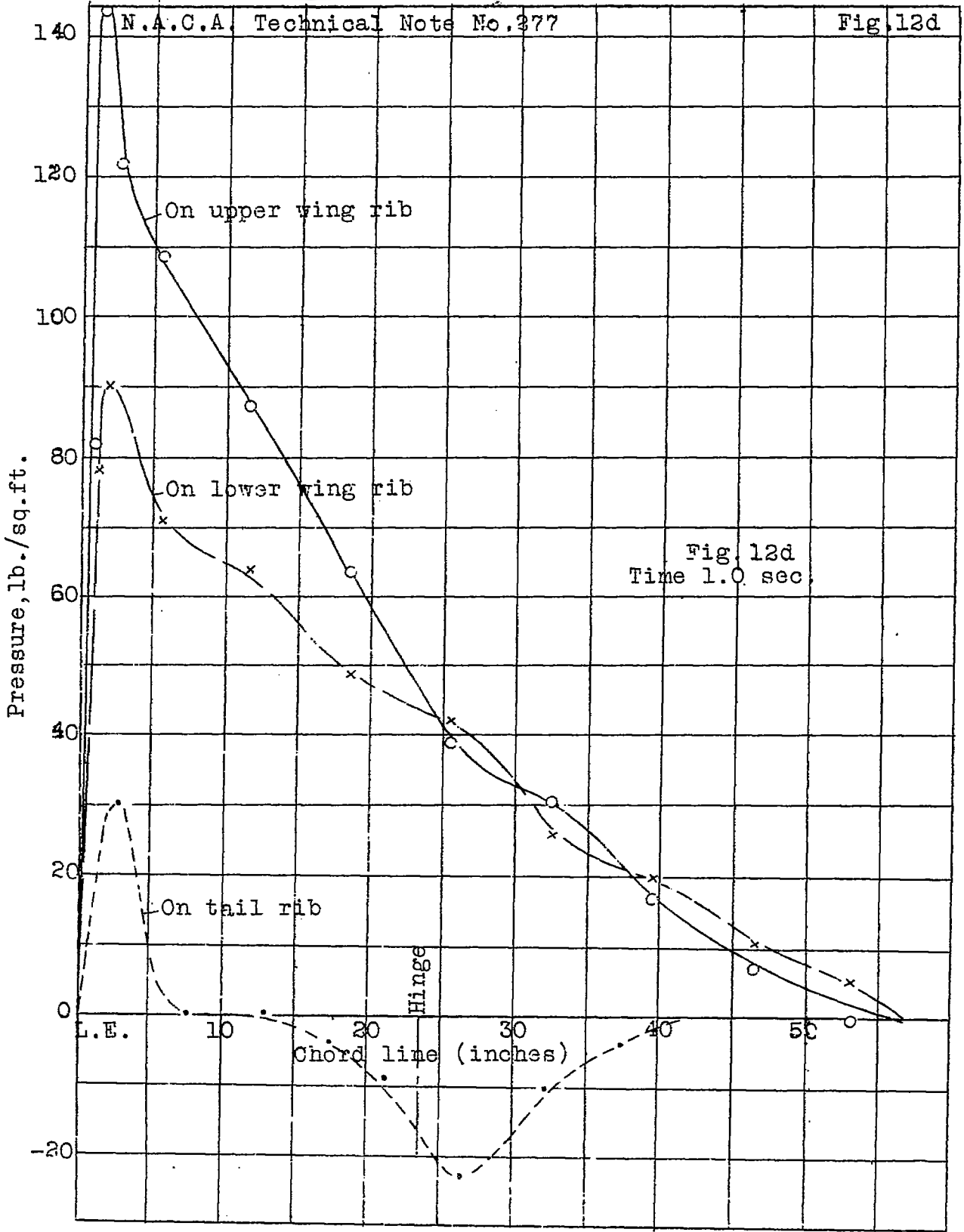

Fig. 12d Pressure distribution on TS airplane in a pull-up with power on at 127 M.P.H.

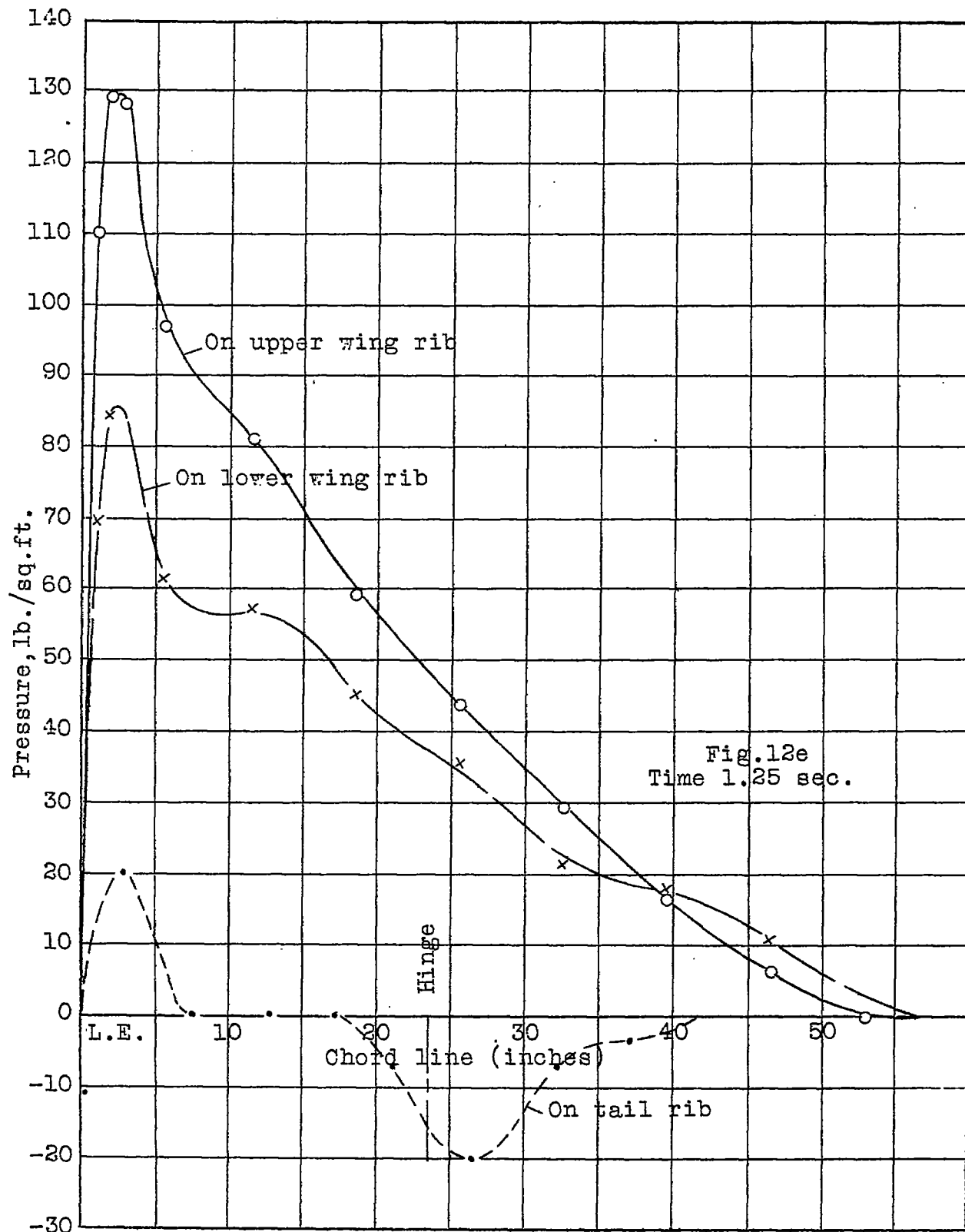

Fig. 12e Pressure distribution on TS airplane in a pull-up with power on at 127 M.P.H.

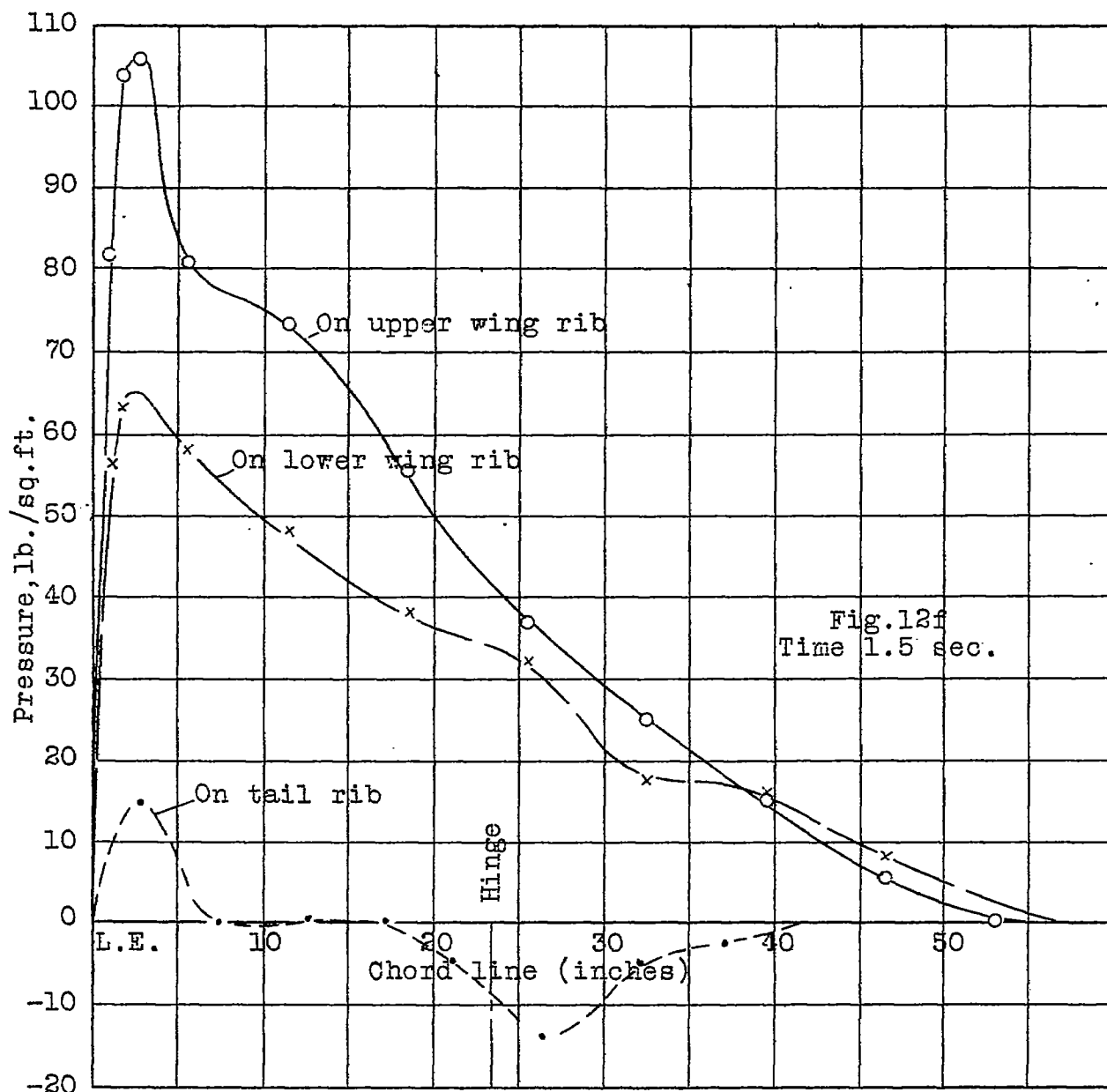

Fig.12f Pressure distribution on TS airplane in a pull-up with power on at 127 M.P.H.

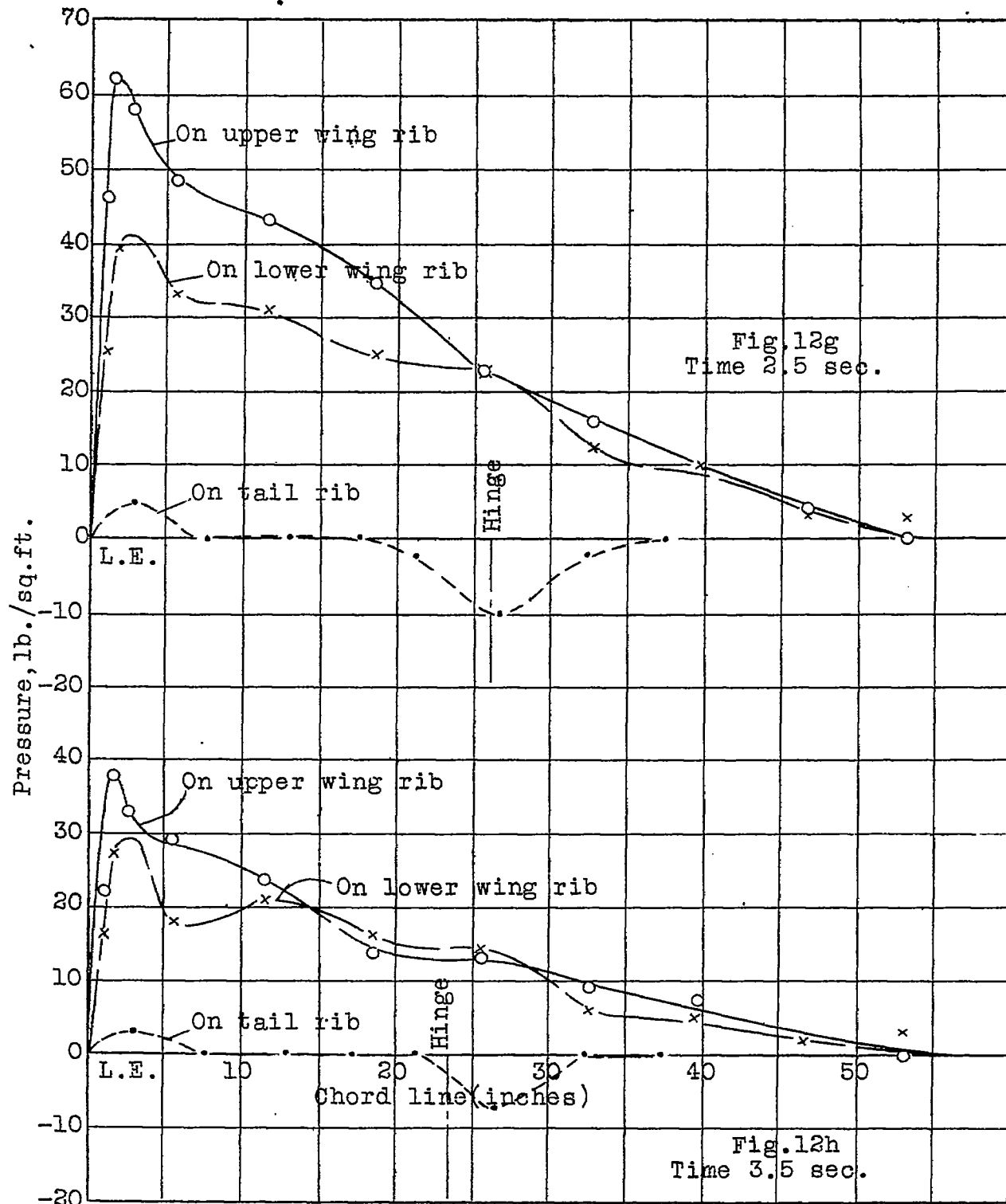

Fig. 12g, h Pressure distribution on TS airplane in a pull-up with power on at 127 M.P.H.

- a Moment about L,E.of tail plane
- b Air speed
- c  $C_{NF}$  Upper wing
- d  $C_{NF}$  Lower wing
- f Elevator angle
- g Load on upper wing rib
- h Load on lower wing rib
- i Normal acceleration

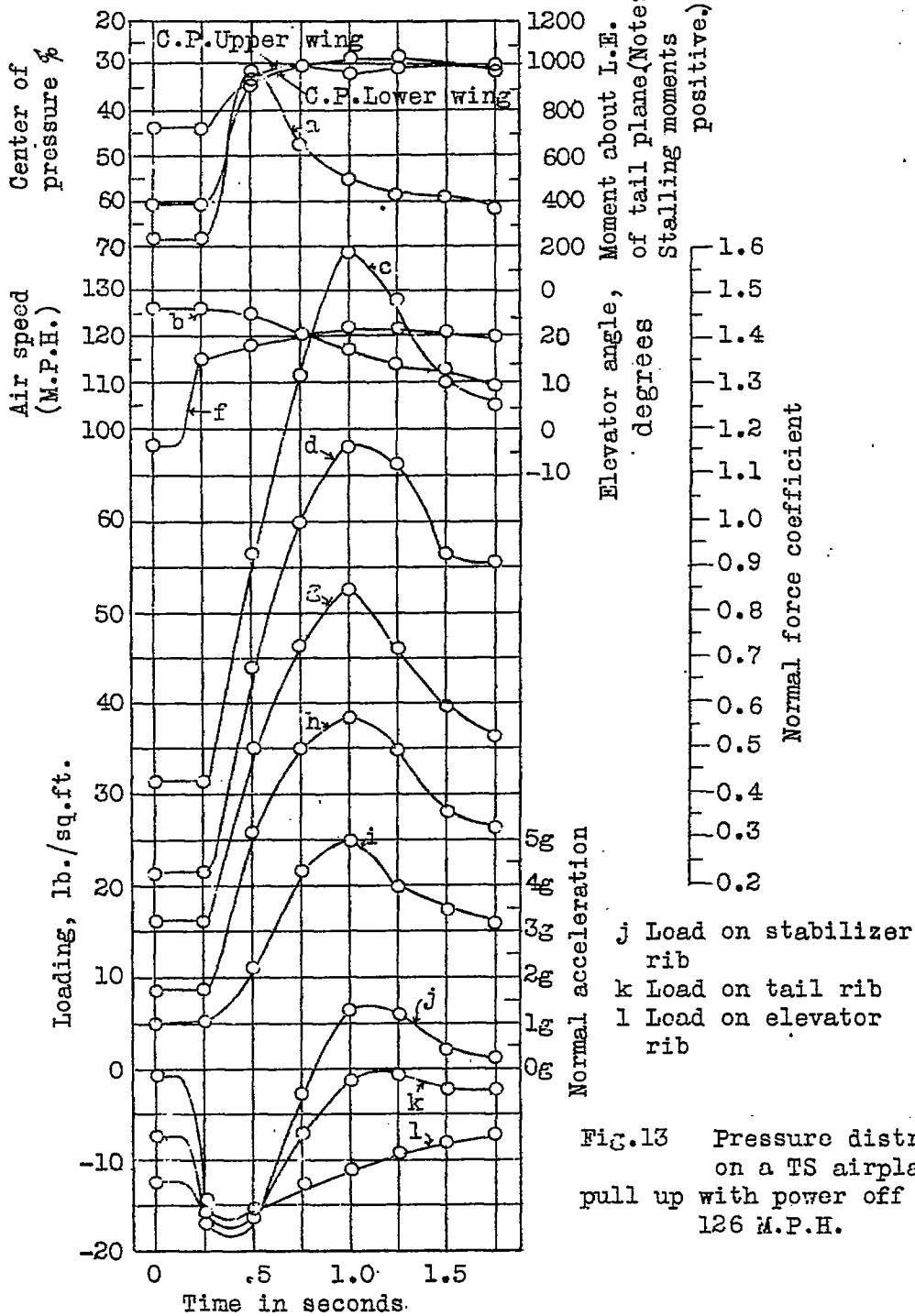

Fig.13 Pressure distribution on a TS airplane in a pull up with power off at 126 M.P.H.

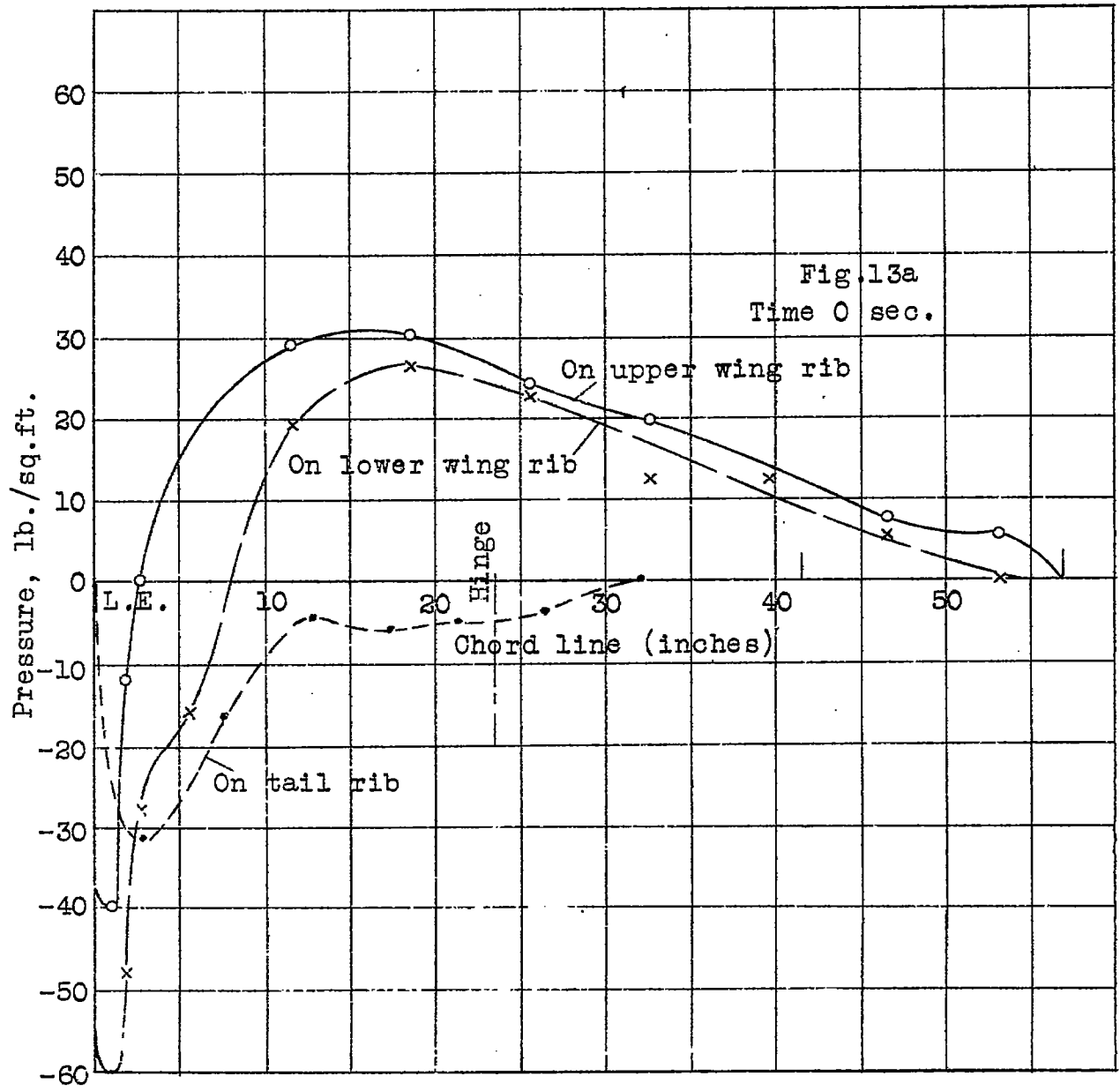

Fig.13a Pressure distribution on TS airplane in a pull-up with power off at 126 M.P.H.



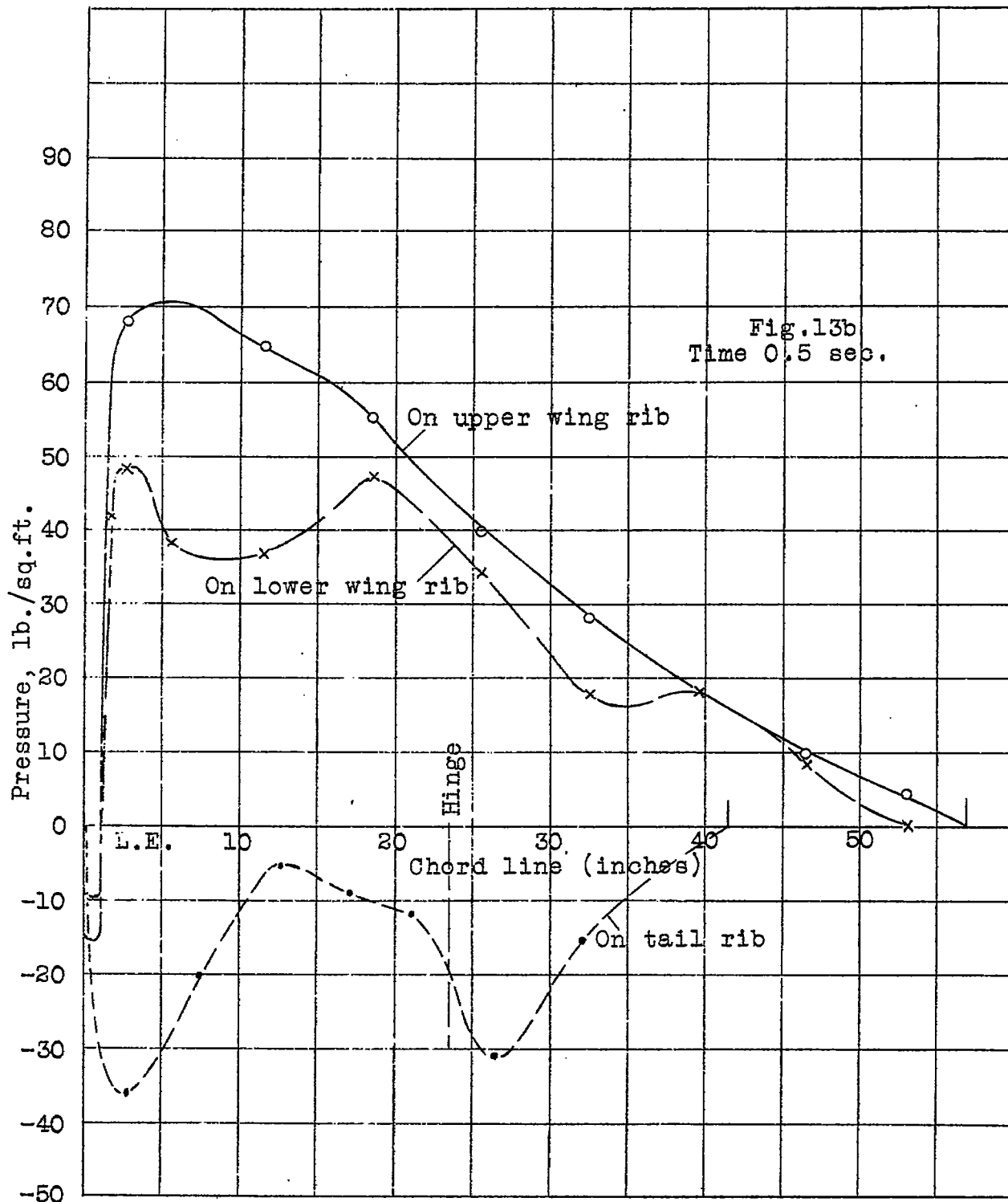
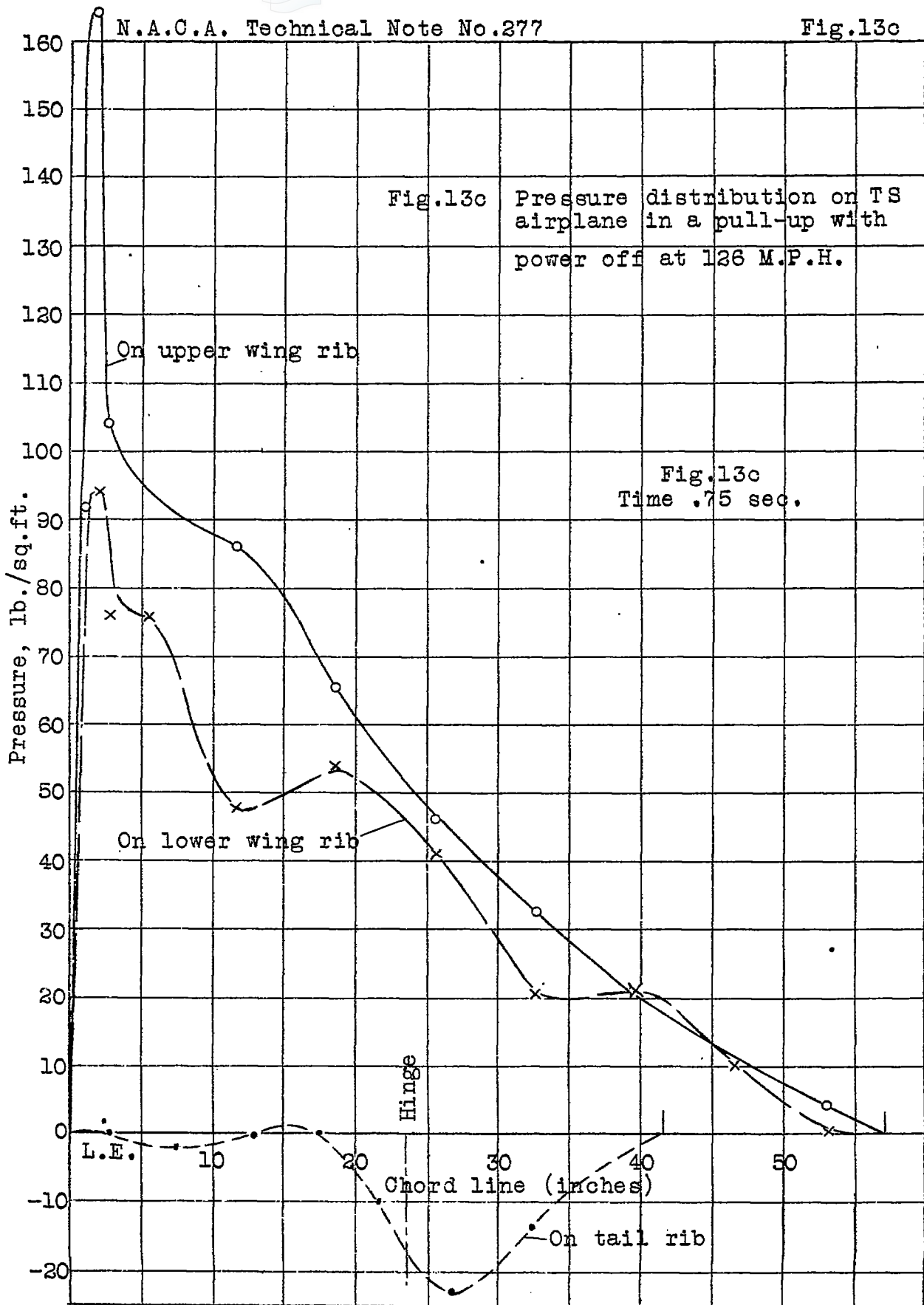
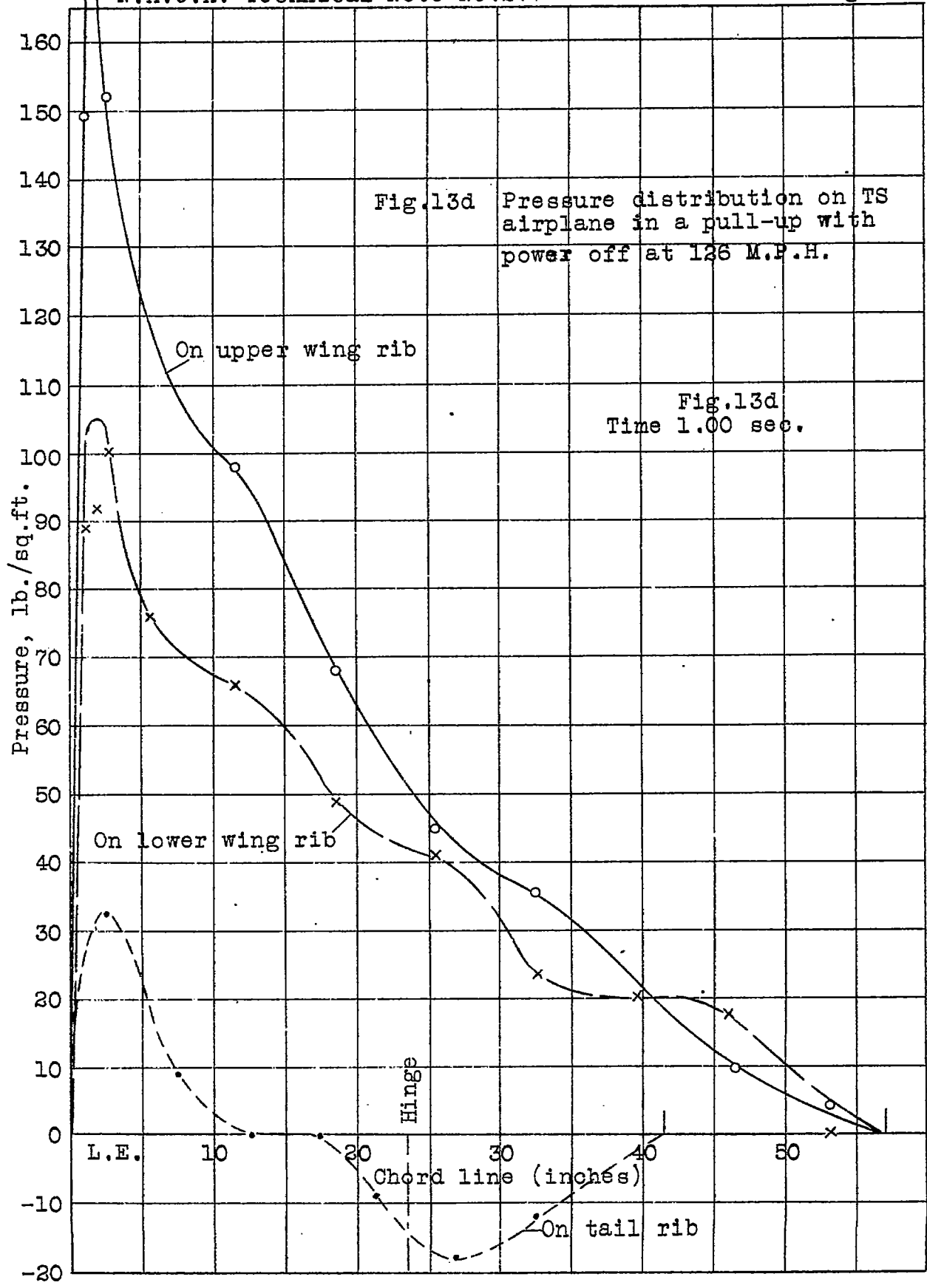

Fig.13b Pressure distribution on TS airplane in a pull-up with power off at 126 M.P.H.





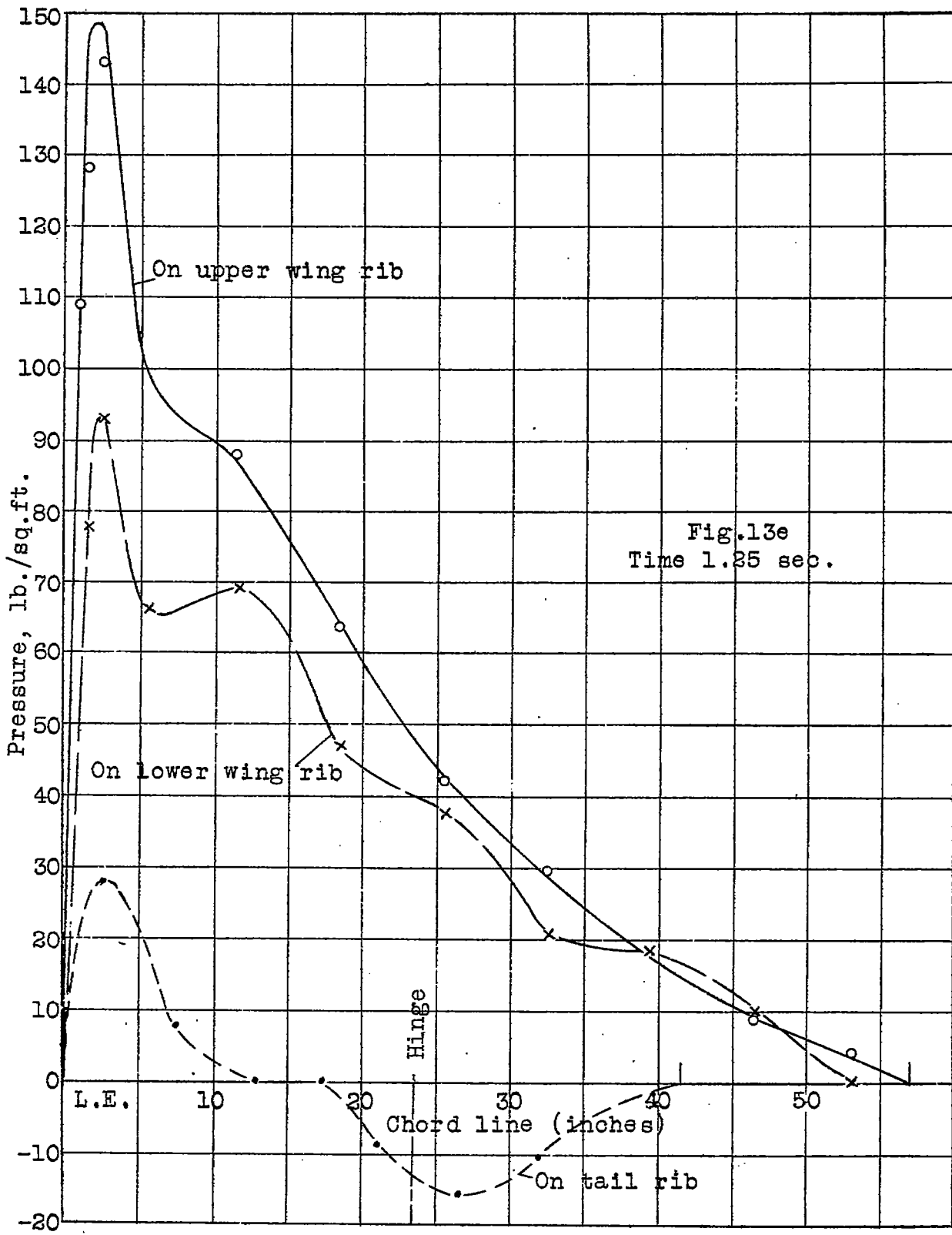

Fig.13e Pressure distribution on TS airplane in a pull-up with power off at 126 M.P.H.

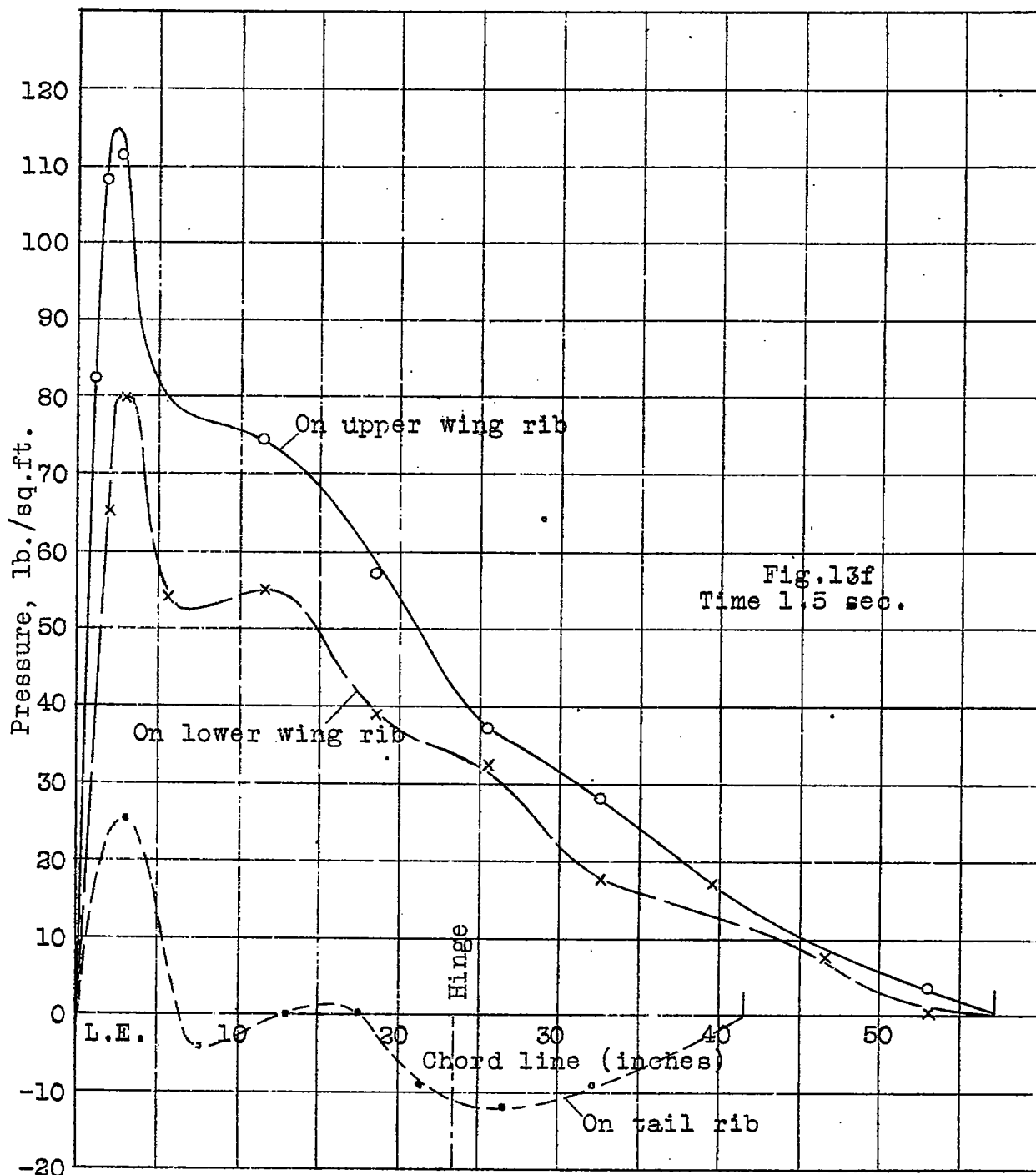

Fig.13f Pressure distribution on TS airplane in a pull-up with power off at 126 M.P.H.

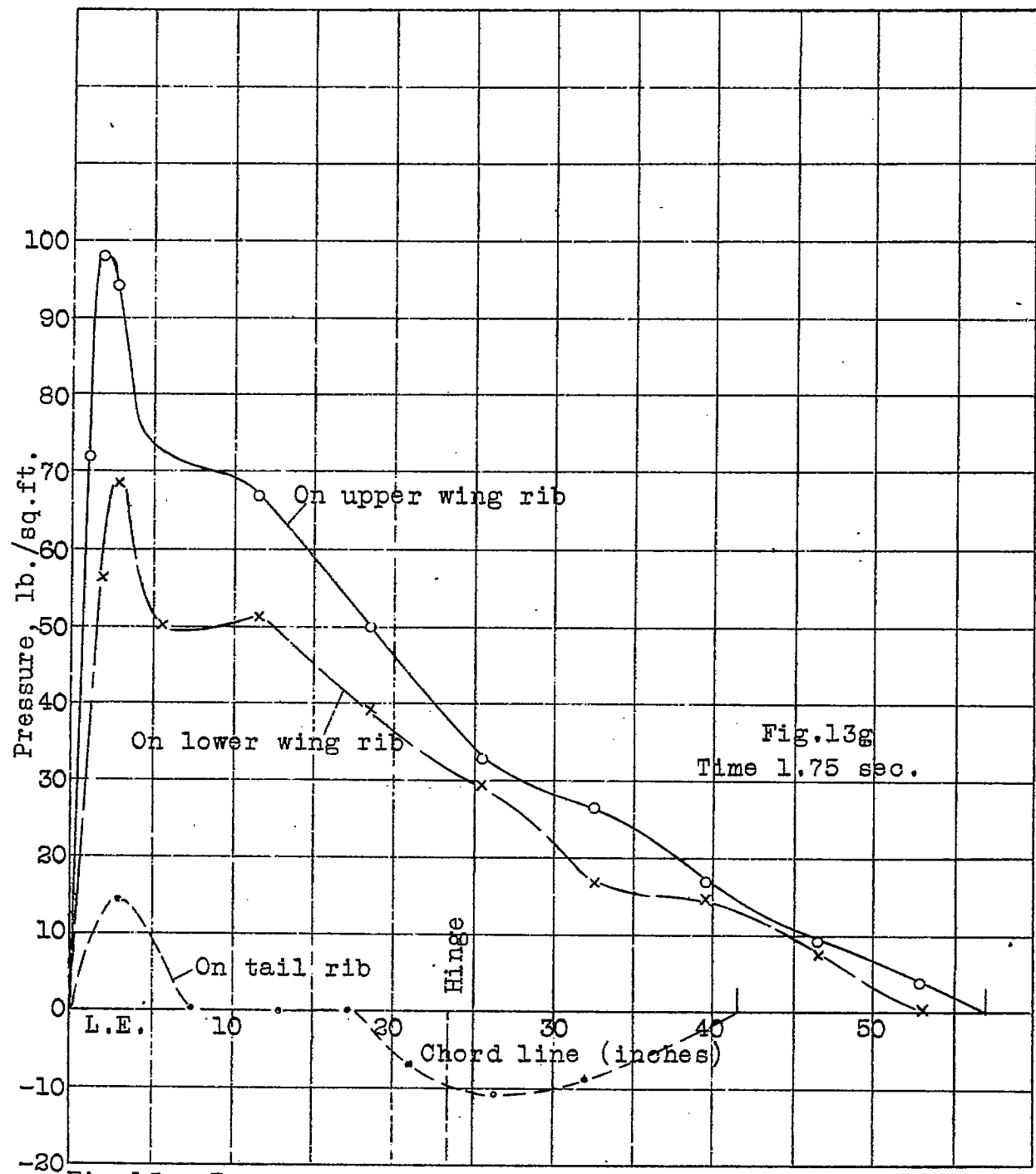

Fig.13g  
Time 1.75 sec.

Fig.13g Pressure distribution on TS airplane in a pull-up with power off at 126 M.P.H.