



OCT 2 1952

*Handwritten signature*

NACA TN 2791

# NATIONAL ADVISORY COMMITTEE FOR AERONAUTICS

TECHNICAL NOTE 2791

CORRELATION OF TENSILE STRENGTH, TENSILE DUCTILITY, AND  
NOTCH TENSILE STRENGTH WITH THE STRENGTH OF ROTATING  
DISKS OF SEVERAL DESIGNS IN THE RANGE OF LOW AND  
INTERMEDIATE DUCTILITY

By Arthur G. Holms and Andrew J. Repko

Lewis Flight Propulsion Laboratory  
Cleveland, Ohio



Washington  
September 1952

NATIONAL ADVISORY COMMITTEE FOR AERONAUTICS

TECHNICAL NOTE 2791

CORRELATION OF TENSILE STRENGTH, TENSILE DUCTILITY, AND NOTCH TENSILE  
STRENGTH WITH THE STRENGTH OF ROTATING DISKS OF SEVERAL DESIGNS  
IN THE RANGE OF LOW AND INTERMEDIATE DUCTILITY

By Arthur G. Holms and Andrew J. Repko

SUMMARY

Burst tests were conducted on several designs of sound disks and disks with defects. Results were compared with tensile strength, tensile ductility, and notch tensile strength. The purposes of the investigation were to determine the extent to which disk strength can be increased by increasing tensile strength, to investigate the extent to which a correlation exists between disk strength and several mechanical properties of materials at low ductilities, and to present some data on the influence of several types of stress concentration on the strengths of disks made from ductile and brittle materials.

For the brittle materials (that may have been subject to chemical segregations) the disk strength did not correlate with tensile strength. For these low-ductility materials (elongation equal to or less than 4.0 percent) and for ductile materials for which notch strength data were available, the disk strength was found to correlate better with the combination of tensile strength and notch strength ratio than with the combination of tensile strength and elongation. For disks possessing much sharper stress raisers (defects), the notch tensile strength was superior to the conventional tensile strength as a basis for correlating disk strength with mechanical properties of the sound material.

In general, experimentally determined disk strengths for ductile materials were slightly less than values predicted from tensile strength values by the concept of average stress. In the case of brittle materials, the observed values were significantly less than the predicted values. The rule that the strength reduction in disks due to holes is approximately equal to the percentage of diametral cross-sectional area removed by the holes was substantiated for disks of ductile materials having large central holes and moderate size eccentric holes. The rule was not substantiated for disks of ductile materials having small central holes and the rule was not substantiated for disks made from materials of low ductility.

## INTRODUCTION

Reduction of disk weight for aircraft gas-turbine rotors is desirable for many reasons. Reduction in rotor weight has an amplified effect on total engine weight because lower gyroscopic forces associated with lower rotor weight permit weight reductions for bearings, shaft, and frame. Thus, a small saving in disk weight permits a general saving of weight and materials throughout the engine.

Use of high-strength materials presents the possibility of reducing wheel thickness and thus of reducing disk weight while maintaining a given factor of safety. The influence of tensile strength and ductility on the strengths of some rotating disks was investigated in reference 1. For sound materials the disk strength increased with increasing tensile strength, and this relation was observed to be independent of ductility for ductilities in excess of about 3 percent elongation. The factors that limit the extent to which disk strength can be increased by increasing tensile strength with accompanying very low ductilities were not investigated.

In general, high-strength materials are usually obtained at some sacrifice in ductility. Furthermore, investigations employing the static notch tensile test have shown that many steels become notch-sensitive in a range of high tensile strength (reference 2). Minimum levels of ductility are usually specified for rotor materials with the object of permitting stress redistribution by plastic flow in the immediate vicinity of such stress raisers as may be required by functional considerations or as may be caused by material imperfections. (Data on the optimum compromise between tensile strength and ductility for some rotating disks having defects are presented in reference 3.) Although the static-notch-tensile test has been shown to measure characteristics of a material not precisely described by the usual tensile strength and ductility measurements (reference 2), the specification of notch strength values for rotor materials is not extensively practiced at present. The significance of the notch test in selecting materials for various applications has not been widely explored.

The present investigation was conducted to examine some of the factors that limit the extent to which disk strength can be increased by increasing tensile strength, to determine the extent to which a correlation exists between disk strength and several mechanical properties of materials at low ductilities, and to evaluate the influence on disk strength of several types of stress concentration for ductile and brittle materials. Results from reference 1 are compared with data from the present investigation (made at the NACA Lewis laboratory), which includes:

- (1) Data from tests of brittle materials.
- (2) Correlations with notch data for disks free from voids and for disks containing voids.

## PROCEDURE

The disk designs investigated are shown by the diagrams of figure 1. All the disks were 10 inches in diameter. Some of the disks were originally  $3/8$  inch thick but had soft surface layers removed by grinding 0.020 inch from the top and bottom faces. The cast disks of beryllium copper containing shrink porosity varied in thickness from 0.497 to 0.570 inch. All other disks were  $3/8$  inch thick.

2337  
Disks were examined for defects by radiographic inspection and by either the magnetic or the fluorescent-particle inspection methods. Disks found to be free of cracks or voids by these inspections were regarded as sound for the purposes of the present investigation, although the existence of small defects or irregularities not so detectable is quite possible. The disks made from an age-hardenable stainless steel were regarded as sound since they did not contain cracks or voids. However, they did contain chemical segregations, which were detected by magnetic inspection and are described in reference 3. The cast disks of beryllium copper contained voids consisting of shrink porosity, also described in reference 3.

The conventional and notched tensile specimens are shown by the diagrams of figure 2. The notched specimens possessed sharp  $60^\circ$  V-notches that removed 50 percent of the cross-sectional area. A concentric tensile fixture of the type described in reference 4 was used for all notched specimens and for all tensile specimens having ductilities equal to or less than 4.0 percent elongation. All specimens were taken from disks produced in the same manner as the burst disks. The heat-treating schedule and the order of the heat-treating and machining steps were always the same for the disks and the corresponding specimens. The method of spin testing was the same as that described in reference 1.

## TENSILE PROPERTIES OF MATERIALS INVESTIGATED

The conventional tensile properties and the notch strength values corresponding to disks free from defects and also for the disks of age-hardenable stainless steel are listed in table I. These properties are based on specimens cut in radial directions from material located near the centers of disks.

Data for the disks containing shrink porosity are listed in table II. As described in reference 3, these disks contained both sound and unsound regions. Both the conventional tensile specimens and the notched specimens were taken from the sound regions.

**CORRELATION OF DISK STRENGTH WITH TENSILE STRENGTH**

If a general correlation of tensile properties with rotating disk performance is to be investigated for a wide variety of materials, the data must be analyzed in such a manner as to be unaffected by the densities. One appropriate parameter for measuring disk performance consists of the simple product of density and burst speed squared. The maximum calculated elastic stress in a solid parallel-sided disk at a speed corresponding to the burst speed is an equivalent parameter for measuring the nominal load sustained by the disk material at the time of bursting. The convenience of using this quantity (referred to as "disk strength") is that the numbers are of comparable magnitudes with the tensile strengths. The formula for calculating disk strength is given in the appendix.

Because the disk strength is a measure of the nominal load sustained by the disk material up to the point of bursting, it is a useful parameter for measuring the significance of the tensile properties when the materials investigated vary in density. (The unsuitability of using actual stresses for this purpose is discussed in reference 1). The disk strength cannot be used as an index of merit of a particular material for rotating disk applications because it is proportional to the density. The burst speed or the burst speed squared would be a more satisfactory index of merit.

For all the designs of figure 1, the disk strength was always calculated by the formula for the maximum elastic stress in a solid parallel-sided disk. The disk strength so calculated for the burst speeds of disks with holes reflects the loss in burst speed squared due to the presence of the holes when compared with similar calculations for solid disks.

Data for sound disks from reference 1 for the disk designs of figure 1(a) to 1(c) (all having tensile ductilities in excess of 3 percent elongation) and data from the present low-ductility investigation for the same disk designs, together with both high- and low-ductility data for the disk design of figure 1(d), are plotted in figure 3. The tensile properties shown in figure 3 and subsequent plots are based on averages of approximately four tensile or notch specimens for any particular heat treatment and chemical composition. For all the designs investigated, these plots of disk strength against tensile strength show that the disk strengths increased with increasing tensile strength for ductilities above 4.0 percent elongation. For ductilities of 4.0 percent elongation or less, the data points fall below the lines established by the ductile materials and no correlation is observed between disk strength and tensile strength. (These disks are said to be "brittle" in this low range of elongation.)

The brittle materials did not necessarily produce disks inferior in strength to the ductile materials. As can be seen from figure 3, some of the materials with ductilities of less than 4.0 percent elongation gave higher disk strengths than any of the ductile materials.

2337

CORRELATION OF DISK STRENGTH WITH COMBINATION OF TENSILE  
 STRENGTH AND TENSILE DUCTILITY

Ratios of disk strength to tensile strength are plotted against ductility in figure 4. In this plot and in subsequent plots, individual points generally represent an average of two disk tests for particular heat treatments and chemical compositions. As would be expected from figure 3, the correlation with tensile strength independently of ductility is seen to be fairly good at ductilities above 4.0 percent elongation, but is quite poor at elongations equal to or less than 4.0 percent.

CORRELATION OF DISK STRENGTH WITH THE COMBINATION OF TENSILE STRENGTH AND  
 TENSILE DUCTILITY COMPARED TO THE CORRELATION OF DISK STRENGTH WITH  
 THE COMBINATION OF TENSILE STRENGTH AND NOTCH STRENGTH RATIO

The static mechanical properties of a material may be regarded as involving three characteristics which can be designated as strength level, ductility, and stress-concentration resistance. Examples of these three properties occur in static tensile testing and are the tensile strength, conventional elongation, and the ratio of notch strength to tensile strength. The potential value of the notch test as a supplement to, or alternative for, the usual ductility measurements lies in the fact that there is no general law relating conventional ductility and stress concentration resistance and that strength level and stress-concentration resistance are the basic characteristics required in actual structures.

The rotating disk and the notched tensile specimen are structures the stress distributions of which are similar in that they are nonuniform; however, sufficient qualitative dissimilarities exist so that a functional relation need not be expected between disk strength and notch strength. The general tendency of disk strength to increase with tensile strength shown in figure 3 suggests that disk strength might be a function of two variables, one of them being the tensile strength and the other being some variable that would correct for the lack of correlation exhibited by figure 3 in the range of low ductility. This hypothesis can be investigated by plotting the quotient of disk strength and tensile strength against other variables. Possible choices for a second variable include ductility and stress-concentration resistance.

The correlation of disk strength with the combination of tensile strength and ductility was compared to the correlation of disk strength with the combination of tensile strength and stress concentration resistance by plotting disk strength divided by tensile strength (the "disk strength ratio") against conventional elongation and against notch strength

2337

divided by tensile strength (the "notch strength ratio") in figures 5 to 8. The disk data in the plot of disk strength ratio against elongation were so selected as to correspond exactly to the data for which notch test data were available; thus, the two plots of figures 5 to 8 show exactly comparable data.

The data points of figure 5 exhibit a somewhat unsatisfactory correlation of disk strength ratio with conventional elongation and a significantly better correlation with notch strength ratio. Figures 6 to 8 indicate general trends that are in agreement with those established by figure 5.

Because the disks made from brittle materials had non-homogeneous structures in the central region which were probably not adequately represented by the tensile values, an upward shifting of the low-ductility points of figures 5 to 8 could be expected if tensile specimens were available that exactly duplicated the center material of the disks. The 0.06-radius fillet (fig. 1) may also have been an important stress raiser in the range of low ductility. In general, the disk fracture surfaces were usually observed at the point of tangency of the 0.06-radius fillet and the disk surface; however, in some cases, the minimum distance between a fracture surface and the center of the disk was as much as 1 inch, which fact supports the hypothesis that a stress raiser involving non-homogeneous material was present at the point of origin of the failure. A case in point is that of the zero-ductility age-hardenable stainless steel. The average tensile strength determined by four radial specimens of this material was 199,500 pounds per square inch, while the smallest value of a series of eight randomly oriented specimens (reference 3) was 168,800 pounds per square inch. If this value had been used in calculating the ordinate of figure 5, the resulting ratio would have been 0.79 instead of 0.67.

Examination of the data points of figure 5 shows that the materials with notch strength ratios greater than unity all had elongation values greater than 4.0 percent, and that the materials with a notch strength ratios less than unity all had elongation values of 4.0 percent or less. Also, all the materials having disk strength ratios less than the unity value (expected for brittle materials) had notch strength ratios less than unity, while all the materials having disk strength ratios greater than unity had notch strength values greater than unity.

Examination of the data points corresponding to the four SAE 4150 steels of figure 5(b) shows that the highest disk strength ratio and notch strength ratio belonged to steel M with the heavier decarburized layer and that removal of this layer by grinding produced significant losses in disk strength ratio and notch strength ratio (steel N) while maintaining approximately equal tensile strengths (table I). In the case of steel A having a thin decarburized layer, a very small gain in disk strength ratio and notch strength ratio occurred when the thin

2537

2337

decarburized layer was removed by grinding (steel B). The data are regarded as being too meager to be conclusive; however, the data do suggest that there may be an opportunity to decrease the notch sensitivity of high-strength steels (while maintaining the high strength level) by heat-treating for a soft surface layer.

#### SIGNIFICANCE OF NOTCHED STRENGTH IN PRESENCE OF IRREGULARITIES

The data obtained from burst tests of disks of cast beryllium copper containing shrink porosity are plotted in figure 9. The plot of disk strength against tensile strength shows that the values of tensile strength do not give the correct order of merit of the various heat treatments of this material in that successive increases in tensile strength were accompanied by an increase and then a decrease in disk strength. The plot of disk strength against notch strength showed that in the presence of severe stress concentrations caused by defects, the disk strength was a monotonically increasing function of the notch strength.

#### SIGNIFICANCE OF CALCULATED AVERAGE STRESS AS A BASIS FOR PREDICTING DISK STRENGTH

The concept of average stress as a means of predicting the strength of rotating disks was introduced in reference 5. The average stress for a rotating disk is determined by calculating the centrifugal force on one-half of the disk and dividing by the area of a diametral cross section. Some data on the significance of calculated average stresses were presented in reference 1 for the disk designs of figures 1(a) to 1(c) (all having tensile ductilities greater than 3 percent elongation). In the present investigation, similar data were secured at low ductilities (4.0 percent elongation and less) and similar data were secured at both high and low ductility for disks having eccentric holes (fig. 1(d)). Results are shown in figure 4. The unity line of figure 4(a) and the lines corresponding to the ratios of solid-disk elastic stress to elastic stress for the disk with holes of figures 4(b) to 4(d) represent the theory that a disk would fail when the calculated elastic stress was equal to the tensile strength. Ratios of solid-disk elastic stress to average stress for the disk designs of figure 1 are given in the appendix and are listed in table III. Because values of solid-disk elastic stress divided by tensile strength are plotted as ordinates in figure 4, the proximity of the data points to the lines corresponding to the ratios of solid-disk elastic stress to average stress (lines labeled "average-stress theory") is an indication of the validity of the concept of average stress as a basis for predicting disk strength from tensile strength data. In general, the data points for all the disks lie between the lines corresponding to these two theories with the points for the ductile materials lying closer to the average stress theory and the points for the brittle



materials lying closer to the elastic stress theory. An important exception occurred in the case of the brittle solid disks of figure 4(a), where data points were found well below the elastic-stress line. Reasons for the weakness of these disks were discussed in the section on the correlation of disk strength with the combination of tensile strength and tensile ductility compared to the correlation of disk strength with the combination of tensile strength and notch strength ratios.

Strengths of rotating disks can also be predicted from calculations that include the effects of plastic flow (reference 6).

SIGNIFICANCE OF CALCULATED AVERAGE STRESS AS A BASIS FOR PREDICTING  
 INFLUENCE OF CIRCULAR HOLES ON DISK STRENGTH

In addition to the use of the concept of average stress as a basis of predicting disk strengths from tensile strength data, the concept of average stress may also be used as a basis for predicting the relative strengths of disks of various designs.

The strength-reducing effect of large- and small-diameter central holes and the influence of ductility on the relative strengths of solid disks and disks having large- and small-diameter central holes is reported in reference 1. For the ductile materials investigated, the strength reduction caused by the holes was found to be essentially unaffected by the ductility.

Data have now been secured (fig. 10) for the disk designs of reference 1 at low ductilities (4.0 percent elongation and less), and at both high and low ductility for disks having eccentric holes (fig. 1(d)). In figure 10 the square of the burst speed was used as the measure of disk strength, and the strength of a disk with a hole relative to the strength of a solid disk was expressed by the ratio of the squares of the burst speeds. The plotted points show averages of burst speeds squared for disks of given design, materials, and heat treatment divided by the average of burst speeds squared for corresponding solid disks. Ratios of solid disk elastic stress to average stress for the disk designs of figure 1 are listed in table III. Dividing each of the ratios by the ratio for the solid disks gives the estimated relative strengths of the disks with holes to that of the solid disk on the assumption that disk strengths can be compared by calculating average stresses. The dashed lines of figure 10 labeled "average-stress theory" were drawn at ordinate values corresponding to the values in table III in the column labeled "Estimated strength relative to solid disk". In general, the data points are seen to lie close to these lines for ductilities greater than 4.0 percent elongation; these data thus support the theory that relative strengths may be compared by calculating average stresses. For the ductile materials

of figure 10, some scatter was observed extending downward to strength levels about 10 percent less than the average stress line for the large central holes and to about 15 percent less for the small central holes. In general, the ratios are slightly lower for the brittle materials (4.0 percent elongation or less) and this was especially true for the disks with the large central holes.

2337  
The values in table III expressing the estimated loss in strength with respect to the solid disk were obtained by subtracting the relative strength ratios from unity and expressing the result as a percent. Another method of estimating the relative strengths of rotating disks containing holes is to consider only the changes in cross-sectional area. The reduction in centrifugal force corresponding to material removed by the holes is ignored. On this basis, the estimated loss in strength of the several designs, as compared with the solid disk, is given by the values of loss in diametral cross-sectional area (table III).

Comparison of the loss in strength due to holes with the loss predicted by calculating average stresses, in addition to being exhibited by figure 10, is summarized in table III. The data of table III show that the relative strength predictions based on average stress calculations were substantiated in the case of ductile materials with eccentric holes and in the case of ductile materials with large central holes. The data of table III indicate that the average stress predictions should not be extended to designs involving very small holes or to brittle materials.

#### SUMMARY OF RESULTS

The following results were obtained in a correlation of tensile strength, tensile ductility, and notch tensile strength with the strength of rotating disks of several designs in the range of low and intermediate ductility:

1. Previous results have shown the strengths of rotating disks to increase with tensile strength independently of ductility down to tensile ductilities of about 3 percent elongation. For the types of material available for the present tests (that may have been subject to chemical segregations), the strengths of rotating disks in a range of ductility equal to or less than 4.0 percent elongation did not correlate with tensile strength.

2. For the low-ductility materials and for the ductile materials for which notch strength data were available, the disk strength of solid disks was found to correlate better with the combination of tensile strength and stress concentration resistance (notch strength ratio) than with the combination of tensile strength and ductility (conventional elongation).

3. Where disks possessed much sharper stress raisers (defects), the notch tensile strength was superior to the conventional tensile strength as a basis for correlating disk strength with mechanical properties.

4. Experimentally observed disk strengths for ductile materials were slightly less than values predicted from measured tensile strengths by the concept of average stress. In the case of brittle materials, the observed disk strengths were very much less than the values predicted by calculating average stresses. The rule (based on the concept of average stress) that the strength reduction in disks caused by holes is approximately equal to the percentage of diametral cross-sectional area removed by the holes was substantiated for disks of ductile materials having large central holes and moderate-size eccentric holes. The rule was not substantiated for disks of ductile materials having small central holes and, in general, the rule was not substantiated for disks made from brittle materials.

Lewis Flight Propulsion Laboratory  
National Advisory Committee for Aeronautics  
Cleveland, Ohio May 14, 1952

APPENDIX - CALCULATION OF AVERAGE AND ELASTIC STRESSES

Symbols

The following symbols are used in this report:

- A      area of diametral section, sq in.
- b      radius of disk, in.
- c      radius of eccentric hole, in.
- d      radius from center of disk to center of eccentric hole, in.
- F      centrifugal force on one-half of disk, lb
- $r_p$     0.424 b
- $r_c$     0.424 c
- $\nu$       Poisson's ratio, 0.3
- $\rho$       mass density of disk material, (lb)(sec<sup>2</sup>)/in.<sup>4</sup>
- $\sigma$     maximum elastic stress in a solid parallel-sided disk
- $\omega$       angular velocity, radian/sec

Solid-Disk Elastic Stress

The maximum elastic stress is at the center of the solid parallel-sided disk and is (reference 7)

$$\sigma = \frac{3+\nu}{8} \rho \omega^2 b^2$$

As in reference 1, the disk strength was calculated for all materials on the assumption that  $\nu = 0.3$ .

Ratio of Solid-Disk Elastic Stress to Average Stresses

As calculated in the appendix to reference 1, the ratios of solid disk elastic stress to average stresses for the several disk designs were as follows:

2337

Disk of figure 1(a) . . . . .	1.238
Disk of figure 1(b) . . . . .	1.231
Disk of figure 1(c) . . . . .	1.056

The average stress on a diametral section disk of figure 1(d) was calculated as follows:

The center of gravity of a semicircle is located a distance from the center of the circle given by

$$r_b = 0.424 b$$

$$r_c = 0.424 c$$

and the centrifugal force per unit thickness on one-half of the disk was calculated from

$$F = \frac{\pi b^2}{2} \rho r_b \omega^2 - 2 \frac{\pi c^2}{2} \rho r_c \omega^2 - \pi c^2 \rho d \omega^2$$

$$\frac{F}{A} = \frac{\frac{\pi}{2} \rho \omega^2 (0.424 b^3 - 0.848 c^3 - 2c^2 d)}{2(b - 2c)}$$

$$= \frac{\pi \rho \omega^2 (0.424 b^3 - 0.848 c^3 - 2c^2 d)}{4(b - 2c)}$$

The ratio of solid disk elastic stress to the average stress for the disk of figure 1(d) is:

$$\frac{\sigma}{F/A} = \frac{\left(\frac{3+\nu}{8} \rho \omega^2 b^2\right)(4b - 8c)}{\pi \rho \omega^2 (0.424 b^3 - 0.848 c^3 - 2c^2 d)}$$

$$= \frac{3+\nu}{2\pi} \frac{b^2(b-2c)}{0.424 b^3 - 0.848 c^3 - 2c^2 d}$$

$$= \frac{3+0.3}{2\pi} \frac{5.00^2(5.00-0.375)}{0.424 \times 5.00^3 - 0.848 \left(\frac{0.375}{2}\right)^3 - 2 \left(\frac{0.375}{2}\right)^2 \cdot 2.50}$$

$$= 1.150$$

2337

REFERENCES

1. Holms, Arthur G., and Jenkins, Joseph E.: Effect of Strength and Ductility on Burst Characteristics of Rotating Disks. NACA TN 1667, 1948.
2. Sachs, G., Sangdahl, G. S., and Brown, W. F., Jr.: New Notes on High Strength Heat Treated Steels. Pts. I and II, vol. 166, nos. 21 and 22. Iron Age, Nov. 23 and 30, 1950, pp. 59-63 and pp. 76-80.
3. Holms, Arthur G., Jenkins, Joseph, E., and Repko, Andrew J.: Influence of Tensile Strength and Ductility on Strengths of Rotating Disks in Presence of Material and Fabrication Defects of Several Types. NACA TN 2397, 1951.
4. Sachs, G., Lubahn, J. D., and Ebert, L. J.: Notch Bar Tensile Test Characteristics of Heat Treated Low Alloy Steels. Am. Soc. Metals, vol. 33, 1944, pp. 340-391.
5. Robinson, Ernest L.: Bursting Tests of Steam-Turbine Disk Wheels. A.S.M.E. Trans., vol. 66, no. 5, July 1944, pp. 373-380; discussion pp. 380-386.
6. Manson, S. S.: Analysis of Rotating Disks of Arbitrary Contour and Radial Temperature Distribution in the Region of Plastic Deformation. Paper presented at the First U. S. National Congress of Applied Mechanics (Chicago), June 11-16, 1951.
7. Timoshenko, S.: Theory of Elasticity. McGraw-Hill Book Co., Inc., 1934, p. 68.

2337

TABLE I - DISK MATERIALS FREE FROM VOIDS, DESIGNS INVESTIGATED, AND MATERIAL PROPERTIES

Material	Disk design <sup>a</sup>	Tensile properties		
		Tensile strength <sup>b</sup> (lb/sq in.)	Notch strength <sup>c</sup> (lb/sq in.)	Conventional elongation <sup>d</sup> (percent)
Steel A, SAE 4150 <sup>e</sup>	figs. 1(a), 1(b), 1(c)	268,600	199,400	3.8
Steel B, SAE 4150 <sup>f</sup>	fig. 1(a)	258,200	197,700	4.0
Steel M, SAE 4150 <sup>g</sup>	fig. 1(a)	243,700	211,500	2.2
Steel N, SAE 4150 <sup>h</sup>	fig. 1(a)	243,500	179,500	2.0
Tool steel <sup>i</sup>	figs. 1(a), 1(b), 1(c), 1(d)	219,300	126,200	0.2
Die steel <sup>j</sup>	figs. 1(a), 1(b)	279,500	162,700	2.0
Nickel base alloy (Inconel X)	figs. 1(a) <sup>l</sup> , 1(b) <sup>l</sup> , 1(c) <sup>l</sup> , 1(d)	162,700 <sup>l</sup>	188,600	21.6 <sup>l</sup>
Age-hardenable 18-8 stainless steel <sup>k</sup>	fig. 1(a) <sup>m</sup>	123,600 <sup>m</sup>	198,600	14.9 <sup>m</sup>
	fig. 1(a) <sup>m</sup>	163,900 <sup>m</sup>	232,800	17.6 <sup>m</sup>
	fig. 1(a) <sup>m</sup>	199,500	104,200	0.0

<sup>a</sup>Types of disks:

Fig. 1(a), solid disk.

Fig. 1(b), disk with 1/16-inch-diameter central hole.

Fig. 1(c), disk with 1/2-inch-diameter central hole.

Fig. 1(d), disk with four 3/8-inch-diameter eccentric holes.

<sup>b</sup>Tensile specimen (fig. 2(a)).

<sup>c</sup>Notch specimen (fig. 2(b)).

<sup>d</sup>1-inch gage length, 1/4-inch-diameter specimen.

<sup>e</sup>Thin decarburized surface.

<sup>f</sup>Thin decarburized surface removed by grinding.

<sup>g</sup>Moderate decarburized surface.

<sup>h</sup>Moderate decarburized surface removed by grinding.

<sup>i</sup>Mill analysis

<sup>j</sup>Nominal composition

<sup>k</sup>Mill analysis

	C	Mn	Si	Ni	Cr	Mo	Ti	W	V	Al
<sup>i</sup> Mill analysis	0.46	0.48	0.34	0.12	3.97	8.09	----	0.40	1.89	----
<sup>j</sup> Nominal composition	.95	1.20	.30	----	.50	----	----	.50	.20	----
<sup>k</sup> Mill analysis	.05	.60	.78	7.01	17.20	----	0.79	----	----	0.08

<sup>l</sup>Data from reference 1.

<sup>m</sup>Data from reference 3.



2337

TABLE II - DISK MATERIAL CONTAINING VOIDS, DESIGN INVESTIGATED, AND  
 MATERIAL PROPERTIES OF CORRESPONDING DEFECT-FREE MATERIAL

Material	Disk design <sup>a</sup>	Tensile properties		
		Tensile strength <sup>b</sup> (lb/sq in.)	Notch strength <sup>c</sup> (lb/sq in.)	Conventional elongation <sup>d</sup> (percent)
Cast beryllium copper containing shrink porosity	$\frac{1}{2}$ -in.-diam. central hole (fig. 1(c))	67,600 <sup>a</sup>	81,700	37.5 <sup>a</sup>
	$\frac{1}{2}$ -in.-diam. central hole (fig. 1(c))	81,200 <sup>a</sup>	105,500	24.4 <sup>a</sup>
	$\frac{1}{2}$ -in.-diam. central hole (fig. 1(c))	148,300 <sup>a</sup>	168,000	6.8 <sup>a</sup>
	$\frac{1}{2}$ -in.-diam. central hole (fig. 1(c))	154,500 <sup>a</sup>	142,600	2.4 <sup>a</sup>

<sup>a</sup>Data from reference 3.

<sup>b</sup>Tensile specimen (fig. 2(a)).

<sup>c</sup>Notch specimen (fig. 2(c)).

<sup>d</sup>1-inch gage length, 1/4-in.-diam. specimen.





TABLE III - STRENGTH REDUCTIONS DUE TO PRESENCE OF CIRCULAR HOLES

Disk design	Ratio of solid disk elastic stress to average stress	Estimated strength relative to solid disk	Estimated loss in strength compared with solid disk (percent)	Loss in diametral cross-sectional area due to hole (percent)	Observed average loss	
					Ductile materials (> 4.0 percent elongation) (percent)	Brittle materials ( $\leq$ 4.0 percent elongation) (percent)
Solid disk (fig. 1(a))	1.238					
1/16-inch-diameter central hole, (fig. 1(b))	1.231	0.9943	0.57	0.63	7.0	11.0
Four 3/8-inch-diameter eccentric holes, (fig. 1(d))	1.150	.9289	7.11	7.50	5.0	11.0
1/2-inch-diameter central hole, (fig. 1(c))	1.056	.8530	14.70	15.00	19.0	39.0



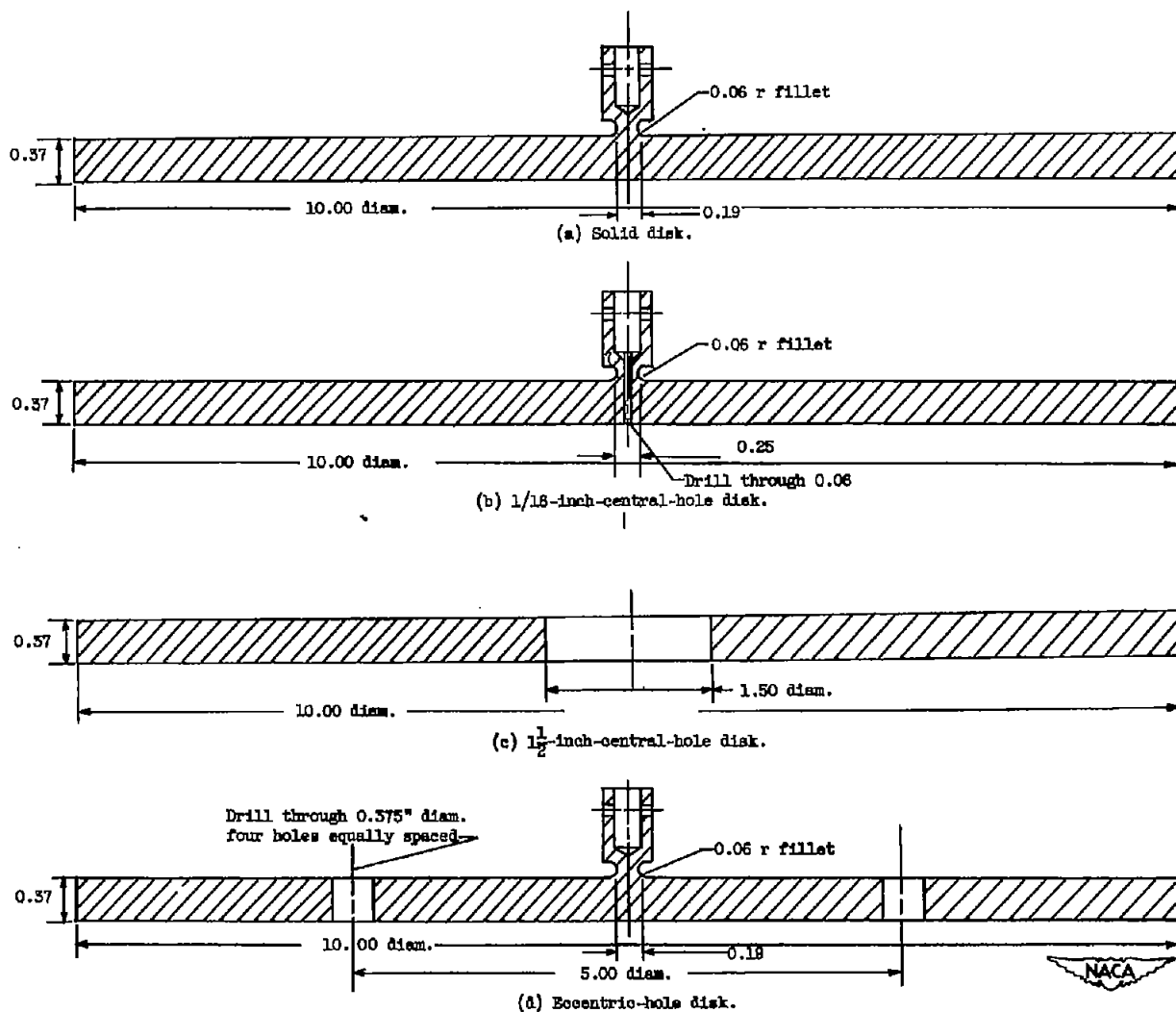
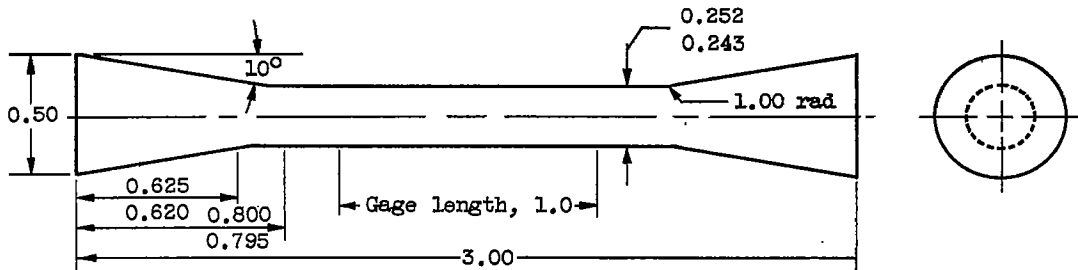
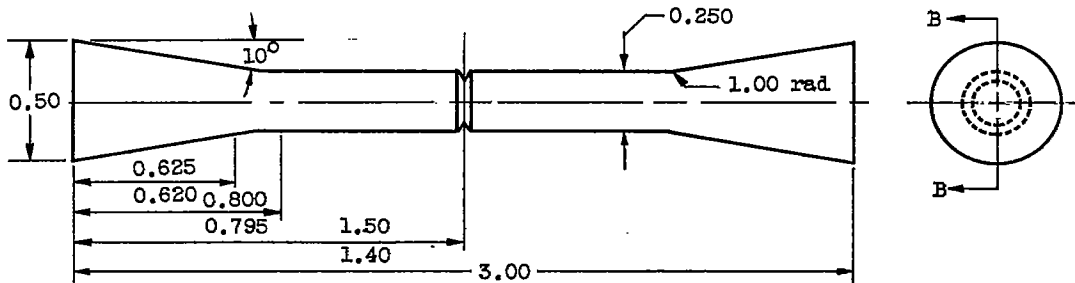

Figure 1. - Disk designs. (All dimensions are in inches.)



(a) Unnotched.



(b) Conical-ended notched.

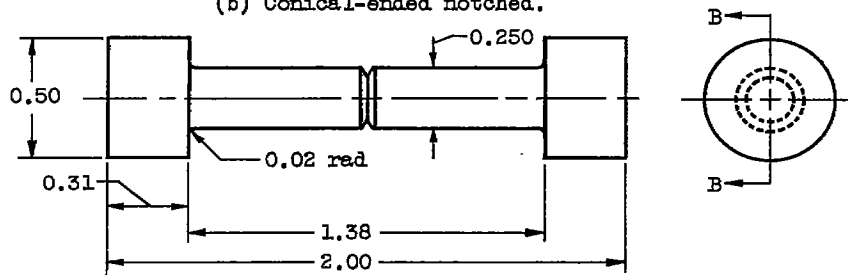

(c) Button-head-ended notched.

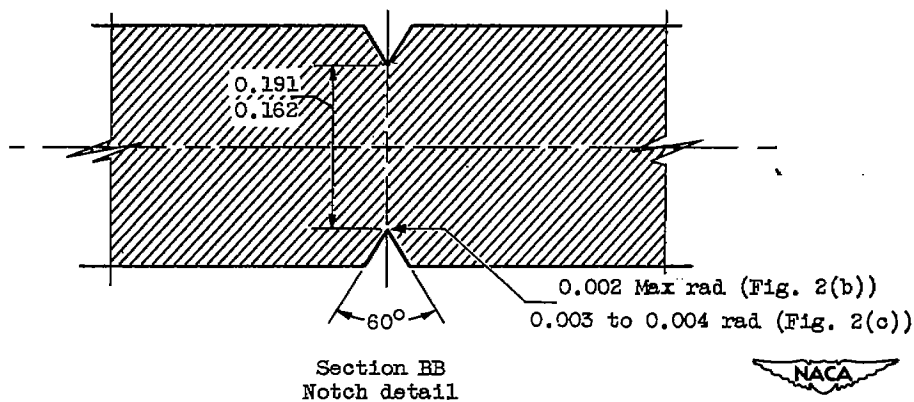
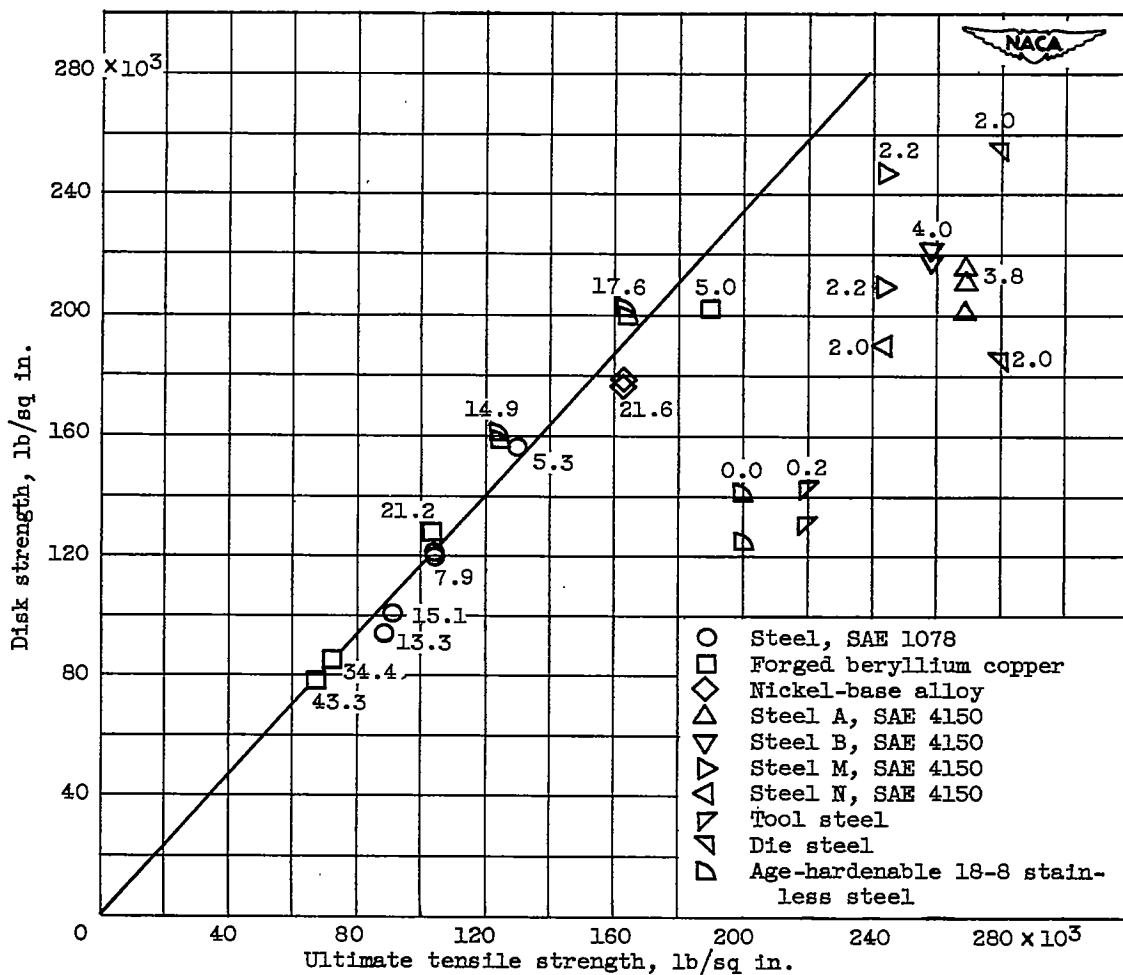

Figure 2. - Tensile specimens. (All dimensions are in inches.)

2337



(a) Solid disks.

Figure 3. - Relation between disk strength and ultimate tensile strength. Values beside data points indicate percent elongation.

2337

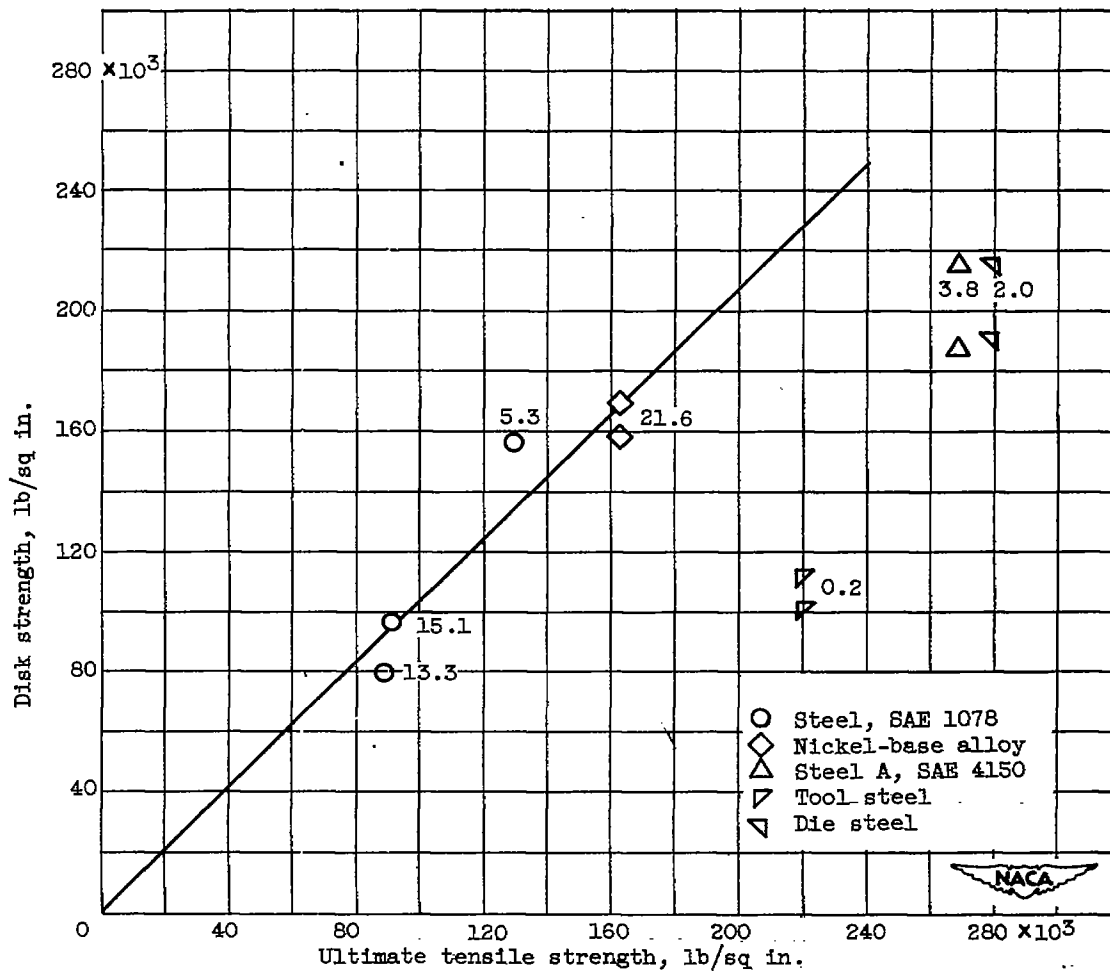

(b) Disks with 1/16-inch-diameter central holes.

Figure 3. - Continued. Relation between disk strength and ultimate tensile strength. Values beside data points indicate percent elongation.

2537

2337

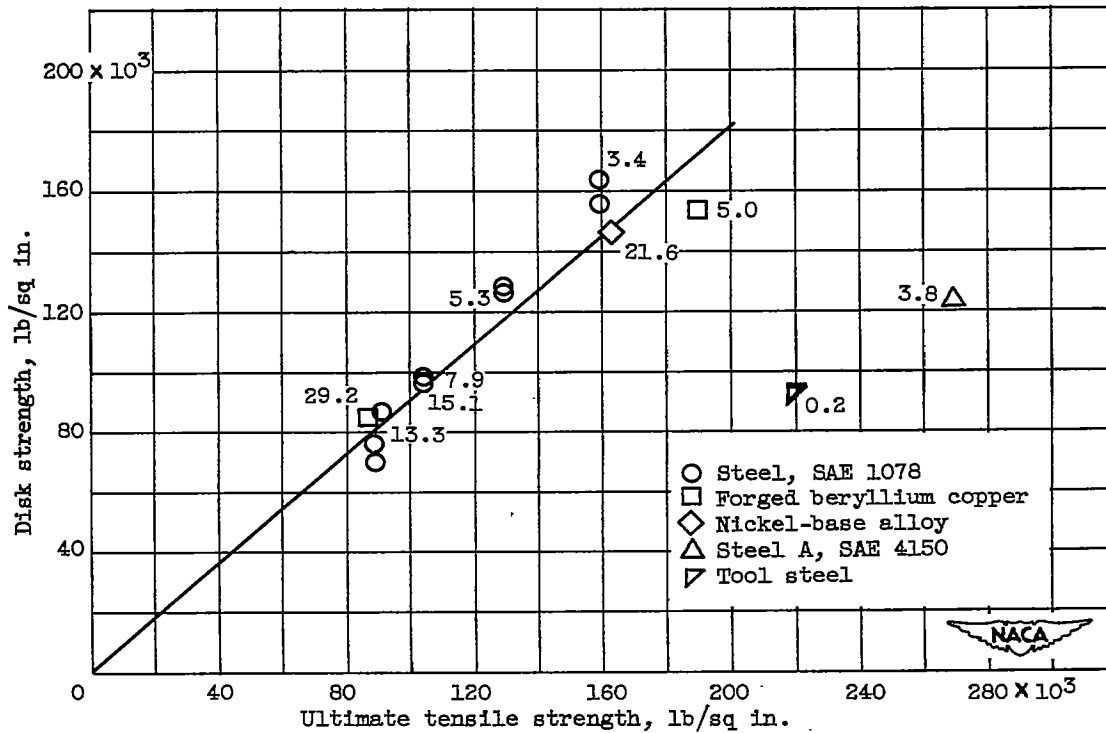

(c) Disks with  $\frac{1}{2}$ -inch-diameter central holes.

Figure 3. - Continued. Relation between disk strength and ultimate tensile strength. Values beside data points indicate percent elongation.

2337

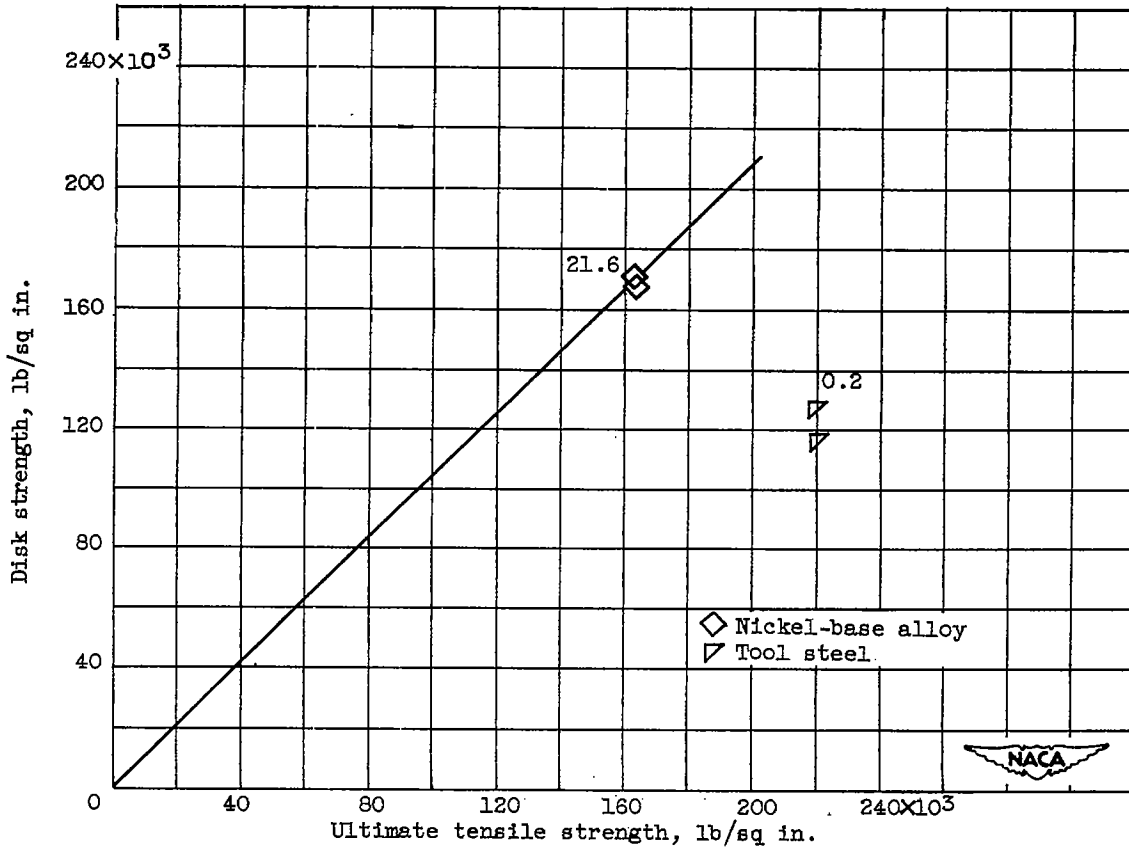

(d) Disks with four 3/8-inch-diameter eccentric holes.

Figure 3. - Concluded. Relation between disk strength and ultimate tensile strength. Values beside data points indicate percent elongation.

2337

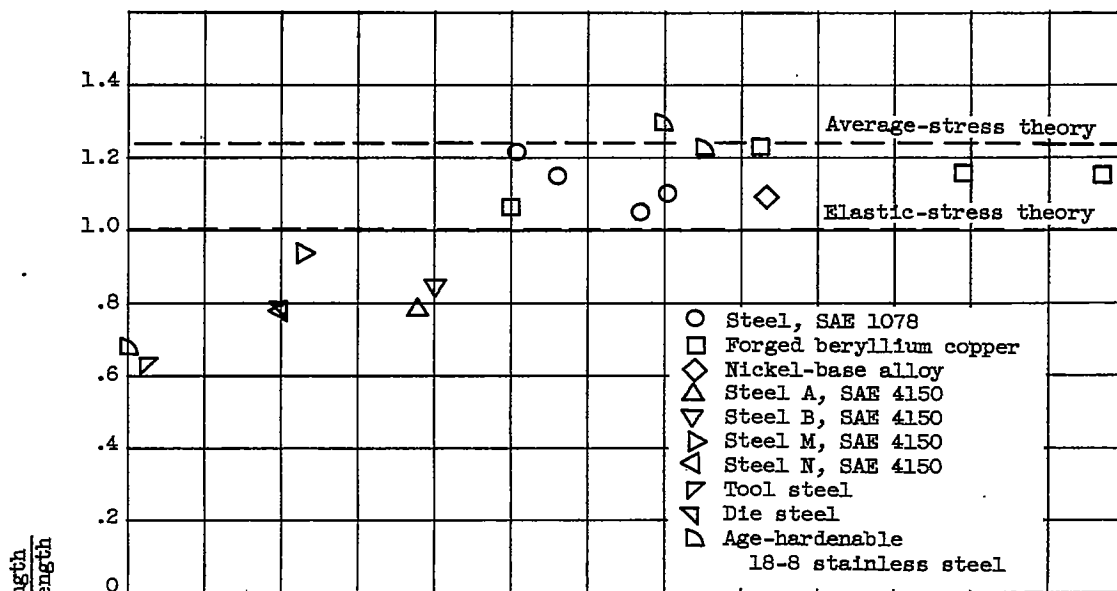

(a) Solid disks.

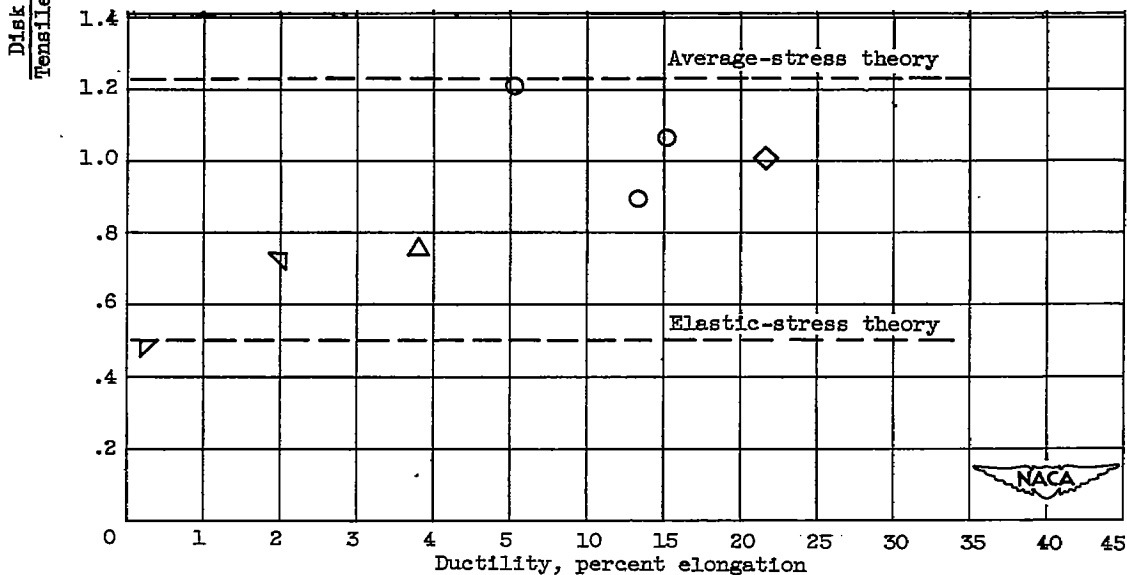

(b) Disks with 1/16-inch-diameter central holes.

Figure 4. - Relation between ductility and utilization of tensile strength.



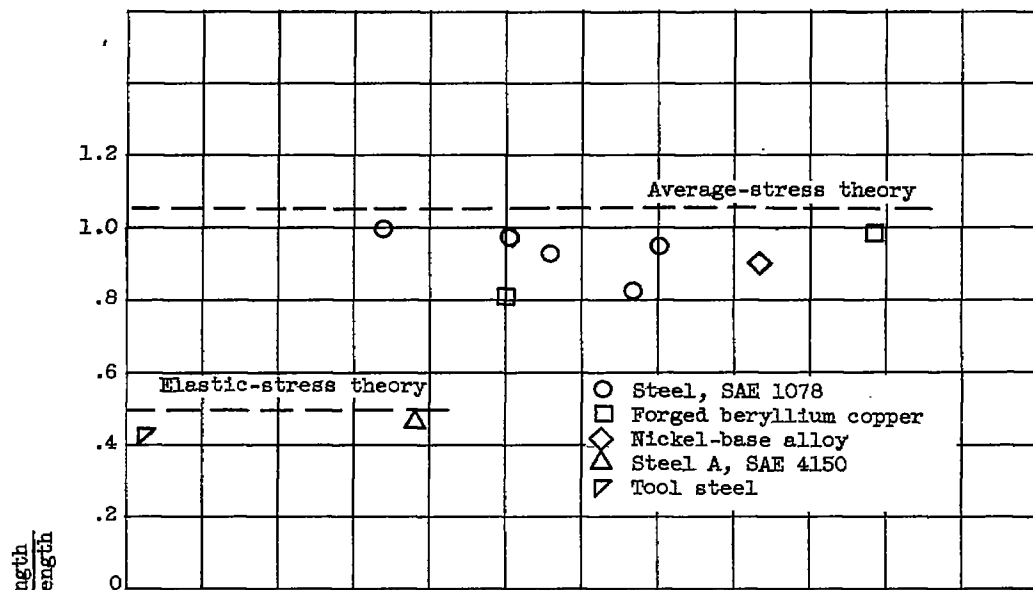

(c) Disks with 1/2-inch-diameter central holes.

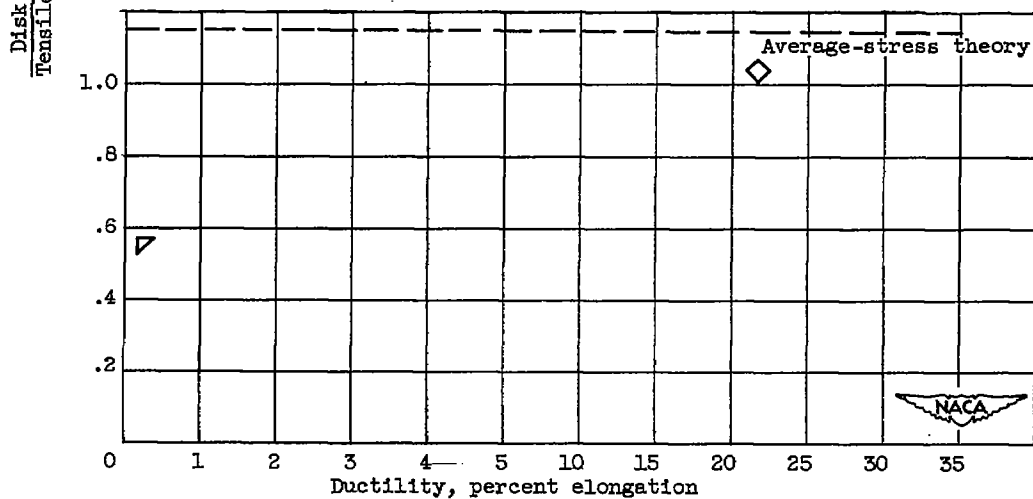

(d) Disks with four 3/8-inch-diameter eccentric holes.

Figure 4. - Concluded. Relation between ductility and utilization of tensile strength.

2337



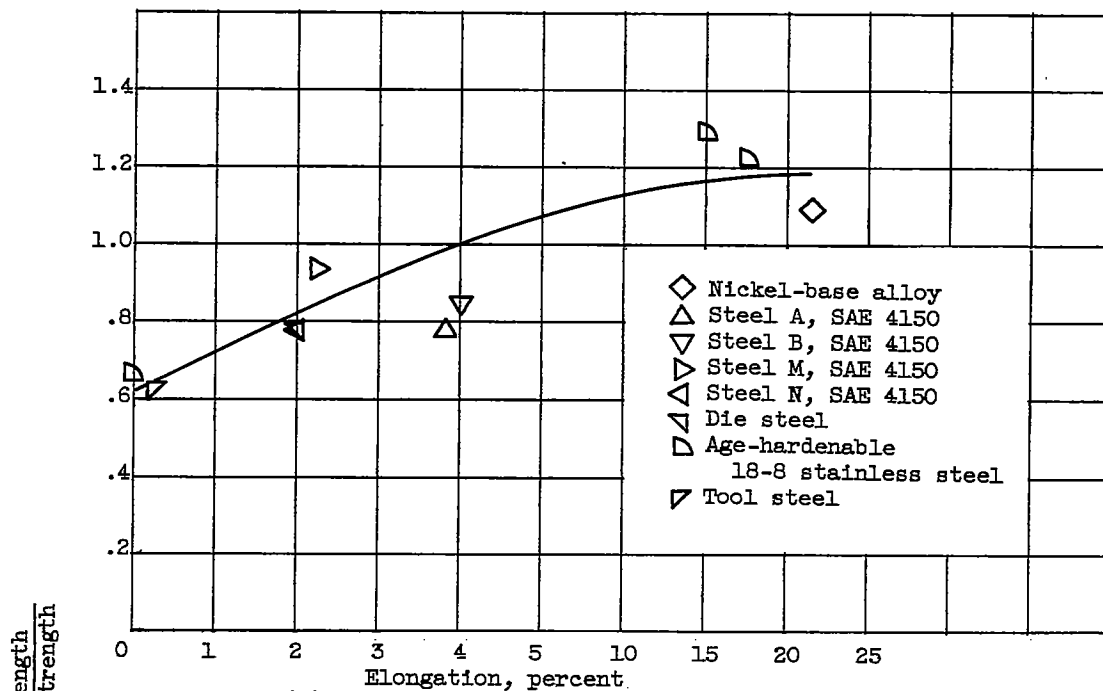

(a) Correlation with ductility

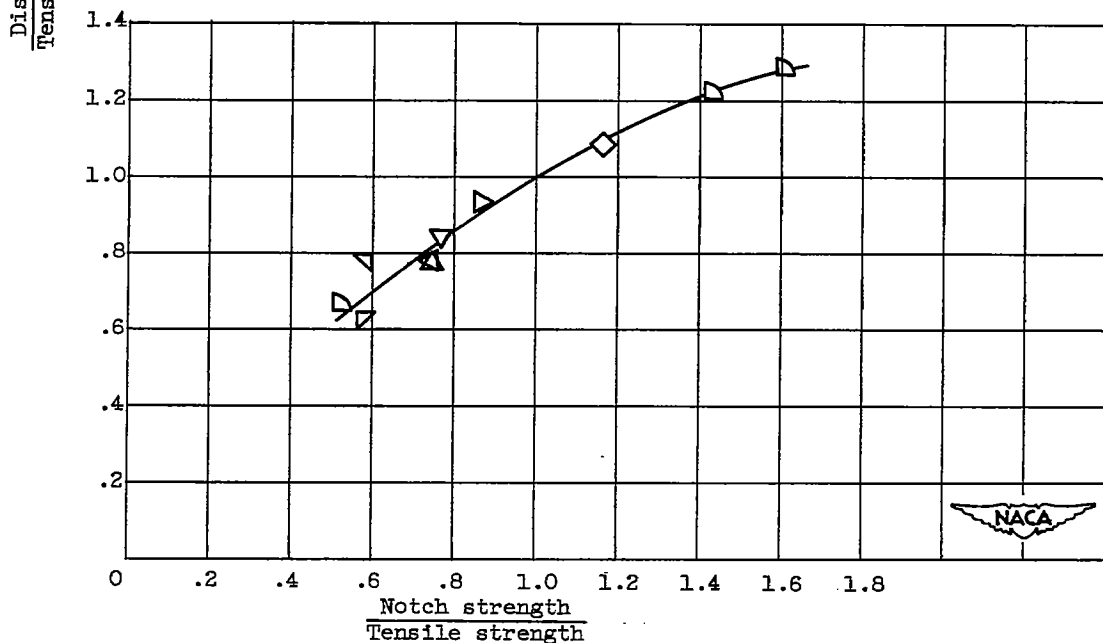

(b) Correlation with stress concentration resistance.

Figure 5. - Correlation of disk strength with tensile strength and ductility, and correlation of disk strength with tensile strength and stress concentration resistance for solid disks.



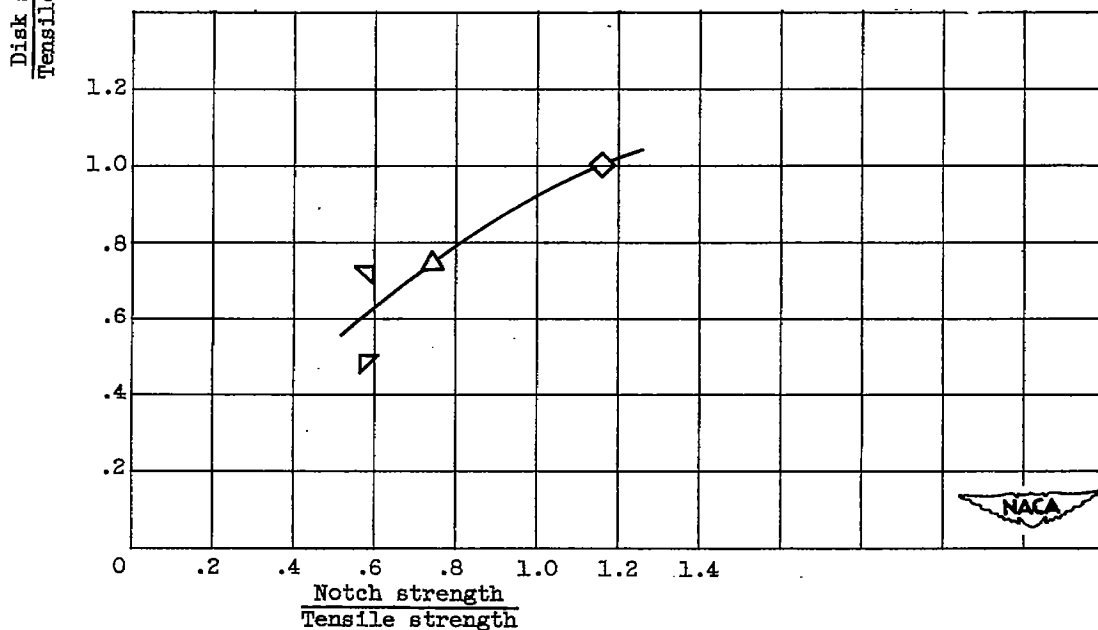
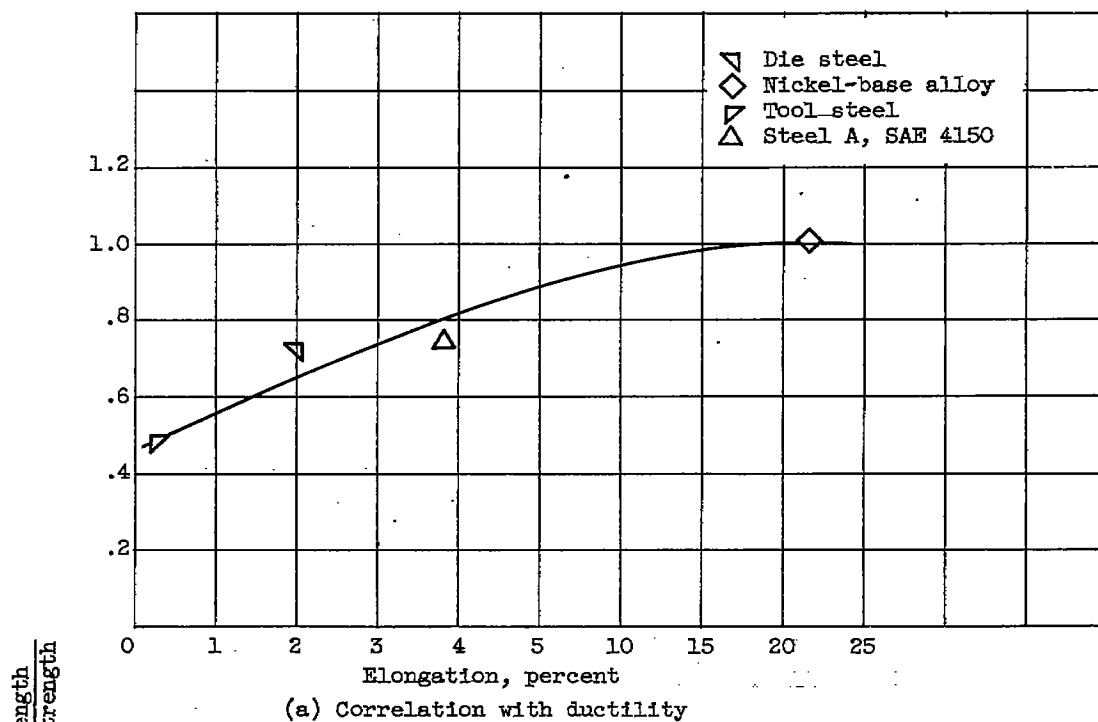
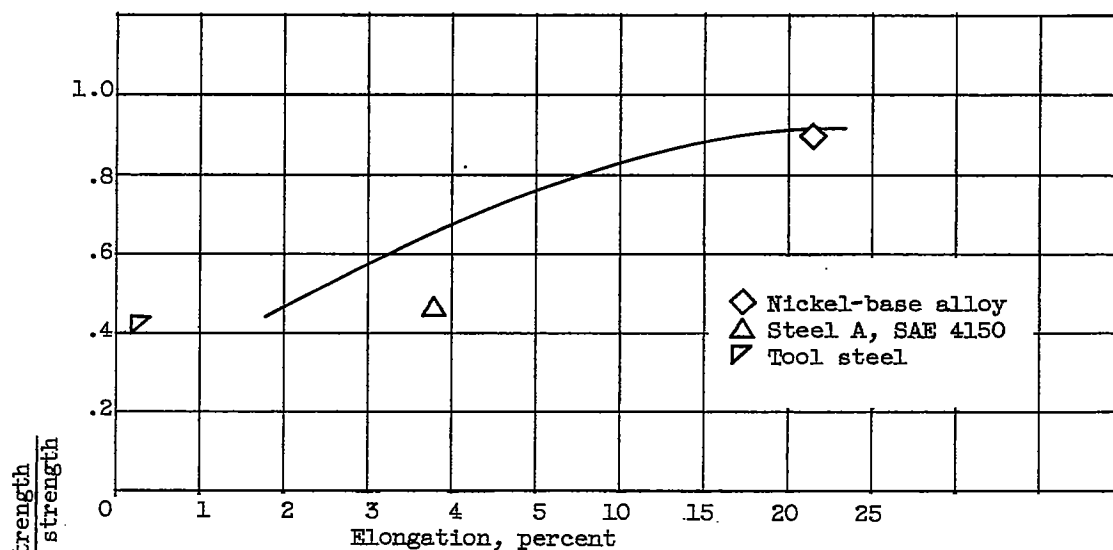
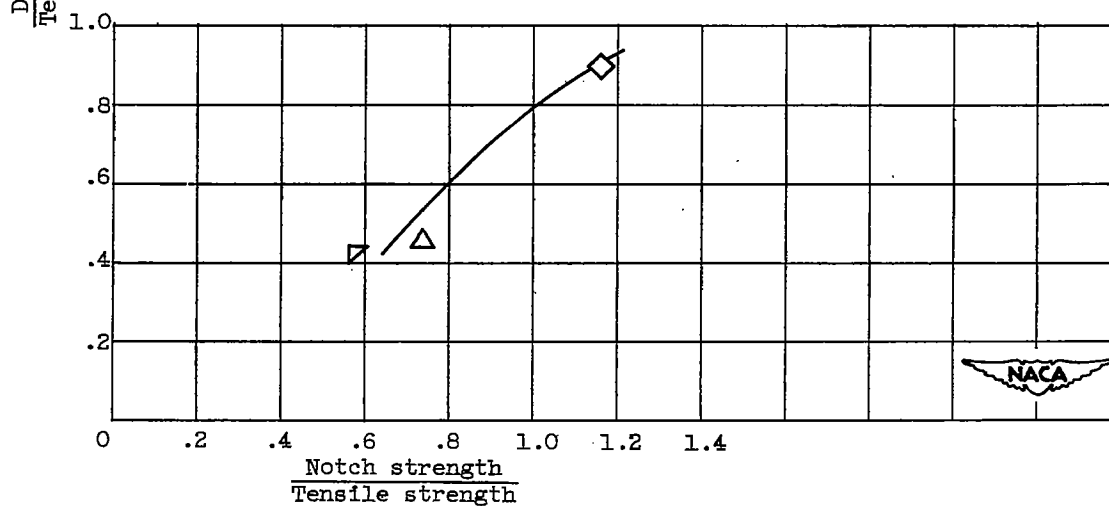

Figure 6.— Correlation of disk strength with tensile strength and ductility and correlation of disk strength with tensile strength and stress concentration resistance for disks with 1/16-inch-diameter central holes.



(a) Correlation with ductility.



(b) Correlation with stress concentration resistance.

Figure 7. - Correlation of disk strength with tensile strength and ductility and correlation of disk strength with tensile strength and stress concentration resistance for disks with  $\frac{1}{2}$ -inch-diameter central holes.



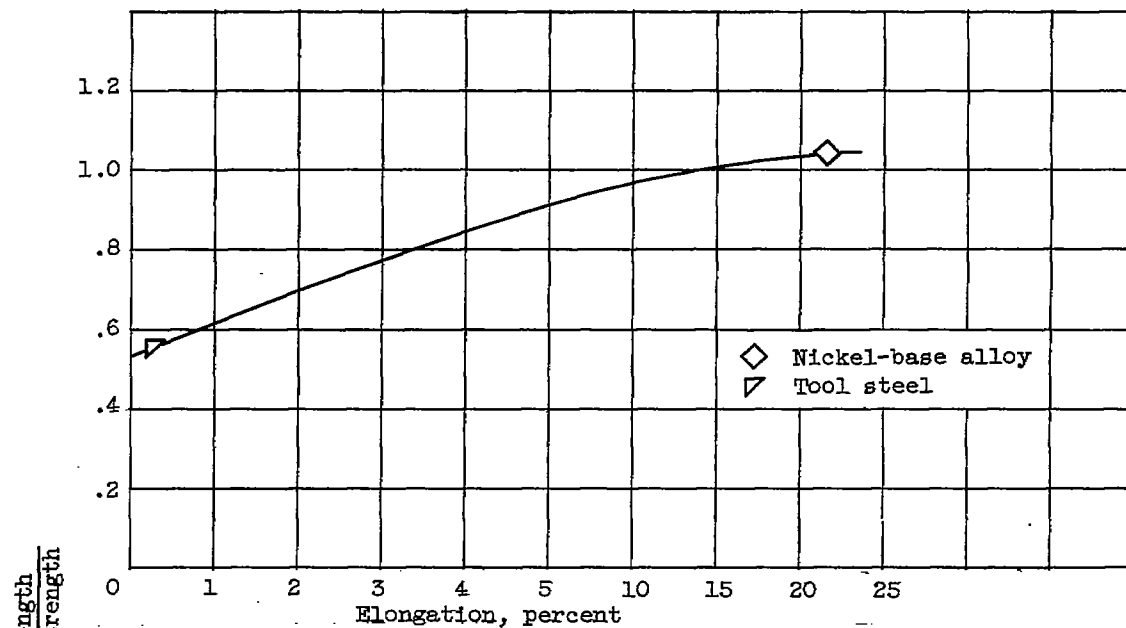

(a) Correlation with ductility.

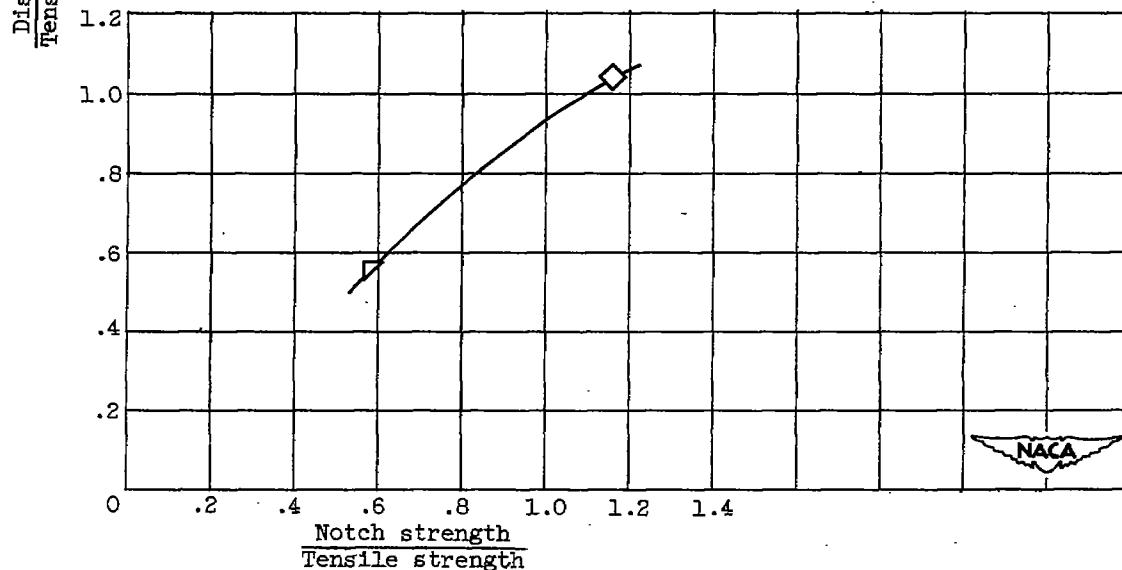

(b) Correlation with stress concentration resistance.

Figure 8. - Correlation of disk strength with tensile strength and ductility and correlation of disk strength with tensile strength and stress concentration resistance for disks with four 3/8-inch-diameter eccentric holes.

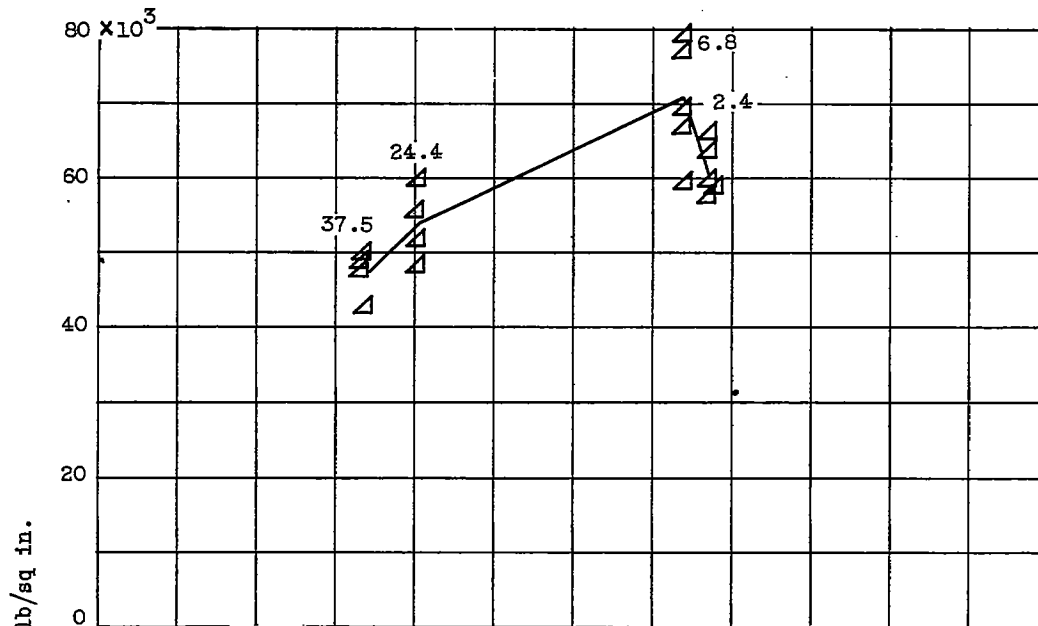

(a) Tensile strength.

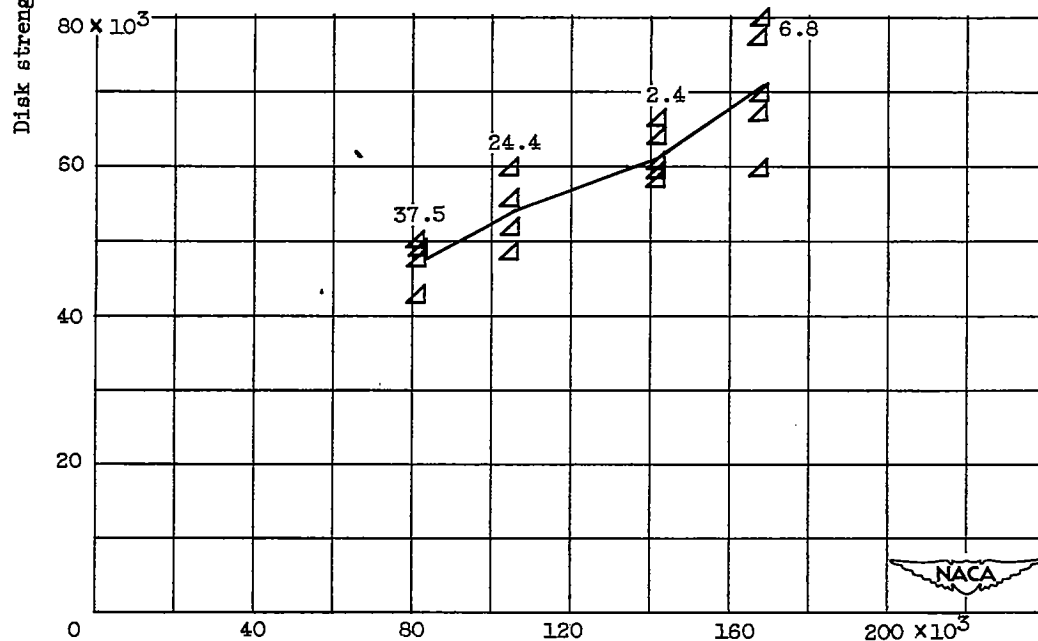

(b) Notch strength.

Figure 9. - Relation between disk strength and specimen strength for cast beryllium copper disks with  $\frac{1}{2}$ -inch-diameter central holes and shrink porosity. Values beside data points indicate percent elongation.

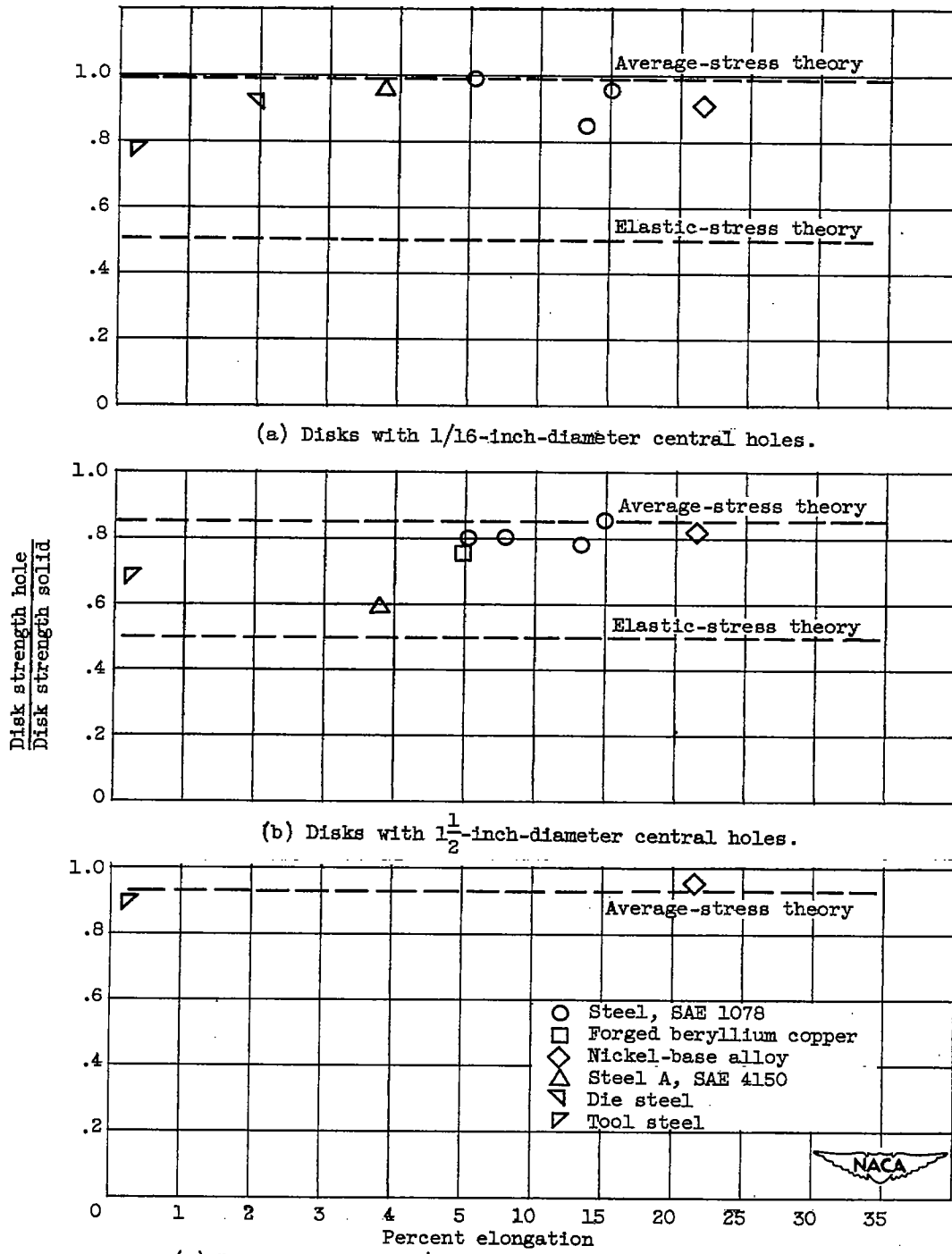

Figure 10. - Relation between ductility and strength reduction due to presence of holes.