

OCT 15 1952

NACA TN 2804

NATIONAL ADVISORY COMMITTEE FOR AERONAUTICS

TECHNICAL NOTE 2804

THE PLANING CHARACTERISTICS OF A SURFACE HAVING
A BASIC ANGLE OF DEAD RISE OF 20° AND
HORIZONTAL CHINE FLARE

By Walter J. Kapryan and Irving Weinstein

Langley Aeronautical Laboratory
Langley Field, Va.

*Horizontal
Chine Flare*



Washington

October 1952

FOR REFERENCE

NOT TO BE TAKEN FROM THIS ROOM

NACA LIBRARY
LANGLEY AERONAUTICAL LABORATORY
Langley Field, Va.

1L

NATIONAL ADVISORY COMMITTEE FOR AERONAUTICS

TECHNICAL NOTE 2804

THE PLANING CHARACTERISTICS OF A SURFACE HAVING
A BASIC ANGLE OF DEAD RISE OF 20° AND
HORIZONTAL CHINE FLARE

By Walter J. Kapryan and Irving Weinstein

SUMMARY

In order to extend the range of available planing-surface data, the hydrodynamic characteristics have been obtained for a planing surface having a basic angle of dead rise of 20° at the keel and horizontal chine flare. This surface is representative of those used on present-day flying boats. The wetted lengths, resistances, center-of-pressure locations, and drafts were determined at speed coefficients (Froude numbers) ranging from approximately 3.0 to 25.0, with the bulk of the data obtained at Froude numbers in excess of 7.0. Beam loadings were varied from 0.85 to 87.33. Keel-wetted-length-beam ratios were extended to 7.0 in all cases where excessive loads and spray conditions were not encountered.

The data obtained indicate that, during high-speed steady-state planing, the planing characteristics are independent of speed and load for a given trim and depend only on lift coefficient. The difference between the chine wetted length and keel wetted length is constant for a given trim angle and the variation of this difference with trim is shown to be in reasonable agreement with theory. The ratio of center-of-pressure location forward of the step to the mean wetted length, for practical applications, can be considered a constant equal to 0.67 up to 18° of trim. A slight decrease in this ratio occurs with further increase in trim angle. The draft data indicate a pile-up of water at the keel during steady-state planing. Although negligible at low trims, this pile-up was significant at trims of 12° and higher. The drag data show that friction drag at trims of 18° and higher is negligible and that the resistances for those trims may be assumed equal to the load times the tangent of the trim angle.

INTRODUCTION

Present developments in water-based aircraft show an immediate need for information on the principal planing characteristics of prismatic

surfaces at higher trims and loads than are covered by the range of steady-state experimental data now available (refs. 1 to 8). In addition to this information, the effects of chine flare used on seaplane hulls to control spray and increase the efficiency of surfaces having high angles of dead rise need to be studied.

In order to meet this need, a detailed testing program was established to include basic angles of dead rise up to 40° , trims up to 30° , wetted-length—beam ratios up to 7.0, and Froude numbers, based on beam, up to 25.0. The principal planing characteristics to be determined for appropriate combinations of speed, load, and trim were resistance, center of pressure, draft, and wetted length. In addition to straight V-shaped cross sections of fundamental interest, modified sections with horizontal chine flare and vertical chine strips were included. The program was carried out in the Langley tank no. 1. This large facility enabled the maximum Froude number to be reached with an acceptable size of model and more extreme combinations of the independent parameters to be covered than have heretofore been investigated.

In the present paper the apparatus used and procedures developed for the program are described, and the results obtained for the first model, a surface having a 20° angle of dead rise and horizontal chine flare, are presented. This cross section is representative of that currently used on the forebodies of flying boats and may also be useful for more heavily loaded planing elements on unconventional seaplanes.

SYMBOLS

b	beam of planing surface, ft
d	draft at trailing edge (measured vertically from undisturbed water level), ft
g	acceleration due to gravity, 32.2 ft/sec^2
l_c	chine wetted length, ft
l_k	keel wetted length, ft
l_m	mean wetted length, $\frac{l_c + l_k}{2}$ for this model, ft
l_p	center-of-pressure location (measured along keel forward of trailing edge), $\frac{M}{\Delta \cos \tau + R \sin \tau}$, ft

M	trimming moment about trailing edge of model at keel, ft-lb
Δ	vertical load, lb
R	horizontal resistance, lb
Re	Reynolds number
S	principal wetted area (bounded by trailing edge, chines, and heavy spray line) projected on plane parallel to keel, $l_m b$, sq ft
V	horizontal velocity, ft/sec
w	specific weight of water, lb/cu ft
C_{Δ}	load coefficient or beam loading, Δ/wb^3
C_R	resistance coefficient, R/wb^3
C_V	speed coefficient or Froude number, V/\sqrt{gb}
C_{Lb}	lift coefficient based on beam, $\frac{\Delta}{\frac{\rho}{2} v^2 b^2} = 2 \frac{C_{\Delta}}{C_V^2}$
C_{Db}	drag coefficient based on beam, $\frac{R}{\frac{\rho}{2} v^2 b^2}$
C_{Ls}	lift coefficient based on principal wetted area, $\frac{\Delta}{\frac{\rho}{2} v^2 S} = \frac{C_{Lb}}{l_m/b}$
C_{Ds}	drag coefficient based on principal wetted area, $\frac{R}{\frac{\rho}{2} v^2 S} = \frac{C_{Db}}{l_m/b}$
β	angle of dead rise, deg
ρ	mass density of water, slugs/ft ³
τ	trim (angle between keel and horizontal), deg

DESCRIPTION OF MODEL

A photograph of the model is shown as figure 1 and a cross section showing the pertinent dimensions of the model is presented in figure 2. The model, which is made of brass, has a length of 36 inches, a beam of 4 inches, and horizontal chine flare. The flare is a circular arc tangent to the basic 20° dead-rise section and horizontal at the chine. The radius of the arc is such that the angle of dead rise measured from the chine is 16° and the width of the flare on each side of the keel is approximately 20 percent of the beam. The resulting cross section is similar to that of the length-beam-ratio series of hulls recently investigated by the National Advisory Committee for Aeronautics (ref. 9).

The planing bottom of the model was machined to a tolerance of ± 0.002 inch and polished to a finish corresponding to the finish of the "A" block in the General Electric Standard Roughness Specimen set. This finish was maintained throughout testing by daily polishing. The bottom was also machined longitudinally straight to a tolerance of ± 0.005 inch and the chines and keel were machined knife-sharp. The agreement of subsequent check data with that obtained early in the testing program indicates that any reduction in sharpness of the keel and chines produced by daily polishing did not affect the results.

APPARATUS AND PROCEDURES

General

A detailed description of the Langley tank no. 1, the apparatus for towing the model, and the instrumentation for measuring the lift, drag, and trimming moment is given in reference 10. A diagram of the model and towing gear is presented in figure 3.

Wetted Length and Area

The wetted areas were determined from underwater photographs and from visual readings of the wetted length where photographs were not available. The apparatus used to obtain the photographs is shown in figure 4. The camera was located in a watertight glass-top box submerged in the center of the tank. As the model passed over the camera, the shutter was actuated by a photocell unit which also flashed three speed lamps for illumination of the model. The presence of the box, which was 30 inches (7.5 model beams) under the undisturbed water surface, had no measurable effect on the hydrodynamic forces acting on the planing surfaces.

The requirement of a highly polished metal surface precluded the use of painted or scribed grids on the model for measuring wetted length. In order to make this measurement, transparent grids were superposed on the photographs during the process of enlarging, the grids having previously been made for each model at various trims and drafts. A typical underwater photograph with superposed grids is shown as figure 5.

The wetted lengths were arbitrarily measured from the trailing edge to the intersection of the keel and chines with the heavy spray line as shown in figure 5. This spray line was essentially straight from keel to chine throughout the range of the tests, and the mean wetted length was therefore the average of the keel and chine wetted lengths. The principal wetted area, analogous to wing area in aerodynamics, was then taken as the area aft of the spray line projected in a plane parallel to the keel or the mean wetted length times the beam. The area wet by light spray forward of the spray line was not included in the principal wetted area since it is assumed that this area does not contribute appreciably to the lift force and should not be included in the fundamental lift coefficient C_{L_0} .

Draft

The visual draft readings, which were obtained by the method described in reference 10, were referred to the undisturbed water surface. Corrections to these readings were necessary because of the influence of the pressure distribution around the towing carriage on the water level under the carriage and because of a surge or long wave which is set up in the tank during operation. The position of the actual water surface relative to the towing carriage (undisturbed water surface) was recorded by a capacity-bridge water-level recorder. This instrument, shown in figure 6, consisted of: (1) A Wheatstone bridge pick-up unit, (2) a 5000-cycle-per-second carrier amplifier, (3) a 5000-cycle-per-second oscillator, (4) a power supply, and (5) a recorder. One leg of the bridge consisted of a metal plate and the water surface. The other legs contained condensers. A variation of the distance between the plate and the water surface unbalanced the bridge and caused flow of current. This current was amplified, demodulated, and fed into the recording galvanometer.

A careful survey of the water surface indicated no appreciable gradient in height in the vicinity of the test area.

Aerodynamic Tares

The aerodynamic forces on the model and towing gate were held to a minimum by the use of a windscreen housing the test section of the

towing carriage as shown in figure 7. The windscreen, which was constructed of $\frac{1}{4}$ -inch plywood, had vertical sides and was V-shaped in front. A horizontal lip of $\frac{1}{8}$ -inch-thick aluminum, 12 inches wide, was installed flush with the bottom of the main V and projected forward. This lip helped minimize the water-surface disturbances. A clearance of 1 inch between the bottom of the screen at the V and the water surface was maintained during testing.

The lengthy extension of the windscreen aft of the model was used to prevent spray from striking the towing carriage. This extension of the windscreen was 9 inches above the water to provide clearance above the tank structure when the towing carriage was in the trimming basin.

The residual windage tares were determined by making a series of runs at various speeds with the model barely clearing the surface of the water. The tare for resistance amounted to only 0.3 pound at a speed of 82 feet per second. The proper tare was deducted from the drag measurements to obtain the hydrodynamic resistances. The tares for load and moment were found to be negligible.

Precision*

The quantities measured are generally believed to be accurate within the following limits:

Load, lb	±0.15
Resistance, lb	±0.15
Trimming moment, ft-lb	±0.50
Wetted length, in.	±0.25
Draft, in.	±0.05
Trim, deg	±0.10
Speed, ft/sec	±0.20

TEST PROGRAM

The basic schedule of points for which the data were obtained is shown in figure 8. The schedule was bounded by the maximum load limit of the apparatus, the maximum speed of the towing carriage, and the curve representing the maximum value of 0.5 of the parameter $\sqrt{C_{\Delta}}/C_V$. Combinations of load and speed within the boundaries were selected to correspond to approximately equal increments of $\sqrt{C_{\Delta}}/C_V$ and to determine

variations of the quantities measured with speed at the arbitrary values of constant load shown.

The measurements were made at trims of 2°, 4°, 6°, 12°, 18°, 24°, and 30°. At each trim, the basic schedule was followed up to loads where the keel-wetted-length—beam ratio exceeded 7.0 or the salt spray became too extensive for proper maintenance of the apparatus.

Supplementary combinations of speed and load were used at low trims to determine the inception of clean planing and elsewhere as required to define variations of the measurements with speed, load, and trim.

RESULTS AND DISCUSSION

Tabular Data

The experimental data obtained for all conditions where the chines were wetted are presented in tables I and II. The corresponding data for the dry-chine condition have been omitted, since in this condition the precision of measurement became marginal for the size of model used.

In these tables, the load, resistance, speed, wetted lengths, draft, and center of pressure are expressed as conventional nondimensional hydrodynamic coefficients based on beam. The lift and drag coefficients are expressed both in terms of the square of the beam and the principal wetted area. Both forms are included because the former has been used universally in the literature on planing and the latter is analogous to the fundamental coefficients of aerodynamic lifting elements.

Analysis

During planing, where forces due to buoyancy are negligible, the dynamic planing characteristics would be expected to be primarily functions of lift coefficient and trim. The data in table I, therefore, were plotted against C_{L_b} with trim as a parameter.

In general, the experimental data when plotted against C_{L_b} group along a single curve for each trim. This "collapsing" indicates the independence of the data from speed and eliminates, for engineering purposes, the necessity of interpolating for load. Because of the simple relation between C_{L_b} and C_{L_S} when the chines are wetted $\left(\frac{l_m}{b} C_{L_S} = C_{L_b}\right)$, corresponding curves of collapsed data against C_{L_S} may be easily constructed when the use of the more fundamental lift coefficient is preferable.

The data presented in table II were obtained in the speed range where lift coefficient is not the governing parameter and, therefore, the data will not fit the collapsed curves. A detailed discussion of this data appears subsequently in this paper in the section entitled "Buoyancy."

Wetted length.- The variation of the mean-wetted-length-beam ratio l_m/b with C_{L_b} is shown in figure 9. For a given value of C_{L_b} , the mean-wetted-length-beam ratio increased with decrease in trim and at low trims the wetted length increased rapidly with a small increase in C_{L_b} .

The relation between the chine-wetted-length-beam ratio l_c/b and the keel-wetted-length-beam ratio l_k/b is shown in figure 10. The difference between the chine wetted length and the keel wetted length was constant for a given trim until the dry-chine condition was reached. By definition, a similar variation necessarily holds for the relation between the mean wetted length and the keel wetted length.

The variation of the difference between the chine and keel wetted lengths with trim is shown in figure 11. The variation predicted by the two-dimensional theory of Wagner, as applied in reference 7, is also shown. A mean dead-rise angle of 18° was assumed to account for the reduction in the angle of dead rise caused by horizontal chine flare. The experimental curve is in reasonable agreement with the theoretical curve, although its absolute values fall somewhat below those of the theoretical curve.

Center of pressure.- The center-of-pressure location l_p is defined as the distance from the trailing edge to the intersection of the resultant hydrodynamic force vector with the keel of the model. A plot of center-of-pressure location in beams l_p/b against C_{L_b} is presented in figure 12. Since for a given trim all the data for different loads and speeds form a single curve against C_{L_b} , it follows that, for a given trim and lift coefficient, l_p/b is, for practical considerations, independent of speed and load.

Figure 13 presents plots of l_p/b against l_m/b for each of the trim angles. The ratio of the center-of-pressure location to the mean wetted length appears to be almost constant for trims up to 18° . For practical applications, this ratio l_p/l_m can be considered equal to 0.67 for trims of 18° or less and independent of the trim or the mean-wetted-length-beam ratio. This ratio decreased at the higher trims and became 0.55 at a trim of 30° .

Draft.- A plot of d/b against C_{L_b} is presented in figure 14. The variation of d/b with C_{L_b} follows a pattern similar to that evidenced in the variation of l_m/b and l_p/b with C_{L_b} (figs. 9 and 12, respectively). In figure 15, the drafts, expressed as a function of the beam, are plotted against $\frac{l_k}{b} \sin \tau$ and compared with those computed from the keel wetted lengths where

$$\left(\frac{d}{b}\right)_{\text{computed}} = \frac{l_k}{b} \sin \tau$$

The computed curves give the draft relative to a keel wetted length corresponding to an intersection of the model with the water surface as defined in figure 5. If the vertical position of the water surface at the point where the keel intersects the water surface did not change, the computed drafts would be expected to match the actual draft readings. The draft data, however, fall below these computed curves, particularly at trims above 12° ; this result suggests a pile-up of water at the keel. The extent of the pile-up is indicated in figure 16, where the pile-up in beams is plotted against trim.

Buoyancy.- Some of the light-load and low-speed conditions at the lower trims were strongly influenced by buoyancy. For these conditions, C_{L_b} is no longer the governing parameter. In order to define the limitations of the plots against C_{L_b} , therefore, drafts were measured at low speeds to the point where the sides of the model above the chines were wetted or to the point where the spray envelope fell back on the deck of the model, whichever occurred first. These data are presented in figure 17 as a plot of d/b against C_{L_b} . The data obtained at the low speeds are seen to depart from the curves of collapsed data of figure 14 (represented by the solid lines in fig. 17) in a systematic pattern, with load as parameter. In every case, this departure occurred before the sides of the model were wetted. A cross plot of these curves (fig. 18) establishes a minimum load below which the data, at a given C_{L_b} , appear to depart from the curves of collapsed data. The area below each trim curve represents data that will be most influenced by buoyancy and will not lie on the curves of collapsed data; for example, at a trim angle of 6° , the lightest beam loading that will still lie on the curve of collapsed data at a C_{L_b} of 0.15 is 3.05.

This tendency to depart from the curves of collapsed data was noted at low trims for all the quantities measured and was taken into

account in fairing the data. At trims above 12°, combinations of load and speed where buoyancy effects were appreciable were not reached within the limits of the test program.

Resistance.- The drag coefficients from table I are plotted against lift coefficient in figure 19. On this basis, the data for the various speeds and loads collapse into a single curve for each trim and the curves at the higher trims are straight lines through the origin.

The total drag of a prismatic planing surface is made up of the horizontal components of the normal force or induced drag and the friction force. The induced drag coefficient for the clean-planing condition at each trim is represented in figure 19 by a dashed line with a slope equal to the tangent of the trim angle. The difference between the total and induced drag coefficients is the friction drag coefficient. At low trims the friction drag is seen to be a large part of the total, whereas, at trims of 18° and over, it is negligible. The friction drag is, of course, a function of the effective Reynolds number, the roughness of the model, and the extent of laminar flow in the boundary layer. The latter effect for a smooth model may be examined by a comparison of the skin-friction drag coefficients deduced from the drag data and the well-established coefficients for smooth flat plates.

In calculating the skin-friction drag coefficients from the test data, the faired values of drag coefficient of figure 19 and the faired values of mean-wetted-length-beam ratio from figure 9 were used to improve the precision. The skin-friction drag coefficient C_f was assumed to be

$$C_f = \frac{F}{\frac{\rho}{2} S_f V_m^2}$$

where

F friction force parallel to keel, $R \cos \tau - \Delta \sin \tau$, lb

S_f actual wetted area aft of the stagnation line or approximately $S/\cos \beta$

V_m mean speed over the surface

The mean speed was assumed to be that given by Bernoulli's theorem for a surface streamline, with a uniform average pressure on the model assumed equal to $\frac{\Delta}{S \cos \tau}$.

Thus,

$$V_m^2 = V^2 - \frac{2g \Delta}{wS \cos \tau}$$

$$= V^2 \left(1 - \frac{C_{L_b}}{\cos \tau \ l_m/b} \right)$$

For small trims, $\cos \tau$ may be taken equal to 1 and

$$C_f = \cos \beta \frac{C_{D_b} - C_{L_b} \tan \tau}{\frac{l_m}{b} - C_{L_b}} \quad (1)$$

The Reynolds number for the planing surface was assumed to be $V_m l_m / \nu$ where ν is the kinematic viscosity.

The results of the calculations for trims at which the friction is appreciable are plotted in figure 20 together with the Schoenherr line (ref. 11) for fully turbulent boundary layer and the Blasius line for laminar flow on flat plates. The coefficients for the model lie close to the Schoenherr line at the higher Reynolds numbers, an indication of largely turbulent boundary layers, and generally lie between the lines at the lower Reynolds numbers, an indication of partially laminar boundary layers. The values of the friction drag coefficients apparently decrease with increases in load and trim; this decrease may be attributed to the fact that effects of the pressure gradients on the model favor the extent of the laminar layer in spite of the marked turbulence induced by the intersection with the water surface. It should be noted, however, that at the lower Reynolds numbers the friction forces are generally small and the accuracy of determination of the friction drag coefficient is greatly decreased. For example, at a trim of 12° , the derived friction forces were generally less than 0.4 pound at Reynolds numbers below 1×10^6 and less than 0.2 pound at Reynolds numbers below 0.5×10^6 .

For the full-scale planing surface, calculation of the drag directly by equation (1) with the skin-friction drag coefficient for fully turbulent flow at the appropriate Reynolds number seems preferable. This procedure involves only the use of wetted-length and wetted-area data from the tank tests and is independent of the small-scale drag data. At high trims (above 12°), the friction force can be neglected entirely and the total drag taken as equal to the induced drag or $\Delta \tan \tau$.

CONCLUDING REMARKS

The results obtained from an experimental investigation of a planing surface having an angle of dead rise of 20° and horizontal chine flare indicate that, during high-speed steady-state planing, the important planing characteristics are independent of speed and load for a given trim and depend only on lift coefficient. The difference between the chine wetted length and keel wetted length is constant for a given trim angle and the variation of this difference with trim is shown to be in reasonable agreement with theory. The ratio of center-of-pressure location forward of the trailing edge to the mean wetted length, for most practical applications, can be considered a constant equal to 0.67 up to 18° of trim. This ratio decreases to 0.55 at 30° of trim. Evidence of pile-up at the keel was present at all trims and was substantial at trims above 12° . The drag data show that friction drag at trims of 18° and higher is negligible and that the resistances for those trims may be assumed equal to the load times the tangent of the trim angle.

Langley Aeronautical Laboratory,
National Advisory Committee for Aeronautics,
Langley Field, Va., July 23, 1952.

REFERENCES

1. Sambraus, A.: Planing-Surface Tests at Large Froude Numbers - Airfoil Comparison. NACA TM 848, 1938.
2. Sottorf, W.: Experiments With Planing Surfaces. NACA TM 661, 1932.
3. Sottorf, W.: Experiments With Planing Surfaces. NACA TM 739, 1934.
4. Sottorf, W.: Analysis of Experimental Investigations of the Planing Process on the Surface of the Water. NACA TM 1061, 1944.
5. Shoemaker, James M.: Tank Tests of Flat and V-Bottom Planing Surfaces. NACA TN 509, 1934.
6. Locke, F. W. S., Jr.: Tests of a Flat Bottom Planing Surface To Determine the Inception of Planing. NAVAER DR Rep. 1096, Bur. Aero., Dec. 1948.
7. Korvin-Kroukovsky, B. V., Savitsky, Daniel, and Lehman, William F.: Wetted Area and Center of Pressure of Planing Surfaces. Preprint No. 244, S.M.F. Fund Paper, Inst. Aero. Sci. (Rep. No. 360, Project No. NRO62-012, Office Naval Res., Exp. Towing Tank, Stevens Inst. Tech., Aug. 1949.)
8. Savitsky, Daniel: Wetted Length and Center of Pressure of Vee-Step Planing Surfaces. S.M.F. Fund Paper No. FF-6, Inst. Aero. Sci. (Rep. No. 378, Project No. NRO62-012, Office Naval Res., Exp. Towing Tank, Stevens Inst. Tech.), Sept. 1951.
9. Carter, Arthur W.: Recent N.A.C.A. Research on High Length-Beam Ratio Hulls. Paper presented at the Annual Summer Meeting, I.A.S., Los Angeles, July 14-16, 1948.
10. Truscott, Starr: The Enlarged N.A.C.A. Tank, and Some of Its Work. NACA TM 918, 1939.
11. Davidson, Kenneth S. M.: Resistance and Powering. Detailed Considerations - Skin Friction. Vol. II of Principles of Naval Architecture, ch. II, pt. 2, sec. 7, Henry E. Rossell and Lawrence B. Chapman, eds., Soc. Naval Arch. and Marine Eng., 1939, pp. 76-83.

TABLE I

EXPERIMENTAL DATA OBTAINED FOR A PLANING SURFACE HAVING A 20° ANGLE OF DEAD RISE AND HORIZONTAL CHINE FLARE
 LANGLEY TANK MODEL 276A

Average kinematic viscosity = 15.35×10^{-6} ft²/sec; specific weight of tank water = 63.4 lb/cu ft

α (deg)	C _A	C _V	C _R	$\frac{l_a}{b}$	$\frac{l_m}{b}$	$\frac{l_k}{b}$	$\frac{l_D}{b}$	$\frac{d}{b}$	C _{Lb}	C _{Db}	C _{Ls}	C _{Ds}
2	0.85	7.32	0.34	1.62	3.00	4.38	1.80	0.10	0.0318	0.0126	0.011	0.0042
2	.85	7.62	.43	1.40	2.78	4.15	---	---	.0292	.0147	.010	.0053
2	.85	9.09	.37	.28	1.61	2.95	---	---	.0206	.0089	.013	.0055
2	.85	9.15	.37	.38	1.75	3.12	1.26	.10	.0203	.0088	.012	.0050
2	.85	9.15	.37	.25	1.63	3.00	1.86	.08	.0203	.0085	.012	.0052
2	.85	9.18	.38	.50	1.88	3.25	1.29	---	.0202	.0091	.011	.0048
2	1.49	8.54	.78	3.75	5.12	6.50	---	.21	.0409	.0214	.008	.0042
2	1.49	10.68	.67	1.00	2.48	3.95	---	.13	.0262	.0117	.010	.0047
2	2.13	9.76	1.02	3.75	5.13	6.50	3.15	.21	.0446	.0204	.009	.0040
2	2.13	9.76	1.12	4.25	5.91	7.08	---	.24	.0446	.0236	.008	.0040
2	2.13	11.59	1.02	2.12	3.58	5.02	---	.17	.0318	.0152	.009	.0042
2	2.13	12.20	.86	1.12	2.50	3.88	1.53	.11	.0286	.0115	.011	.0046
2	2.13	12.44	---	1.25	2.69	4.12	---	---	.0274	---	.010	---
2	2.13	12.44	.98	---	---	---	---	.14	.0274	.0126	---	---
2	2.13	14.49	.97	.12	1.50	2.88	1.56	---	.0203	.0092	.013	.0061
2	2.13	14.49	.92	.25	1.63	3.00	1.08	.10	.0203	.0088	.012	.0054
2	4.26	13.54	2.12	4.38	5.75	7.12	4.02	---	.0462	.0230	.008	.0040
2	4.26	13.76	2.05	4.00	5.50	6.88	3.69	.24	.0450	.0217	.008	.0039
2	4.26	16.01	1.82	2.00	3.35	4.70	2.16	---	.0332	.0141	.010	.0042
2	4.26	16.32	1.81	1.75	3.13	4.50	2.01	.15	.0318	.0132	.010	.0042
2	4.26	18.36	1.73	.65	2.03	3.40	1.26	---	.0252	.0104	.012	.0051
2	4.26	18.70	1.71	.92	2.30	3.68	1.26	.11	.0244	.0097	.011	.0042
2	4.26	19.88	1.71	.45	1.83	3.20	1.26	.08	.0216	.0086	.012	.0047
2	4.26	19.89	1.76	.55	1.86	3.18	.42	---	.0216	.0089	.012	.0048
2	4.26	20.34	1.82	.25	1.61	2.97	1.20	---	.0206	.0088	.013	.0054
2	6.39	15.71	3.27	5.62	7.00	8.38	4.80	---	.0518	.0264	.007	.0038
2	6.39	16.62	3.23	4.70	6.08	7.45	4.14	---	.0480	.0234	.008	.0038
2	6.39	16.78	3.29	4.62	6.00	7.58	4.41	.25	.0454	.0231	.008	.0039
2	6.39	16.99	3.19	4.12	5.50	6.88	4.02	.22	.0444	.0222	.008	.0040
2	6.39	16.99	3.13	4.12	5.50	6.88	3.81	.25	.0444	.0217	.008	.0039
2	6.39	17.32	3.14	3.75	5.09	6.42	3.81	---	.0426	.0209	.008	.0041
2	6.39	17.45	3.05	3.75	5.13	6.50	3.60	.21	.0420	.0200	.008	.0039
2	6.39	18.30	2.99	3.05	4.43	5.78	3.12	---	.0383	.0177	.009	.0040
2	6.39	18.39	2.83	3.62	4.00	5.38	2.67	.18	.0380	.0167	.009	.0042
2	6.39	18.60	2.73	2.38	3.75	5.12	2.70	.16	.0370	.0158	.010	.0042
2	6.39	19.96	2.63	1.75	3.73	4.50	2.37	.14	.0323	.0133	.009	.0036
2	6.39	21.81	2.53	.75	2.12	3.50	1.68	---	.0268	.0106	.013	.0050
2	6.39	21.87	2.41	.88	2.19	3.50	1.35	---	.0267	.0100	.012	.0046
2	6.39	22.97	2.51	.62	2.00	3.37	1.23	.10	.0242	.0095	.012	.0047
2	6.39	24.95	2.74	.37	1.79	3.20	.99	---	.0205	.0088	.011	.0049
2	6.39	24.98	2.64	.25	1.62	3.00	1.41	---	.0205	.0085	.013	.0052
2	10.65	21.87	5.29	4.75	6.13	7.50	4.41	---	.0444	.0221	.007	.0036
2	10.65	23.18	4.92	3.38	4.75	6.12	3.51	.21	.0398	.0183	.008	.0038
2	10.65	25.07	4.53	2.22	3.61	5.00	2.43	---	.0338	.0144	.009	.0040
2	.85	6.10	.11	.63	1.25	1.88	.36	.14	.0457	.0059	.036	.0047
2	.85	6.10	.13	.35	.99	1.62	---	---	.0457	.0070	.046	.0071
2	.85	6.10	.19	.55	1.21	1.88	---	.14	.0457	.0102	.038	.0084
2	2.13	7.26	.40	2.43	3.08	3.72	2.01	.25	.0810	.0151	.026	.0049
2	2.13	9.18	.45	.47	1.10	1.75	.48	---	.0507	.0107	.046	.0097
2	2.13	10.77	.40	.12	.82	1.52	.66	---	.0368	.0069	.045	.0084
2	2.13	12.44	.40	0	.72	1.45	---	.10	.0274	.0052	.038	.0070
2	2.98	7.62	.65	3.75	4.38	5.00	---	.36	.1027	.0224	.023	.0051
2	2.98	7.62	.65	4.00	4.62	5.25	---	.34	.1027	.0224	.022	.0048
2	4.26	10.16	.97	2.30	2.96	3.62	1.95	---	.0825	.0188	.028	.0063
2	4.26	13.72	.71	1.09	1.72	2.12	.57	.09	.0452	.0075	.042	.0069
2	6.39	10.13	1.60	5.40	6.10	6.80	4.02	.45	.1240	.0311	.020	.0051
2	6.39	12.57	1.32	2.33	3.00	3.68	2.10	.23	.0810	.0168	.027	.0056
2	6.39	16.78	1.18	.40	1.06	1.72	.78	.10	.0454	.0084	.043	.0079
2	6.39	19.88	1.18	.05	.76	1.48	.24	---	.0324	.0060	.042	.0079
2	10.65	12.81	2.48	5.70	6.36	7.02	4.29	.48	.1297	.0302	.020	.0047
2	10.65	14.64	2.31	3.68	4.30	4.92	3.03	.08	.0989	.0226	.023	.0050
2	10.65	16.26	2.10	2.25	2.90	3.55	1.95	.23	.0807	.0159	.028	.0055
2	10.65	16.40	2.14	2.05	2.68	3.30	2.02	.24	.0792	.0159	.029	.0059
2	10.65	20.19	1.66	.75	1.40	2.05	.81	---	.0525	.0082	.037	.0058
2	10.65	25.30	1.05	.05	.68	1.30	.59	.11	.0333	.0066	.049	.0097
2	19.17	17.38	4.60	5.63	6.30	6.98	4.08	.48	.1270	.0304	.020	.0048
2	19.17	21.90	3.85	2.30	2.96	3.63	2.10	.23	.0800	.0160	.027	.0054
2	19.17	25.00	3.45	1.20	1.88	2.55	1.21	---	.0614	.0111	.033	.0059
2	27.69	19.70	6.61	6.63	7.25	7.88	4.91	---	.1425	.0341	.020	.0047
2	27.69	25.00	5.68	2.63	3.25	3.88	2.32	---	.0885	.0182	.027	.0056
2	36.21	21.70	8.74	7.13	7.75	8.38	5.36	---	.1540	.0372	.020	.0048
2	36.21	24.30	8.16	5.00	5.62	6.26	4.06	---	.1230	.0277	.022	.0049



TABLE I - Continued

EXPERIMENTAL DATA OBTAINED FOR A PLANING SURFACE HAVING A 20° ANGLE OF DEAD RISE AND HORIZONTAL CHINE FLARE
 LANGLEY TANK MODEL 276A - Continued

τ (deg)	C_{Δ}	C_Y	C_R	$\frac{l_G}{b}$	$\frac{l_M}{b}$	$\frac{l_K}{b}$	$\frac{l_P}{b}$	$\frac{d}{b}$	C_{L_b}	C_{D_b}	C_{L_S}	C_{D_S}
6	0.85	6.10	0.13	0.15	0.59	1.02	0.33	0.10	0.0456	0.0070	0.077	0.0118
6	2.13	6.04	.40	1.87	2.31	2.75	1.11	---	.1170	.0220	.051	.0095
6	2.13	7.20	.38	.72	1.14	1.55	.78	.14	.0820	.0146	.072	.0128
6	2.13	9.15	.36	.22	.69	1.15	.18	.14	.0509	.0086	.074	.0125
6	4.26	9.15	.73	1.25	1.70	2.15	.21	.21	.1018	.0174	.060	.0102
6	5.11	7.62	.82	3.48	3.91	4.35	---	.44	.1761	.0283	.045	.0072
6	10.65	9.15	2.03	6.20	6.61	7.02	4.08	.72	.2545	.0485	.038	.0073
6	10.65	12.90	1.88	1.98	2.44	2.90	1.62	.28	.1280	.0226	.052	.0093
6	10.65	12.90	1.84	2.05	2.48	2.92	1.71	---	.1280	.0221	.052	.0089
6	10.65	16.29	1.76	.52	.95	1.38	.69	.15	.0802	.0133	.083	.0140
6	10.65	22.00	2.01	0	.44	.88	.78	.15	.0433	.0082	.098	.0186
6	10.65	25.00	1.89	0	.44	.88	.24	.06	.0341	.0060	.077	.0137
6	10.65	25.00	2.01	0	.49	.98	.09	---	.0341	.0064	.070	.0131
6	19.17	12.44	3.79	6.64	7.09	7.50	4.74	.85	.2470	.0489	.035	.0069
6	19.17	12.44	3.79	6.60	7.03	7.45	4.68	---	.2450	.0488	.035	.0069
6	19.17	14.30	3.64	4.12	4.56	5.00	3.15	---	.1875	.0356	.041	.0078
6	19.17	14.30	3.74	4.18	4.63	5.08	3.24	---	.1826	.0356	.041	.0077
6	19.17	21.72	3.11	.45	.94	1.42	.73	.16	.0812	.0132	.086	.0140
6	19.17	24.77	3.01	.30	.71	1.12	.47	.14	.0625	.0098	.088	.0138
6	19.17	25.30	3.11	.38	.81	1.25	.48	.08	.0599	.0097	.074	.0120
6	36.21	17.10	7.54	6.62	6.99	7.35	4.83	---	.2480	.0516	.035	.0074
6	36.21	20.10	6.82	4.05	4.45	4.85	3.15	.45	.1744	.0337	.039	.0076
6	36.21	20.20	6.82	3.88	4.32	4.75	3.12	.47	.1775	.0334	.041	.0070
6	36.21	23.91	6.41	2.10	2.59	3.08	1.73	.28	.1270	.0224	.049	.0087
6	36.21	25.00	6.31	---	---	---	1.50	.24	.1160	.0202	---	---
6	36.21	25.10	6.17	1.57	2.03	2.48	1.43	.25	.1150	.02196	.057	.0096
6	36.21	25.51	10.53	5.00	5.44	5.88	3.82	.61	.2085	.0412	.038	.0076
6	53.25	24.03	10.28	4.10	4.51	4.92	3.14	.50	.1842	.0356	.041	.0079
6	53.25	24.19	10.35	4.38	4.78	5.18	3.27	.53	.1822	.0354	.038	.0074
6	53.25	24.25	10.10	3.92	4.36	4.80	3.21	.49	.1815	.0343	.042	.0079
6	53.25	24.77	10.06	3.90	4.40	4.90	3.05	.47	.1738	.0328	.040	.0075
6	53.25	24.92	10.04	3.55	3.99	4.42	2.86	.43	.1715	.0323	.043	.0081
6	53.25	24.95	9.98	3.57	3.99	4.40	2.72	.44	.1710	.0321	.043	.0080
6	70.29	23.88	14.06	6.90	6.33	6.75	4.70	.80	.2470	.0493	.034	.0067
6	70.29	25.01	14.06	5.98	6.33	6.72	4.34	.46	.2245	.0448	.035	.0071
6	.85	3.60	.19	.50	.68	.88	.14	.14	.1314	.0293	.193	.0431
12	.85	3.69	.19	.46	.68	.88	.24	.12	.1248	.0279	.215	.0481
12	.85	4.51	.22	.25	.44	.63	.06	.09	.0836	.0218	.190	.0491
12	.85	4.58	.26	---	---	---	---	.09	.0811	.0248	---	---
12	.85	4.64	.20	.18	.36	.55	---	.08	.0790	.0186	.219	.0517
12	2.13	3.05	.48	3.13	3.36	3.59	---	---	.4580	.1033	.136	.0307
12	2.13	3.29	.53	2.95	3.14	3.32	---	.66	.3940	.0980	.125	.0312
12	2.13	3.36	.50	2.85	3.04	3.22	2.01	---	.3770	.0885	.124	.0291
12	2.13	4.06	.55	1.82	2.01	2.20	---	.38	.2580	.0668	.128	.0332
12	2.13	4.21	.50	1.81	2.01	2.00	---	.37	.2410	.0561	.133	.0310
12	2.13	4.27	.48	1.42	1.61	1.80	.90	---	.2340	.0526	.145	.0327
12	2.13	4.58	.54	---	---	---	---	.24	.2032	.0515	---	---
12	2.13	4.73	.52	.90	1.06	1.22	---	.22	.1910	.0465	.180	.0439
12	2.13	4.85	.46	.82	1.01	1.20	.45	---	.1810	.0391	.179	.0387
12	2.13	5.79	.46	.38	.58	.75	---	---	.1270	.0274	.227	.0489
12	2.13	5.89	.46	.35	.54	.72	.30	---	.1228	.0265	.227	.0490
12	2.13	5.95	.48	.35	.53	.72	.30	---	.1203	.0271	.204	.0459
12	2.13	5.95	.46	.38	.56	.75	.30	.12	.1203	.0260	.215	.0465
12	2.13	7.20	.47	.12	.31	.50	.21	---	.0822	.0181	.265	.0584
12	2.13	7.26	.52	.12	.34	.55	---	.08	.0808	.0197	.237	.0579
12	2.13	9.15	.56	0	.25	.50	---	---	.5090	.1034	.203	.0413
12	4.26	6.10	1.00	---	---	---	---	.30	.2285	.0538	---	---
12	6.39	6.10	1.49	---	---	---	---	.33	.3430	.0800	---	---
12	6.39	8.94	1.45	.52	.73	.93	.57	.17	.1600	.0363	.219	.0497
12	6.39	10.06	1.41	.58	.56	.75	.27	.12	.1265	.0279	.226	.0498
12	6.39	10.12	1.44	.25	.49	.72	.27	.12	.1250	.0282	.255	.0575
12	6.39	12.38	1.44	.12	.31	.50	.12	.08	.0832	.0188	.269	.0607
12	6.39	12.50	1.48	.10	.34	.56	.12	.10	.0816	.0190	.240	.0559
12	6.39	12.50	1.44	.15	.39	.62	.30	---	.0816	.0184	.209	.0472
12	10.65	7.62	2.49	2.75	2.91	3.08	---	.62	.3666	.0858	.126	.0295
12	10.65	9.09	2.46	1.50	1.69	1.88	1.24	.35	.2578	.0596	.153	.0355
12	10.65	9.15	2.46	1.50	1.69	1.88	1.38	.32	.2540	.0588	.150	.0348
12	10.65	9.21	2.47	1.50	1.69	1.88	1.11	.34	.2510	.0583	.148	.0345
12	10.65	10.77	2.45	.88	1.06	1.25	.69	.20	.1833	.0421	.089	.0203
12	10.65	12.96	2.47	.78	.96	1.15	.39	.13	.1270	.0294	.132	.0306
12	10.65	16.17	2.37	.20	.30	.58	.18	.10	.0814	.0181	.209	.0464
12	10.65	16.32	2.42	.08	.26	.45	.09	.08	.0800	.0182	.308	.0700

TABLE I - Continued

EXPERIMENTAL DATA OBTAINED FOR A PLANING SURFACE HAVING A 20° ANGLE OF DEAD RISE AND HORIZONTAL CHINE FLARE

LANGLEY TANK MODEL 276A - Continued

τ (deg)	C_D	C_V	C_R	$\frac{l_a}{b}$	$\frac{l_B}{b}$	$\frac{l_K}{b}$	$\frac{l_P}{b}$	$\frac{d}{b}$	C_{Lb}	C_{Db}	C_{Lb}	C_{Db}
12	10.65	21.75	2.45	0	0.19	0.38	0.21	0.07	0.0450	0.0104	0.237	0.0548
12	19.17	8.63	4.48	4.52	4.71	4.90	3.27	.99	.5150	.1203	.109	.0256
12	19.17	9.55	4.53	3.42	3.63	3.83	2.60	.76	.4214	.0993	.116	.0274
12	19.17	9.73	4.50	3.35	3.55	3.75	2.43	----	.4060	.0952	.114	.0268
12	19.17	10.46	4.47	2.50	2.70	2.90	2.01	.57	.3512	.0819	.130	.0303
12	19.17	10.74	4.70	2.38	2.56	2.75	1.87	.53	.3320	.0780	.130	.0305
12	19.17	12.44	4.40	1.45	1.65	1.85	1.20	.53	.2472	.0568	.150	.0344
12	19.17	12.51	4.47	1.40	1.58	1.80	1.32	.33	.2450	.0571	.155	.0362
12	19.17	14.58	4.34	.75	.95	1.15	.79	.22	.1804	.0408	.190	.0430
12	19.17	14.58	4.20	.80	1.00	1.20	.64	.21	.1804	.0395	.180	.0395
12	19.17	17.08	4.39	.42	.62	.82	.24	.14	.1316	.0301	.212	.0486
12	19.17	17.26	4.32	.42	.66	.90	.39	.12	.1290	.0291	.196	.0441
12	19.17	17.39	4.25	.40	.59	.78	.33	.15	.1270	.0282	.215	.0478
12	19.17	17.54	4.28	.45	.64	.82	.36	----	.1246	.0278	.195	.0435
12	19.17	17.60	4.28	.40	.58	.75	.36	----	.1240	.0276	.214	.0476
12	19.17	24.86	4.28	0	.31	.63	.21	.10	.0621	.0139	.201	.0449
12	27.69	13.82	6.33	1.92	2.11	2.30	1.46	.44	.2900	.0663	.137	.0314
12	27.69	16.78	6.40	.92	1.10	1.28	.79	.24	.1968	.0455	.179	.0413
12	27.69	24.77	6.44	.18	.36	.55	.34	----	.0902	.0210	.251	.0584
12	36.21	11.99	8.53	4.68	4.85	5.03	3.22	.99	.5030	.1187	.104	.0244
12	36.21	12.35	8.80	4.22	4.41	4.60	2.55	----	.4750	.1156	.108	.0262
12	36.21	12.96	8.73	3.75	3.94	4.12	2.66	----	.4320	.1040	.110	.0264
12	36.21	14.98	8.28	2.40	2.59	2.78	1.75	.53	.3230	.0738	.125	.0285
12	36.21	15.10	8.42	2.45	2.64	2.83	1.70	----	.3175	.0738	.120	.0279
12	36.21	15.19	8.58	2.30	2.48	2.65	1.82	.55	.3140	.0745	.127	.0300
12	36.21	24.86	8.19	.54	.74	.94	.31	.15	.1174	.0265	.218	.0491
12	53.25	14.58	12.87	4.95	5.14	5.32	3.43	1.06	.5020	.1211	.098	.0236
12	53.25	16.04	12.99	3.50	3.69	3.88	2.54	.74	.4140	.1010	.112	.0274
12	53.25	16.17	12.98	3.35	3.51	3.68	2.38	.69	.4068	.0992	.116	.0282
12	53.25	16.17	12.74	3.50	3.69	3.88	2.52	.80	.4068	.0973	.110	.0263
12	53.25	18.30	12.33	2.32	2.51	2.70	1.78	.53	.3180	.0736	.127	.0293
12	53.25	20.80	12.53	1.45	1.64	1.82	1.15	.34	.2464	.0580	.150	.0354
12	53.25	24.10	12.52	.85	1.01	1.12	.69	.20	.1836	.0430	.188	.0426
12	53.25	24.58	12.51	.70	.89	1.08	.62	.17	.1764	.0413	.198	.0464
12	53.25	24.77	12.27	.48	.69	.90	.61	.17	.1740	.0401	.252	.0581
12	70.29	16.68	17.24	4.88	5.06	5.25	3.41	1.06	.5070	.1240	.100	.0245
12	70.29	18.61	16.87	3.60	3.79	3.98	2.58	.78	.4060	.0975	.107	.0257
12	70.29	20.80	16.99	2.28	2.45	2.62	1.79	.48	.3250	.0785	.133	.0320
12	70.29	20.91	16.70	2.30	2.49	2.68	1.75	.46	.3216	.0765	.129	.0307
12	70.29	23.79	16.46	1.48	1.64	1.80	1.15	.33	.2480	.0581	.151	.0355
12	70.29	24.92	16.41	1.30	1.48	1.65	.98	.28	.2270	.0529	.154	.0357
12	87.33	20.68	21.36	3.42	3.57	3.72	2.50	.72	.4080	.0998	.114	.0280
12	87.33	23.45	21.12	2.52	2.67	2.70	1.72	.52	.3170	.0768	.126	.0305
12	87.33	25.16	21.19	1.88	2.04	2.20	1.43	.41	.2755	.0670	.135	.0329
18	.85	3.66	.30	.25	.36	.48	----	.04	.1270	.0446	.352	.1240
18	.85	3.69	.32	.20	.36	.52	.39	----	.1250	.0430	.348	.1330
18	.85	4.58	.30	.10	.21	.32	----	.01	.0811	.0286	.376	.1360
18	.85	4.64	.30	.05	.24	.42	----	----	.0792	.0279	.330	.1160
18	2.13	2.90	.73	2.05	2.19	2.32	----	----	.5070	.1736	.232	.0794
18	2.13	2.90	.71	2.12	2.24	2.35	1.36	.66	.5070	.1680	.226	.0750
18	2.13	3.23	.73	1.60	1.71	1.82	.99	.50	.4100	.1392	.239	.0815
18	2.13	3.36	.71	1.45	1.56	1.68	.78	.50	.3780	.1257	.242	.0805
18	2.13	4.06	.74	.88	.99	1.10	.84	----	.2580	.0900	.260	.0910
18	2.13	4.15	.72	.75	.86	.98	.34	.24	.2478	.0832	.288	.0966
18	2.13	4.21	.72	.70	.81	.92	.11	----	.2408	.0808	.298	.0998
18	2.13	4.82	.73	.48	.59	.70	.12	----	.1836	.0634	.311	.1075
18	2.13	4.85	.72	.40	.51	.62	.21	.15	.1812	.0613	.356	.1200
18	2.13	4.85	.70	.40	.54	.68	.36	----	.1812	.0595	.336	.1101
18	2.13	5.82	.67	.18	.29	.40	----	.13	.1260	.0395	.435	.1362
18	2.13	7.38	.72	0	.11	.22	.57	----	.0785	.0265	.714	.2410
18	6.39	5.09	2.19	2.12	2.22	2.32	1.50	----	.4940	.1690	.222	.0761
18	6.39	6.41	2.14	1.32	1.44	1.55	.32	----	.3090	.1042	.215	.0724
18	6.39	8.48	2.19	.50	.52	.65	.57	----	.1772	.0610	.341	.1172
18	6.39	9.94	2.17	.18	.31	.45	.19	.13	.1294	.0441	.417	.1423
18	6.39	10.37	2.13	.20	.31	.42	----	.08	.1190	.0395	.384	.1275
18	6.39	12.51	2.11	0	.11	.22	----	.05	.0816	.0269	.743	.2445
18	10.65	6.47	3.63	2.20	2.31	2.42	1.59	----	.5100	.1734	.221	.0751
18	10.65	8.17	3.55	1.10	1.25	1.40	.99	----	.3200	.1064	.256	.0852
18	10.65	9.33	3.51	.60	.72	.85	.46	.21	.2460	.0808	.342	.1121
18	10.65	9.36	3.53	.68	.79	.90	.49	.25	.2440	.0804	.309	.1018
18	10.65	12.99	3.49	.18	.29	.40	.01	.10	.1266	.0415	.436	.1429
18	10.65	16.23	3.54	.10	.21	.32	.05	.10	.0812	.0270	.387	.1287



TABLE I - Continued

EXPERIMENTAL DATA OBTAINED FOR A PLANING SURFACE HAVING A 20° ANGLE OF DEAD RISE AND HORIZONTAL CHINE FLARE
 LANGLEY TANK MODEL 276A - Continued

α (deg)	C_{Δ}	C_V	C_R	$\frac{l_a}{b}$	$\frac{l_B}{b}$	$\frac{l_K}{b}$	$\frac{l_P}{b}$	$\frac{d}{b}$	C_{L_b}	C_{D_b}	C_{L_S}	C_{D_S}
18	19.17	8.69	6.54	2.25	2.36	2.48	1.50	0.67	0.5100	0.1736	0.216	0.0735
18	19.17	9.76	6.52	1.50	1.71	1.82	1.09	.46	.4032	.1371	.236	.0802
18	19.17	10.77	6.43	1.08	1.19	1.30	.79	.31	.3310	.1108	.278	.0931
18	19.17	12.35	6.37	.70	.81	.92	.48	.22	.2520	.0833	.311	.1030
18	19.17	12.60	6.26	.72	1.21	1.70	.56	---	.2420	.0792	.200	.0655
18	19.17	14.40	6.32	.42	.54	.65	.37	.14	.1848	.0608	.342	.1125
18	19.17	16.84	6.29	.25	.36	.48	.30	.10	.1350	.0444	.375	.1230
18	19.17	17.31	6.44	.15	.30	.45	.21	.11	.1278	.0429	.426	.1430
18	19.17	21.84	6.31	0	.11	.22	.13	.05	.0804	.0274	.730	.2450
18	27.69	10.52	9.33	2.20	2.32	2.45	1.62	---	.5000	.1680	.216	.0724
18	27.69	12.20	9.26	1.38	1.60	1.82	1.11	---	.3630	.1250	.227	.0781
18	27.69	13.18	9.30	1.10	1.24	1.38	.96	---	.3200	.1075	.258	.0866
18	27.69	13.72	9.12	.92	1.04	1.15	.64	.29	.2940	.0968	.283	.0931
18	27.69	13.73	9.14	.92	1.04	1.15	.66	.26	.2930	.0970	.282	.0933
18	27.69	16.78	9.10	.45	.56	.68	.37	.15	.1972	.0647	.352	.1155
18	27.69	24.92	9.23	.08	.22	.38	.11	.06	.0894	.0280	.408	.1273
18	36.21	11.77	12.24	2.25	2.36	2.48	1.53	.67	.5250	.1761	.222	.0746
18	36.21	11.90	12.22	2.22	2.34	2.45	1.56	.65	.5120	.1725	.219	.0739
18	36.21	13.27	12.08	1.60	1.71	1.82	1.13	.46	.4130	.1370	.242	.0801
18	36.21	14.94	12.02	1.12	1.24	1.35	.76	---	.3248	.1075	.262	.0867
18	36.21	17.38	12.04	.65	.76	.88	.50	---	.2394	.0800	.315	.1050
18	36.21	20.25	11.89	.30	.41	.52	.34	.12	.1764	.0580	.430	.1415
18	36.21	24.28	12.11	.20	.35	.50	.24	.08	.1230	.0412	.352	.1176
18	36.21	24.95	12.00	.05	.16	.28	.15	.08	.1162	.0387	.726	.2420
18	53.25	14.33	18.03	2.25	2.36	2.48	1.67	.68	.5185	.1750	.220	.0742
18	53.25	14.43	17.91	2.25	2.36	2.48	1.57	---	.5100	.1715	.216	.0727
18	53.25	15.96	18.00	1.60	1.72	1.85	1.18	.48	.4176	.1412	.243	.0812
18	53.25	16.26	17.75	1.50	1.61	1.72	1.08	---	.4013	.1345	.250	.0835
18	53.25	18.14	17.50	1.02	1.11	1.20	.79	.30	.3220	.1059	.281	.0954
18	53.25	18.21	17.64	1.10	1.21	1.32	1.03	---	.3200	.1058	.264	.0870
18	53.25	21.01	17.68	.75	.86	.98	.55	.18	.2408	.0800	.280	.0930
18	53.25	24.18	17.41	.50	.61	.72	.32	.14	.1820	.0598	.299	.0995
18	53.25	24.81	17.80	.40	.51	.62	.33	.05	.1721	.0578	.338	.1133
18	53.25	25.16	17.31	.38	.49	.60	.29	.13	.1680	.0549	.344	.1120
18	70.29	16.76	23.80	2.05	2.16	2.28	1.52	.60	.5000	.1693	.231	.0785
18	70.29	18.30	23.58	1.58	1.69	1.80	1.15	.49	.4175	.1410	.247	.0835
18	70.29	20.92	23.27	1.00	1.11	1.22	.79	.30	.3205	.1068	.299	.0961
18	70.29	23.72	23.24	.78	.89	1.00	.58	.22	.2495	.0827	.280	.0930
18	70.29	23.94	23.31	.65	.79	.92	.52	.18	.2450	.0812	.310	.1028
18	70.29	25.00	23.15	.52	.64	.75	.47	.14	.2244	.0740	.351	.1157
18	70.29	25.01	23.66	.50	.61	.72	.49	.19	.2238	.0756	.367	.1240
18	87.33	18.54	29.78	2.00	2.14	2.27	1.62	---	.5020	.1714	.246	.0802
18	87.33	18.85	29.30	2.08	2.19	2.30	1.53	.60	.4900	.1650	.224	.0753
18	87.33	20.74	29.39	1.55	1.66	1.78	1.16	.46	.4050	.1363	.244	.0821
18	87.33	20.77	29.34	2.15	2.31	2.47	1.17	---	.4050	.1360	.175	.0589
18	87.33	23.61	29.52	1.00	1.11	1.22	.78	.33	.3120	.1059	.281	.0953
18	87.33	25.32	29.15	.78	.89	1.00	.65	.24	.2720	.0910	.306	.1023
24	.85	3.66	.38	.17	.26	.34	.14	.08	.1270	.0566	.490	.2180
24	.85	4.58	.93	0	.08	.16	---	.07	.0812	.0363	---	---
24	2.13	3.20	.38	1.07	1.16	1.24	.64	.39	.4150	.1810	.358	.1560
24	2.13	4.88	.94	.30	.38	.46	.11	.12	.1790	.0792	.471	.2080
24	2.13	7.32	.95	.03	.14	.25	---	.09	.0795	.0356	.576	.2580
24	10.65	9.03	4.81	.46	.54	.62	.34	.19	.2620	.1182	.485	.2190
24	19.17	8.69	8.70	1.45	1.53	1.61	.97	.52	.5100	.2310	.333	.1510
24	19.17	9.64	8.67	1.02	1.10	1.18	.72	.39	.4300	.1868	.390	.1698
24	19.17	12.38	8.65	.47	.55	.62	.28	.19	.2600	.1130	.474	.2050
24	19.17	12.50	8.54	.45	.55	.65	.31	---	.2550	.1093	.464	.1980
24	19.17	16.26	8.61	.20	.31	.43	.05	.14	.1505	.0650	.484	.2090
24	19.17	17.39	8.65	.12	.23	.34	.13	.13	.1314	.0572	.572	.2490
24	36.21	11.99	16.20	1.36	1.43	1.50	.94	.56	.5055	.2250	.353	.1570
24	36.21	15.04	16.10	.66	.76	.86	.47	.32	.3200	.1426	.421	.1870
24	36.21	17.14	16.23	.50	.57	.66	.29	.23	.2460	.1100	.433	.1930
24	36.21	19.98	16.06	.30	.39	.48	.22	.12	.1820	.0808	.466	.2070
24	36.21	20.07	15.84	.30	.36	.42	.27	---	.1800	.0786	.500	.2180
24	36.21	22.05	15.80	.22	.31	.39	.24	---	.1490	.0648	.480	.2080
24	36.21	24.89	15.79	.15	.23	.31	.09	---	.1170	.0508	.508	.2200
24	53.25	14.49	24.05	1.41	1.48	1.55	.97	---	.5100	.2298	.344	.1550
24	53.25	18.30	23.92	.74	.82	.90	.50	.32	.3180	.1422	.388	.1740
24	53.25	18.39	23.74	.71	.81	.90	.49	.32	.3150	.1406	.389	.1740
24	53.25	20.68	23.76	.50	.56	.62	.37	.16	.2480	.1110	.443	.1980
24	53.25	25.07	23.65	.30	.40	.50	.19	.12	.1690	.0753	.422	.1880

TABLE I - Concluded

EXPERIMENTAL DATA OBTAINED FOR A PLANING SURFACE HAVING A 20° ANGLE OF DEAD RISE AND HORIZONTAL CHINE FLARE
 LANGLEY TANK MODEL 276A - Concluded

τ (deg)	C_A	C_V	C_R	$\frac{l_c}{b}$	$\frac{l_m}{b}$	$\frac{l_k}{b}$	$\frac{l_p}{b}$	$\frac{d}{b}$	C_{Lb}	C_{Db}	C_{Ls}	C_{Ds}
24	70.29	16.78	31.40	1.42	1.51	1.59	0.94	0.55	0.5000	0.2230	0.331	0.1477
24	70.29	18.54	31.36	1.03	1.12	1.19	.73	.45	.4080	.1814	.364	.1620
30	.85	3.74	.52	.15	.21	.28	.35	.09	.1215	.0743	.570	.3490
30	.85	4.61	.52	.02	.09	.15	.07	.09	.0800	.0489	---	---
30	.85	4.64	.52	.10	.15	.20	---	---	.0790	.0484	.527	.3230
30	2.13	3.29	1.24	.85	.92	.97	.72	.34	.3930	.2290	.427	.2490
30	2.13	4.85	1.25	.32	.39	.45	.27	.12	.1810	.1064	.466	.2740
30	2.13	7.29	1.32	.08	.14	.20	.17	.06	.0802	.0498	.572	.3550
30	10.65	9.33	6.23	.39	.45	.50	.32	.22	.2450	.1433	.544	.3190
30	10.65	16.32	6.15	.05	.14	.23	---	---	.0798	.0461	.583	.3370
30	10.65	18.36	6.17	0	.08	.15	.06	---	.0632	.0366	---	---
30	19.17	8.75	11.11	1.15	1.22	1.27	.67	.53	.5000	.2770	.411	.2270
30	19.17	12.44	11.15	.48	.54	.60	.23	.16	.2470	.1440	.460	.2680
30	19.17	12.44	10.99	.40	.46	.52	.40	---	.2470	.1420	.539	.3090
30	19.17	17.58	11.10	.11	.20	.29	---	.08	.1240	.0719	.621	.3590
30	19.17	21.96	10.84	.12	.18	.22	.04	.05	.0796	.0450	.432	.2500
30	19.17	25.01	11.44	0	.05	.10	---	.06	.0612	.0366	---	---
30	36.21	11.96	20.98	1.11	1.16	1.21	.72	.43	.5060	.2930	.436	.2520
30	36.21	12.05	20.91	1.12	1.19	1.25	.71	---	.4980	.2870	.419	.2510
30	36.21	14.94	20.94	.55	.63	.71	---	---	.3250	.1878	.516	.2980
30	36.21	15.25	20.55	.62	.68	.72	.39	---	.3110	.1766	.457	.2600
30	36.21	16.44	20.81	.46	.50	.53	.30	---	.2680	.1542	.537	.3090
30	36.21	16.53	20.31	.50	.55	.60	.30	---	.2642	.1485	.481	.2700
30	36.21	19.83	21.00	.23	.31	.39	.22	.13	.1844	.1070	.595	.3450
30	36.21	24.86	20.77	.12	.23	.33	.16	.06	.1170	.0673	.520	.2980



TABLE II

SUPPLEMENTARY EXPERIMENTAL DATA OBTAINED AT LOW SPEEDS FOR LANGLEY TANK MODEL 276A

[Average kinematic viscosity = 15.35×10^{-6} ft²/sec; specific weight of tank water = 63.4 lb/cu ft]

τ (deg)	C_A	C_V	C_R	$\frac{z_s}{b}$	$\frac{z_M}{b}$	$\frac{z_K}{b}$	$\frac{z_P}{b}$	$\frac{d}{b}$	C_{Lb}	C_{Db}	C_{Ls}	C_{Ds}
2	0.85	3.05	0.27	---	---	---	---	0.28	0.1820	0.0582	---	---
2	.85	3.66	.30	---	---	---	---	.26	.1270	.0448	---	---
2	.85	3.66	.24	4.87	6.25	7.62	3.06	.26	.1270	.0358	.020	.0057
2	.85	3.69	.23	5.12	6.50	7.88	2.70	.26	.1240	.0338	.019	.0052
2	.85	4.58	.27	4.12	5.50	6.88	2.88	.24	.0808	.0257	.015	.0047
2	.85	4.58	.28	4.12	5.50	6.88	2.94	---	.0808	.0270	.015	.0049
2	.85	4.58	.35	4.75	6.12	7.50	---	.25	.0808	.0334	.013	.0054
2	.85	4.64	.31	4.60	5.96	7.30	1.11	---	.0790	.0288	.013	.0048
2	.85	5.18	.34	---	---	---	---	---	.0635	.0254	---	---
2	.85	5.18	.32	---	---	---	---	---	.0635	.0238	---	---
2	.85	6.10	.43	3.00	4.30	5.60	1.74	---	.0456	.0231	.010	.0054
2	.85	6.13	.35	2.25	3.63	5.00	2.52	---	.0450	.0186	.012	.0051
2	.85	6.28	.37	2.38	3.75	5.12	---	.20	.0430	.0188	.011	.0050
2	.85	6.41	.43	3.00	4.38	5.75	---	.19	.0415	.0210	.009	.0048
2	1.49	6.71	.74	---	---	---	---	.29	.0663	.0328	---	---
2	1.49	7.32	.74	5.12	6.44	7.75	---	.27	.0557	.0290	.009	.0045
2	2.13	8.54	1.13	5.75	7.00	8.25	---	.30	.0584	.0310	.008	.0044
2	2.13	9.15	1.17	5.25	6.69	8.12	---	.28	.0509	.0308	.008	.0046
4	.85	3.66	.13	3.25	3.88	4.50	2.19	.28	.1270	.0194	.033	.0050
4	.85	3.66	.17	---	---	---	---	.31	.1270	.0254	---	---
4	.85	3.96	.22	3.00	3.62	4.25	---	.28	.1075	.0281	.030	.0078
4	.85	4.27	.17	2.68	3.32	3.98	---	.26	.0932	.0186	.028	.0056
4	.85	4.60	.11	2.15	2.78	3.40	1.38	.22	.0806	.0104	.029	.0037
4	2.13	4.60	.19	1.97	2.58	3.18	.33	---	.0806	.0180	.030	.0046
4	2.13	4.27	.39	---	---	---	---	.50	.2340	.0427	---	---
4	2.13	4.58	.35	---	---	---	---	.49	.2030	.0333	---	---
4	2.13	4.82	.34	5.38	5.94	6.62	3.39	.42	.1835	.0291	.031	.0049
4	2.13	4.88	.30	---	---	---	---	.45	.1790	.0252	---	---
4	2.13	5.49	.48	---	---	---	---	.42	.1410	.0318	---	---
4	2.13	6.16	.46	3.35	4.00	4.65	1.80	.46	.1120	.0242	.028	.0060
4	2.98	5.18	.61	---	---	---	---	.55	.2230	.0456	---	---
4	2.98	5.18	.48	---	---	---	---	.53	.2230	.0358	---	---
4	2.98	5.49	.61	6.15	6.82	7.50	---	---	.1988	.0406	.029	.0059
4	2.98	5.49	.52	---	---	---	---	---	.1988	.0345	---	---
4	2.98	6.10	.56	---	---	---	---	.49	.1600	.0300	---	---
4	2.98	6.10	.61	---	---	---	---	---	.1600	.0328	---	---
6	.85	2.04	.17	---	---	---	1.50	.39	.4080	.0837	---	---
6	.85	2.68	.17	---	---	---	2.22	.33	.2370	.0476	---	---
6	.85	3.05	.20	2.42	2.86	3.30	1.56	.33	.1830	.0421	.064	.0147
6	.85	3.66	.12	2.10	2.51	2.98	1.68	.30	.1270	.0179	.051	.0071
6	.85	4.58	.12	.98	1.41	1.85	1.02	.18	.0810	.0114	.058	.0081
6	2.13	3.05	.61	---	---	---	3.63	.66	.4580	.1310	---	---
6	2.13	3.66	.39	5.88	6.30	6.72	---	.54	.3180	.0581	.050	.0092
6	2.13	4.27	.34	3.50	3.95	4.40	2.10	.42	.2340	.0374	.059	.0095
6	2.13	4.85	.42	2.78	3.21	3.65	2.19	.11	.1810	.0357	.056	.0111
6	2.98	3.66	.45	6.25	6.65	7.05	---	.71	.4440	.0671	.067	.0100
6	2.98	4.58	.45	---	---	---	---	.57	.2840	.0429	---	---
6	2.98	6.10	.45	2.72	3.15	3.58	---	.36	.1600	.0241	.051	.0077
6	4.26	4.27	.75	7.25	7.65	8.05	---	.80	.4680	.0824	.061	.0107
6	4.26	6.10	.76	---	---	---	---	.58	.2285	.0408	---	---
6	5.11	6.10	.82	---	---	---	---	.69	.2740	.0440	---	---
12	.85	1.83	.22	---	---	---	---	.49	.5070	.1310	---	---
12	.85	3.05	.26	---	---	---	---	.19	.1830	.0559	---	---
12	2.13	2.14	.48	---	---	---	---	.82	.9300	.2100	---	---
12	2.13	2.84	.52	3.50	3.69	3.88	---	.76	.5290	.1290	.143	.0350
12	4.26	2.74	.86	---	---	---	---	1.09	1.1360	.2290	---	---
12	4.26	4.58	1.00	---	---	---	---	.60	.4050	.0953	---	---
12	6.39	3.36	1.40	6.52	6.72	6.92	---	1.37	1.1300	.2480	.168	.0369
12	6.39	4.58	1.49	4.55	4.70	4.85	---	.97	.6080	.1420	.129	.0302

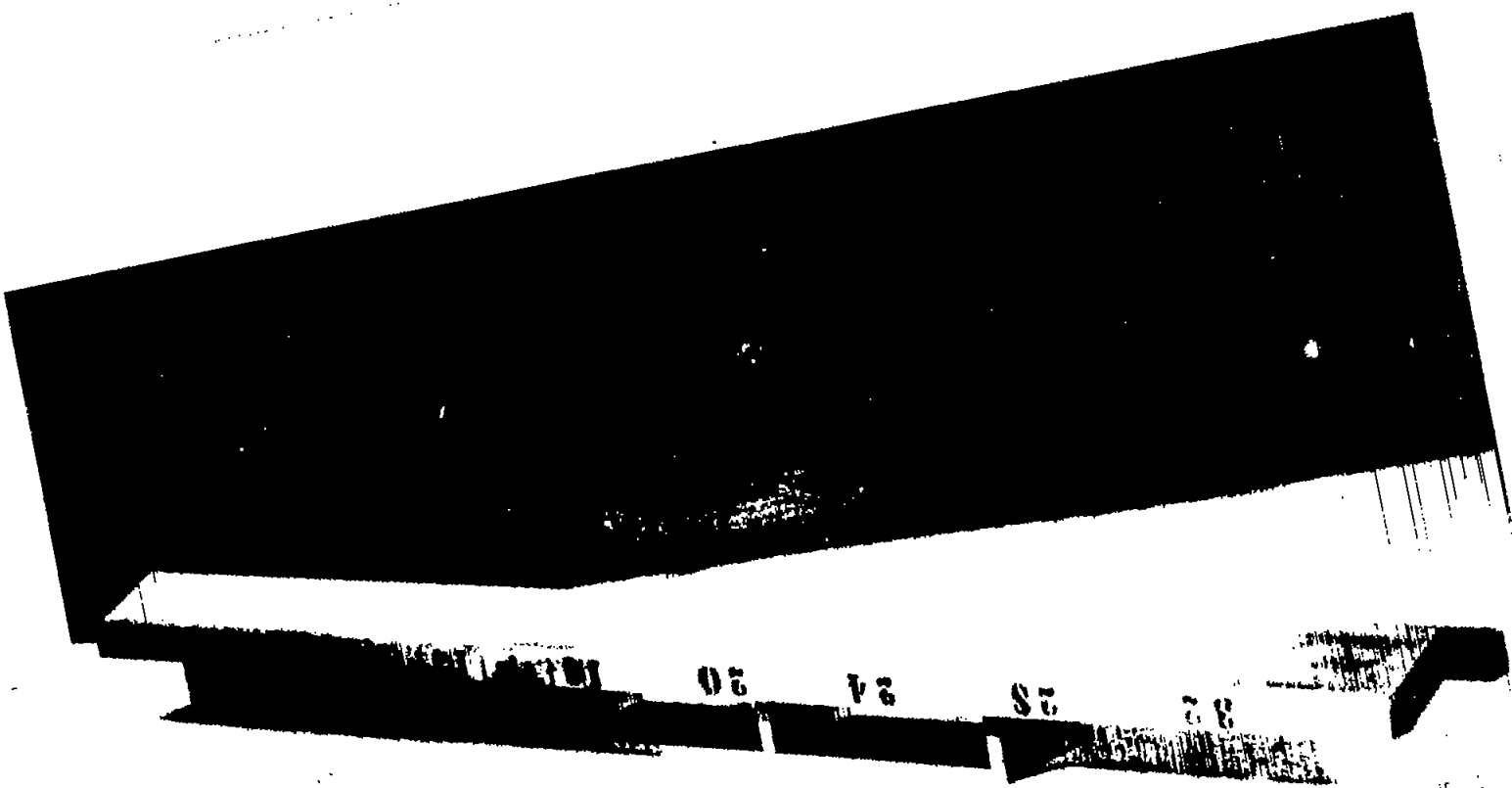

Figure 1.- Langley tank model 276A.

NACA
1930

NACA TN 2804

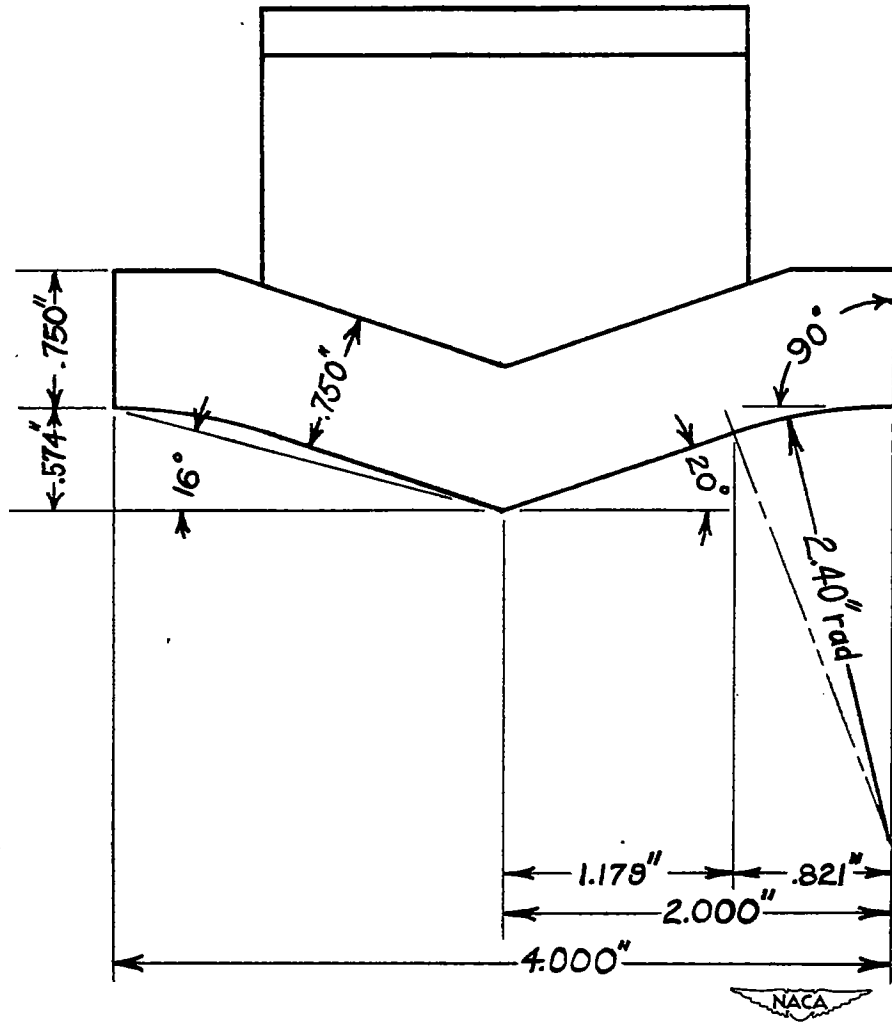

Figure 2.- Cross section of model.

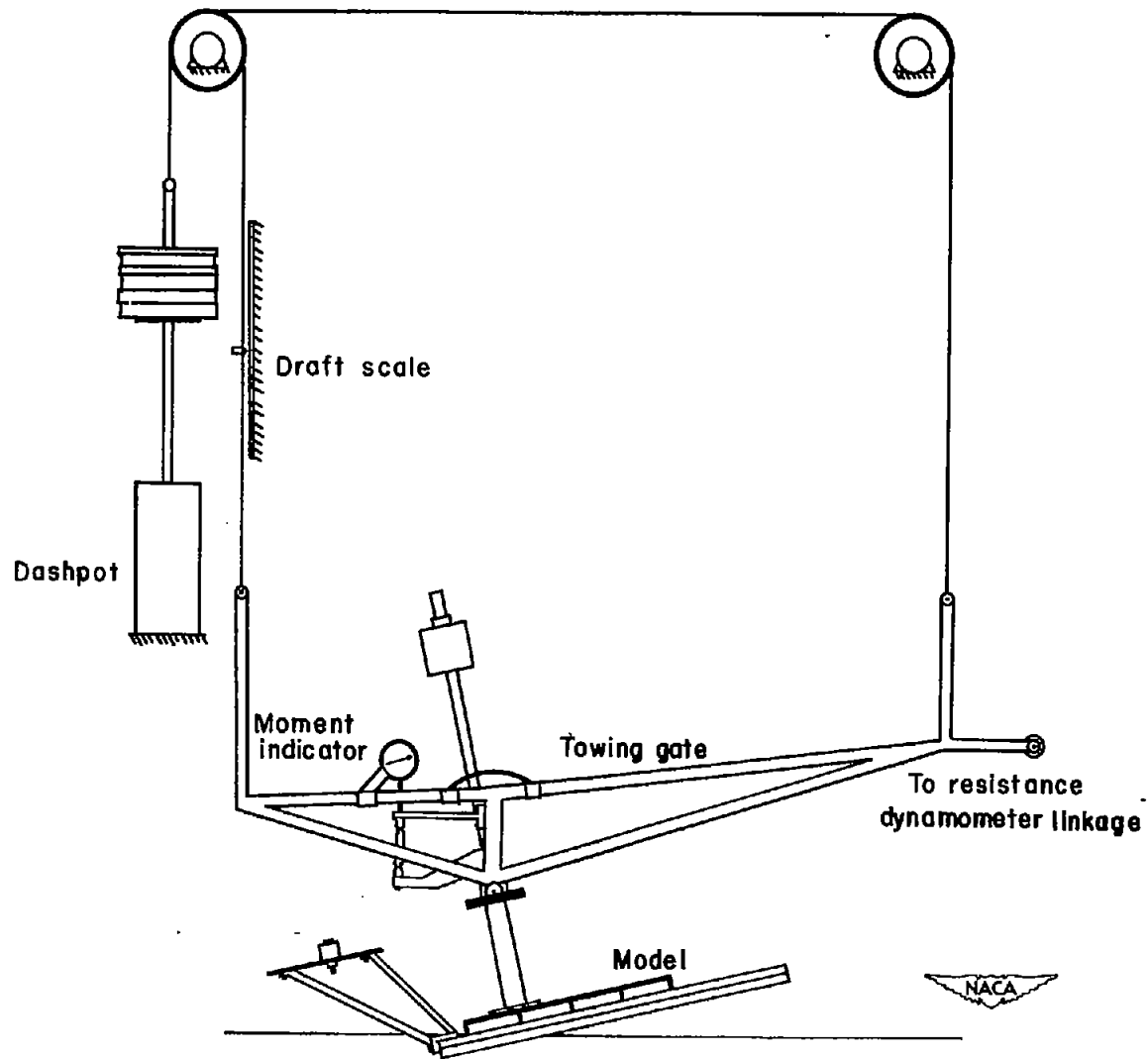

Figure 3.- Setup of model and towing gear.

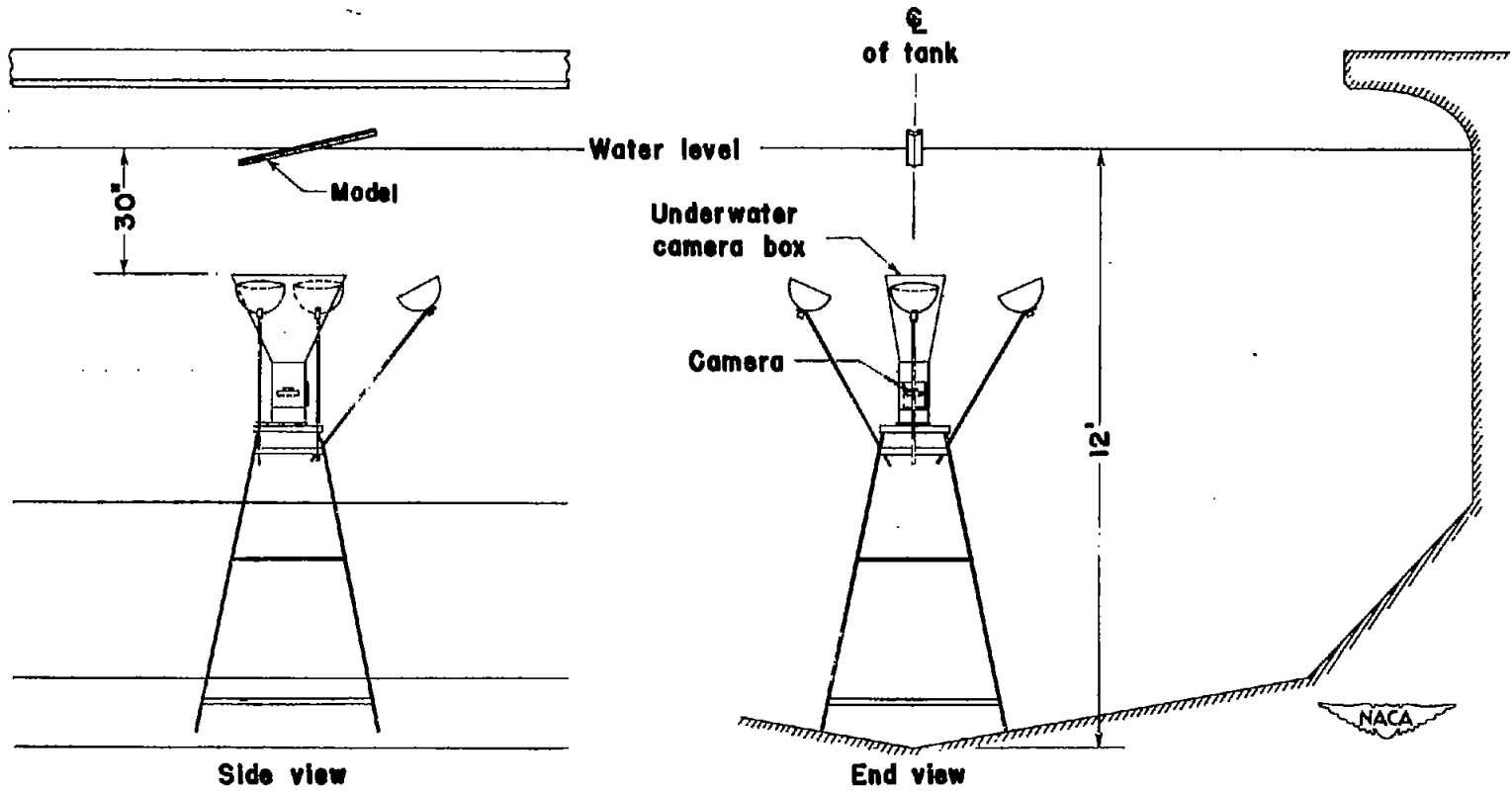

Figure 4.- Setup used for obtaining underwater photographs.

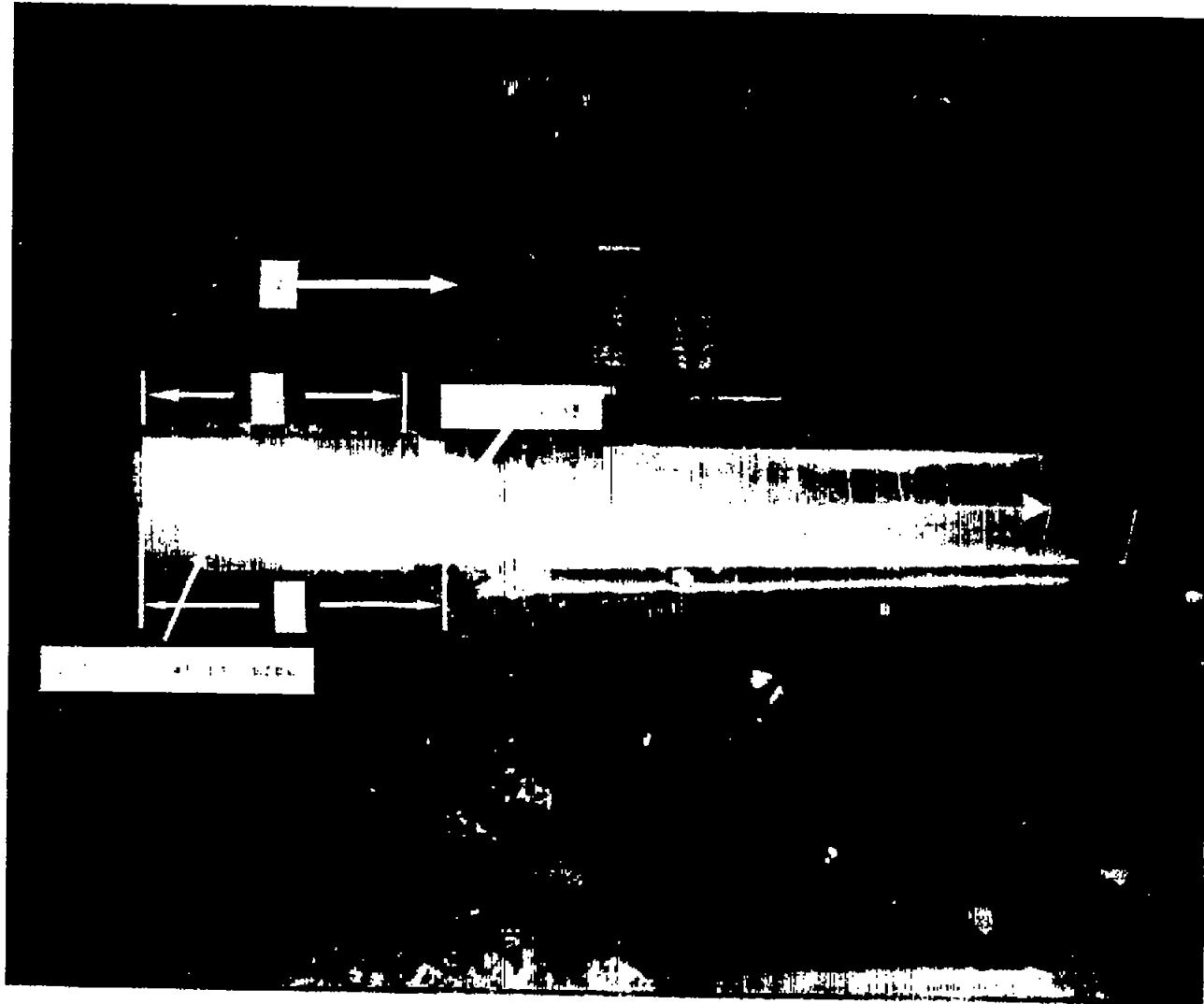

Figure 5.- Typical underwater photograph.

NACA
L-75176

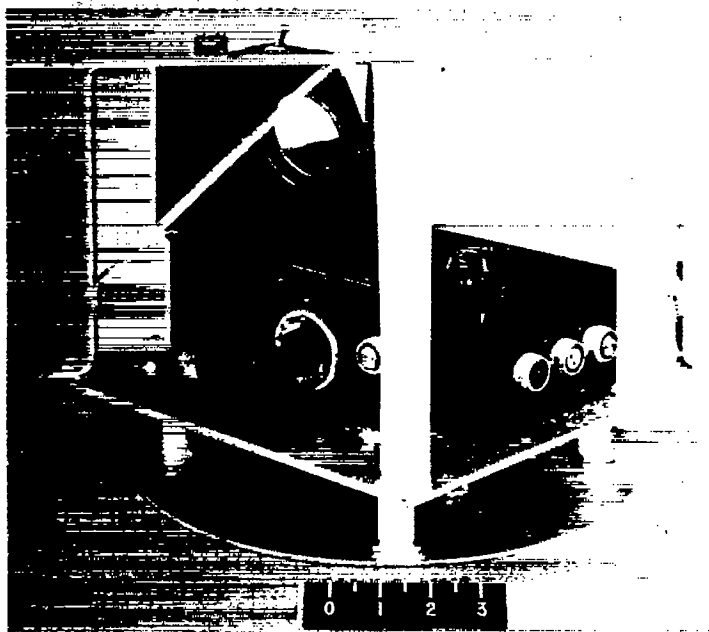
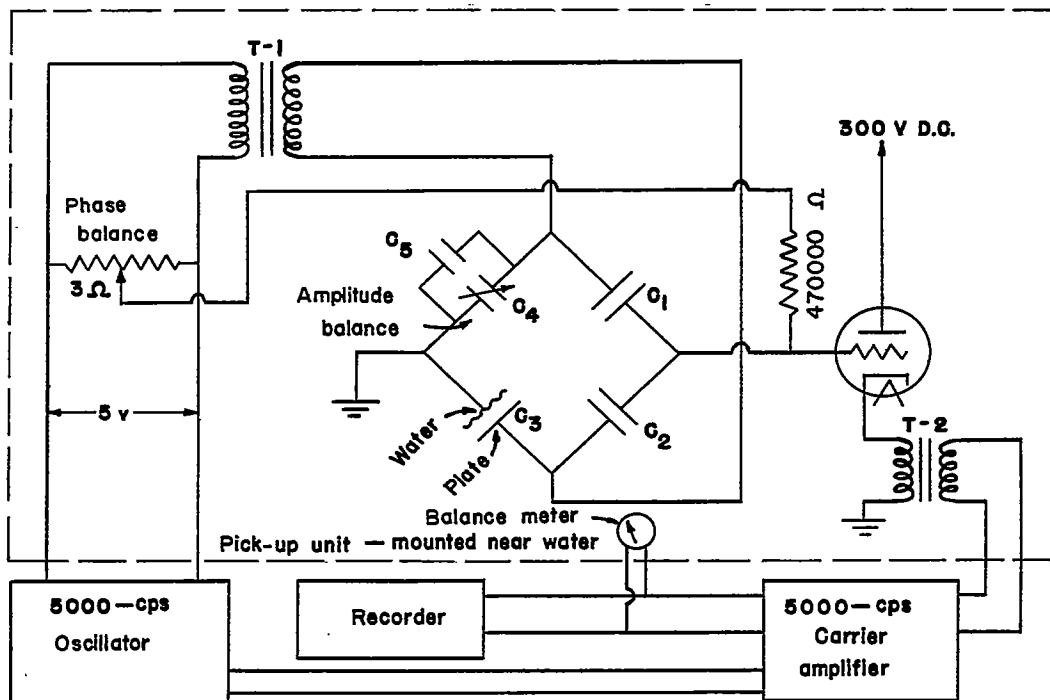

Figure 6.- Photograph and schematic drawing of circuit of capacity-bridge water-level indicator.

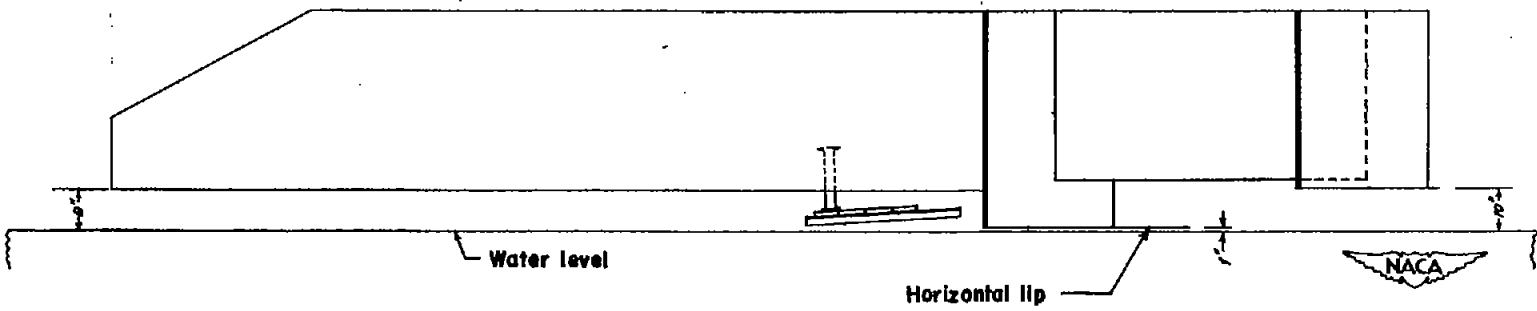
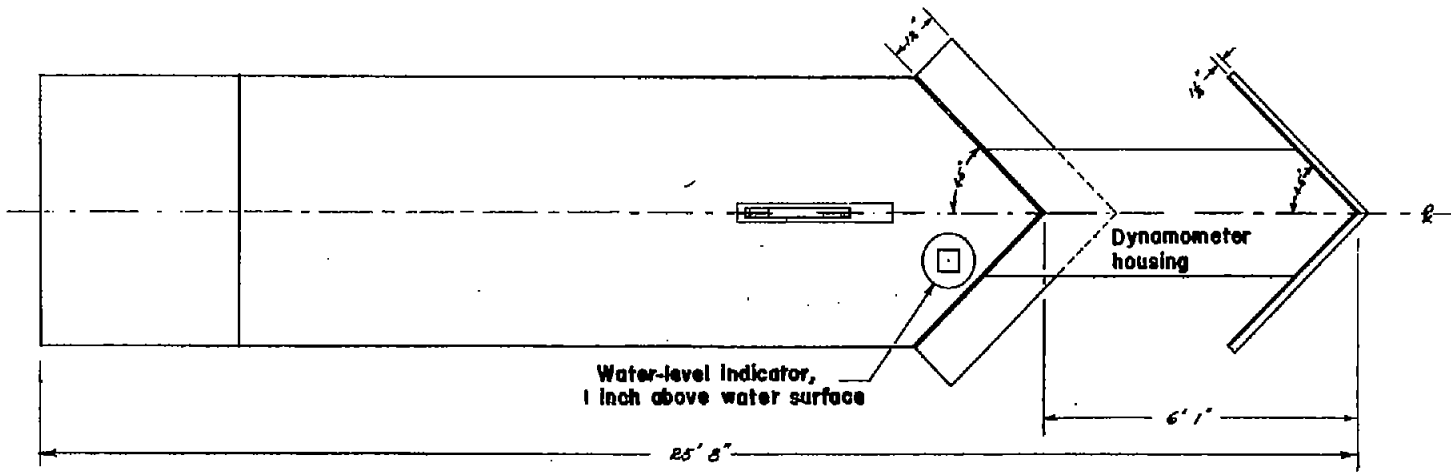

Figure 7.- Details of windscreen.

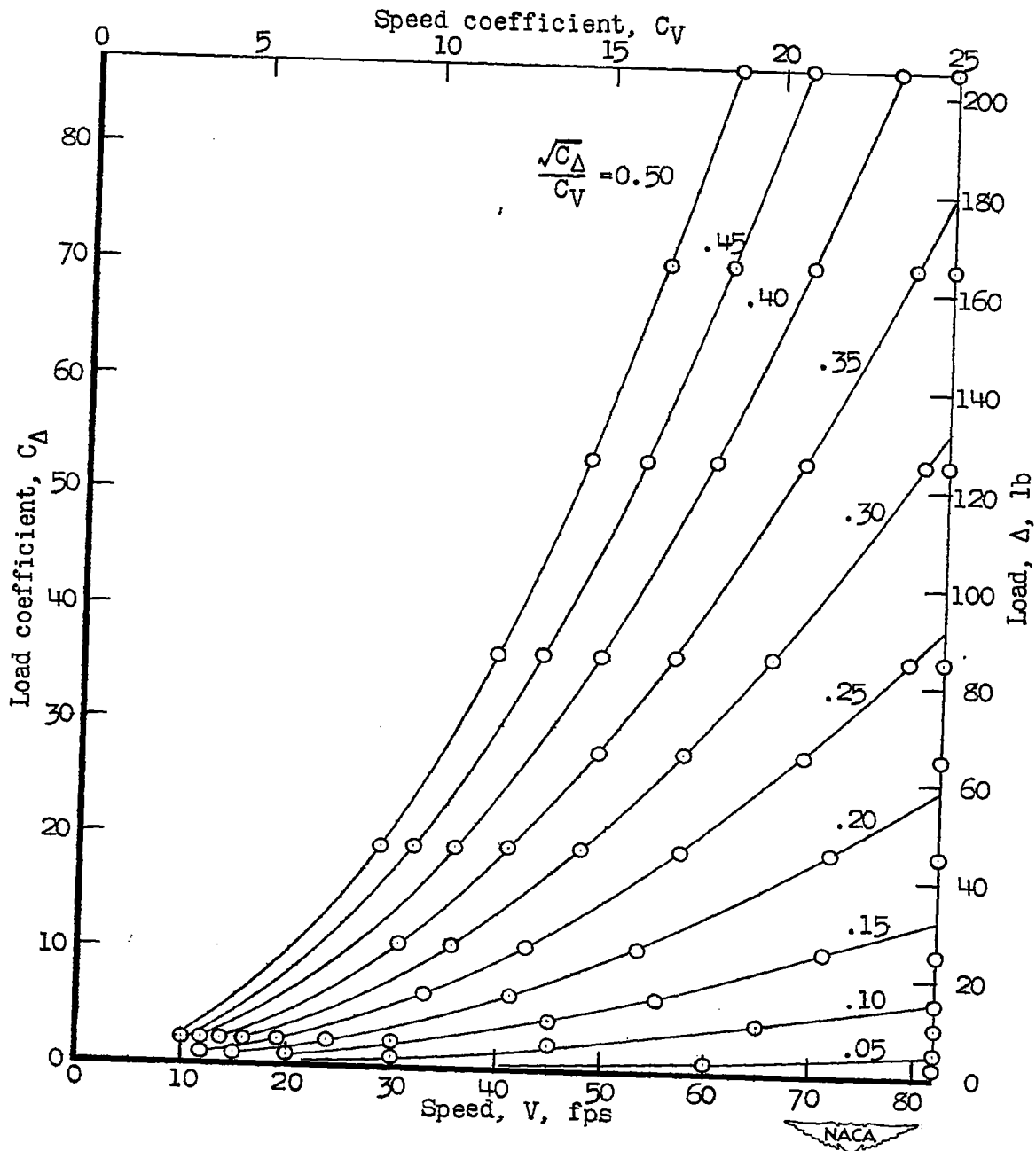

Figure 8.- Load-speed schedule for test program.

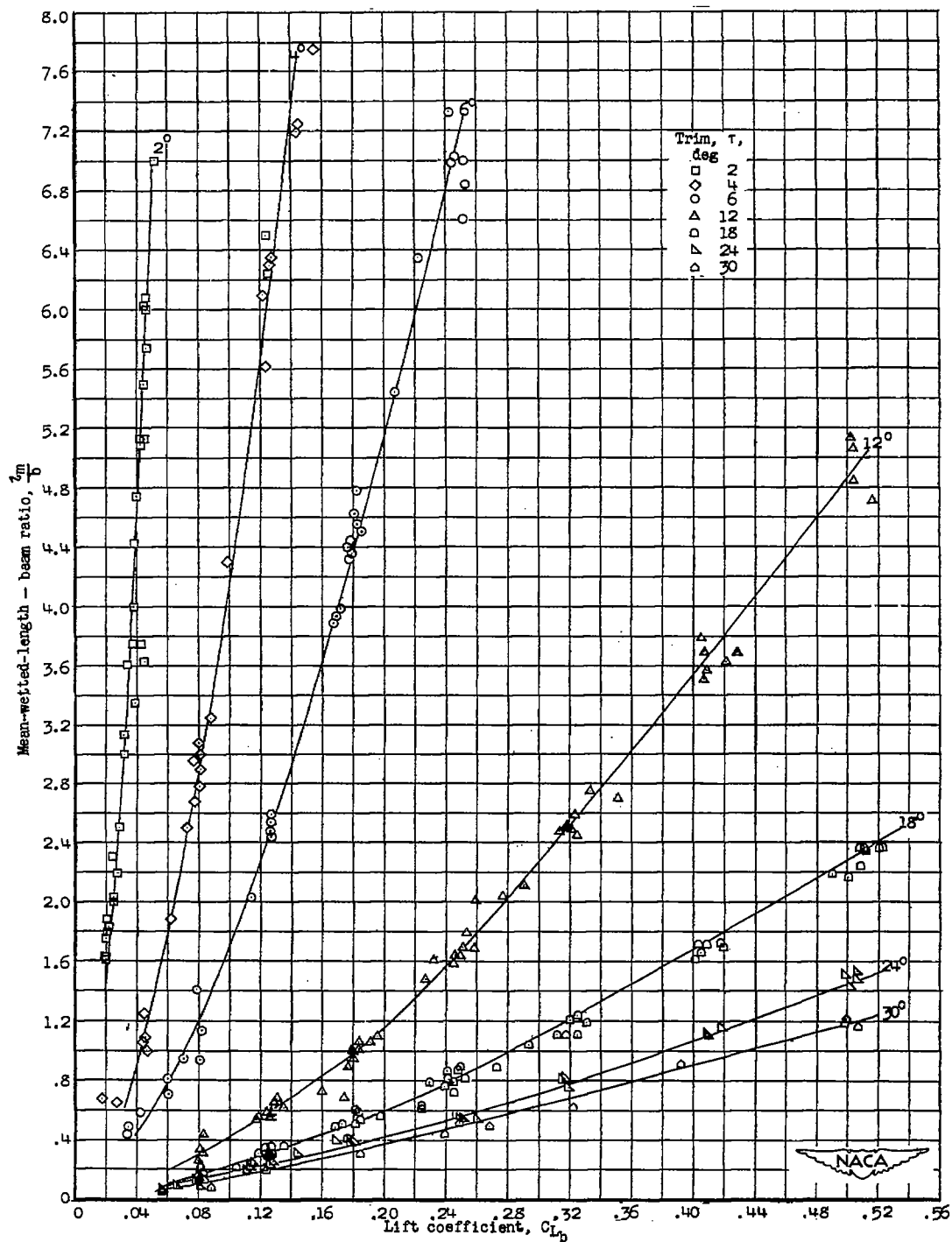

Figure 9.- Variation of mean-wetted-length-beam ratio l_m/b with lift coefficient C_{Lb} .

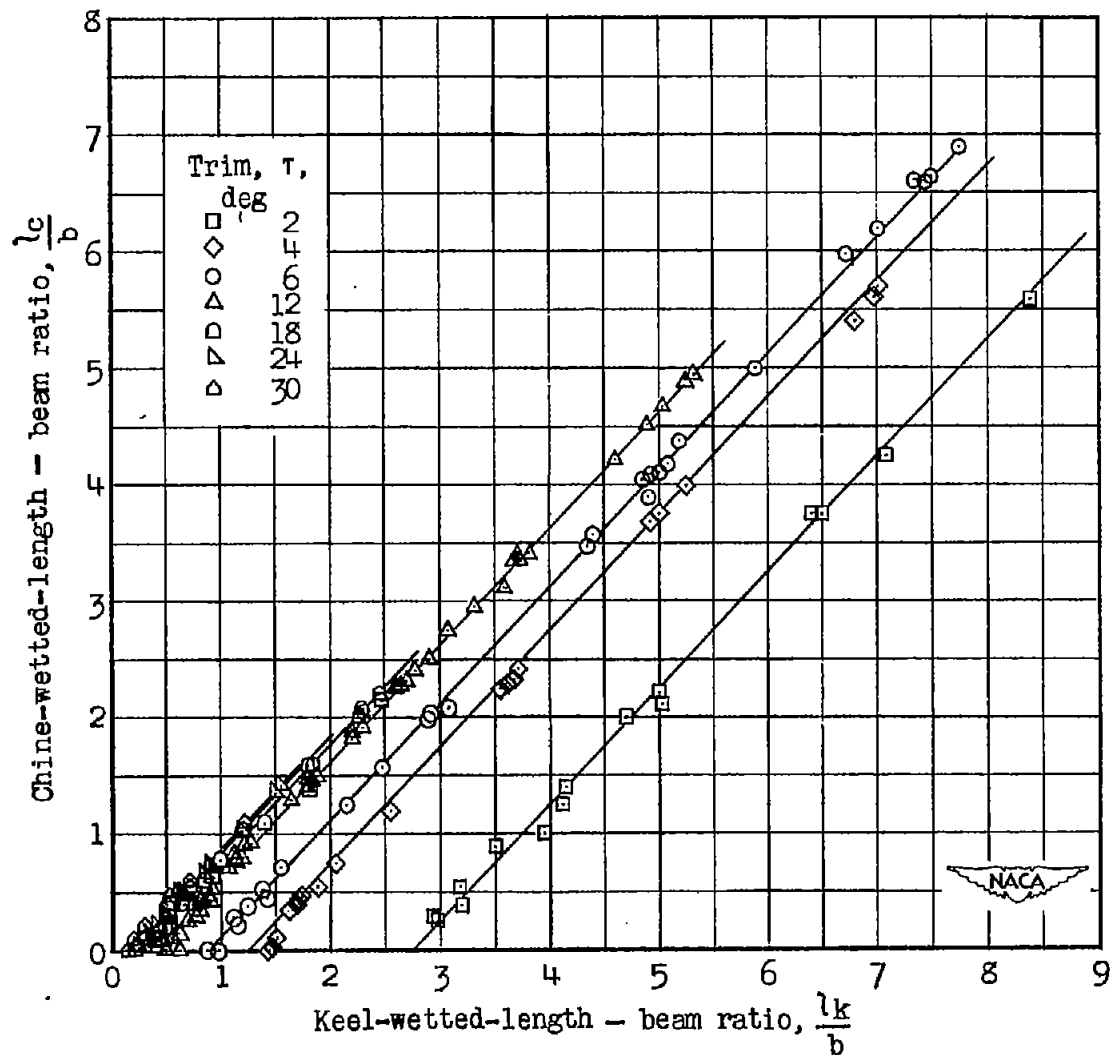

Figure 10.- Variation of chine-wetted-length-beam ratio with keel-wetted-length-beam ratio.

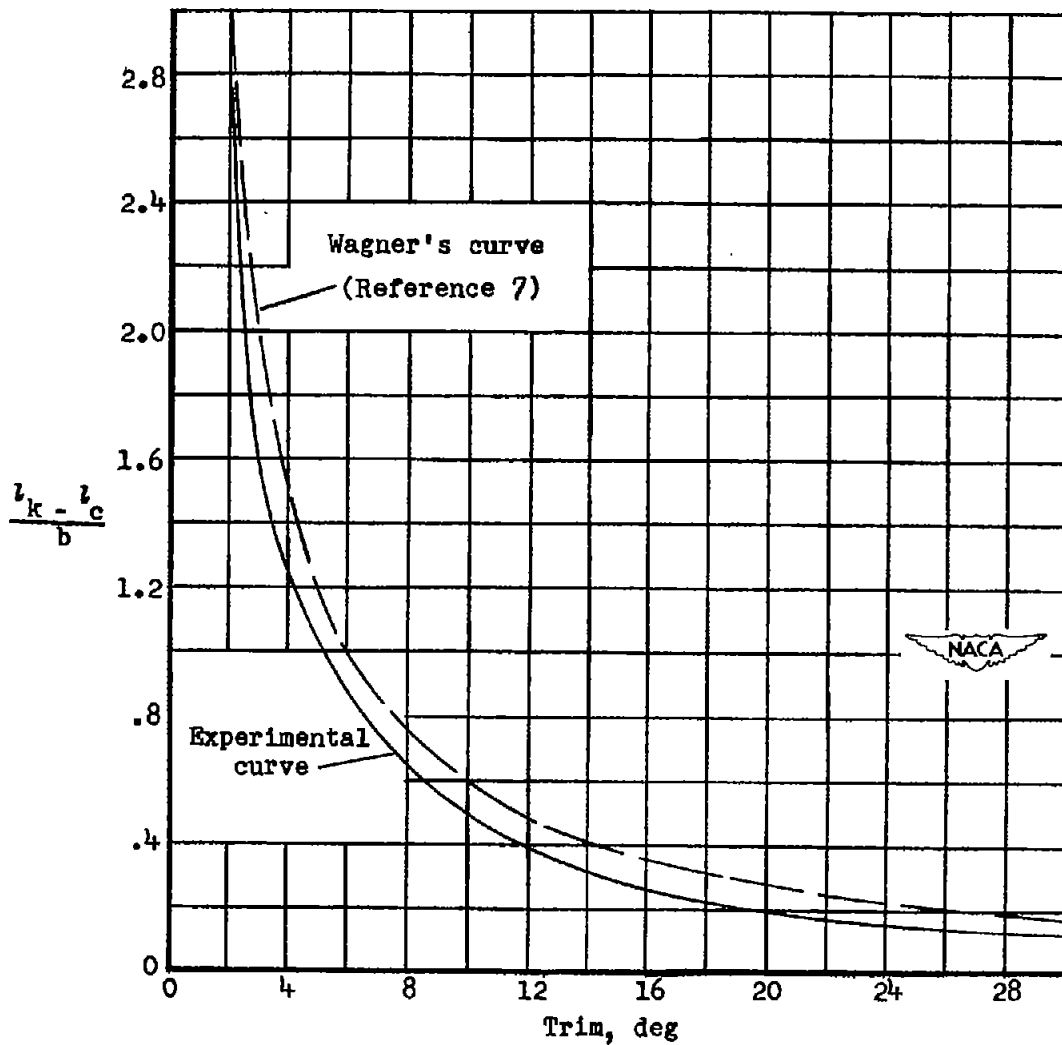

Figure 11.- Variation of $\frac{l_k - l_c}{b}$ with trim.

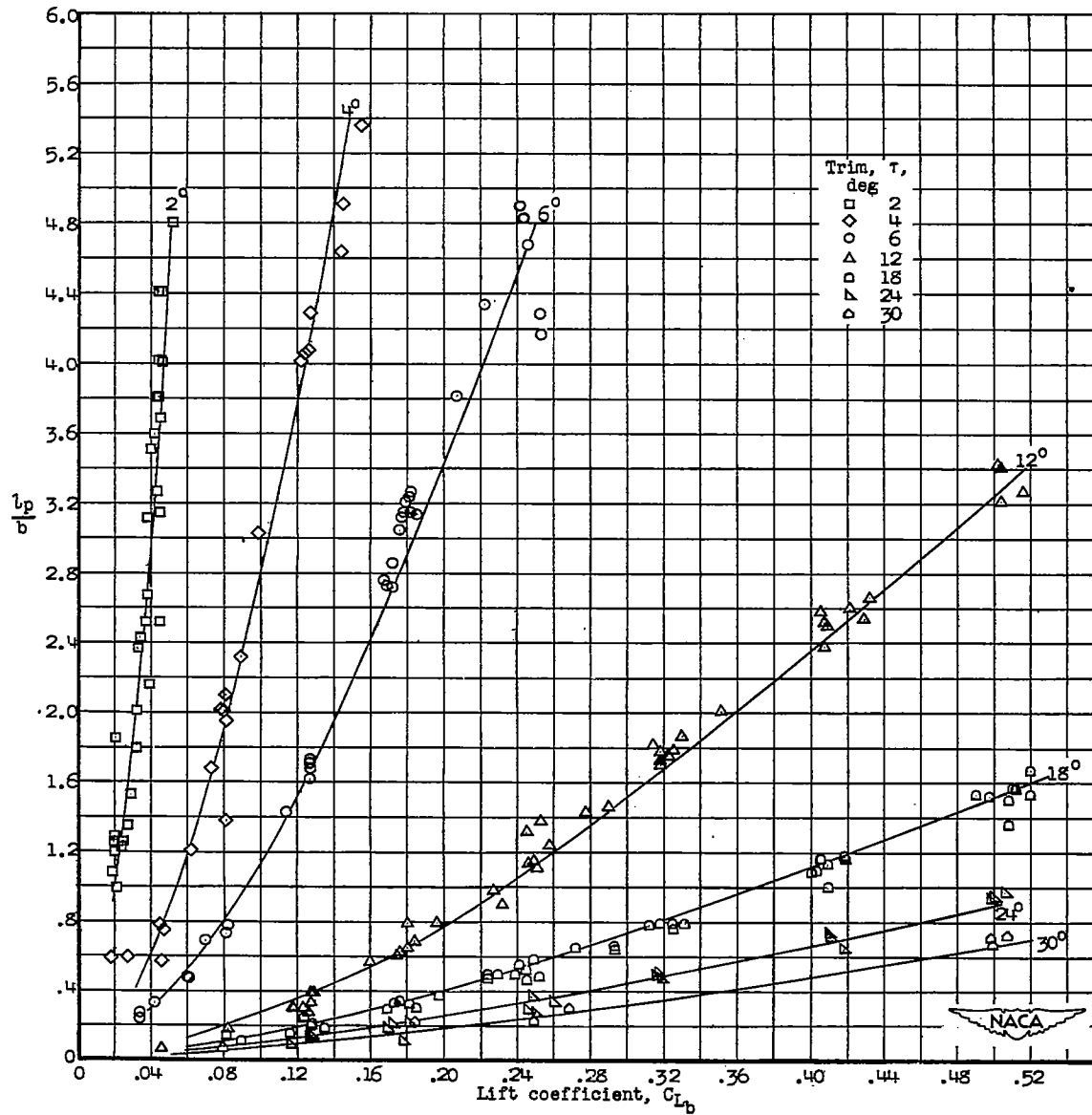
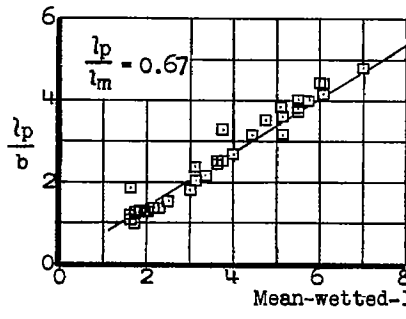
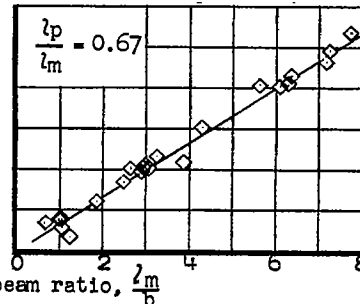

Figure 12.- Variation of nondimensional center-of-pressure location l_p/b with lift coefficient C_{Lb} .



(a) Trim, 2°.



(b) Trim, 4°.

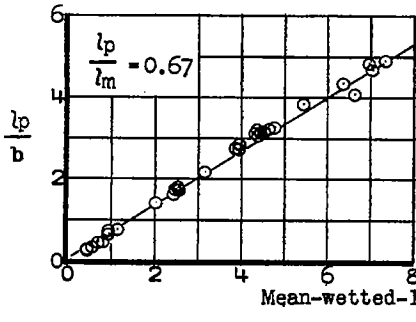

(c) Trim, 6°.

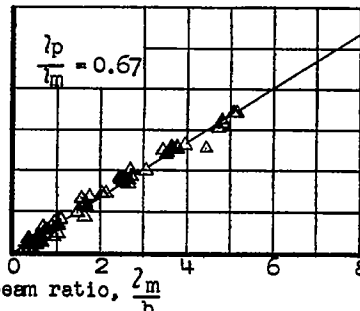

(d) Trim, 12°.

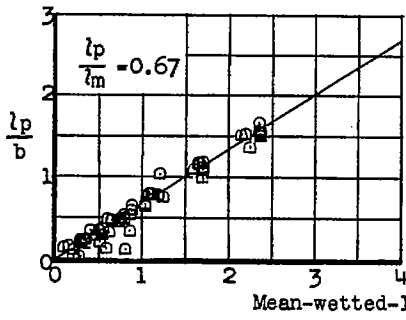

(e) Trim, 18°.

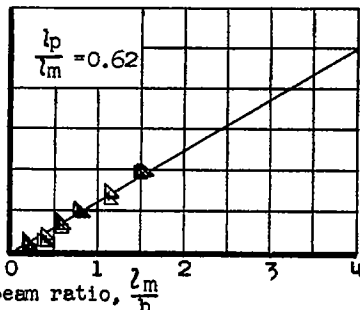

(f) Trim, 24°.

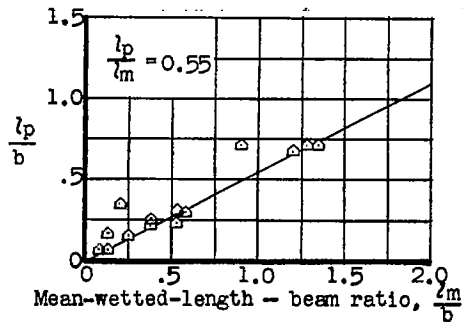

(g) Trim, 30°.



Figure 13.- Variation of l_p/b with l_m/b .

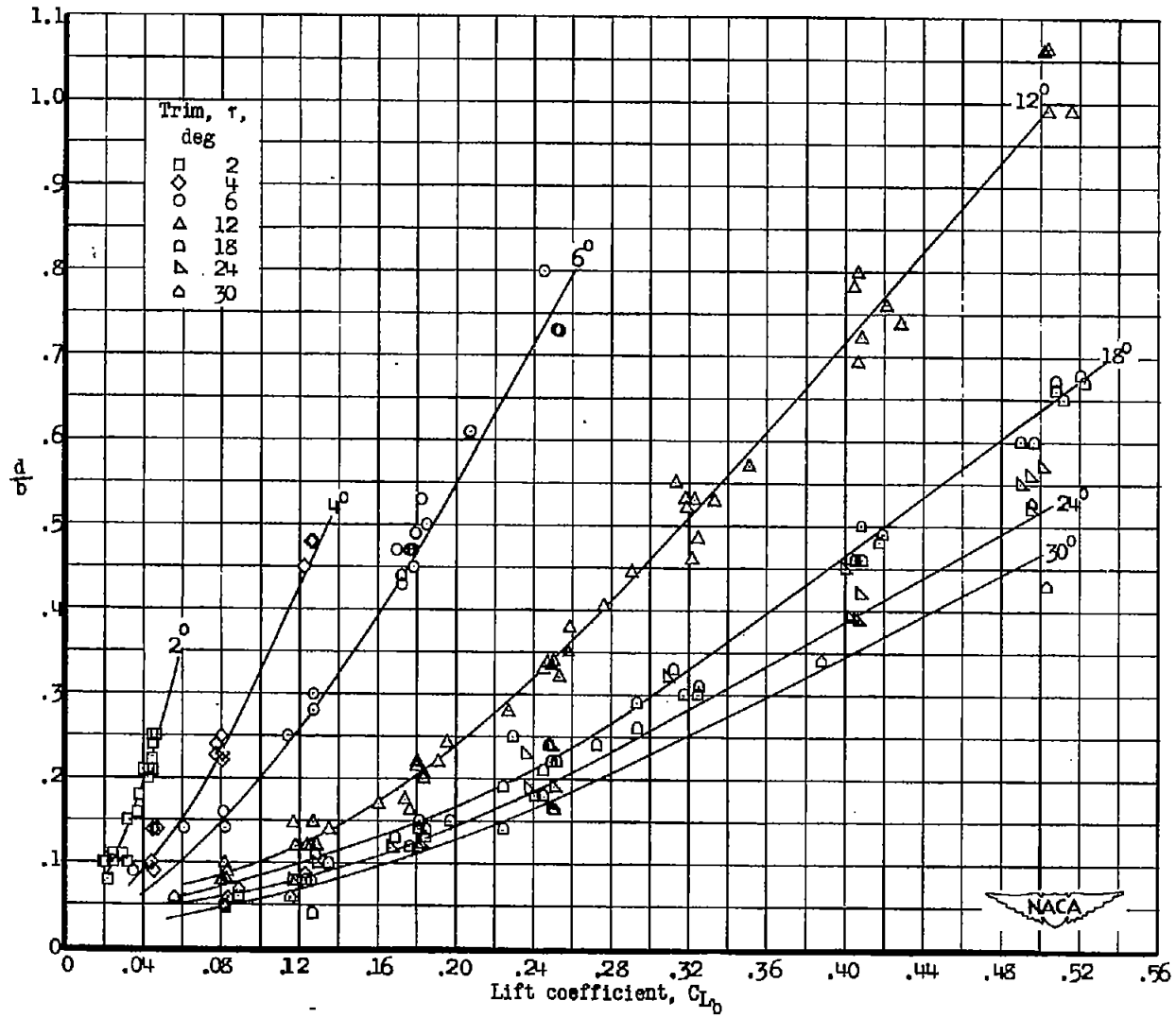
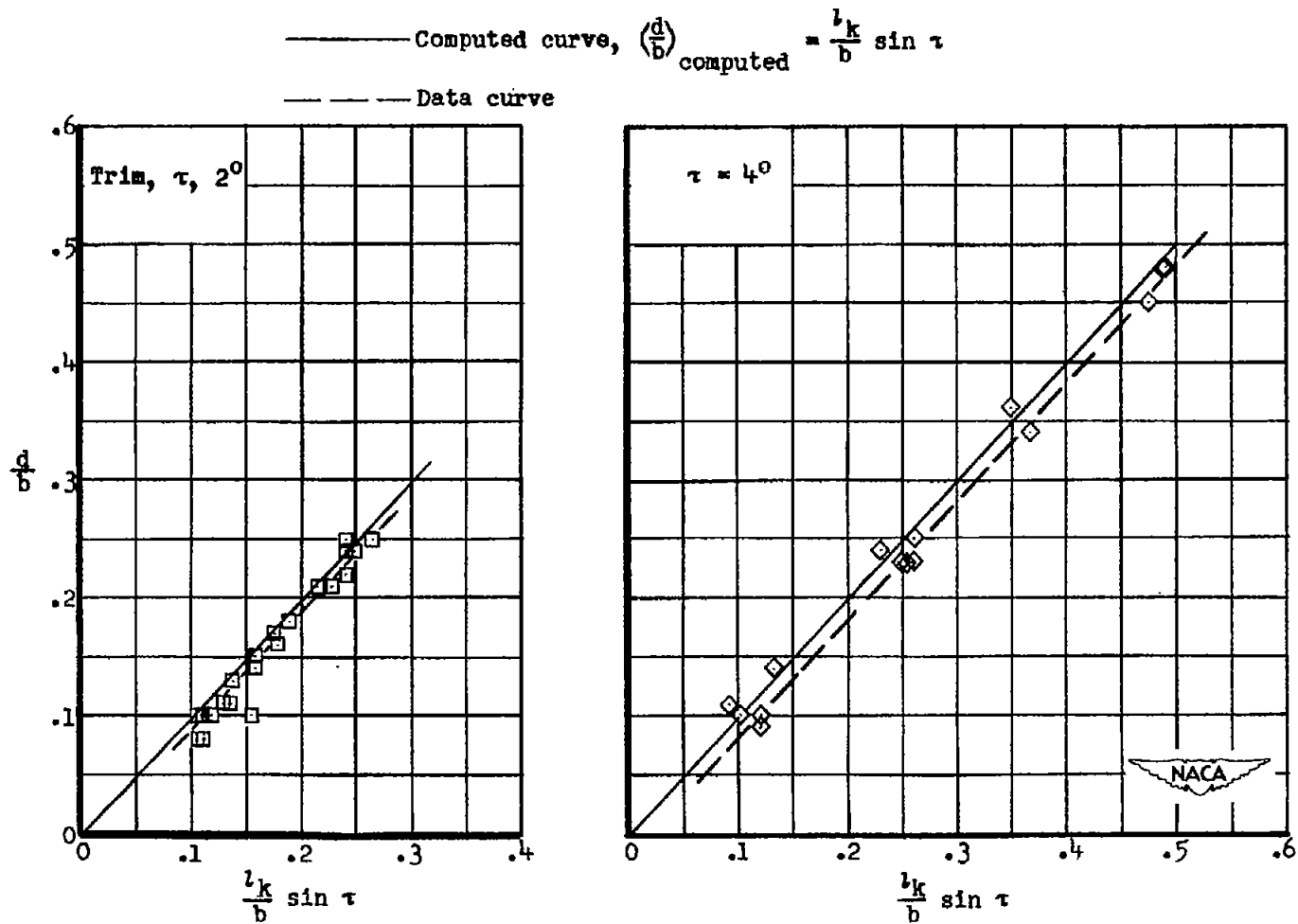
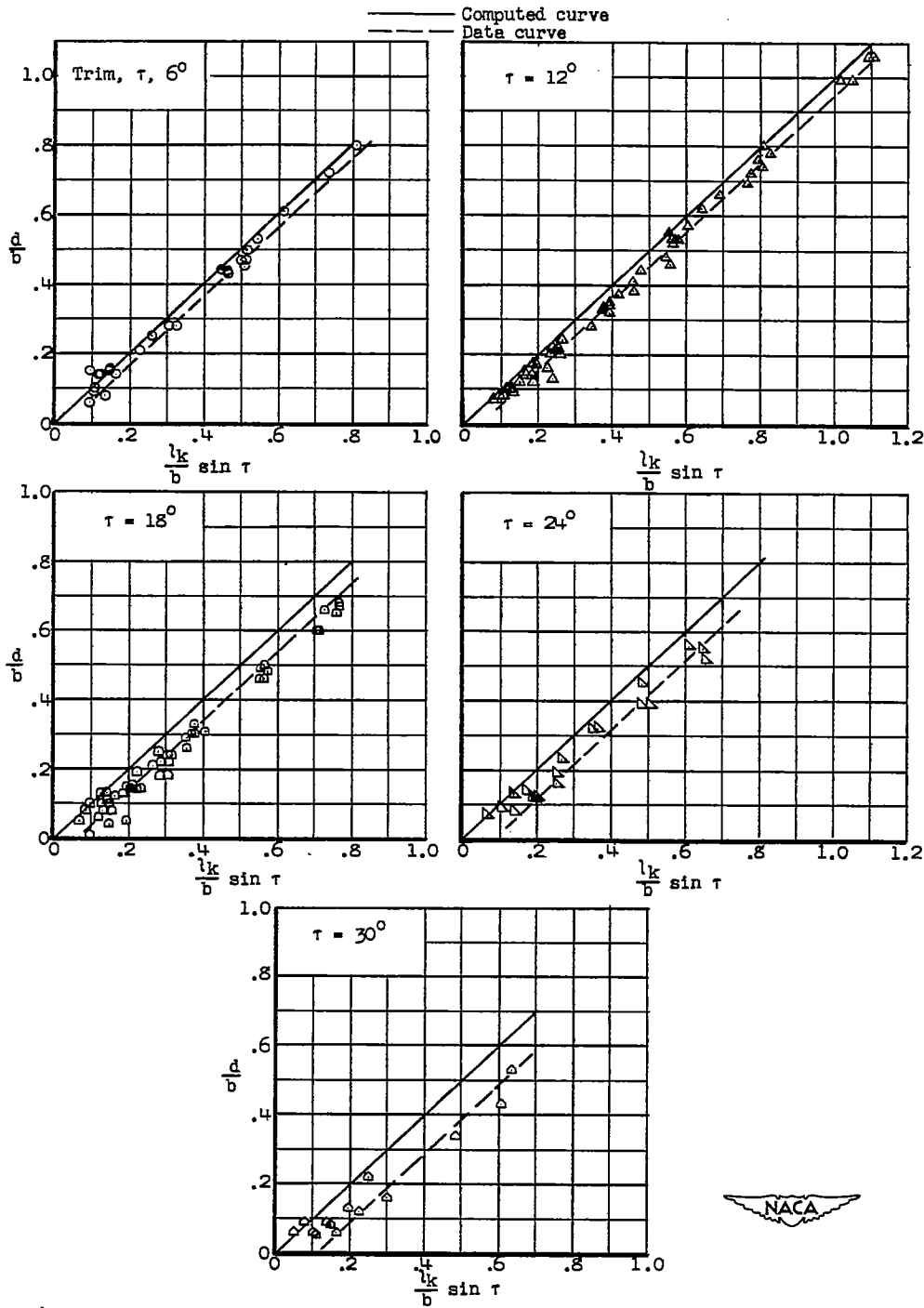

Figure 14.- Variation of d/b with C_{L_b} .



(a) Trim, 2° and 4° .

Figure 15.- Comparison of experimental draft data with computed draft data showing pile-up at the keel.



(b) Trim, 6° , 12° , 18° , 24° , and 30° .

Figure 15.- Concluded.

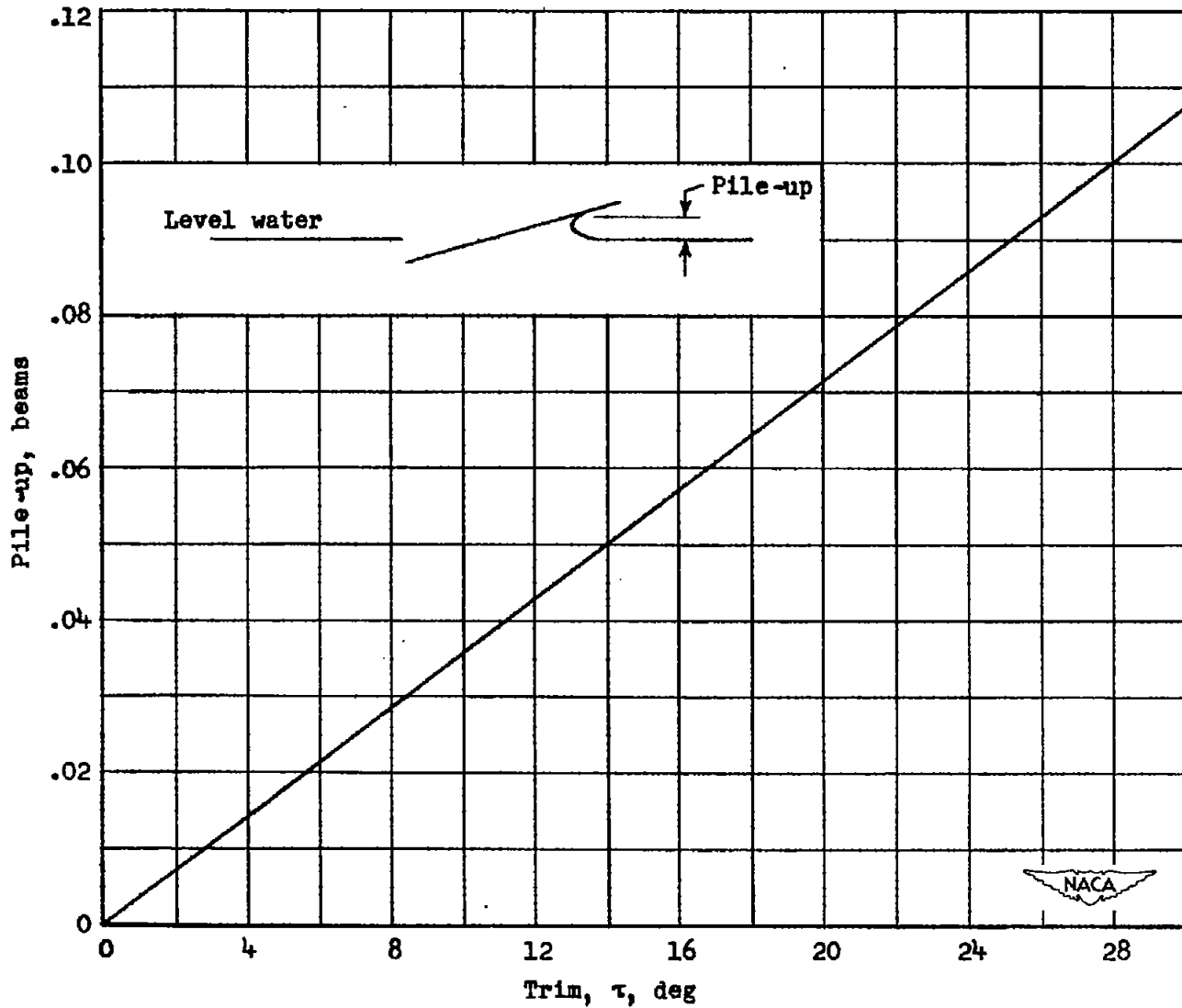
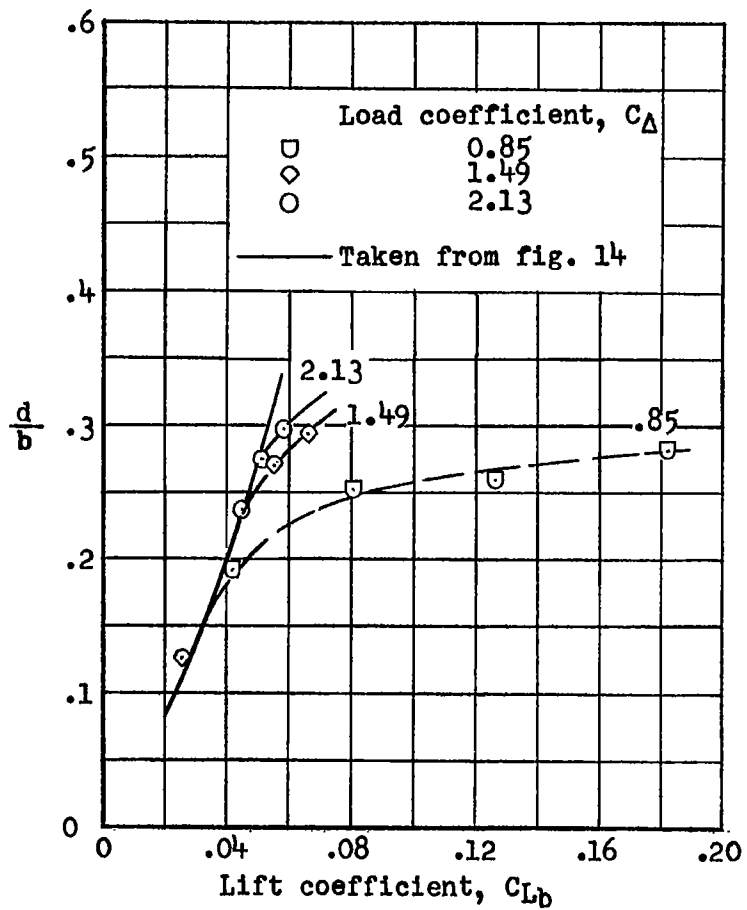
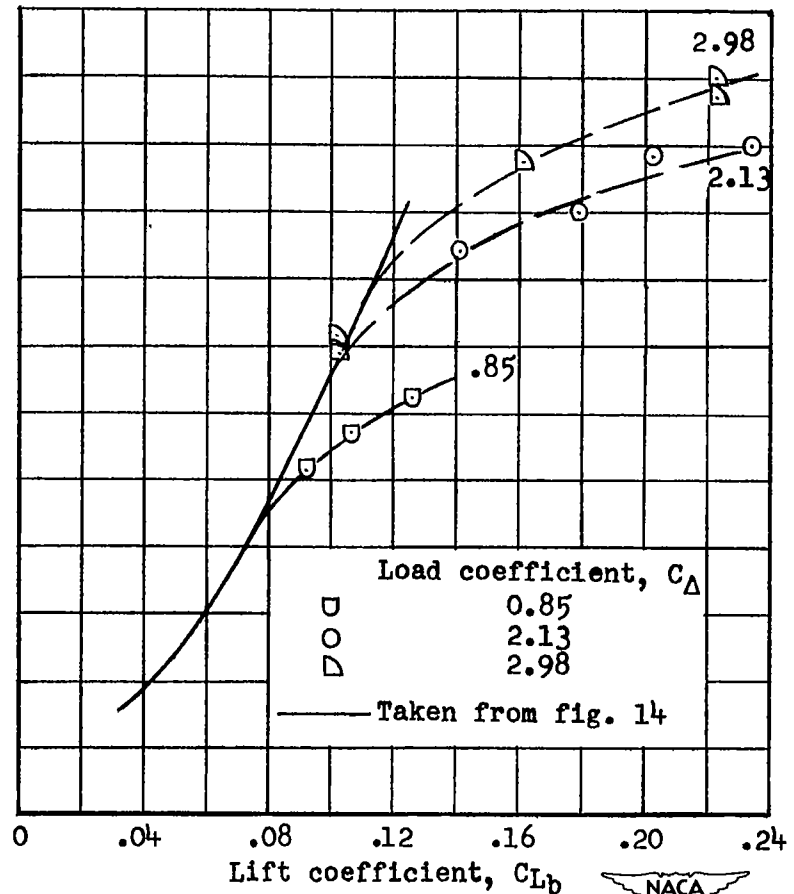

Figure 16.- Variation of pile-up with trim angle.



(a) Trim, 2° .



(b) Trim, 4° .

Figure 17.- Variation of d/b with C_{Lb} at low speeds. (See table II.)

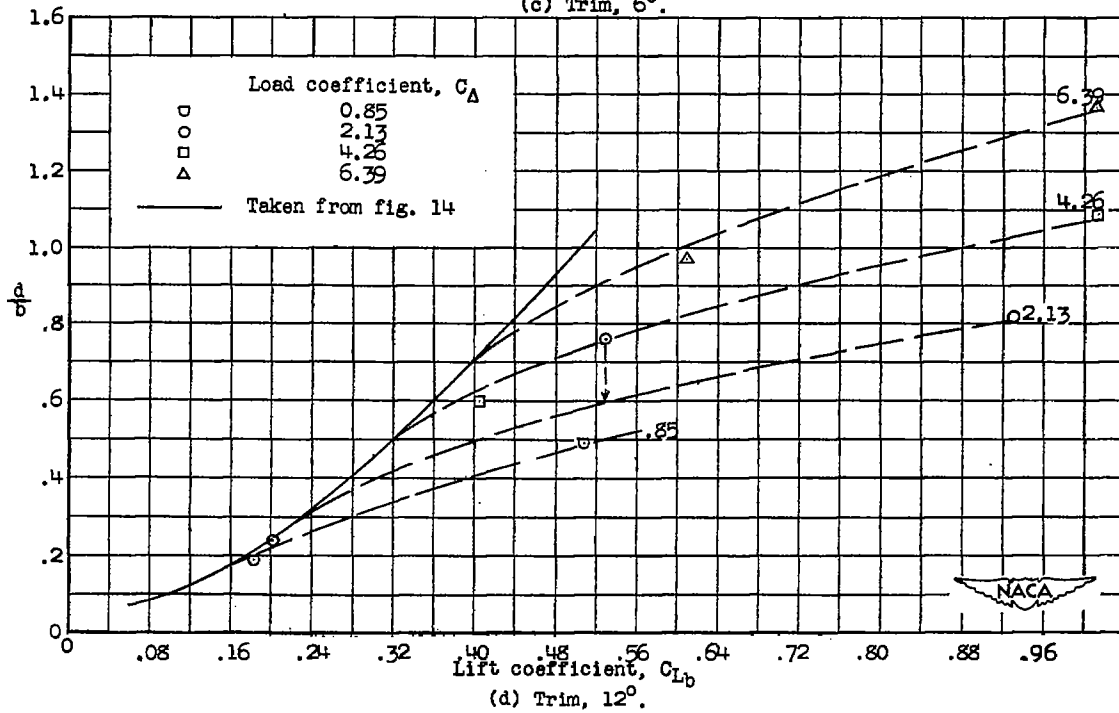
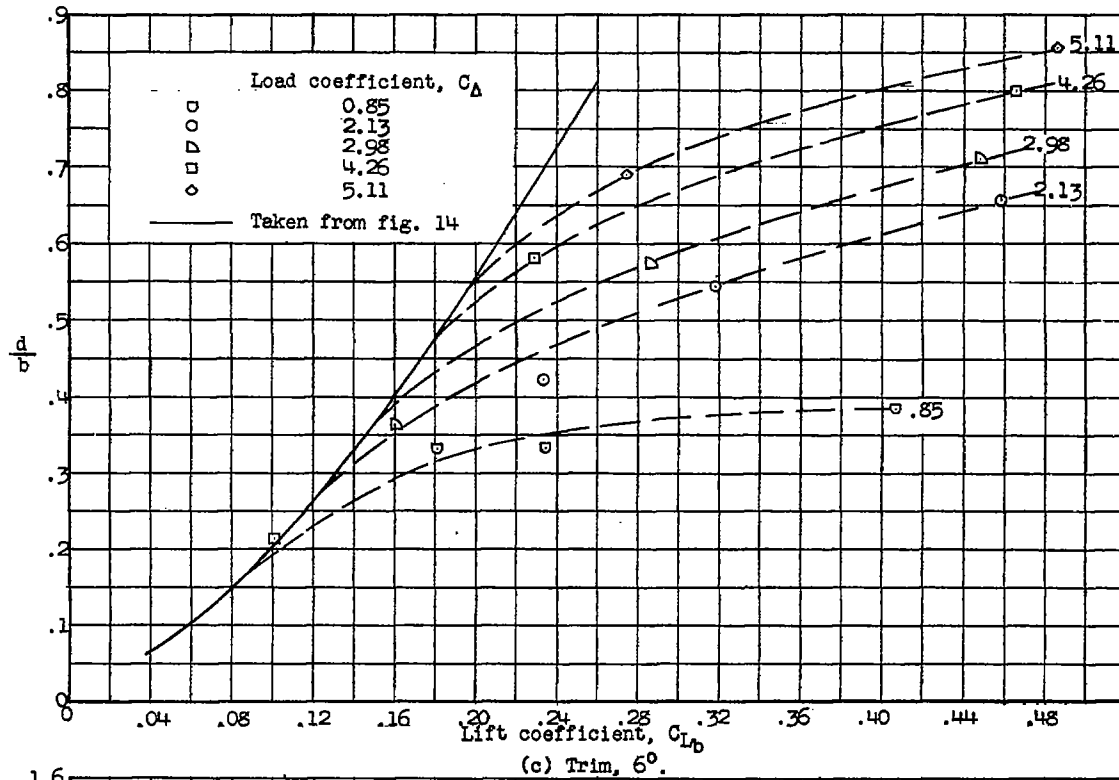

Figure 17.- Concluded.

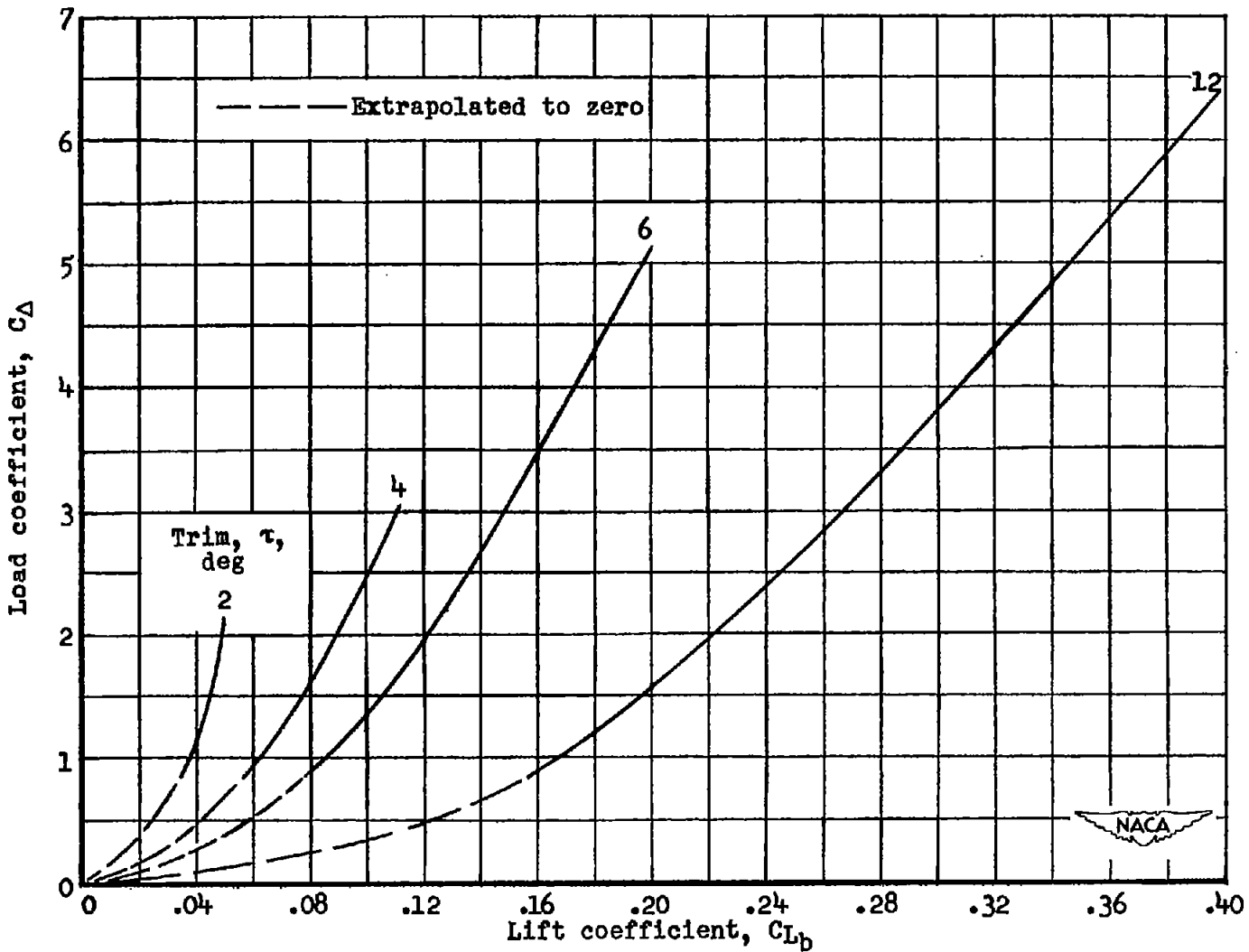
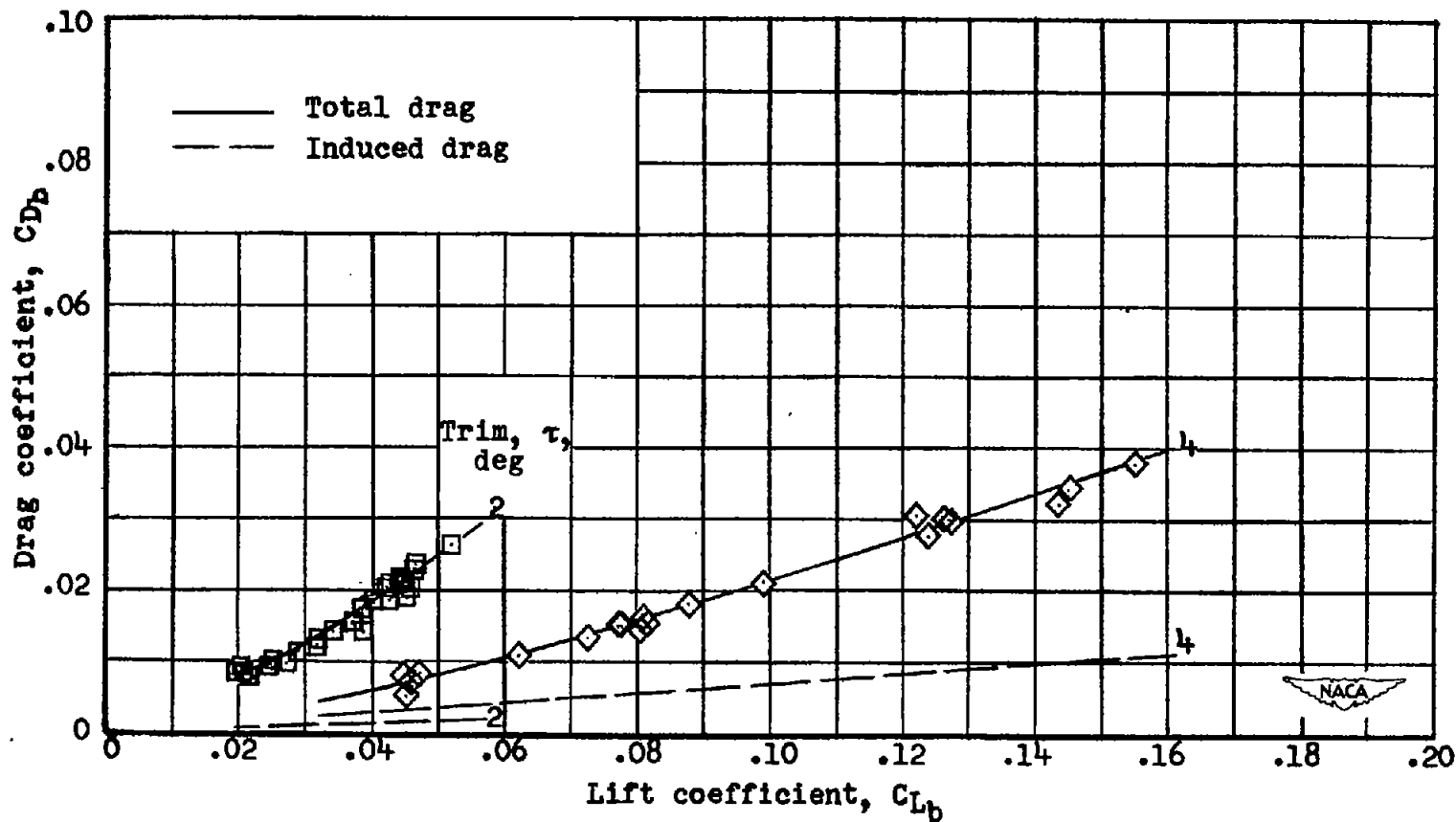
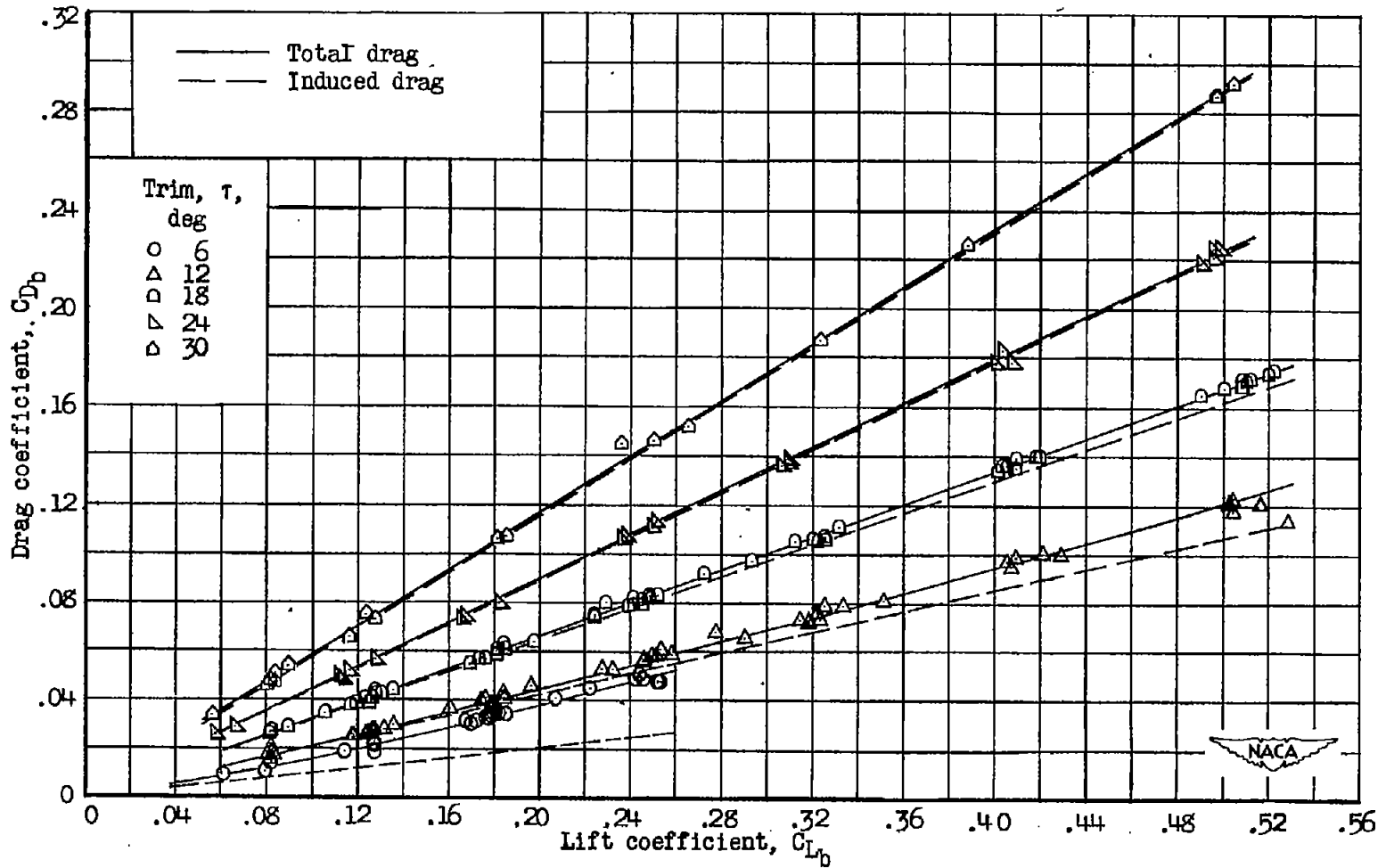

Figure 18.- Curves defining the variation of minimum load coefficient for pure planing.



(a) Trim, 2° and 4°.

Figure 19.- Variation of drag coefficient C_{Dp} with lift coefficient C_{Lp} .



(b) Trim, 6°, 12°, 18°, 24°, and 30°.

Figure 19.- Concluded.

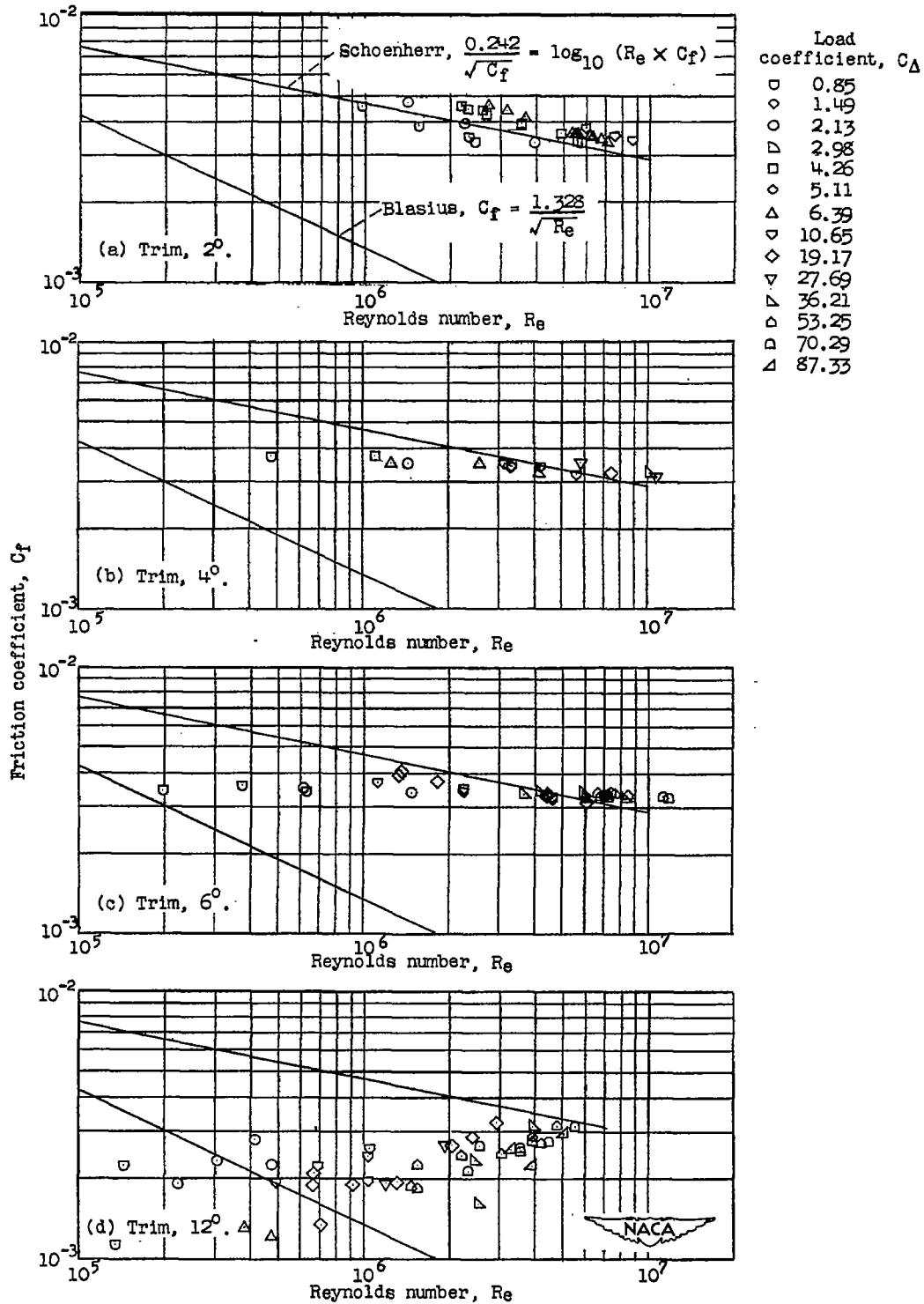

Figure 20.- Variation of friction coefficient with Reynolds number.