



TECHNICAL NOTES

NATIONAL ADVISORY COMMITTEE FOR AERONAUTICS

No. 286

PRELIMINARY INVESTIGATION ON BOUNDARY LAYER CONTROL BY
MEANS OF SUCTION AND PRESSURE WITH THE U.S.A. 27 AIRFOIL

By E. G. Reid and M. J. Bamber
Langley Memorial Aeronautical Laboratory

Washington
May, 1928

286

NATIONAL ADVISORY COMMITTEE FOR AERONAUTICS.

TECHNICAL NOTE NO. 286.

PRELIMINARY INVESTIGATION ON BOUNDARY LAYER CONTROL
BY MEANS OF SUCTION AND PRESSURE WITH THE U.S.A. 27 AIRFOIL.

By E. G. Reid and M. J. Bamber.

S u m m a r y

The tests described in this report constitute a preliminary investigation of airfoil boundary layer control, as carried out in the atmospheric wind tunnel of the Langley Memorial Aeronautical Laboratory, from February to August, 1927.

Tests were made on a U.S.A. 27 airfoil section with various slot shapes and combinations, and at various amounts of pressure or suction on the slots.

The lift of airfoils can be increased by removing or by accelerating the boundary layer.

Removing the boundary layer by suction is more economical than to accelerate it by jet action. Gauze-covered suction slots apparently give the best results.

When not in operation, all suction slots tested had a detrimental effect upon the aerodynamic characteristics of the airfoil which was not apparent with the backward-opening pressure slots.

Thick, blunt-nose airfoils would seem to give best results with boundary layer control.

Introduction

It is known that the performance characteristics of airplanes would be materially improved if the departure of the air flow from the upper surface of airfoils could be made as small at large angles of attack as it is at small angles. The cause of the departure of the actual flow of air around airfoils from that which would exist in an inviscid fluid is found in the action of viscosity and has its root in the layer of retarded air (boundary layer) close to the airfoil. At small angles of attack the flow retarded by the action of viscosity produces a thin boundary layer over the surface while at large angles the entire flow over the upper surface becomes discontinuous and turbulent.

The lift may be expected to increase with the angle of attack so long as continuous flow over the upper surface can be maintained. The object of controlling the flow of air in the boundary layer is to prevent, in so far as is possible, the appearance of discontinuous flow over the upper surface of the airfoil which gives rise to an increase of profile drag and, finally, a decrease of lift (burble) as the angle of attack is increased.

Control of the boundary layer has been accomplished in other laboratories by accelerating it by jet action, removing it through the surface of the wing, or providing a movable surface such that the friction would be reduced between the air and this

surface. The jet action for the acceleration of the boundary layer, has been furnished by an auxiliary airfoil near the leading edge of the wing, a nozzle held in front of the airfoil so as to discharge air rearward over the surface, and rearward opening slots in the upper surface of the airfoil. The boundary layer has been removed by suction, drawing it into the airfoil through slots, gauze coverings, and perforations in the upper surface. Rotating cylinders have also been used as the leading edge of airfoils to form a movable surface so that there would be no retardation of the air by that surface.

In this investigation at the Langley Memorial Aeronautical Laboratory the boundary layer was controlled either by accelerating it by jet action or by suction acting from the inside of the wing through slots. The method used to accelerate the boundary layer was to blow air from inside the wing out through rearward opening slots nearly parallel to the surface. The velocity of the air flow through the slots was controlled by a pressure maintained inside the airfoil.

Tests were made to determine the following: (1) Normal force coefficient (C_{NF}) with and without slots, (2) an approximation of the power required by the slots expressed in turns of an equivalent drag coefficient, (3) the position of the point of discontinuity or separation of flow on the upper surface of the plain airfoil.

Apparatus and Installation

The tests were made on a U.S.A. 27 airfoil in the 5-foot, circular throat atmospheric wind tunnel. This is the airfoil section of the TS airplane which is being flight-tested with pressure slots at this laboratory.

Due to the fact that the widths of the slots must necessarily be small in comparison to the chord of the airfoil, a large chord was used. The airfoil was placed between planes which were normal to the span; thus making the flow two-dimensional.

An 18-inch chord, $25\frac{1}{2}$ -inch span airfoil was built up of wood and metal. Figure 1 is a photograph of the airfoil with the upper cover plate removed showing the construction. The leading and trailing edge sections were made of wood and the center portion of four steel ribs covered with sheet iron cover plates. The ribs were cut out to allow for free passage of air through the inside of the airfoil.

The airfoil was mounted vertically in the wind tunnel as shown in Figure 2. The air supply was led to the inside of the airfoil by means of a truncated cone and a water seal. Stream-line forms enclosed the pressure tubes above and the water seal below the planes.

The small tubes which can be seen in Figure 1 are the leads from pressure orifices at the middle of the span of the model. The orifices are located as shown in Figure 3. The pressures at the various points on the airfoil were indicated by a multiple

manometer from which photographic records similar to Figure 4 were obtained.

The pressure difference for slot operation was furnished by an N.A.C.A. Roots type supercharger driven by a shunt wound electric motor.

Computation of Test Results

The normal force coefficient (C_{NF}) was determined from the pressures indicated on the photographic manometer records. The pressures were computed in terms of dynamic pressure ($q = \frac{1}{2} \rho V^2$) and plotted at their respective positions along the chord. The points thus plotted determined a pressure distribution diagram. The area of this when divided by the chord gave C_{NF} , which may be expressed as the mean pressure in terms of q .

The "increase of normal force coefficient" (as used in this report) is that obtained by comparison with the maximum obtained with the unslotted airfoil.

The power required to deliver air to or from the slots may be considered as the product of a hypothetical drag and the velocity of flight (the tunnel wind speed). The drag coefficient C_{DG} corresponds to this hypothetical drag and is computed according to the formulas developed in Appendix I.

Unslotted Airfoil

Tests were made on the unslotted airfoil to form a basis of comparison for the results obtained with the various slots. Pressure distribution records were taken for various angles of attack. The pressure distribution diagrams shown in Figure 5 are for 12 and 18 degrees angle of attack. C_{NF} is plotted against α in Figure 6.

As has already been mentioned, the flow of air over the upper surface of an airfoil becomes discontinuous at the higher angles of attack. Since the purpose of the slots is to prevent discontinuous flow, the points of discontinuity were determined for various angles of attack. As the continuous flow is toward the rear and discontinuous flow appears in general to be forward over the surface, the point of separation of flow could be readily determined.

The method of determining the direction of flow was to paint with white lead around the pressure openings and allow hydrogen sulphide to pass out of the openings. The hydrogen sulphide was carried along the surface by the flow of air and as it came in contact with the white lead some of it was changed to black lead sulphide. The pattern thus obtained indicated the direction of flow. Trials were made until two adjacent tubes indicated forward and rearward flow, respectively. The point of discontinuity was taken as lying between those tubes for that angle of attack.

In Figure 7 the position of the point of discontinuity as thus determined along the chord is plotted against angle of attack.

Airfoil with Pressure Slots

The first slot was formed as shown in Figure 8 and located at A, (Fig. 9), by cutting a slot in the upper cover plate at the maximum ordinate, filling the rear edge of the front plate thus formed, and adding the brass former to the front of the rear plate. The width of the slot could be varied by screws from the lower surface through to the brass former.

Pressure distribution records were taken with slot openings of .01, .02, and .04 inch; the pressure inside the airfoil was maintained at an excess of $4q$ (four times dynamic pressure) over the static pressure. The increases in C_{NF} over that of the unslotted airfoil, as computed from the above records, were so small that the results are not given. From a study of the probable effects of slot shape the indications were that the air was discharged at too large an angle with the surface.

To decrease the angle of discharge with the surface, steel cover plates ground to a 3 degree bevel were used for the upper side of the slot and the brass former for the lower side. Figure 10 is a diagram of the resulting slot. Two of these slots located as shown in Figure 9 at A and B, were incorporated in a new upper cover plate. The slot width was adjustable as before.

Pressure distribution tests were made with various pressures

and slot openings. In Figure 11, C_{NF} is plotted against α for .018 inch front and .020 inch rear slot openings and at pressures of 0, 4 q, 11 q, and 15 q, in excess of static pressure. In Figure 12, C_{NF} is plotted against α for front slot open and rear closed, and for the rear slot open and front closed with slot openings of .015, .030, and .045 inch at a pressure of 11 q. Pressure distribution diagrams taken at 18 degrees with .018 inch front and .020 inch rear slots at 4 q and 15 q pressures are given in Figure 13, together with the diagram for the unslotted airfoil. The pressure distribution diagram for 18 degrees with rear slot closed and front slot open .045 inch at 11 q pressure, is reproduced as Figure 14. The pressure distribution diagrams for the same pressure but with the rear slot open .045 inch and front slot closed were almost identical.

In Figure 15, A, B, C, and D, the percentage increase in C_{NF} is plotted against C_{DS} for 12, 15, 18, and 21 degrees, for the various conditions indicated. Due to the fact that the data required to determine the quantity of air furnished to the slots from the supercharger was not recorded in several tests, C_{DS} was computed for all pressure slot tests by the method outlined in Appendix I (c). For this reason the values of C_{DS} are to be considered of comparative value only.

Airfoil with Suction Slots

Tests were made with three types of suction slots: (a) slots opening normal to the surface, (b) sharp edge forward-opening slots, and (c) gauze-covered slots.

Slots Opening Normal to Surface.— In order to find the best slot position or positions and combination of slots as well as the effectiveness of normal opening slots, a cover plate with 9 slots each 1/32 inch wide located as illustrated in Figure 16, was made up and tested. A second series of tests were made with the three front slots widened to 1/16 inch, and then a third series of tests with the slots filed so as to open forward. Combinations of slot positions were obtained by covering various slots with paper strips.

The results of these tests are given in Figures 17, 18, and 19. In Figures 17 and 18, C_{NF} is plotted against α for the various conditions indicated. Pressure distribution diagrams for the plain and slotted airfoils at 18 degrees angle of attack are shown in Figure 19.

These tests seemed to indicate that the increase of C_{NF} depended more upon total slot area than changes in pressure, and that the farther forward the slot was located along the chord the greater was the effect produced.

Forward Opening Sharp Edge Slots.— A study of the foregoing results led to the incorporation of the slot combination illus-

trated in Figure 20. The upper side of each slot was formed by a steel plate, the edge of which was ground to a 3-degree bevel. The front slot (Fig. 21) was formed by cutting away a portion of the wooden leading edge piece and carrying the metal cover plate forward. The lower sides of the two back slots (Fig. 10) were made up of brass formers. The slot widths were made adjustable.

It was believed that the high negative pressures and the apparent break in flow at the leading edge of this airfoil (see pressure distribution diagrams, Figures 5, 13, 14, and 19), made it somewhat unsuitable for boundary layer control. For this reason the leading edge was modified, as shown in Figure 21, and additional tests made with those forms of nose. Figure 22 gives typical pressure distribution diagrams for the airfoil with suction slots at 18 degrees. In Figures 23, 24, and 25, C_{NF} is plotted against α for the various slot and nose combinations tested. Figures 26, A, B, C, and D, give the per cent increase in C_{NF} plotted against C_{DS} . The values of C_{DS} were computed according to Appendix I (a and b).

Gauze-Covered Slots.— Upon inspection of the pressure distribution diagrams for normal opening slots (Fig. 19) and for sharp-edge forward-opening slots (Fig. 22), it will be noticed that a sharp break occurs in the pressure curve at the position of each slot. This break apparently is caused by a rapid change in velocity or direction of the air flow near the slot. The result is that the pressure rises abruptly just back of the slot.

This condition decreases the coefficient of normal force accordingly and may be the cause of disturbed flow. It is believed that if the boundary layer could be removed less abruptly the above condition could be eliminated. The ideal condition would be realized if there were an infinite number of small holes over the upper surface. As this arrangement is impractical from a construction standpoint, the gauze-covered slots which are described below were used.

The slots, as shown in Figure 27, were covered with a fine, open-mesh cloth and tested with the second modification of the leading edge as in Figure 21. In Figure 25, C_{NF} is plotted against angle of attack, and Figure 28 shows a typical pressure distribution diagram taken at 18 degrees and $-3 q$ pressure. The per cent increase in C_{NF} is plotted against C_{DG} for a slot pressure of $-3 q$ in Figure 29. C_{DG} was computed according to Appendix I (a and b).

D i s c u s s i o n

Pressure Slots.— The backward opening pressure slots with or without pressure have no apparent detrimental effect upon the normal characteristics of the airfoil, and with high pressures large lift increases are obtained. The kinetic energy of the air discharged through the slots per unit time is plotted against per cent increase of C_{NF} in Figure 30, for 12 and 15 degrees angle of attack for various conditions. It appears that the in-

crease of C_{NF} is directly proportional to the kinetic energy of the jets. These results are subject to errors as outlined in Appendix I (c). The slots must discharge the air at an extremely small angle with the surface to be effective.

Suction Slots.— Without suction, all suction-type slots tested (Figs. 16, 17, and 22) have some detrimental effect but, with suction, give greater lift increases for the same C_{DS} than pressure slots, as may be seen by a comparison of Figures 15 and 26.

Figure 31 shows per cent increase of C_{NF} plotted against quantity of air flowing through the slots per unit time for various slot widths and pressures. These curves show that the increase in C_{NF} is directly proportional to the quantity of air flowing through the slots regardless of slot area or pressure. However, to handle a given quantity of air (for a given increase in C_{NF}) it is more economical to use large slot areas and low pressures because the power required is directly proportional to the pressure inside the wing.

In Figure 22, pressure distribution diagrams for forward opening slots, a pronounced step occurs at the front and rear slots. The step is produced by a sudden change in velocity or direction of air flow at the slot. The pressure distribution diagram for gauze-covered slots (Fig. 28) has a slight step at the slot positions but shows considerable improvement over the sharp-edge slots.

Gauze-covered slots gave larger increases in C_{NF} than other suction slots, and with a lower power requirement (C_{DS}) for the same C_{NF} increase.

C o n c l u s i o n s

1. The maximum lift of an airfoil may be increased by controlling the boundary layer by suction or jet action.

2. The increase in the maximum coefficient of normal force is directly proportional, within the limits tested; to the kinetic energy of the jet per unit time for pressure slots, and to the quantity of air flowing per unit time through the suction slots.

3. It is more economical to control the boundary layer by suction than by jet action.

4. When not in operation, all slots tested, with the exception of those opening rearward, had a detrimental effect upon the aerodynamic characteristics of the airfoil.

5. The ideal type of slot would be one which would give little or no detrimental effect when not in operation, especially at low angles of attack, and which in operation would control the boundary layer without interfering with smooth flow.

6. Thick, blunt-nosed airfoils would seem to give best results with boundary layer control.

7. Important changes in the normal aerodynamic characteristics of airfoils appear to be possible through the medium of boundary layer control.

Langley Field, Virginia,

December 9, 1927.

A P P E N D I X I.

Part (a).

Computation of an absolute drag coefficient equivalent
 to the power required to draw or expel air
 through the slots.

Let S = wing area (3.19 sq.ft.).

V = air-stream velocity (64.2 ft. per sec.).

q = dynamic pressure (4.91 lb. per sq.ft.).

P_w = difference between pressure within the wing and static pressure.

$$n = \frac{P_w}{q}$$

Q = volume of air passing through slots per unit time (cu.ft. per sec.).

D_S = hypothetical drag which, if acting on wing, would necessitate expenditure of power $P_w Q$, that is,

$$V D_S = n q Q$$

$$C_{DS} = \frac{D_S}{qS} \qquad (D_S = \frac{n q Q}{V})$$

$$= \frac{nQ}{SV} = 0.0049 n Q.$$

The pressure was maintained at constant values such that n was always integral; Q was obtained according to part (b) from the supercharger revolutions or part (c) computed from the pressures.

Part (b)

Determination of Q - the volume of air passing through the slots per unit time from the supercharger.

The N.A.C.A. Roots type supercharger which was used to pump air to or from the wing during these tests has been extensively tested in the laboratory and it has been found that its delivery can be quite accurately computed according to the formula

$$Q = (N - N_s) D$$

wherein Q = delivery in cu.ft. per sec.

N = revolutions of rotors per second.

N_s = "slip speed" in r.p.s.

D = displacement per revolution in cu.ft. (0.1875 cu.ft.)

when N_s is taken as the speed required to maintain a given pressure at no delivery. That is, N_s depends upon the pressure change within the compressor and is, for all practical purposes, independent of Q .

For the determination of the quantities of air used in these tests, the slip curve (N_s V_s delivery pressure) was determined

by blocking the air duct at the end of the airfoil and noting the pressures maintained at various supercharger speeds. During the tests of the airfoil, the N required to maintain the desired pressure was observed for each test condition and the air quantity computed according to the above formula.

Part (c)

Determination of Q - the volume of air used by the slots per unit time (pressure slots only).

- Let P_w = difference between pressure within the airfoil and static pressure.
- P_r = difference between pressure at the slot and static pressure.
- q = dynamic pressure.
- $n = \frac{P_w}{q} \qquad n_1 = \frac{P_r}{q}$
- V_s = velocity of air flowing through the slot in feet per second.
- A_s = area of slot square feet
- C = slot coefficient assumed to be unity.

From $V = \sqrt{2gh}$

$V_s = 8 \times 64.2 \sqrt{n + n_1}$

$Q = V_s \times A_s \times C \qquad (C = 1)$

$= A_s \times 64.2 \sqrt{n + n_1}$

and from part (a)

$$C_{DS} = \frac{A_S \times 64.2 \sqrt{(n + n_1) n}}{V S}$$
$$= .313 \times A_S \times n \sqrt{n + n_1}$$

P_1 the pressure at the slot was sealed from the faired pressure distribution diagrams.

Due to the fact that P_1 could not be accurately determined, and that C was considered as unity there may be considerable error in the absolute value of these results, but for purposes of comparison they may be considered satisfactory.

B i b l i o g r a p h y

1. Fales, E. N. : Tests of Pneumatic Means for Raising
 and : Airfoil Lift and Critical Angle.
Kerber, L. V. : Journal of the Society of Automotive
 Engineers, May, 1927, 575-581.
2. Lachmann, G. : Experiments with Slotted Wings. N.A.C.A.
 Technical Note No. 71. (1921)
3. Lachmann, G. : Results of Experiments with Slotted Wings.
 N.A.C.A. Technical Memorandum No. 282.
 (1924)
4. Lachmann, G. : Results of Recent Experiments with Slotted
 Wings. N.A.C.A. Technical Memorandum No.
 298. (1925)
5. Wolff, E. B. : Preliminary Investigation of the Effect
 of a Rotating Cylinder in a Wing. N.A.C.A.
 Technical Memorandum No. 307. (1925)
6. Wolff, E. B. : Tests for Determining the Effect of a
 and : Rotating Cylinder Fitted into the Leading
Kening, C. : Edge of an Airplane Wing. N.A.C.A. Tech-
 nical Memorandum No. 424. (1926)
7. Ackeret, J, : Experiments with an Airfoil from Which
 Betz, A, : the Boundary Layer is Removed by Suction.
 and : N.A.C.A. Technical Memorandum No. 374.
Schrenk, O. : (1926)
8. Schrenk, O. : Experiments with a Sphere from Which the
 Boundary Layer is Removed by Suction.
 N.A.C.A. Technical Memorandum No. 388.
 (1926)
9. Ackeret, J. : Removing Boundary Layer by Suction.
 N.A.C.A. Technical Memorandum No. 395.
 (1926)
10. Handley Page, F. : Tests on an Airfoil with Two Slots Suita-
 ble for an Aircraft of High Performance.
 N.A.C.A. Technical Memorandum No. 369.
 (1926)

Fig. 1

Airfoil with upper
cover plate removed.

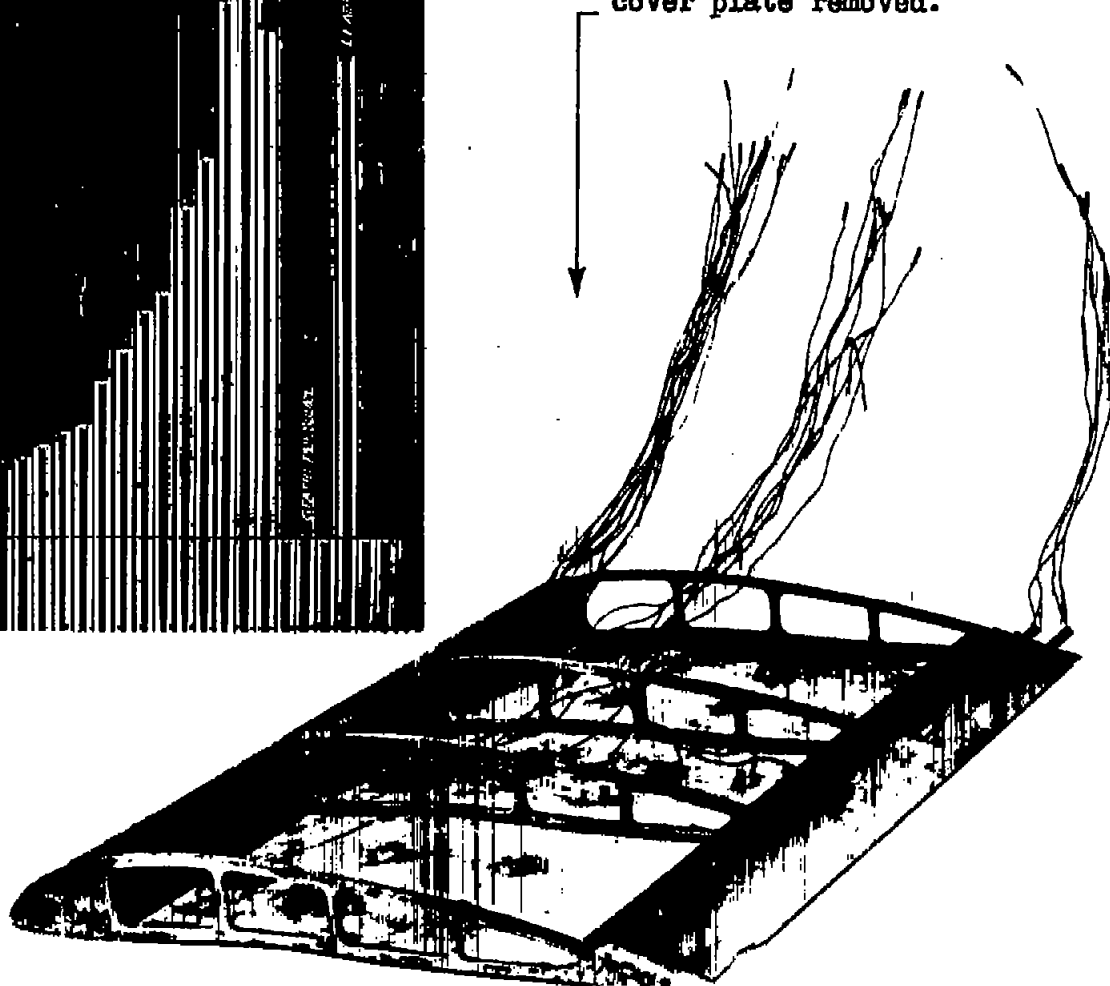
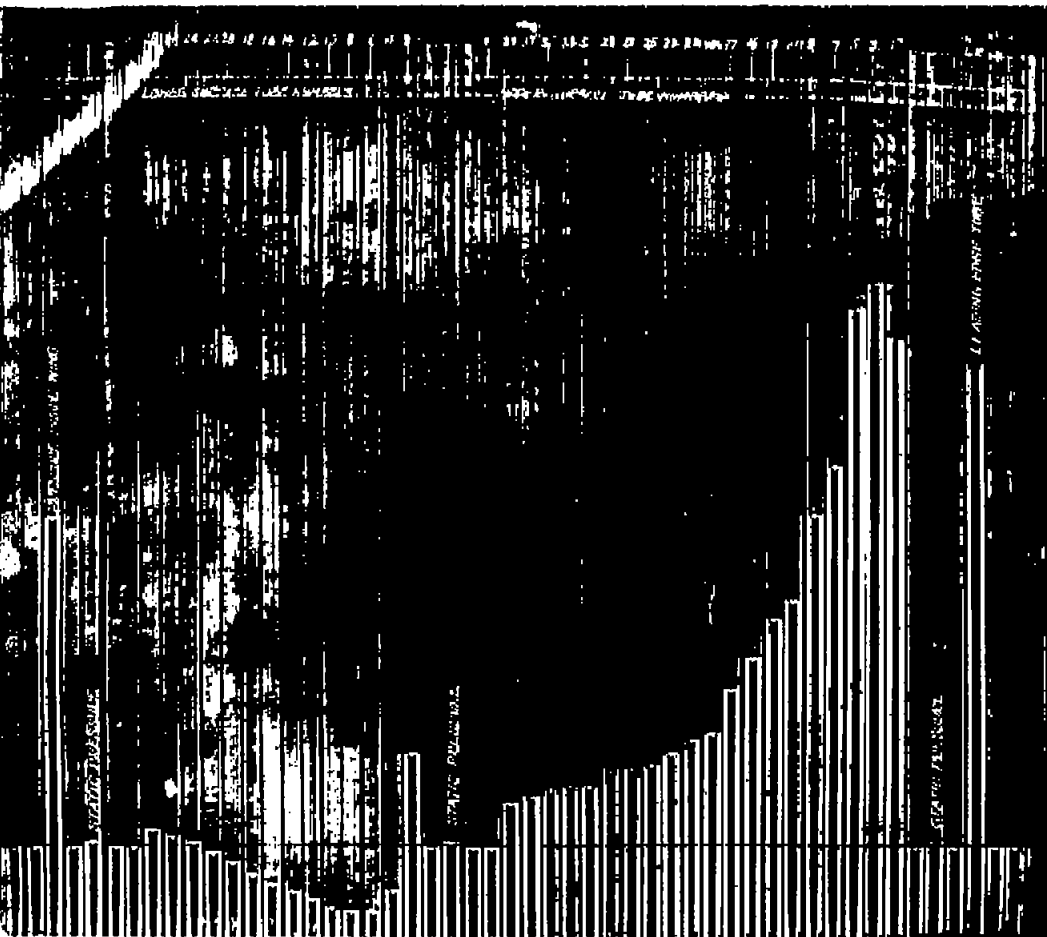

Fig. 4

Reproduction of
photographic
pressure record.



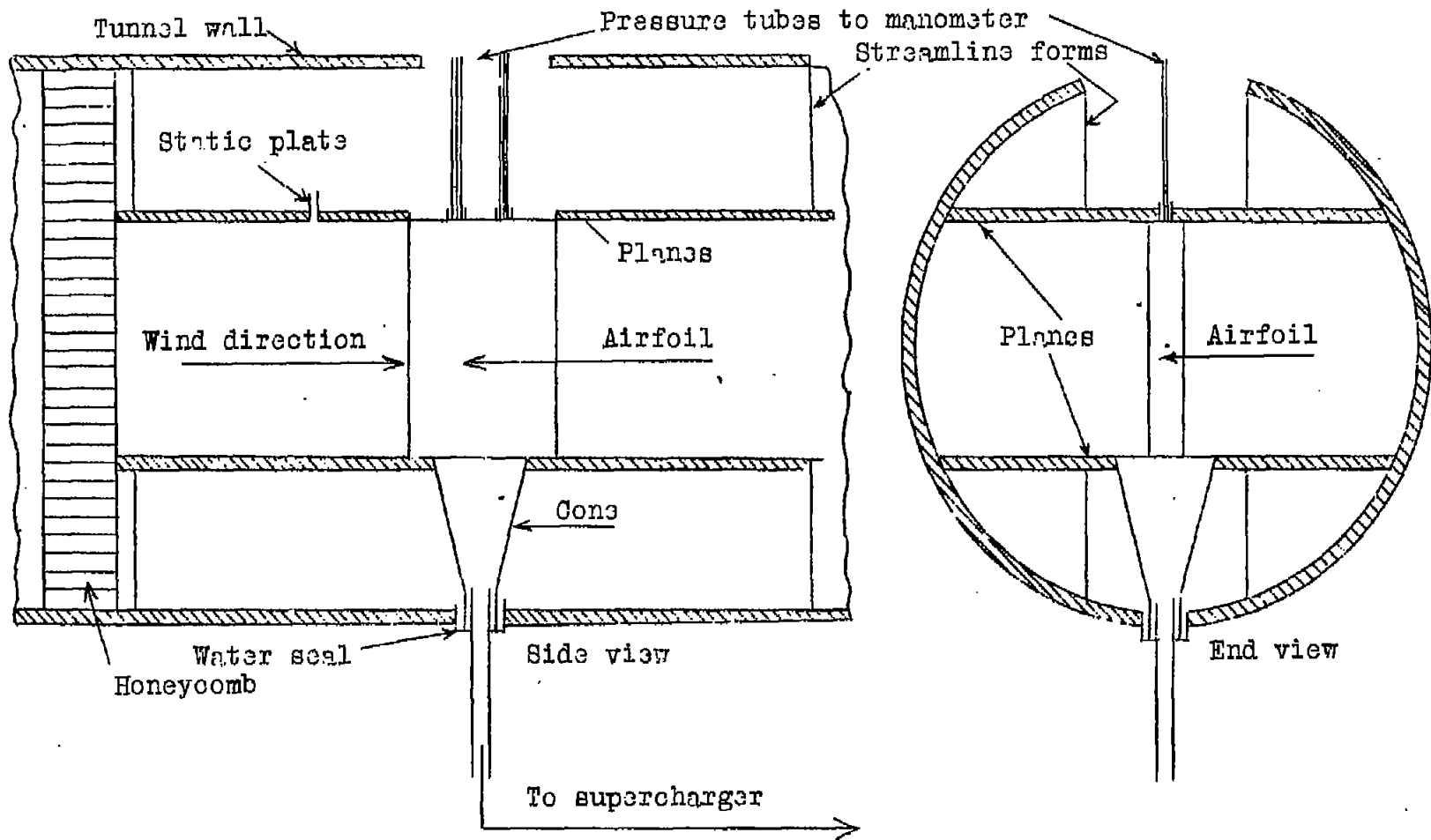

Fig. 2 Installation of airfoil in atmospheric wind tunnel.

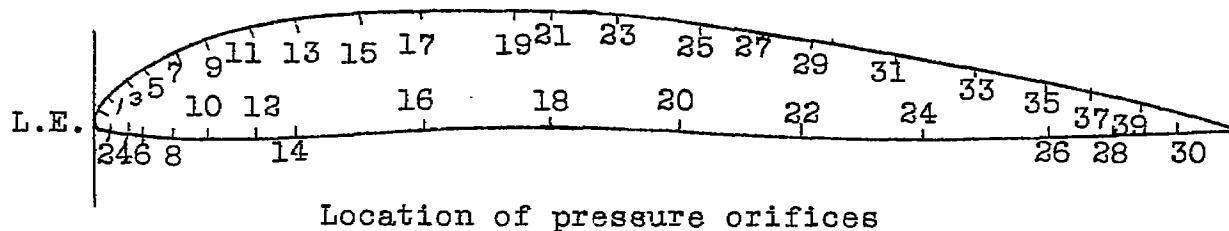

Fig.3

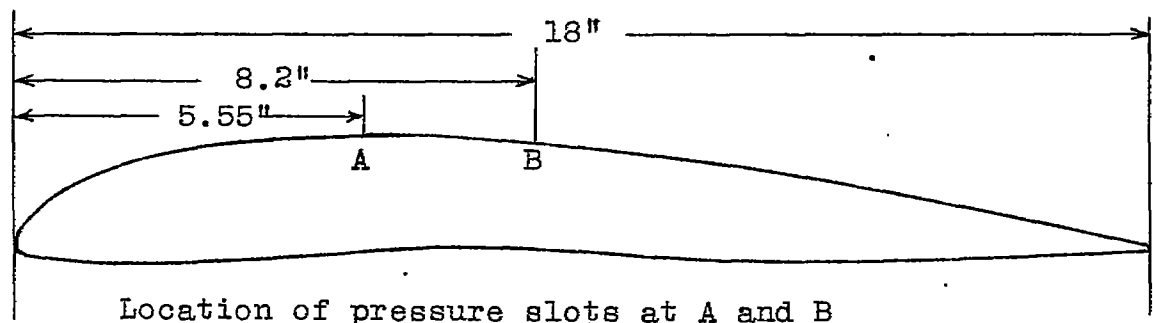
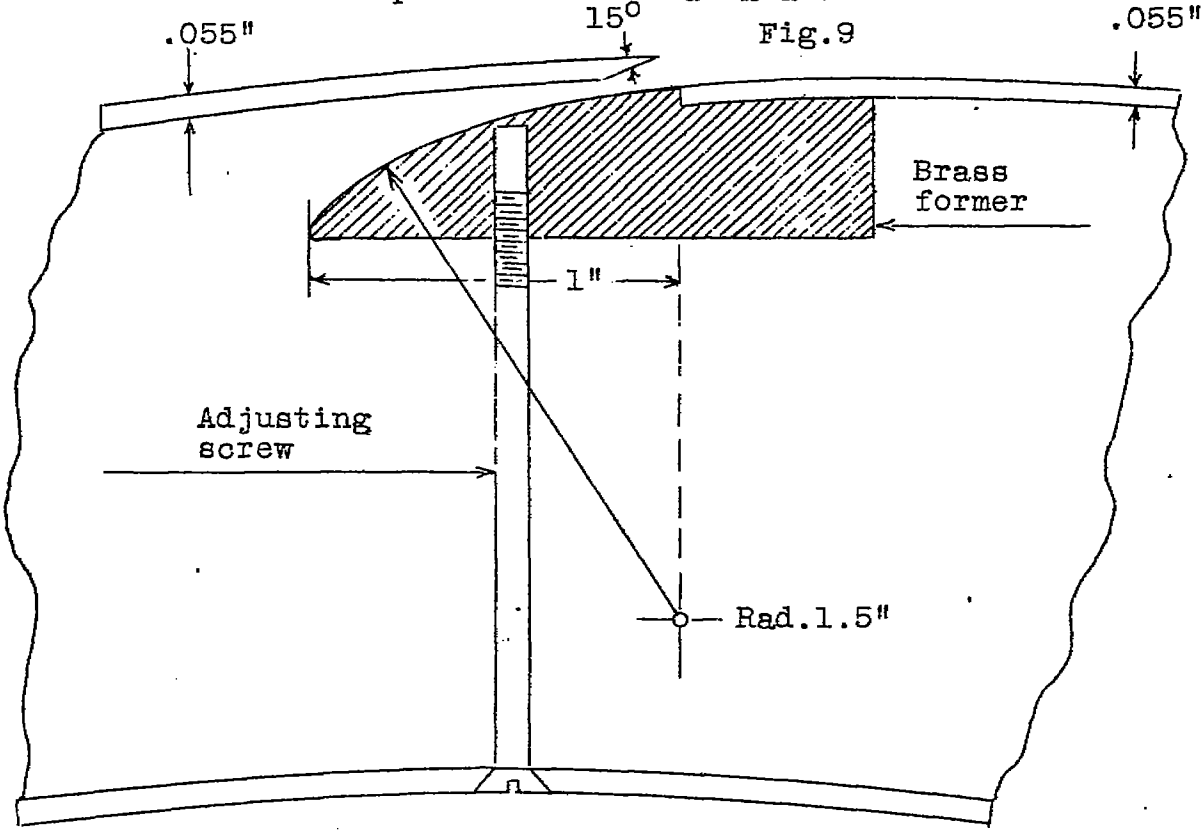

Fig.9



Pressure slot used at A Fig.9

Fig.8

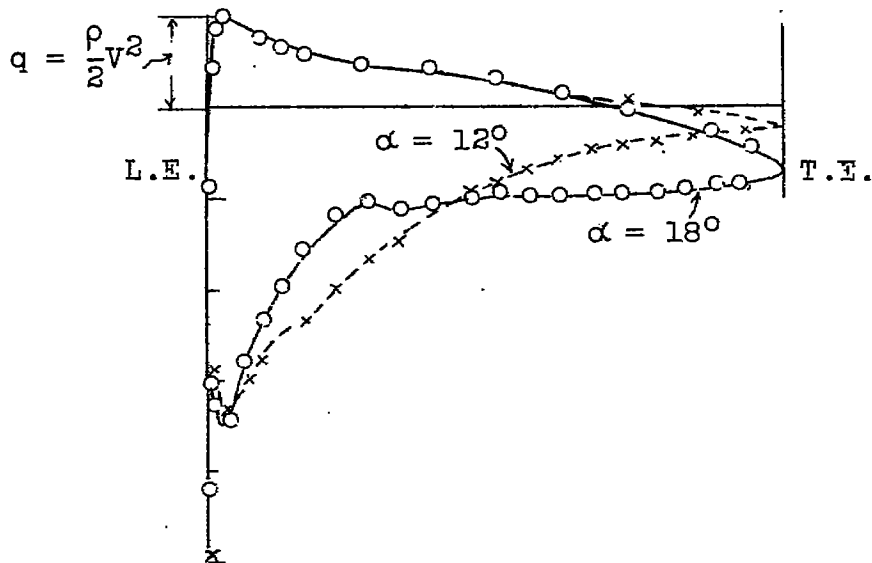

Fig.5 Pressure distribution diagrams for plain airfoil.

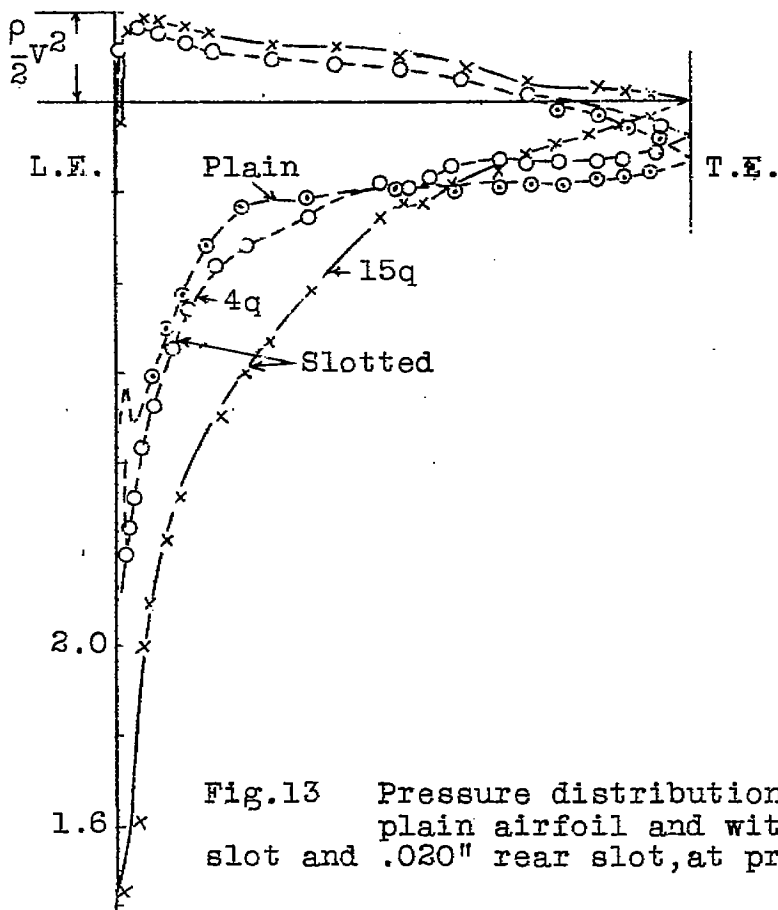

Fig.13 Pressure distribution diagrams for plain airfoil and with .018" front slot and .020" rear slot, at pressure of $4q$ & $15q$.

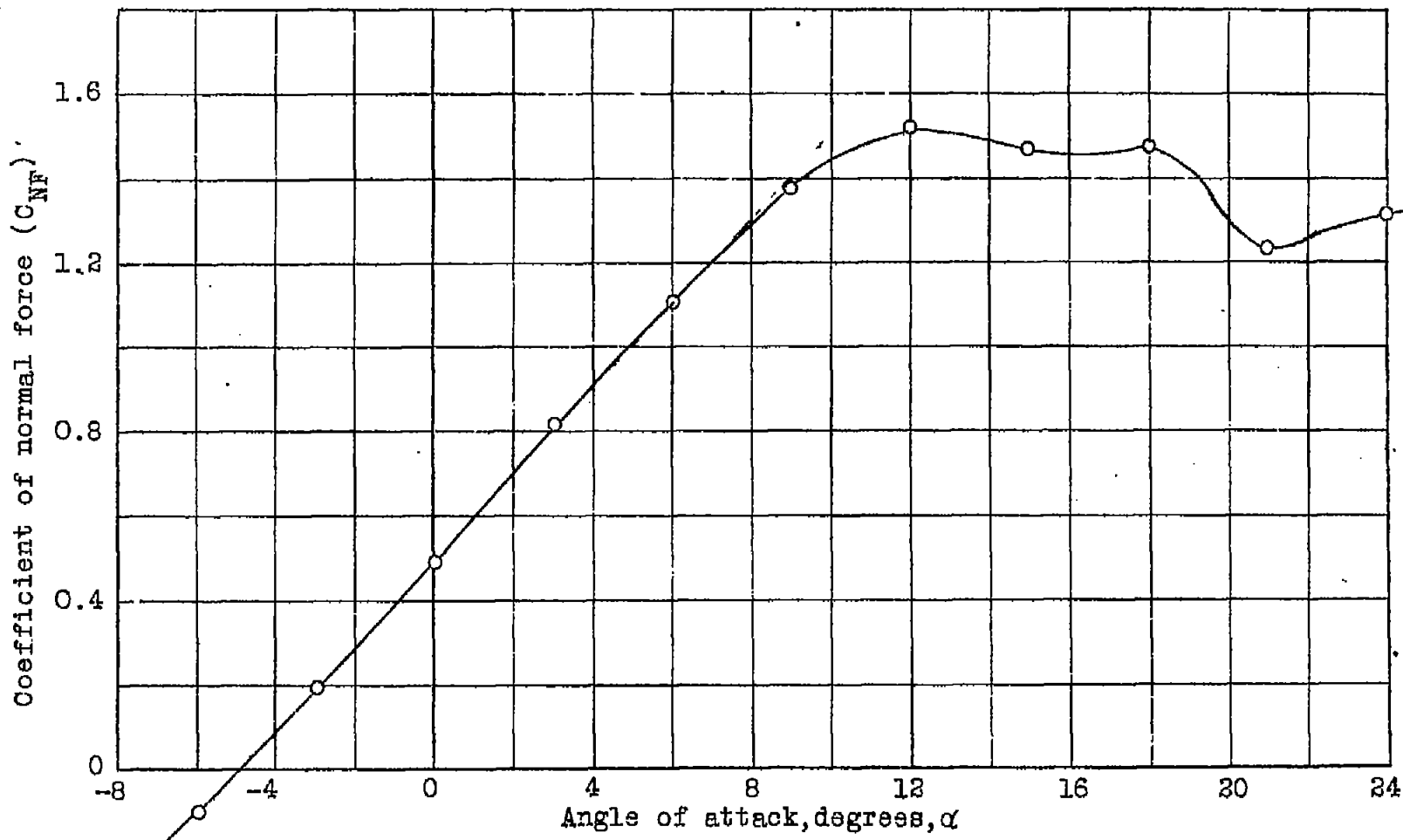

Fig.6 Coefficient of normal force vs. angle of attack. Plain airfoil.

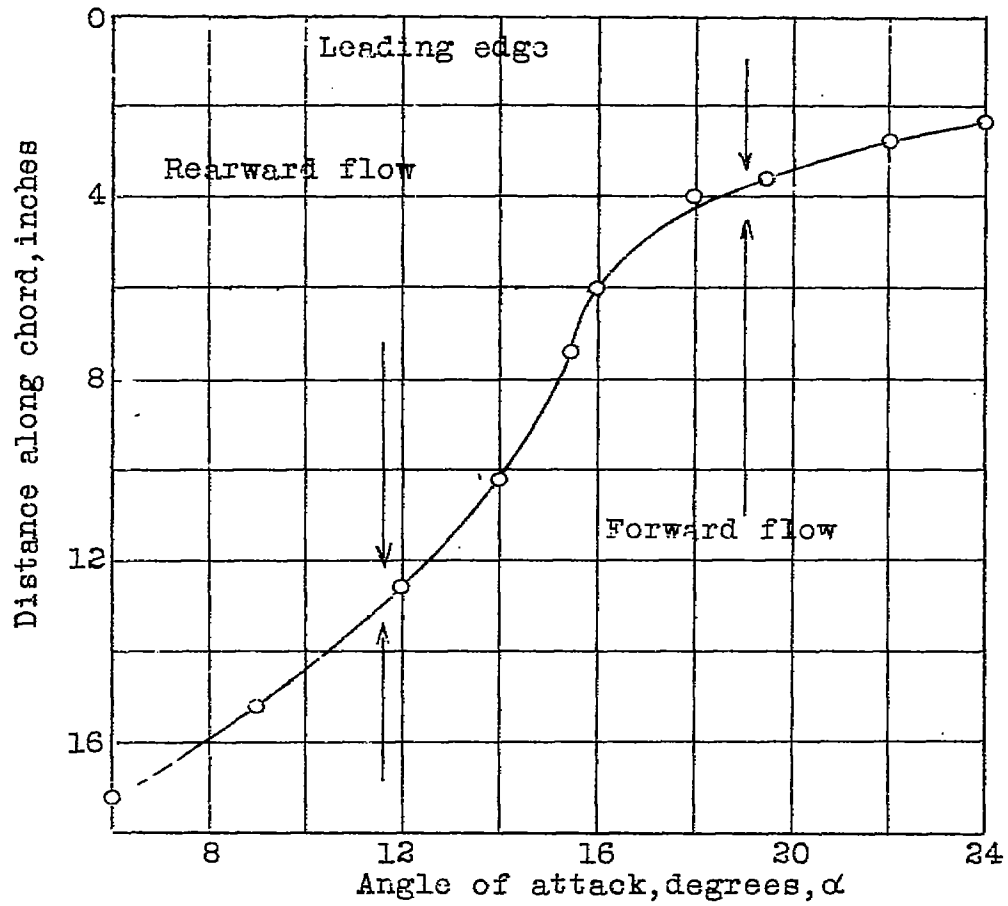

Fig.7 Position of point of discontinuity vs. angle of attack. Plain airfoil.

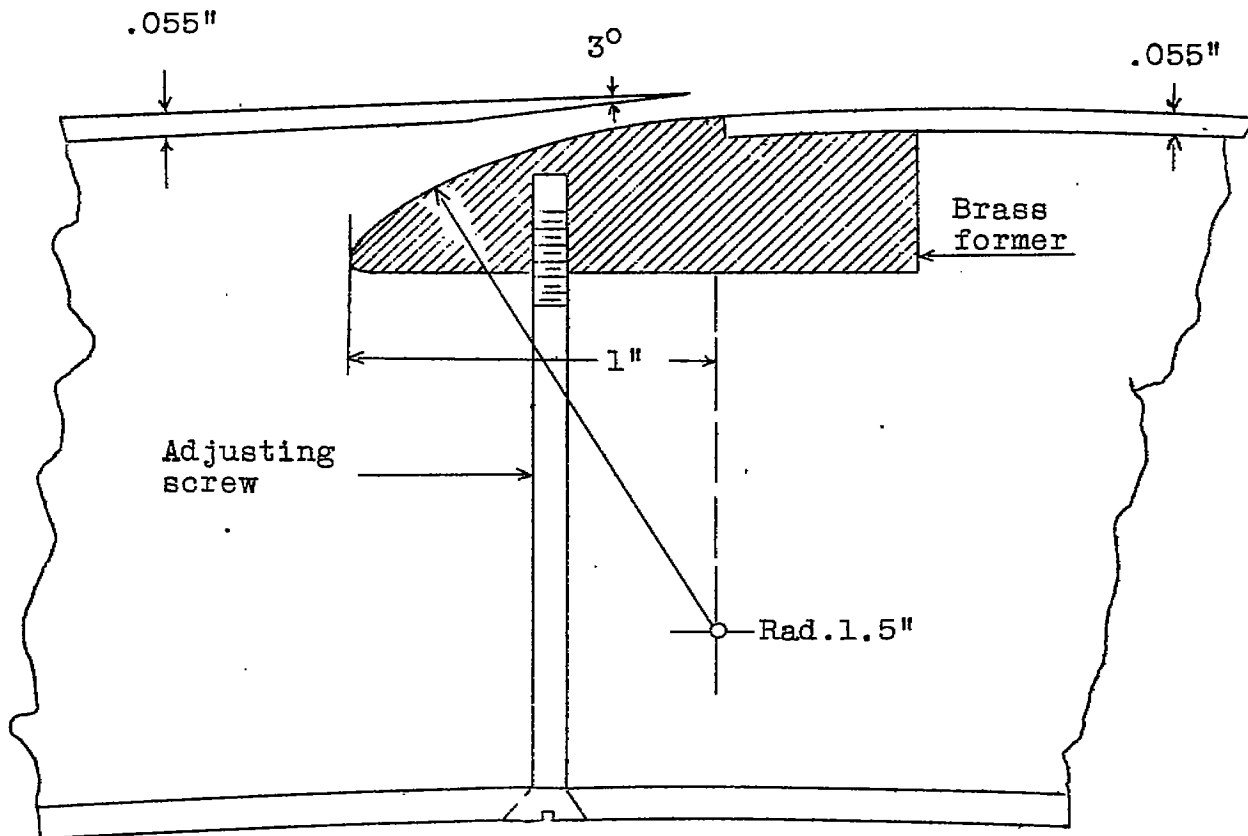

Fig.10 Improved slot used (rearward opening) for pressure and (forward opening) for suction.

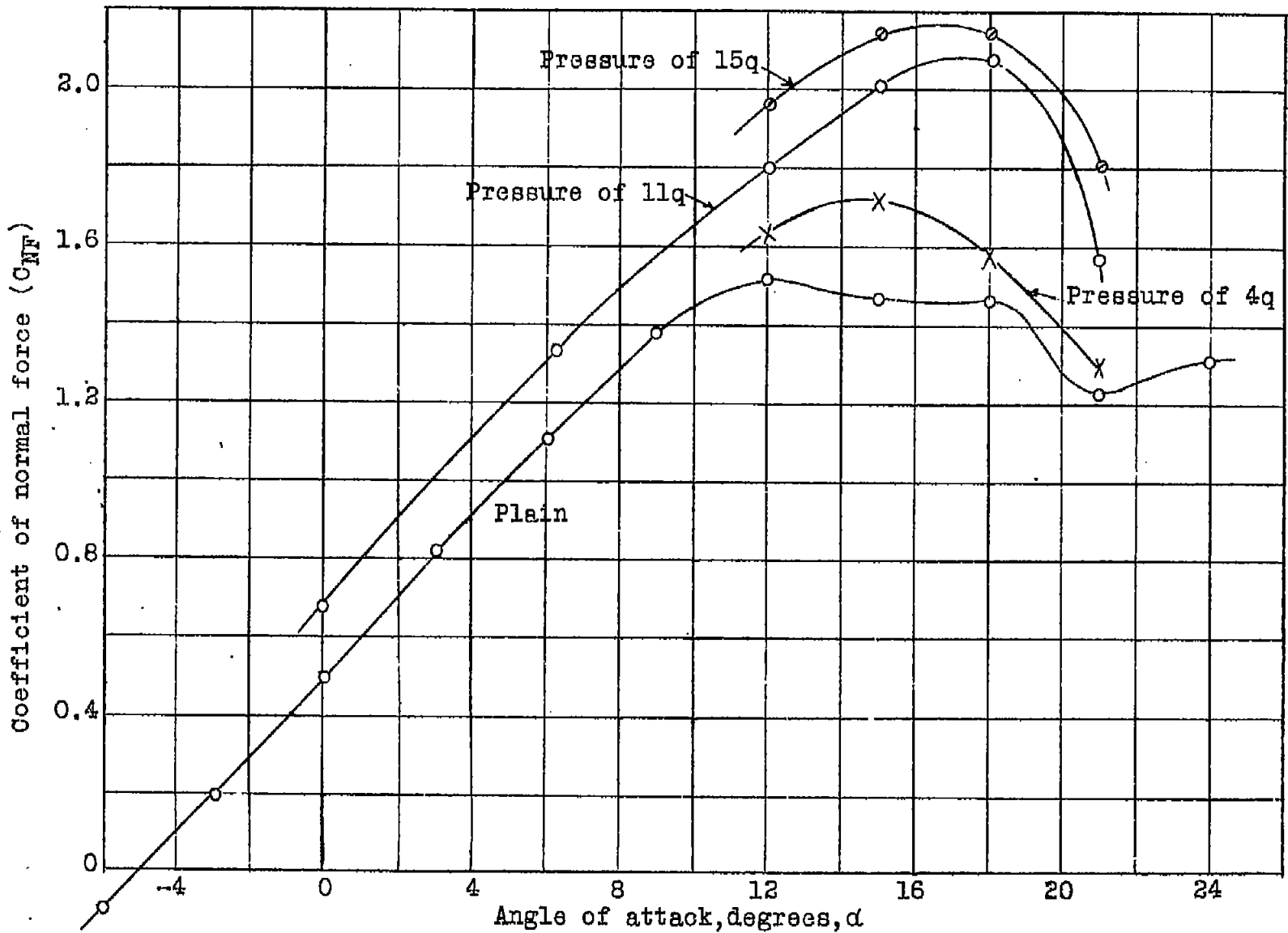

Fig. 11 Coefficient of normal force vs. angle of attack. Plain and with two pressure slots, front .018", rear .020".

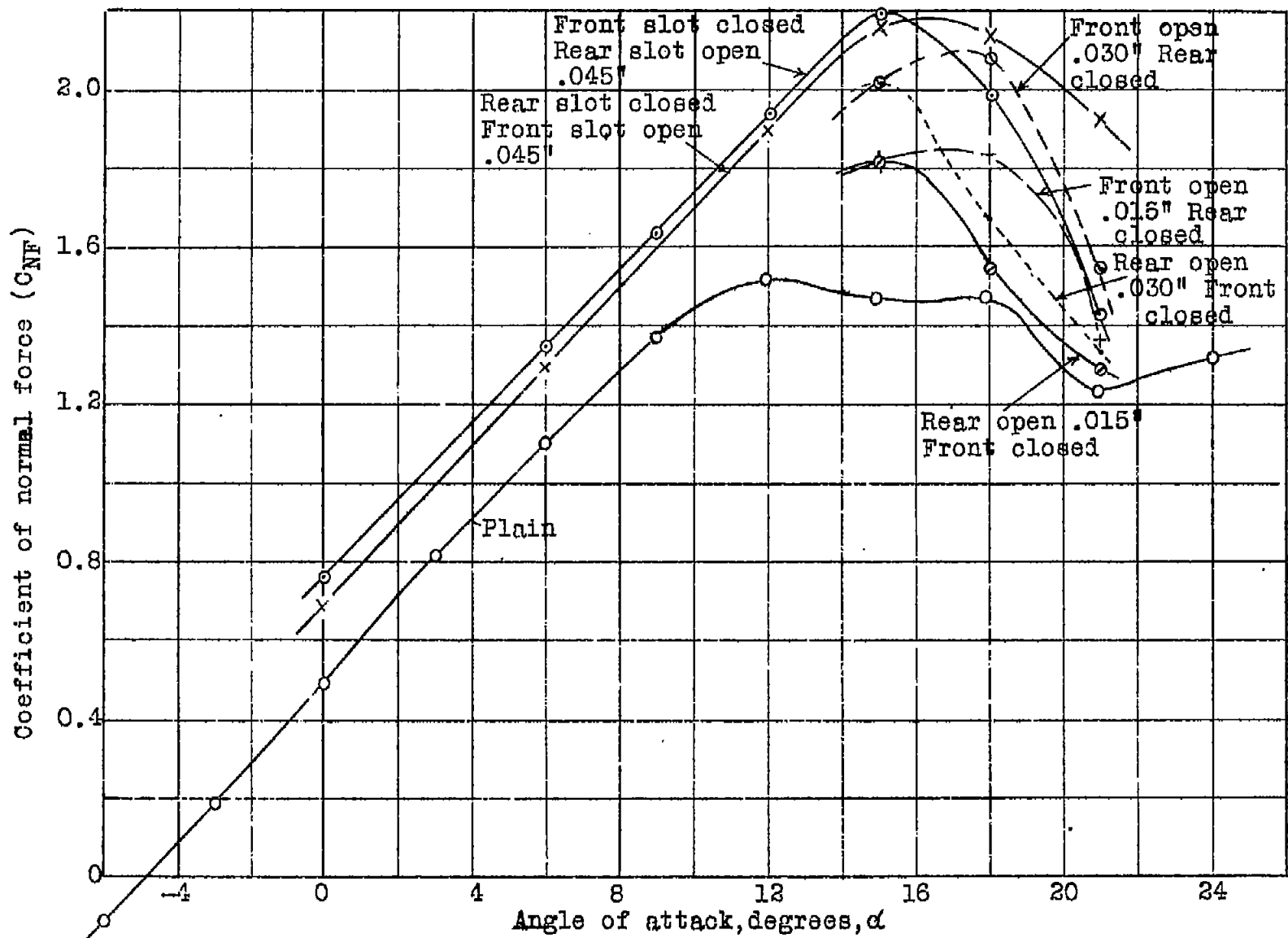

Fig. 12 Coefficient of normal force vs. angle of attack. Two pressure slots at a pressure of 11q. Slot openings and combinations as indicated.

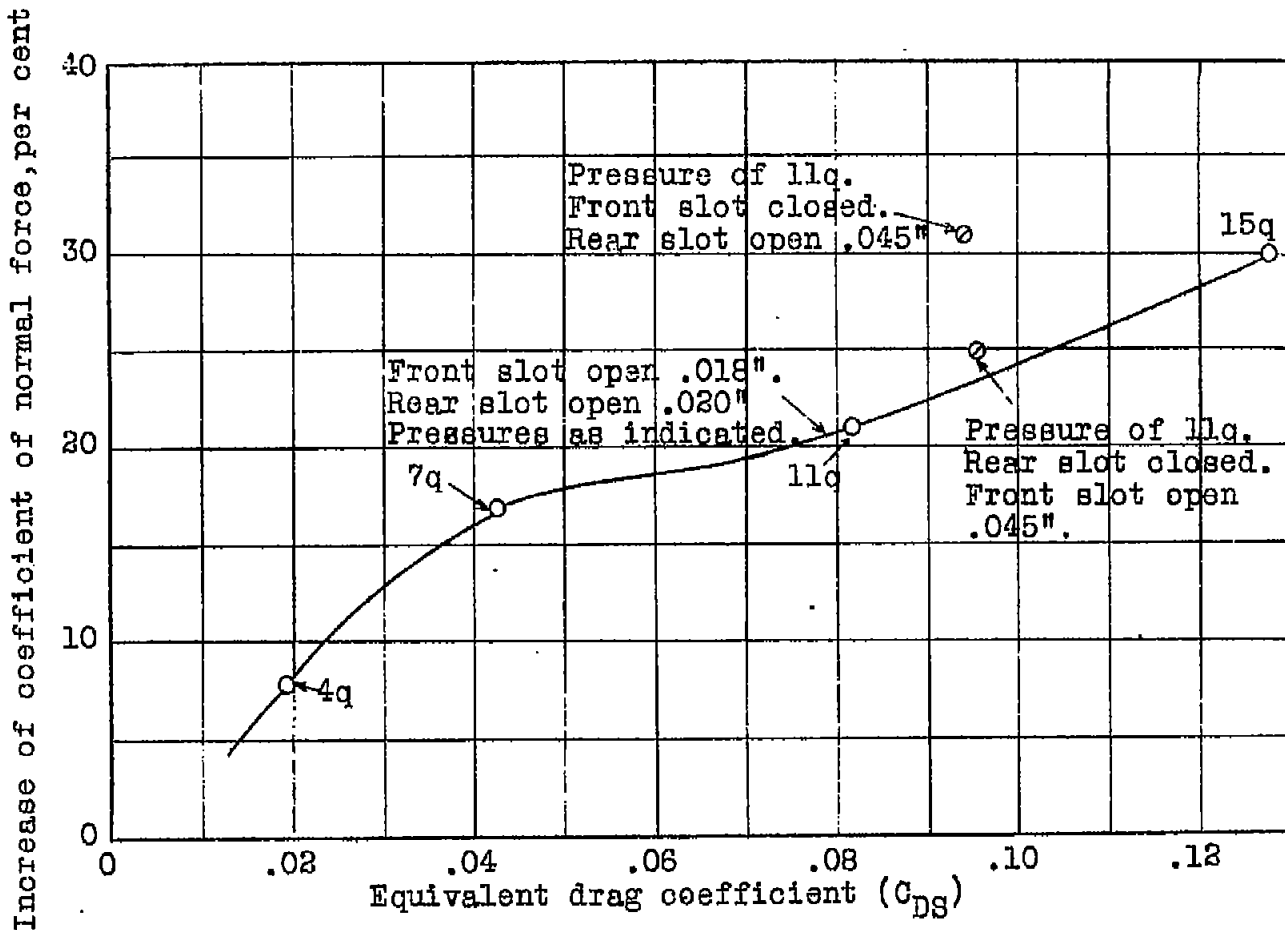

Fig.15A Angle of attack 12 degrees. Increase of coefficient of normal force vs. equivalent drag coefficient for various pressure slot openings, combinations and pressures as indicated.

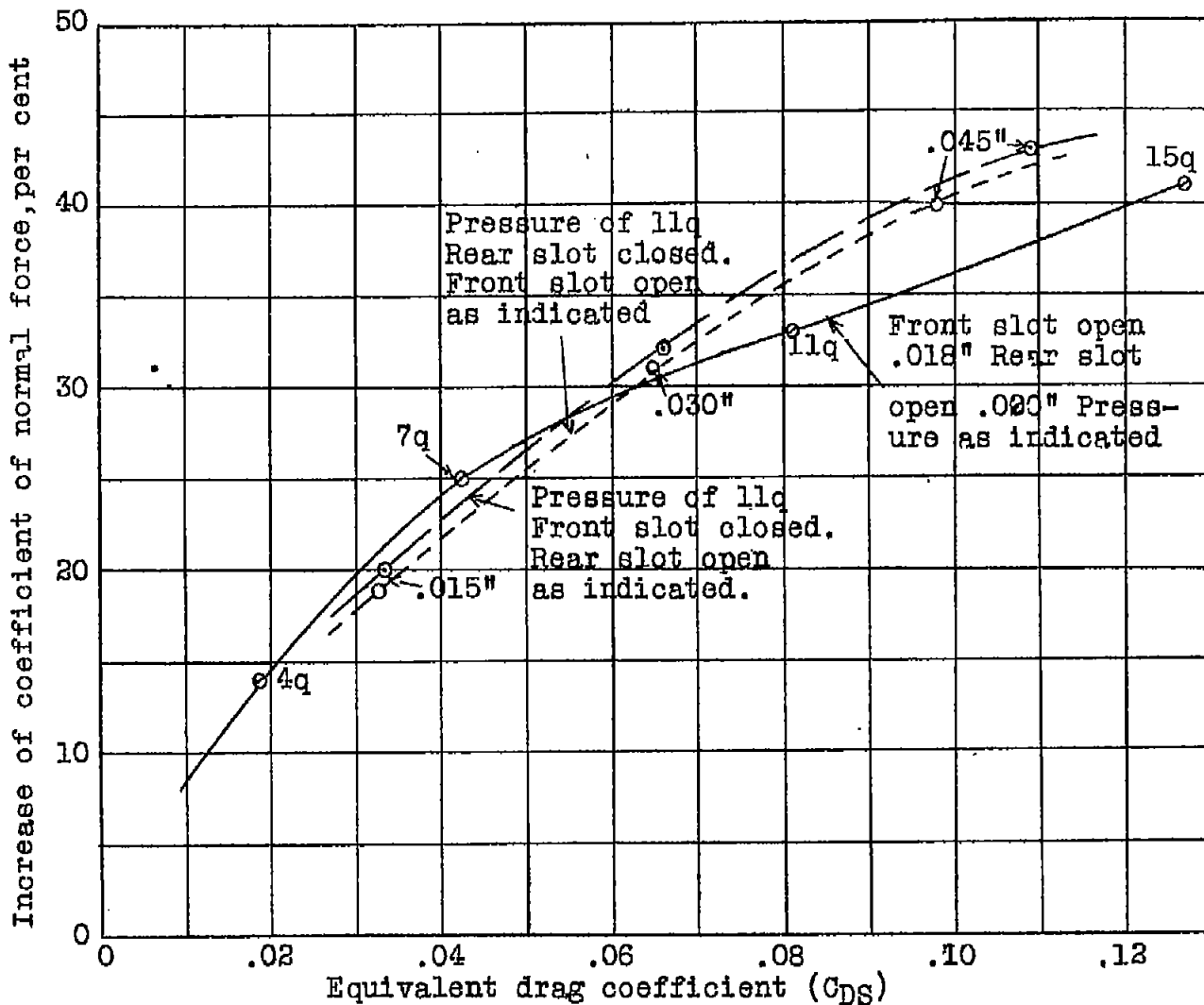

Fig.15B Angle of attack 15 degrees. Increase of coefficient of normal force vs. equivalent drag coefficient for various pressure slot openings, combinations and pressures as indicated.

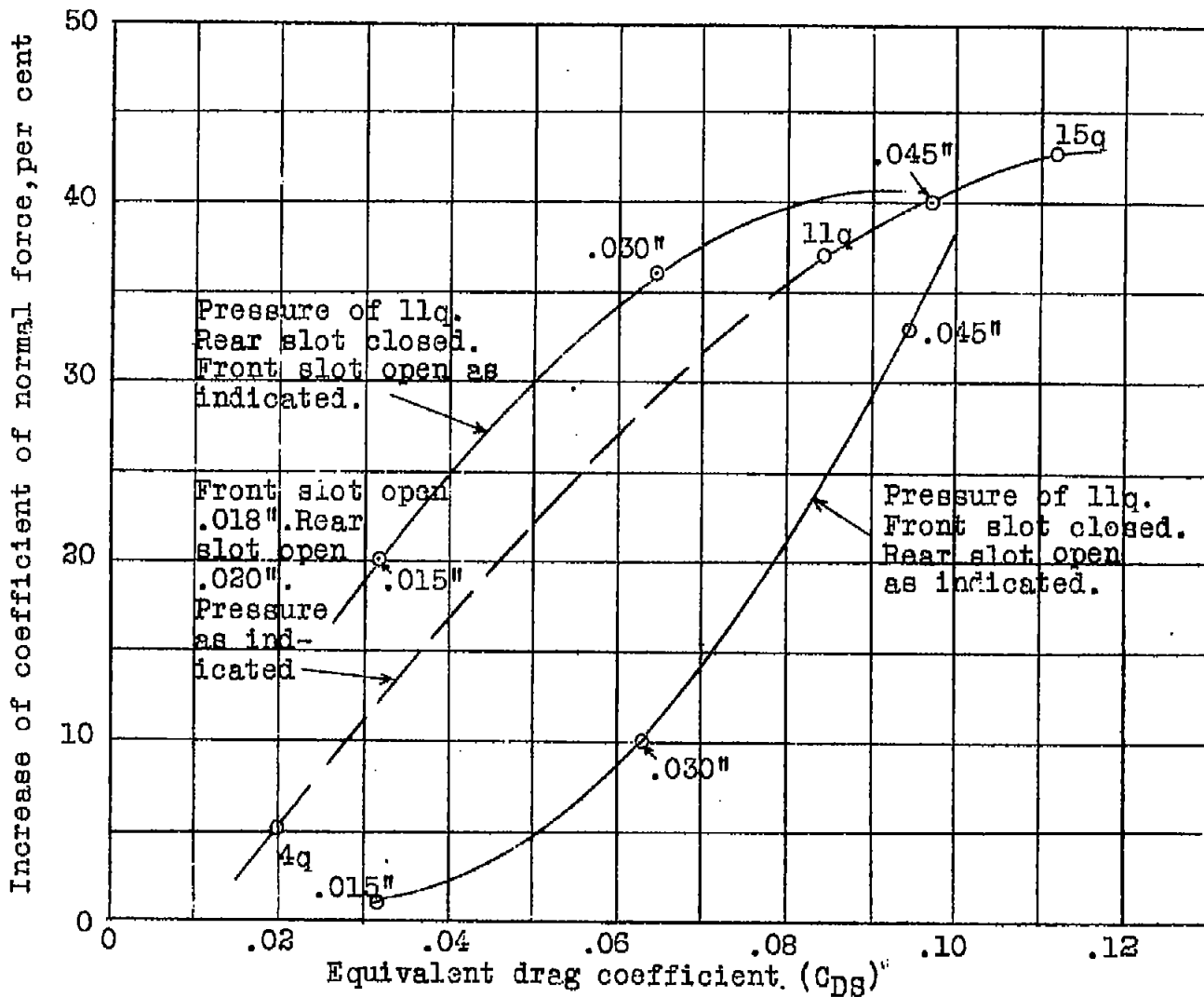

Fig.150 Angle of attack 18 degrees. Increase of coefficient of normal force vs. equivalent drag coefficient for various slot openings, combinations and pressures as indicated.

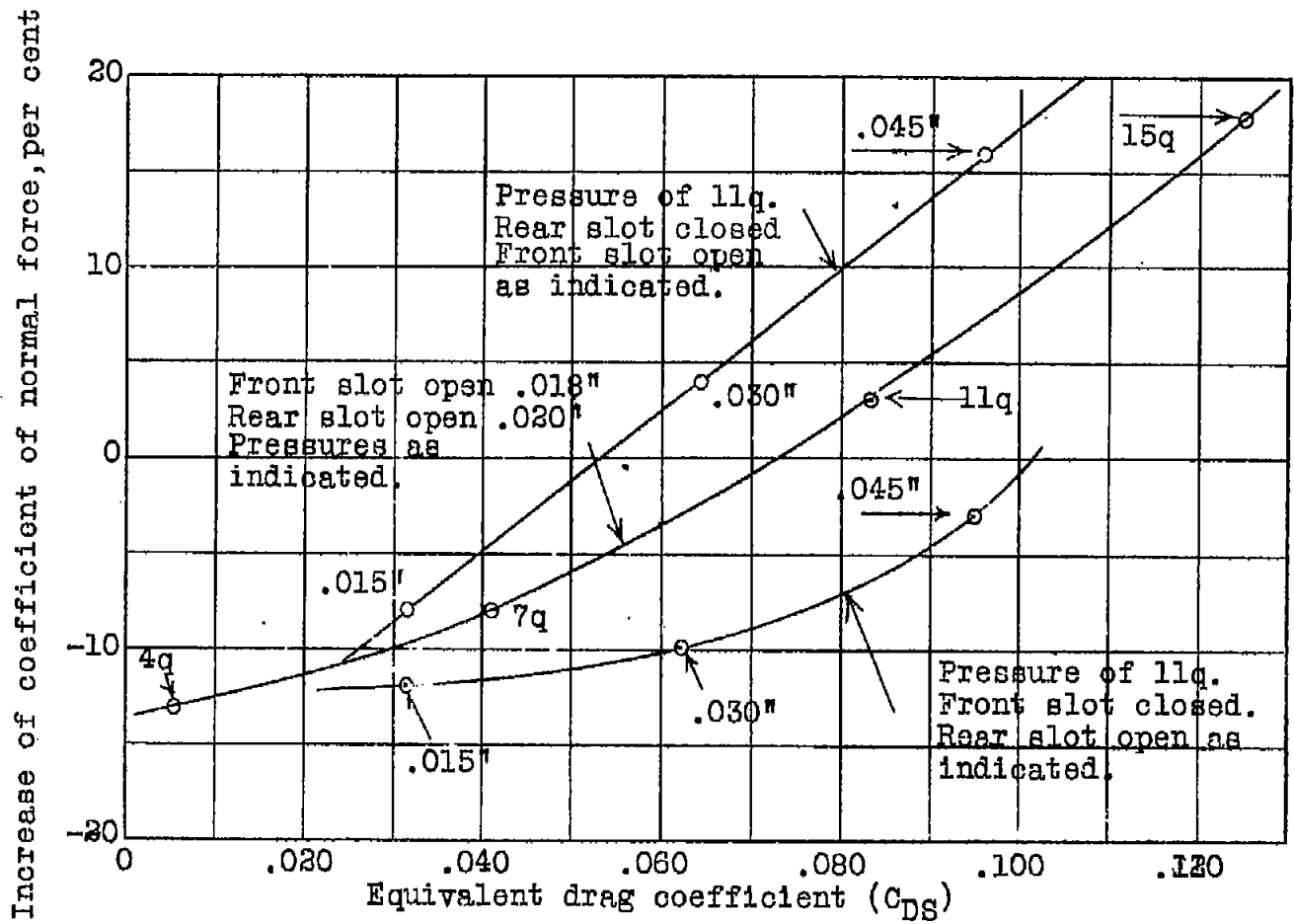

Fig.15D Angle of attack 21 degrees. Increase of coefficient of normal force vs. equivalent drag coefficient for various pressure slot openings, combinations and pressures as indicated.

N.A.C.A. Technical Note No. 286

FIG. 15D

N.A.C.A. Technical Note No.286

Fig.16

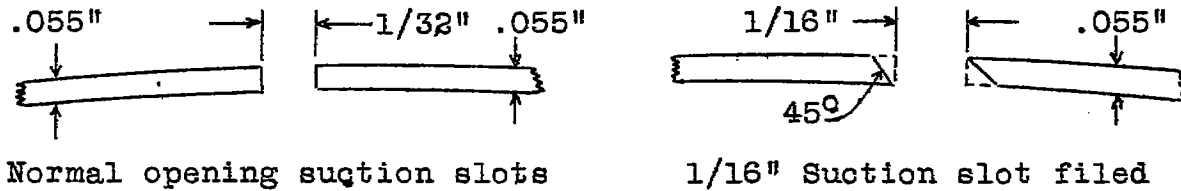
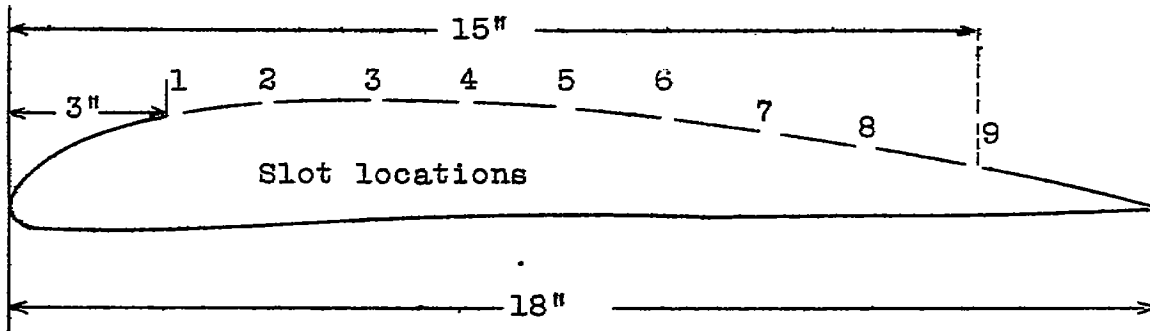

Fig.16

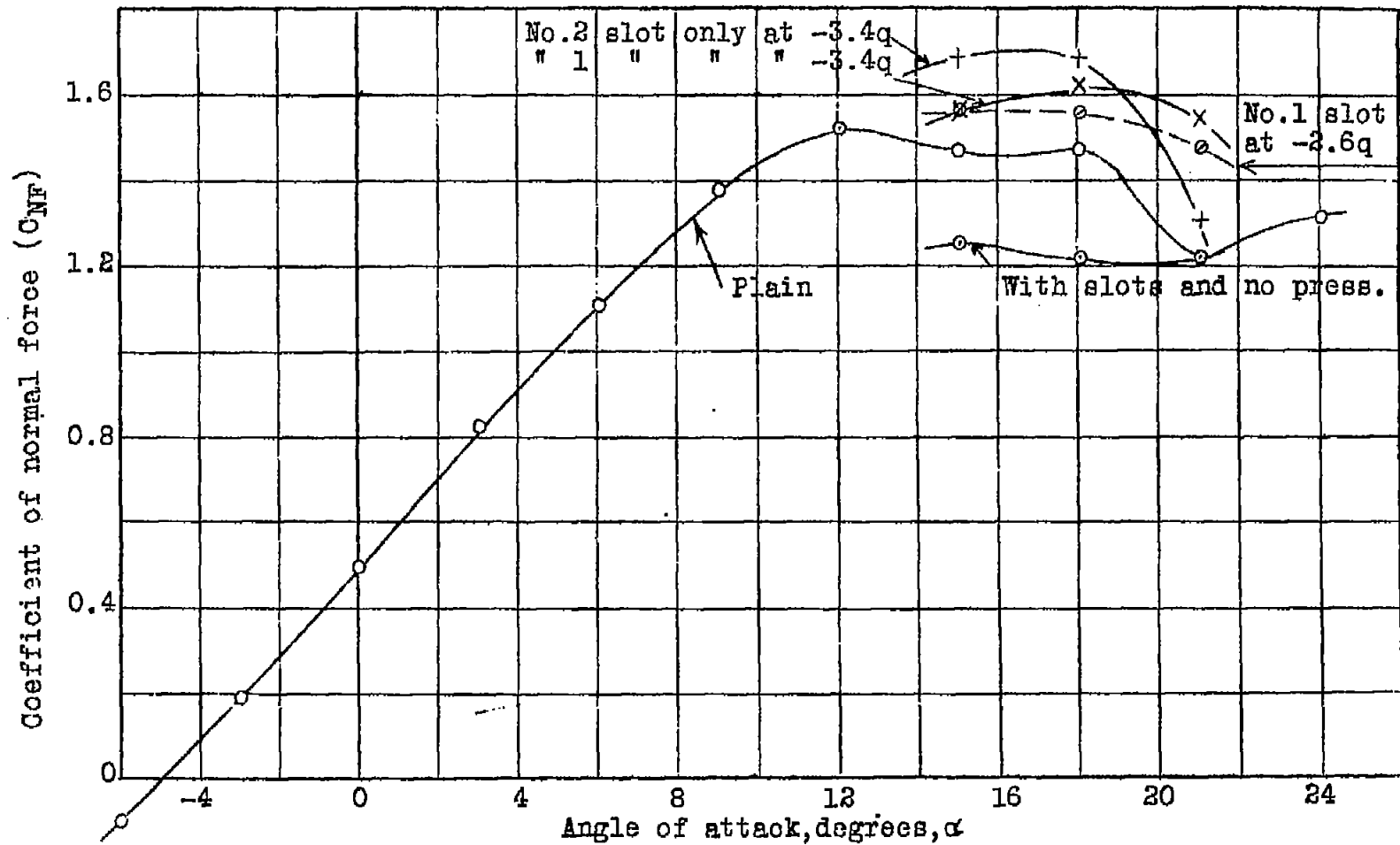

Fig.17 Coefficient of normal force vs. angle of attack. 1/16" normal opening suction slots No.1 and No.2. (For location of slots see Fig.16)

N.A.C.A. Technical Note No.286

FIG.17

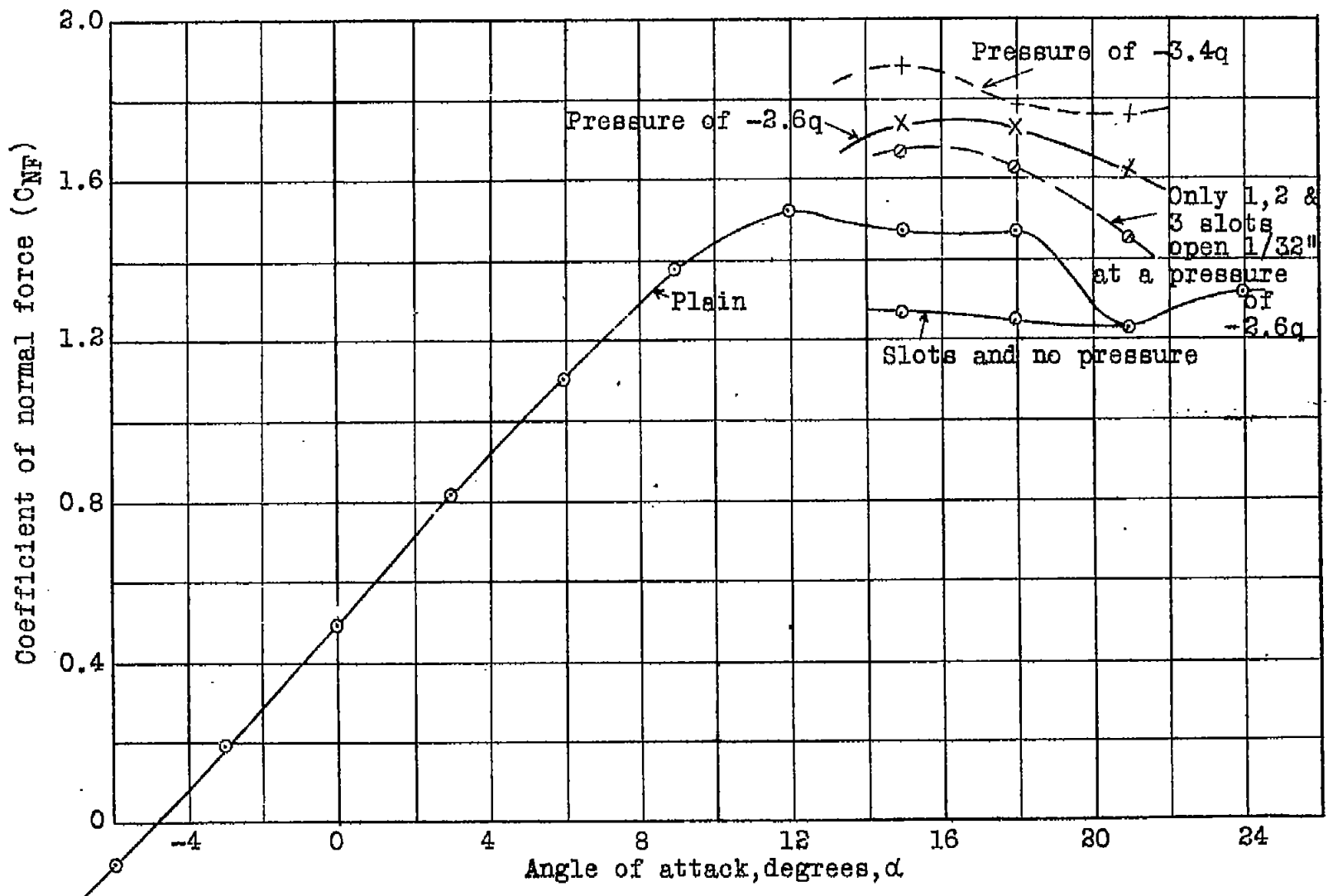

Fig.18 Coefficient of normal force vs. angle of attack. Slots No.1,2 and 3 open 1/16" and slot No.4 open 1/32". Pressures indicated. (For location of slots see Fig.16)

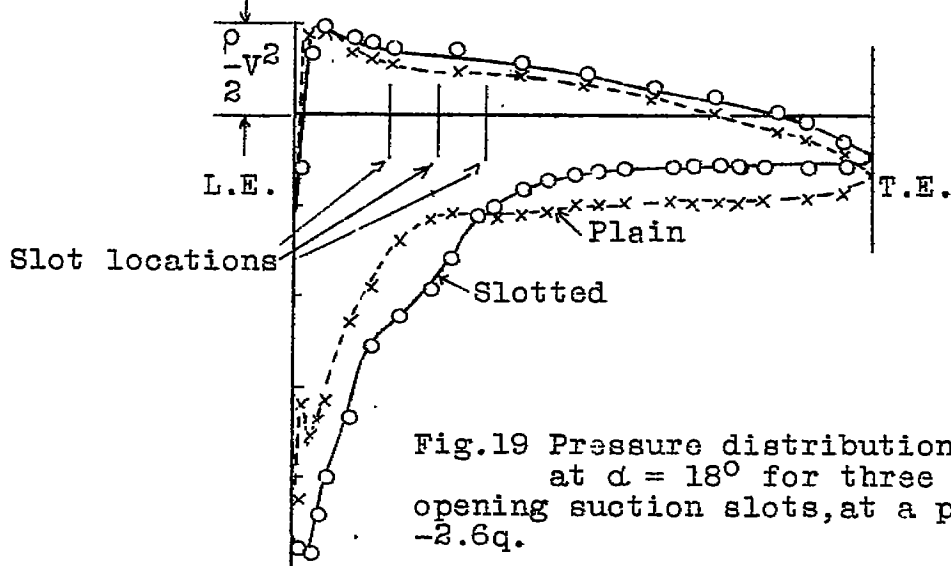

Fig.19 Pressure distribution diagrams at $\alpha = 18^\circ$ for three $1/32''$ normal opening suction slots, at a pressure of $-2.6q$.

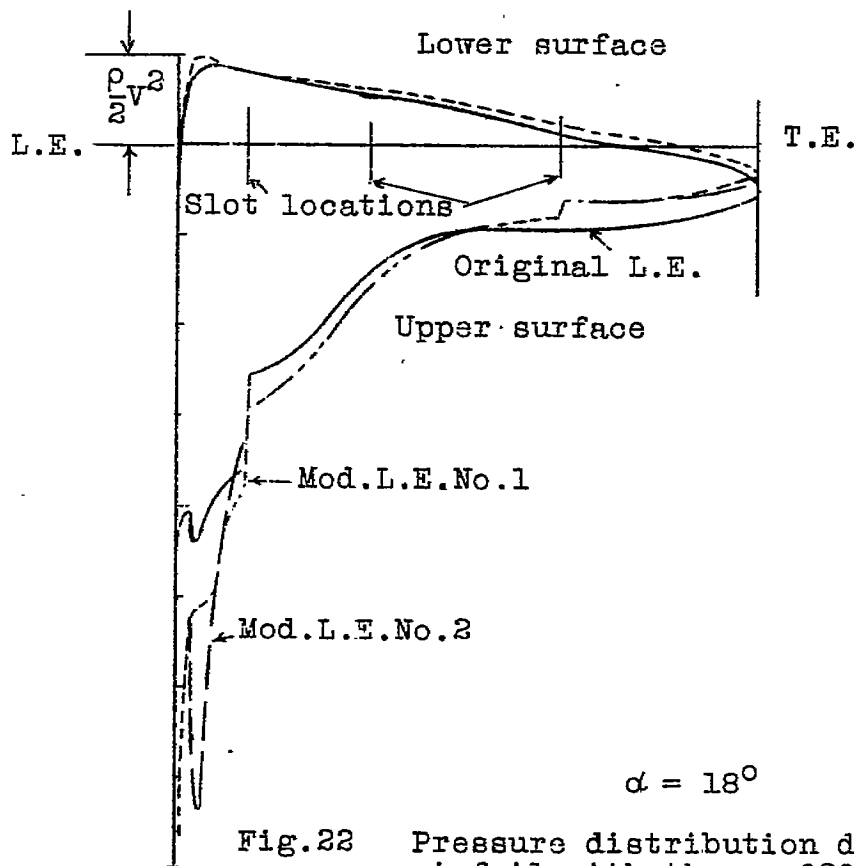

Fig.22 Pressure distribution diagrams for airfoil with three $.020''$ forward opening suction slots with original and 2 modifications of L.E. at a pressure of $-4q$.

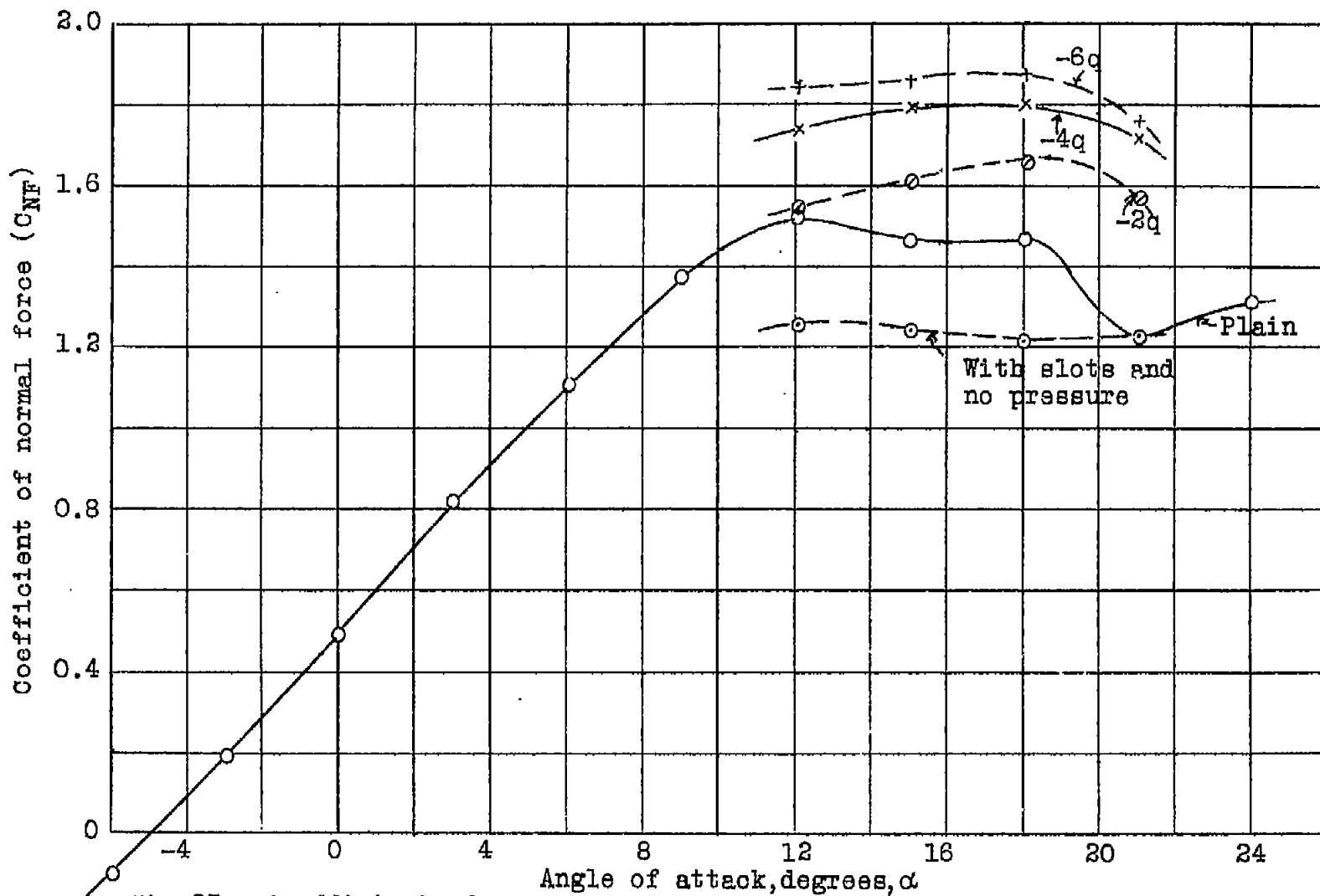

Fig.23 Coefficient of normal force vs angle of attack. Three .020 inch forward opening suction slots at pressure of 0, $-2q$, $-4q$ and $-6q$.

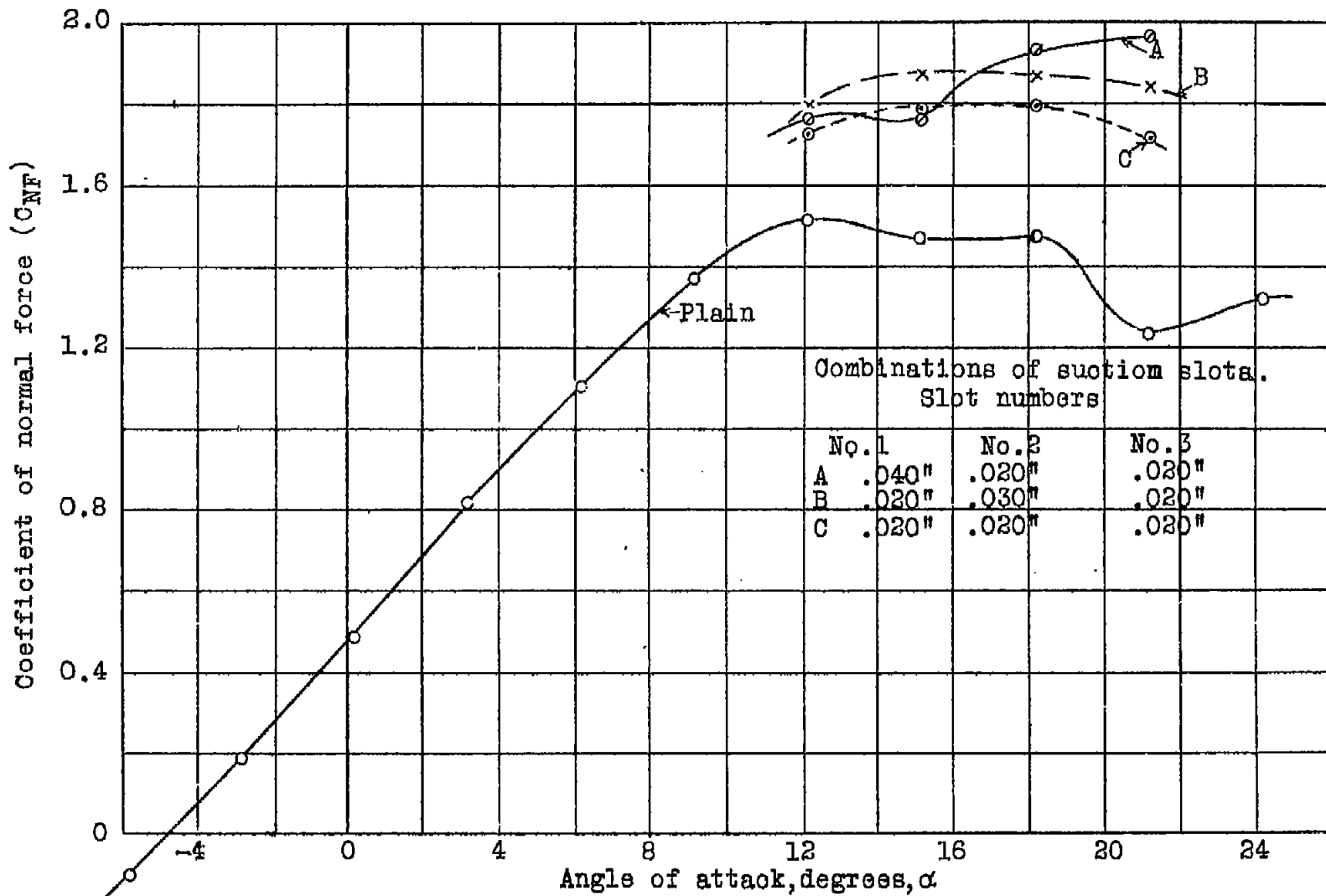

Fig. 24 Coefficient of normal force vs angle of attack. Three forward opening suction slots with various slot openings. Pressure of $-4q$.

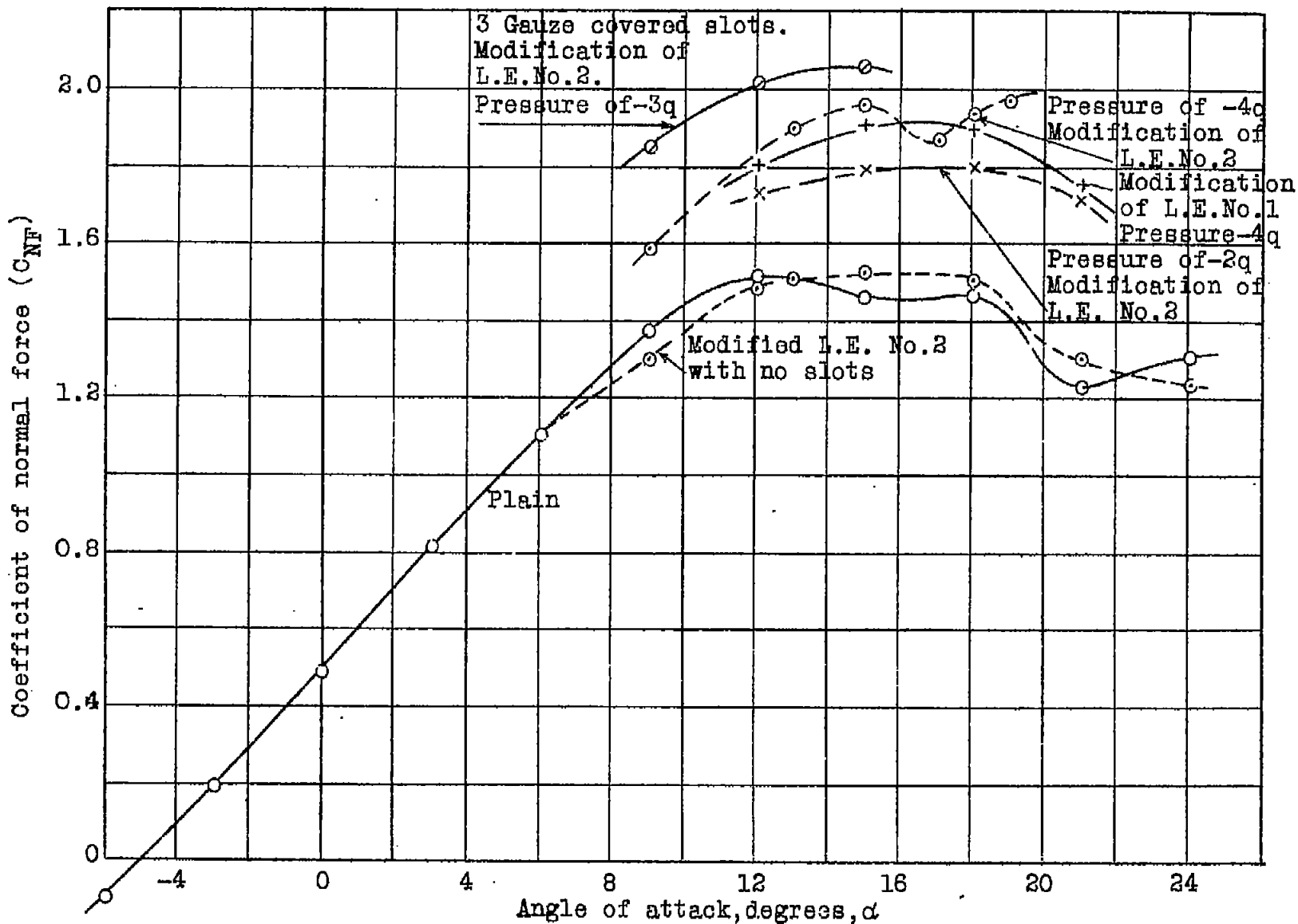

Fig. 25 Coefficient of normal force vs angle of attack. Three .020 inch forward opening suction slots. Three conditions of the leading edge at pressure indicated.

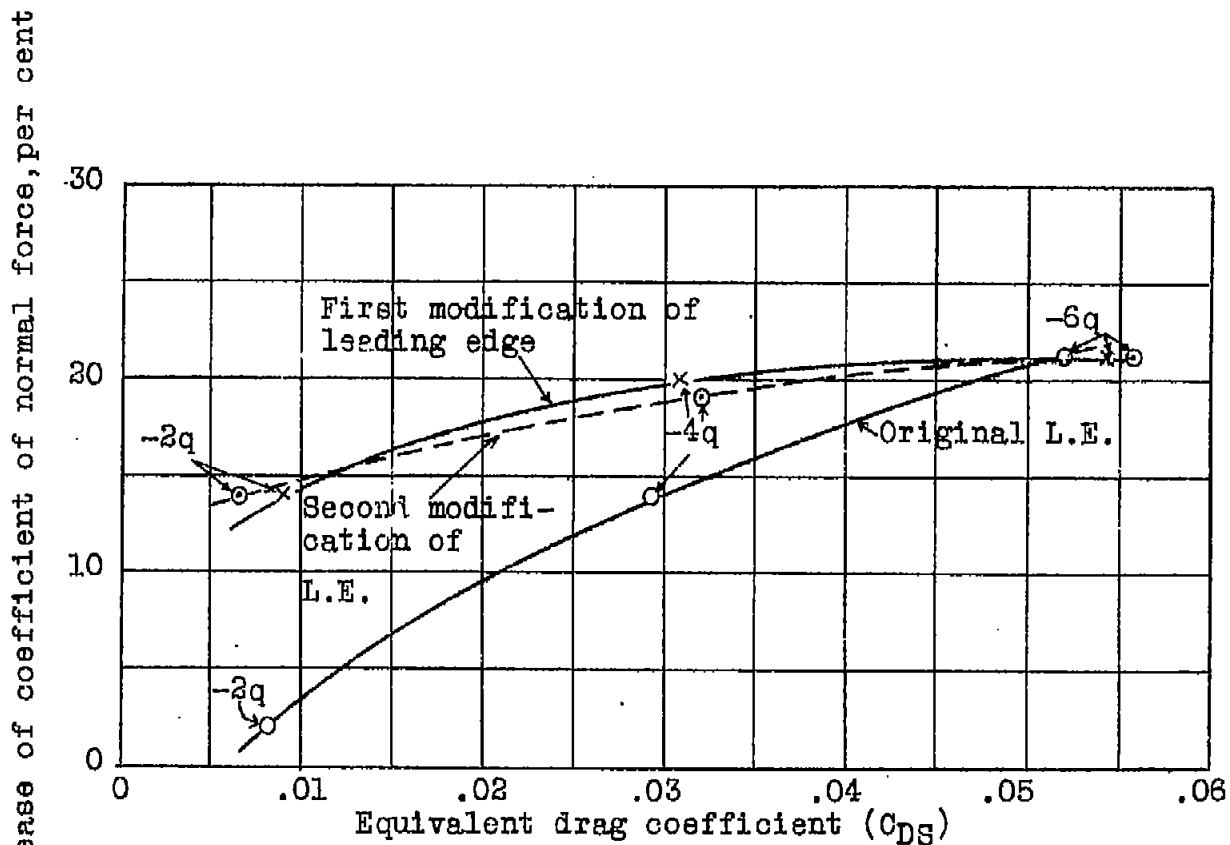

Fig.26A Angle of attack 12 degrees. Increase of coefficient of normal force vs equivalent drag coefficient for three .020" sharp-edge suction slots at pressures of -2q, -4q and -6q.

Increase of coefficient of normal force, per cent

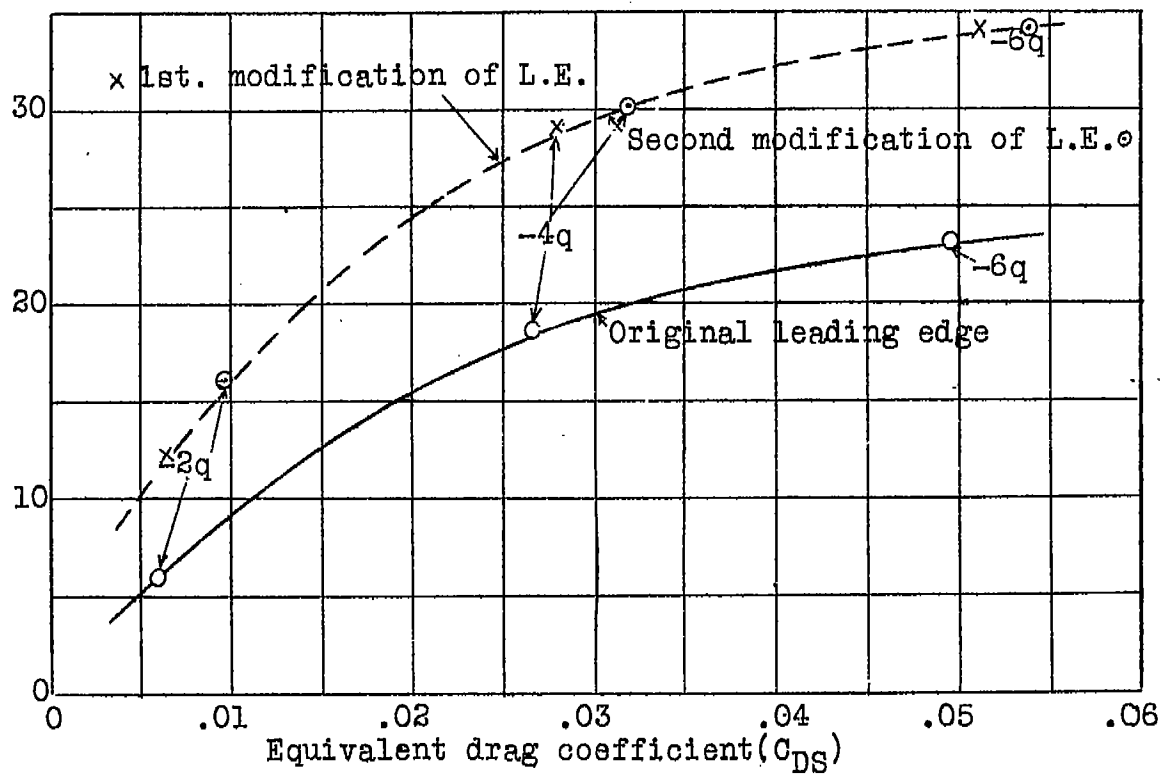

Fig. 26B Angle of attack 15 degrees. Increase of coefficient of normal force vs. equivalent drag coefficient for three .020" sharp edge suction slots at pressures of $-2q$, $-4q$, $-6q$.

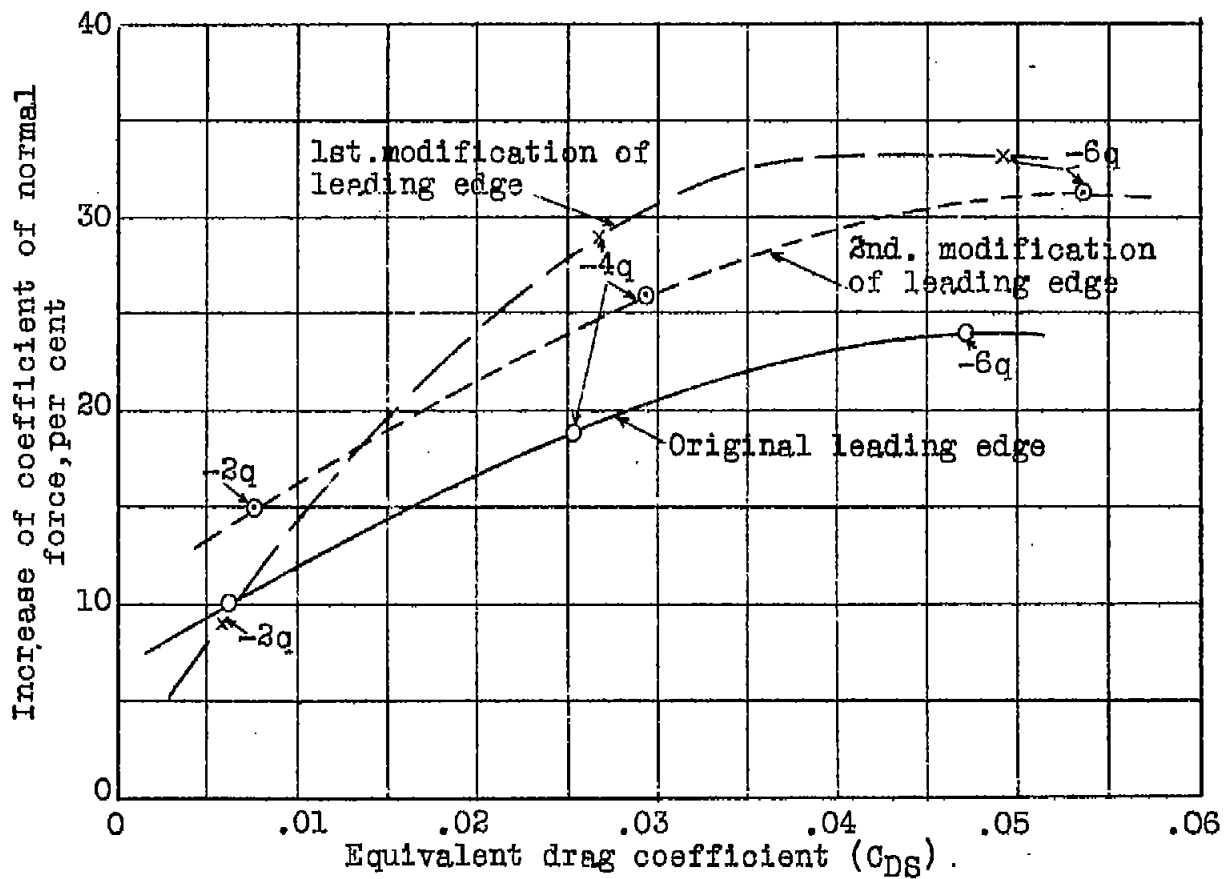

Fig. 26C Angle of attack 18 degrees. Increase of coefficient of normal force vs. equivalent drag coefficient for three sharp-edge suction slots at pressures of $-2q$, $-4q$ and $-6q$.

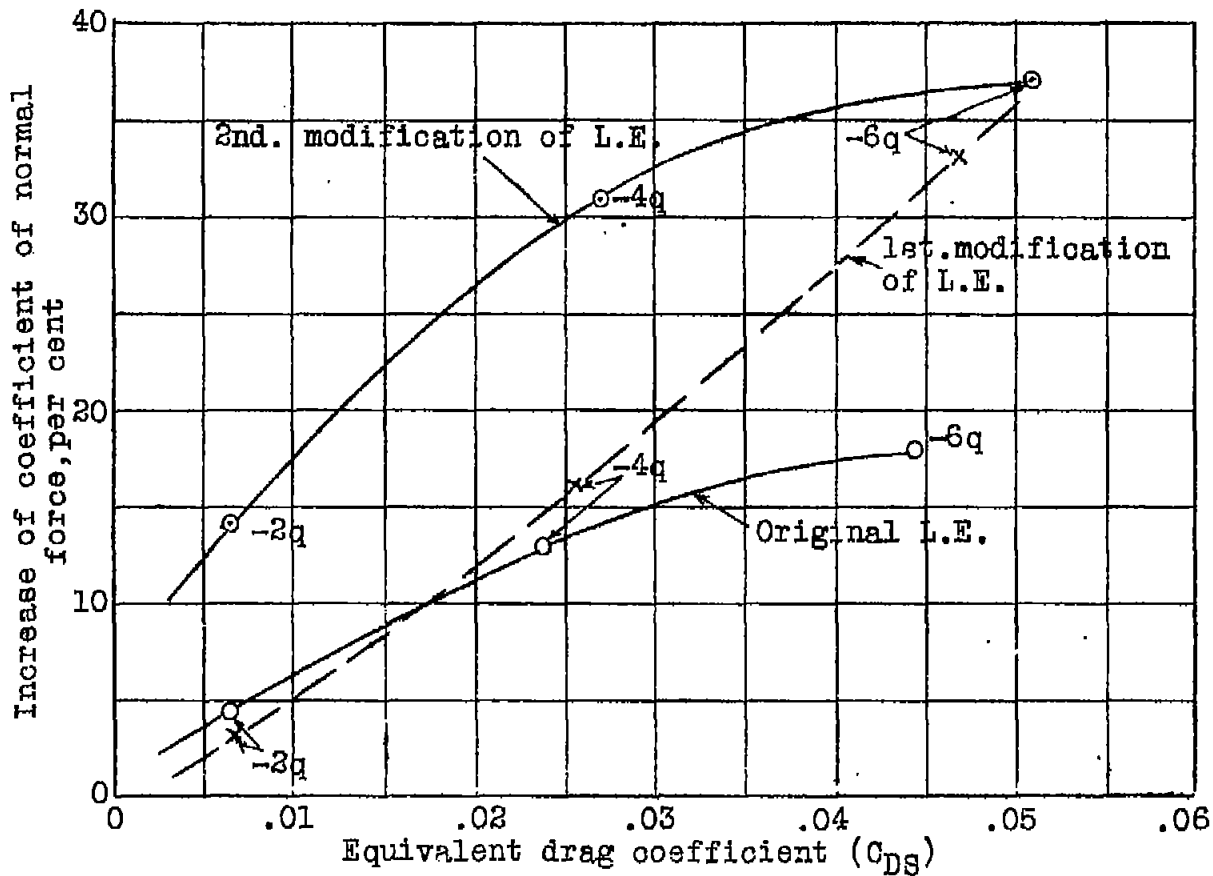
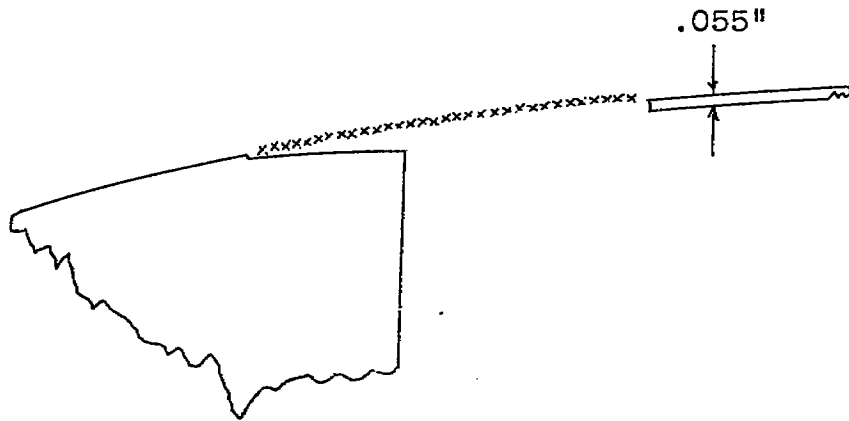
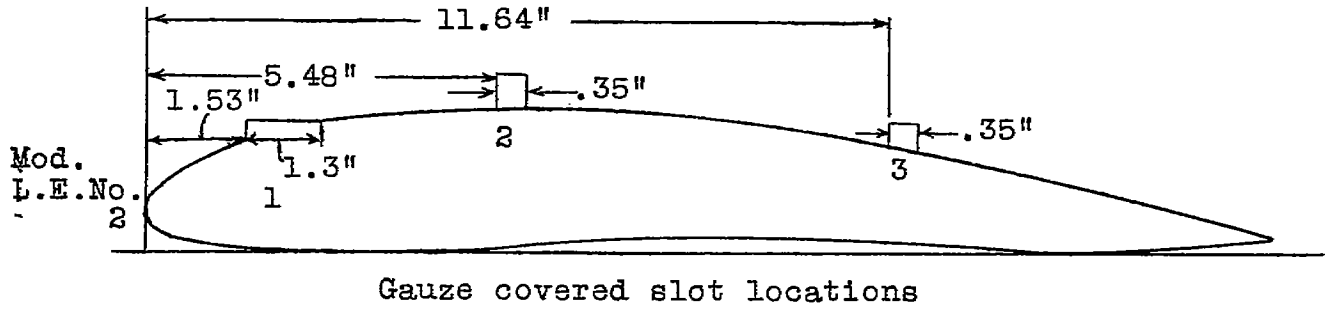
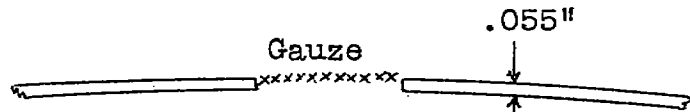

Fig. 26D Angle of attack 21 degrees. Increase of coefficient of normal force vs. equivalent drag coefficient for three .020" sharp-edge suction slots at pressures of $-2q$, $-4q$ and $-6q$.



Slot at 1



Slot at 2 & 3

Fig. 27 Gauze covered slot details and locations.

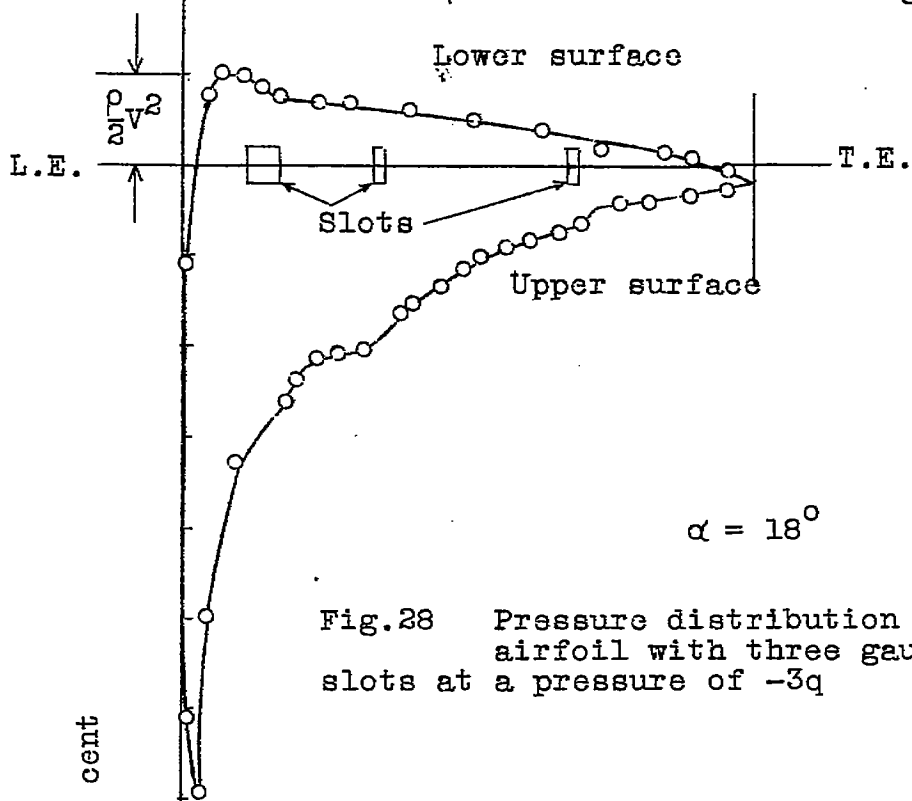

Increase of coefficient of normal force, per cent

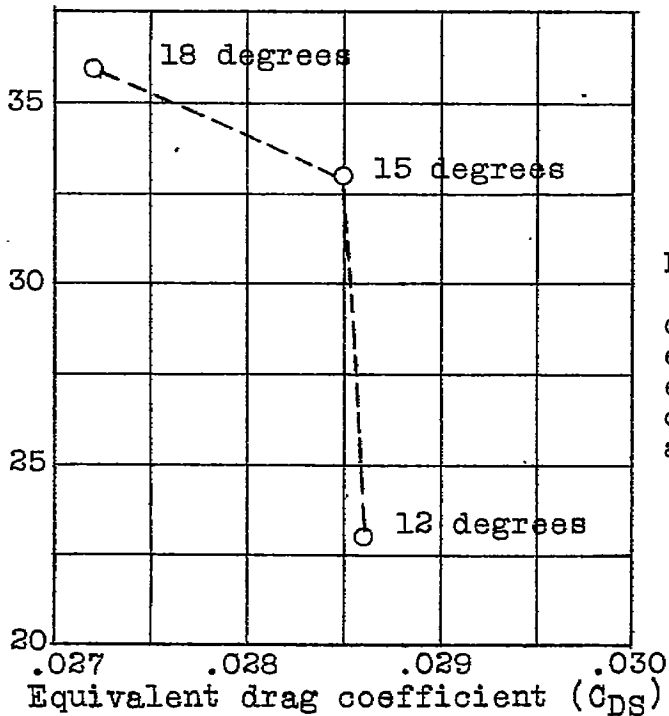

Fig. 29 Increase of coefficient of normal force vs. equivalent drag coefficient for gauze covered slots with a pressure of $-3q$.

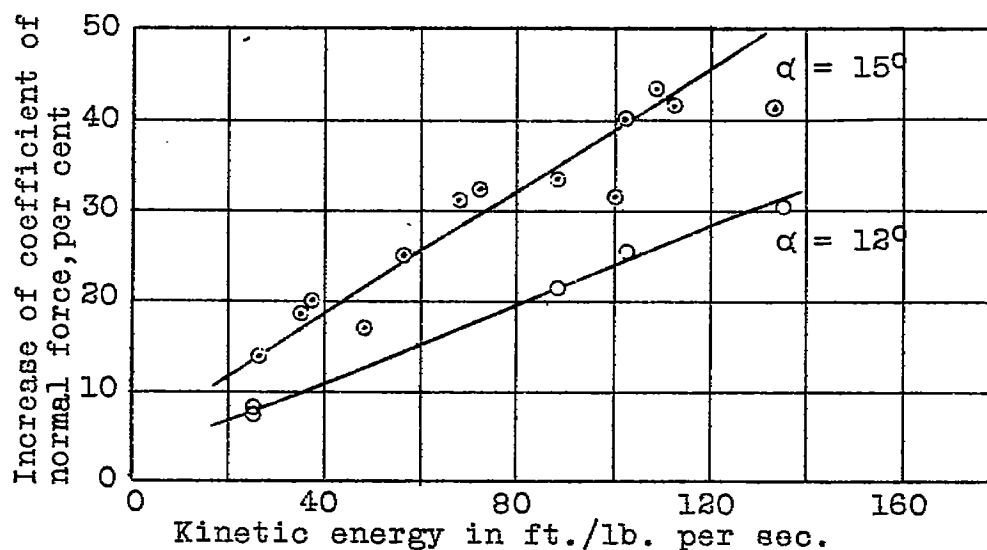

Fig. 30 Increase of coefficient of normal force vs. Kinetic energy per sec. with 2 pressure slots at various widths and pressures.

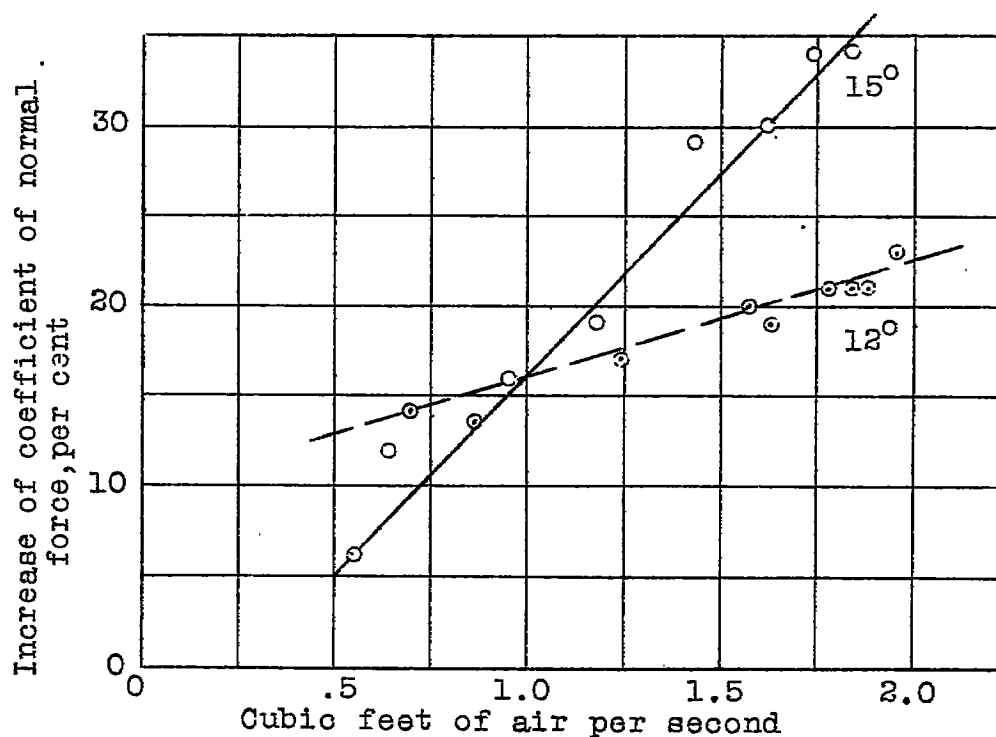

Fig. 31 Increase of coefficient of normal force vs. quantity of air per second for various suction slots and pressures.