

NACA TN 2928

Copy 2928

NATIONAL ADVISORY COMMITTEE FOR AERONAUTICS

TECHNICAL NOTE 2928

AXIAL-LOAD FATIGUE PROPERTIES
OF 24S-T AND 75S-T ALUMINUM ALLOY AS DETERMINED

IN SEVERAL LABORATORIES

By H. J. Grover and W. S. Hyler
Battelle Memorial Institute

Paul Kuhn and Charles B. Landers
Langley Aeronautical Laboratory

and

F. M. Howell
Aluminum Company of America



Washington

May 1953

FOR REFERENCE

NOT TO BE TAKEN FROM THIS ROOM

TECHNICAL NOTE 2928

AXIAL-LOAD FATIGUE PROPERTIES

OF 24S-T AND 75S-T ALUMINUM ALLOY AS DETERMINED

IN SEVERAL LABORATORIES

By H. J. Grover, W. S. Hyler, Paul Kuhn,
Charles B. Landers, and F. M. Howell

SUMMARY

In the initial phase of an NACA program on fatigue research, axial-load tests on 24S-T3 and 75S-T6 aluminum-alloy sheet have been made at the Battelle Memorial Institute and at the Langley Aeronautical Laboratory of the National Advisory Committee for Aeronautics. The test specimens were polished and unnotched. The manufacturer of the material, the Aluminum Company of America, has made axial-load tests on 24S-T4 and 75S-T6 rod material. The test techniques used at the three laboratories are described in detail; the test results are presented and are compared with each other and with results obtained on unpolished sheet by the National Bureau of Standards.

INTRODUCTION

Many engineering structures and all machinery are subjected to repeated loads and are thus potentially liable to minor or major failures by fatigue. As designs become more refined, fatigue generally changes first from a minor to a major and costly nuisance and finally may become a dominant design criterion. This stage has been reached for several classes of airplanes.

Although fatigue research has been pursued for over a hundred years, it is not possible at present to design against fatigue failure with anywhere near the same confidence as against static failure. In order to improve this situation insofar as possible, the National Advisory Committee for Aeronautics (NACA) initiated a long-range research program about 1947.

This paper gives results obtained in a fundamental phase of the program, the determination of the fatigue properties of two aluminum alloys (24S-T3 and 75S-T6) widely used for airframe construction. The main purpose of the tests was to furnish base-line data for succeeding

phases of the program, such as investigations of notch effect and cumulative damage. A large amount of each material (about 5 tons) was purchased at one time in order to minimize the problem of variation of material properties in subsequent phases of the investigation. All the material was in the form of sheet nominally 0.091 inch thick. The tests described in this paper were made on unnotched specimens subjected to axial loading with a constant amplitude of stress at a series of stress ratios R (ratio of minimum stress to maximum stress in each cycle); the specimens were electropolished.

The test program was begun by the Battelle Memorial Institute under contract to the NACA at a time when the NACA had no facilities for fatigue testing. However, a fatigue laboratory has since been established at the Langley Aeronautical Laboratory (LAL). The first project undertaken in this laboratory was a check of the tests made by Battelle at stress ratios of 0 and -1. This large-scale check between two laboratories working with the same lot of material is an interesting feature of the report.

The National Bureau of Standards (NBS) has made a number of tests under three NACA contracts on unpolished specimens of both alloys at a stress ratio of -1. A comparison of NACA and Battelle data with these data is included.

The Aluminum Company of America (ALCOA), the manufacturer of the material, had not tested sheet material under axial loading but had tested 24S-T4 and 75S-T6 rod material under axial loading. A comparison of NACA, Battelle, and NBS data with these data appeared desirable; the Aluminum Research Laboratories of ALCOA, therefore, participated in the preparation of this report.

Section I of the report outlines the scope of the initial phase of the NACA - Battelle program and describes those items that were common to the tests made by these two laboratories (material and preparation of specimens). The next three sections describe test techniques and present results obtained by Battelle, NACA, and ALCOA, respectively. Section V presents comparisons of the results obtained by these three laboratories and by NBS.

I. NACA - BATTELLE TEST PROGRAM

Scope of program.- The program discussed in this paper, which is the initial phase of a larger program, called for the determination of the unnotched fatigue strengths of 24S-T3 and 75S-T6 aluminum alloy in sheet form under axial loading. A series of tests covering stress ratios from $R = -1.0$ to $R = 0.6$ was made by Battelle. Check tests at stress ratios $R = -1.0$ and $R = 0$ were made by LAL.

Material.- The material was purchased in the form of sheets 4 feet by 12 feet by 0.091 inch. In order to provide sufficient material for several lines of investigations, a fairly large quantity (150 sheets) of each material was purchased. This material was manufactured and heat-treated according to commercial practices under close metallurgical supervision to insure uniformity. The sheets of each alloy were from two consecutive lots. The spread of tensile properties is probably less than might be encountered in an ordinary lot of commercial material. The material was stored at the Langley Laboratory until needed; in order to prevent corrosion in storage and damage in handling, the sheets were protected by a coat of zinc-chromate primer on each face. The material complies with the specifications listed in table I.

A chemical analysis was made by ALCOA for each coil of sheet. Table II gives a summary of these analyses. Mechanical properties were determined by ALCOA on coupons cut from the end scrap and side scrap that were obtained while the sheets were being cut. Similar tests were made by Battelle and NACA on coupons cut from the corners of the sheets. The results are given in tables III to V. They are presented only in summary form because attempts to correlate fatigue life with these properties have failed to show any correlation so far. For the same reason, the standard pattern for cutting specimens from the sheets and designating them is not given here; it is given in reference 1.

Specimens.- Blanks for all fatigue specimens were cut from the sheets at the Langley Laboratory and sent to Battelle for machining and electro-polishing. The blanks were approximately 3 inches by 18 inches, with the grain running parallel to the long dimension of the blank.

Still protected by the zinc-chromate primer, each blank was machined to the specimen shape shown in figure 1. Extreme care was used in machining, and final milling cuts removed only about 0.0005 inch from each of the edges of the specimens. Then the zinc-chromate primer was removed from the test section, and the section was polished by electrolytic removal of about 0.0008 inch from each surface. After this polishing procedure, the fatigue-test specimens were coated with vinyl seal for protection against corrosion and against surface damage due to handling. This coating was removed with acetone immediately before each particular specimen was tested.

Electropolishing was chosen in preference to mechanical polishing partly because it is believed to produce a minimum amount of residual stress; mostly, however, it was chosen because it was considered to be the only practical method of polishing the large number of notched specimens to be used in a subsequent phase of the investigation.

II. BATTELLE TESTS

Results of a number of fatigue tests on unnotched sheet specimens of 24S-T3 and of 75S-T6 aluminum alloys have been described in reference 1. The following account includes these results and also the results of additional tests conducted at Battelle to examine more completely some details of the fatigue behavior of these materials.

Machines.- Fatigue tests at Battelle were run on Krouse direct repeated-stress testing machines. A photograph of one of these machines is shown as figure 2, and the schematic drawing in figure 3 illustrates the principle of operation.

The "loading beam" (fig. 3) serves to apply load to the specimen, to measure the load, and to provide a sensitive cut-off after specimen failure. Load measurement is obtained by measuring bending of the beam as the crank is rotated slowly by hand. Calibration of the beam bending was initially obtained by dead-weight loading at the specimen position; calibration checks have been made a number of times and have shown no change during the several years the machines have been in use. In the present tests, the machines were operated at speeds in the range from 1,100 cpm to 1,500 cpm. Correction factors for small dynamic effects at operating speed were obtained for each machine by use of resistance wire strain gages on weigh bars inserted in series with specimens. These factors have also been checked several times and found unvarying (for specimens of the type described in this report) at fixed speeds of operation. Over-all checks of load operation were made during the course of this investigation by resistance wire strain gages mounted on specimens and read by apparatus essentially like that described in reference 2.

A change in the load during a run caused a change in the deflection of the loading beam and stopped the machine by a switch triggered by this alteration in bending of the beam. Usually only failure of the specimen caused the stopping of the machine. In rare instances in which environmental conditions changed the load before specimen failure, the load was readjusted before restarting the machine.

Observations throughout the investigation led to the estimation that the precision of setting and maintaining loads was about ± 2 percent for tension-tension tests and about ± 5 percent for tension-compression tests.

Test procedure.- Tension-compression tests were conducted with guide plates originally developed by NBS (ref. 3) in order to prevent buckling of the specimen during the compression part of the cycle. The essential details of these guide plates are indicated in the sketch in figure 4. In practice, the guide plates were so tightened that it was moderately difficult to move them by hand with the specimen under tensile load.

This procedure was adopted after preliminary experiments (described in ref. 1) to investigate the effectiveness of the guide plates in reducing buckling stresses without adding undesirable friction loads or surface abrasion.

Results.- Results of the fatigue tests conducted by Battelle are shown in the form of S-N diagrams in figures 5 and 6. Plotted points represent only those tests in which failure occurred not more than 1 inch from the point of minimum cross section. For preliminary plots, the boundary of the test section was chosen at 1/2 inch from the point of minimum section. The stress at the 1/2-inch boundary is about 2 percent less and at the 1-inch boundary about 7 percent less than at the minimum section. There was no significant difference between the scatter bands for the preliminary plots and the final ones, because relatively few specimens failed at a distance greater than 1/2 inch but less than 1 inch. Few specimens failed outside of the 1-inch boundary.

Figure 5(a) shows data from tests on specimens of 24S-T3 at a stress ratio $R = 0.25$. In this figure, a solid line has been drawn, as estimated by eye, to indicate an estimated mean curve for the data. Dashed lines shown in the figure indicate limits of a scatter band, within which essentially all the data points lie. Figures 5(b) and 5(c) show similar data and curves for tests on the same material at stress ratios of -1.00 and 0.02, respectively.

Figure 5(d) shows S-N curves for specimens of 24S-T3 from tests at a number of stress ratios. To avoid confusion, test points have been omitted from this figure for the three stress ratios (0.25, 0.02, and -1.00) for which the observed data have already been indicated in the previous figures. Curves shown in figure 5(d) for these three stress ratios are the mean-value curves, already indicated in figures 5(a), (b), and (c).

Figure 6 shows results from similar tests on specimens of 75S-T6.

The results shown in figures 5 and 6 indicate that, despite care in testing, the scatter in the test results was appreciably beyond the estimated limits of error in loading. A more detailed discussion is given in section V of this report.

III. NACA TESTS

The NACA tests made at LAL covered the 24S-T3 and the 75S-T6 aluminum alloys at stress ratios of -1.0 and 0, as mentioned in section I, and have not been reported previously.

Machines.- The fatigue testing machines used at Langley are patterned after machines originally developed by the Lockheed Aircraft Corporation (ref. 4). A photograph of one of these machines is presented as figure 7, and a schematic diagram of essential parts is shown in figure 8.

The machines operate on the subresonance principle. A vibrating beam is supported by flexure plates, the specimen, and a pair of preload springs. The natural frequency of vibration of the beam in the vertical plane is tuned to approximately 1,900 cpm by adjusting the relative positions of the supports or by adjusting the position of or the amount of weight fastened to the free end of the beam. The system is excited by a rotating eccentric which is driven at 1,800 cpm by an electric motor. The load in the specimen is many times the force exerted by the rotating eccentric since the system is operating near a resonant condition.

Three basic methods for control of the amplitude of the dynamic force in the specimen may be used either singly or in combination: adjustment of the force exerted by the rotating eccentric, adjustment of the natural frequency of the vibrating system, and adjustment of the natural frequency of a small spring-mass system which is coupled to and vibrates with the primary vibrating beam. The first two adjustments are usually made before a test is started to make large changes in amplitude, and the latter adjustment is used to regulate the amplitude precisely. The length of the spring may be changed (while the machine is running) by a lead screw driven by a small electric motor inside the primary beam. This system is also used for making small adjustments in amplitude which may become necessary during a test. The mean load on the specimen may be varied by adjusting the screws which support the preload springs.

The lower grip is kept vertical by horizontal flexure plates and receives load from the vibrating beam through a vertical flexure plate. The upper grip is supported by a member to which resistance wire strain gages are applied. The specimen is clamped in the lower and upper grips by adjustable plates which are held in place by setscrews. Sheets of plastic are inserted between the grip plates and the specimen to provide a uniform clamping pressure in the grip section and electrical insulation between the specimen and the testing-machine frame. A low-voltage current which is passed through the specimen operates a relay in the control circuit of the drive motor to stop the machine when the specimen fails. An additional limit switch is mounted below the vibrating beam to stop the machine if the specimen elongates excessively. The machines are bolted to concrete blocks which are in turn supported by rubber pads to provide a seismic mount.

The loads in the specimen are measured by an electronic apparatus which is a development of the apparatus described in reference 2 and of similar apparatus used by NBS (ref. 5). The resistance wire strain gages

previously mentioned are connected into a bridge circuit which is supplied with a 12-volt, 5,000-cycle carrier current from an audio-signal generator. The output of the bridge is amplified and fed into a cathode-ray oscilloscope which serves as a null indicator. A suitable calibrated balancing resistor is used to provide bridge balance at the minimum, maximum, and mean loads in the load cycle. The minimum and maximum load in the cycle is determined when the pattern on the oscilloscope indicates 100-percent modulation of the carrier and the mean load is determined when the axes of the upper and lower sine waves that form the envelope are coincident. The least count on the dial of the balancing resistor is 0.1 percent of full scale.

The load measuring apparatus is calibrated periodically against a special calibration bar which is equipped with Tuckerman optical strain gages and which was previously calibrated in a static testing machine having an error of 1/2 percent or less. The probable error in the load measuring apparatus is thought to be less than 1 percent within the range of loads commonly used.

The specimens are installed as shown in figure 9 clamped between guide plates similar to those used at Battelle and shown in figure 4. In an attempt to determine the amount of load absorbed by the guide plates, a specimen which had failed was clamped into the machine with the broken surfaces separated by 1/8 inch; guide plates were installed in the usual manner; and the machine was operated to produce up to 1/16-inch motion of the lower grip. The loads were measured with the indicating apparatus and were found to be less than 25 pounds in all cases. Since these motions were greater than those encountered in fatigue tests, it is felt that the guides probably absorbed less than 1 percent of the load. In another test, windows were cut into a set of guide plates so that electrical strain gages could be attached directly to the specimen; this test showed no measurable load absorption by the guide plates.

Comparative tests at $R = 0$ with and without guides were also made on some smooth and some notched specimens. All these tests confirmed the conclusion drawn previously at NBS and at Battelle that the guide plates used had no measurable effect in the specific tests described.

Test procedure.- Since the exact amplitude of the alternating force in the specimen could not be predicted before the machine was started, the amplitude of force was measured after the machine had been adjusted to produce approximately the proper magnitude and had been started. Minor adjustments in amplitude were then made by extending or retracting the auxiliary spring-mass system while the machine was running. The machine was stopped for major adjustments, if required. It is estimated that the machines were adjusted to the proper load values before 3,000 cycles of load were applied.

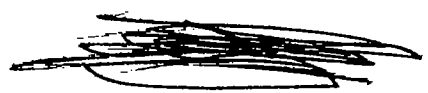

The loads on the specimen were checked periodically throughout the tests and adjusted if necessary. Changes in load rarely exceeded 3 percent of the maximum load during the test.

Just before failure of the specimen the amplitude of load increased markedly. This increase in load was probably due to a progressive decrease in natural frequency as the crack in the specimen propagated rapidly. This rapid increase in amplitude was limited to approximately the last 15 seconds before final failure occurred.

Results.- Results of axial-load fatigue tests on specimens of the two materials at $R = -1.0$ and $R = 0$ are shown in figures 10 and 11. Test points are plotted for only those specimens in which failure occurred not more than 1 inch from the center of the specimen. The percentage of specimens that failed in the outer half of the 2-inch test section was not so small as in the Battelle tests. Test points with diagonal lines represent tests without guides. The solid lines represent the edges of the scatter bands containing most of the test points. No mean curves are drawn since only scatter bands are compared in section V.

The test results shown in figures 10 and 11 indicate scatter of the same order as found in the corresponding Battelle results. A more detailed comparison is given in section V of this report.

IV. ALCOA TESTS

The test results presented in this section were obtained at the Aluminum Research Laboratories of ALCOA.

Material.- The material used for the tests described in this section consisted of 3/4-inch-diameter rolled and drawn rod produced commercially. The nominal and actual compositions and grain size of the materials are given in table VI and their tensile properties and compressive yield strengths are given in table VII; nominal values are obtained from reference 6. These compositions and properties are representative of the respective alloys and tempers of rod and are similar to those of sheet, except that the tensile yield strength of 24S-T3 sheet is higher than that of 24S-T4 rod. Photomicrographs showing the structures of the 24S-T4 and 75S-T6 rod materials are shown in figures 12 to 16. These structures are similar to those of 24S-T3 and 75S-T6 sheet materials of the two alloys.

Specimens.- The shape of the fatigue specimens used is shown in figure 17. The specimens were rough-turned to within 0.100 inch of the final diameter and then were machined to the final size with succeedinglly finer cuts from 0.010 to 0.001 inch deep. The resulting tool marks were

removed by polishing longitudinally, first with No. 320 emery cloth and finally with No. 00 metallographic polishing paper.

Machines.- The fatigue tests of the rod were made in axial-stress machines of the type illustrated in figure 18. Each machine, designed to test four specimens simultaneously, consists essentially of a main shaft on each end of which is a variable eccentric which in turn actuates a cross head. To each cross head one end of each of two specimens is attached and the opposite ends of the specimens are attached to dynamometer links whose load-deflection characteristics have been determined individually. The dynamometer links are attached to suitable brackets on the base of the machine. Adjustment of the graduated eccentrics determines the throw of the cross heads and, if the load-deflection characteristics of the dynamometer links are taken into account, the total range of load for each of a pair of specimens. The throw of the eccentric may be varied from 0 to 5/8 inch. Each of the links requires a load of about 1,000 pounds to cause a deflection of 0.129 inch. The deflection of each link is measured at the center by using a dial gage reading directly to the nearest 0.001 inch. Adjustment of the nuts on the opposite sides of each bracket which supports a link affords a means for positioning the stress range of each specimen independently of the other specimens. That is, with a given stress range, by means of these adjusting nuts, all or any portion of the stress range may be made to cause either tensile or compressive stress in the specimen. Consideration of the machine just described will reveal that, by adjustment of the throw of the eccentric and the diameter of the specimen, many different ranges of stress, as well as positions of ranges, can be obtained. The machine is operated at a speed of 2,000 rpm. The stresses in the individual specimens have been checked by using 1/2-inch Huggenberger tensometers on opposite sides of the specimens in a vertical plane and agree within less than 0.5 percent.

Procedure.- Tests were made at stress ratios varying from $R = 0$ to $R = -2.0$. The frequency of loading was 2,000 cpm, except that the tests of 75S-T6 rod at the three highest stresses for a stress ratio of 0 were made at a much slower rate (about 100 cpm) by operating the machine with a hand crank.

Results.- The results of the ALCOA tests are plotted in figures 19 and 20. As indicated, tests were made at stress ratios of 0, -0.5, -1.0, and -2.0.

The curves that are shown in figure 19 are based on the tests of one lot of 24S-T4 (points without diagonal lines) for the four stress ratios. In drawing the curves, consideration was given to making them consistent with each other, so that a modified Goodman diagram could be established from them. This Goodman diagram was the basis of the values for 24S-T4 in various tables, including table 6 of reference 7 and table 3.112(d) of

reference 8. In figure 19 the points through which slanting lines have been drawn represent the results of subsequent tests of another sample of similar material.

Figure 20 shows similar results for 75S-T6 rod for the same stress ratios. As in the case of the data for 24S-T4, the curves were drawn through the points without diagonal lines and they represent the curves which formed the basis of a modified Goodman diagram. The points with diagonal lines represent results of tests of two other samples of rod, the points for one sample having the lines slanting in one direction and those for the other sample, in the other direction.

Discussion of results.- The results of the tests of the original samples of both alloys (figs. 19 and 20) seemed quite consistent, not showing excessive scatter for any stress ratio. They led to curves for the various ratios that compared well with each other. When later tests were made of additional samples, however, it was found that the scatter of results increased considerably.

In the case of 24S-T4 (fig. 19) it will be noted that the results of the tests on sample P-853 at a stress ratio of 0 agree very well with the results on sample P-746 at stresses above 45 ksi and below 30 ksi. At intermediate stresses, however, the life of sample P-853 is only one-tenth to perhaps even as little as one-hundredth the life of sample P-746. It should be pointed out that such large differences may, at least partially, be attributable to unintentional differences in preparation of specimens, fit of specimens in holders of the fatigue machines, alinement of machines, technique of testing, or other factors not associated with differences between samples. These differences in fatigue life illustrate the difficulty of trying to present fatigue data in tables of the type represented by table 6 of reference 7 and table 3.112(d) of reference 8.

In the case of 75S-T6 (fig. 20) the data for samples 116517 and 117482 are generally higher than those for sample 70968, the greatest difference being for a stress ratio of 0. A somewhat greater spread of results is observed in the tests of 75S-T6 than for 24S-T4. This difference in spread has been observed previously in other fatigue tests (ref. 9). Here, again, the difficulty of presenting fatigue data in tabular form is exemplified.

V. COMPARISONS OF TEST RESULTS

Battelle and NACA tests.- Figures 21 and 22 show the scatter bands obtained in the Battelle and the NACA tests for each of the two materials and the two stress ratios used in the comparative tests. Because

approximately the same number of tests were made at each laboratory, it is permissible to compare the limits of the scatter bands. In order to avoid confusion, no mean curves are shown.

For the 24S-T3 sheet material, the agreement is excellent in the middle part of the curves. At low stresses, there is some tendency for the NACA results to fall slightly lower than the Battelle results. At the high-stress end, a similar tendency appears for the stress ratio $R = -1.0$.

For the 75S-T6 sheet material, the agreement may also be considered very good for medium stresses. For low stresses, the NACA results are lower than the Battelle results, particularly at the stress ratio $R = -1.0$. This tendency was noted early in the tests, when only a small number of tests had been made in either laboratory. In an effort to eliminate the discrepancies, exchange visits of the staffs of the laboratories were made, each step in the test procedure was discussed and carefully checked, and additional tests were made in each laboratory. In spite of all efforts, however, it has not been possible so far to reduce the discrepancies further or to explain them. Some additional remarks on this subject will be made subsequently, when comparisons are made with results from other laboratories.

Battelle, NACA, and ALCOA tests.- In figures 23 and 24 the scatter bands for the Battelle and the NACA tests are shown, together with points representing the ALCOA tests. It will be recalled that the ALCOA tests were made on rod material, whereas the Battelle and NACA tests were made on sheet material. For the 24S-T material (fig. 23), the ALCOA points fall within or very close to the scatter bands for the Battelle and the NACA tests, which are practically identical. For the 75S-T6 material, at $R = -1.0$ (fig. 24(a)), a number of ALCOA points fall within the Battelle scatter band, and others fall within the gap between the Battelle and the NACA scatter bands (at cycle numbers $N \geq 2 \times 10^6$) which constitutes the greatest discrepancy between Battelle and NACA results. For 75S-T6 at $R = 0$ (fig. 24(b)) and $N \geq 2 \times 10^6$, the ALCOA points are distributed over the combination of Battelle and NACA scatter bands. This result, together with that for $R = -1.0$, suggests that the discrepancies between Battelle and NACA results may be, at least partly, not truly systematic differences ascribable to peculiarities of machines or test techniques.

Battelle, NACA, and NBS tests.- Data on sheet material tested under completely reversed stress only ($R = -1.0$) have been obtained in the course of several NACA contracts by the National Bureau of Standards. In the NBS tests, none of the specimens were polished. Guides were used as in the Battelle and NACA tests to prevent buckling of the specimens. Two types of machines were used. One was of the same general type as the machine used by Battelle as described in section I (crank-driven lever); the other was built to the design of the Aluminum Research Laboratories as described in section III.

Figure 25(a) shows results obtained by NBS on 24S-T3 sheet specimens, taken from references 10 and 11. Reference 11 includes results of tests performed at 12 and 1,000 cpm. The effect of this difference in testing speed is small in comparison with test scatter, however, and does not contribute significantly to the width of the scatter band. Figure 25(b) shows results taken from reference 12 together with the two curves defining the scatter band of figure 25(a). In the tests reported in reference 12 the width of specimen was varied from 1/4 to 2 inches, and the fatigue strength appeared to decrease somewhat as the width of specimen increased. For purposes of comparison with the Battelle and NACA specimens, which were 1 inch wide, the NBS results on specimens having a width greater than 1 inch (weak specimens) have been omitted. Some of the points in figure 25(b) fall below the scatter band obtained from figure 25(a); the lower curve was therefore modified as indicated.

In figure 26, the NBS scatter band (as defined by the upper curve of fig. 25(a) and the modified lower curve shown in fig. 25(b)) is shown together with the Battelle and NACA scatter bands. It may be seen that the unpolished NBS specimens have the same maximum life and a somewhat lower minimum life than the polished Battelle and NACA specimens.

Figure 27 shows NBS data on 75S-T6 specimens taken from reference 12. The data for specimens wider than 1 inch are again omitted. Figure 28 shows a comparison between the scatter band for these tests and the Battelle and NACA scatter bands. The NBS scatter band coincides reasonably well with the NACA scatter band but is somewhat lower than the Battelle scatter band. Thus the maximum difference between unpolished and polished specimens is, in this case, of the same order of magnitude as the difference between polished specimens tested at two laboratories.

CONCLUDING REMARKS

The report presents axial-load fatigue data on 24S-T and 75S-T aluminum alloy obtained at four laboratories. Tests at the Battelle Memorial Institute and at the Langley Aeronautical Laboratory of the NACA were made on polished sheet specimens from the same lot of material. Tests at the National Bureau of Standards were made on unpolished specimens from different lots of sheet material. Tests at the Aluminum Research Laboratories of the Aluminum Company of America were made on rod material.

For the 24S-T material, the agreement between results from all four laboratories is very good; the differences between polished and unpolished specimens, or between sheet material and rod material, are shown to be small.

For the 75S-T material, similarly good agreement exists only if the comparison is confined to sheet material tested at medium stresses. If the comparison is extended to include sheet material tested at low stresses and rod material, discrepancies appear. At the present, it is difficult to say how much of the discrepancy should be attributed to variability of material and how much to unrecognized differences in test conditions.

Langley Aeronautical Laboratory,
National Advisory Committee for Aeronautics,
Langley Field, Va., January 21, 1953.

REFERENCES

1. Grover, H. J., Bishop, S. M., and Jackson, L. R.: Fatigue Strengths of Aircraft Materials. Axial-Load Fatigue Tests on Unnotched Sheet Specimens of 24S-T3 and 75S-T6 Aluminum Alloys and of SAE 4130 Steel. NACA TN 2324, 1951.
2. Grover, H. J.: The Use of Electric Strain Gages To Measure Repeated Stresses. Proc. Soc. for Exp. Stress Analysis, vol. 1, no. 1, Addison-Wesley Press, Inc. (Cambridge, Mass.), 1943, pp. 110-115.
3. Brueggeman, W. C., and Mayer, M., Jr.: Guides for Preventing Buckling in Axial Fatigue Tests of Thin Sheet-Metal Specimens. NACA TN 931, 1944.
4. Foster, H. W., and Seliger, Victor: Fatigue-Testing Methods and Equipment. Mech. Eng., vol. 66, no. 11, Nov. 1944, pp. 719-725.
5. Howard, Darnley M.: Flexural Fatigue Tests of Wing Beams. NBS Rep. 1350, Bur. Aero., Dec. 1951.
6. Anon.: Alcoa Aluminum and Its Alloys. Aluminum Co. of Am., 1950.
7. Anon.: Alcoa Structural Handbook. Aluminum Co. of Am., 1950.
8. Anon.: Strength of Metal Aircraft Elements. ANC-5, Munitions Board Aircraft Committee, Dept. of Defense. Revised ed., June 1951.
9. Templin, R. L., Howell, F. M., and Hartmann, E. C.: Effect of Grain Direction on Fatigue Properties of Aluminum Alloys. Aluminum Co. of Am., reprinted from Product Engineering, July 1950.
10. Brueggeman, W. C., Mayer, M., Jr., and Smith, W. H.: Axial Fatigue Tests at Zero Mean Stress of 24S-T Aluminum-Alloy Sheet With and Without a Circular Hole. NACA TN 955, 1944.
11. Smith, Frank C., Brueggeman, William C., and Harwell, Richard H.: Comparison of Fatigue Strengths of Bare and Alclad 24S-T3 Aluminum-Alloy Sheet Specimens Tested at 12 and 1000 Cycles Per Minute. NACA TN 2231, 1950.
12. Brueggeman, W. C., and Mayer, M., Jr.: Axial Fatigue Tests at Zero Mean Stress of 24S-T and 75S-T Aluminum-Alloy Strips With a Central Circular Hole. NACA TN 1611, 1948.

TABLE I
 SPECIFICATIONS FOR 24S-T3 AND 75S-T6 SHEET MATERIAL

Issuing agency	24S-T3	75S-T6
Federal	QQ-A-355a	-----
Army and Air Force	-----	AXS-1682
Air Force and Navy	AN-A-12-1	AN-A-9a-2
Navy	47AlOe	-----
A.S.T.M.	B209-51T	B209-51T



TABLE II
 CHEMICAL ANALYSES

(a) 24S-T3 sheet (6 samples)

	Si	Fe	Cu	Mn	Mg	Cr	Zn
Maximum	0.18	0.37	4.64	0.59	1.56	0.02	0.07
Minimum	.15	.30	4.56	.54	1.41	.02	.02
Average	.16	.33	4.61	.57	1.51	.02	.06

(b) 75S-T6 sheet (9 samples)

	Si	Fe	Cu	Mn	Mg	Cr	Ni	Zn	Pb	Sn	Ti
Maximum	0.09	0.26	1.68	0.18	2.62	0.25	0	5.80	0	0	0.07
Minimum	.06	.18	1.44	.14	2.47	.23	0	5.55	0	0	.06
Average	.07	.22	1.58	.16	2.56	.24	0	5.68	0	0	.07



TABLE III

MECHANICAL PROPERTIES

[Specimens tested by ALCOA]

(a) 24S-T4 sheet

	Ultimate tensile strength, ksi	Tensile yield strength (offset = 0.2 percent), ksi	Elongation in 2 inches, percent
Center samples (cut from center of end scraps, perpendicular to grain, 32 specimens)			
Maximum	70.1	47.13	23.0
Minimum	67.5	44.60	19.5
Average	68.8	45.97	21.4
Maximum deviation	1.3	1.37	1.9
Edge samples (cut from ends of end scraps, perpendicular to grain, 7 specimens)			
Maximum	70.4	48.33	23.0
Minimum	67.6	46.28	20.0
Average	68.7	47.37	21.2
Maximum deviation	1.7	1.09	1.8
Side-scrap samples (cut from side scraps, parallel with grain, 7 specimens)			
Maximum	71.9	56.02	22.5
Minimum	71.2	53.29	20.5
Average	71.5	54.78	21.6
Maximum deviation	.4	1.49	1.1



TABLE III - Concluded

MECHANICAL PROPERTIES

[Specimens tested by ALCOA]

(b) 75S-T6 sheet

	Ultimate tensile strength, ksi	Tensile yield strength (offset = 0.2 percent), ksi	Elongation in 2 inches, percent
Center samples (cut from center of end scraps, perpendicular to grain, 40 specimens)			
Maximum	85.2	74.79	11.5
Minimum	81.4	70.31	10.0
Average	83.4	72.90	10.9
Maximum deviation	2.0	2.59	.9
Edge samples (cut from ends of end scraps, perpendicular to grain, 9 specimens)			
Maximum	84.5	73.50	11.5
Minimum	82.7	71.33	10.5
Average	83.1	72.51	10.8
Maximum deviation	1.4	1.18	.7
Side-scrap samples (cut from side scraps, parallel with grain, 10 specimens)			
Maximum	82.5	74.94	11.0
Minimum	78.0	68.00	10.0
Average	80.9	72.89	10.7
Maximum deviation	2.9	4.89	.7



TABLE IV

MECHANICAL PROPERTIES

[Specimens tested by Battelle]

(a) 24S-T3 sheet

	Ultimate tensile strength, ksi	Yield strength (offset = 0.2 percent), ksi	Elongation in 2 inches, percent
Tensile tests (parallel with grain, 5 specimens)			
Maximum	73.5	56.0	20.0
Minimum	72.5	53.5	16.3
Average	73.0	54.9	18.2
Tensile tests (perpendicular to grain, 5 specimens)			
Maximum	72.0	50.5	20.7
Minimum	70.0	49.5	15.5
Average	70.9	50.1	18.3
Compressive tests (parallel with grain, 6 specimens)			
Maximum		45.8	
Minimum		41.7	
Average		44.1	
Compressive tests (perpendicular to grain, 6 specimens)			
Maximum		56.5	
Minimum		47.1	
Average		50.0	



TABLE IV - Concluded

MECHANICAL PROPERTIES

[Specimens tested by Battelle]

(b) 75S-T6 sheet

	Ultimate tensile strength, ksi	Yield strength (offset = 0.2 percent), ksi	Elongation in 2 inches, percent
Tensile tests (parallel with grain, 4 specimens)			
Maximum	83.5	79.0	12.1
Minimum	79.5	74.5	10.1
Average	81.6	76.0	11.4
Tensile tests (perpendicular to grain, 4 specimens)			
Maximum	84.0	76.5	11.5
Minimum	81.0	73.5	10.0
Average	82.5	75.0	11.0
Compressive tests (parallel with grain, 6 specimens)			
Maximum		80.8	
Minimum		78.0	
Average		79.3	
Compressive tests (perpendicular to grain, 6 specimens)			
Maximum		76.5	
Minimum		72.6	
Average		74.5	



TABLE V

MECHANICAL PROPERTIES

[Specimens tested by NACA at LAL]

(a) 24S-T3 sheet

	Ultimate tensile strength, ksi	Yield strength (offset = 0.2 percent), ksi	Elongation in 2 inches, percent
Tensile tests (parallel with grain, 147 specimens)			
Maximum	73.44	59.28	25.0
Minimum	70.27	46.88	15.0
Average	72.14	52.05	21.6
Tensile tests (perpendicular to grain, 148 specimens)			
Maximum	72.44	48.19	24.0
Minimum	68.22	43.24	15.0
Average	70.25	46.27	19.9
Compressive tests (parallel with grain, 52 specimens)			
Maximum		46.20	
Minimum		41.90	
Average		43.62	
Compressive tests (perpendicular to grain, 36 specimens)			
Maximum		50.00	
Minimum		46.80	
Average		48.10	



TABLE V - Concluded

MECHANICAL PROPERTIES

[Specimens tested by NACA at LAL]

(b) 75S-T6 sheet

	Ultimate tensile strength, ksi	Yield strength (offset = 0.2 percent), ksi	Elongation in 2 inches, percent
Tensile tests (parallel with grain, 152 specimens)			
Maximum	84.54	79.79	15.0
Minimum	79.84	71.54	7.0
Average	82.94	75.50	12.3
Tensile tests (perpendicular to grain, 151 specimens)			
Maximum	87.02	75.48	14.0
Minimum	81.62	69.58	9.0
Average	84.50	73.75	11.7
Compressive tests (parallel with grain, 52 specimens)			
Maximum		77.00	
Minimum		69.08	
Average		74.60	
Compressive tests (perpendicular to grain, 38 specimens)			
Maximum		80.80	
Minimum		77.10	
Average		78.53	



TABLE VI
 COMPOSITION AND GRAIN SIZE OF MATERIALS TESTED BY ALCOA

Alloy and temper	Sample no.	Composition, percent							Grains per mm ³
		Cu	Fe	Si	Mn	Mg	Zn	Cr	
24S-T4	Nominal ^a	4.5	-----	-----	0.6	1.5	-----	-----	-----
	P-746	4.39	0.19	0.16	.68	1.52	-----	-----	900
	P-853	4.45	.17	.17	.66	1.48	-----	-----	22,000
75S-T6	Nominal ^a	1.6	-----	-----	-----	2.5	5.6	0.3	-----
	S-70968	1.49	.35	.10	.14	2.20	5.60	.27	9,720
	S-116517	1.64	.40	.14	.10	2.40	5.60	.26	29,000
	S-117482	1.62	.13	.09	.01	2.20	5.77	.22	7,490

^aReference 6.



TABLE VII
 TENSILE AND COMPRESSIVE PROPERTIES
 OF MATERIALS TESTED BY ALCOA

Alloy and temper	Sample no.	Ultimate tensile strength, ksi	Tensile yield strength (offset = 0.2 percent), ksi	Elongation in 2 inches, percent	Compressive yield strength (offset = 0.2 percent), ksi
24S-T4	Nominal ^a	68.0	48.0	19	-----
	P-746	70.5	42.0	21.3	-----
	P-853	71.3	45.3	20.0	50.3
75S-T6	Nominal ^a	82.0	72.0	11	-----
	S-70968	81.3	70.3	15.0	73.4
	S-116517	83.8	72.6	14.0	77.5
	S-117482	86.5	74.7	21.4	81.0

^aReference 6.



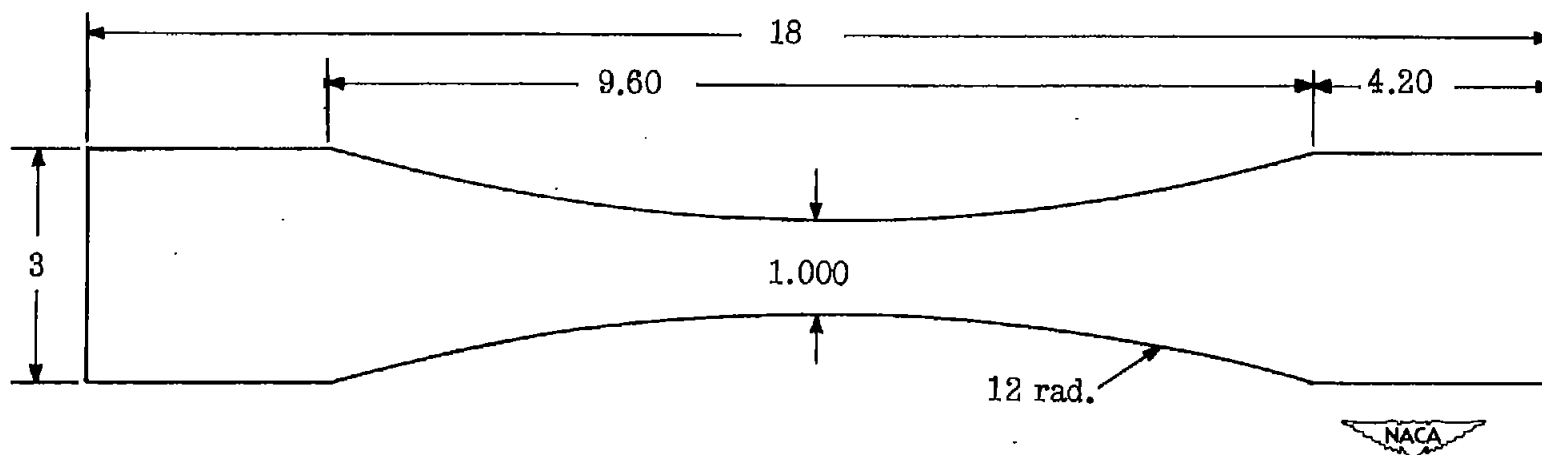

Figure 1.- Fatigue test specimen tested by Battelle and NACA. All dimensions are in inches.

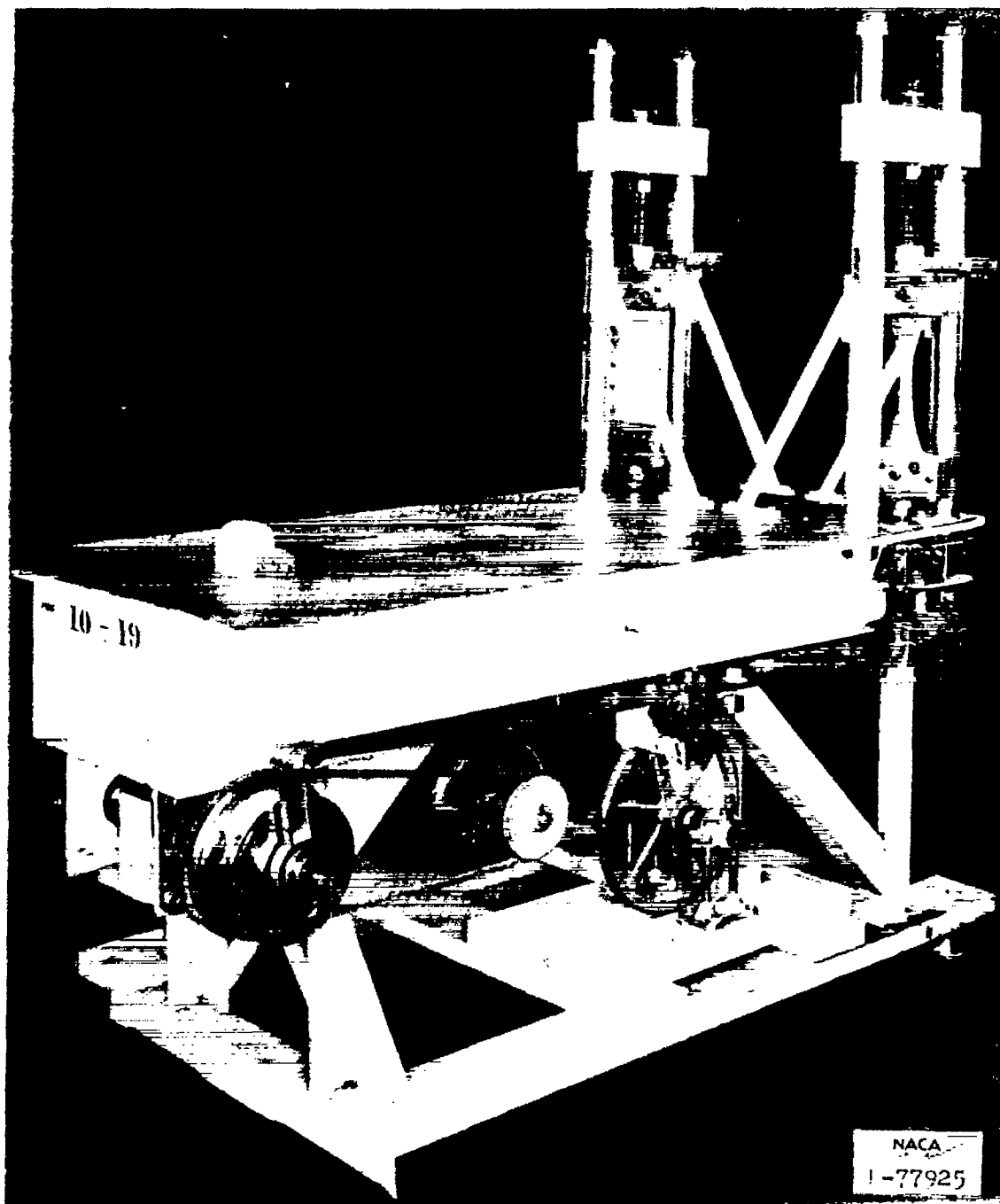

Figure 2.- Krouse direct repeated-stress testing machine.

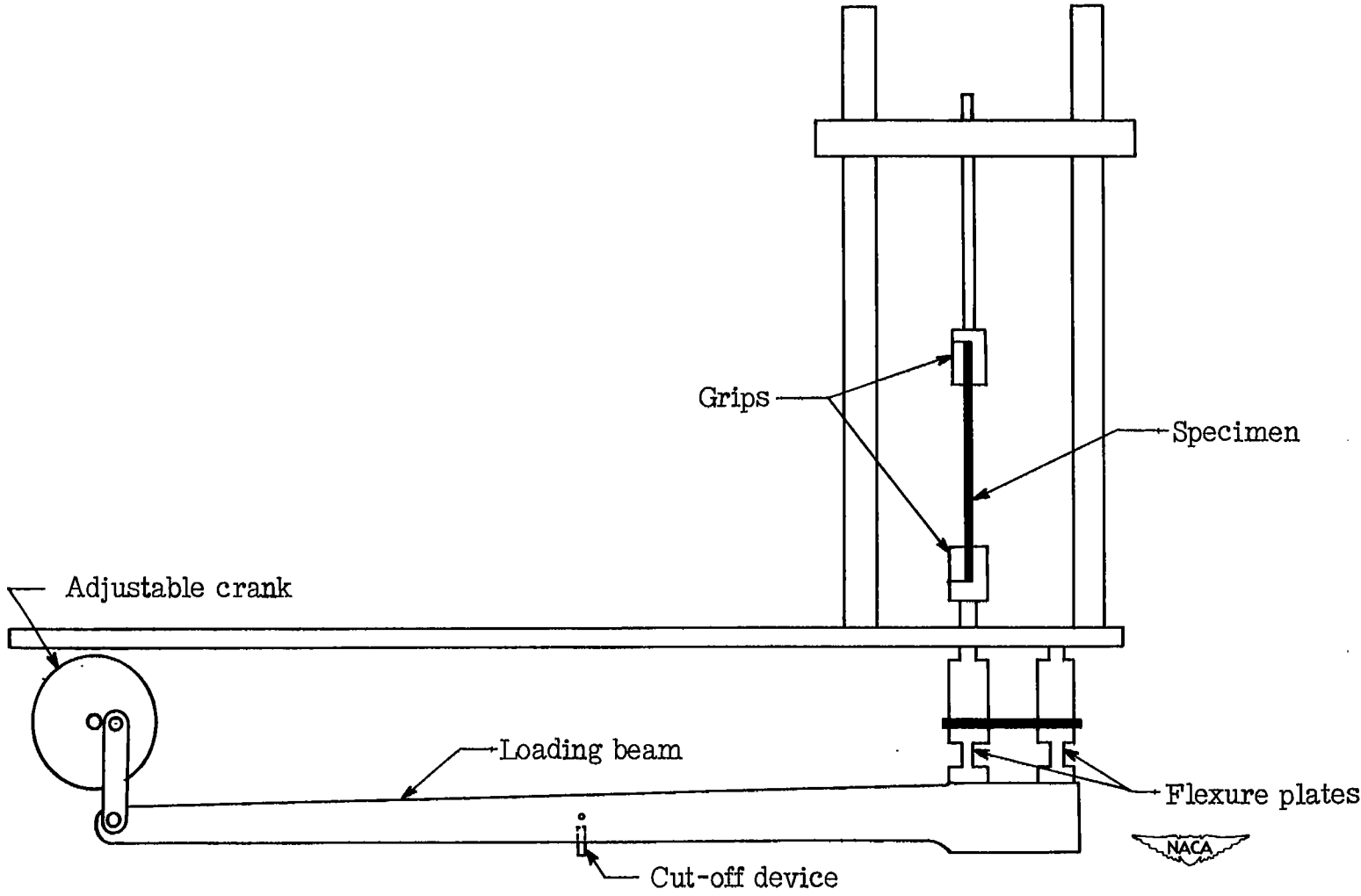

Figure 3.- Schematic drawing of fatigue testing machine used by Battelle.

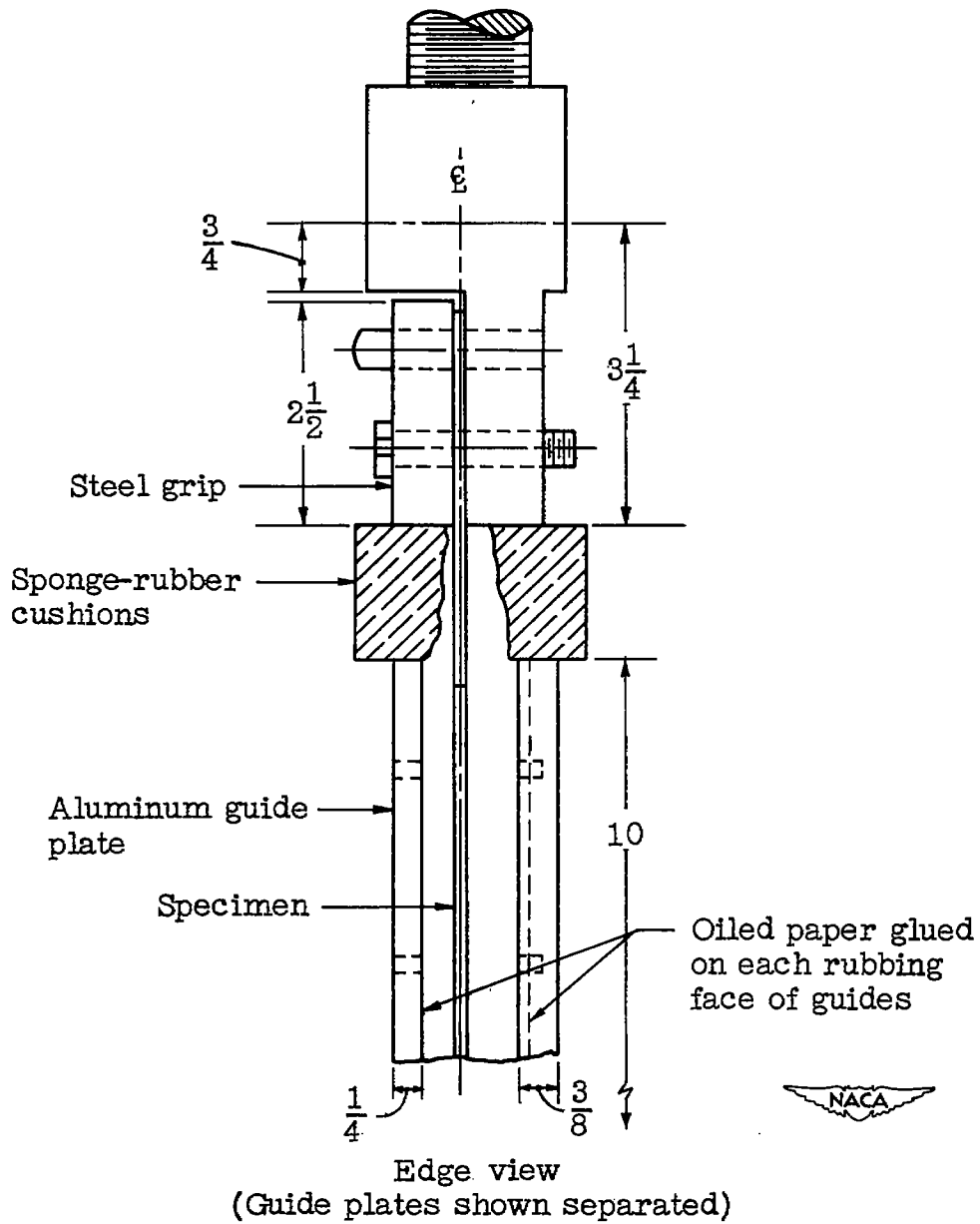
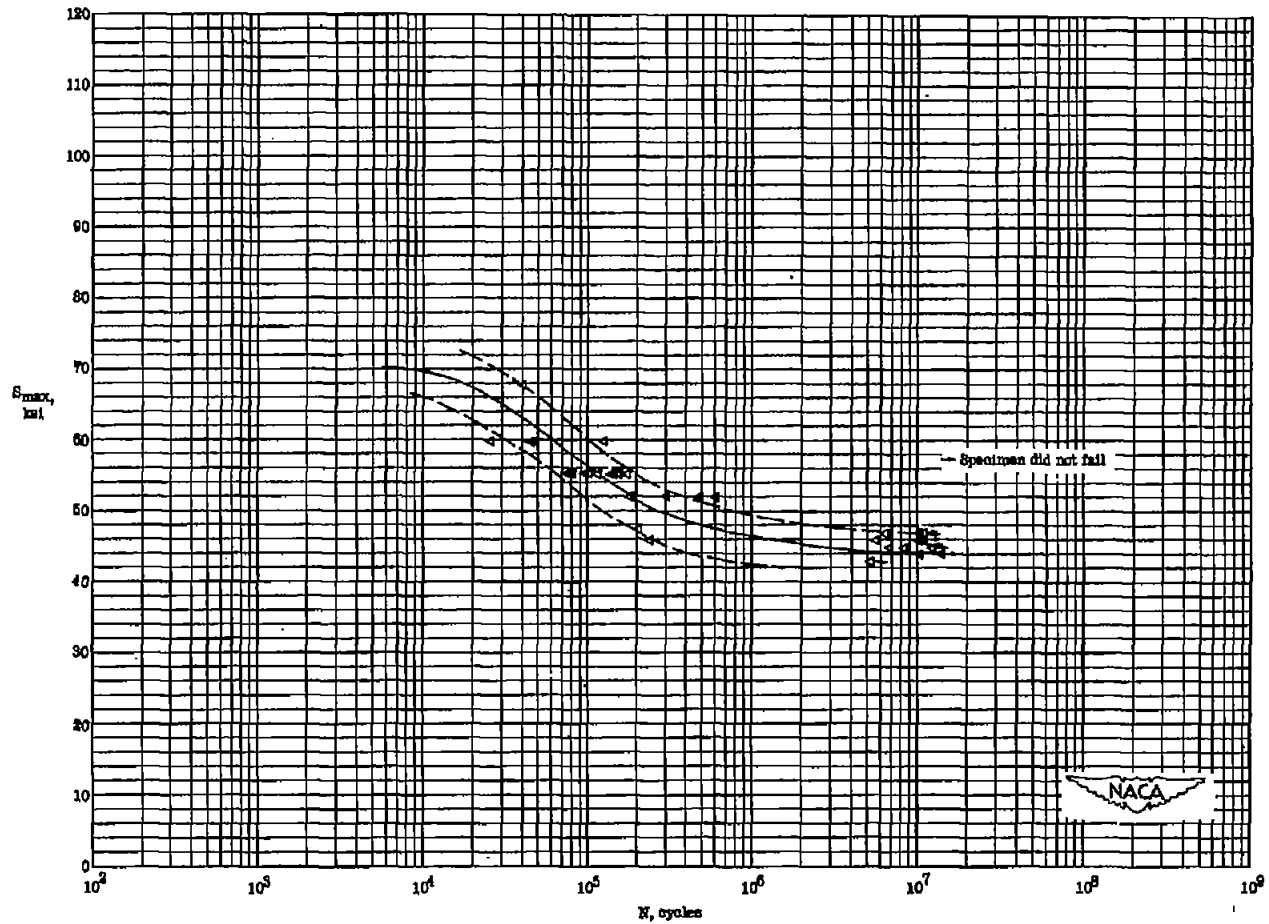
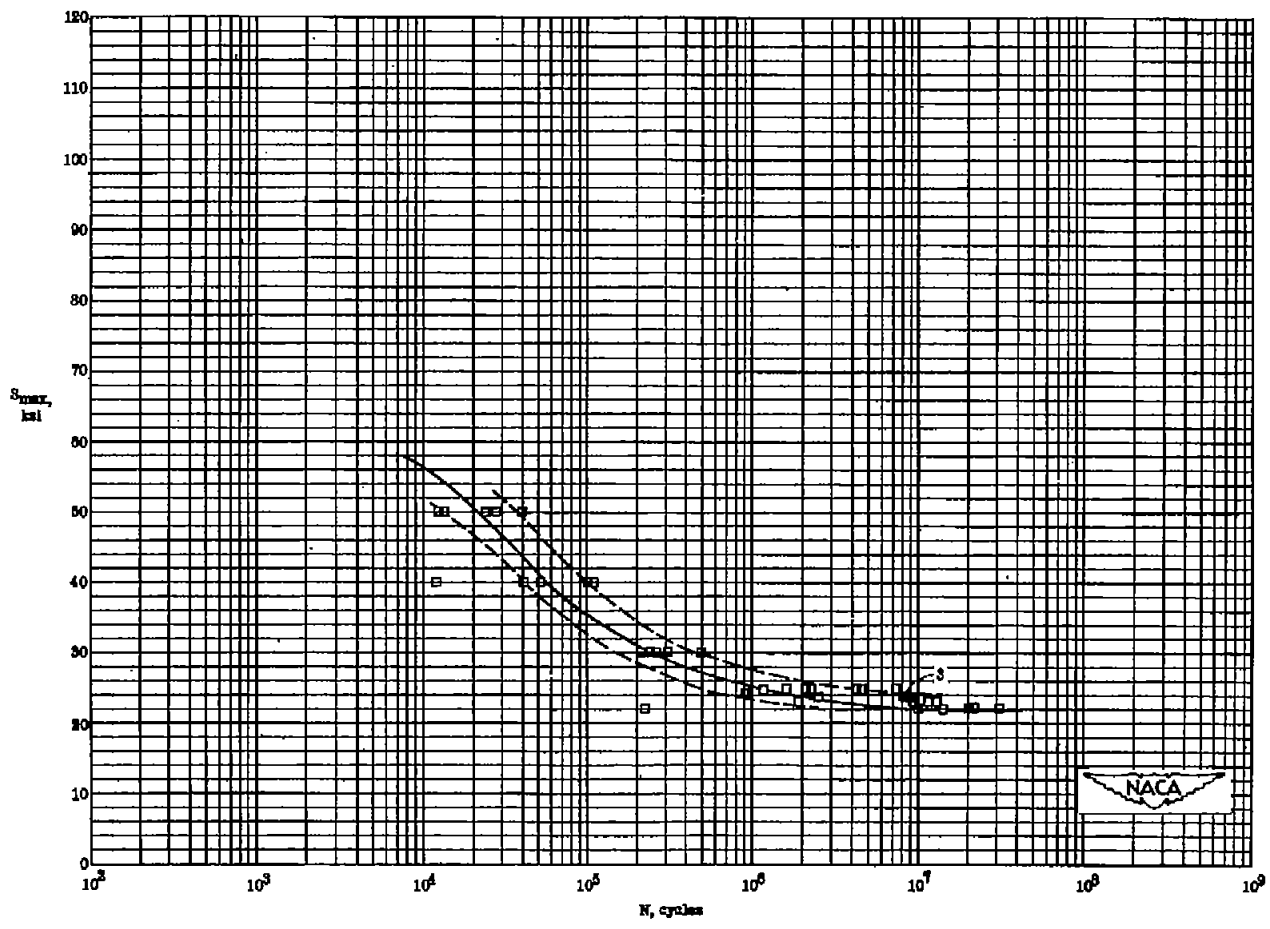

Figure 4.- Sketch of tension-compression grips and guide plates. Only upper portion shown. All dimensions are in inches.



(a) $R = 0.25$.

Figure 5.- Results of fatigue tests at various stress ratios on unnotched 24S-T3 aluminum-alloy sheet specimens tested by Battelle.



(b) $R = -1.00$.

Figure 5.- Continued.

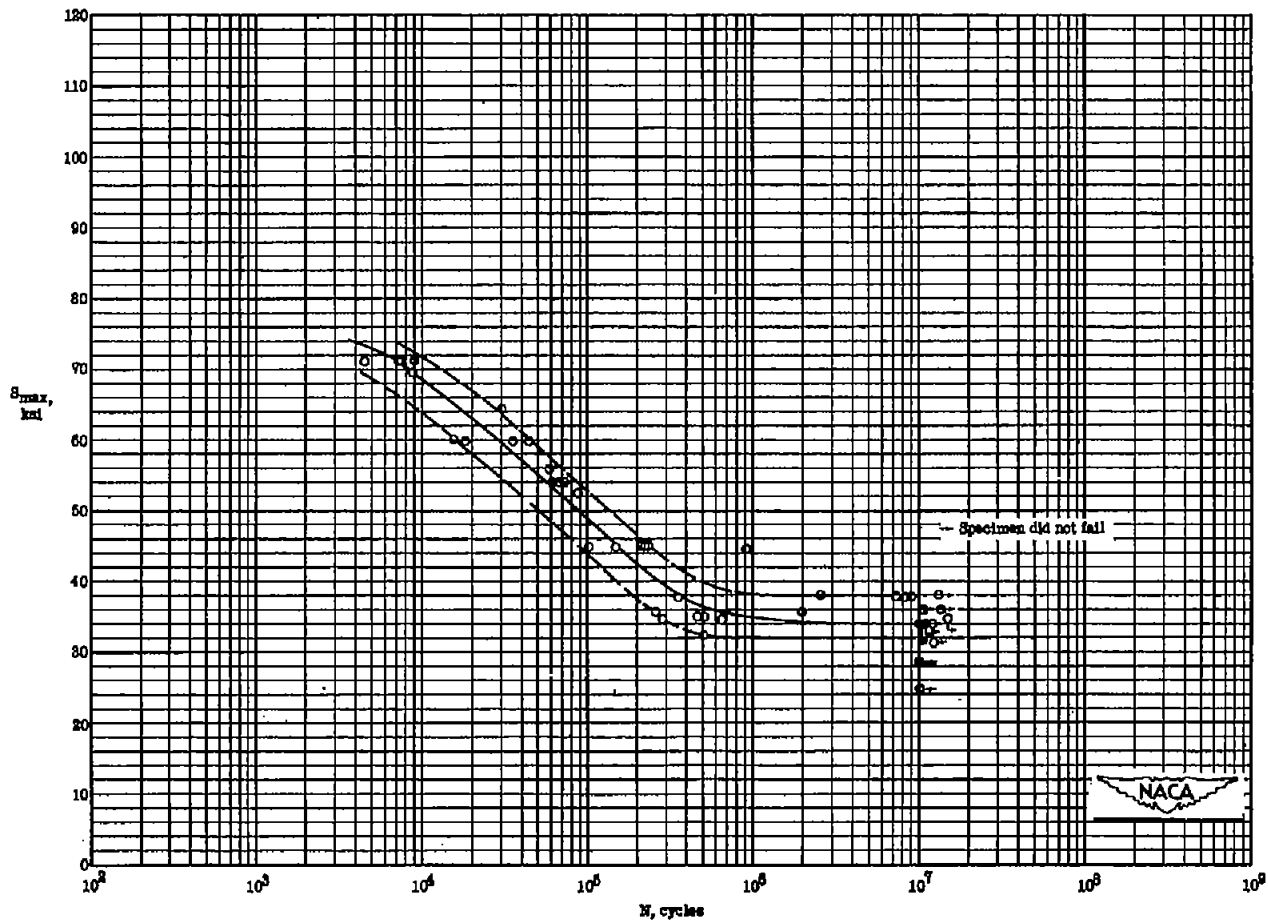

(c) $R = 0.02$.

Figure 5.- Continued.

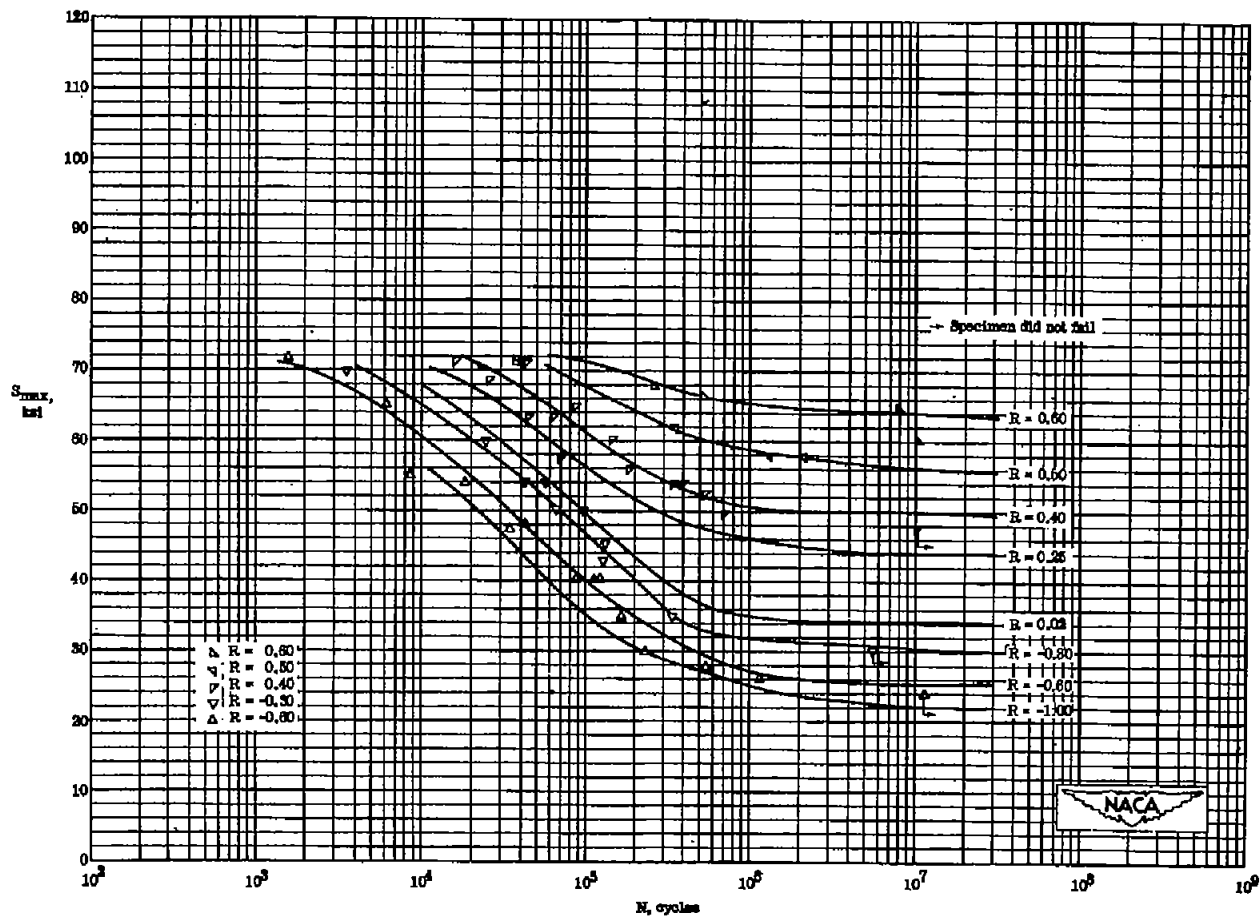

(d) $R = -1.00$ to 0.60 .

Figure 5.- Concluded.

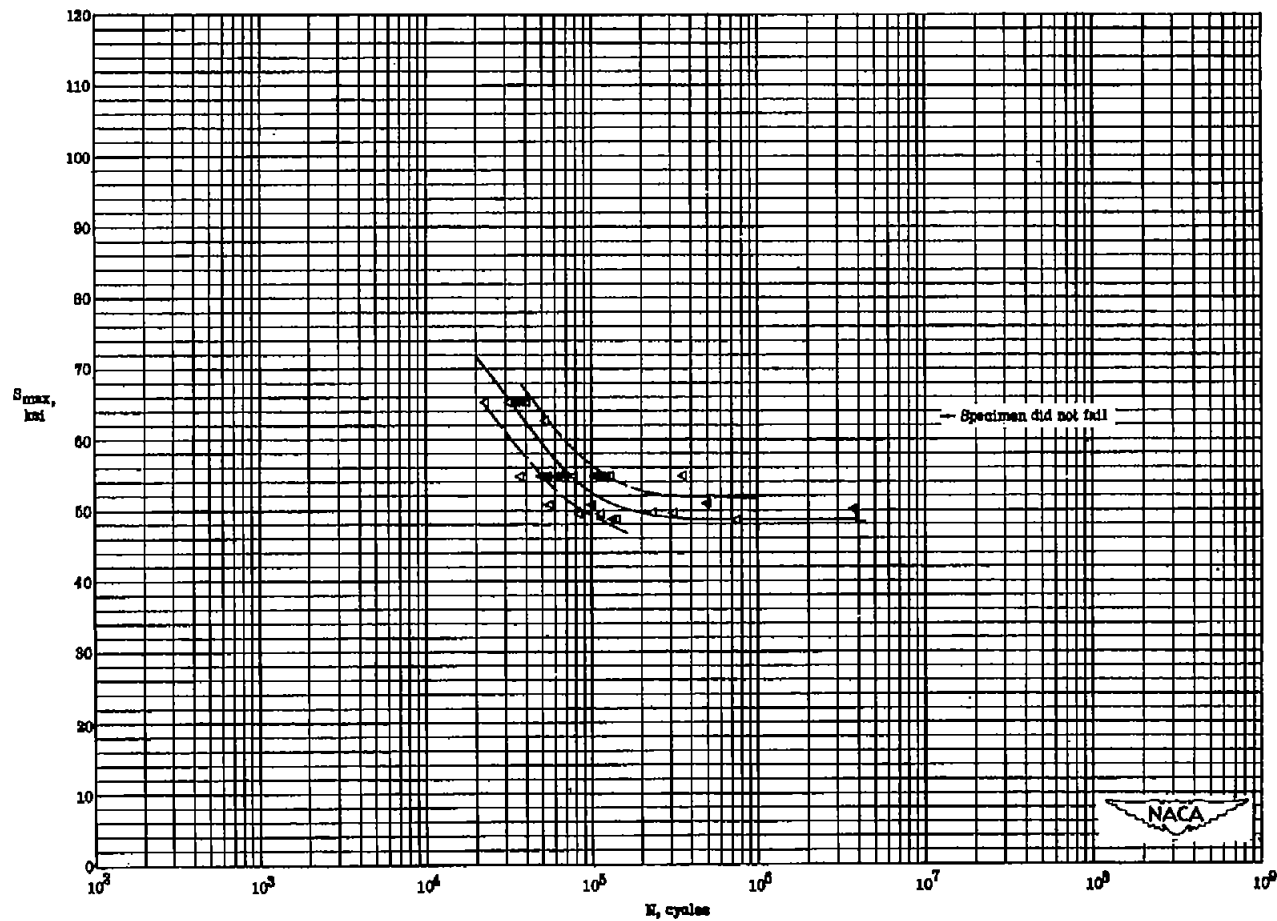

(a) $R = 0.25$.

Figure 6.- Results of fatigue tests at various stress ratios on unnotched 75S-T6 aluminum-alloy sheet specimens tested by Battelle.

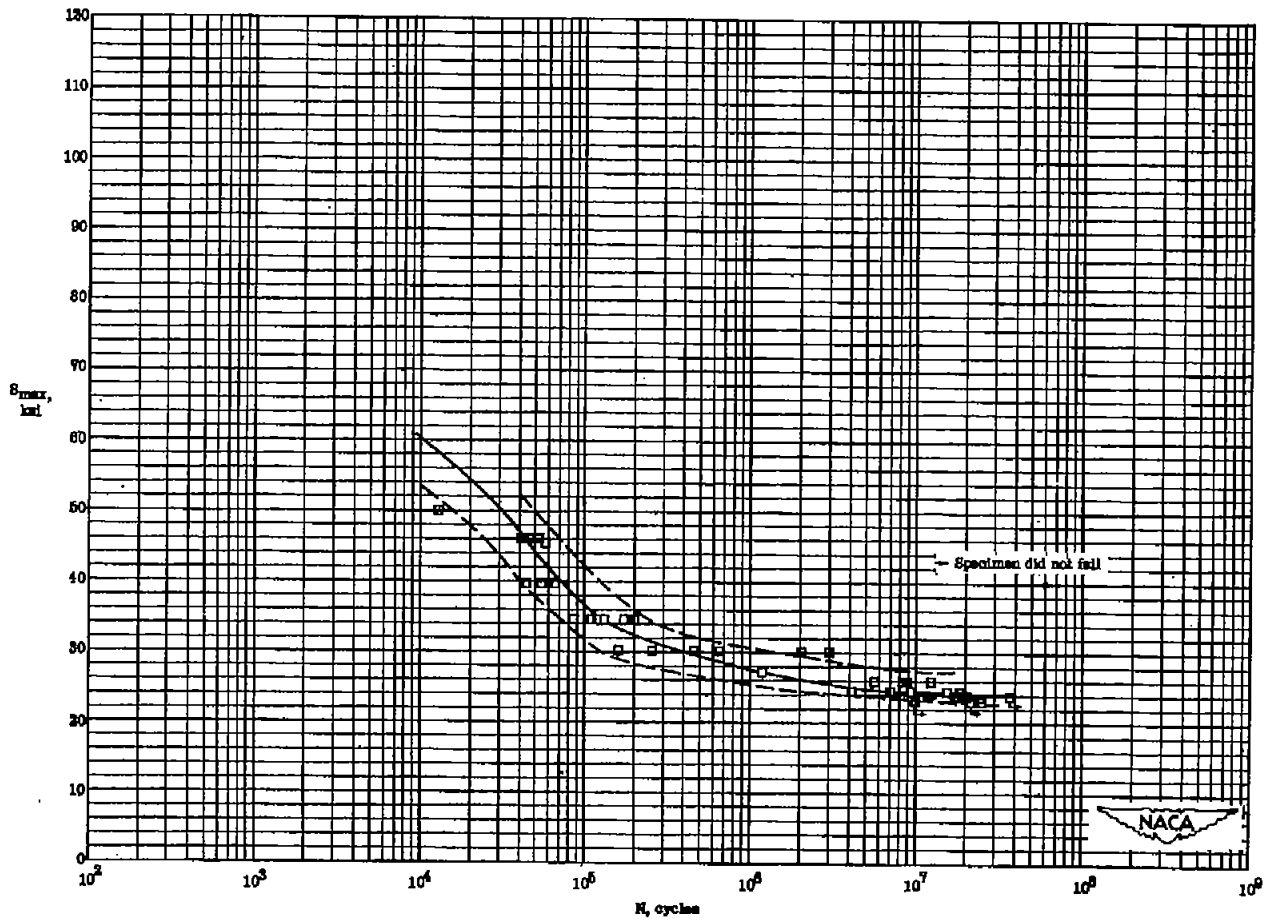

(b) $R = -1.00$.

Figure 6.- Continued.

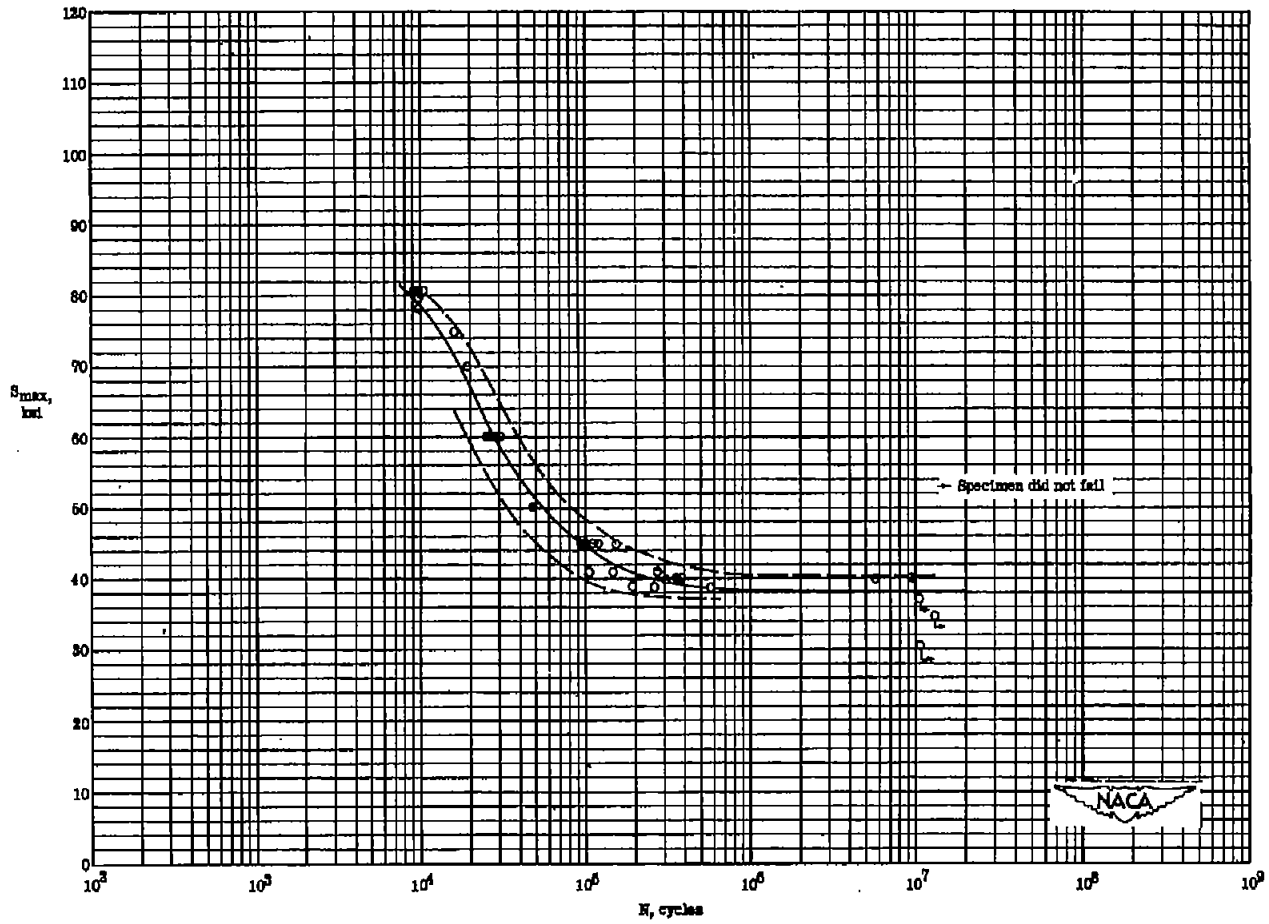

(c) $R = 0.02$.

Figure 6.- Continued.

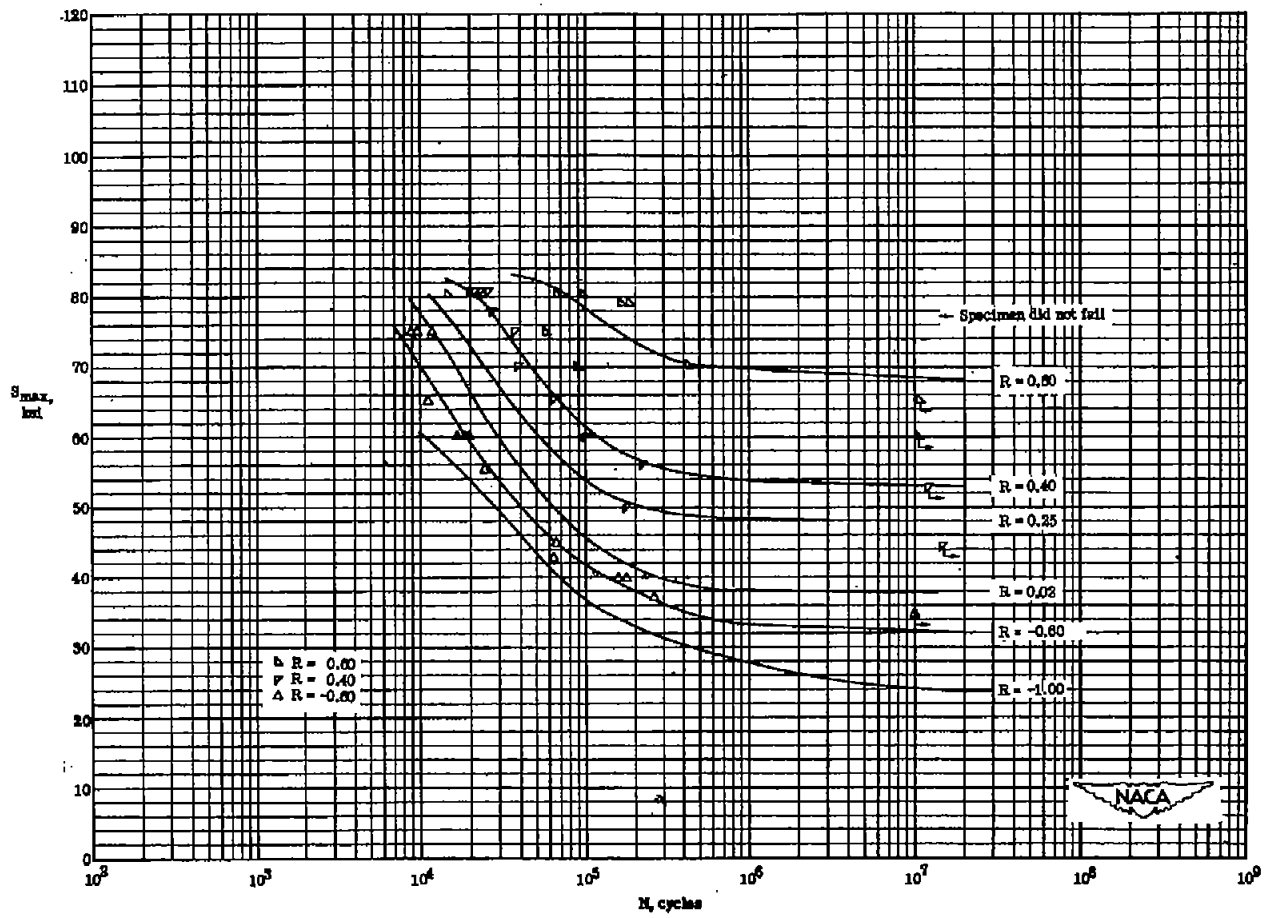

(d) $R = -1.00$ to 0.60 .

Figure 6.- Concluded.

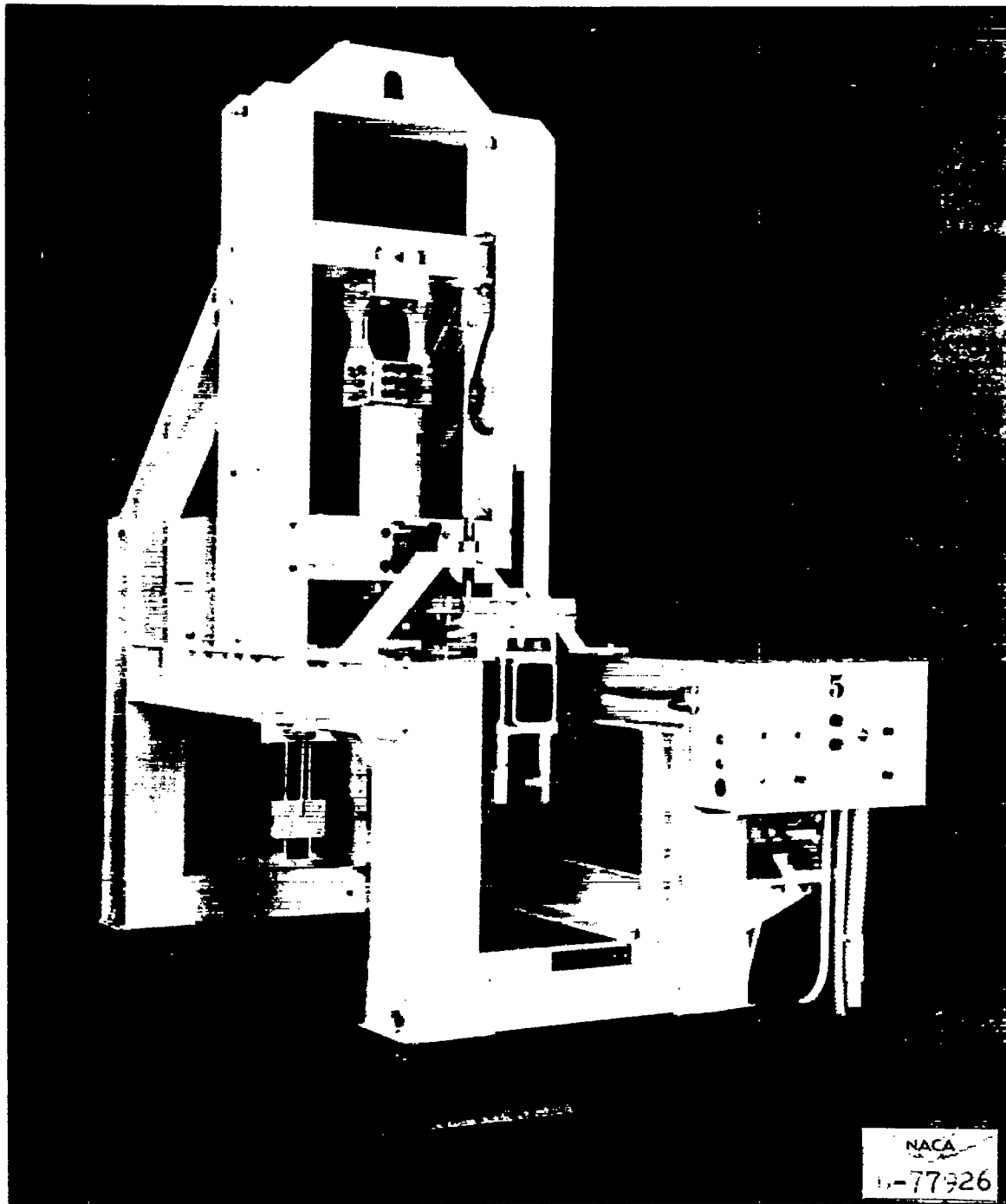

Figure 7.- Axial-load fatigue testing machine used by NACA.

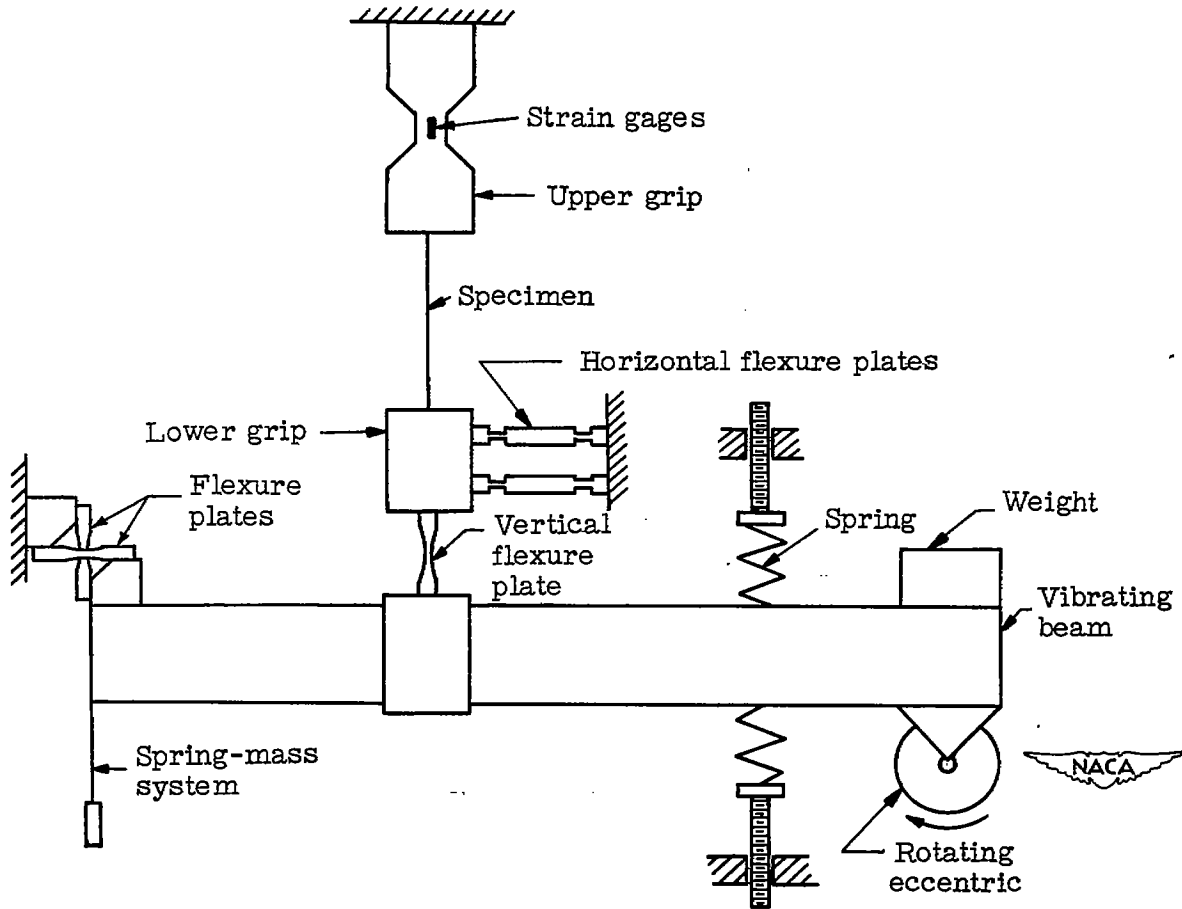

Figure 8.- Schematic drawing of fatigue testing machine used by NACA.

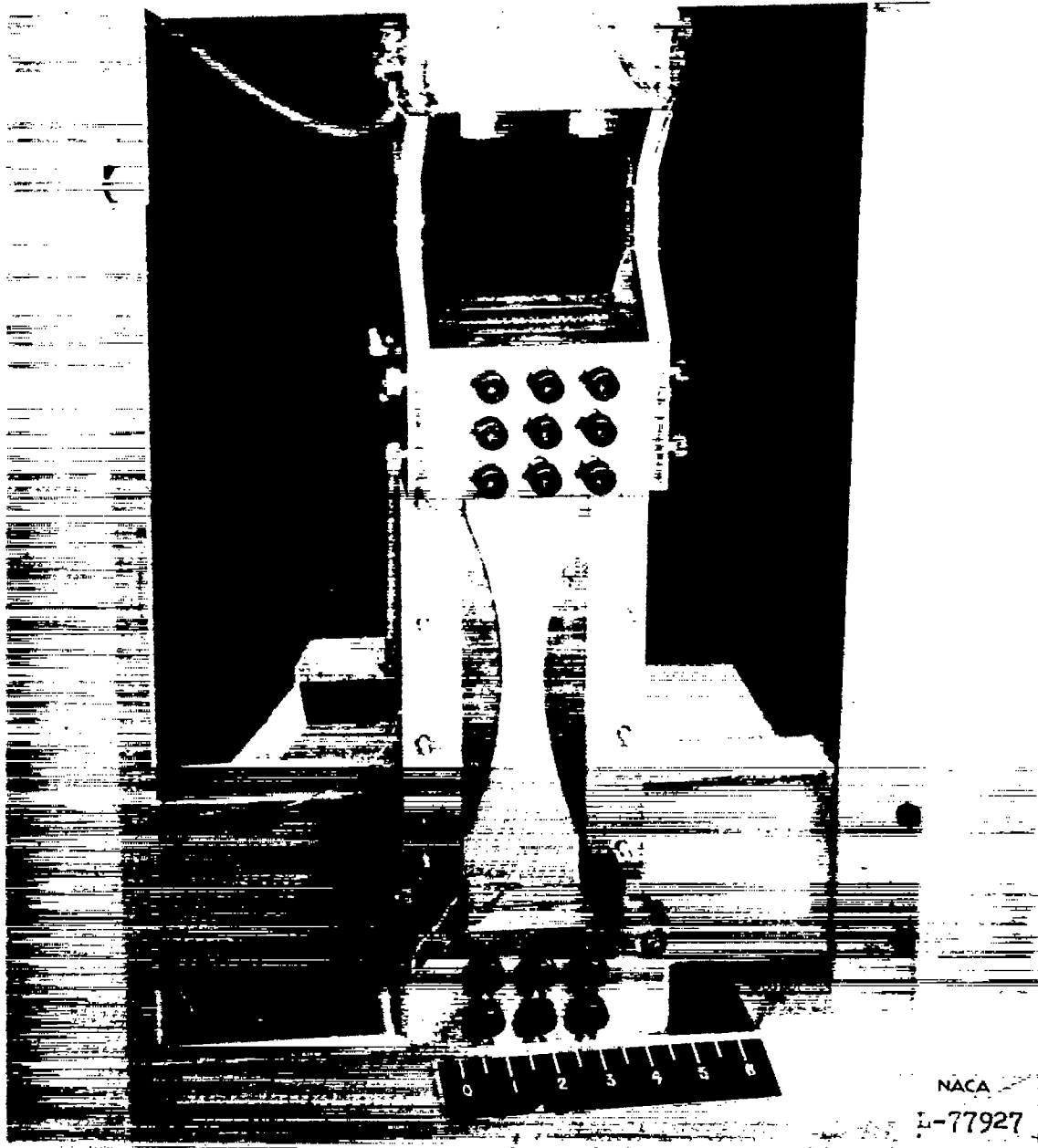
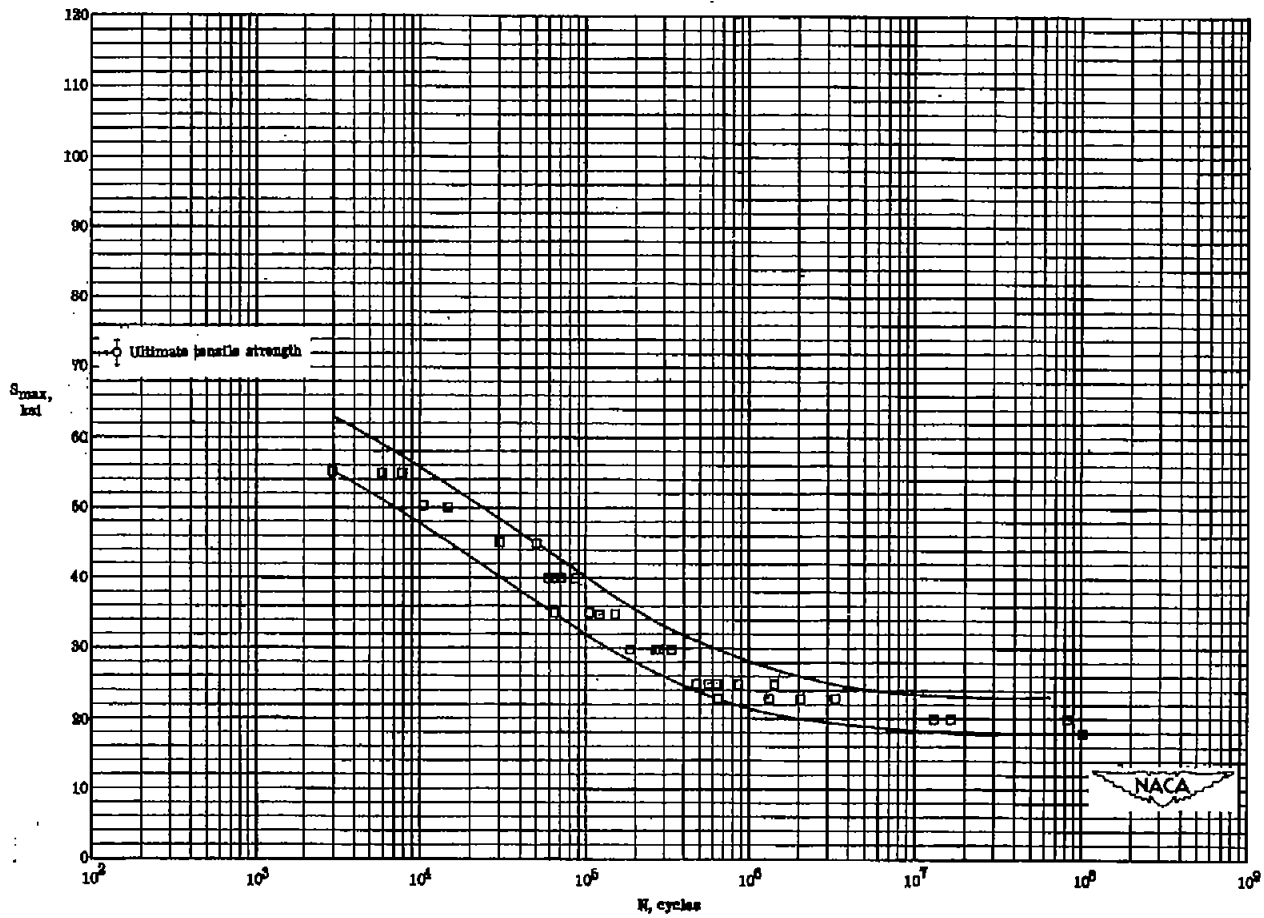
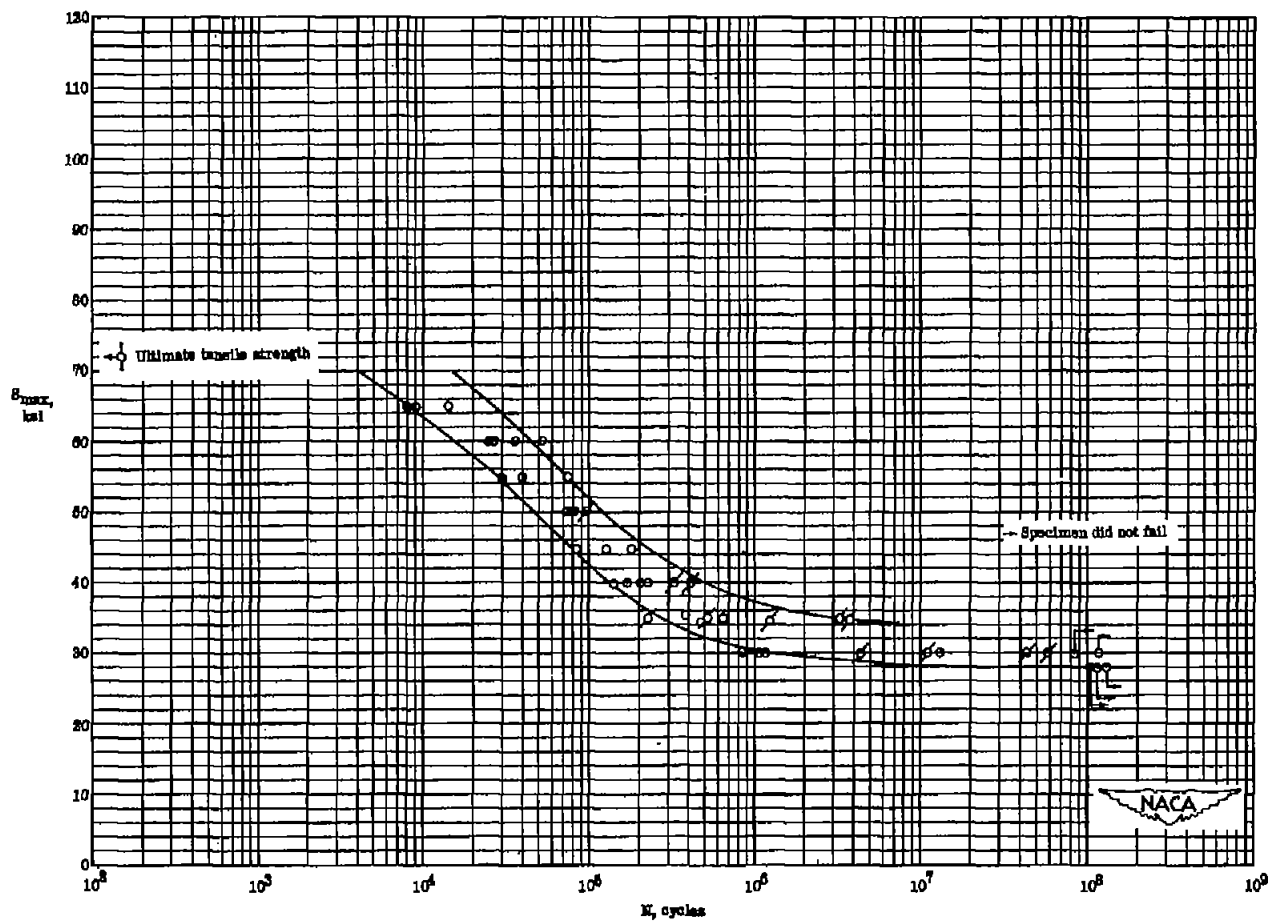

Figure 9.- View of specimen installed in fatigue testing machine used by NACA.



(a) $R = -1.00$.

Figure 10.- Results of fatigue tests at various stress ratios on unnotched 24S-T3 aluminum-alloy sheet specimens tested by NACA.



(b) $R = 0$. Test points with diagonal lines represent tests without guides.

Figure 10.- Concluded.

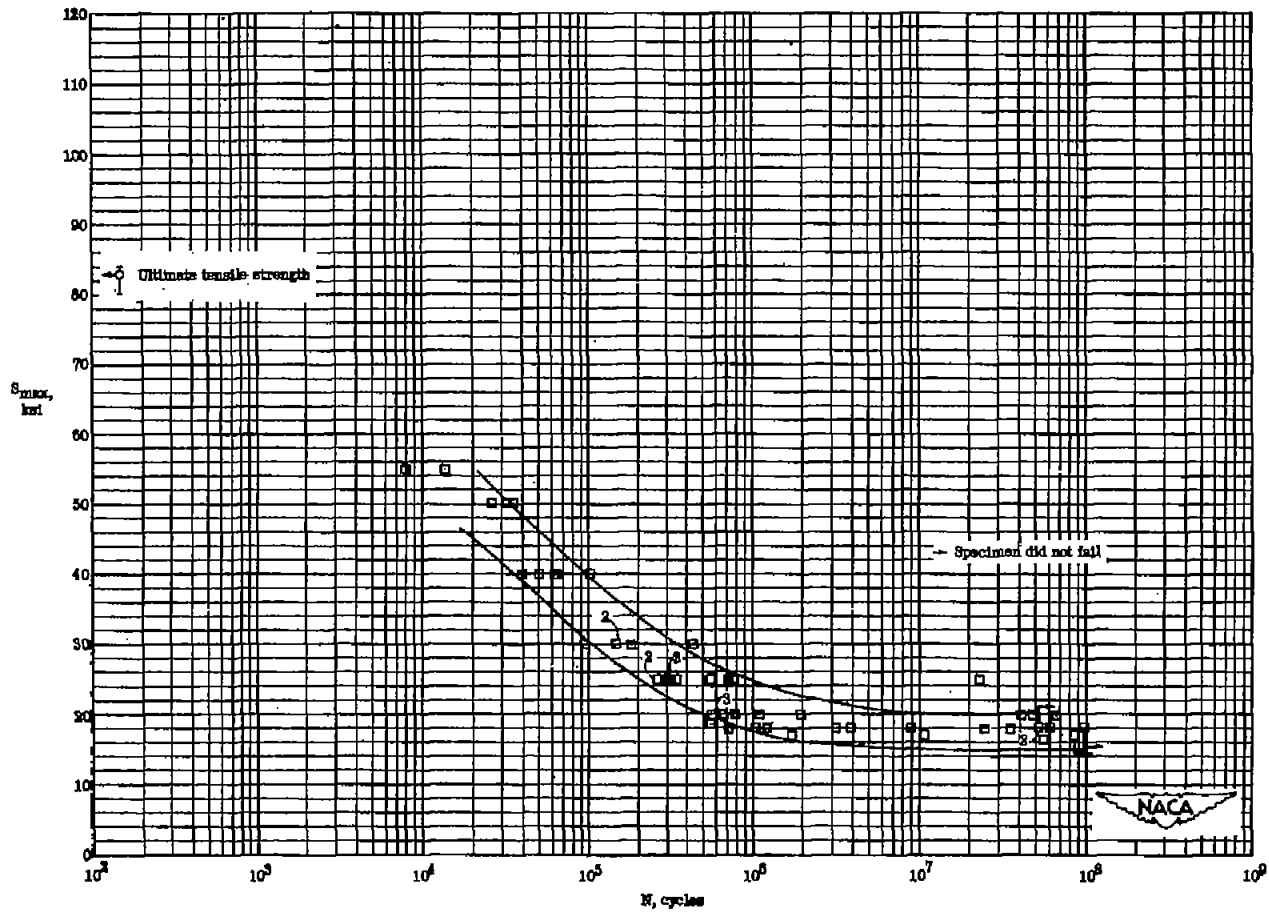

(a) $R = -1.00$.

Figure 11.- Results of fatigue tests at various stress ratios on unnotched 75S-T6 aluminum-alloy sheet specimens tested by NACA.

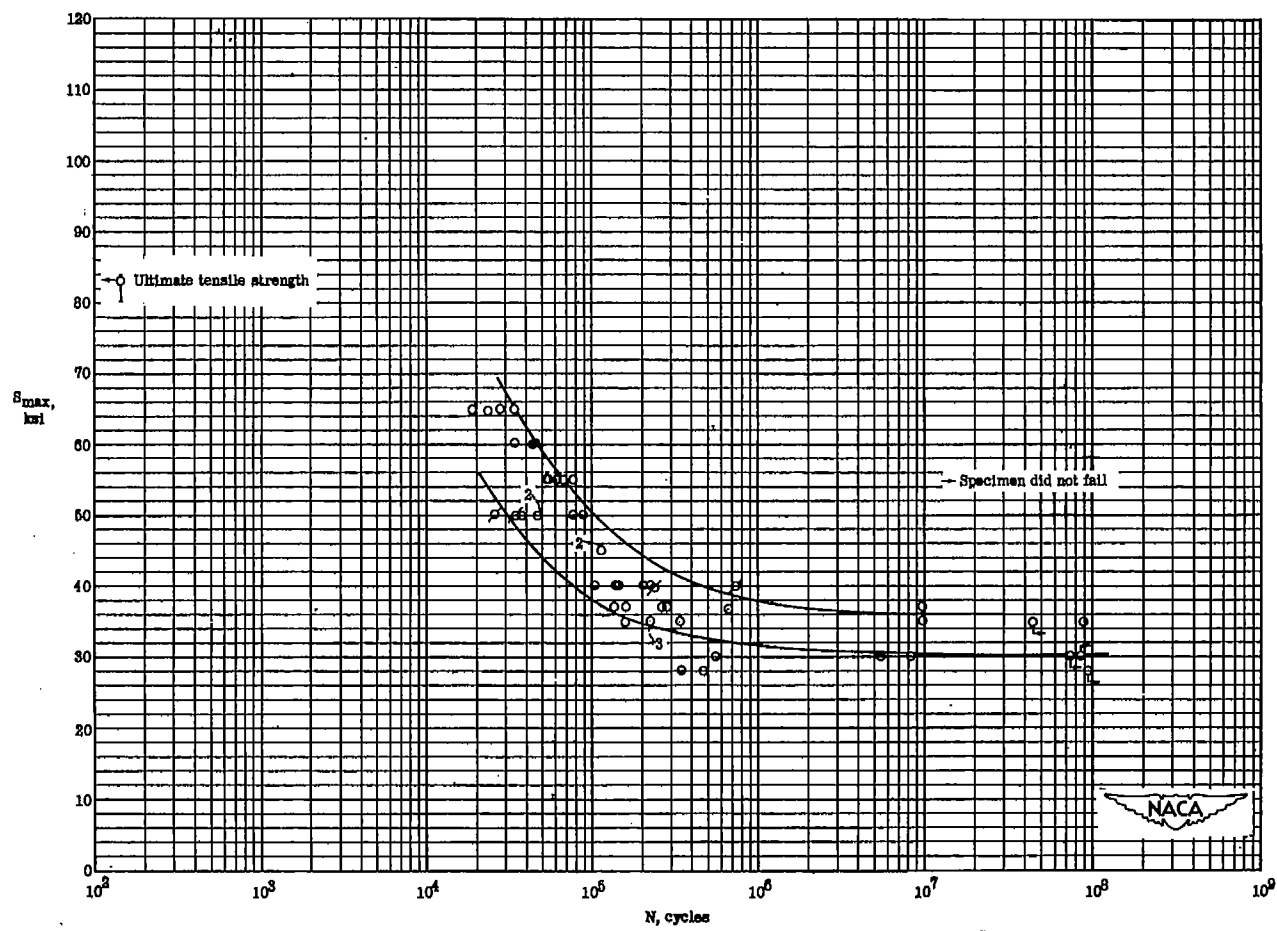

(b) $R = 0$. Test points with diagonal lines represent tests without guides.

Figure 11.- Concluded.

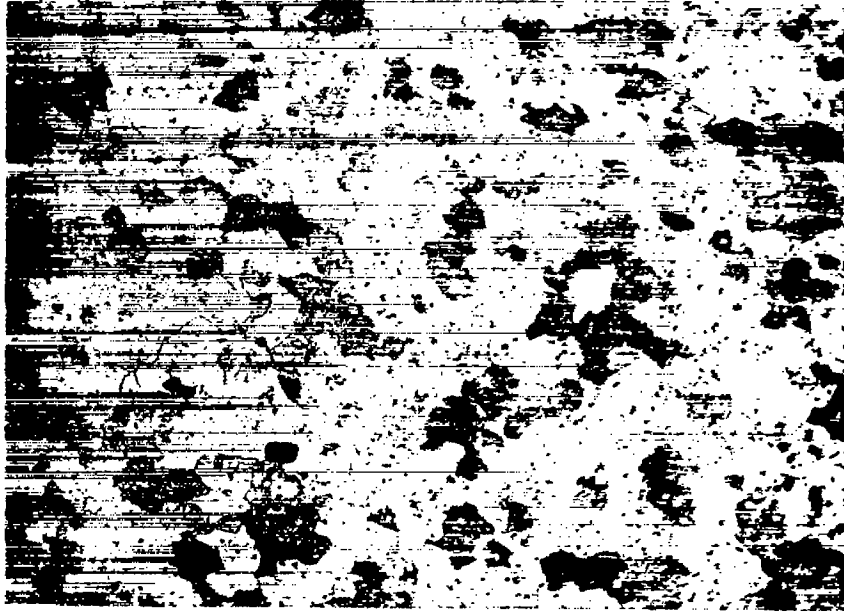

(a) Cross section.

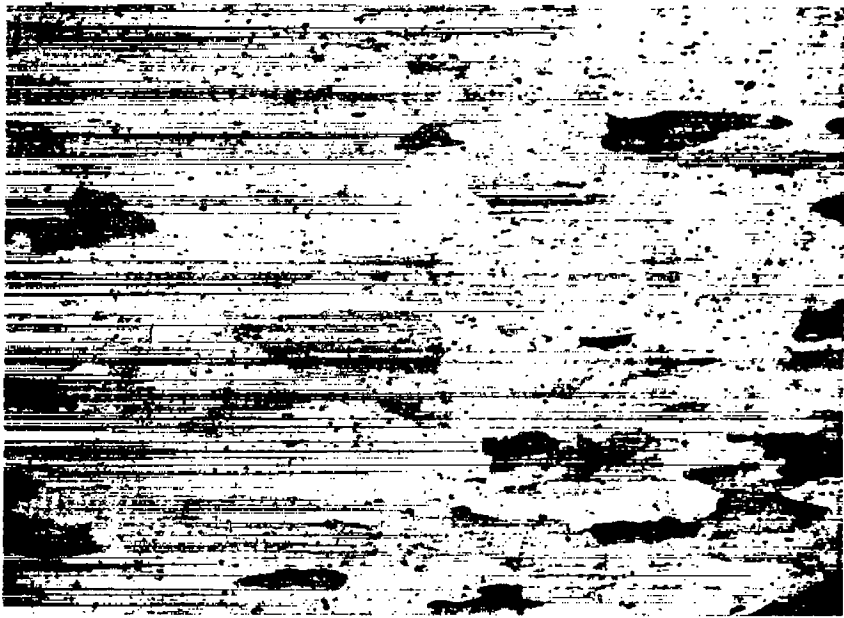

(b) Longitudinal section.

NACA
L-77928

Figure 12.- Microstructure of 24S-T4 aluminum-alloy rod, sample P-746
(Keller's Etch, X100).

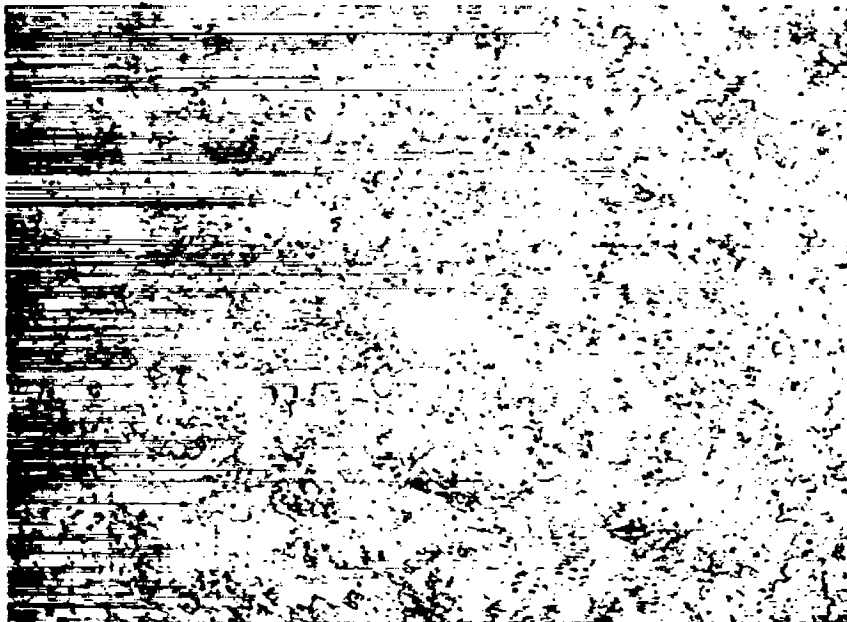

(a) Cross section.

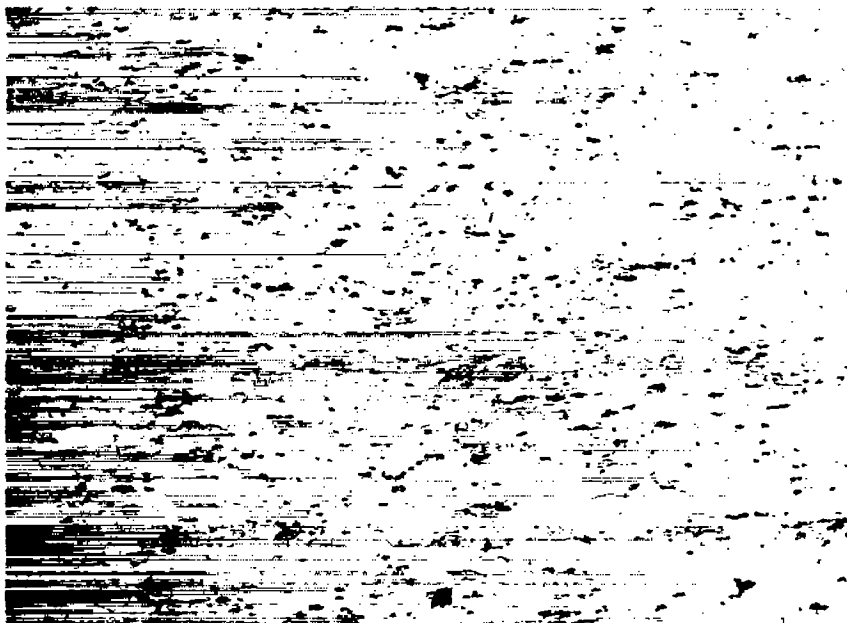

(b) Longitudinal section.



L-77929

Figure 13.- Microstructure of 24S-T4 aluminum-alloy rod, sample P-853
(Keller's Etch, X100).

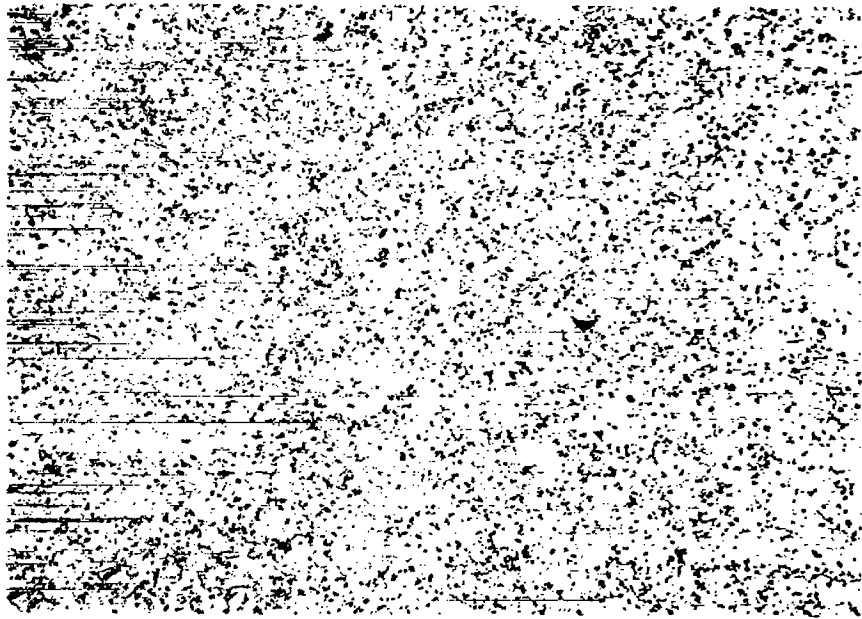

(a) Cross section.

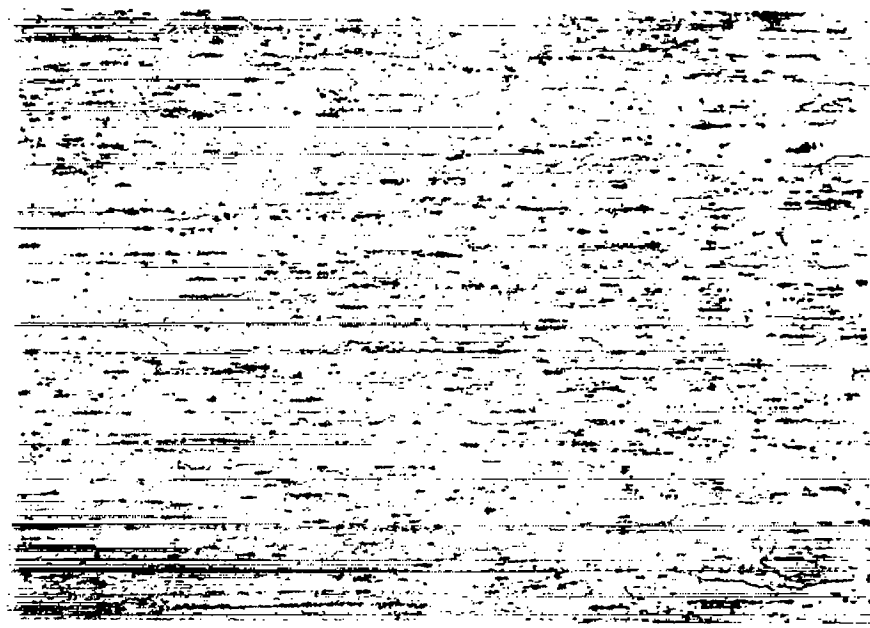

(b) Longitudinal section.



L-77930

Figure 14.- Microstructure of 75S-T6 aluminum-alloy rod, sample 70968
(Keller's Etch, X100).

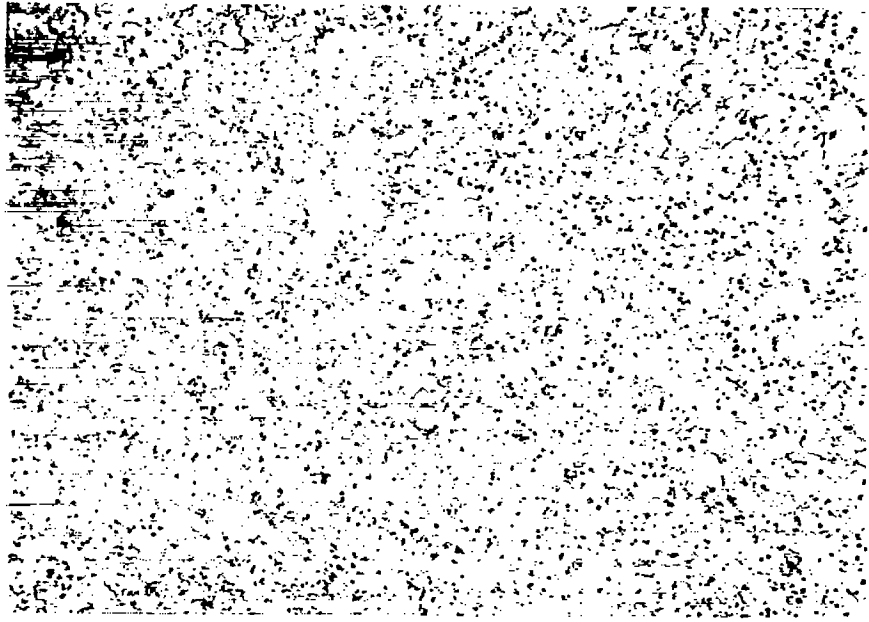

(a) Cross section.



(b) Longitudinal section.

NACA
L-77931

Figure 15.- Microstructure of 75S-T6 aluminum-alloy rod, sample 116517
(Keller's Etch, X100).

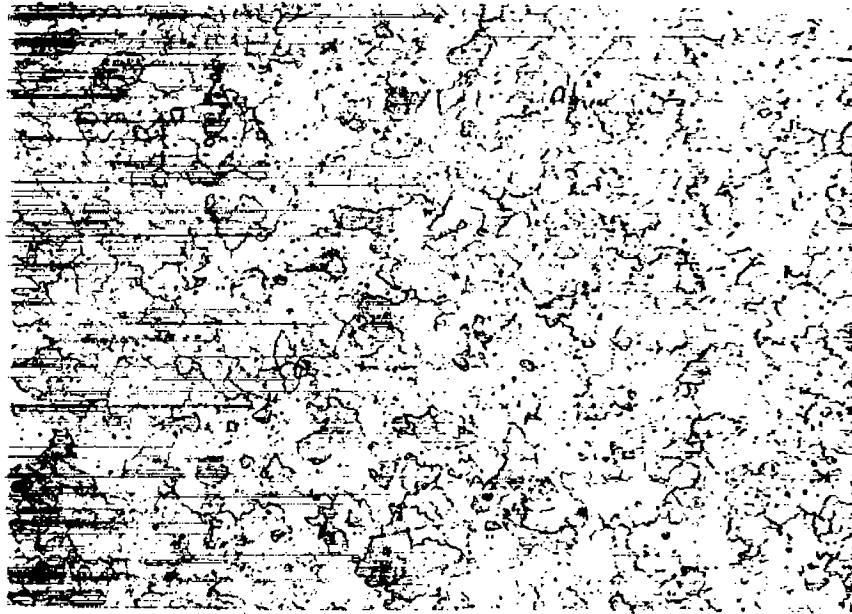

(a) Cross section.



(b) Longitudinal section.

NACA
L-77932

Figure 16.- Microstructure of 75S-T6 aluminum-alloy rod, sample 117482
(Keller's Etch, X100).

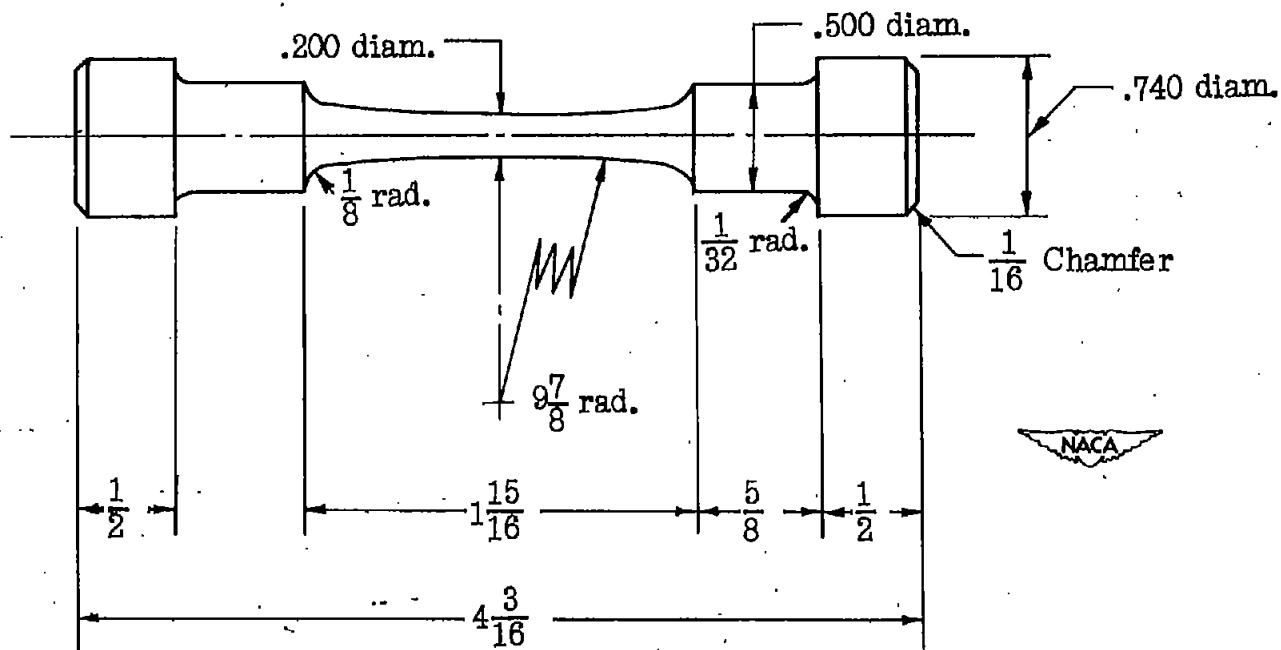

Figure 17.- Fatigue test specimen tested by ALCOA. All dimensions are in inches.

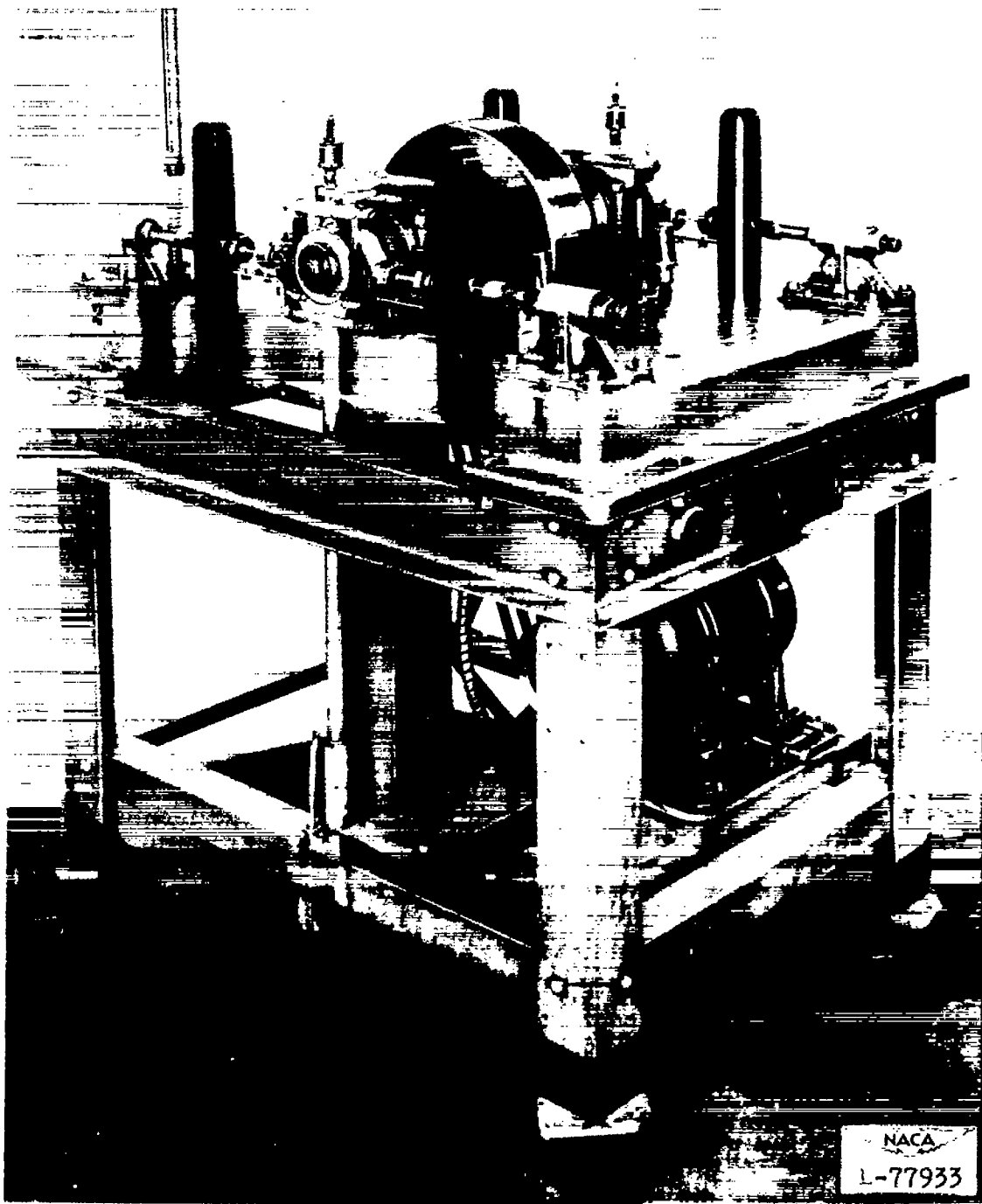

Figure 18.- Axial-stress fatigue testing machine used by ALCOA.

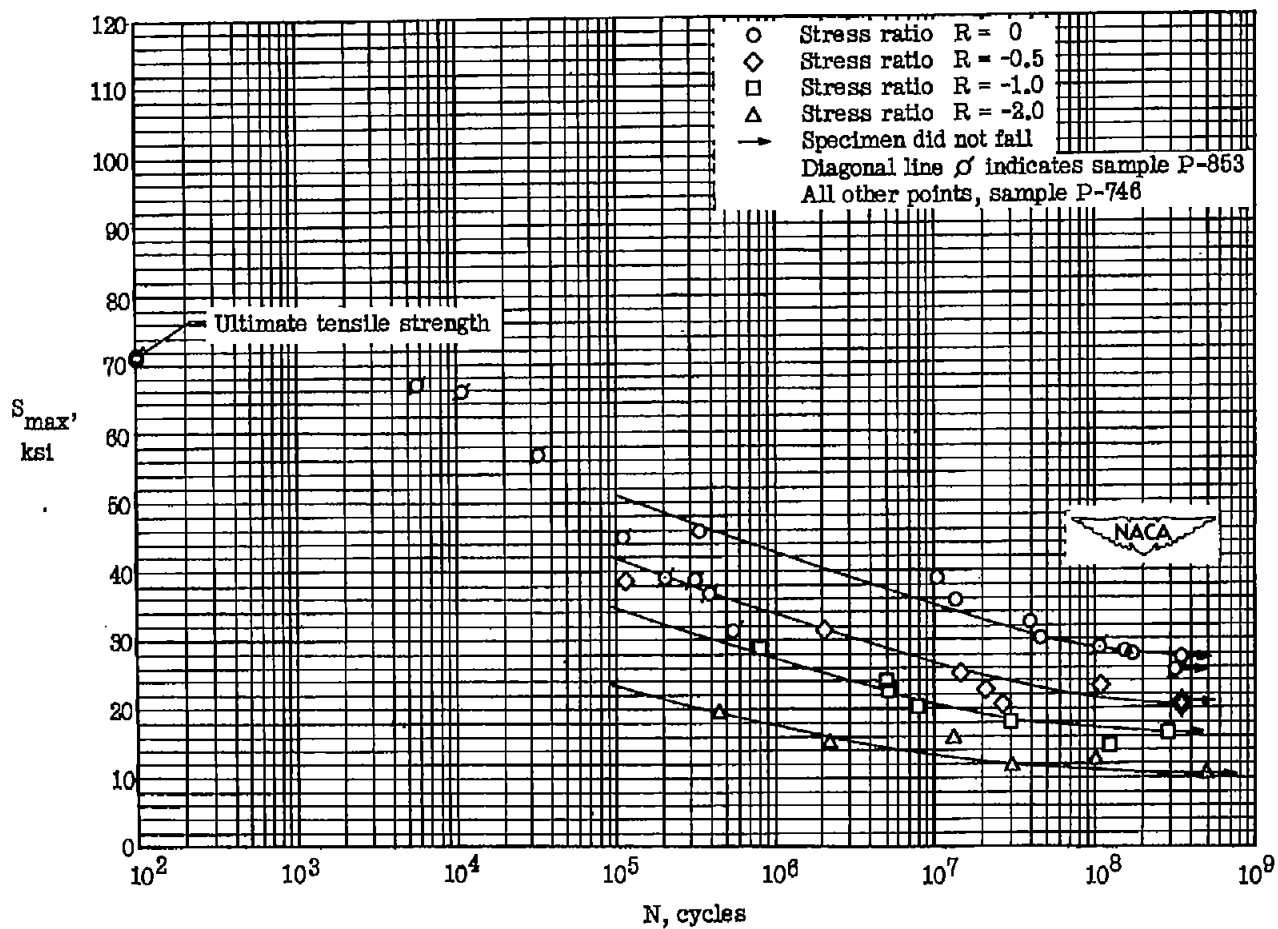

Figure 19.- Results of fatigue tests on unnotched 24S-T4 aluminum-alloy rolled and drawn rod specimens tested by ALCOA.

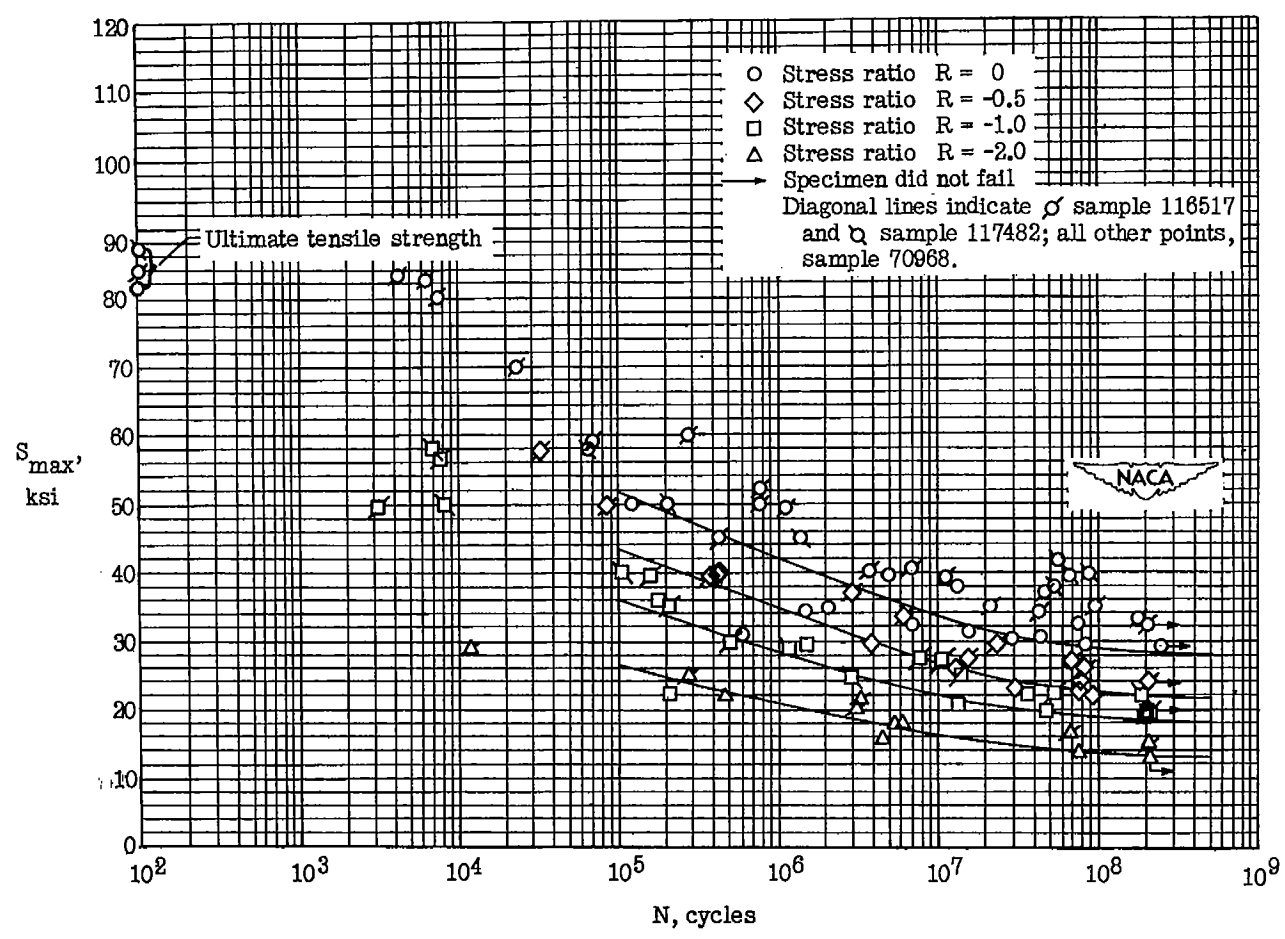
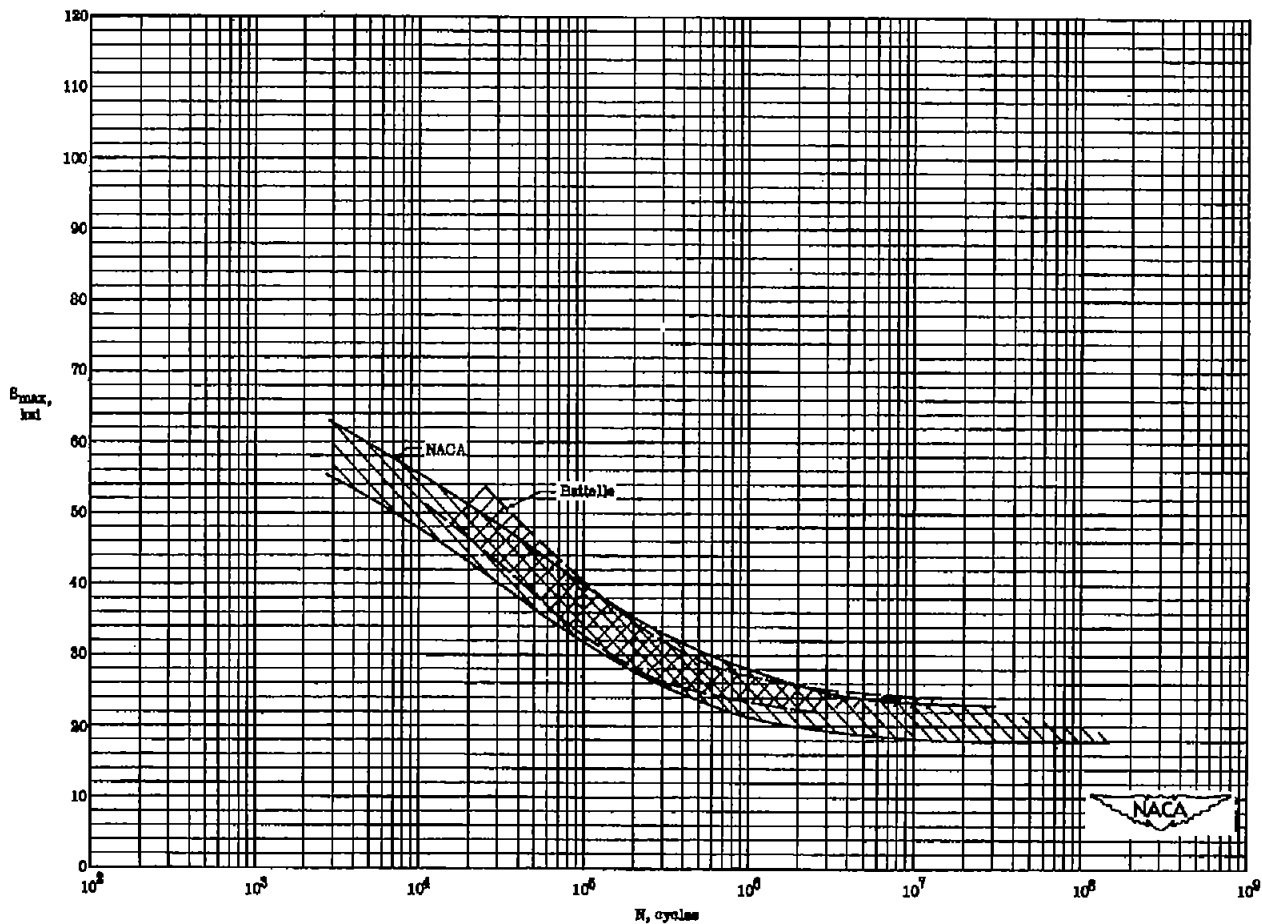
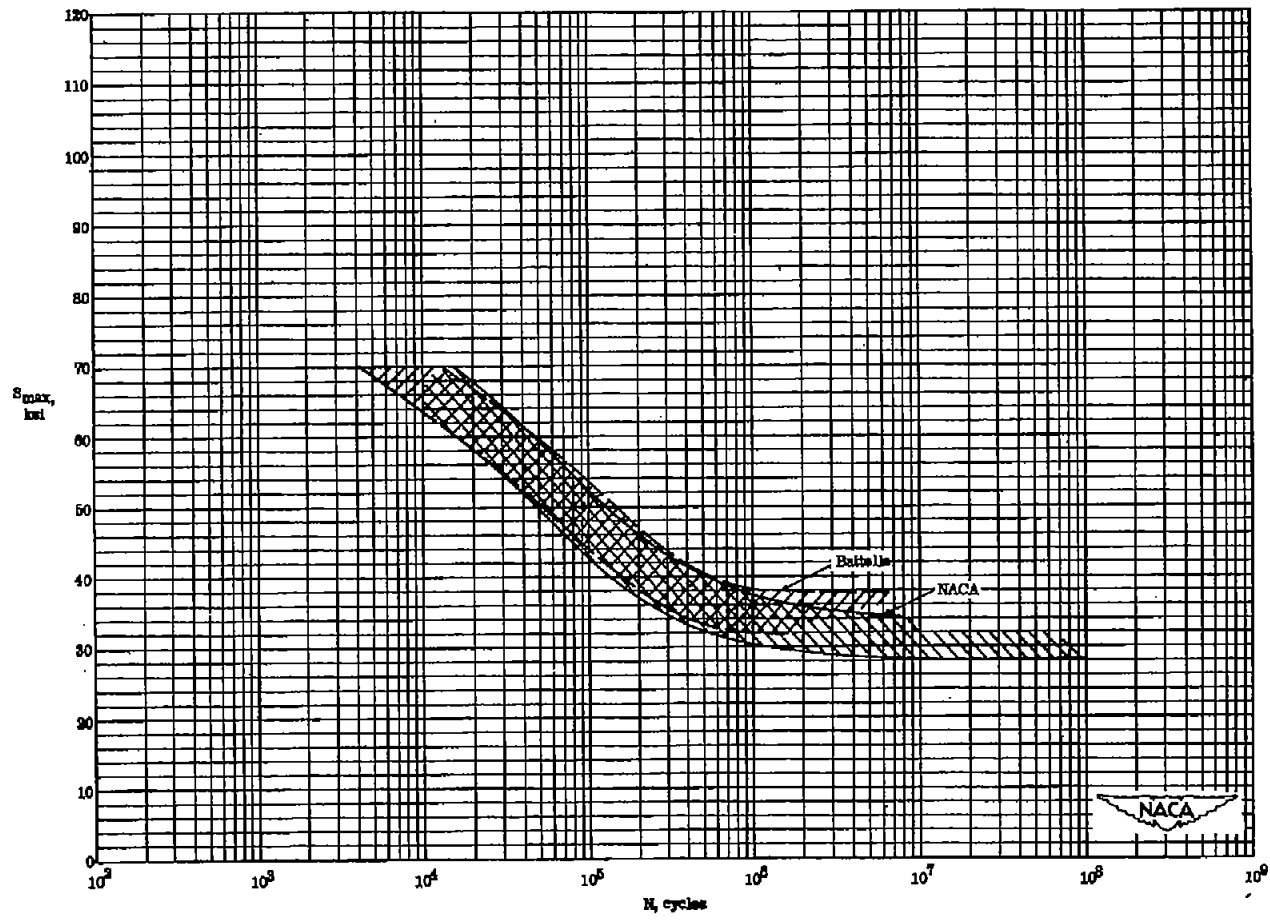

Figure 20.- Results of fatigue tests on unnotched 75S-T6 aluminum-alloy rolled and drawn rod specimens tested by ALCOA.



(a) $R = -1.00$.

Figure 21.- Comparison of results of fatigue tests at various stress ratios on unnotched 24S-T3 aluminum-alloy sheet specimens tested by Battelle and NACA.



(b) $R = 0$.

Figure 21.- Concluded.

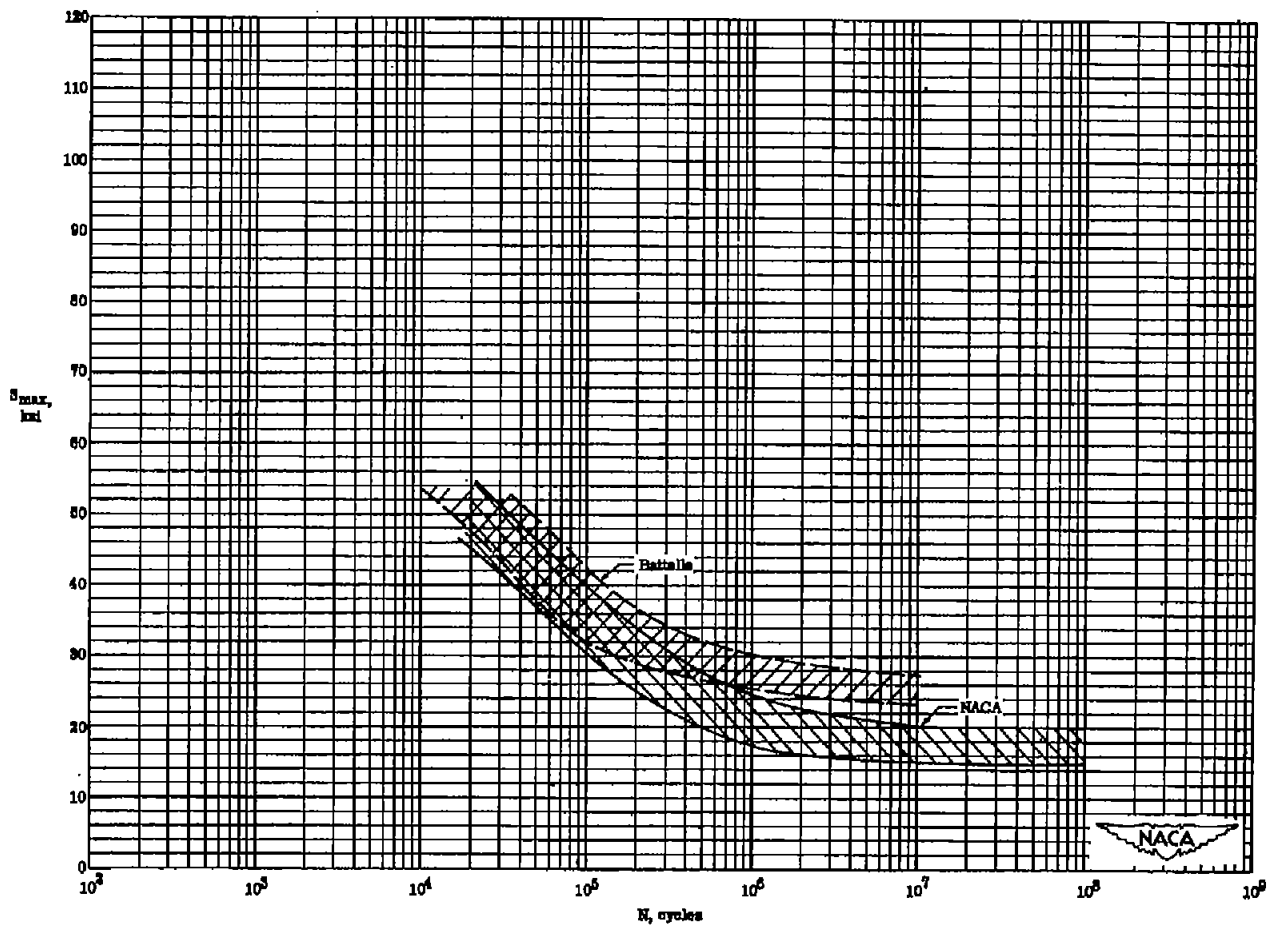

(a) $R = -1.00$.

Figure 22.- Comparison of results of fatigue tests at various stress ratios on unnotched 75S-T6 aluminum-alloy sheet specimens tested by Battelle and NACA.

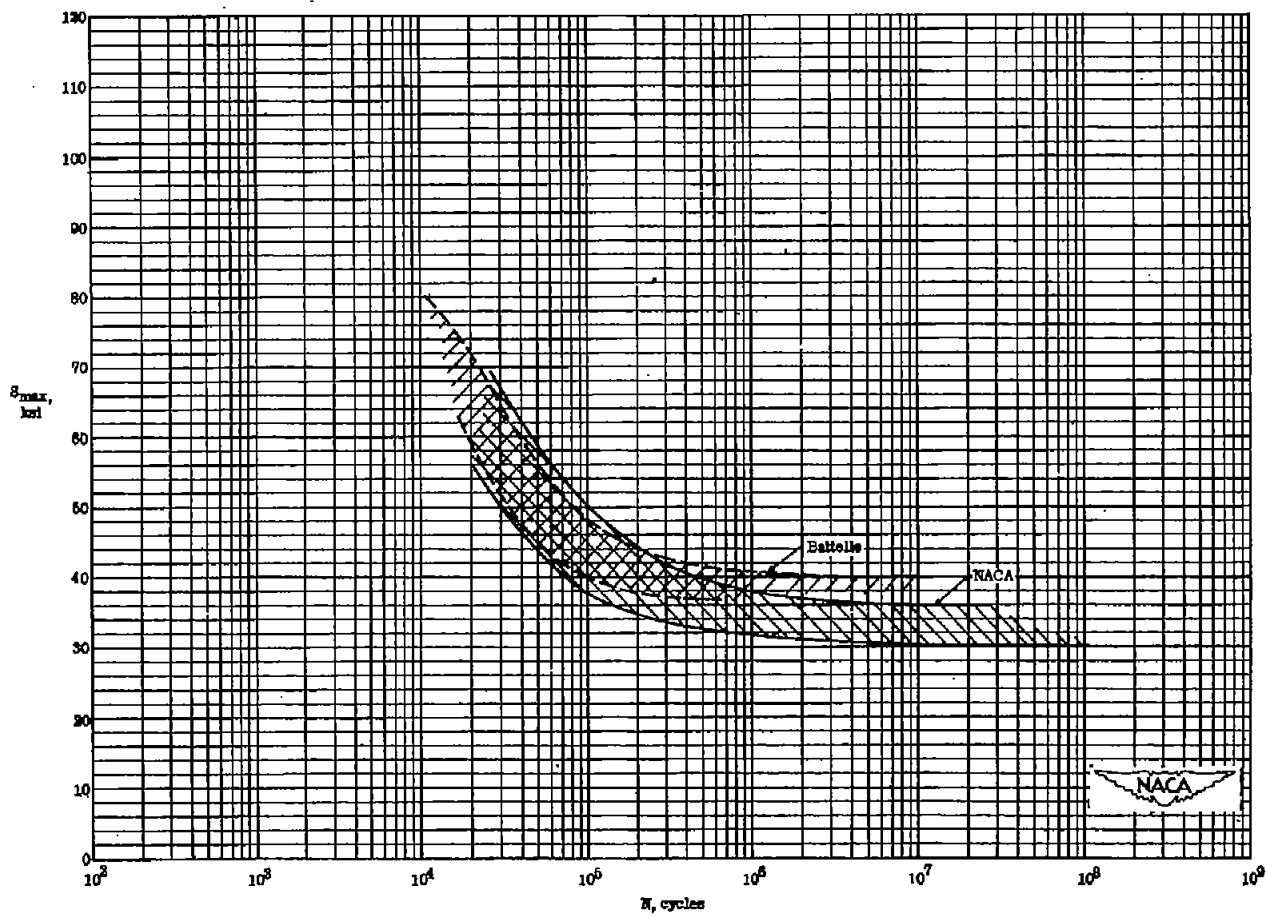

(b) $R = 0$.

Figure 22.- Concluded.

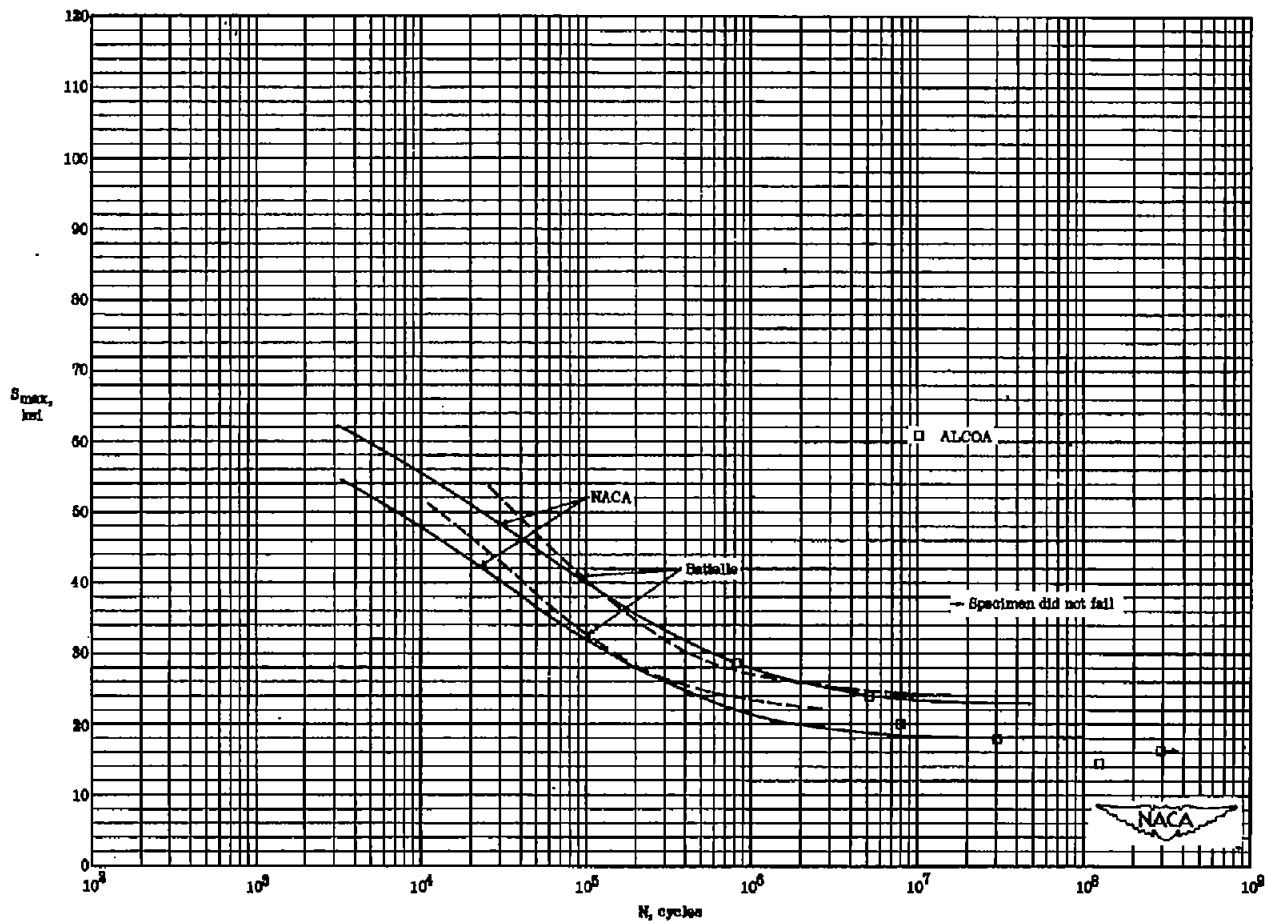

(a) $R = -1.00$.

Figure 23.- Comparison of results of fatigue tests at various stress ratios on unnotched 24S-T3 aluminum-alloy sheet specimens tested by Battelle and NACA and on unnotched 24S-T4 aluminum-alloy rolled and drawn rod specimens tested by ALCOA.

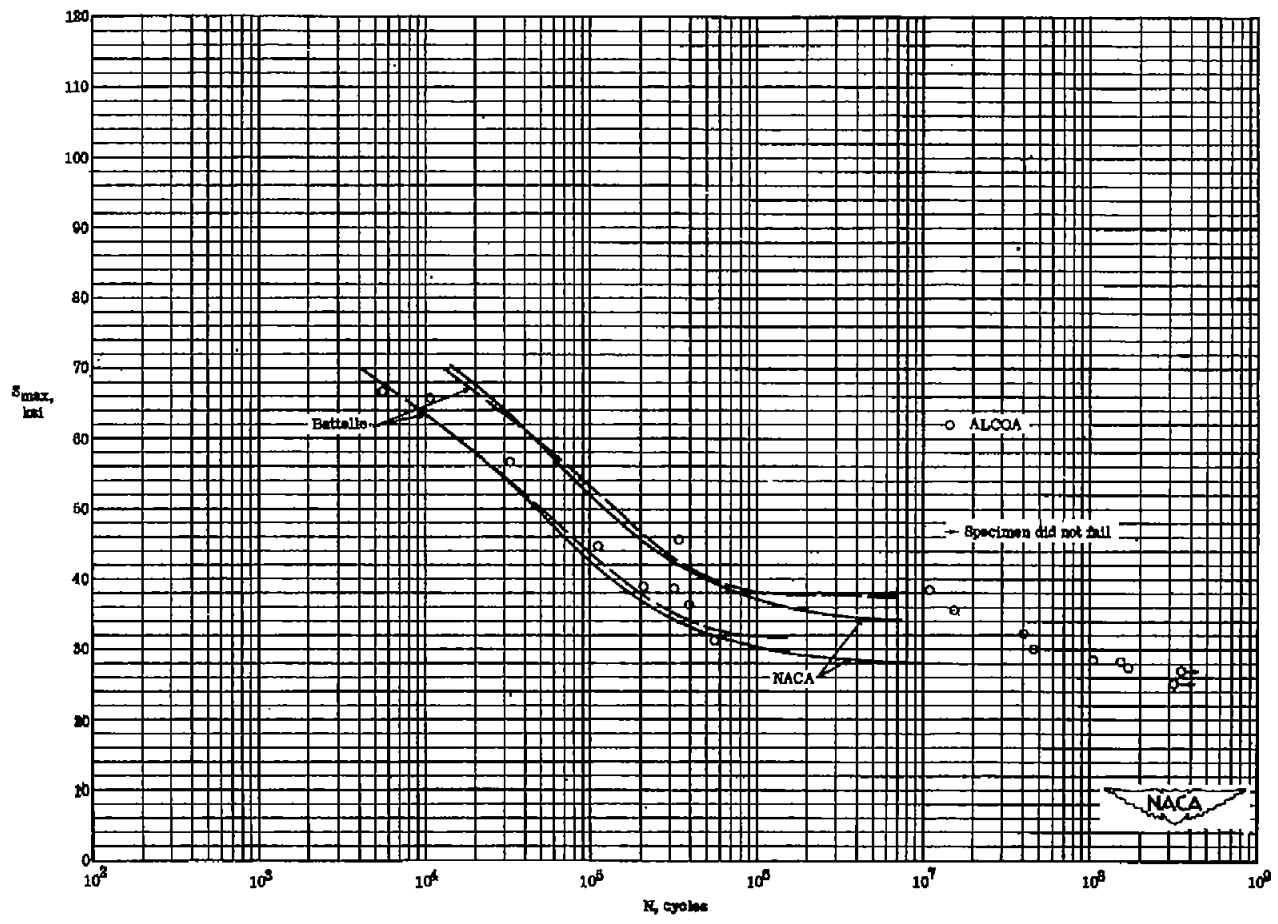

(b) $R = 0$.

Figure 23.- Concluded.

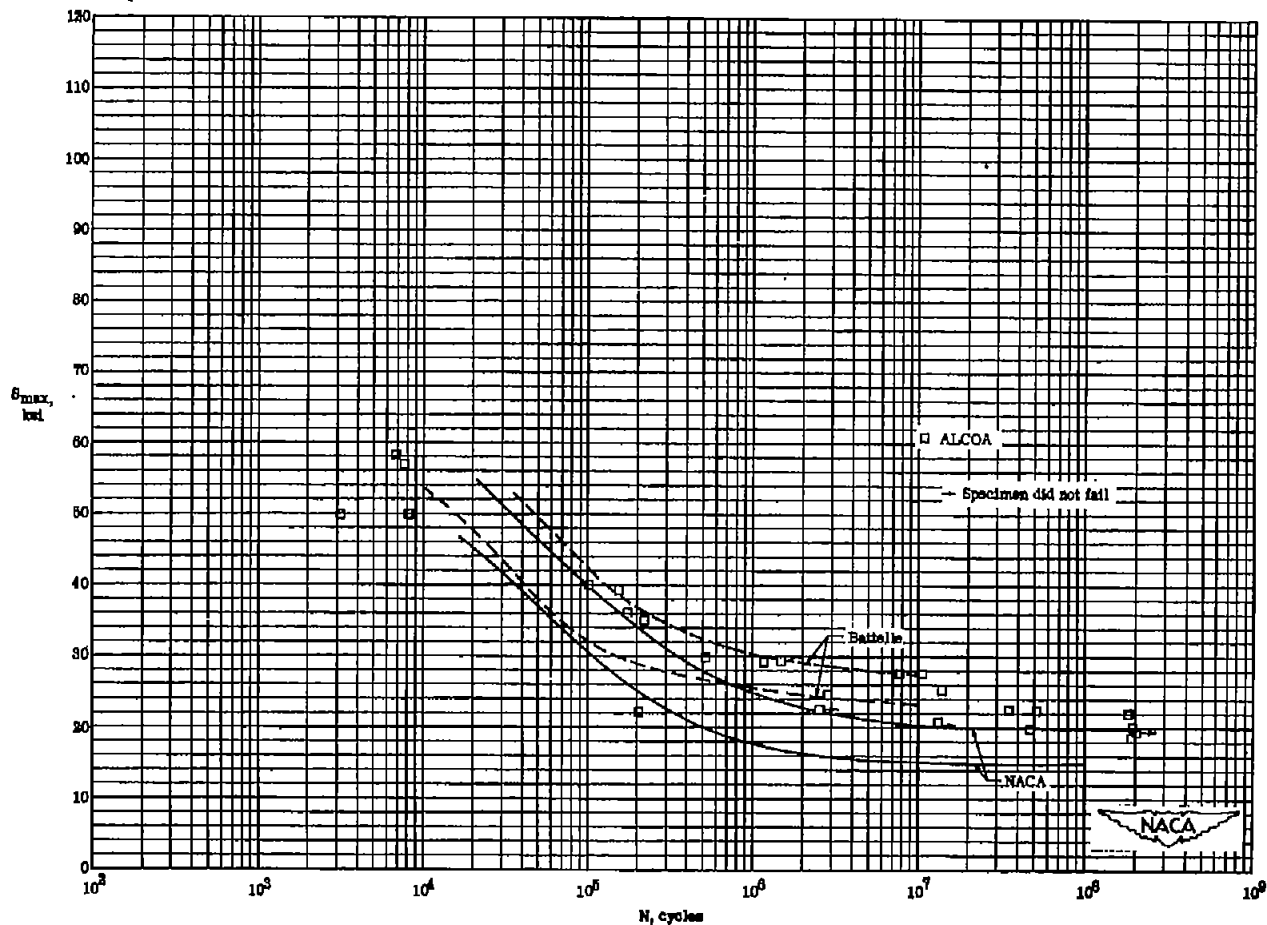

(a) $R = -1.00$.

Figure 24.- Comparison of results of fatigue tests at various stress ratios on unnotched 75S-T6 aluminum-alloy sheet specimens tested by Battelle and NACA and on unnotched 75S-T6 aluminum-alloy rolled and drawn rod specimens tested by ALCOA.

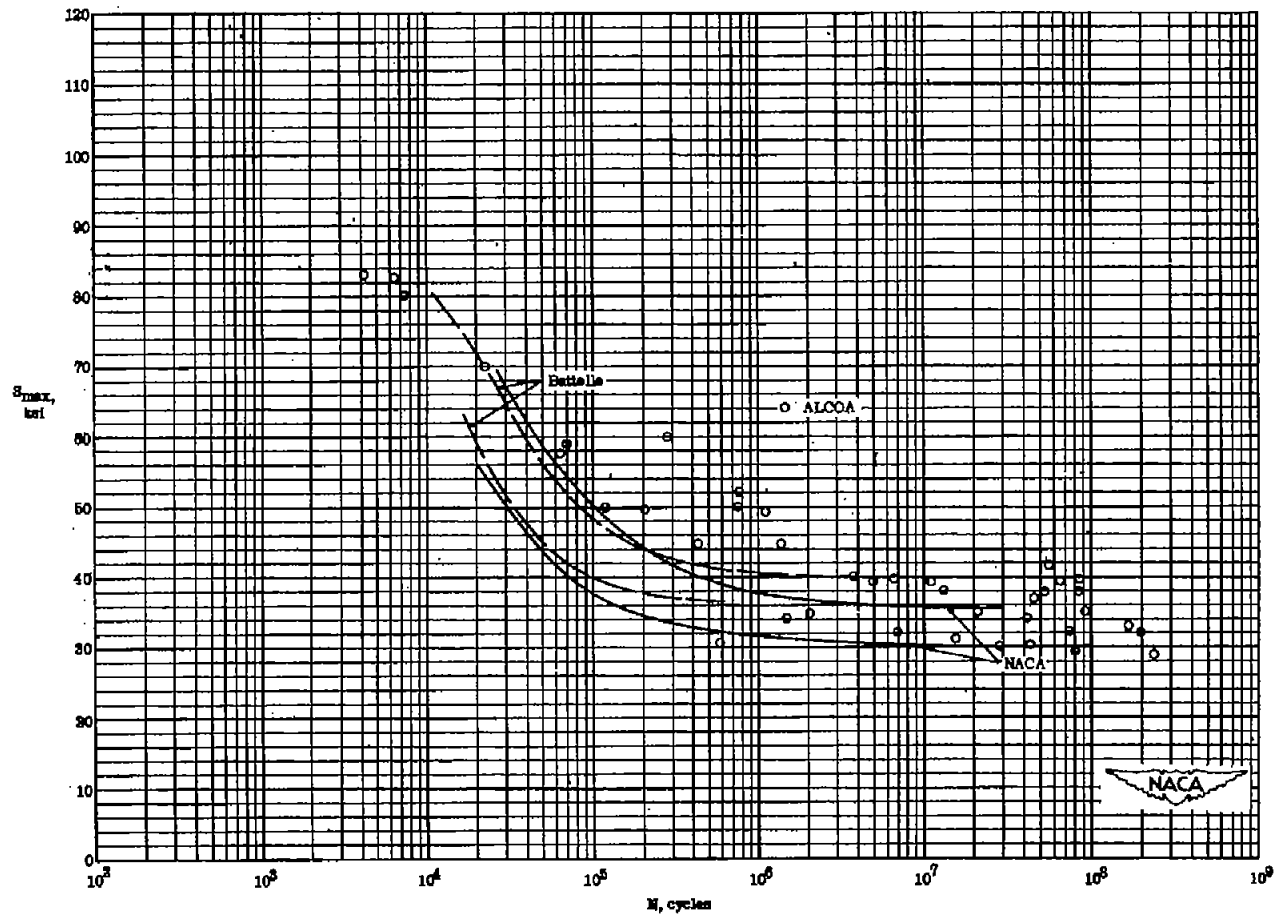

(b) $R = 0$.

Figure 24.- Concluded.

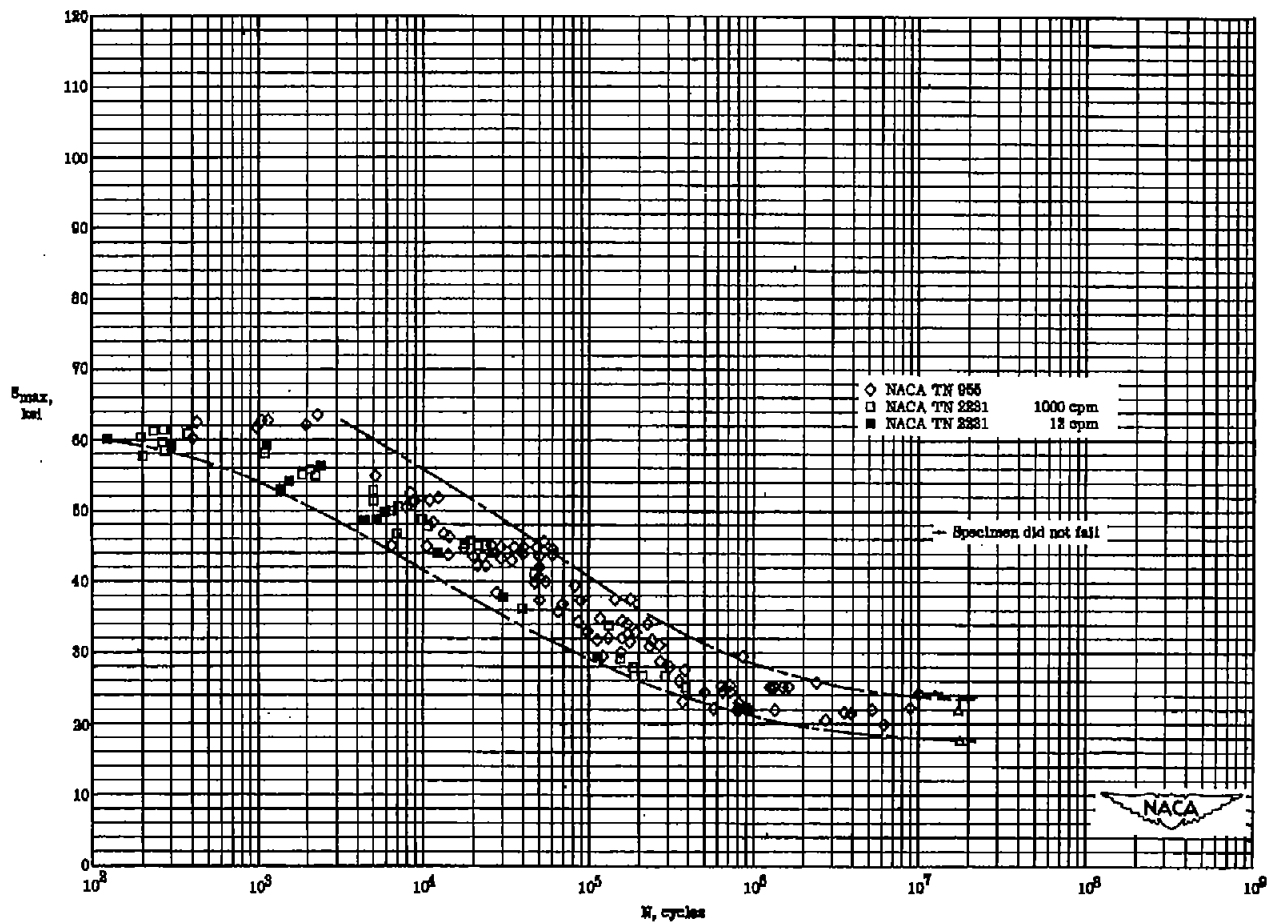

(a) References 10 and 11.

Figure 25.- Results of fatigue tests at $R = -1.00$ on unnotched 24S-T3 aluminum-alloy sheet specimens tested by NBS.

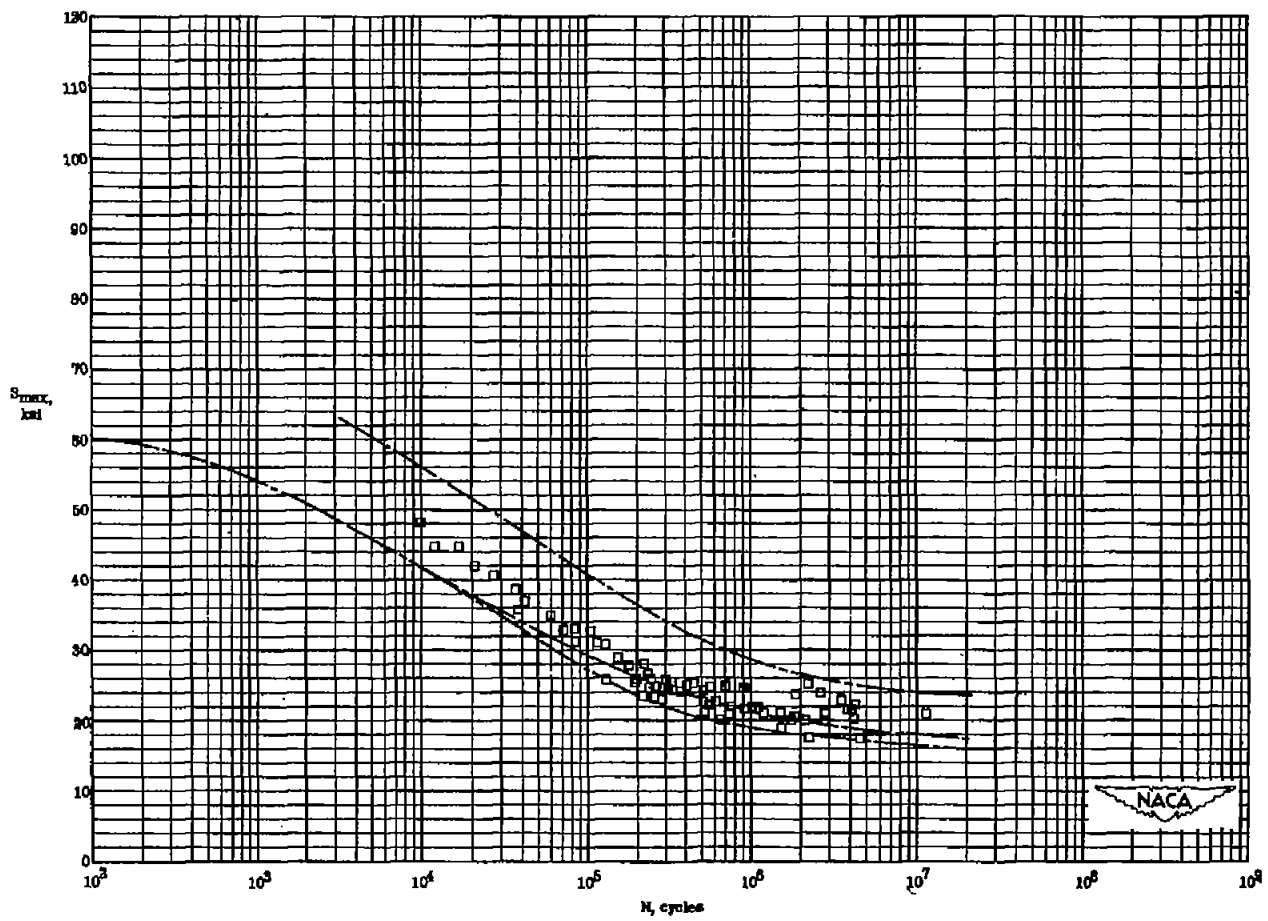

(b) Reference 12.

Figure 25.- Concluded.

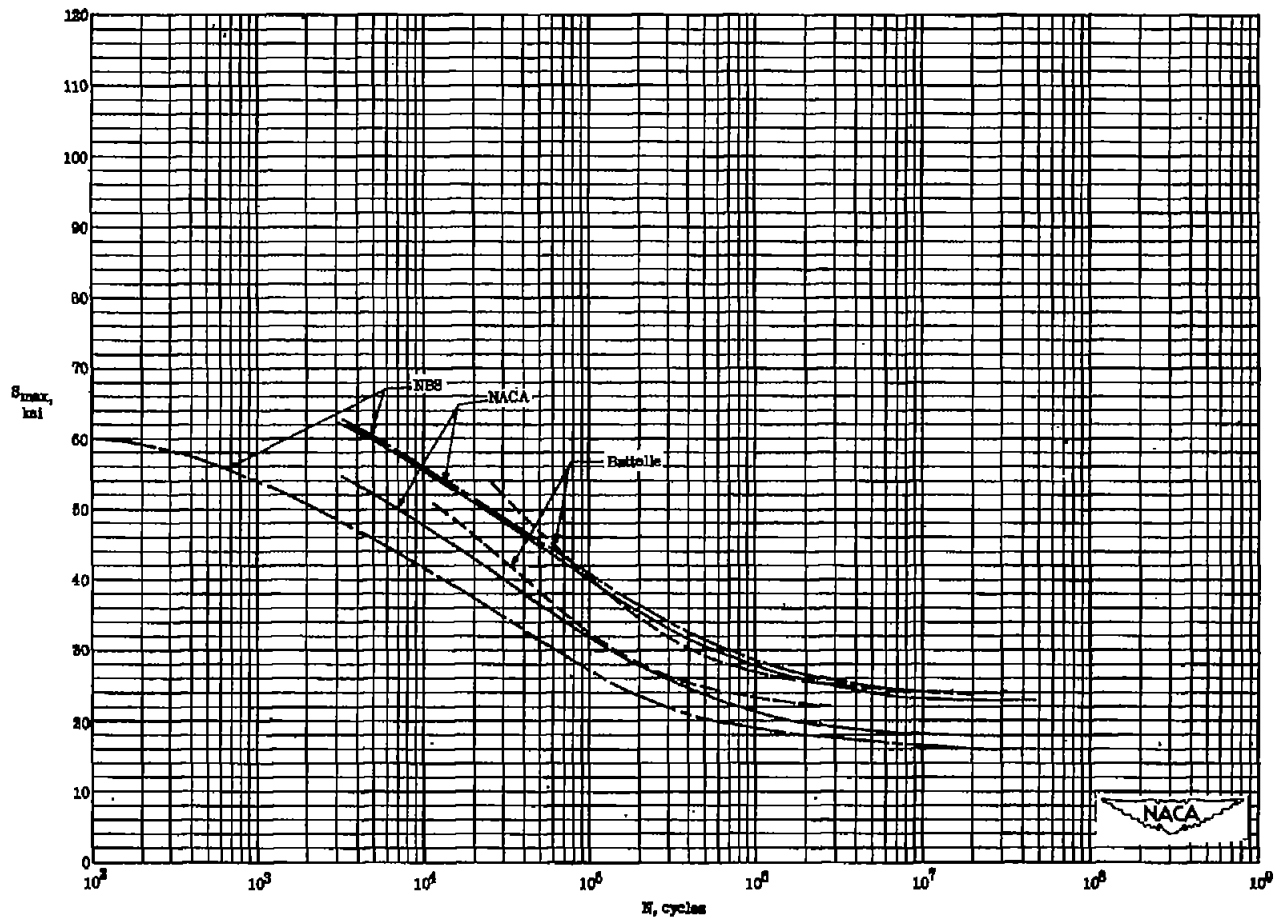

Figure 26.- Comparison of results of fatigue tests at $R = -1.00$ on unnotched 24S-T3 aluminum-alloy sheet specimens tested by Battelle, NACA, and NBS.

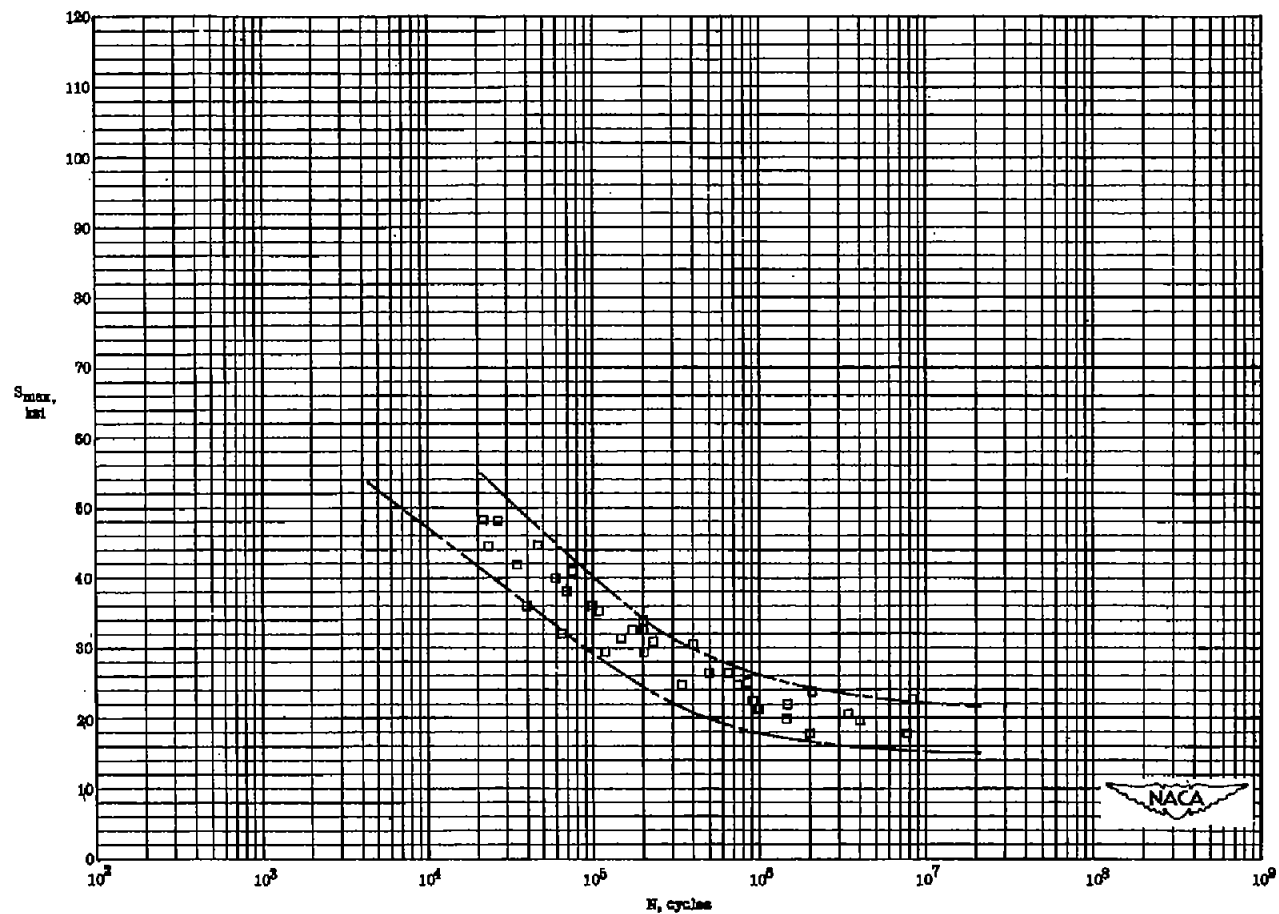

Figure 27.- Results of fatigue tests at $R = -1.00$ on unnotched 75S-T6 aluminum-alloy sheet specimens tested by NBS (data from ref. 12).

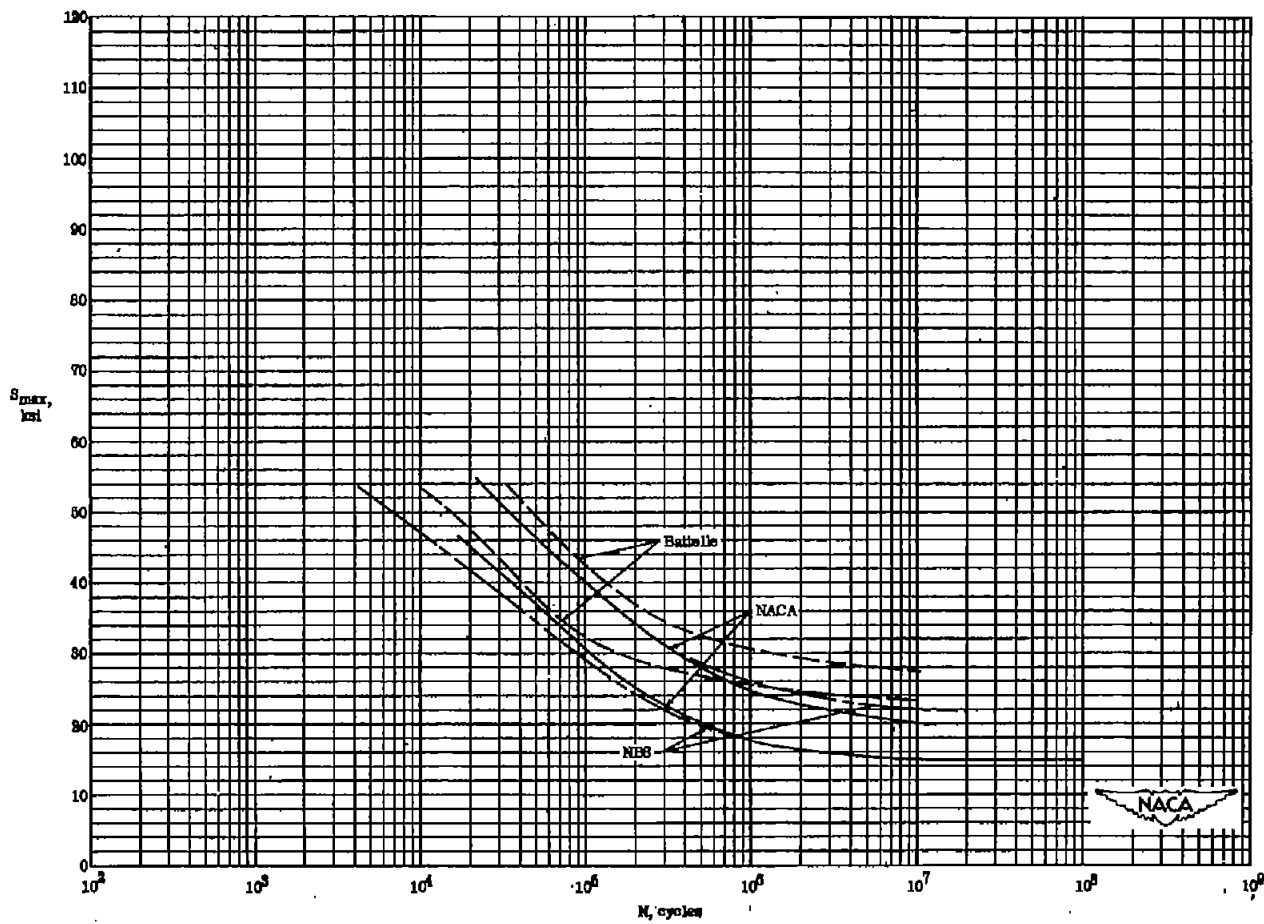

Figure 28.- Comparison of results of fatigue tests at $R = -1.00$ on unnotched 75S-T6 aluminum-alloy sheet specimens tested by Battelle, NACA, and NBS.