

NATIONAL ADVISORY COMMITTEE
FOR AERONAUTICS

MAILED
APR 21 1931

TO:

Greedy, L. M. A. L.

TECHNICAL NOTES

NATIONAL ADVISORY COMMITTEE FOR AERONAUTICS

No. 372

DEVELOPMENT OF AN IMPINGING-JET FUEL-INJECTION VALVE NOZZLE

By J. A. Spanogle and G. T. Hemmeter
Langley Memorial Aeronautical Laboratory

FILE COPY

To be returned to
the files of the Langley
Memorial Aeronautical
Laboratory.

Washington
April, 1931



3 1176 01431 9561

NATIONAL ADVISORY COMMITTEE FOR AERONAUTICS

TECHNICAL NOTE NO. 372

DEVELOPMENT OF AN IMPINGING-JET FUEL-INJECTION VALVE NOZZLE

By J. A. Spanogle and G. T. Hemmeter

Summary

During an investigation to determine the possibilities and limitations of a two-stroke-cycle engine with fuel injection and spark ignition, it was necessary to develop a fuel-injection valve nozzle to produce a disk-shaped, well-dispersed spray. Preliminary tests showed that two smooth jets impinging upon each other at an angle of 74 degrees gave a spray with the desired characteristics. Nozzles were built on this basis and, when used in fuel-injection valves, produced a spray that fulfilled the original requirements. The spray is so well dispersed that it can be carried along with an air stream of comparatively low velocity or entrained with the fuel jet from a round-hole orifice. This characteristic of the spray from an impinging-jet nozzle limits its application to situations where wide dispersion is required by the conditions in the engine cylinder and the combustion chamber.

Introduction

The staff of the National Advisory Committee for Aeronautics at the Langley Memorial Aeronautical Laboratory has undertaken the investigation of the possibilities and limitations of the

two-stroke-cycle high-speed fuel-injection engine as a means for increasing the power per unit of displacement obtainable from an engine suited to aircraft use. For this investigation it was desirable to have an engine capable of covering a wide range of experimental conditions. This requirement made the design of the fuel-injection valve and nozzle, as well as other accessory parts for this engine, a rather difficult problem.

The cylinder for this engine had been decided upon before the design of the fuel-injection valve was started and had four holes that could be used for the fuel-injection valve or valves. These holes were in pairs diametrically opposed; one hole of the first pair in either side of the combustion chamber and the other pair similarly arranged in the cylinder wall just above the air-admission ports so that the fuel could be injected into the air stream as it entered the cylinder. As this air flow could be controlled to be either radial or tangential to the cylinder, the spray had to be nearly circular in shape, perpendicular to the axis of the cylinder, and, at the same time, well dispersed. For the radial flow with injection into the combustion chamber, the residual air flow is negligible and the movement of the oil must be depended upon for proper distribution. For tangential flow the residual velocity in the combustion chamber is low and therefore the spray must be well dispersed to obtain proper distribution. For either type of air flow, with injection through the lower cylinder wall holes, the spray must be well dispersed

to follow this air flow and produce a proper mixture of fuel and air (internal carburetion).

The dispersion requirement seemed most important and impinging jets offered the simplest means of obtaining this dispersion. A preliminary test apparatus was assembled to determine the requirements of a fuel-injection valve nozzle built on the impinging-jet principle.

Preliminary Nozzle Investigation

The apparatus shown in the photograph (Fig. 1) was used to determine experimentally the factors affecting the physical characteristics of the spray from impinging jets. Two nozzles were mounted in an adjustable holder which made it possible to vary the angle of impingement and the distance between the nozzles as well as to adjust the axes of the jets to cross exactly. These nozzles were supplied with filtered liquid through a regulating valve by which the discharge pressure could be controlled. The flow paths to the nozzle were kept as nearly similar as possible. Water was used as the fluid in the preliminary tests and could be supplied either directly from the Laboratory mains at pressures up to 60 pounds per square inch or obtained from a high-pressure reservoir which allowed continuous operation of the jets for approximately 3 minutes. The pressure in this reservoir was obtained by means of an air bottle.

The first nozzle tested (a and b in Fig. 2) had straight, long, round-hole orifices which did not give sufficiently smooth jets and which, in spite of care taken in their manufacture, did not give similar jets. The test with these nozzles indicated that it was very necessary to have the jets of the same size at the point of impingement or one jet would pass through the other without either forming a disk or dispersing the jets.

To obtain smooth, stable flow from the nozzles it was decided to make new nozzles with a converging entrance, a short cylindrical portion, and a rounded exit as shown in Figure 2c. The angle of the converging entrance is $23\text{-}1/2$ degrees merely because that shape reamer was available. The length and the diameter of the cylindrical portion are equal. Although the rounded edge is necessary at the exit its radius is known to be relatively unimportant. These nozzles gave jets which were entirely satisfactory as to size, type of flow, and directional stability over the entire range of pressures used.

Adjustment of the nozzle for proper impingement was accomplished by first aligning the jets at low fluid pressures. If the liquid disk formed at the point of impingement of the two solid jets was perpendicular to the plane determined by the axes of the nozzles, the impingement would be satisfactory at higher pressures and result in a well-dispersed spray. The nearer the nozzles were to each other the easier it was to obtain this adjustment.

It was found that the angles between 72 degrees and 76 degrees gave a spray pattern which was so nearly circular that an angle of 74 degrees between the orifice axes was adopted as the most desirable. Satisfactory atomization and dispersion were obtained at pressures above 150 pounds per square inch. With the same orifices acting singly (nonimpingement) and with otherwise identical injection conditions, no atomization and little dispersion were observed at these low pressures.

After the tests with water, the nozzle apparatus was connected to a fuel-injection pump and Diesel oil was used to see if there was any change in the characteristics of the spray. As no change was observed the nozzle was designed on this basis. During these tests the spray was lighted and it continued to burn with injections into the atmosphere at the rate of 750 per minute. The flame was a brilliant yellow with but little smoke.

As a result of these investigations a nozzle was designed as shown in Figure 2d. This nozzle had two orifices which were similar in section to those used in the preliminary tests and were inclined at an angle of 74 degrees to each other. The point of impingement was kept as close as practicable to the nozzle exit so that more exact impingement might be obtained, and this also decreased the probability of the solid jets breaking up before impingement. The latter feature was found to be very necessary, because if the jets broke up before impingement, one spray would pierce the other without giving the desired atomization and dispersion.

Valve Design

After determining the design of the nozzle (Fig. 2d) it was necessary to design a suitable valve as shown in Figure 3. This valve has a large flat seat to reduce the stem movement necessary for the rapid admission of the fuel, but has a disadvantage in that the path of the oil after passing the seat changes direction too often. This valve has given satisfactory mechanical operation with the exception of a slight dribbling after cut-off; some erosion of the seat occurred which was normal and to be expected.

To reduce the volume of oil between the seat and the outlet to the nozzle and also to eliminate one change of direction of the oil path, another valve (Fig. 4) was designed with a hollow stem. This valve has also given satisfactory mechanical operation with less dribble, although it, too, is subject to erosion of the seats.

A third valve was built (Fig. 5) which was simpler to construct, because of the substitution of a spring-loaded poppet valve for the lapped stem.

This design was intended for use in internal-carburetion work where sharpness of start and cut-off is not nearly so important as when the injection is directly into the combustion chamber.

The dribble after cut-off may be due to the comparatively large volume of oil between the valve and the orifice exits.

Further design will be necessary to effect a reduction in this volume and thus diminish dribbling. At present the work is directed toward maximum power rather than toward fuel economy so that this dribble is relatively unimportant.

Test Results

Visual observation, when injecting into the atmosphere, and spray photographs taken with the N.A.C.A. spray photographic apparatus indicate that the spray is finely atomized and well dispersed. The spray photographs (Figs. 6a and 6b) show a more uniform dispersion than has been obtained with a multiple-jet nozzle having numerous small orifices. The uniform density of the photographed spray is a fine indication of good dispersion. The spray penetration curves of Figure 7 show the spray to be of comparatively low velocity and to be considerably affected by changes in chamber pressure. As these curves are developed from the extreme outer portion of the spray pattern they show that the spray should approximately fit the combustion chamber of the cylinder (4-5/8-inch bore) for which it was designed and that the additional penetration under lower air pressures when injecting into the air stream will be taken up by the travel of the spray with the air stream, thereby reducing the probability of washing the cylinder walls with fuel and impairing the lubrication.

Coefficient-of-discharge tests of the impinging-jet nozzle show that the shape of the flow passages allows this nozzle to have a higher coefficient of discharge than other nozzles designed to give an equal degree of dispersion. The energy imparted to the oil by the pump is conserved and not dissipated in friction.

A combination nozzle for the N.A.C.A. No. 4 cylinder head was designed so that two main sprays would provide for the air in the throat and the clearance of the cylinder head, and two impinging jets were provided to give the spray distribution between the valve heads (Fig. 8). The space limitation of the nozzle made it necessary for the four orifices to be located close together. The spray for the impinging jets was so well dispersed that it was entrained with the spray from the main jets and carried along with it as shown in Figures 9a and 9b.

Although the spray from the impinging-jet nozzle was not suited for the combustion chamber of any other test engine now being tested at the N.A.C.A. Laboratory, an indication of the distribution and mixing of the combustion air was obtained by running some of these engines with this nozzle. As expected, the result was a much higher rate of pressure rise than that with nozzles having round-hole orifices.

Conclusions

Although only a few of these nozzles have been built, there has been no difficulty in making them within the necessary tolerance to insure proper impingement. The formation of the liquid disk at the proper angle under low pressures as noted with the preliminary apparatus is a sufficient indication that the operation of a nozzle of this type will be satisfactory. The impinging-jet nozzle is simpler to construct and has a higher coefficient of discharge than any other means used at this laboratory for obtaining comparable dispersion.

The impinging-jet nozzle gives an apparently well-atomized spray with good dispersion over the entire spray pattern. This spray has a low velocity and, therefore, a small total penetration, but its wide dispersion allows it to be carried along with air flowing at comparatively low velocities. This spray should not be used unless other conditions in the cylinder and combustion chamber are conducive to its proper utilization.

Langley Memorial Aeronautical Laboratory,
National Advisory Committee for Aeronautics,
Langley Field, Va., March 30, 1931.

N.A.C.A. Technical Note No. 372

Fig. 1

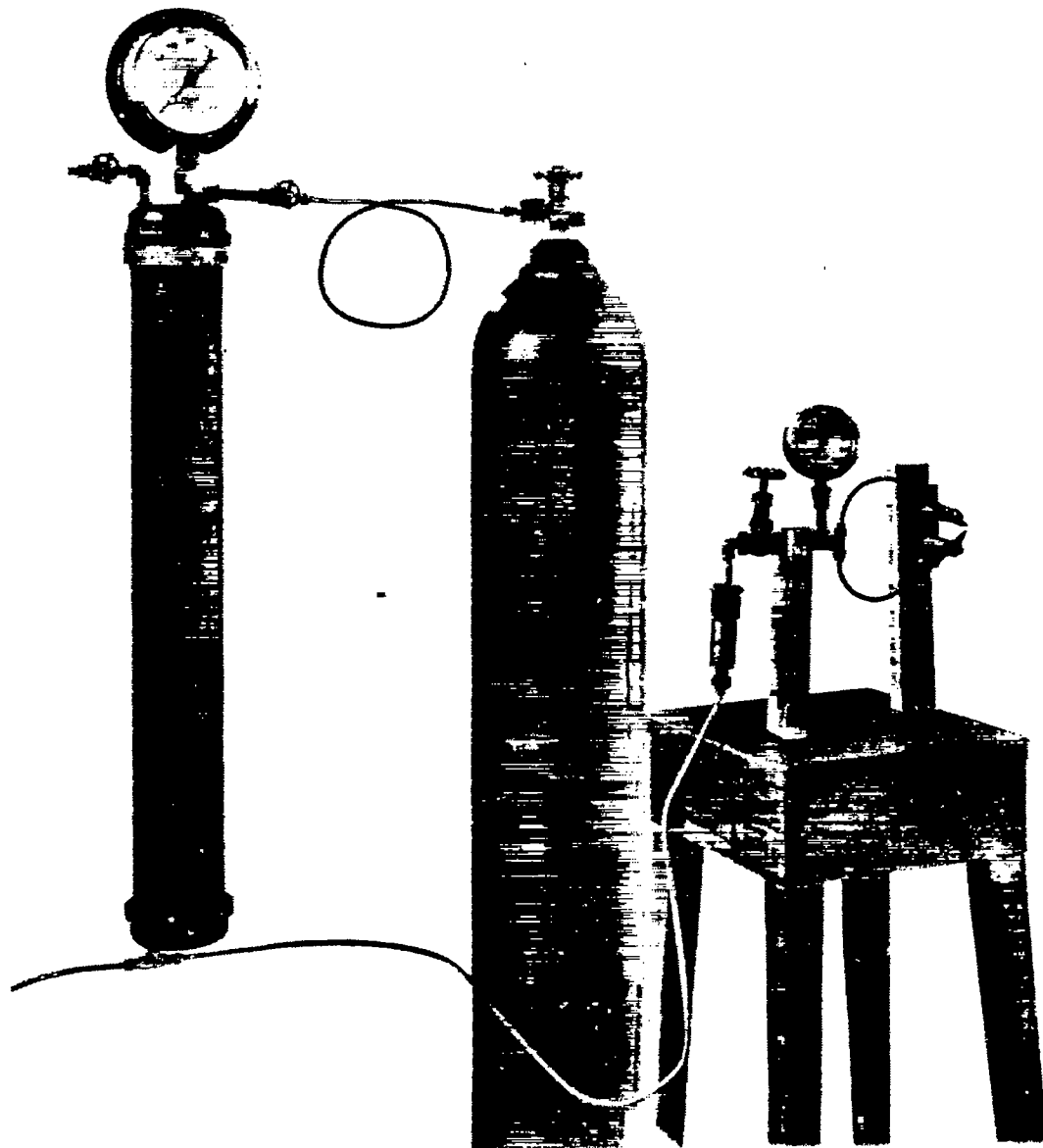
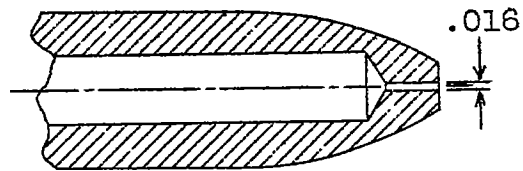
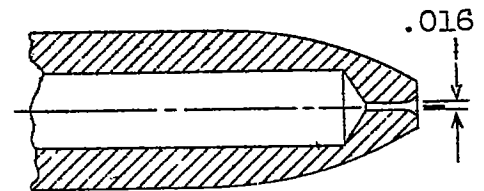

FIG. 1

APPARATUS FOR PRELIMINARY INVESTIGATION OF IMPINGING-JETS



a-Straight round hole orifice



b-Exit edge rounded.

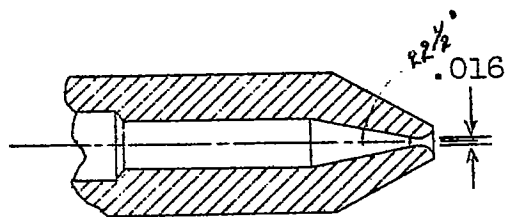

c-Tapered orifice.

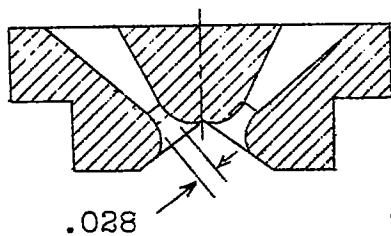

d-Impinging-jet nozzle.

Scale: full size

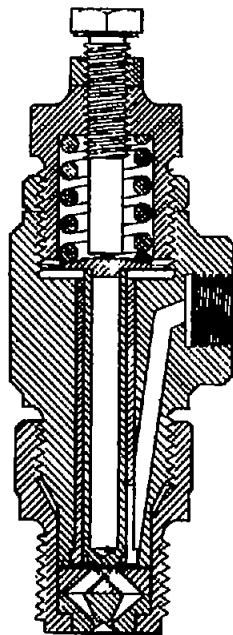

Fig. 3

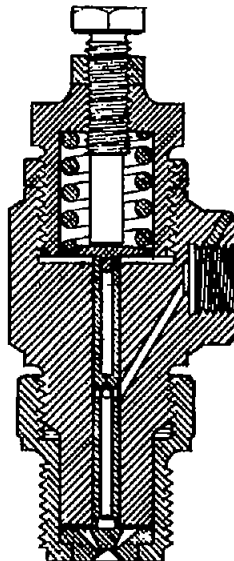

Fig. 4

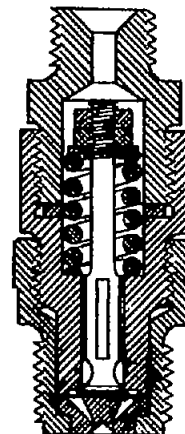

Fig. 5

Injection valves used with impinging-jet nozzles.



Fig. 6a View across spray. Injection pressure: 1500 pounds per square inch.
Chamber pressure: 200 pounds per square inch.



Fig. 6b View through spray. Injection pressure: 1500 pounds per square inch.
Chamber pressure: atmospheric.
Note: Edges obscured by side of spray chamber.

Fig. 6 Spray photographs with impinging-jet nozzle. Orifice diameter 0.038 inch.

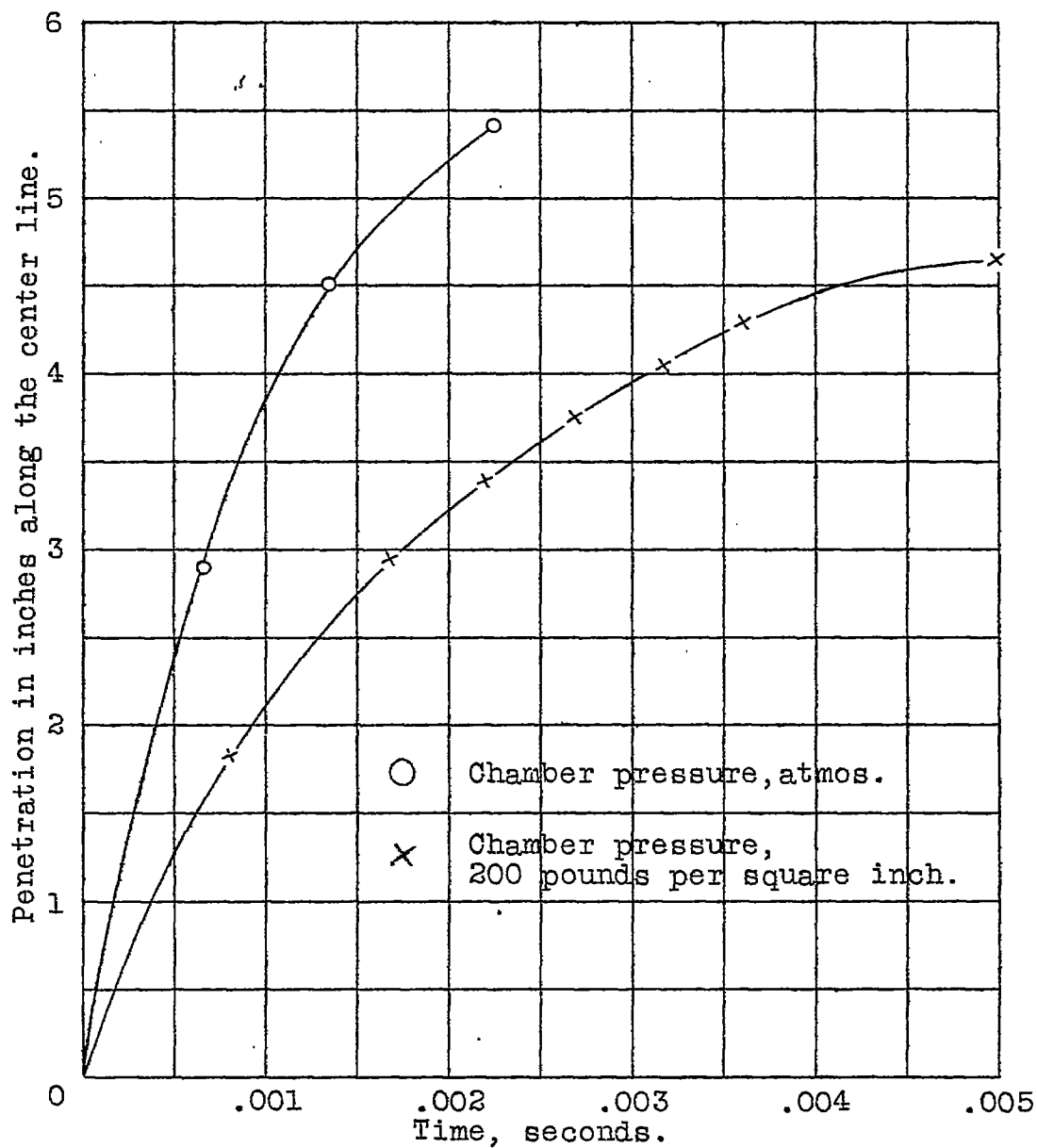
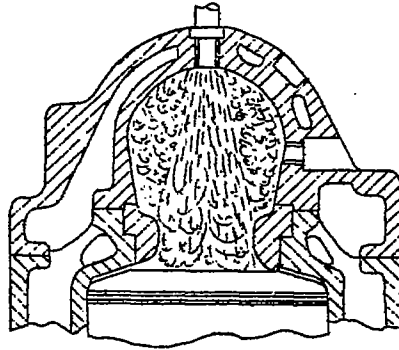
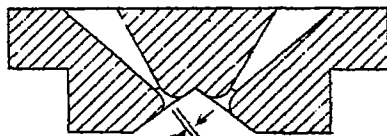
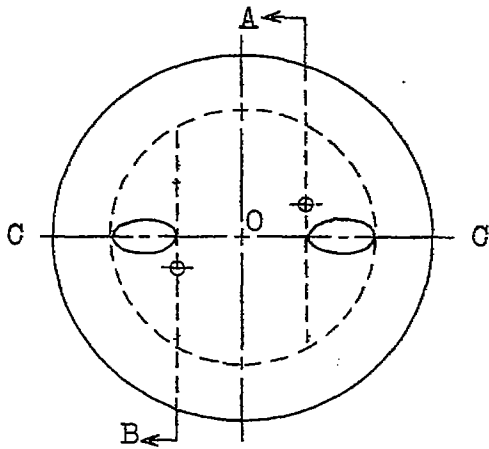

Fig. 7 Penetration of spray from impinging-jet nozzle.
Orifice diameter 0.028".



Combustion chamber of the N.A.C.A. cylinder head No. 4 showing predicted spray formation.



Section C-C

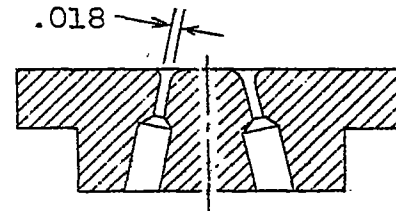

Section AOB

Fig. 8

Combination nozzle.



Fig. 9a View through spray. Injection pressure 3500 pounds per square inch.
Chamber pressure 200 pounds per square inch.



Fig. 9b View across spray. Injection pressure 3500 pounds per square inch.
Chamber pressure 200 pounds per square inch.

Fig. 9 Spray photographs with combination nozzle.