

NATIONAL ADVISORY COMMITTEE
FOR AERONAUTICS

MAILED
JUN 12 1931

TO: L. M. G. L.

THIS DOCUMENT PROVIDED BY THE ABBOTT AEROSPACE
TECHNICAL LIBRARY
WWW.ABBOTT.AEROSPACE.COM
JUN 15 1931

~~1070~~
~~1070~~

~~1070~~

TECHNICAL NOTES

NATIONAL ADVISORY COMMITTEE FOR AERONAUTICS

No. 381

ENDURANCE AND OTHER PROPERTIES AT LOW TEMPERATURES
OF SOME ALLOYS FOR AIRCRAFT USE

By H. W. Russell and W. A. Welcker, Jr.
Battelle Memorial Institute

FILE COPY

To be returned to
the files of the Langley
Memorial Aeronautical
Laboratory.

Washington
June, 1931



3 1176 01425 5518

NATIONAL ADVISORY COMMITTEE FOR AERONAUTICS

TECHNICAL NOTE NO. 381

ENDURANCE AND OTHER PROPERTIES AT LOW TEMPERATURES
OF SOME ALLOYS FOR AIRCRAFT USE

By H. W. Russell and W. A. Welcker, Jr.

Abstract

The low temperature endurance properties of materials for aircraft construction are not well known. In order to determine them, apparatus for testing endurance at -40°C has been devised.

The endurance properties of monel metal, low-carbon stainless steel, "18 and 8," $3\frac{1}{2}\%$ Ni steel, and chromium-molybdenum steel have been determined at -40°C and at room temperature (about 20°C). Tensile, impact and hardness tests of these materials have also been made at various temperatures.

The results show an increase in endurance limit, tensile strength, and hardness with decreased temperature. Impact strength is, in general, decreased, but of all the alloys tested, only one, low-carbon stainless steel, gives less than 15 ft. lb. Charpy impact test at -40°C .

Purpose of tests. - The metals subcommittee of the National Advisory Committee for Aeronautics had observed various failures in airplane streamline wire which were obviously due to corrosion-fatigue. The fractures started at corroded spots as nuclei, these spots sometimes developing beneath the paint and giving no visible sign of existence. An obvious way of combating corrosion-fatigue is the use of corrosion-resistant alloys. Several corrosion-resistant alloys can be had with mechanical properties similar, as shown by the usual tests, to those of the carbon steel streamline wire, but a question arose as to whether their low-temperature properties were such that they would withstand the temperature likely to be met in aircraft service. As very little information was found in the literature, it appeared desirable to make direct tests of low temperature endurance properties, and to supplement these with low temperature tests of tensile strength, impact resistance, and hardness.

Choice of temperature.- According to Nature, (page 590, October 11, 1930,) the lowest temperature of the upper air recorded in England was found to be -98°F . (-72°C) at an altitude of 7.8 miles (12.5 km), while the lowest recorded temperature of -133°F . (-92°C) was found 10.6 miles (17 km) above Batavia, Java.

The average temperature throughout the year at various altitudes above latitude 40° in the United States as given by W. R. Gregg* are as follows:

20,000 ft.	- 5.0°F .	- 20.6°C
30,000 ft.	- 40.5°F .	- 40.3°C
45,000 ft. and above	- 67.0°F .	- 55.0°C

At the higher altitudes there is little change between summer and winter temperatures, but at 25,000 feet a common winter temperature is -40°C .

To insure a readily detectable effect of temperature the lowest temperature which can be secured with reasonable convenience should be used. The temperature chosen, -40°C , is in the region of the lowest natural temperature likely to be encountered.

Materials.- The corrosion-resistant materials selected for test were monel metal, low-carbon stainless steel, and "18 and 8" austenitic stainless steel. At the suggestion of aircraft engineers a nickel steel and a chromium-molybdenum steel were included in the tests.

The analyses of the materials are given in Table I as determined by Dr. M. Benoy of this laboratory. These analyses agreed well with those furnished by the makers.

These materials were tested in the condition shown in Table II. For streamline wire "18 and 8" would be used in the cold worked condition. Through the kindness of Mr. J. B. Johnson of Wright Field one-half inch diameter rod of cold worked "18 and 8" (6-CW) was secured. Johnson has determined the endurance properties of similar materials. The tensile and impact tests for the cold worked "18 and 8" were made on specimens smaller than standard.

*Gregg, W. R.: "Standard Atmosphere." N.A.C.A. Technical Report No. 147, 1922.

Preparation of Test Specimens

Endurance.- A satisfactory and inexpensive method of preparing test specimens for endurance testing is greatly needed. Various methods of preparation and two types of specimens were used in this work.

The standard specimen for the R. R. Moore endurance machine was first made on the lathe by the use of a template to secure the 9-3/4 inch longitudinal radius. A final smoothing was given in the lathe with emery cloth. Later it was found better to merely rough out on the lathe and then finish on the cylindrical grinder, set to give the required 9-3/4 inch radius.

The failure of some specimens at the fillet at the end of the 9-3/4 inch radius due to an incorrect radius at this fillet, led to the use of a modified design of specimen. This modification, suggested by Mr. H. J. French of the International Nickel Company, consisted in the use of a smaller radius of curvature which obviated the need of a fillet. This specimen is shown in Figure 1. This could be made on a lathe without the use of a template by rocking the tool post. Final grinding was not possible because the grinder would not accommodate the smaller radius. With a suitable grinder this is an excellent type of specimen, especially for materials too hard for the lathe.

All specimens received a final longitudinal polish. The specimens, held in suitable handles, were polished by hand against a disk about 8 inches in diameter for the 9-3/4 inch radius, but smaller for the 5 inch radius specimen. This was turned at about 100 r.p.m. in a drill press. The circumference bore a one-inch wide strip of Number 320 emery cloth. The specimen was polished longitudinally until no tool marks were visible. Then a similar disk bearing 000 French emery paper, backed with cloth, was used to secure the final polish. All polishing was done in a longitudinal direction and was continued until no circumferential scratches were visible under the microscope. Figure 2 is a photomicrograph of the polished surface.

The diameter of the minimum section was measured with a micrometer with spherical tips, measurement being made directly to 0.0001 of an inch. The readings on different diameters of a single specimen might vary by 0.0003 inch.

Tensile specimens.- Standard threaded tensile specimens 0.505 inch in diameter were used. The low temperature specimens had a longer threaded portion to increase the distance from the

grips to the breaking section and to accommodate the cooling bath. Test specimens of annealed "18 and 8" for low temperature tests had a diameter of 0.400 inch. The cold worked "18 and 8" specimens were 0.270 inch in diameter.

Hardness specimens.- The hardness specimens were machined to a square cross section and finished by grinding. They were about three inches long so that a number of readings could be made from each one.

Impact specimens.- The small Charpy impact test specimen was used. The drilled or "Keyhole" notch was used. The specimen is shown in Figure 3. Specimens of cold worked "18 and 8" were the same except that the .160 inch dimension above the notch was reduced to .070 inch.

Testing Equipment and Procedure

Endurance.- All endurance testing was done on R. R. Moore endurance machines, which give rotary bending at about 1800 cycles a minute. All weights and significant dimensions were checked. The calculated stress at the minimum section should be correct to within an error of less than one per cent. In nearly all cases fracture occurred within one-eighth inch of the minimum section so that the stress at the breaking section may differ by about one per cent from the calculated value in a few cases. As far as possible all specimens were run continuously until fractured. The load was carefully applied after the machine was started and was removed when the run was interrupted.

The cooling chamber for the low temperature tests underwent slight modification as the work proceeded. These changes were made to secure better insulation and a more reliable circulation of the air. There is no reason to believe that the early data are in any way less reliable than those secured later. In the present form the cooling chamber will operate for a long time in hot and humid atmosphere with but little attention.

The cooling chamber is shown in Figure 4. A wooden box fits over the endurance machine between the driving motor H and the revolution counter F and rests on a board passing under the base of the machine. Slots at the motor and counter ends permit the entire box to be removed for changing specimens. A door G at the top provides access to the inside of the chamber for inspection and for adding the refrigerant. The inside of the box is lined with two inches of cork-board sealed with asphalt. This provides an insulation not readily affected by moisture. A pad of hair-felt, cut and slotted to conform, covers the metal parts of the base inside the box.

The box is divided into an upper and a lower chamber by a movable wooden partition. In the upper chamber a movable wire basket B, raised by legs one-half inch long, provides a receptacle for the solid carbon dioxide which is used as a cooling agent. At one end of the partition is a fan in a circular hole.

This fan is driven by a shaft from the motor FM mounted on the top of the box. At the other end of the partition is an opening controlled by a movable damper D.

Around the test specimen S and carried by the ends of the bearings of the endurance machine is a loose spiral of annealed copper wire. Around this is wrapped a layer of cotton wool L forming an inner chamber C of about two inches in diameter. Into this chamber the thermocouple is placed just above the specimen. The thermocouple wires pass horizontally to the outside of the box and to a vacuum bottle containing ice fastened to the box. The wires inside the box are wrapped with cotton wool to reduce the effects of thermal conductivity.

Figure 5 shows the wiring diagram of the temperature controlling mechanism. The iron-constantan thermocouple in the inner chamber has its "cold" or reference junction in melting ice. From binding posts at this junction, copper wires lead to a Leeds and Northrup potentiometer-recorder controller calibrated in millivolts and without "cold" junction compensation. This provides a convenient and permanent record of the chamber's inner temperature. A potentiometer indicator provides for occasional checks and more precise readings of the temperature. The thermocouple was calibrated at the mercury melting point and the CO_2 sublimation point. On closing switch S_1 the fan is set into operation cooling the lower chamber. Switch S_2 starts the motor of the recorder controller. When the temperature of the inner chamber becomes lower than -40°C the "high" contact of the controller is opened, extinguishing lamp W.L. and opening the relay. A condenser C around the relay is necessary to prevent burning the controller contacts. The opening of the relay stops the fan permitting the chamber to warm up. If for any reason the chamber becomes much too warm, about -30°C , the low contact is closed, lighting a red lamp which warns the operator.

Lubrication.— As the bearings of the endurance machine are cooled to -40°C a special oil is necessary for their proper lubrication. As no special oil recommended for use could be found, it was necessary to select and prepare such an oil. The viscosity of various oils and mixtures of oils was measured at -40°C . The viscosity was measured by the rate of flow through a vertical capillary tube which was surrounded by a circulated

bath of acetone cooled with solid CO_2 . A 50-50 mixture of light transformer oil (Standard-Indiana-#4088 Transformer Oil) and paraffine-free kerosene (Standard-Ohio Rayolite) was found to have suitable viscosity. This oil has proved satisfactory in the low temperature endurance machine. Later it was found that kerosene alone served better, giving less heating in the bearings.

Operation. - With the sample in position in the endurance machine, the basket was filled with CO_2 and the fan set running, until the temperature of the inner chamber was that for which the controller was set: a temperature of about -38°C . The motor of the endurance machine was then started and the load carefully applied. At intervals of from one to two hours more solid CO_2 was added. The machine was kept in operation continuously, the watchman adding CO_2 as needed at night.

The box was opened from the top daily to inspect the oil level in the bearing, to lubricate the lower fan bearing, and to remove such frost as prevented the ready circulation of air. At these times the run was continued, the temperature of the sample increasing to about -30°C for a short time.

A special temperature study of the temperatures at various places within the chamber was made. In addition to the couple on the controller, nine other couples were distributed about the sample as shown in Figure 4. Couple 9 was in the inner specimen chamber and could be pulled into contact with the sample.

The specimen was of "18 and 8" which shows a large internal heating effect. (See page 9 for discussion of internal heating.) The bearing containing couple 1 was not in as good condition as for the most of the endurance tests.

The results of an extensive series of measurements showed the controlling thermocouple to vary by about 1°C on either side of -40°C , but the specimen temperature as measured by stopping the specimen and pulling couple 9 into contact was about -35°C . Thus 5°C is the maximum departure from -40°C which might be expected during a run except in the case of highly loaded samples of "18 and 8." Samples of other materials should have been much nearer -40°C throughout the run.

Bearing 2 ran at a temperature slightly below -40°C . Bearing 1, which was in poor condition, ran at about -28°C . Couples 3 and 4 in the air stream showed about -55°C , but varied considerably as the fan started and stopped. Couple 5 outside the specimen chamber showed about -46°C but varied also.

Couple 6 on the chamber wall showed less than -50°C showing no great heat loss here, but couple 7 on the metal support stood at about -22°C and couple 8 at about -30°C showing large heat losses through the metal base.

Considering that these tests were made with a specimen of "18 and 8" and one bearing in bad shape, they indicate that the probable limits of temperature variations of a low temperature endurance specimen are -35° to -42°C . These are outer limits which are only exceeded for a short time when the chamber is opened for lubricating, at which time the temperature may rise to -30°C for a short time.

The variation of the room temperature specimens from a mean of $+20^{\circ}\text{C}$ is undoubtedly greater than this.

Cost of operation.- Endurance testing even at room temperature is relatively expensive. The cost of operating the cooling chamber will depend upon the weather and upon the material being tested. The actual amount of solid carbon dioxide placed into the chamber varies from 50 to 80 pounds per day, including loss in storage and transportation 80 to 120 pounds per day were purchased. In all nearly 24,000 pounds of solid carbon dioxide were purchased at an average cost, including transportation, of $7\text{-}3/4$ cents a pound.

Tensile tests.- The tensile tests were made with an Amsler Testing Machine. The load was applied quite slowly. Stress-strain diagrams made by the machine have been preserved.

For the low temperature tensile tests a metal container, shown in Figure 6, was held by nuts on the long threaded portion at the lower end of the specimen. This container was filled with acetone cooled to -40°C by solid carbon dioxide. A number 36 copper-constantan thermocouple was wrapped at the breaking section and held against the specimen by a rubber band. Carbon dioxide was added as needed during the test to hold the temperature constant. Only just before fracture, when heat was produced rapidly, did the temperature vary by as much as $\frac{1}{2}^{\circ}\text{C}$ from -40°C . A special test, during which no carbon dioxide was added, showed by the quite slow heating of the specimen that the loss of the heat to the grips of the machine was not excessive and that the measured temperature was that of the specimen.

Hardness tests.- Checks of the uniformity of the materials and of specimens for the endurance tests were made with the Rockwell Hardness Tester. However all tests in the study

of the effect of temperature on hardness were made by the Brinell method with 3000 kg load on a 10 mm ball.

Temperature control was secured by placing the test specimen in a bath (see figure 7). An insulated metal container had, as part of its bottom, a special anvil fitting over the regular anvil of the machine. This was filled with acetone to several inches above the surface of the specimen. A rigid extension for the ball carrier permitted the ball to enter well into the bath. The temperature of the specimen was determined by a 36 gauge copper-constantan thermocouple resting in a saw-cut at the end of the specimen. In part of the work couples were placed in the anvil and in the ball carrier above the ball. Readings of these couples agreed with the specimen temperature to within 1°C.

The most satisfactory way of conducting the test was to start with the bath at about room temperature. A test was made near the end of the bar, then the bar was moved along, the bath was cooled to the next lower temperature desired and another test was made. This was continued until two faces of the bar were tested.

Impact tests.- Impact tests were made on an Anslar Impact Machine. The calibration of the machine was checked and the direct reading scale found substantially correct. Tests were made with a height of fall which gave the hammer an energy of 82 foot pounds on striking. In the case of the "18 and 8" a somewhat greater energy was necessary.

Low temperature specimens were cooled in an acetone bath as shown in Figure 8. This bath consisted of a shallow, wide-mouthed pyrex vacuum flask. The specimens were supported on a platform of wire screen. The temperature was measured by a thermocouple in the notch of a dummy specimen. When a specimen had been held at the desired temperature for some time, it was removed with wooden tongs and broken in a measured five seconds. Tests with the dummy specimen showed no appreciable temperature change in this interval of five seconds.

Discussion of results.- The results of the tests are shown in Tables III to VI and Figures 10 to 20. In the endurance curves where "scatter" makes the results uncertain a dashed line represents the trend of the S-N relation. Specimens which withstood a large number of cycles without fracture were retested at a higher stress. Dotted lines join the points representing these tests with raised stress. Information secured in this way is valuable in determining the endurance limit. If a specimen retested with a raised stress

breaks only after a greater number of cycles than a virgin specimen run at the same stress will withstand, it indicates that the specimen was strengthened by the lower stress and that this lower stress is below the endurance limit. If, however, the retested specimen proves weaker than a virgin specimen, or rather lies to the left of the stress cycle S-N curve as determined by virgin specimens, it indicates that the original stress was sufficient to damage the specimen and was greater than the endurance limit.

The "scatter" shown by the monel metal in the endurance tests is due in part to variations in the treatment of the material. In the "as received" condition the hardness of the specimens was not uniform, ranging from 165 to 222 Brinell. Successive anneals at about 1100°F. were given the specimen blanks to bring them to about 165 Brinell. The specimens as tested showed hardness from 155 to 185 Brinell. The scatter of the points on the S-N curve (figure 10) is not, however, wholly explained by variations in hardness for a grouping of the points according to the hardness of the individual specimen failed to reduce the scatter very much.

The annealed "18 and 8" showed an interesting phenomenon. A highly stressed specimen became heated by elastic hysteresis to a red heat and failed by bending. For stresses slightly above the endurance limit the specimen heated slowly at first, then rapidly to a temperature which caused oxidation. All fractures were irregular and unlike a "characteristic" fatigue fracture. Figure 9 shows the fracture and oxidation of the specimens.

Specimens of annealed "18 and 8" started at -40°C in the cold chamber likewise heated rapidly and when fractured were all found to have been oxidized. In one case the thermocouple in the inner chamber indicated a temperature of 118°C at fracture, the specimen must have been much hotter. Specimens which did not fail would first heat up to about -30°C and then settle down to a temperature slightly warmer than -40°C.

The effect of understressing was very marked on the annealed "18 and 8." The room temperature specimens showed considerable strengthening by understressing; the low temperature specimens were strengthened to a remarkable degree. One specimen originally stressed just under the endurance limit had its stress increased by steps of 1000 pounds per square inch after runs of 100,000 cycles or more. The stress was raised in this way a total of 20,000 pounds per square inch. When fracture finally occurred it was at a considerable distance from the reduced section where the strengthening was undoubtedly less.

There appear to be two factors influencing the endurance properties of "18 and 8" in the annealed condition. The heating due to elastic hysteresis has a tendency to lower the S-N curve while the strengthening by working tends to raise the curve. The number of cycles per second will determine the rate of production of heat and hence the temperature of the specimen. Thus if large changes were made in the frequency of revolution some change would be expected in the S-N relation for highly stressed specimens. Stress just above the endurance limit does not cause very rapid heating until fracture starts. Then, it is true, the temperature is rapidly raised. As the greater portion of the run is made at moderate temperature no great change in the endurance limit will be caused by changes in the frequency. When, due to raising of the elastic limit by working, the elastic hysteresis becomes less the rate of heating will be decreased so that it is possible that a specimen which at first heats may later run somewhat cooler. If the stress is now raised in small enough steps the material can be slowly strengthened. The strengthening so produced is largely in the surface layers thus being somewhat different from the strengthening produced by drawing or cold rolling, but as fatigue failure starts in the surface layers the S-N relation for such material should approach the S-N values for cold worked materials as indeed it does.

The low temperature endurance results for the cold worked "18 and 8" are shown in Figure 14a. Figure 14b shows the results obtained by J. B. Johnson on two similar materials. He found that these materials had the following properties:

Material	Analysis			Tensile strength lb./ sq.in.	Rockwell hardness	Endurance limit lb./sq.in.	Endur- ance ratio
	C.	Cr.	Ni				
1	.12	18.78	8.41	112,000	35.6	62,000 at 20°C 63,000 at -40°C	.55
2	.11	18.40	9.63	135,000	53.0	74,000 at 10°C	.54

Our material marked 5-CW was from the same lot as Johnson's material 2, but probably because of difference in cold working had mechanical properties more nearly those of material 1.

Johnson's low temperature endurance tests on material 1 were made in a room refrigerated to -40°C. The two points indicated by small squares in Figure 14b we secured on specimens prepared by Johnson of this material. They indicate a higher

endurance limit than Johnson found which may be due to lack of uniformity in the material or a higher specimen temperature in his tests.

Table III gives the endurance limit found for each material and the ratio of the endurance limit to the tensile strength. With the exception of the "18 and 8" the endurance ratio is the same at room temperature and -40°C .

The results of the tensile tests are shown in Table IV. The increase in tensile strength at -40°C is quite definite. No great significance can be attached to the values of elongation and reduction in area except to note that the changes with temperature are not large.

The results of the hardness tests are shown in Table V and Figures 18 and 19. After the tests were well under way it was found that the stainless steel (4H) was not in a uniform condition, hence the values given for it in all the tests are not as reliable as for the other materials. Hardness values are given for the two extreme conditions (4H-1 and 4H-2). The curves are drawn as straight lines, not because it is thought that the true relation is linear but to show most easily the trend of the hardness for decreasing temperature. All points except for the $3\frac{1}{2}\%$ Ni (I-T) are the average of tests on two separate bars of material. In all cases an increase in hardness with decreasing temperature is noted. With chromium molybdenum (9-T-I) the change is smallest, with "18 and 8" (6) it is largest.

The Charpy impact results are shown in Table VI and Figure 20. Here, because of the "scatter" of the results, no great significance should be attached to the shape of the curves. This "scatter" is undoubtedly inherent in the materials and the test and is not due to uncertainty of the temperature. The two values shown for the stainless steels (4 and 4H) at -40°C probably represent a real effect for no intermediate values were found. The presence of two impact values at certain temperatures has been noted by several previous workers and is discussed by Greaves and Jones.*

Recent work by Lt. Hugh E. Haven at the U. S. Navy Engineering Experiment Station** gives information which should be considered along with our results. Lt. Haven has made tor-

*Greaves and Jones, Jour. Iron and Steel Inst., Vol. 112, p. 154, 1925.

**Haven, Hugh E.: "Some Effects of Corrosion Fatigue on Stream-line Wire for Aircraft." To be presented at the Baltimore ASME Aeronautic Div. meeting, May 12-14, 1931.

sional corrosion fatigue tests using fresh carbonate water as the corrosion agent. The significant results are as follows:

	A	B	C					
Material	Tensile strength	Torsional endurance limit	Torsional corrosion fatigue limit	Elongation	Reduction of area	Endurance ratio	Ratio C/B	Composition like our material
all cold worked	lb./sq. in.	lb./sq.in.	lb./sq. in.	per cent	per cent	B/A		
Stainless 12% Cr "18 and 8"	145,900	36,500	18,000	8.2	36.2	.25	.49	4
Monel metal	188,200	27,500	12,000	6.5	46.9	.15	.44	6
Stainless 18% Cr	151,200	23,000*	11,000	7.5	39.3	.15	.48	2
Do-annealed	225,900	20,000**		7.8	41.7	.09**		
Carbon steel .48% C cadmium plated	111,600	35,000	27,500	50.3	63.6	.32	.79	
	161,300	29,000	7,500	7.7	40.8	.18	.26	

It will be noted that the annealed 18% Cr Stainless, while having the lowest tensile strength, has much the highest corrosion fatigue limit. The corrosion fatigue limit in the cold worked condition in which it would be used has not yet been determined.

The large variation in the endurance ratio is hard to understand though it may be due to the effects of cold working. The ratio of corrosion fatigue limit to endurance limit shows an interesting comparison.

Lt. Haven's results do not show "18 and 8" to have as high corrosion fatigue properties as the straight chromium stainless, though either one shows materially better results than the carbon steel. Since the low temperature impact figures for the two materials place them in the opposite order, it will be necessary to compare both these properties in a final choice of the materials.

*Value at 10 million cycles.

**The specimens were not polished but tested in the "as received" condition.

Conclusions

The results show that the materials tested have in the main better properties at -40°C than at room temperature. The materials containing iron as ferrite are, however, likely to become brittle. This is in line with what is known of metals and alloys in general but is here extended to include endurance properties.

Of the three materials tested with an eye to their suitability for streamline wire only the plain chromium stainless steel (4) shows any indication of poor low temperature impact properties that might bar it from such use. It might have been expected from data in the literature that the $3\frac{1}{2}\%$ Ni steel would not show marked low temperature brittleness. That the chromium-molybdenum steel so widely used in aircraft should also retain a large measure of toughness at low temperatures might perhaps have been expected from service results, but it is reassuring to find that the quantitative figures indicate so good a retention of toughness.

The endurance ratios (endurance limit; tensile strength) for the materials tested at room temperature and at -40°C remain surprisingly constant, only the "18 and 8" showing appreciable diminution in this ratio. The absolute values of endurance limit even for "18 and 8" increase considerably, but the tensile strength increases at a still greater rate. While sweeping conclusions for other alloys than those tested are not justified, it appears probable that in respect to pure endurance properties (no consideration being given to the influence of notch brittleness but merely taking into account the endurance properties of a polished and properly filleted test specimen,) one might generally expect better rather than poorer service from alloys at low temperatures. Low temperature endurance testing does not seem likely to be required as a routine matter. Low temperature impact properties should be, it appears, a matter of much greater concern.

Battelle Memorial Institute,
Columbus, Ohio, May 13, 1931.

TABLE I
 Analysis of Materials

Maker	Heat	Ref. No.	Material	C	Mn	P	S	Si	Cr	Ni	Ko
*INCO		2	Monel Metal	0.08	0.99			0.01		67.87	Cu- 28.85 Fe- 1.78
**B.S.C.	JX4382	4	Stainless Steel	0.07	0.20	.011	.025	0.15	13.85	0.08	
***C.A.S.C.	22367	6	"18 and 8"	0.09	0.39	.008	.020	0.59	17.51	9.24	
C.A.S.C.	7615	1	3 $\frac{1}{2}$ % Ni Steel	0.36	0.60	0.018	0.016	0.24	0.25	3.48	
B.S.C.	5J721	9	Chromium Molybdenum Steel	0.36	0.61	0.017	0.014	0.23	0.70	0.16	0.18

TABLE II
 Treatment of Materials

Mark	Material	Conditions
2	Monel Metal	As received - cold drawn.
4	Stainless Steel	As received - annealed.
4 H	Stainless Steel	20 min. 1850°F.-O.Q., 120 min. 1025°F.-Air, 90 min. 1035°F.-W.Q.
6	"18 and 8"	As received - annealed.
6 C W	"18 and 8"	As received - cold worked, 1/2 in. wire.
1-T	3 $\frac{1}{2}$ % Ni	60 min. 1475°F.-O.Q., 60 min. 1050°F.-cooled in air.
9-T-1	Chromium-molybdenum	60 min. 1600°F.-O.Q., 55 min. 1000°F.-cooled in air.
9-T-2	Chromium-molybdenum	30 min. 1600°F.-W.Q., 120 min. 800°F.-cooled in air.

*INCO - International Nickel Company.

**B.S.C. - Bethlehem Steel Company.

***C.A.S.C. - Central Alloy Steel Company (now Republic).

TABLE III

Material		Endurance limit lb./sq.in.		Endurance ratio	
		+20°C	-40°C	+20°C	-40°C
Monel Metal	(2)	36,000*	38,000*	.38	.37
Stainless Steel	(4)	39,000	44,000	.59	.59
Stainless Steel	(4H)	60,000	65,000	.49	.50
"18 and 8"	(6)	33,000	42,000	.38	.27
"18 and 8" cold worked	(6CW)	62,000**	75,000	.55**	.46
3 $\frac{1}{2}$ % Ni Steel	(1T)	61,000*	68,000	.48	.49
Chromium-molybdenum Steel	(9T1)	65,000	70,000	.52	.52
Chromium-molybdenum Steel	(9T2)	98,000	101,000	.51	.50

*Approximate values at 40 million cycles.

**Determined by Mr. J. B. Johnson at Wright Field on material 1.

TABLE IV

Tensile Tests

Material	Yield lb./sq.in.		Tensile strength lb./sq.in.		Elongation per cent % in 2 in.		Reduction of area per cent	
	r.t.	-40°C	r.t.	-40°C	r.t.	-40°C	r.t.	-40°C
2			93,300	102,900	33.0	37.5	71.7	71.4
4			66,000	75,400	40.2	45.0	75.8	72.9
4 H			123,000	130,000	22.5	25.2	65.9	65.8
6*			88,000	160,000	69.9	48.7	76.7	70.2
6 C W**	114,600	112,400	127,000	162,500	31.5**	42.7**	59.5	63.2
1 T			128,000	140,500	22.5	24.0	63.4	60.4
9 T 1	99,400	108,000	125,000	135,000	15.9	21.5	61.5	59.8
9 T 2	180,600	191,000	193,000	202,000	11.5	14.7	58.4	55.6

*0.400 in. diameter specimen.

**0.270 in. diameter specimen.

TABLE V

Brinell Hardness Test

Material	Brinell hardness number					
	r. t. (20°C)	0°C	-20°C	-40°C	-60°C	-75°C ca.
Monel Metal (2)	208	203	218	218	222	227
Stainless (4)	139	143	148	148	154	155
Stainless (4H1)	215	227	230	237	241	246
Stainless (4H2)	270	273	282	284	289	299
"18 and 8" (6)	144	156	171	183	193	192
"18 and 8" (6CW)	260	282	282	288	295	295
3½% Ni (1T)	158	162	168	175	284	288
Chromium- molybdenum (9T1)	256	256	256	256	261	269
Chromium- molybdenum (9T2)	350	362	371	381	383	394

TABLE VI

Charpy Impact Resistance* in Foot Pounds

Material	r. t. (ca. 20°C)	0°C	-20°C	-40°C	-60°C	-80°C ca.
Monel Metal (2)	62	74	66	62	60	63
Stainless (4)	39	38	4	25	1	1
Stainless (4H)	28	--	--	3 25 6		
"18 and 8" (6)	80	78	77	78	81	82
"18 and 8" (6CW)	35	33	31	30	29	29
3½% Ni (1T)	40	--	37	38	33	--
Chromium- molybdenum (9T1)	39	29	27	22	20	17
Chromium- molybdenum (9T2)	21	26	24	18	21	12

*10 by 10 mm specimen, key hole notch, No. 47 drill.

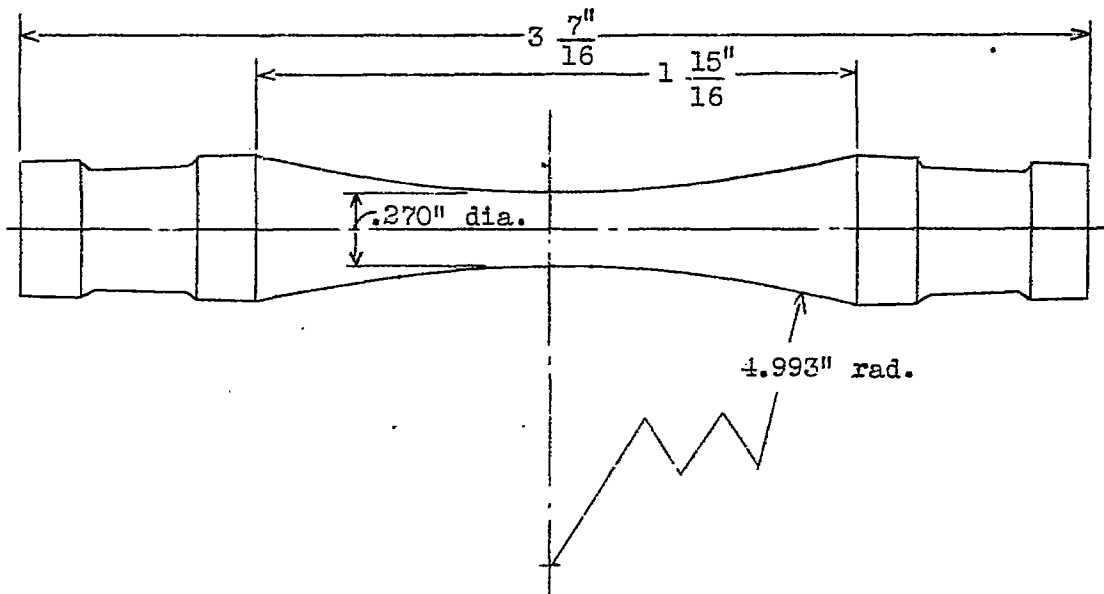

Fig.1 Modified endurance specimen.

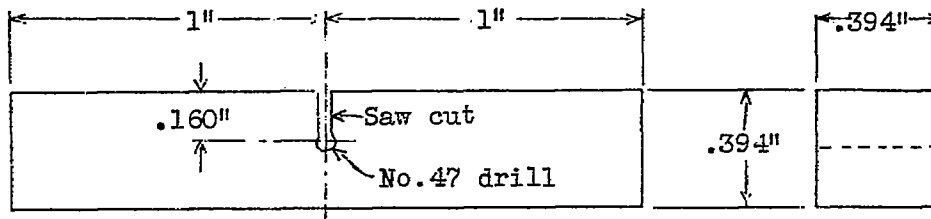

Fig.1 Charpy impact specimen.

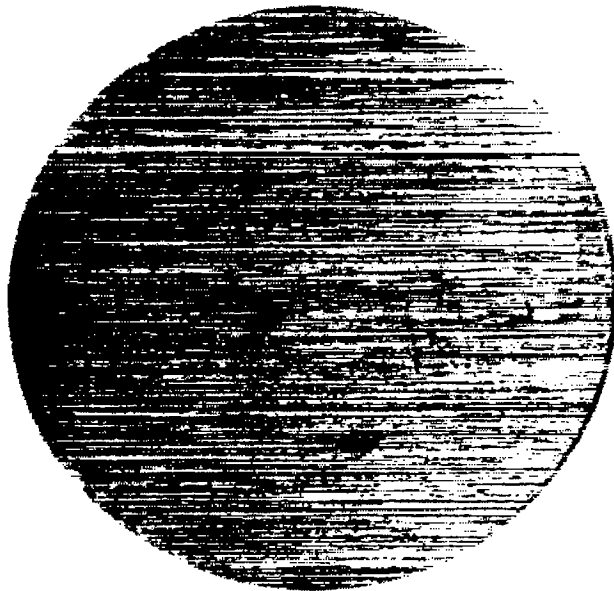

Fig.2 Polished fatigue specimen - 100X

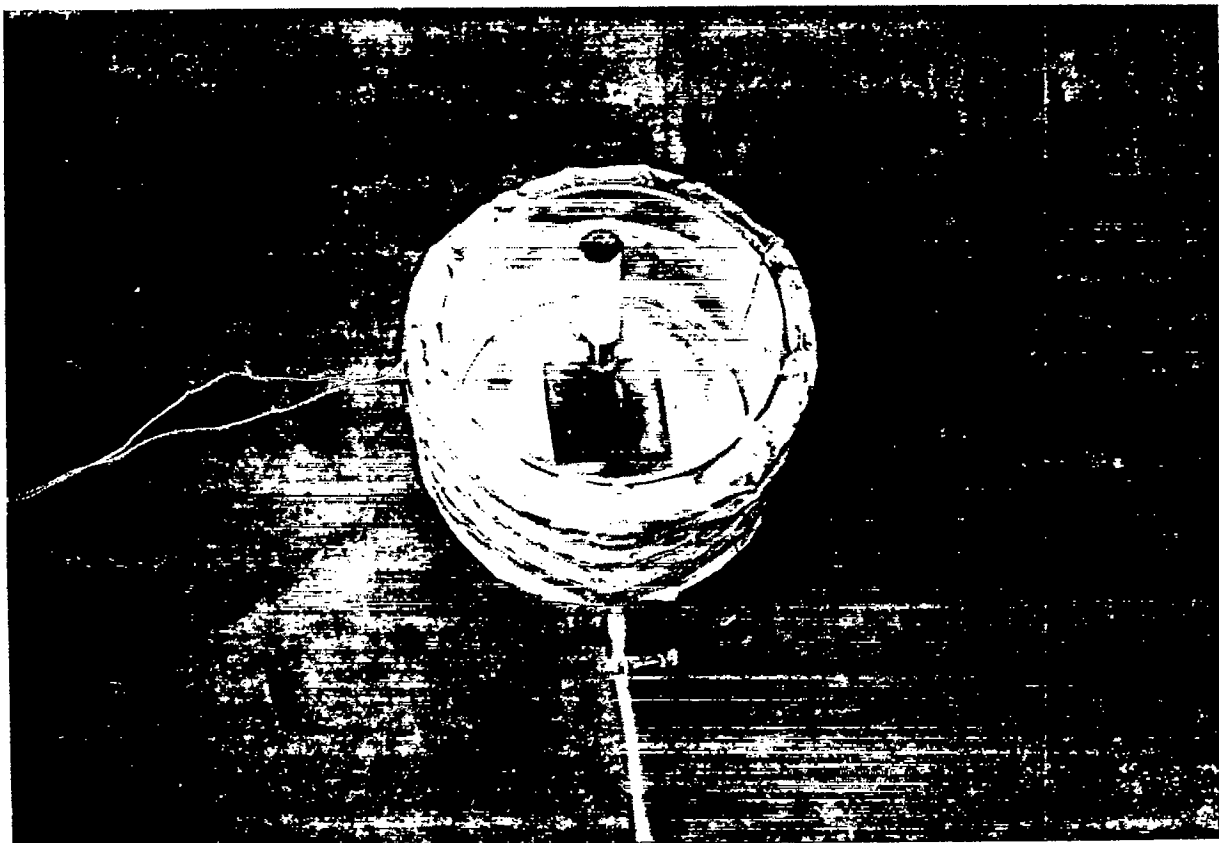

Fig.6 Cooling bath for tensile test.

N.A.C.A. Technical Note No.381

Figs.4,5

1. In left bearing.
2. In right bearing.
3. In air under fan.
4. In air at damper.
5. In air outside inner chamber.

6. On cork wall oppo-
site inner
chamber.

7. On right
bearing
support.

8. On left
stirrup.

9. On fatigue
specimen (loop)

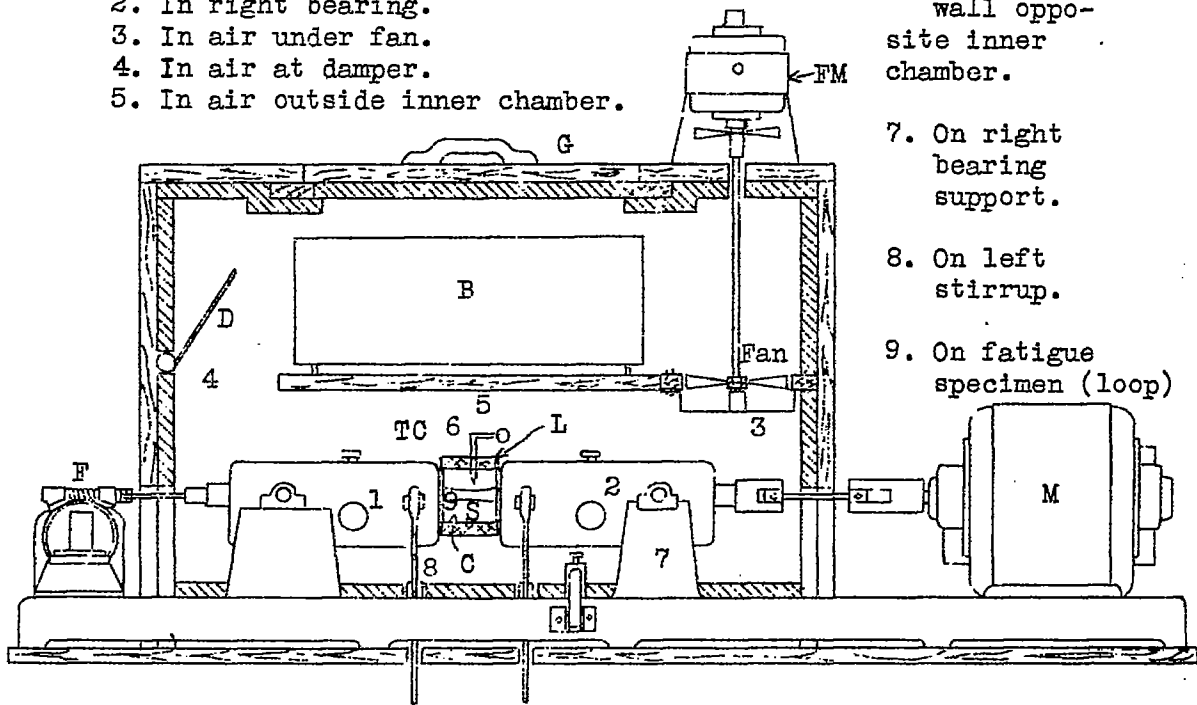

Fig.4 Low temperature endurance testing apparatus showing also positions of couples for temperature distribution test.

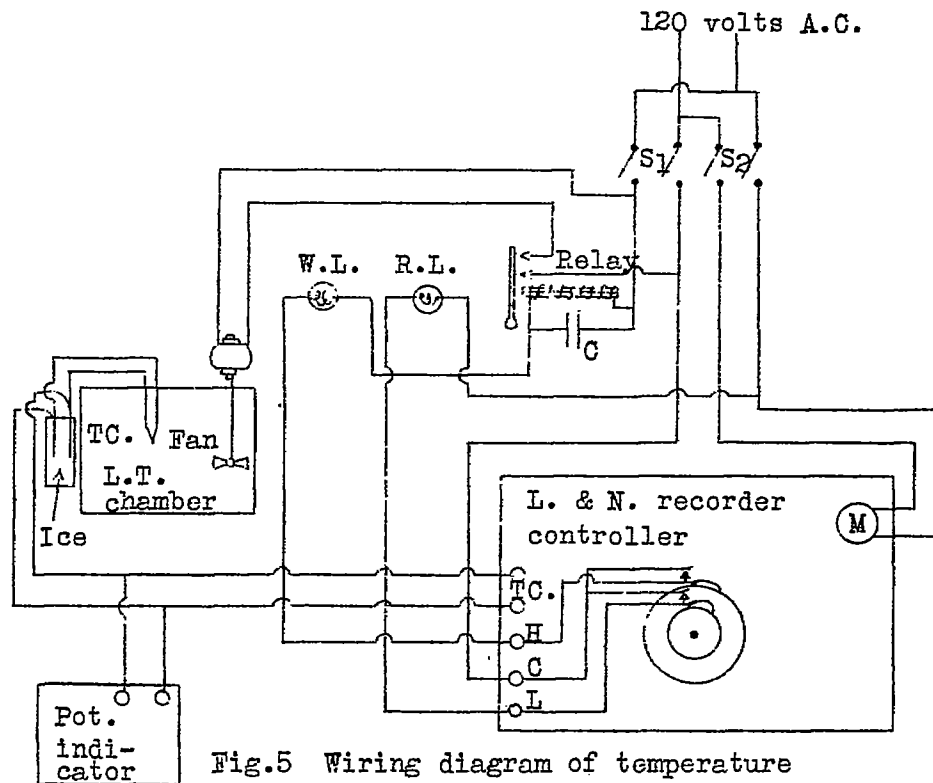

Fig.5 Wiring diagram of temperature controlling mechanism.

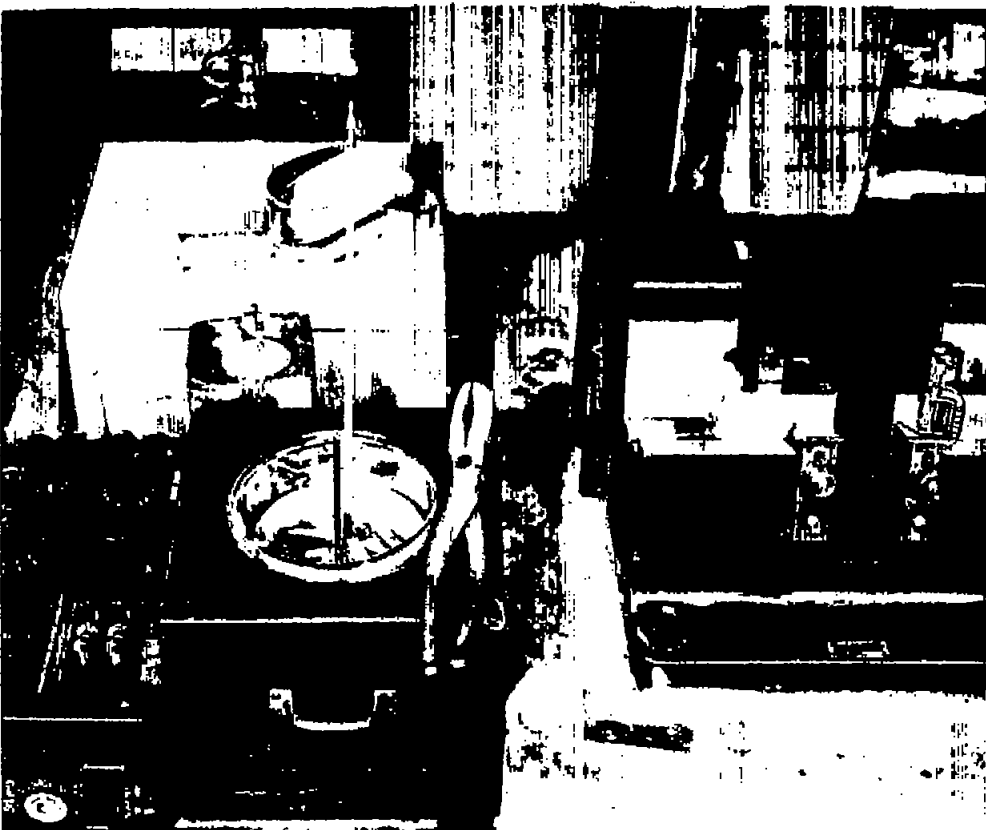

Fig.8 Low temperature Charpy impact apparatus.

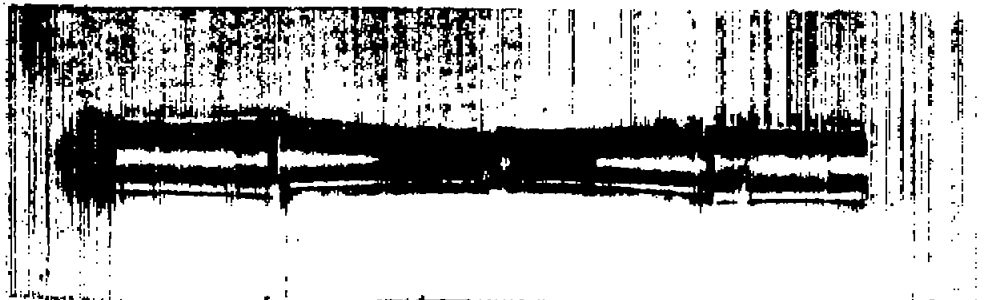

Fig.9 Typical fracture of "18 and B".

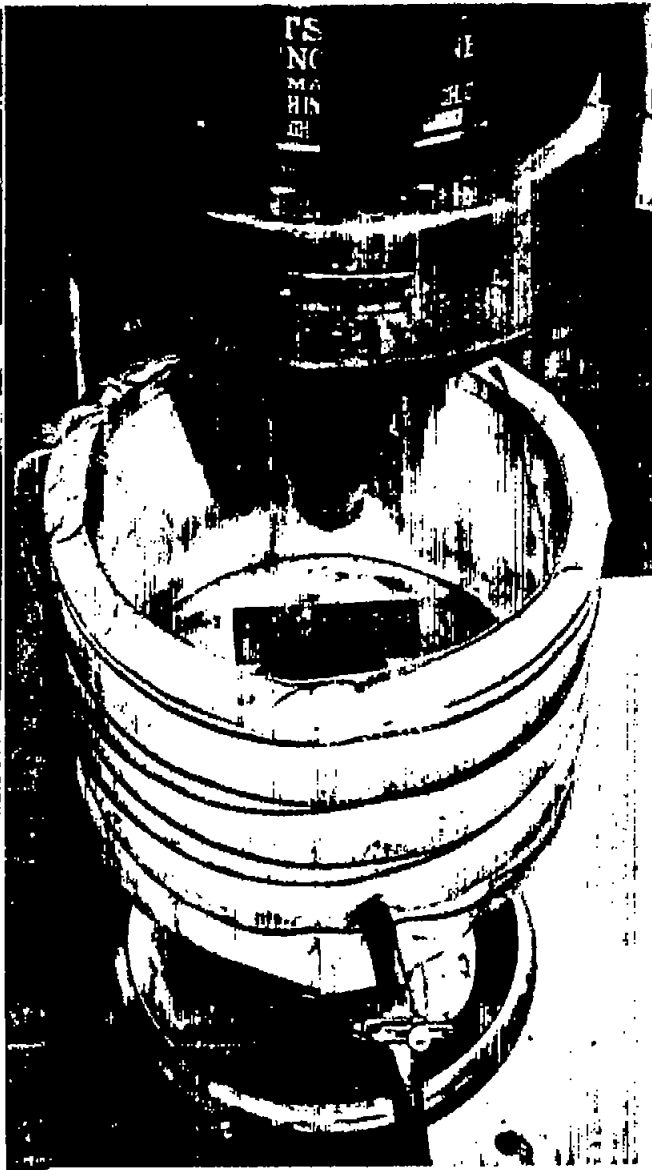

Fig.7 Low temperature hardness apparatus.

Monel metal - 2
 o Room temperature run
 x Low temperature run
 o--o Stress raised

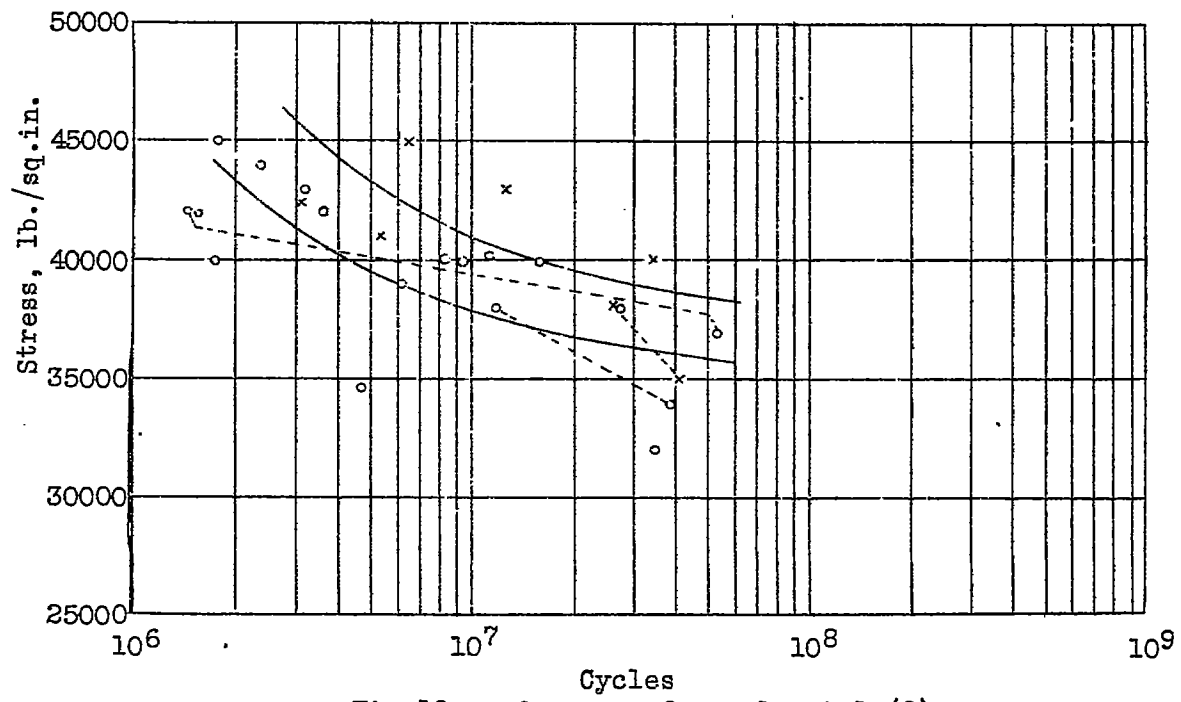

Fig.10 Endurance of Monel metal (2)

Stainless steel - 4

o Room temperature run → Specimen unbroken
 x Low temperature run o--o Stress raised

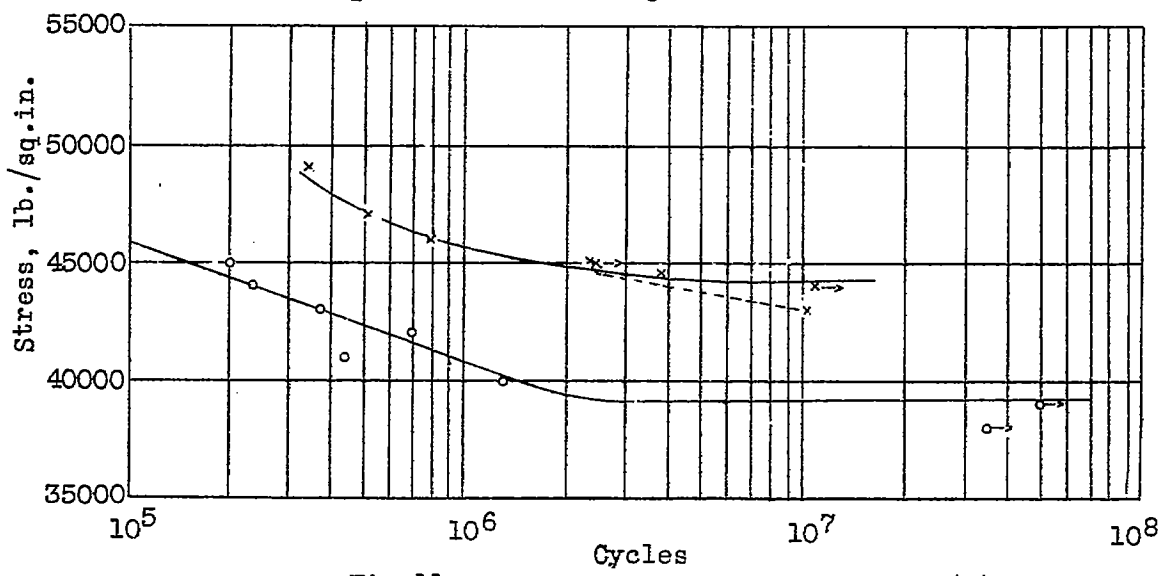

Fig.11 Endurance of stainless steel (4)

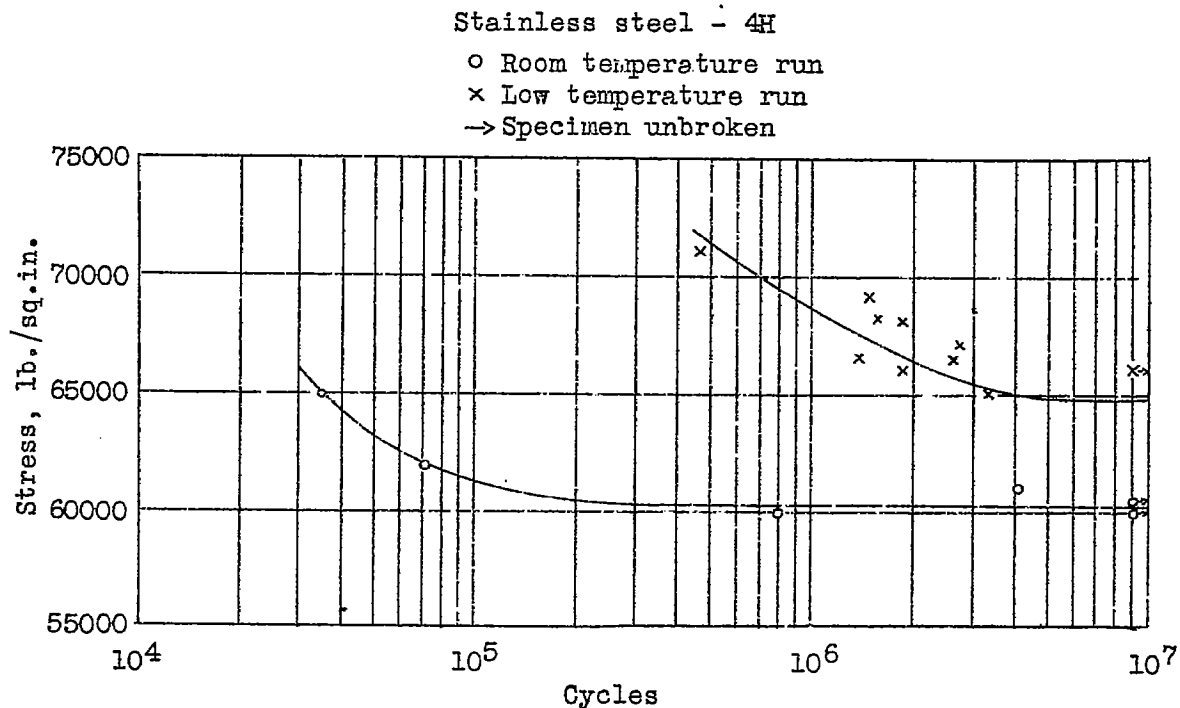

Fig.12 Endurance of stainless steel (4H)

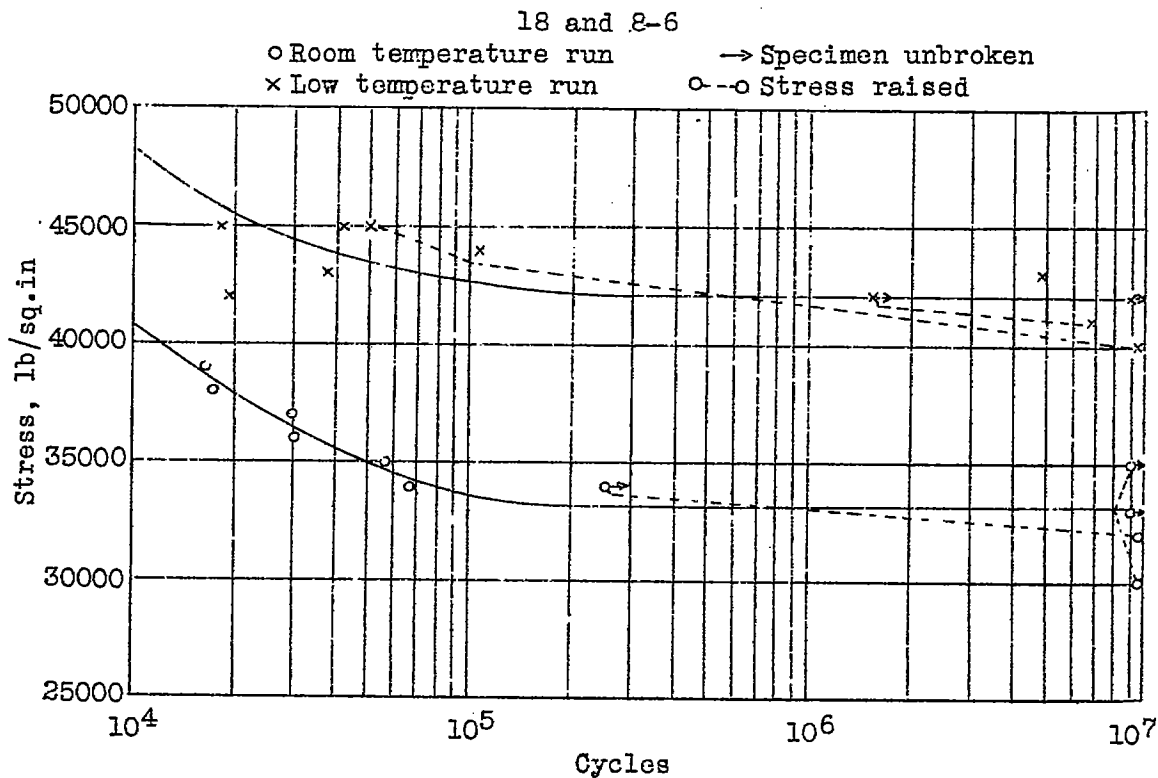

Fig.13 Endurance of 18 and 8-6

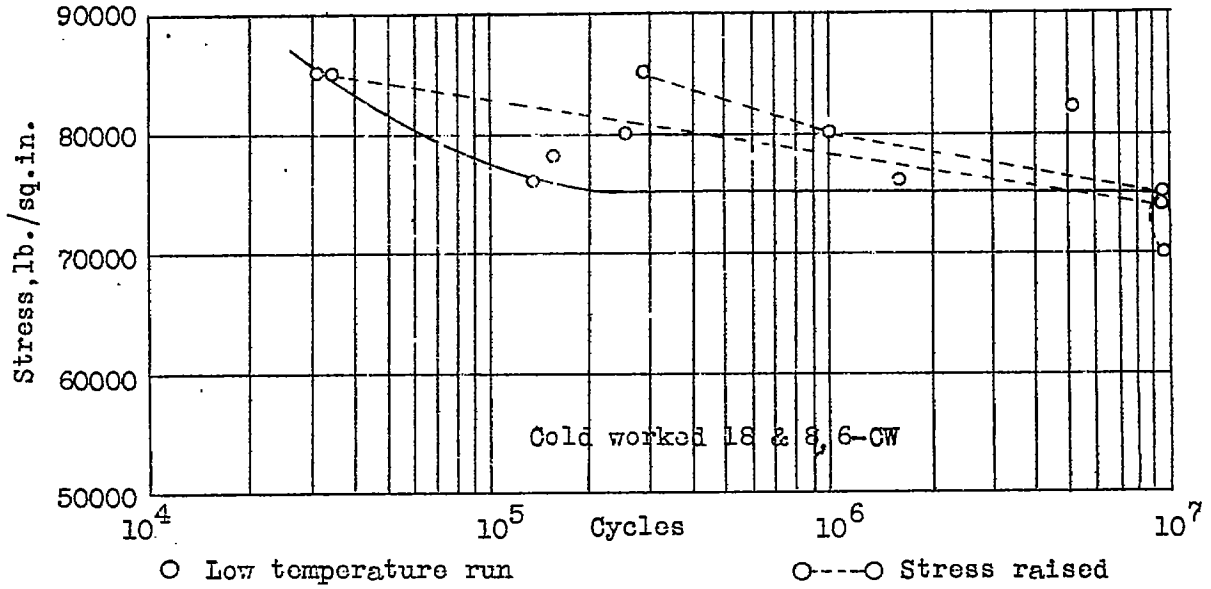

Fig.14a Low temperature endurance of cold worked "18 and 8" 6-CW.

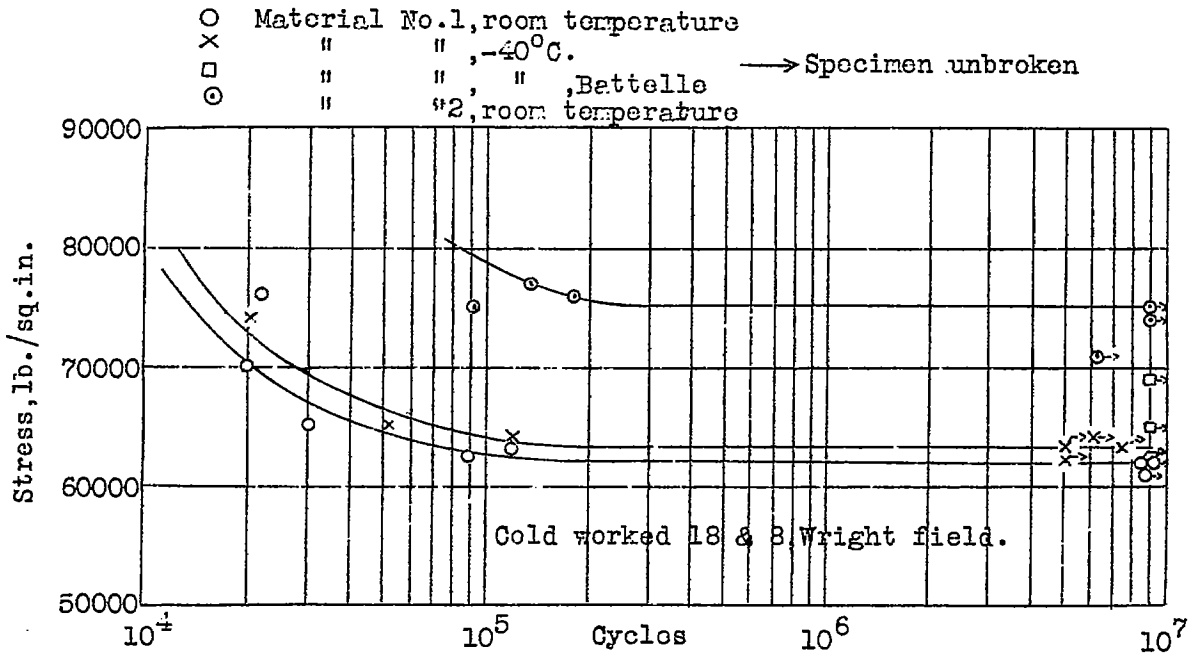
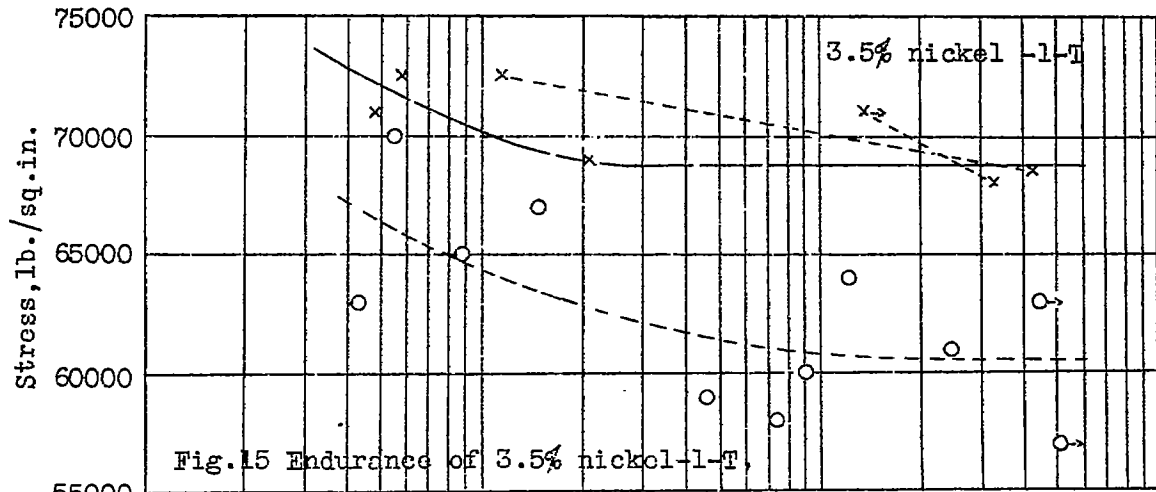
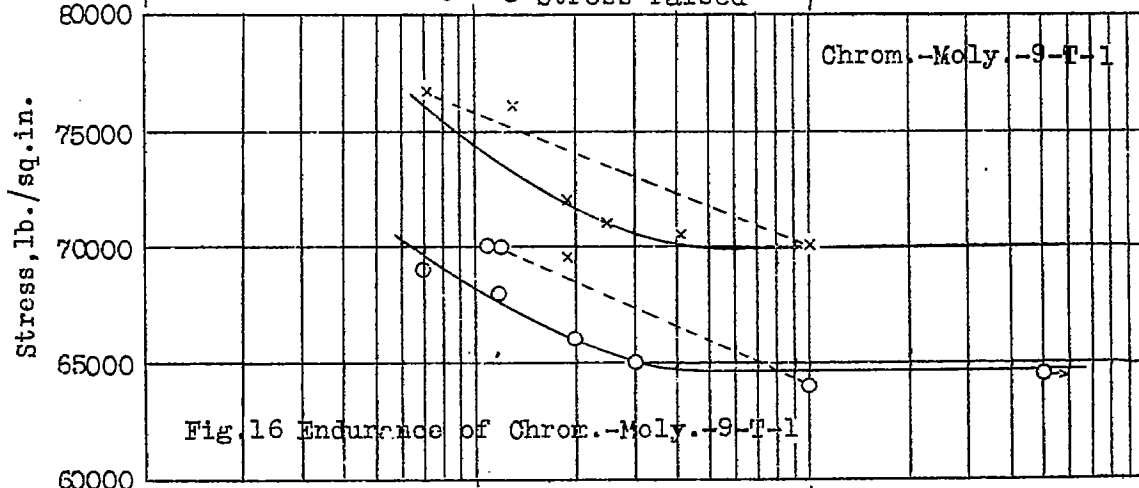

Fig.14b Endurance of cold worked "18 and 8", by J.B. Johnson.



○ Room temp. run × Low temp. run → Specimen unbroken
 ○---○ Stress raised



○ Room temp. run × Low temp. run → Specimen unbroken
 ○---○ Stress raised

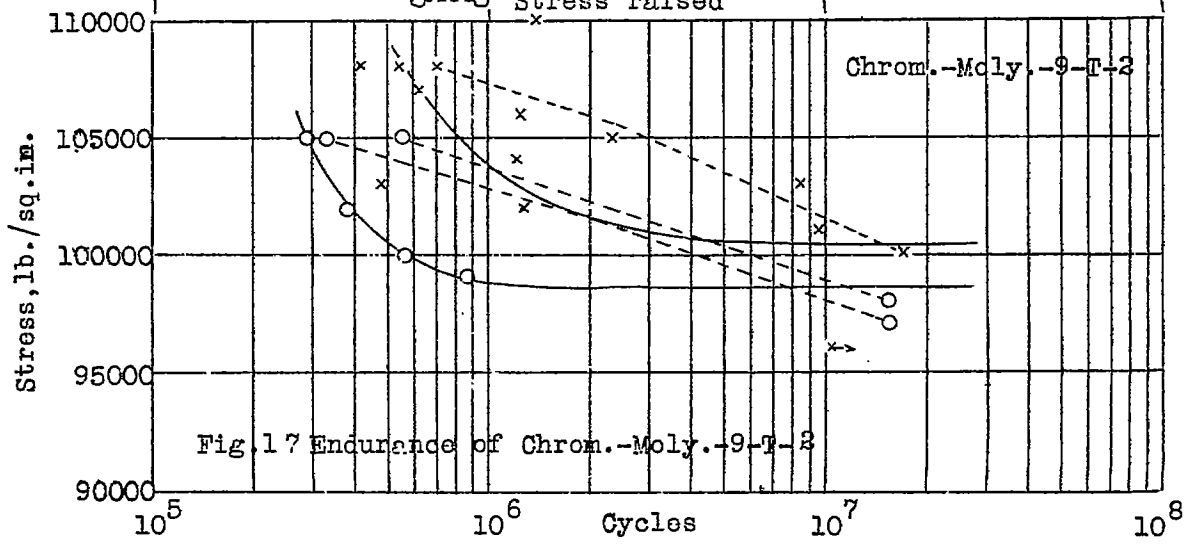

Fig.17 Endurance of Chrom.-Moly.-9-T-2

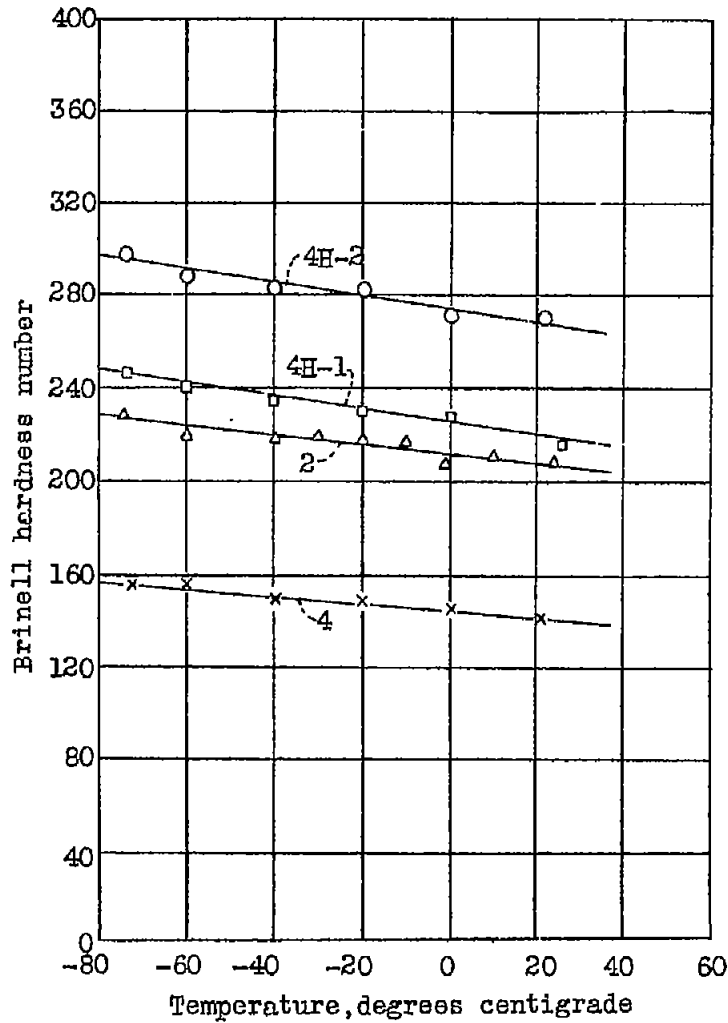

Fig.18 Variation of Brinell hardness with temperature.

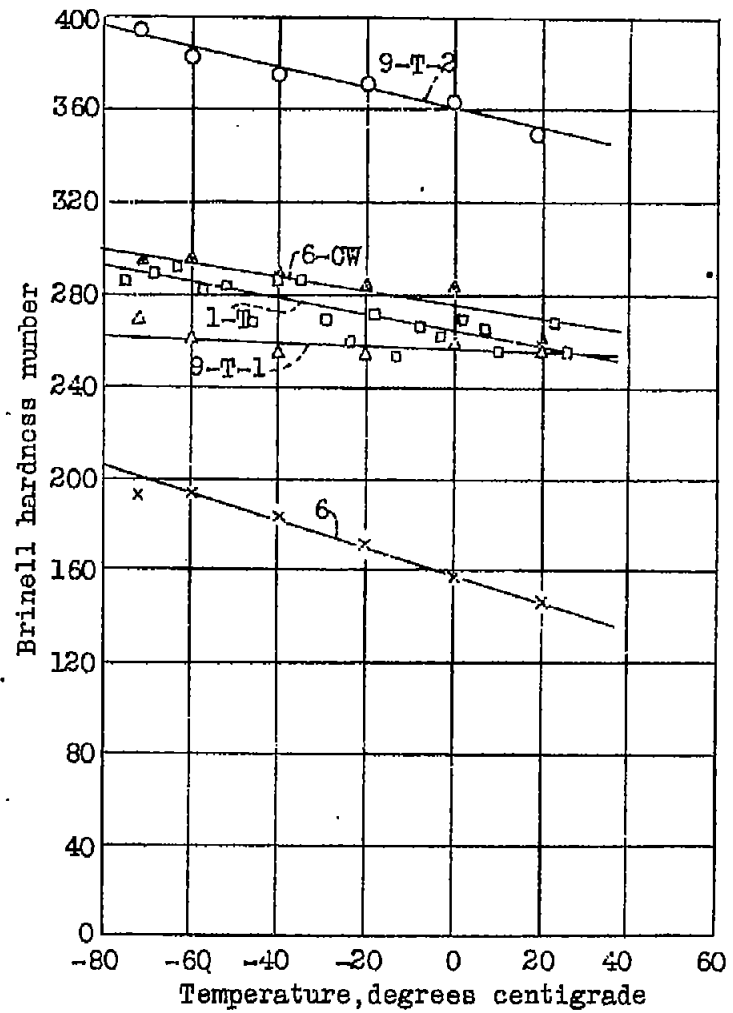

Fig.19 Variation of Brinell hardness with temperature.

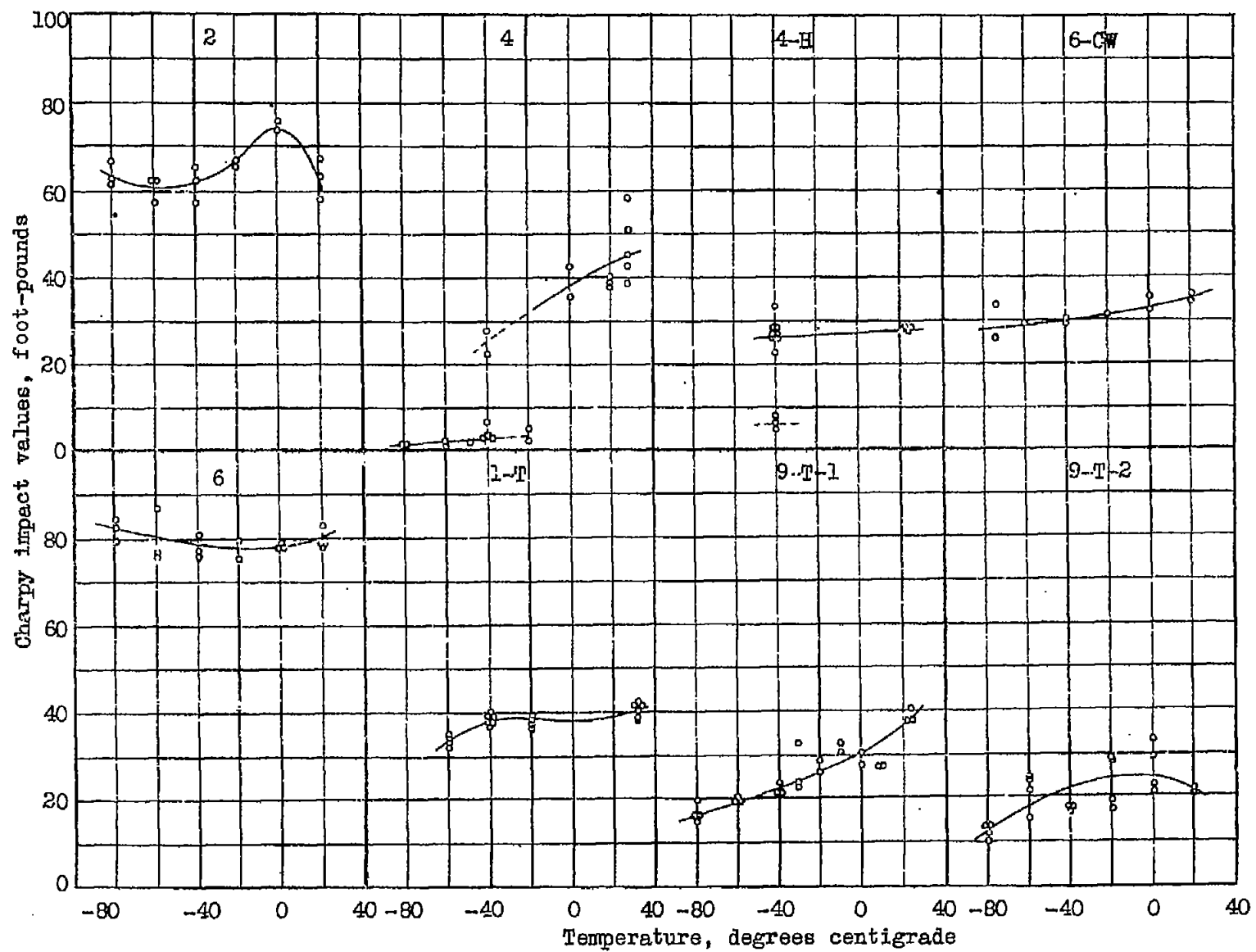

Fig. 20 Charpy impact resistance at various temperatures.