

NATIONAL ADVISORY COMMITTEE
FOR AERONAUTICS
MAILED
SEP 2 1931
TO: S. M. A. L.

~~_____~~
~~_____~~
~~_____~~

TECHNICAL NOTES
NATIONAL ADVISORY COMMITTEE FOR AERONAUTICS

No. 389

THE N.A.C.A. APPARATUS FOR STUDYING THE
FORMATION AND COMBUSTION OF FUEL SPRAYS AND THE RESULTS
FROM PRELIMINARY TESTS

By A. M. Rothrock
Langley Memorial Aeronautical Laboratory

FILE COPY

To be returned to
the files of the Langley
Memorial Aeronautical
Laboratory.

Washington
September, 1931

NATIONAL ADVISORY COMMITTEE FOR AERONAUTICS

TECHNICAL NOTE NO. 389

THE N.A.C.A. APPARATUS FOR STUDYING THE FORMATION
AND COMBUSTION OF FUEL SPRAYS AND THE RESULTS
FROM PRELIMINARY TESTS

By A. M. Rothrock

SUMMARY

This report describes the apparatus as designed and constructed at the Langley Memorial Aeronautical Laboratory, for studying the formation and combustion of fuel sprays under conditions closely simulating those occurring in a high-speed compression-ignition engine. The apparatus consists of a single-cylinder modified test engine, a fuel-injection system so designed that a single charge of fuel can be injected into the combustion chamber of the engine, an electric driving motor, and a high-speed photographic apparatus. The cylinder head of the engine has a vertical disk form of combustion chamber whose sides are glass windows. When the fuel is injected into the combustion chamber, motion pictures at the rate of 2000 per second are taken of the spray formation by means of spark discharges. When combustion takes place the light of the combustion is recorded on the same photographic film as the spray photographs.

The report includes the results of some tests to determine the effect of air temperature, air flow, and nozzle design on the spray formation. The results show that the compression temperature has little effect on the penetration of the fuel spray but does affect the dispersion, that air velocities of about 300 feet per second are necessary to destroy the core of the spray, and that the effect of air flow on the spray is controlled to a certain extent by the design of the injection nozzle. The results on the combustion of the spray show that when ignition does not take place until after spray cut-off the ignition may start almost simultaneously throughout the combustion chamber or at different points throughout the chamber. When

ignition takes place before spray cut-off the combustion starts around the edge of the spray and then spreads throughout the chamber.

INTRODUCTION

During the last five years the National Advisory Committee for Aeronautics has published considerable information on the formation of fuel sprays for high-speed compression-ignition engines. The majority of the investigations reported have dealt with the effects on the fuel spray of the injection-nozzle design, of the injection system, and of the density of the air into which the fuel has been sprayed. Only one report has been published by the Committee (reference 1) on the effect of high air temperatures on the formation and penetration of the fuel spray. The tests reported in this reference, although conducted by spraying the fuel into air at atmospheric pressure, indicated the necessity of extending the researches of the Committee to include a study of the spray formation and penetration into air at the temperatures and densities in the combustion chambers of high-speed compression-ignition engines.

In addition to studying the formation and penetration of the fuel spray in the engine it is necessary to study the combustion of the fuel spray. Investigations on the phenomena of combustion as applied to the compression-ignition engine have been conducted principally in England and Germany. Some of the earliest work was done by Moore. (Reference 2.) His tests were made to determine the auto-ignition temperatures of liquid fuels at atmospheric pressure. This work was extended by Wollers and Ehmcke (reference 3) and by Alt (reference 4). The next step was to investigate the effect of air density on the auto-ignition temperature of fuel sprayed into heated dense air. Such tests were conducted by Hawkes (reference 5) and Bird (reference 6) and by Tausz and Schulte (reference 7) and Neumann (reference 8). These same investigators also determined the effect of air temperature on the time lag of auto-ignition. Bird (reference 9) then extended the tests by photographing the combustion in a constant-volume chamber. Bird's tests were the first in which ignition lags were recorded as low as 0.004 second, a value of the same order of magnitude as that obtained in high-speed compres-

sion-ignition engines. Mader (reference 10), by means of a small glass window placed in the combustion chamber of a compression-ignition engine, obtained stroboscopic pictures of the combustion of the fuel spray. Tizard and Pye (reference 11) and Fenning and Cotton (reference 12) and Duchêne (reference 13) conducted tests in which the auto-ignition lag of gases ignited by adiabatic compression was measured. In addition, Duchene, employing a small glass cylinder, photographed the combustion.

As a result of an analysis of the preceding investigations it was decided to extend the research on combustion by constructing an apparatus that would permit photographing the combustion of fuel sprays in a chamber in which the air was heated by adiabatic compression and in which the combustion continued during the expansion of the gases. This apparatus when used in conjunction with the photographic apparatus of the N.A.C.A. spray-photography equipment (reference 14) would permit photographs to be obtained of both the spray formation and combustion under conditions which closely simulate those in the combustion chamber of a compression-ignition engine.

The purpose of this report is to describe the apparatus as designed and constructed at the Langley Memorial Aeronautical Laboratory, Langley Field, Va., and to present some of the preliminary test results which are representative of the results that can be obtained with the apparatus. Unless otherwise stated, all tests were conducted with Diesel fuel.

PART I

DESCRIPTION OF APPARATUS

The apparatus consists essentially of a modified single-cylinder test engine, an electric motor for driving the test engine, a fuel-injection system driven from the crankshaft of the engine, and a high-speed photographic system. A photograph of the engine, injection system, and driving motor is shown in Figure 1, and a sketch of the engine and the injection system in Figure 2.

Test Engine.— The combustion chamber of the engine has a diameter of 3 inches and a depth of $7/8$ inch. This shape was chosen because it permits the two sides of the chamber to be made of glass disks. There are two 1-inch thick windows on each side of the chamber separated by an air space which is connected to a tank of compressed air. Since the air temperatures of 2000° to 3000° F. absolute and pressures in excess of 800 pounds per square inch are reached in the combustion chamber the conditions to which the inner windows are exposed are extremely severe. By maintaining an air pressure between the windows of approximately 450 pounds per square inch the maximum stress on the inner windows is reduced. The combustion chamber is connected to the displacement volume of the engine by a rectangular orifice of a size, 0.695 square inch in area, to produce calculated air velocities of 300 feet per second in the chamber.

There are two openings in the cylinder head for the injection valve so that the effect of air velocities can be studied with the spray directed normal to or counter to the air flow. The third opening is used for a maximum pressure indicator.

The cylinder of the engine has a bore of 5 inches and a stroke of 7 inches. The volumetric compression ratio of the engine is 15.8:1. At the bottom of the stroke the piston uncovers ports in the cylinder wall. These ports are connected to a cam-operated poppet valve so adjusted that it is open when the piston is at bottom center. These ports and the valve permit air to enter the displacement volume and compensate for air leakage around the piston rings. In addition, the inlet manifold may be connected to an air compressor so that the effect of increased air density on the fuel spray and on the combustion may be studied.

The core passages in the cylinder head and the jacket around the cylinder are connected to an electrically heated tank containing glycerine. By means of this liquid, temperatures of 500° F. can be maintained in the cylinder jacket and the cylinder head. A suitable pump is used to circulate the glycerine.

One end of the crankshaft is connected to the electric driving motor, and the other end to the timing gear through which the injection system is driven. The timing gear is calibrated so that the start of injection can be varied in increments of one crankshaft degree. The shaft connecting the timing gear to the injection system is separated by a clutch similar to those employed on press punches. When this clutch is engaged by means of the mechanism shown in Figure 2 the camshaft of the injection system makes a single revolution at a speed one-half the engine crankshaft speed.

Injection System.- The injection system is of the type used on the N.A.C.A. spray-photography equipment. This system was chosen because its characteristics have been extensively investigated by Gelalles (reference 15) who determined the effect of the different variables in the injection system on the formation and development of the fuel spray, and by the author (reference 16) who determined the effect of the different variables in the injection system on the instantaneous pressures at the discharge orifice of the injection valve. The system consists of a high-pressure reservoir to which fuel is forced under pressures up to 10,000 pounds per square inch by means of a hand pump; a timing valve connected by suitable tubing to the injection valve; a by-pass valve for controlling the injection period; and a valve for controlling the initial pressure in the injection tube before the start of injection. The tube connecting the timing valve and the injection valve is 50 inches long so that the instantaneous pressures at the discharge orifice will not fluctuate because of the pressure-wave phenomena. (Reference 16.) A hand-operated needle valve in the top of the high-pressure reservoir allows air to be released from the reservoir.

When the clutch mechanism is engaged by the operating lever the first cam opens the timing valve, which releases the fuel under pressure in the reservoir to the automatic injection valve. Injection continues until the second cam opens the by-pass valve, at which time the hydraulic pressure in the high-pressure reservoir is released to atmos-

pheric pressure and the injection is stopped. The period of injection can be varied by means of the serrated coupling connecting the by-pass valve cam to the camshaft.

Photographic Equipment.- Figure 3 shows a diagrammatic sketch of the high-speed photographic system and the arrangement of the camera and the spark gap relative to the combustion chamber in which the injection valve is shown mounted in the vertical position. In the operation of the electric circuit the rotary distributor is driven at a speed of approximately 2,400 r.p.m. The primary circuit of the high-tension transformer is closed charging the electric condensers to 30,000 volts through the kenotron tube for rectifying the current. When the clutch for the fuel-injection system is engaged, the rotation of the camshaft closes the spark-discharge switch grounding the condensers through the spark gap. The condensers are therefore consecutively discharged as the contacts on the rotary distributor complete the condenser circuits. With the four contacts as shown in Figure 3, the rate of discharge of the condensers is 4000 per second. For the present series of tests two of the contacts were removed, giving a rate of discharge of 2000 per second. The light from each condenser discharge is reflected from the parabolic mirror so that a converging beam enters the combustion chamber. The lens mounted in the camera then focuses the image of the chamber onto the film mounted on the rotating film drum. The drum has a diameter of 30 inches and turns at a peripheral speed of 2000 inches per second. By means of a serrated coupling connecting the spark discharge switch with the camshaft, the time of start of the spark discharges can be synchronized with the start of the fuel injection into the combustion chamber. When the injection takes place the light from the spark discharges is intercepted by the fuel spray so that silhouettes of the spray are recorded on the photographic film. When combustion takes place the light of the combustion is focused onto the rotating film by the lens. Consequently, high-speed motion pictures are obtained of the spray but a continuous picture is obtained of the combustion. Standard commercial photographic film is used with satisfactory results.

PART II

RESULTS FROM PRELIMINARY TESTS

Reproducibility of Fuel Sprays

The object of the first test conducted was to determine the reproducibility of the fuel sprays. Figure 4 shows three series of spray photographs taken with nozzle No. 18 (fig. 5) under the same conditions. There is little variation in the penetration of the sprays in the three series. There is, however, a difference in the dispersion of the sprays. In the top series the spray was well dispersed at 10° after top center. In the second series the spray did not fill the volume of the chamber included between the windows until 20° after top center. In the third series the dispersion was about the same as in the second. The reproducibility of the sprays is considered satisfactory.

Effect of Air Temperature on the Fuel Spray

Photographs were taken of the fuel spray in the combustion chamber using nozzle No. 18 (fig. 5) with the injection starting at top center so that the velocity of air flow in the chamber would be a minimum. With the same injection valve and nozzle, photographs were taken of the fuel sprays in the spray chamber of the spray-photography equipment at an air density of 1.1 pounds per cubic foot and at room temperature. The results are shown in Figure 6. Both series of photographs are silhouettes. The rate of penetration of the spray tips was slightly decreased in the hot air; and the fuel dispersed throughout the chamber to a greater extent than in the air at room temperature. In the cold air, after the cut-off of injection the spray diffused slowly throughout the chamber but at all times light was transmitted through the chamber. With injection into the hot air the spray completely blocked out the light after 0.004 second. Injection cut-off occurred at approximately 0.0038 second. Whether or not this diffusion throughout the chamber is accompanied by appreciable vaporization cannot be told from the photographs. The photographs show that observations of fuel sprays obtained in air at room temperature but at a density corresponding to that in the combustion chamber of a compression-ignition engine yield information on the spray characteristics which

is directly applicable to engine conditions.

The results present a check on the tests made by Joachim and Boardsloy which showed that it was the air density and not the air pressure that affects the spray penetration (reference 17). In their tests it was shown that at room temperature increasing the air pressure from 200 to 400 pounds per square inch decreased the distance of the spray-tip penetration 28 per cent at the end of 0.001 second. In the tests from which the photographs in Figure 3 were obtained the air pressure for injection into air at room temperature was 210 pounds per square inch, whereas the pressure in the engine with the piston at top center was 465 pounds per square inch.

Effect of Air Flow on the Fuel Spray

The air velocity (fig. 7) through the orifice connecting the combustion chamber to the displacement volume was computed for an engine speed of 1500 r.p.m. by the method given in reference 7. The curve is plotted from right to left to correspond with the spray photographs. From 38° to 14° B.T.C. the variation in velocity was only 40 feet per second. After being forced through the orifice the air jet strikes the top of the chamber and then is divided, forming whirls in each half of the chamber.

Figure 8 (see also Table I) shows the effect of the air flow on the spray from a single 0.020-inch orifice with the injection valve mounted in the horizontal position so that the air flow is normal to the spray. With injection starting at 50° before top center the air velocity at the time when the spray had penetrated across the chamber was sufficient to blow the fuel away from the edge of the spray and to deflect slightly the main core of the spray. The fuel from the part of the spray in the center of the chamber was blown upward by the incoming air, and the fuel close to the injection valve was blown downward by the air whirls. At 21° before top center the deflection of the core of the spray is shown. The succeeding photographs show no spray, indicating that the fuel is either well dispersed or vaporized.

With injection starting at 40° before top center the same tendencies are observed as in the previous photographs.

With injection starting at 30° before top center the spray in the first spray photograph is shown being blown upward in the direction of the air flow. In the second photograph the spray has traversed beyond the middle of the chamber, but has been bent upward. Between 35° and 45° after top center the chamber becomes fogged. This extremely rapid fogging is observed in all the photographs with injection starting at or later than 30° before top center. The exact cause of it is not known. It is possible that it is caused by sudden condensation of fuel vapor when the temperature of the air on the down stroke of the piston passes the critical temperature of the fuel.

The photographs for injection starting at 20° before top center show the same general effects as those shown in the preceding photographs. However, with injection starting at 10° before top center the air flow had considerably less effect on the spray. It is interesting to observe that when the spray continued after top center the direction of the air flow was reversed; the spray was deflected downward although the main core of the spray was not destroyed. With injection starting at top center the spray after traversing the chamber was reflected from the chamber wall.

A comparison of all the photographs shows that the air flow produced by the piston forcing the air through a narrow restriction between the displacement volume and the combustion chamber had a decided effect on the spray, the magnitude of the effect depending on the injection timing. The photographs and the computations show that air velocities of approximately 300 feet per second were necessary to appreciably deflect the main core of the spray. (Compare with results published in reference 18.)

Figure 9 (see also Table II) shows the effect of air flow on the fuel spray from a single 0.020-inch orifice with the injection valve mounted in the vertical position so that the air flow is counter to the spray. With injection starting at 40° before top center the spray penetrated across the section of the chamber included in the glass windows but was blown backward between 10° before top center and top center, after which cut-off occurred. With injection starting 30° before top center the spray penetrated the depth of the chamber but the spray angle was considerably increased by the air velocity directed against the spray. With injection starting at 20° before top center the spray again penetrated the depth of the chamber

and as before the spray angle was considerably increased. With injection starting at 10° before top center there was a decrease in the effect of air flow on the fuel spray. With injection starting at top center there was no appreciable effect of the reversed air flow on the spray. The cone angle of the spray was approximately that observed when the fuel was injected into air at room temperature. (Reference 15.)

The same general conclusions can be drawn from this figure as from Figure 8. The mixing of the fuel and air appears to be more uniform with the air flow directed counter to the spray than with the air flow directed normal to the spray.

Figure 10 shows the effect of the direction of the air flow relative to the fuel sprays from nozzle No. 17, Figure 5. This nozzle is the same as nozzle No. 18 except that the C orifices have a diameter of 0.005 inch instead of 0.012 inch. In general, the results are the same as those obtained with the single 0.020-inch orifice.

Figure 11 shows the effect of the air flow on the fuel sprays from nozzle No. 18, Figure 5. With injection starting at 50° before top center the air flow had no appreciable effect on the spray until after cut-off, which occurred between 30° and 20° before top center. At no time did the spray completely block out the light from the spark discharges. After cut-off, the moving air had considerable effect on the spray, dispersing the fuel unevenly throughout the chamber. With injection starting at 40° before top center the first spray photograph shows fuel being blown away from the tip of the spray. The air flow between 30° and 20° before top center blew the spray aside to a certain extent but the central sprays of the cores were little affected. After cut-off the light from the spark discharges was not completely blocked out but there was more blocking than was shown in the previous photographs. The distribution after cut-off was still very uneven. With injection starting at 30° before top center the fuel did not penetrate across the chamber. The individual sprays cannot be distinguished after 15° before top center. Between 20° and 30° after top center the light from the spark discharges was completely blocked out. With injection starting at 20° before top center the effect of the air flow was about the same as with injection starting at 30° before top center. Complete diffusion of the spray throughout the chamber occurred between 20° and 30° after

top center and apparently very soon after cut-off.

With injection starting at 10° before top center the effect of the air flow was quite marked, but the penetration of the spray was greater than that obtained with injection starting at 20° before top center. Diffusion throughout the chamber occurred at cut-off. With injection starting at top center the air flow had little effect on the sprays. This series of photographs is the same as shown in Figure 4 where they have been discussed in detail.

The photographs in Figure 11 show that enlarging the C orifices from 0.005-inch diameter to 0.012-inch diameter had a decided effect on the spray when the air flow was directed normal to the spray. The results indicate that the sprays from the larger orifices tended to stop the air flow so that there was no deflection of the central core of the sprays. With low air velocities the distribution improved very rapidly following the cut-off of injection. Consequently, as the author has mentioned in a previous report (reference 19), it can be expected that in a quiescent combustion chamber if combustion does not start until after injection cut-off, the burning of the fuel will take place at a rate resulting in detonation. The photographs show how the dispersion of the fuel during injection is improved by the use of high air velocities.

Figure 12 shows the effect of air flow on the sprays from nozzle $N_0. 18$ mounted in the vertical position. The fuel used in this test was a hydrogenated fuel known as "Safety Fuel," the properties of which will be discussed later. With the injection starting at 40° before top center the spray spread out, tending to fill the whole chamber. However, the moving air directed against the spray prevented the fuel from reaching the bottom of the combustion chamber. Between 20° before top center and top center the fuel was blown backward, decreasing the penetration. The sprays at an angle to the center line of the combustion chamber were blown somewhat to one side. The photograph at top center shows the fuel principally in the center of the chamber. The next two photographs show the sprays reaching the bottom of the chamber and starting to diffuse throughout the chamber. The rest of the photographs show continuation of this diffusion.

With injection starting at 30° before top center a maximum penetration was reached between 20° and 10° before

top center. The penetration then decreased until after top center, at which time the fuel started to diffuse throughout the whole chamber. Between 20° and 30° after top center the combustion chamber cleared considerably and then fogged again. With injection starting at 20° before top center the penetration across the chamber was slow until after top center at which time the air velocity through the throat was reversed. The sprays then penetrated to the bottom of the chamber, but the air-fuel mixture throughout the chamber was not uniform. With injection starting at top center the penetration was slow until about 10° after top center at which time the sprays reached the bottom of the chamber. The succeeding photographs show the sprays gradually diffusing throughout the chamber.

Effect of Physical Properties of the Fuel on the Fuel Spray

Figure 13 shows a series of spray photographs obtained with Diesel fuel and nozzle No. 18, and a series of photographs obtained with safety fuel under the same conditions. Figure 14 shows the distillation curves of the two fuels and some of their physical properties are given in the following table:

	Diesel fuel	Safety fuel
Specific gravity at 100° F.	0.83	0.88
Viscosity at 100°E poise	0.022	0.021
Surface tension lb. per in.	1.6×10^{-4} at 73° F.	1.7×10^{-4} at 85° F.

The Diesel fuel penetrated faster than the safety fuel and was less affected by the air flow even though the Diesel fuel had the lower specific gravity. (See reference 17.) Because of its greater penetration the Diesel fuel spray formed the better mixture with the air. The general characteristics of the sprays are the same as those discussed in the preceding paragraphs. The fact that no light was transmitted through the windows after 27° after top center with the Diesel fuel and that light was transmitted through the windows until 50° after top center with

the safety fuel, which had the lower critical temperatures, is a further indication that condensation of the Diesel fuel vapors took place. However, further research is necessary before a definite conclusion can be drawn. The figures indicate that volatility is an important factor in the distribution of the fuel spray.

Combustion of the Fuel Spray

When a single charge of air is repeatedly compressed and expanded, heat is given up to the cylinder during the first compression so that the compression temperature is less than that which would have been obtained had the compression been strictly adiabatic. During the first expansion more heat is given up to the cylinder wall so that the temperature at the end of the first expansion is less than the temperature at the beginning of the first compression. This action is repeated on the successive compressions and expansions until an equilibrium of heat transfer is reached in which the heat given up to the cylinder walls during the latter part of compression and the first part of expansion is equal to the heat absorbed from the cylinder walls during the first part of compression and the latter part of expansion. At this condition of equilibrium, the temperature of the charge at the beginning, and consequently at the end, of compression is considerably lower than that existing when the air charge is continually renewed.

In the present apparatus this phenomenon took place to some extent. However, since some air was taken in through the ports at the start of each stroke to compensate for the air lost through leakage around the piston rings, there was additional heat input to the engine at the start of each stroke. Exactly how low the final expansion temperature became during the approximately 1500 revolutions between the starting of the engine and the photographing of the injection is not known.

During the tests the results of which have just been presented, the temperature of the air in the combustion chamber was not sufficient to cause combustion. When the cylinder head and jacket were heated to 190° to 200° F. combustion occurred several engine revolutions after the injection, provided that the air-fuel ratio was approximately 5 : 1. With smaller fuel quantities combustion oc-

curred only after five or six injections. Combustion would not take place even with an excess of fuel unless the injection valve was mounted in the vertical position, showing that even with an ignition lag of several revolutions of the engine, the combustion was affected by the direction of the air flow relative to the fuel sprays.

Three photographs of combustion under these conditions with nozzle No. 18 are shown in Figure 15. The top photograph shows rather weak combustion starting almost simultaneously throughout the combustion chamber. The end of combustion occurred in the center of the chamber before the burning died out along the edges of the chamber. The middle photograph shows strong combustion starting almost simultaneously throughout the chamber and dying out in the center and then along the edges. The bottom photograph is particularly interesting because it shows combustion starting in different parts of the chamber; finally filling the whole chamber, and then dying out on one edge before the cessation of combustion at the center and outer edge. The exact time interval between injection and combustion was not measured in obtaining the results shown in Figure 15. Visual observation indicated that the lag was about one second (25 engine revolutions).

Following the completion of the tests the results of which are presented in Figure 15, the cylinder head and jacket were insulated and heated slowly to about 400° F. Photographs were taken during the heating. The film drum was run at a peripheral speed of 30 inches per second so that the ignition lag in engine revolutions could be recorded. At this drum speed the spark discharges and the combustion were each recorded as a single circle of light, that is, the image of the combustion chamber. As the ignition lag was decreased by the increasing engine temperature the circle caused by the combustion approached that caused by the spark discharges. When combustion took place with an ignition lag of less than one engine revolution, the two images were superposed. Photographs were then taken with the film drum running at 2000 inches per second. When the ignition lag was such that combustion did not start until about 10° after the end of the fuel injection, the combustion photographs were similar to those shown in Figure 15. At the highest engine temperature, the combustion started during the injection of the fuel.

Two photographs of the process are shown in Figure 16.

With the exception of the engine temperature the conditions were the same as those under which the photographs in Figure 9 were obtained. The fuel-air ratio was about 1 : 15. In the upper photograph the combustion is seen to start around the edges of the spray (a) and to persist for about 60 crankshaft degrees. Because of fogging of the window the sprays could not be distinguished clearly enough to accurately time the record with respect to the crankshaft position. Consequently, the zero position does not necessarily correspond to top center of the engine although it is probably within 10° of it. In the lower photograph with injection starting at 30° before top center the images of the fuel spray can be seen and the combustion is again shown to start around the edge of the spray (a) and then spread throughout the chamber. The combustion period is much shorter than that with the injection starting at 10° before top center. The exact cause of this is unknown. The phenomenon was repeated in a second series of tests. Comparison of Figure 16 with Figure 15 shows that when the ignition lag of the spray is greater than the injection period, combustion starts almost simultaneously throughout the whole chamber, but when the ignition lag is less than the injection period the combustion starts along the edges of the fuel spray and then spreads throughout the chamber. (See also reference 19.)

CONCLUSIONS

Although the tests, the results of which are presented in this report, were conducted primarily to determine the range of usefulness of the apparatus, there are a few conclusions that can be drawn from the photographs:

1. The reproducibility of the fuel sprays under the same conditions was satisfactory.
2. High air temperatures slightly decrease the penetration and increase the dispersion of the fuel sprays.
3. Air velocities of approximately 300 feet per second in the combustion chamber have a decided effect on the penetration and dispersion of the fuel sprays from single round-hole orifices.
4. The effect of the air velocity on the fuel spray is dependent on the number, arrangement, and size of the

discharge orifices.

5. The physical properties of the fuel have an important effect on the dispersion and penetration of the fuel sprays.

6. The rate of combustion of the fuel spray can be decreased by forcing ignition to take place before injection is completed.

7. Ignition can be forced to take place before injection is completed by increasing the temperature of the cylinder and the combustion-chamber jackets.

Langley Memorial Aeronautical Laboratory,
National Advisory Committee for Aeronautics,
Langley Field, Va., August 26, 1931.

REFERENCES

1. Gelalles, A. G.: Some Effects of Air and Fuel Oil Temperatures on Spray Penetration and Dispersion. N.A.C.A. Technical Note No. 338, 1930.
2. Moore, Harold: Some Factors Affecting the Utilization of Heavy Fuel Oils in Internal-Combustion Engines. Paper read before the North East Coast Institution of Shipbuilders, Dec. 1, 1922.
3. Wollers and Ehmcke: Der Vergasungsvorgang der Treibmittel, die Ölgebildung, und das Verhalten der Öldämpfe und Ölgase bei der Verbrennung im Dieselmotor. Kruppsche Monatshefte, Vol. 11, 1921, p. 1.
4. Alt, Otto: Combustion of Liquid Fuels in Diesel Engine. N.A.C.A. Technical Memorandum No. 281, 1924. Translation from Z.V.D.I., July 14, 1923.
5. Hawkes, C. J.: Some Experiments in Connection with the Injection and Combustion of Fuel-Oil in Diesel Engines. Paper read before the North East Coast Institution of Shipbuilders, Nov., 1926.

REFERENCES (Continued)

6. Bird, A. L.: Experiments on Oil Jets and Their Ignition. Paper presented before the Institute of Mechanical Engineers (British), Nov., 1926.
7. Tausz, J., and Schulte, F.: Ignition Points and Combustion Reactions in Diesel Engines. N.A.C.A. Technical Memorandums Nos. 483 and 484. (Parts I and II) Communication from the Petroleum Research Laboratory of the Institute of Applied Chemistry, Technical High School, Karlsruhe. (1928)
8. Neumann, Kurt: Experiments on Self-Ignition of Liquid Fuels. N.A.C.A. Technical Memorandum No. 391, 1926. Translation from Z.V.D.I., August 7, 1926.
9. Bird, A. L.: Some Characteristics of Nozzles and Sprays for Oil Engines. Paper presented before the Third International Power Conference, Berlin, 1930.
10. Mader, O.: Weiterentwicklung des Junkers-Doppelkolbenmotors in den Junkerswerken, Dessau. Z.V.D.I., Vol. 69, No. 44, Oct., 1925, pp. 1369-1378.
11. Tizard, H. T., and Pye, D. R.: Experiments on the Ignition of Gases by Sudden Compression. Philosophical Magazine (British), Vol. XLIV, July, 1922.
12. Fenning, R. W., and Cotton, F. T.: Experiments on the Ignition of Gases by Sudden Compression. British A.R.C. R&M No. 1324, Nov., 1929.
13. Duchêne, M. R.: Contribution to the Study of Normal Burning in Gaseous Carbureted Mixtures. N.A.C.A. Technical Memorandums Nos. 547 and 548, 1928. (Parts I and II.) Translation from Service Technique et Industriel de L'Aeronautique, Bulletin Technique No. 54, Dec., 1928.
14. Beardsley, E. G.: The N.A.C.A. Photographic Apparatus for Studying Fuel Sprays from Oil Engine Injection Valves and Test Results from Several Researches. N.A.C.A. Technical Report No. 274, 1925.
15. Gellales, A. G.: Effect of Orifice Length-Diameter Ratio on Fuel Sprays for Compression-Ignition Engines. N.A.C.A. Technical Report No. 402, 1931.

REFERENCES (Continued)

- 16. Rothrock, A. M.: Pressure Fluctuations in a Common-Rail Fuel Injection System. N.A.C.A. Technical Report No. 363, 1930.
- 17. Joachim, W. F., and Beardsley, E. G.: The Effects of Fuel and Cylinder Gas Densities on the Characteristics of Fuel Sprays for Oil Engines. N.A.C.A. Technical Report No. 281, 1927.
- 18. Rothrock, A. M.: Effect of High Air Velocities on the Distribution and Penetration of a Fuel Spray. N.A.C.A. Technical Note No. 376, 1931.
- 19. Rothrock, A. M.: Combustion in a High-Speed Compression Ignition Engine. N.A.C.A. Technical Report No. 401, 1931.

TABLE I (fig. 8)

Injection start crank degrees	Sym- bol	Computed air ve- locity through jet ft./sec.	D e s c r i p t i o n
50° BTC	a	270	Start of spray - Note cylindrical shape as compared with figures in reference 17.
	b	310	Core of spray deflected upwards, fuel filling upper section of chamber.
	c	330	Fuel in first section of spray deflected downward by air whirls; remainder of spray deflected upward by main air jet.
	d	330	Remainder of core (after cut-off) blown diagonally across chamber.
	e	330	Slight secondary discharge.
	f		Chamber clear for all successive photographs.
40° BTC	a	310	Core of spray and surrounding envelope blown upward filling upper part of chamber.

TABLE I (fig. 8) (cont.)

Injection start crank degrees	Symbol	Computed air velocity through jet ft./sec.	Description	
40° BTC	b	340	Spray diffused so that core is not distinct.	
	c	330	Spray again distinct with fuel being blown away from core.	
	d		Chamber clear for all remaining photographs.	
30° BTC	a	340	See (c) for 50° BTC.	
	b	300	See (b) for 40° BTC.	
	c	220	Core of spray distinguishable but deflected upward.	
	d	-90	Spray reflected from edge of chamber.	
	e	-90	See (d) for 50° BTC.	
	f		Chamber again fogging after having remained clear for 40°.	
20° BTC	a	280	End of spray blown upwards to top of chamber.	
	b	280	First section of spray unaffected by air flow.	
	c		Chamber almost completely fogged. Note - No photographs show chamber clear after injection cut-off.	
10° BTC	a	-90	Spray still deflected upward though air flow through orifice is reversed.	
	b	-270	Edge of spray blown downward by reversed air flow.	
	c } d }			Chamber becoming fogged from edge away from injection valve to edge in which injection valve is mounted.

TABLE I (fig. 8) (cont.)

Injection start crank degrees	Sym- bol	Computed air ve- locity through jet ft./sec.	D e s c r i p t i o n
TC	a	-330	Edge of spray blown downward by re- versed air flow.
	b	-330	Edge of spray blown downward by re- versed air flow.
	c	-330	Spray reflected from edge of cham- ber.
	d		Chamber fogging as in (ed) 10° BTC but process less rapid.
	e		
	f		
	g		
	h		

TABLE II (fig. 9)

Injection start crank degrees	Sym- bol	Computed air ve- locity through orifice ft./sec.	D e s c r i p t i o n
40° BTC	a	290	Spray shows little effect of air flow.
	b	330	Decided effect of air flow particu- larly at top and bottom of spray.
	c	310	Large spray cone-angle caused by air flow. Tip of spray just reaches bottom of chamber.
	d	280	After injection cut-off. Spray be- ing blown to top of chamber.
	e		Chamber clear for all successive photographs.
30° BTC	a	340	Spray similar to that at (a) 40° BTC.

TABLE II (fig. 9) (cont.)

Injection start crank degrees	Sym- bol	Computed air ve- locity through orifice ft./sec.	D e s c r i p t i o n
30° BTC	b	300	Air flow effectively distributing spray throughout chamber.
	c	0	Spray filling greater part of chamber but distribution uneven.
	d	-220	Diffusion of spray continuing. Some light transmitted through all of chamber.
	e		Chamber clear.
	f		Chamber again almost completely fogged.
	20° BTC	a	260
b		-120	Spray deflected more to one side of chamber than other probably because of unevenness of air flow.
c		-230	After cut-off. Spray diffusing throughout chamber.
d			Chamber clearing.
e } f }			Chamber becoming fogged from bottom to top.
			Note - No photographs in which chamber is entirely clear.
10° BTC	a	120	Slight effect of air movement on envelope of spray. No effect on main core of spray.
	b	-120	Spray starting to diffuse unevenly throughout chamber.
	c	-270	Spray formation similar to (b).
	d } e } f }		Slight fogging throughout chamber.
	g } h }		Chamber becomes almost completely fogged.

TABLE II (fig. 9) (cont.)

Injection start crank degrees	Sym- bol	Computed air ve- locity through orifice ft./sec.	D e s c r i p t i o n
TC	a	-120	Spray shows little effect of air flow and no tendency to diffuse throughout chamber.
	b	-300	
	c	-340	Spray diffusing throughout chamber. Chamber slightly fogged. Chamber fogged throughout, fogging taking place very rapidly.
	d		
	e		
	f		
	g		

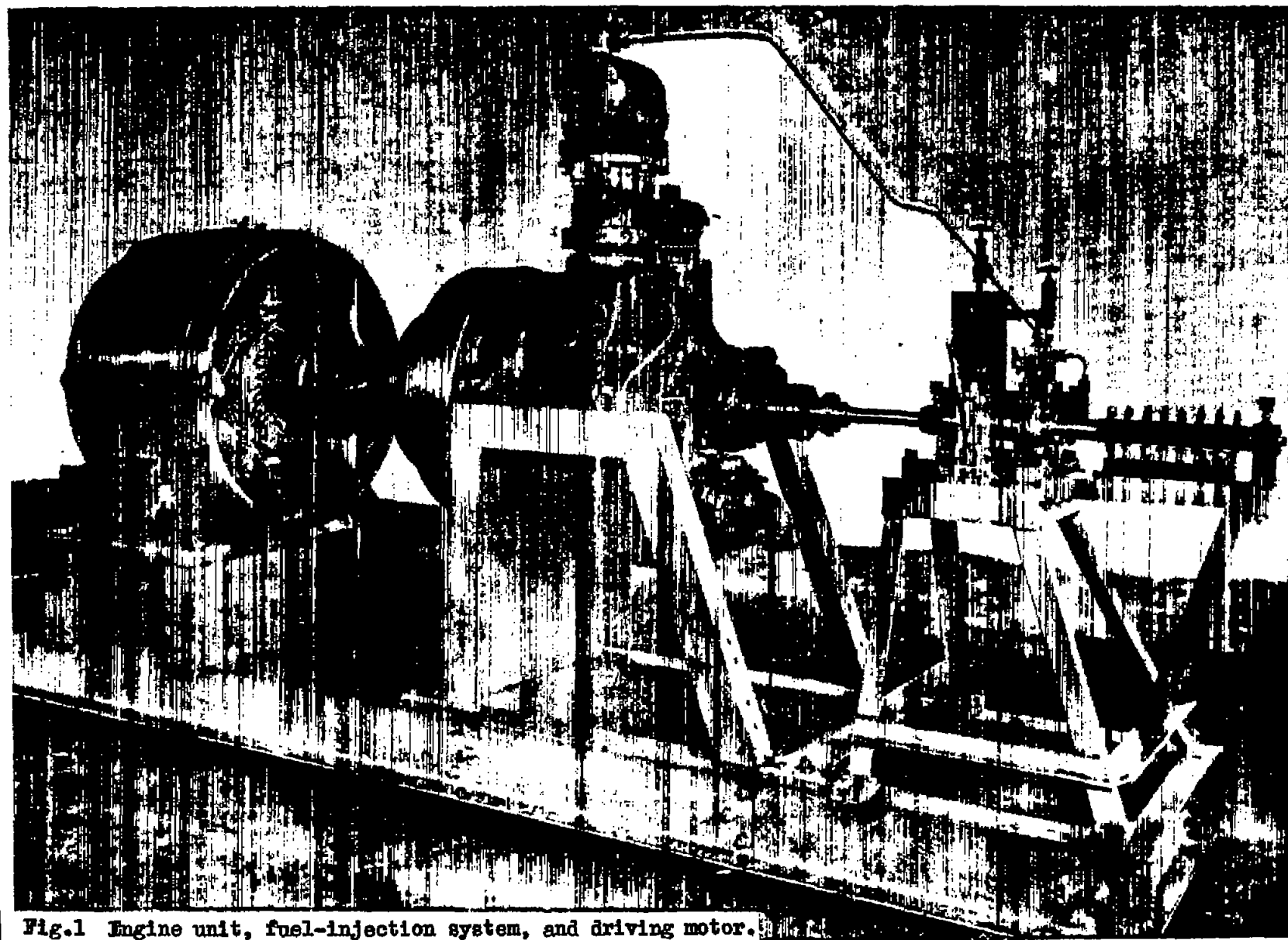

Fig.1 Engine unit, fuel-injection system, and driving motor.

N.A.C.A. Technical Note No.389

Fig.1

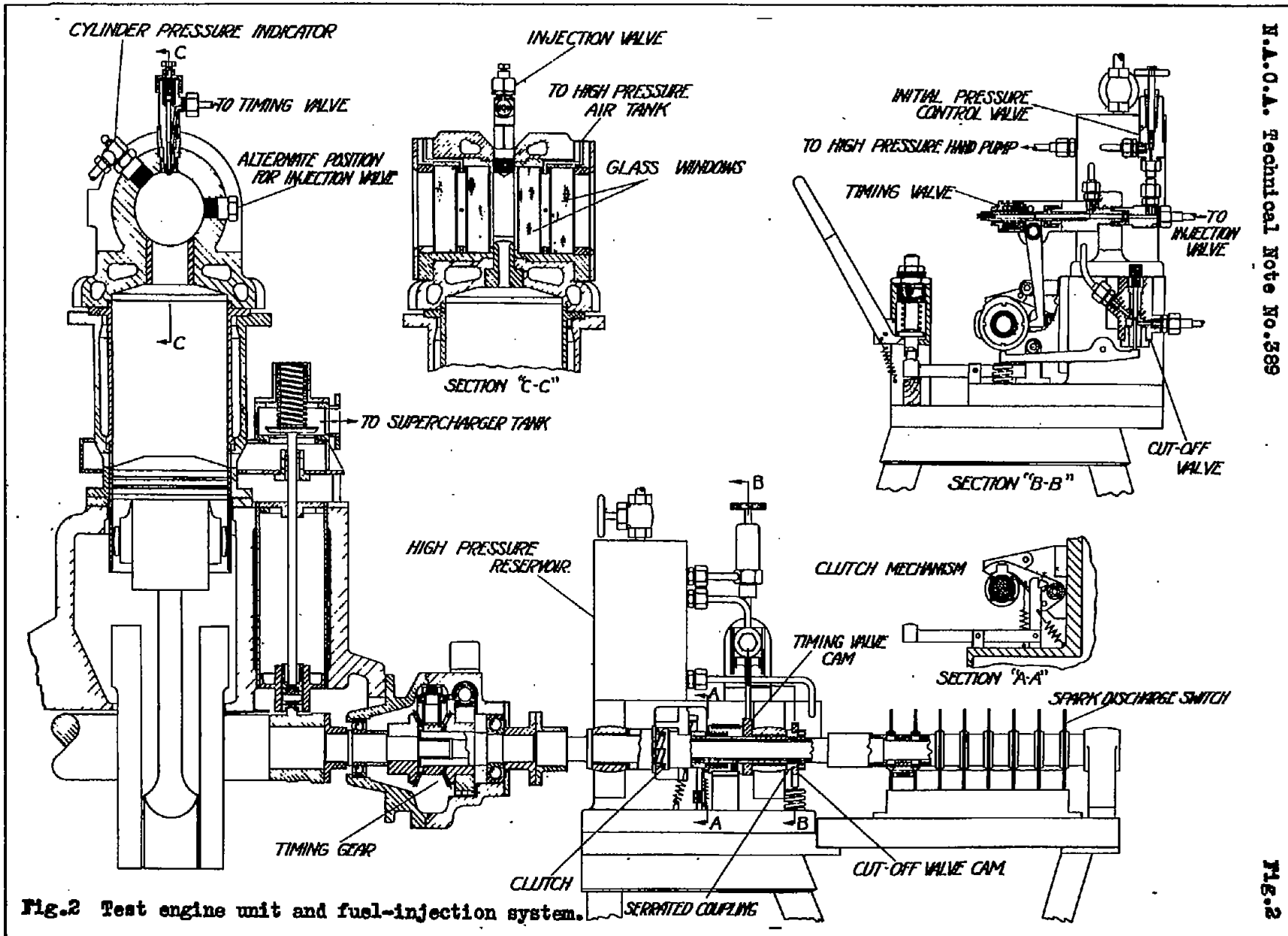
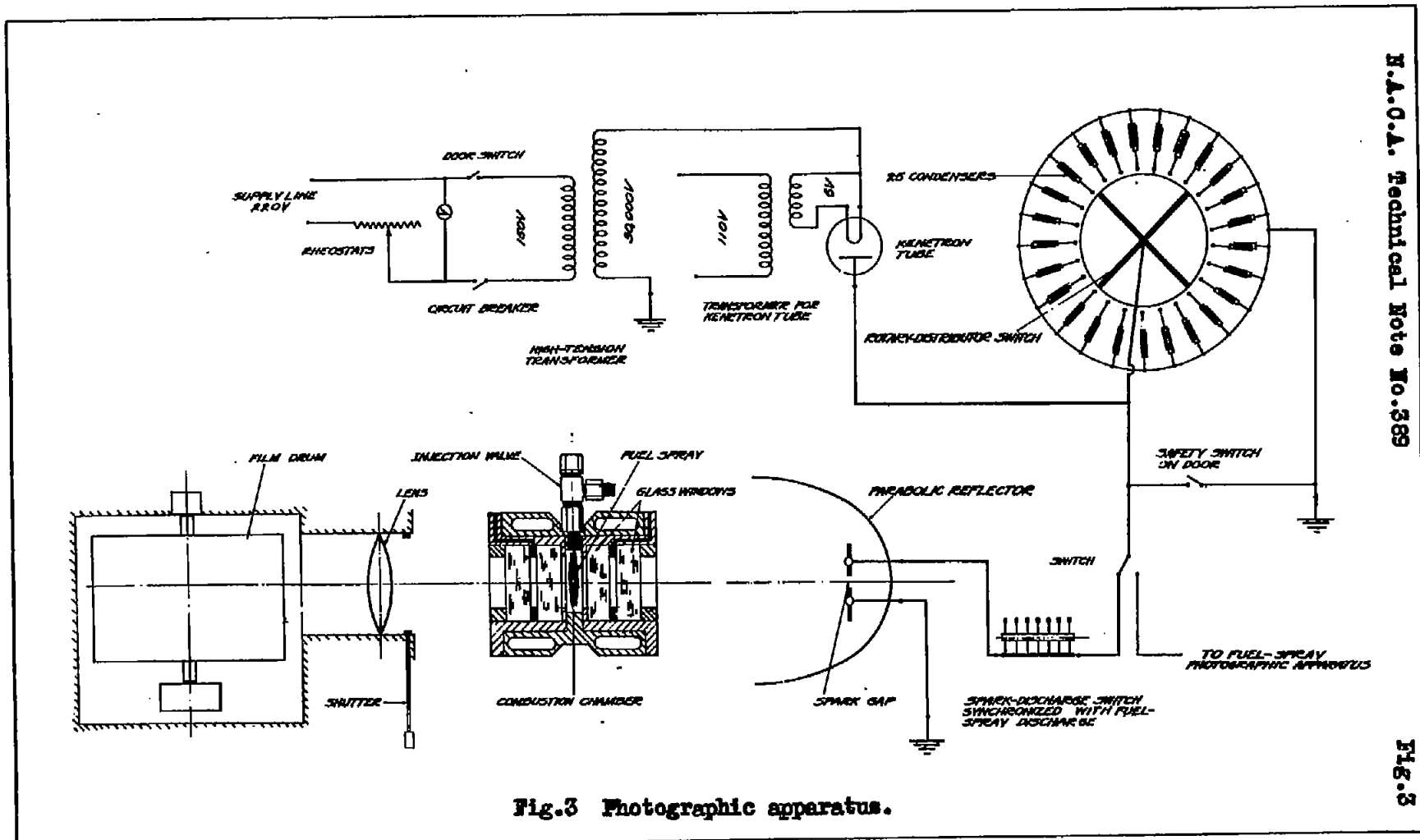

Fig.2 Test engine unit and fuel-injection system.

N.A.O.A. Technical Note No. 389

Fig.2



N.A.O.A. Technical Note No. 389

Fig. 3

Fig. 3 Photographic apparatus.

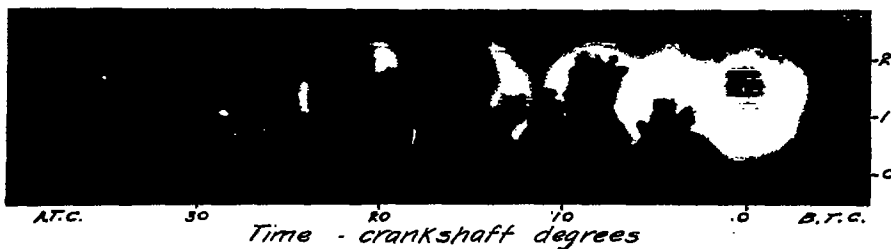
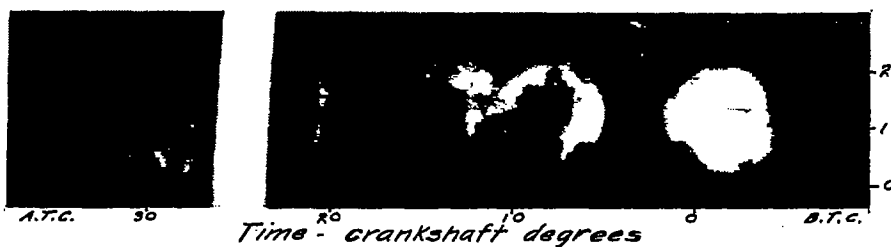
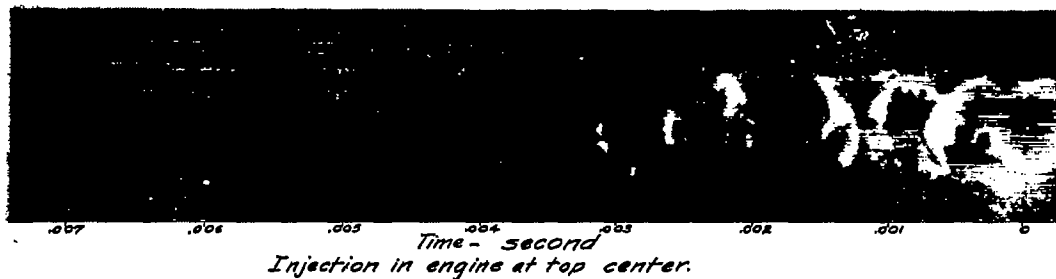
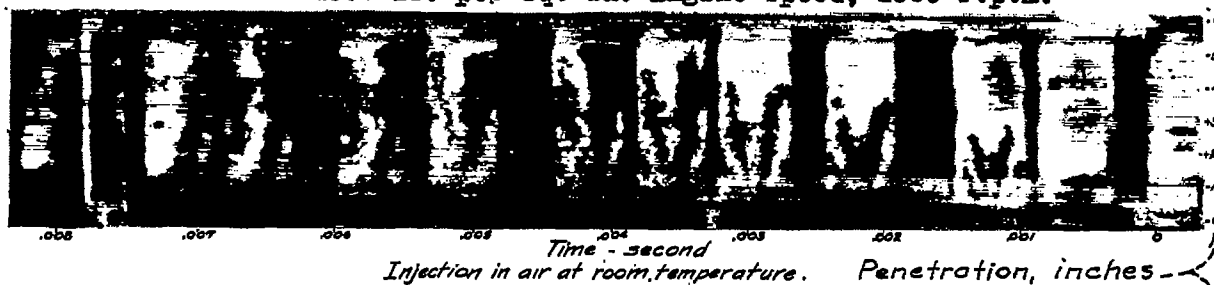
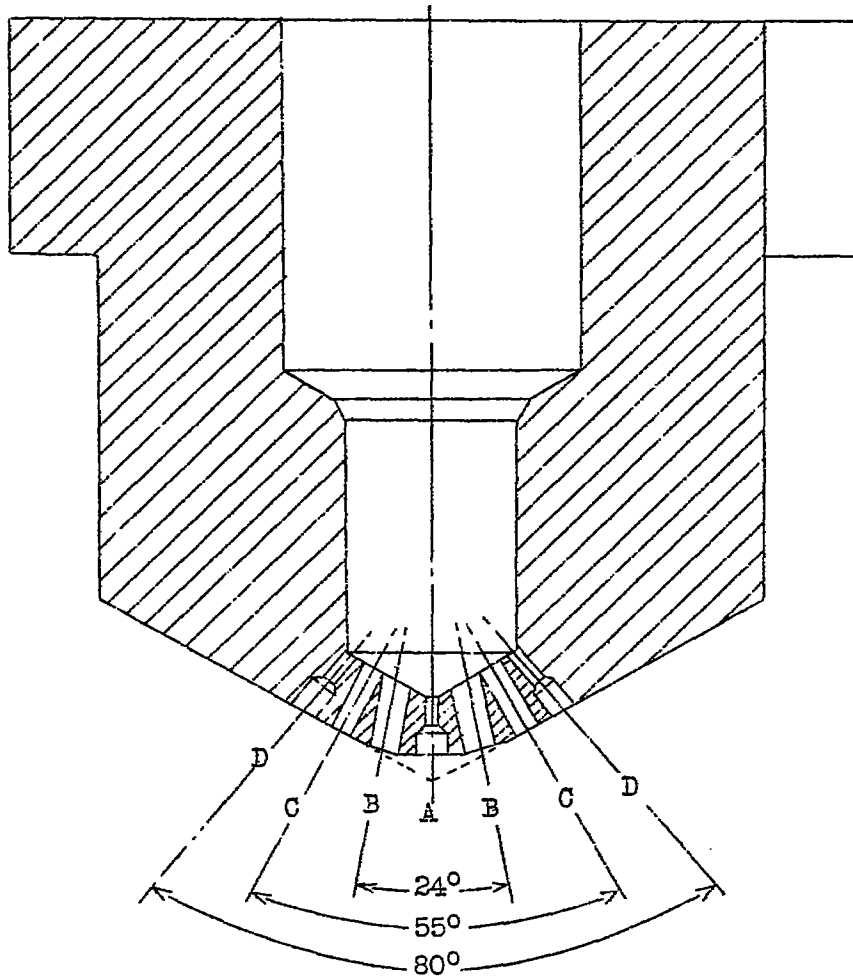

Fig. 4 Reproducibility of fuel spray. Injection valve in horizontal position. Injection pressure, 4000 lb. per sq. in. Engine speed, 1500 r.p.m.



Injection valve in horizontal position. Engine speed 1500 r.p.m.

Fig. 6 Effect of temperature on fuel spray. Injection pressure, 4000 lb. per sq. in. Air density, 1.1 lb. per cu. ft.



Nozzle No.18

Orifice	Diameter	Length
A	.007	.014
B	.018	.036
C	.012	.024
D	.010	.020

Nozzle No.17

C	.005	.010
---	------	------

Fig.5 Multiorifice nozzles.

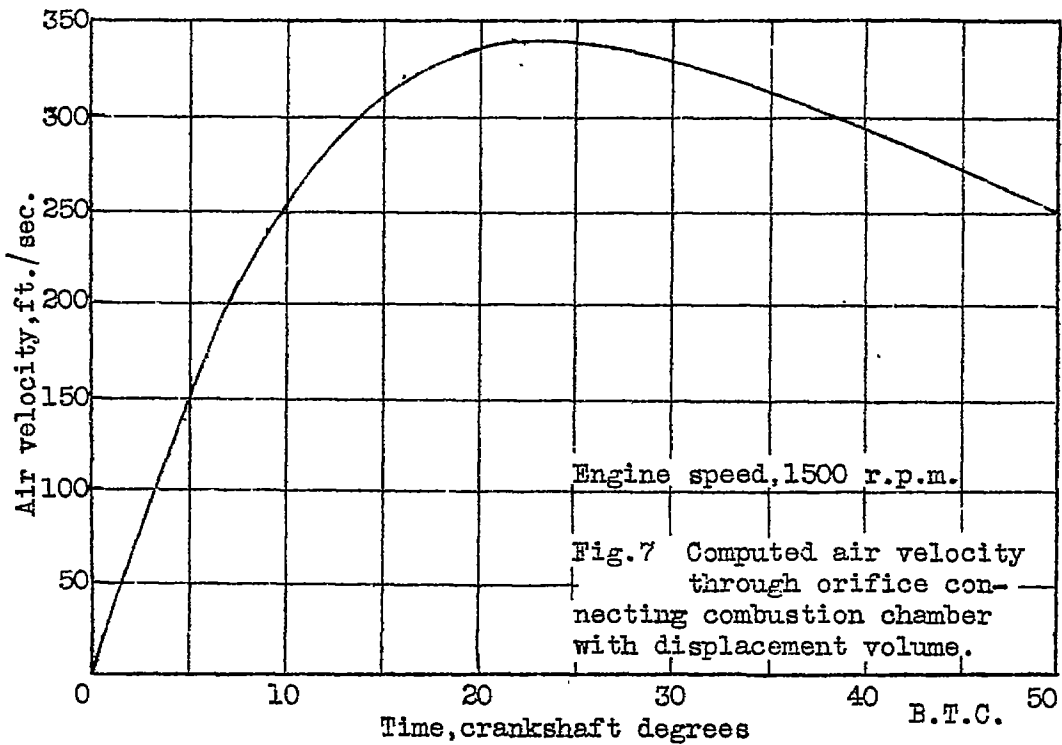
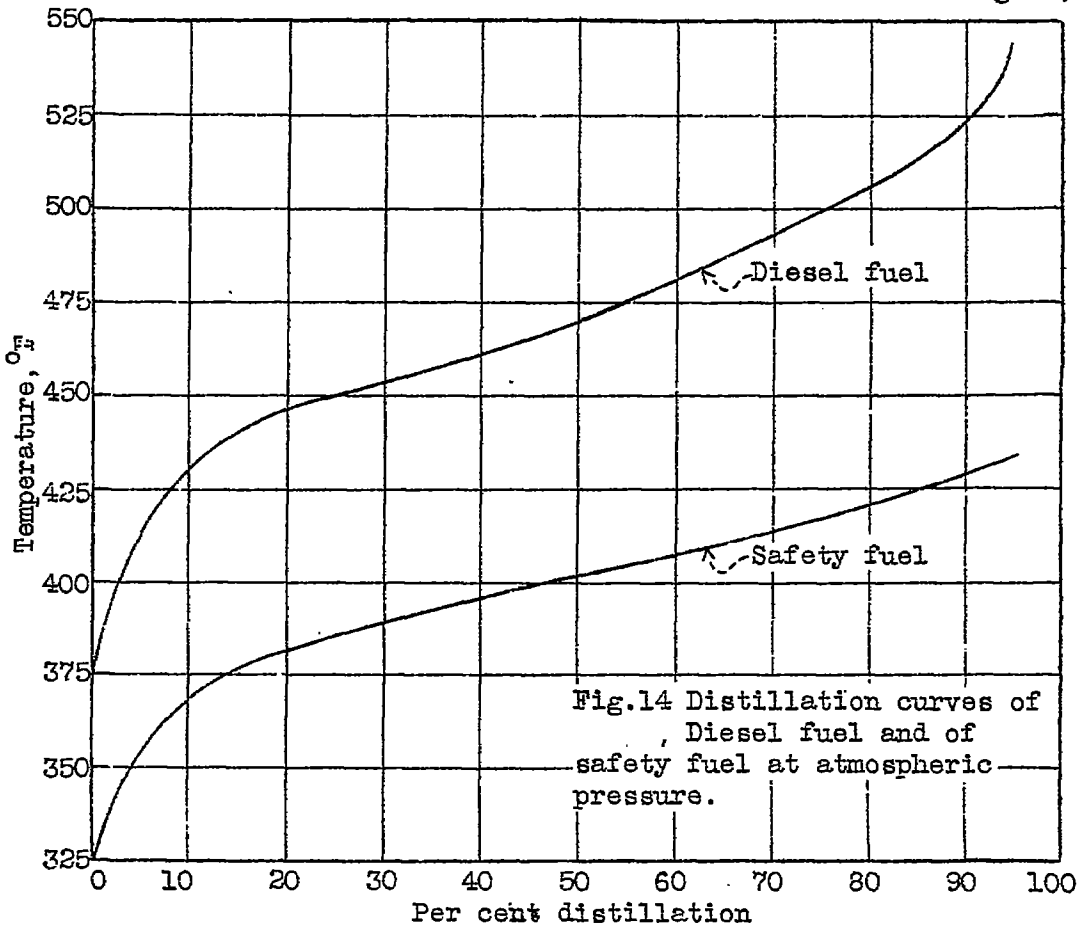

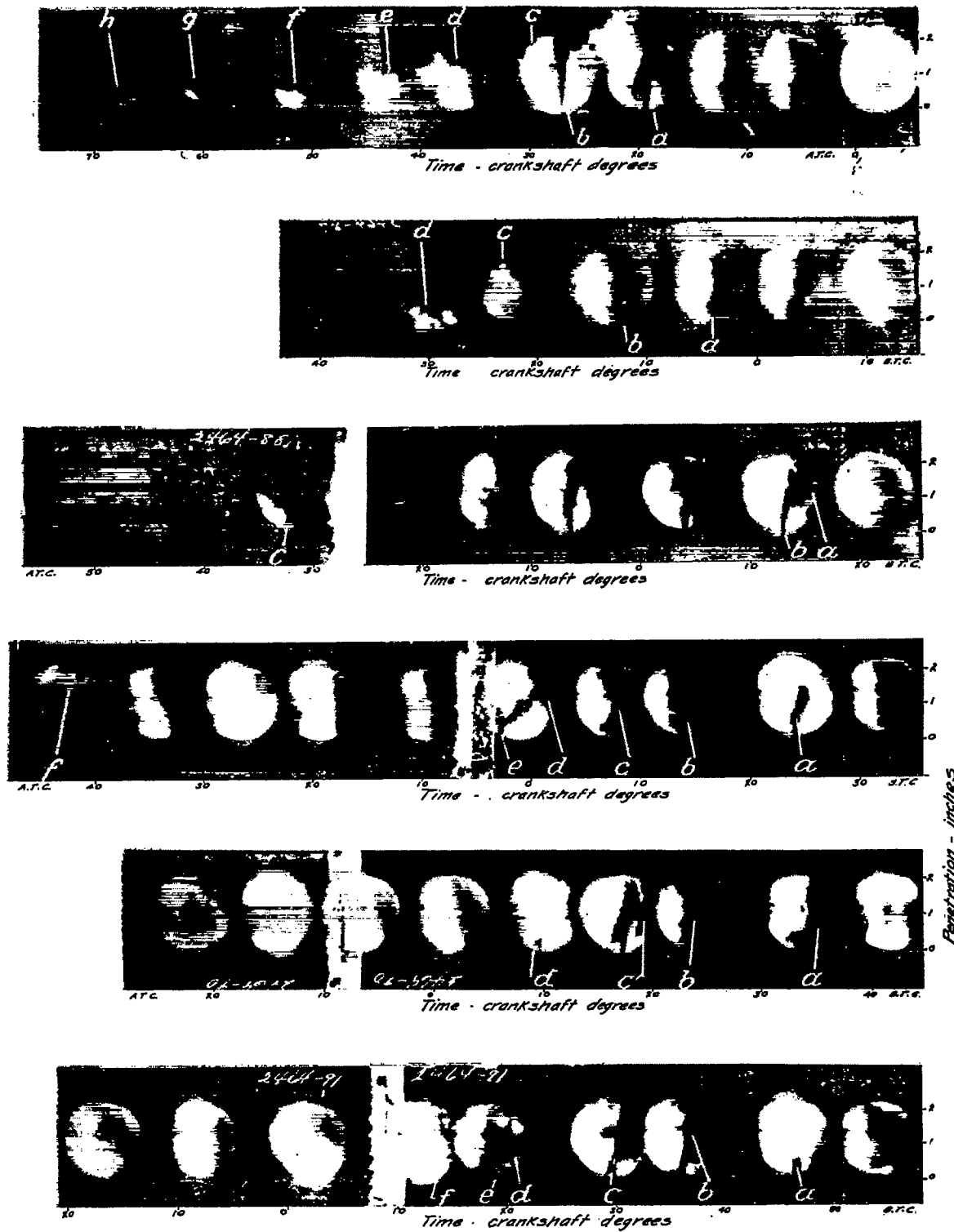

Fig. 8 Effect of air flow on the fuel spray. Injection valve in horizontal position. Injection pressure, 4000 lb./sq. in. Engine speed, 1500 r.p.m.

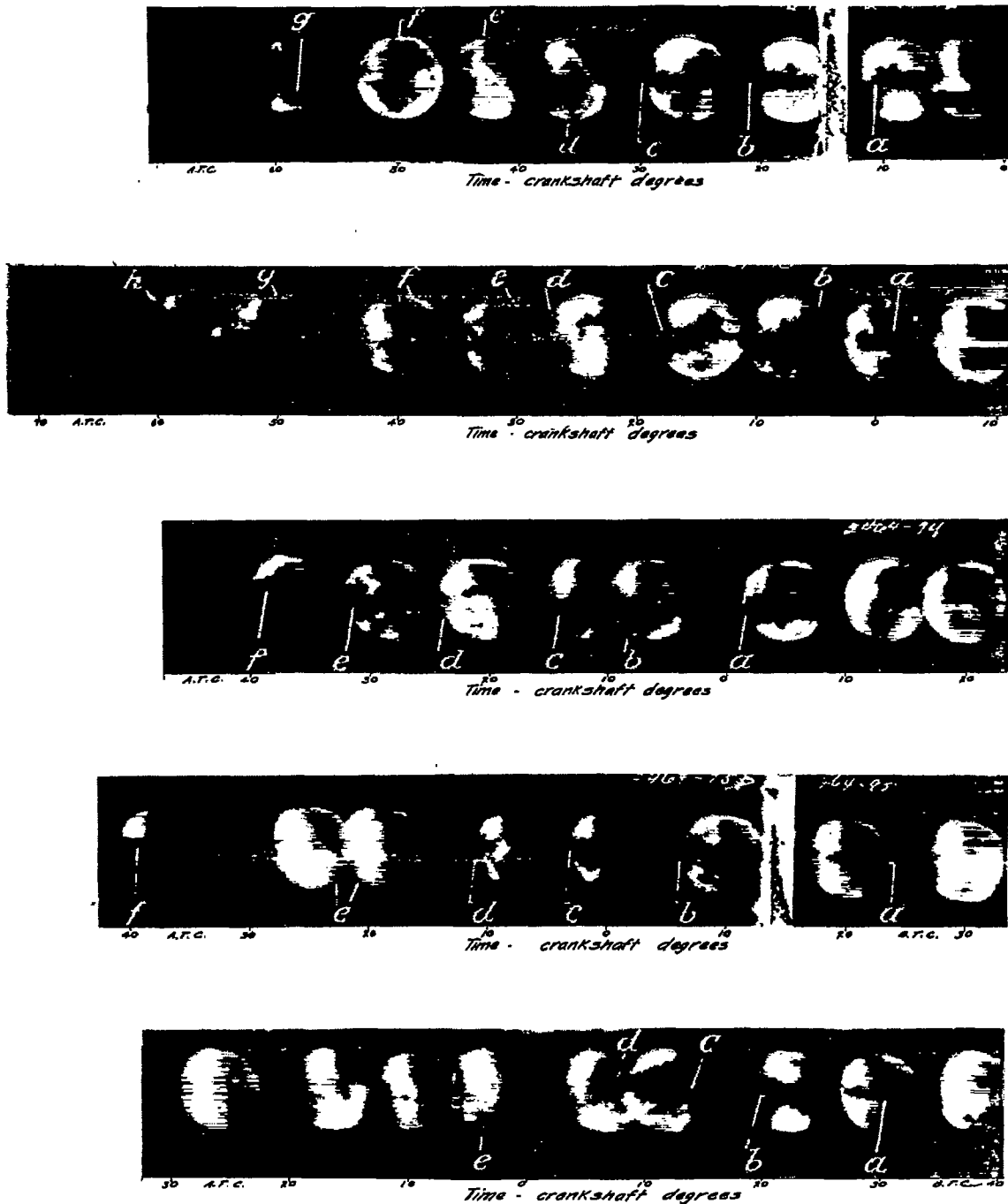

Fig. 9 Effect of air flow on the fuel spray. Injection valve in vertical position. Injection pressure, 4000 lb./sq.in. Engine speed, 1500 r.p.m.



Time - crankshaft degrees.



Time - crankshaft degrees.

Injection valve in vertical position.



Time - crankshaft degrees.



Time - crankshaft degrees.

Penetration - inches.

Fig.10 Effect of position of injection valve on the fuel spray. Injection pressure 4000 lb./sq.in. Engine speed, 1500 r.p.m.

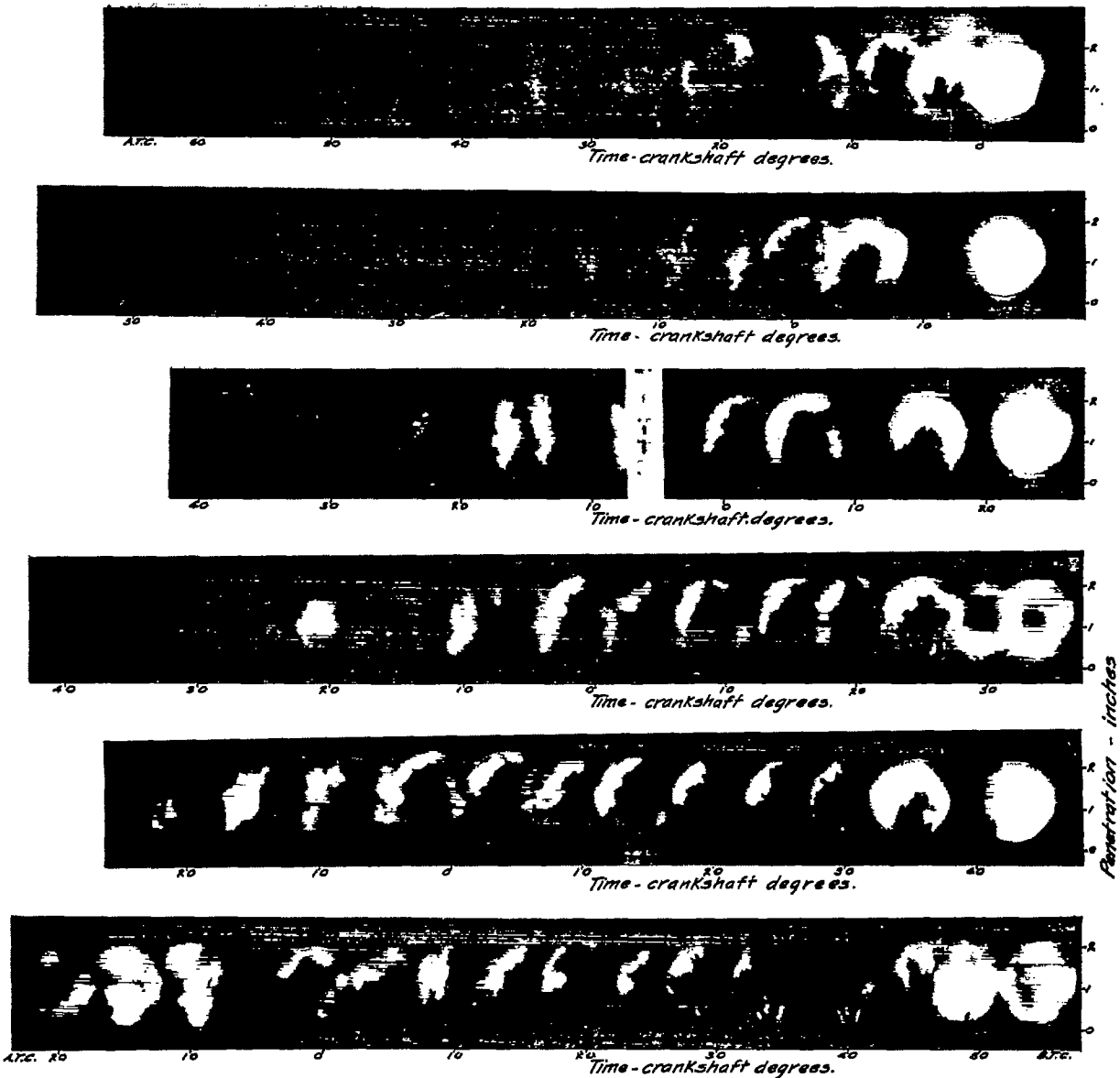

Fig. 11 Effect of air flow on the fuel spray. Injection valve in horizontal position. Injection pressure 4000 lb./sq. in. Engine speed, 1500 r.p.m.

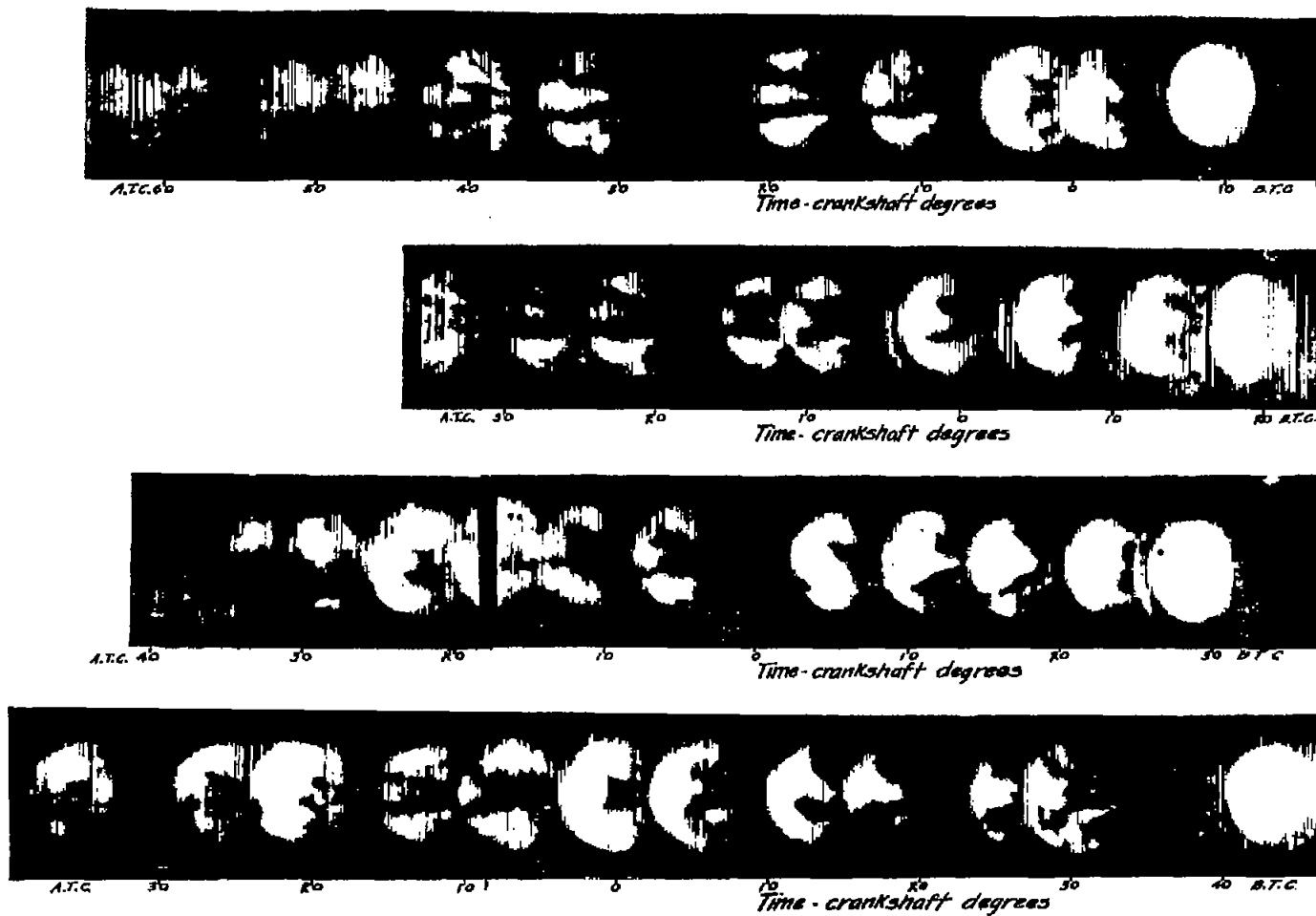
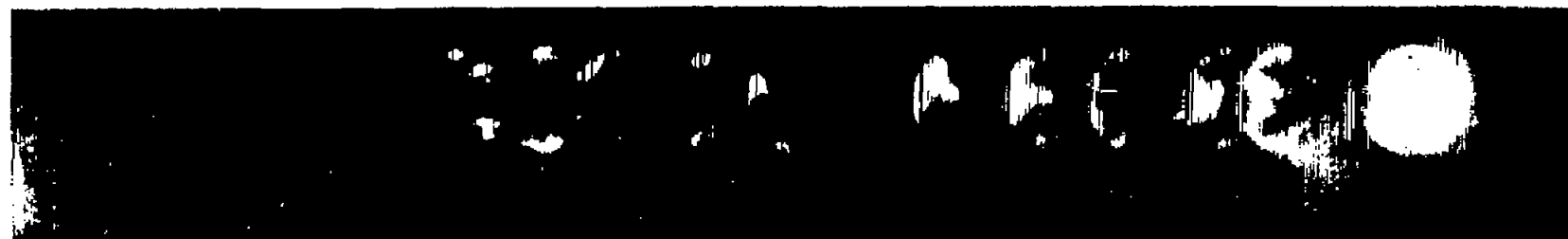

Fig.12 Effect of air flow on the fuel spray. Injection valve in vertical position. Injection pressure, 4000 lb./sq. in. Engine speed, 1500 r.p.m. Safety fuel.



60 A.T.C. 40 30 20 10 0 10 20 30 D.T.C.

Time - crankshaft degrees

Diesel oil



50 A.T.C. 40 30 20 10 0 10 20 30 D.T.C.

Time - crankshaft degrees

Safety fuel

Fig. 13 Effect of physical properties of fuel on spray formation. Injection valve in vertical position. Injection pressure, 4000 lb. per sq. in. Engine speed, 1500 r.p.m.

R.A.O.A. Technical Note No. 389

Fig. 13

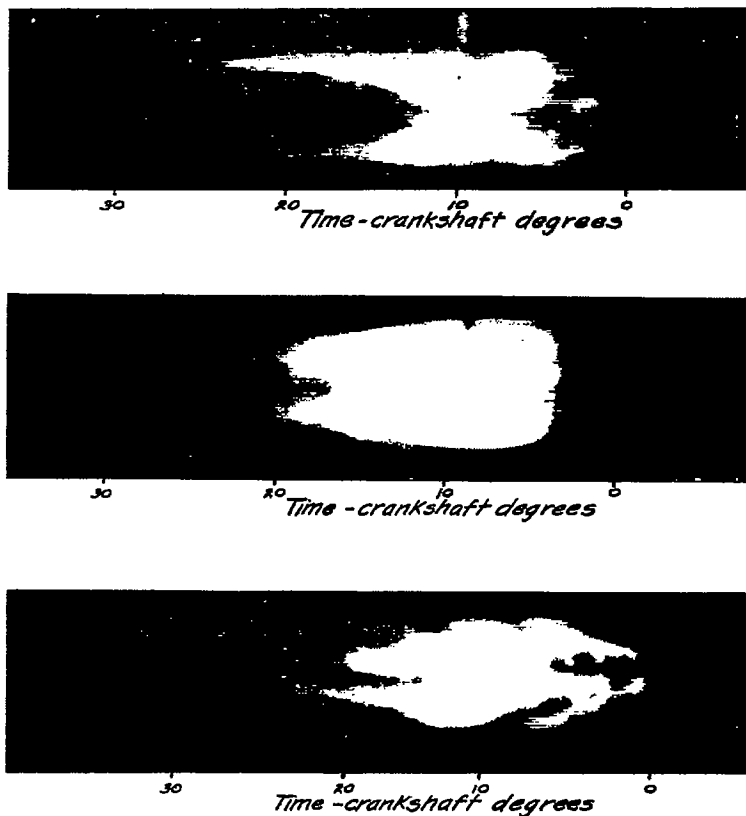

Fig. 15 Combustion with ignition lag of several engine revolutions. Injection valve in vertical position. Injection pressure, 4000 lb. per sq. in. Engine speed, 1500 r.p.m.

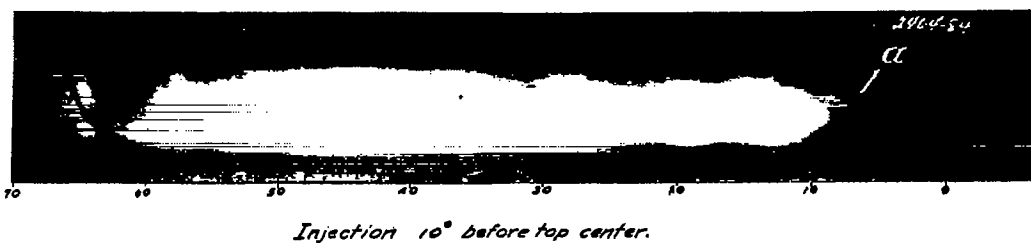

Fig. 16 Combustion starting at fuel spray. Injection valve in vertical position. Injection pressure, 4000 lb. per sq. in. Engine speed, 1500 r.p.m.