

10 1931

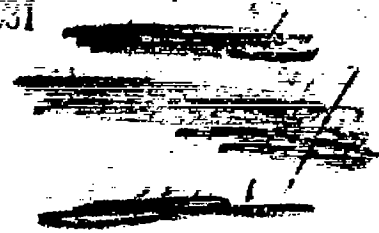

*Library L.M.A.L.*

TECHNICAL NOTES

NATIONAL ADVISORY COMMITTEE FOR AERONAUTICS

\_\_\_\_\_  
No. 398  
\_\_\_\_\_

THE EFFECT OF SLOTS AND FLAPS ON THE LIFT  
AND DRAG OF THE MCDONNELL AIRPLANE AS  
DETERMINED IN FLIGHT

By Hartley A. Soule  
Langley Memorial Aeronautical Laboratory

**FILE**

Langley Memorial Aeronautical Laboratory

Washington  
November, 1931



NATIONAL ADVISORY COMMITTEE FOR AERONAUTICS

TECHNICAL NOTE NO. 398

THE EFFECT OF SLOTS AND FLAPS ON THE LIFT AND  
 DRAG OF THE McDONNELL AIRPLANE AS DETERMINED  
 IN FLIGHT

By Hartley A. Soule

Summary

This note contains the results of flight tests conducted by the National Advisory Committee for Aeronautics on a low-wing monoplane equipped with leading-edge slots extending over the entire wing and flaps extending only to the ailerons, to find their effect on the lift and drag characteristics of the airplane. Curves are given showing the lift and drag characteristics of the airplane for the following conditions of the slots and flaps: slots closed and flaps neutral; slots open and flaps neutral; slots closed and flaps down; and slots open and flaps down. In addition, the high and low speeds in level flight and the climbing characteristics are given.

The results show that the slots used alone increase the maximum lift coefficient 54 per cent; the flaps alone increase it 38 per cent; and the slots and flaps in combination give a total increase in lift coefficient of 94 per cent. The slots and flaps in combination decrease the landing speed from 60 to 43 m.p.h.; increase the speed range of the airplane 40 per cent; and increase the ~~glide~~<sup>glide</sup> angle at landing speed  $4.2^\circ$ .

Introduction

It is generally recognized that one of the most important problems now confronting aeronautical engineers is to improve the airplane in such a manner as to increase the safety of flight. The National Advisory Committee for Aeronautics has realized this and is now engaged in a very extensive program of research, including both wind-tunnel and

flight testing, for the express purpose of increasing the safety of airplanes.

From the standpoint of the aerodynamics of the airplane, it appears that the most promising immediate line of attack is to find means of decreasing the landing and take-off speeds and of providing adequate control and stability at the attitudes corresponding to these speeds. Because of their known ability to increase the maximum lift coefficient, slots and flaps present one very promising method of accomplishing this object.

As a part of its general research on safety, the Committee has therefore undertaken to investigate the aerodynamic, performance, landing, take-off, stability, maneuverability, and control characteristics of an airplane equipped with slots and flaps so that the influence of these devices could be appraised, not only with respect to safety but also with regard to performance in general. This investigation is now in progress on the McDonnell airplane, which was originally designed for entry in the Daniel Guggenheim Safe Aircraft Competition. Some preliminary information, the presentation of which is the object of this report, has been obtained to date.

These preliminary data consist of lift and drag characteristics; slot behavior or operation; and certain performance data, including minimum speed, high speed, ~~stall~~ glide angles, and climb characteristics. These results were obtained, in general, with four combinations of slot and flap setting; slots open and closed, with flaps neutral; and slots open and closed, with flaps depressed. Measurements were made according to methods commonly in use by the Committee.

### The Airplane

A three-view drawing and photographs showing the general arrangement of the McDonnell airplane are given in Figures 1 to 4, inclusive. The principal features of the airplane are given in the following table:

Type - Low-wing tractor monoplane.  
Seating arrangement - Two-place, tandem, open cockpit.

General Characteristics

span	- 35 ft.	over-all length	- 21 ft. 4 in.
chord (c)	- 5 ft. 8 in.	height	- 7 ft. 2½ in.
area <sup>1</sup>	- 196.5 sq.ft.	engine	- Warner "Scarab" rated 110 hp at 1,850 r.p.m.
aspect ratio	- 6.2	weight (test)	- 1,800 lb.
wing section	- M-6	power loading	- 16.3 lb./hp
dihedral	- 4.5°	wing loading	- 9.1 lb./sq.ft.

Slot and Flap Dimensions

span of auxiliary airfoil	31 ft. 7½ in.
chord of auxiliary airfoil	10.2 in.; 15% c.
span of flaps	22 ft. 4-1/8 in.
chord of flaps	17-7/6 in.; 25.6% c.
flap angle when fully depressed	40°

Location of Auxiliary Airfoil with Slot Open  
(See fig. 5.)

width	5.43 in.; 8% c.
depth	2.38 in.; 3.5% c.
gap	1.02 in.; 1.5% c.

The auxiliary, or leading-edge, airfoil is divided into four sections along the span, two on each side of the fuselage. Normally, these auxiliary airfoils are automatic in action, although, in order to allow testing with slots

<sup>1</sup>\* The area was computed to include the projected plan area of the fuselage bounded by the wing roots and the leading and trailing edges extended. Thus it differs from that published elsewhere, viz., 180 sq.ft.

<sup>2</sup>\* Value given is that used in tests. Flaps designed for 50° travel but air loads prevent full movement in flight.

opened or closed at all angles of attack, means were provided to lock them in either the full-open or closed position.

The flaps extend along the entire trailing edge with the exception of the part occupied by the ailerons and are manually operated from the pilot's cockpit. They are interconnected with the stabilizer. Means are provided, however, for adjusting the stabilizer independently of the flaps.

The airplane, as originally designed and constructed, was equipped with wheel fairings, landing-gear strut fairings, and N.A.C.A. cowling. These items were not included when the airplane was delivered to the Committee, and the subject tests were made without them.

#### Tests and Test Methods

A complete description of the methods and apparatus used in these tests will be given in a later report dealing with the complete investigation. Only a brief description of the method is given here.

Lift and drag characteristics.— The lift and drag characteristics were measured for each of the following slot and flap arrangements:

1. Slots closed and flaps neutral.
2. Slots open and flaps neutral.
3. Slots closed and flaps down.
4. Slots open and flaps down.

The characteristics were determined by means of glide tests, which are described in detail in reference 1. Briefly, the glide-test procedure is as follows:

The airplane is flown in a steady glide with the propeller operating approximately at  $V/nD$  for zero thrust. During the glide, simultaneous records are taken of the flight-path angle, the indicated air speed, the angle of inclination of the wing chord, the engine speed, and the temperature and pressure of the air at the altitude of the airplane. The weight of the airplane during the glide is known. From the weight, and the flight-path angle, the components of force acting perpendicular to and parallel to the flight path are calculated. The indicated air speed is corrected to true air speed by means of the pressure and

temperature data. Propeller thrust is calculated from the r.p.m., the true air speed, air density, and propeller characteristics. The drag component, as calculated from the weight and flight-path angle, is then corrected for the component of thrust acting along the flight path, and also for the drag of the apparatus used to measure flight-path angle and air speed. Similar corrections to the lift component are neglected.

From the lift and corrected drag components thus found, the corresponding coefficients are calculated according to the relations,

$$C_L = \frac{L}{q S}$$

and,

$$C_D = \frac{D}{q S}$$

in which the symbols have their standard significance. Angle of attack is taken as the difference between the angle of the flight path and the angle of inclination of the wing chord.

Slot operation.- The angle of attack at which the slot starts to open was determined by flying the airplane at high speed and then slowly increasing the angle of attack until the auxiliary airfoils began to move out. Records of the air speed and angle of attack were obtained at this point with the same apparatus used in the glide tests. The angle of attack was then further increased until the auxiliary airfoils reached the full-out position. At this point, records were again taken. The slot operation was determined both with the flaps neutral and with the flaps depressed.

Performance.- The performance characteristics measured consisted of the minimum speed in level flight, minimum speed in a glide, high speed, glide angle at minimum speed, minimum angle of glide, and rates and angles of climb.

For the measurement of the minimum speed in level flight and minimum speed in glide the same apparatus used in the glide tests was utilized, the only additional in-

strument required being a sensitive indicating altimeter to enable the pilot to maintain true level flight when required.

The high speed was determined for two conditions, namely, slots open, and slots closed; the flaps were neutral in each case. This determination was accomplished by timing the airplane over a measured speed course. Three runs were made in each direction for each condition, and the results for the six runs averaged. No corrections were made to standard atmospheric conditions, as the correction to the engine horsepower practically compensates for the correction to the air speed.

Climb characteristics were obtained for each slot and flap combination by measuring the air speed and flight-path angle in a series of climbs at different speeds, starting from 100 feet altitude.

Minimum angle of glide and glide angle at minimum speed were obtained as incidental results of the other tests

#### Precision

The instruments used in these tests are capable of measuring angles of the flight path and attitude of the airplane to within  $0.1^\circ$ , and air speed within 1 per cent. (Reference 2.) Such errors introduce approximately a 1 per cent error in the drag, and an inappreciable error in the lift. However, although all flights were made under the best obtainable air conditions, a small degree of atmospheric turbulence existed at all times. This instability in the atmosphere, in addition to a small but appreciable tendency for the airplane to oscillate, caused slightly irregular records of the angles measured, which are reflected in the dispersion of points in the results. The accuracy of the results is therefore somewhat reduced. It is estimated that lift and drag coefficients are correct to within  $\pm 3$  per cent, and angle of attack to within  $\pm 0.3^\circ$ .

The maximum and minimum speeds are correct to within  $\pm 1$  per cent. Angles of climb are estimated to be correct to within  $\pm 0.2^\circ$ , and the rate of climb to within  $\pm 3$  per cent.



### Discussion of Results

The results of the tests are given in Figures 6 to 15, and in Tables I and II. Figures 6 to 13 give the results, with experimental points, of the lift and drag measurements for the various slot and flap combinations. These results are presented as curves of lift and drag coefficient and L/D against angle of attack, and also in the form of polar curves. To facilitate comparison of the results with the different slot-flap combinations, the curves of  $C_L$  and  $C_D$  against  $\alpha$  for all cases have been reproduced, without the experimental points, in Figure 14. For the same reason, the polars have been grouped in Figure 15. The data from which the lift and drag curves were obtained are given in Table I.

Table II gives the results of the performance and slot-operation tests.

The lift and drag characteristics.— Referring to Figures 14 and 15, it will be noticed that in all cases the lift coefficient is still increasing when the curves are discontinued. This circumstance could not be avoided, because of the instability of the airplane at the higher angles of attack, and the consequent inability of the pilot to maintain steady conditions long enough to take records at these angles of attack. It is probable that the instability at high angles of attack was caused by a partial stall of the wings (burbles at the center portion) so that when instability was encountered the airplane was operating very close to its maximum lift. Consequently the values given for the maximum lift coefficients (highest points on the lift curves) are believed to be not more than 3 per cent lower than the true maximum lift coefficient.

With slots closed and flaps neutral, corresponding to the condition of no slots or flaps, the airplane has a maximum lift coefficient of 1.00 and a minimum drag coefficient of 0.08. The maximum lift coefficient compares favorably with the maximum lift coefficient of 1.113 obtained in the N.A.C.A. propeller-research tunnel on a 2-foot by 12-foot model of the M-6 airfoil, and at a Reynolds Number of about two-thirds that of the present tests. (Reference 3.) The difference between the two values is explained by the discontinuities in the wing surface of the airplane, caused by slot and flap installation, and



by the presence of the fuselage in the case of the airplane which makes close comparisons invalid. The minimum drag coefficient, 0.08, is rather high, compared with an average value of 0.06 for conventional airplanes in the same class. In this connection, however, the lack of landing-gear strut fairings, wheel fairings, and engine cowling during the tests, should be borne in mind.

In the following discussion of the improvements of the lift and drag characteristics obtained through the use of slots and flaps all comparisons are made with the condition of slots closed and flaps neutral. It should be realized that the results obtained by the use of slots and flaps will be different with different airfoils and that the percentages given cannot be taken as representing the increase to be expected from the installation of slots and flaps on any wing section.

With slots open and flaps neutral, the stall was delayed  $11^{\circ}$ , and the maximum lift coefficient was increased to 1.54, or 54 per cent. This increase represents a 19 per cent reduction in landing speed. On the other hand, the minimum drag coefficient with slots locked open was increased 10 per cent. This means that the sacrifice of the movable or automatic feature of the slots, in favor of simplified construction, with slots of this type, would require a 10 per cent increase in power to maintain the speed range possible with the slots automatic.

With slots closed and flaps down, the maximum lift coefficient was increased from the basic value of 1.00 to 1.38, or 38 per cent. At the same time, the angle of attack of maximum lift coefficient was lowered  $2^{\circ}$  from the original value, and the angle of zero lift was lowered  $6^{\circ}$ . Although the minimum drag was greatly increased with flaps down, no significance is attached to this result, as there is no reason for using the flaps at the low angles of attack.

With slots open and flaps down, the maximum lift coefficient reached its highest value, 1.94. It is of interest to note that the sum of the increases in  $C_{L_{max}}$  resulting from the use of slots and flaps separately is 92 per cent, as compared with the total increase of 94 per cent when the slots and flaps are used together. This result would indicate that the effects of slots and flaps are almost independent of one another.

In considering the possible use of auxiliaries such as slots and flaps to decrease the landing speed, it is worth while to analyze the drag at maximum lift, with regard to its effect on the power required to maintain level flight. Such an analysis has been made for the several slot-flap combinations of the subject tests, using the formula,

$$\frac{P}{P_0} = \frac{C_D}{C_{D_0}} \left( \frac{C_{L_0\max}}{C_{L\max}} \right)^{3/2}$$

where,

- P - power required for minimum speed level flight with auxiliaries.
- P<sub>0</sub> - power required for minimum speed level flight without auxiliaries.
- C<sub>D</sub> - drag coefficient at maximum lift with auxiliaries.
- C<sub>D<sub>0</sub></sub> - drag coefficient at maximum lift without auxiliaries.
- C<sub>L</sub> - maximum lift coefficient with auxiliaries.
- C<sub>L<sub>0</sub></sub> - maximum lift coefficient without auxiliaries.

The results of this analysis follow.

With slots alone, the increase from the basic condition in power required to maintain minimum horizontal speed is 8 per cent. With flaps alone, there is a decrease of 12 per cent. With slots and flaps together, the decrease is 4 per cent. This is an apparently favorable result. However, since the minimum speed is lowered 28 per cent with slots and flaps, there is a corresponding approximate 5 per cent decrease in the ratio V/nD at which the propeller operates, with a consequent reduction in propeller efficiency. Computations based on average propeller data show that the efficiency of the propeller is decreased by about 20 per cent, with a 5 per cent reduction in V/nD in the low-speed range. The power available at maximum C<sub>L</sub> may therefore not be sufficient to maintain level flight when using slots and flaps, unless steps are taken to increase the propeller efficiency at low speeds.

An inspection of the curves of Figures 7, 9, 11 and 13 shows that the maximum  $L/D$  is 5.8, a value which compares unfavorably with the average value of 8 for conventional airplanes. Here again, however, the absence of important fairings during the tests must be considered. Figures 7 and 9 also show that the maximum  $L/D$  with slots open and flaps neutral is the same as with slots closed and flaps neutral. Thus, it does not matter a great deal whether the auxiliary airfoil opens below or above the angle of maximum  $L/D$  for the unslotted wing.

Performance.- For the weight and drag as flown the airplane is somewhat underpowered as evidenced by the low rate of climb, 310 feet per minute. As a result the performance as such is not impressive. However, for the purpose of these tests the performance itself is of minor interest, the chief interest being in the difference of performance obtained with and without the slots and flaps in operation as is discussed in the following paragraphs.

It will have been noted that the actual take-off and landing speeds were not measured. The reason for this was that a direct measurement would have required a calibration of the air-speed head mounted on the airplane, for which time was not available in this part of the investigation. With respect to the take-off speed, it so happens that the angles of attack at which the minimum speeds in level flight were attained with and without the slots and flaps in operation can be obtained with this airplane at take-off. It is possible, therefore, to use the minimum speeds in level flight for these conditions of slots and flaps as indicative of the corresponding take-off speeds, and they are used hereafter in place of the true take-off speeds. It is realized that this procedure does not give exact results because at take-off there must be some power available for climb and at minimum speed in level flight there is none, and also because of the influences of ground effect. However, it provides a satisfactory basis for the comparison of the effects of slots and flaps on take-off speed. With respect to the landing speed the minimum speed in a glide is the true landing speed for a landing which is made from a glide without leveling off, a type of landing which is entirely possible and is practiced with this airplane. The minimum speed in a glide is used in place of landing speed hereafter.

Without slots or flaps, the landing speed is 60 m.p.h. and the glide angle at this speed is  $13^\circ$ . Slots and flaps

reduce the landing speed to 43 m.p.h., and at the same time increase the angle to  $17.3^{\circ}$ . Thus, the slots and flaps have reduced the landing speed 17 m.p.h. and increased the angle of approach by  $4^{\circ}$  without increasing the vertical velocity. Without slots and flaps the take-off speed is 55 m.p.h. and with slots and flaps it is 40 m.p.h.

It is interesting to note that the minimum speed in level flight was 40 m.p.h. and occurred at an angle of attack of  $16.7^{\circ}$ , while the minimum speed in a glide was 43 m.p.h. and occurred at an angle of attack of  $23.7^{\circ}$ . The fact that a lower speed at a lower angle of attack was attained in the level flight condition is due to the slipstream effects. The fact that the highest angle of attack attained in level flight was  $16.7^{\circ}$ , while the maximum lift occurred at an angle of attack of  $23.7^{\circ}$ , shows that the airplane has insufficient power available to take full advantage of the use of slots and flaps to decrease the minimum speed in level flight. It follows that if the airplane had sufficient power to maintain level flight at maximum lift and had a higher landing gear so as to take off at a higher angle of attack it would be possible to appreciably decrease the take-off speed.

The high-speed runs with slots closed and slots locked open, indicate the effect of sacrificing the movable or automatic feature of the slots in favor of simplified construction. With slots closed, the high speed was 91.4 m.p.h., and with slots fixed open it was 84.8 m.p.h. This reduction of 6.6 m.p.h. in the high speed is probably sufficient justification for the use of the automatic or movable feature for this particular design of slot. It should be appreciated, however, that it is possible to design fixed slots which will not have such an unfavorable effect on high speed. (Reference 4.)

The speed ranges given in Table II are all based on the high speed with the slots closed and the flaps neutral. The low speeds used are those obtained in the glides, as they are more indicative of the wing improvement than the low speeds in level flight, where the propeller characteristics are a consideration. The use of slots and flaps increases the speed range 40 per cent, the slots accounting for a 25 per cent and the flaps a 17 per cent increase.

The results of the climb tests show nothing of particular interest, other than that the climb is poor.

To summarize, the results show that the slots used alone increase the maximum lift coefficient 54 per cent, the flaps alone increase it 38 per cent, and the slots and flaps in combination give a total increase in maximum lift coefficient of 94 per cent. The slots and flaps in combination decrease the landing speed from 60 to 43 m.p.h., increase the speed range of the airplane 40 per cent, and increase the glide angle at landing  $4.2^{\circ}$ .

Langley Memorial Aeronautical Laboratory,  
National Advisory Committee for Aeronautics,  
Langley Field, Va., October 13, 1931.

#### References

1. Green, K. W.: Determination of the Lift and Drag Characteristics of an Airplane in Flight. T.N. No. 223, N.A.C.A., August, 1925.
2. Thompson, F. L., and Keister, P. H.: Lift and Drag Characteristics of a Cabin Monoplane Determined in Flight. T.N. No. 362, N.A.C.A., January, 1931.
3. Wood, Donald H.: Tests of Large Airfoils in the Propeller Research Tunnel, Including Two With Corrugated Surfaces. T.R. No. 336, N.A.C.A., May, 1929.
4. Weick, Fred E., and Wenzinger, Carl J.: The Characteristics of a Clark Y Wing Model Equipped with Several Forms of Low-Drag Fixed Slots. T.R. No. 407, N.A.C.A., August, 1931.





*all negative*

N.A.C.A. Technical Note No. 398

Continuation of Table I

McDONNELL GLIDE TESTS

											Slots open and flaps neutral												
1	2	3	4	5	6	7	8	9	10	11	12	13	14	15	16	17	18	19	20	21	22		
Slots open	Flaps neutral																						
29-1	8.4	-15.3	23.7	0.965	0.264	1827	1760	482	538	27.30	69	0.0684	74.0	11.2	0.82	0.004	0.004	7	7	480	1.50	0.408	
2	6.3	-13.1	19.4	.974	.227	1819	1770	413	6.76				78.8	11.7	.83	.003	.003	5	8	410	1.33	.308	
3	4.6	-11.5	16.7	.980	.199	1811	1770	360	7.54				83.2	12.9	.80	.006	.006	5	8	360	1.19	.243	
4	3.2	-10.2	13.4	.984	.177	1803	1775	319	8.83				88.0	13.4	.82	.004	.004	6	9	316	1.07	.191	
5	2.6	-10.0	10.6	.985	.174	1795	1770	312	10.04				97.0	14.2	.85	.001	.001	6	2	302	.90	.153	
6	-2.5	-10.6	8.1	.983	.184	1787	1750	328	13.00				109.2	15.5	.87	.001	.001	-3	3	312	.68	.122	
7	-4.1	-11.4	7.3	.981	.198	1779	1740	352	14.44				115.0	16.9	.85	.001	.001	-3	12	341	.61	.121	
8	-7.8	-12.8	5.0	.975	.222	1771	1730	392	18.58				130.5	18.5	.87	.001	.001	-3	14	375	.47	.103	
9	-12.7	-15.3	2.6	.965	.264	1763	1700	465	26.32				155.5	22.4	.86	.0	.0	0	15	349	.33	.087	
30-1	8.9	-15.4	24.3	.964	.266	1786	1720	474	5.82	27.30	66	.0689	74.0	11.4	.81	.005	.005	6	9	473	1.50	.413	
2	6.9	-13.3	20.2	.973	.230	1780	1730	409	6.29				77.0	12.1	.79	.007	.007	7	7	411	1.40	.332	
3	5.1	-12.4	17.5	.977	.215	1774	1730	381	6.92				81.0	12.1	.83	.003	.003	3	7	377	1.28	.280	
4	3.9	-10.9	14.8	.982	.189	1768	1740	334	7.70				85.1	12.9	.82	.004	.004	6	9	331	1.15	.219	
5	2.5	-10.4	12.9	.984	.181	1762	1730	319	8.53				89.6	13.1	.85	.001	.001	2	9	312	1.03	.186	
6	1.8	-9.9	10.7	.985	.172	1756	1730	311	9.57				95.0	14.1	.83	.003	.003	4	10	305	.92	.158	
7	-2.6	-10.2	7.6	.984	.181	1750	1720	316	12.7				109.5	15.3	.88	.002	.002	-5	13	298	.69	.119	
8	-4.7	-10.8	6.1	.982	.187	1744	1710	326	14.6				117.5	16.9	.86	.0	.0	-5	14	312	.59	.109	
9	-8.5	-12.7	4.2	.976	.220	1738	1700	382	19.1				134.0	18.9	.88	.002	.002	-6	15	361	.45	.096	
15-1	9.3	-15.0	24.3	.966	.259	1780	1720	460	5.72	27.30	70	.0683	73.6	12.0	.76	.010	.010	13	7	454	1.53	.404	
2	8.4	-14.1	22.5	.970	.244	1750	1695	427	5.72				73.6	11.9	.77	.009	.009	11	7	423	1.51	.377	
3	18.8	-14.6	23.4	.968	.232	1720	1665	433	5.62				72.9	12.2	.75	.011	.011	15	7	425	1.51	.385	
16-3	8.7	-14.7	23.4	.967	.254	1832	1770	465	5.77	27.30	75	.0676	73.6	12.0	.76	.010	.010	13	6	458	1.55	.404	
4	8.8	-14.9	23.7	.965	.257	1808	1765	464	5.62				71.3	12.4	.77	.004	.004	18	6	452	1.58	.409	
5	7.6	-14.1	21.7	.970	.244	1784	1730	435	6.08				73.6	12.2	.75	.011	.011	15	6	426	1.45	.356	
Slots closed and flaps down											Slots closed and flaps down												
23-1	-6	-12.5	11.9	.976	.216	1876	1830	405	6.97	27.30	70	.0683	81.0	12.8	.78	.007	.007	11	8	408	1.34	.298	
2	-3	-12.2	12.5	.975	.222	1850	1800	411	6.86				80.5	13.0	.77	.008	.008	11	8	416	1.33	.309	
3	-4.7	-11.5	6.8	.980	.199	1837	1800	366	8.06				87.2	13.1	.82	.004	.004	5	9	362	1.14	.229	
4	-10.3	-12.3	2.0	.977	.213	1811	1770	386	11.85				105.7	15.9	.83	.003	.003	7	12	381	.76	.164	
24-3	8	-13.3	14.1	.973	.230	1780	1730	409	6.40	27.30	71	.0682	78.0	12.9	.76	.010	.010	15	7	417	1.38	.332	
4	-10.2	-12.0	1.8	.977	.208	1750	1710	364	11.5				104.5	15.5	.83	.003	.003	15	7	357	.75	.157	
5	-12.6	-13.0	4	.974	.225	1740	1700	392	13.6				113.6	17.0	.83	.003	.003	8	11	387	.84	.145	
6	-15.8	-14.4	-1.4	.969	.249	1730	1680	430	16.4				125.0	18.9	.82	.004	.004	14	14	427	.52	.132	
7	-20.6	-17.4	-3.2	.954	.299	1710	1650	511	24.1				151.2	22.7	.87	.004	.004	14	16	509	.34	.107	
8	-20.6	-17.4	-3.2	.954	.299	1710	1650	511	24.1				151.2	22.7	.87	.004	.004	14	16	509	.34	.107	
9	-20.6	-17.4	-3.2	.954	.299	1710	1650	511	24.1				151.2	22.7	.87	.004	.004	14	16	509	.34	.107	
10	-20.6	-17.4	-3.2	.954	.299	1710	1650	511	24.1				151.2	22.7	.87	.004	.004	14	16	509	.34	.107	
11	-20.6	-17.4	-3.2	.954	.299	1710	1650	511	24.1				151.2	22.7	.87	.004	.004	14	16	509	.34	.107	
12	-20.6	-17.4	-3.2	.954	.299	1710	1650	511	24.1				151.2	22.7	.87	.004	.004	14	16	509	.34	.107	
13	-20.6	-17.4	-3.2	.954	.299	1710	1650	511	24.1				151.2	22.7	.87	.004	.004	14	16	509	.34	.107	
14	-20.6	-17.4	-3.2	.954	.299	1710	1650	511	24.1				151.2	22.7	.87	.004	.004	14	16	509	.34	.107	
15	-20.6	-17.4	-3.2	.954	.299	1710	1650	511	24.1				151.2	22.7	.87	.004	.004	14	16	509	.34	.107	
16	-20.6	-17.4	-3.2	.954	.299	1710	1650	511	24.1				151.2	22.7	.87	.004	.004	14	16	509	.34	.107	
17	-20.6	-17.4	-3.2	.954	.299	1710	1650	511	24.1				151.2	22.7	.87	.004	.004	14	16	509	.34	.107	
18	-20.6	-17.4	-3.2	.954	.299	1710	1650	511	24.1				151.2	22.7	.87	.004	.004	14	16	509	.34	.107	
19	-20.6	-17.4	-3.2	.954	.299	1710	1650	511	24.1				151.2	22.7	.87	.004	.004	14	16	509	.34	.107	
20	-20.6	-17.4	-3.2	.954	.299	1710	1650	511	24.1				151.2	22.7	.87	.004	.004	14	16	509	.34	.107	
21	-20.6	-17.4	-3.2	.954	.299	1710	1650	511	24.1				151.2	22.7	.87	.004	.004	14	16	509	.34	.107	
22	-20.6	-17.4	-3.2	.954	.299	1710	1650	511	24.1				151.2	22.7	.87	.004	.004	14	16	509	.34	.107	
23-5	-7.2	-11.9	-4.5	.979	.203	1824	1790	371	9.72	27.30	70	.0683	95.7	14.0	.84	.002	.002	3	10	364	.91	.191	
7	-13.1	-12.9	-2	.975	.223	1798	1750	402	14.7				117.8	17.0	.85	.001	.001	2	14	390	.60	.134	
Slots open and flaps down											Slots open and flaps down												
15-2	6.3	-16.2	22.5	.961	.279	1765	1695	492	4.63	27.30	70	.0683	66.3	10.9	.76	.010	.010	11	6	497	1.86	.545	
4	6.6	-16.3	22.9	.960	.281	1735	1665	487	4.42				64.8	11.2	.72	.013	.013	15	5	497	1.91	.572	
16-2	6.4	-16.2	22.6	.960	.279	1846	1770	515	4.63	27.30	75	.0676	66.0	11.6	.70	.015	.015	18	4	529	1.95	.580	
4	6.4	-16.2	22.5	.961	.279	1820	1750	504	4.63				66.0	11.7	.70	.015	.015	19	4	519	1.92	.570	
6	6.4	-16.2	22.5	.961	.279	1750	1720	501	4.63				66.0	11.7	.70	.015	.015	19	4	517	1.90	.570	
8	6.5	-16.2	22.7	.960	.279	1772	1700	495	4.47				64.8	11.6	.69	.016	.016	19	4	510	1.94	.580	
17-1	8	-13.4	14.2	.973	.232	1853	1805	430	5.77	27.30	72	.0681	73.7	12.4	.74	.012	.012	17	7	440	1.59	.388	
2	-7	-11.8	7.1	.979	.204	1844	1805	377	7.64				84.8	14.0	.75	.011	.011	20	9	388	1.20	.259	
3	-12.0	-14.1	2.1	.970	.244	1835	1780	448	11.70				104.5	15.4	.85	.001	.001	2	12	478	.77	.208	
4	-7.4	-12.3	4.9	.977	.213	1826	1790	389	8.89				91.5	15.6	.74	.012	.012	28	10	407	1.02	.233	
5	-14.5	-14.9	4	.966	.257	1817	1755	467	14.25				116.0	17.9	.80	.006	.006	17	14	470	.63	.168	
6	-7	-12.5	11.8	.976	.216	1808	1765	391	6.79				76.4	12.4	.76	.010	.010	13	7	397	1.45	.327	
7	-4.7	-12.0	7.3	.978	.208	1799	1760	374	7.64				84.8	13.7	.77	.009	.009	15	10	380	1.17	.254	
8	-7.8	-12.5	4.7	.976	.216	1790	1750	386	9.10				92.6	14.6	.78	.008	.008	14	12	390	.98	.218	
9																							



TABLE II

Performance Characteristics of McDonnell Airplane

	Slots closed, flaps neutral	Slots open, flaps neutral	Slots closed, flaps down	Slots open, flaps down
High speed	91.4 m.p.h.	84.8 m.p.h.		
Minimum speed in glide (Landing speed)	60 m.p.h.	48 m.p.h.	51 m.p.h.	43 m.p.h.
Angle of attack at landing speed	16.2°	27.0°	14.2°	23.7°
<del>Angle of attack at landing speed</del> Angle of glide at landing speed	13.0°	17.3°	13.5°	17.2°
Vertical velocity at landing speed	19.8 ft./sec.	21.0 ft./sec.	17.5 ft./sec.	18.6 ft./sec.
Minimum speed in level flight (Take-off speed)	55 m.p.h.	44 m.p.h.	46 m.p.h.	40 m.p.h.
Angle of attack at take-off speed	13.0°	24.0°	11.3°	16.7°
<del>Minimum angle of glide</del>	9.8°	9.8°	11.5°	12.5°
Speed range	1.5	1.9	1.8	2.1

With Slots Automatic and Flaps Neutral

Maximum rate of climb	310 ft./min.
Maximum angle of climb	3.4°

Slot Operation

	Power on flaps neutral	Power on flaps down
Slots start to open	5.8° angle of attack	4.1° angle of attack
Slots fully open	10.1° " " "	8.7° " " "
Slots start to close	9.4° " " "	8.4° " " "
Slots fully closed	5.5° " " "	3.6° " " "

N.A.C.A. Technical Note No. 398

Table II

M.A.C.A. Technical Note No. 398

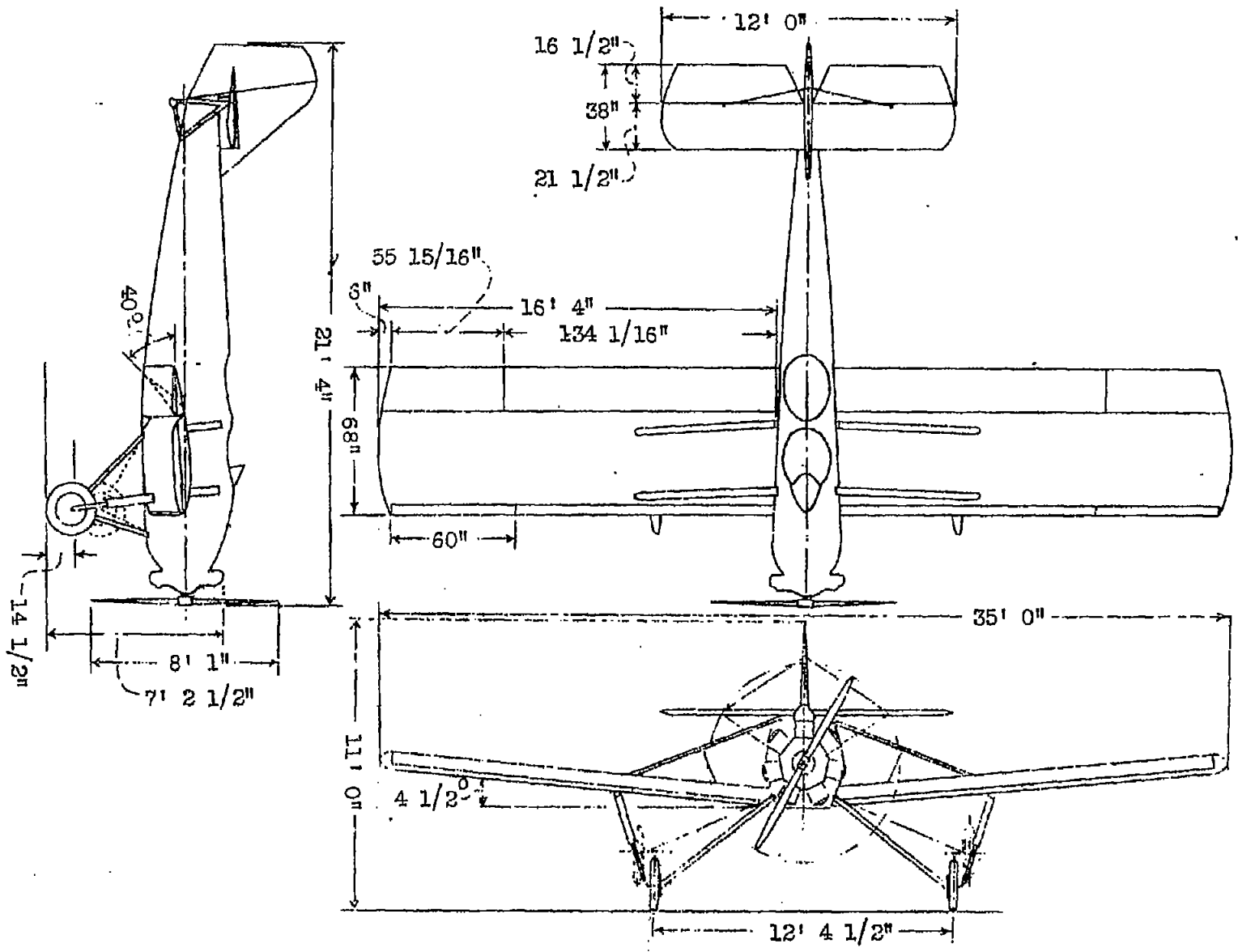

Fig. 1 Three-view drawing of the McDonnell airplane

Fig. 1

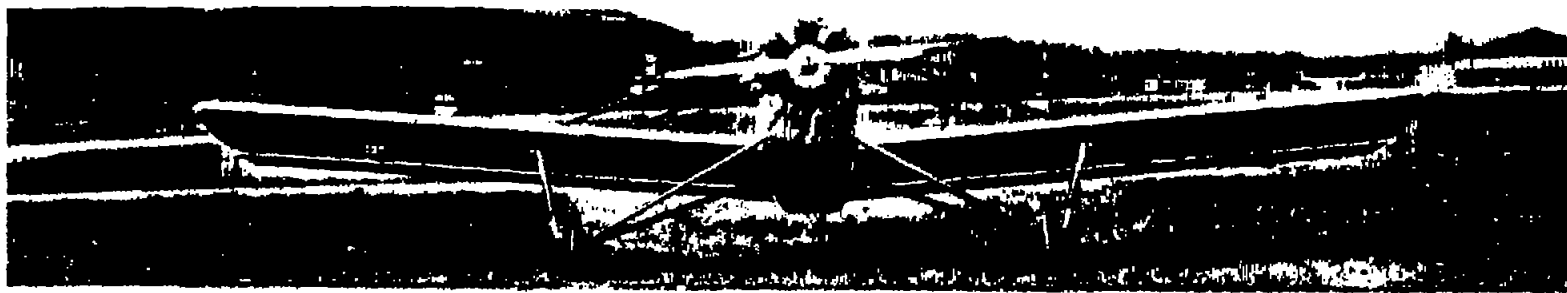

Fig. 2 Front view of the McDonnell airplane



Fig. 3 Three-quarter rear view of the McDonnell airplane

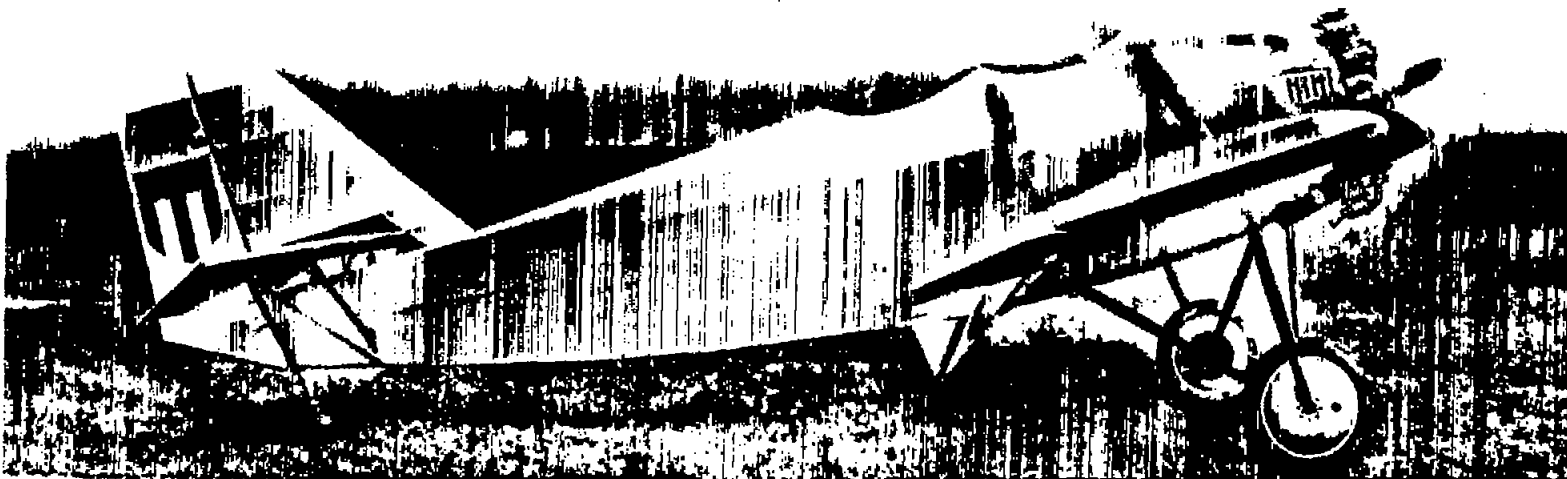

Fig. 4 Side view of the McDonnell airplane with the slots open and flaps down

N.A.C.A.  
Technical  
Note no. 398

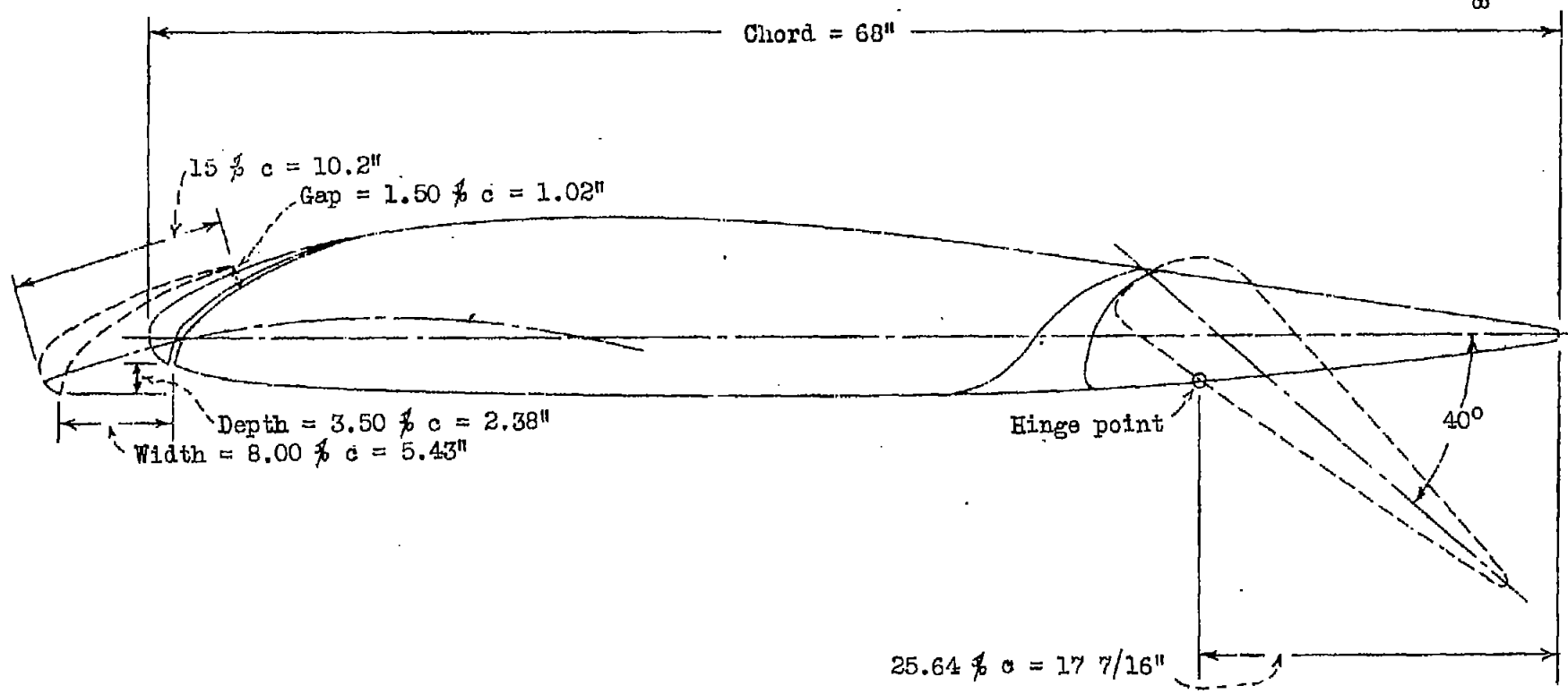

Fig. 5 M-6 wing section equipped with slots and flaps

Fig. 5

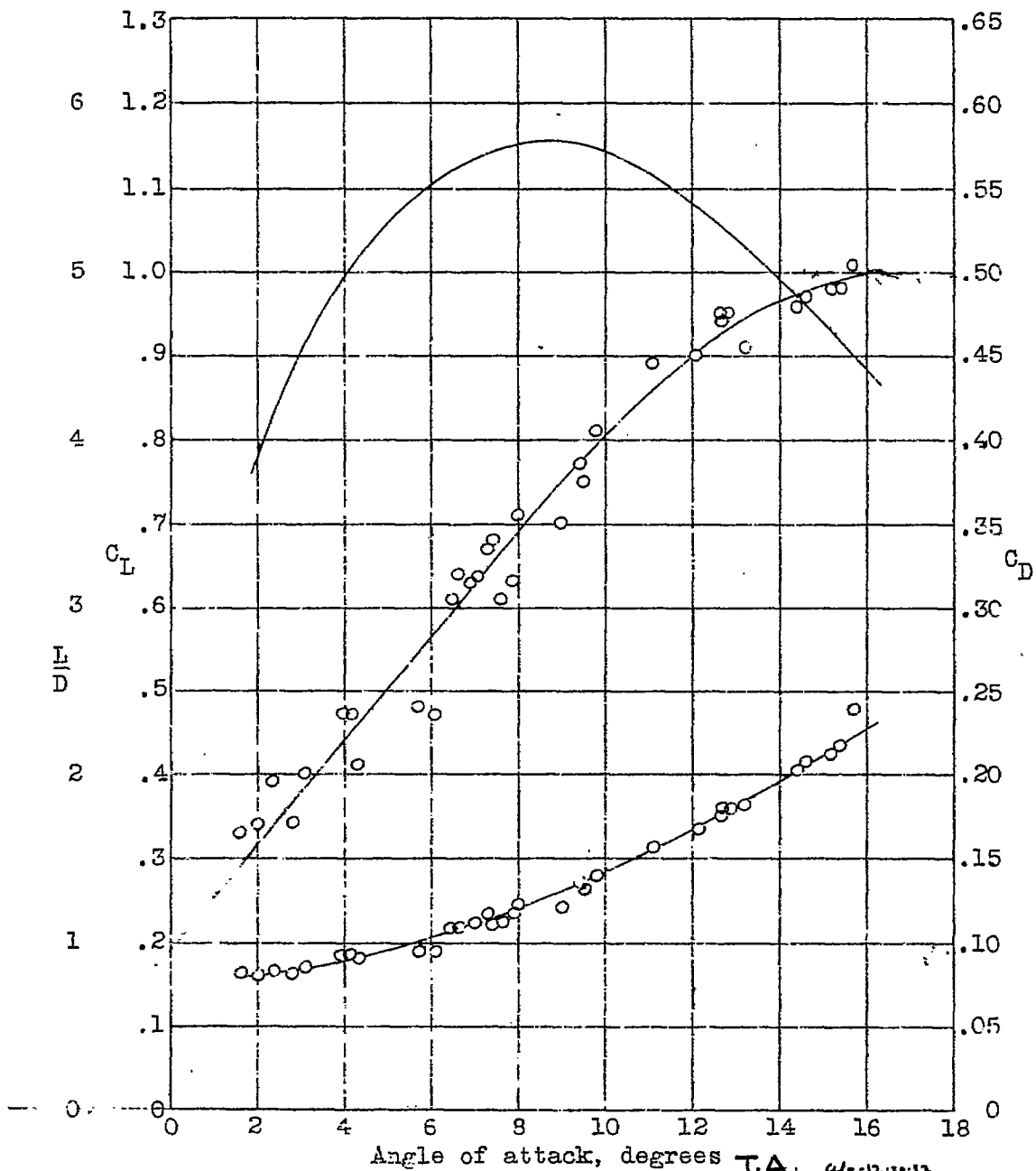

Fig. 6 Characteristic curves for the McDonnell airplane with slots closed and flaps neutral  
 T.A. 12-12-12

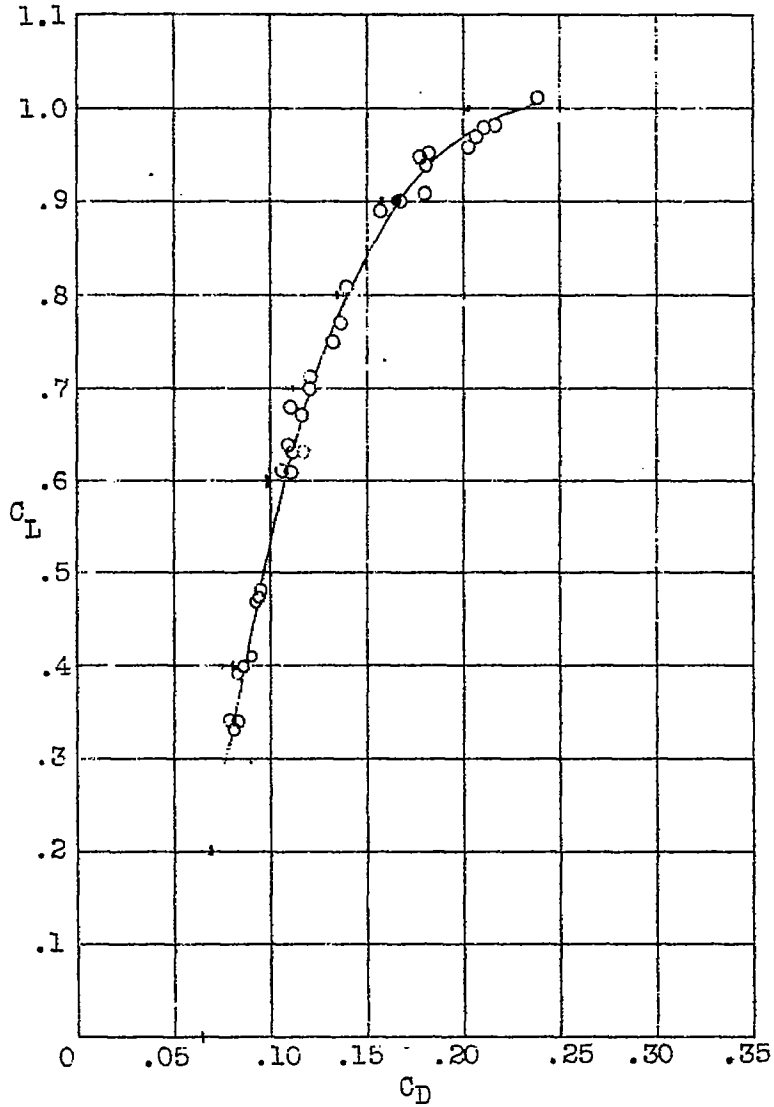

Fig. 7 Polar curve for the McDonnell airplane with slots closed and flaps neutral

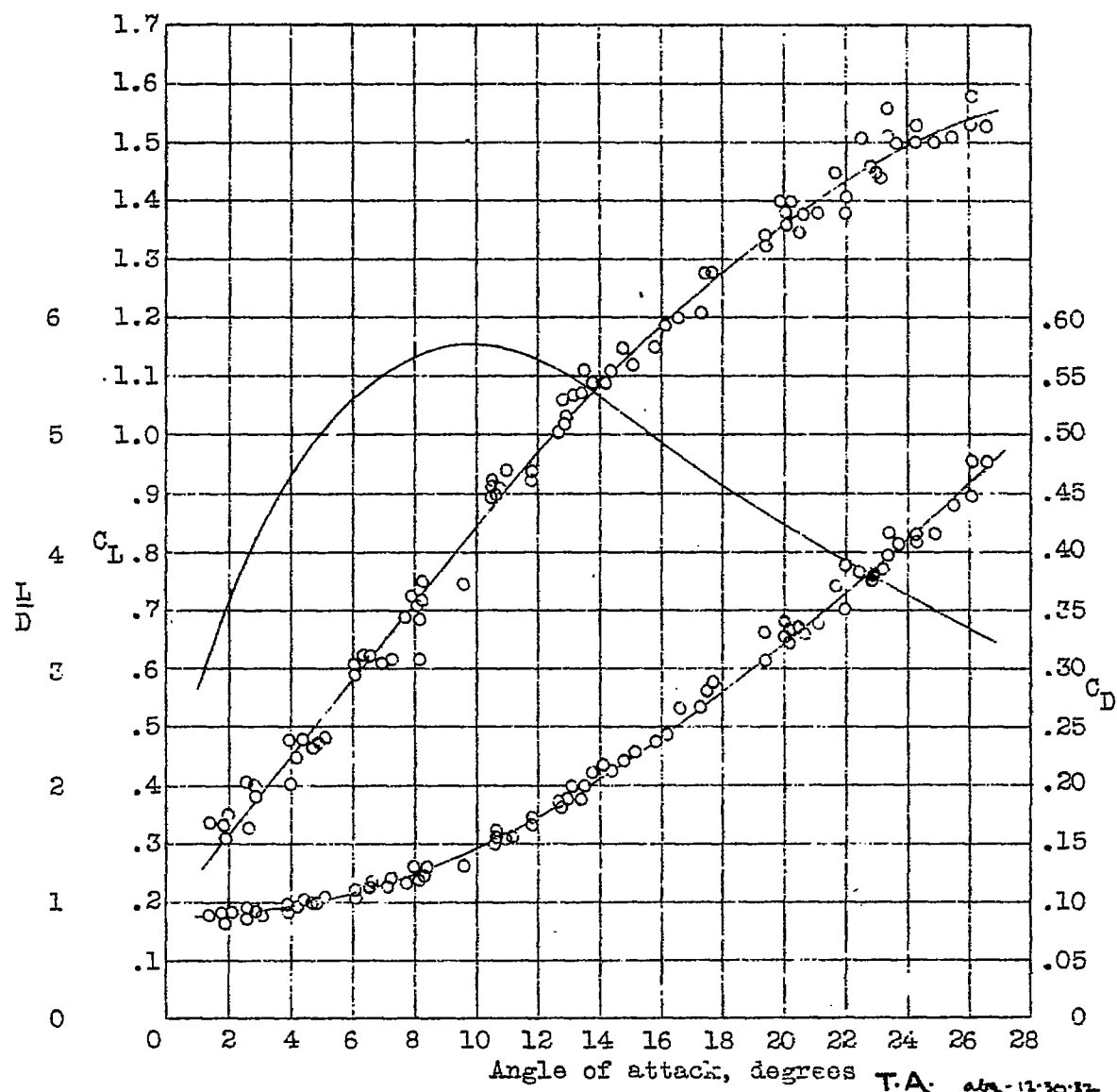

Fig. 8 Characteristic curves for the McDonnell airplane with slots open and flaps neutral  
 T.A. 26-11-30-12



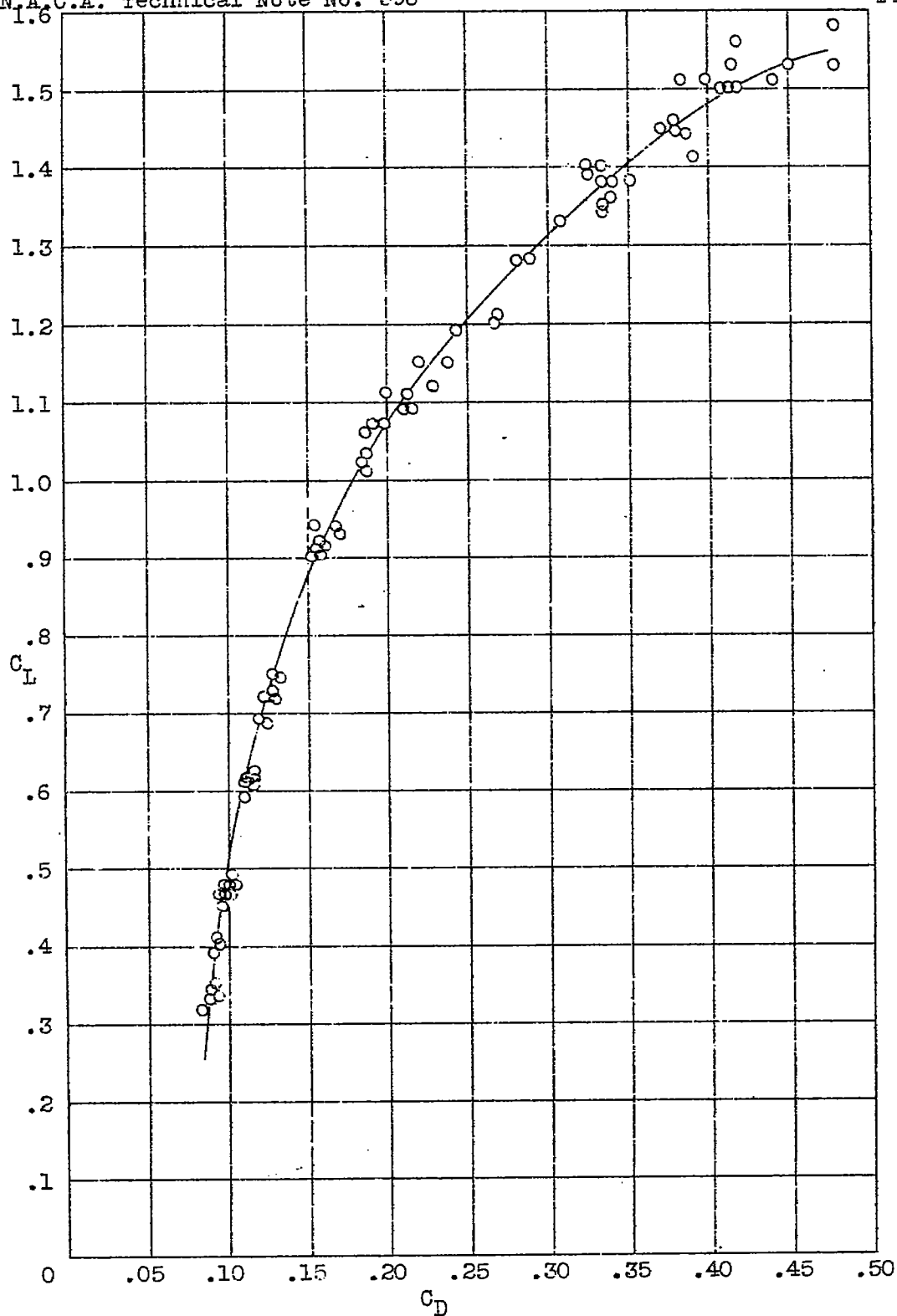

Fig. 9 Polar curve for the Mc Donnell airplane with slots open and flaps neutral.

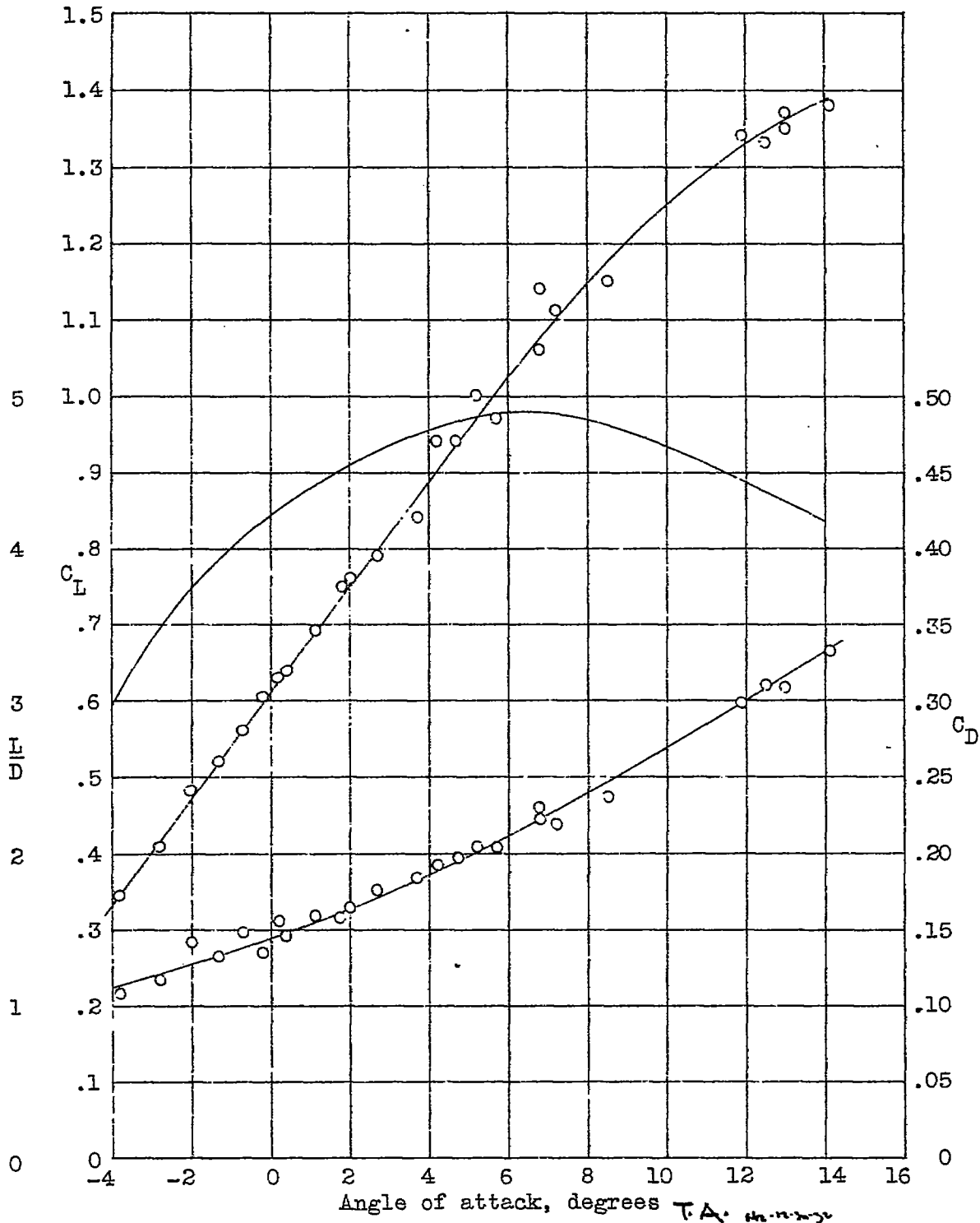

Fig. 10 Characteristic curves for the Mc Donnell airplane with slots closed and flaps down

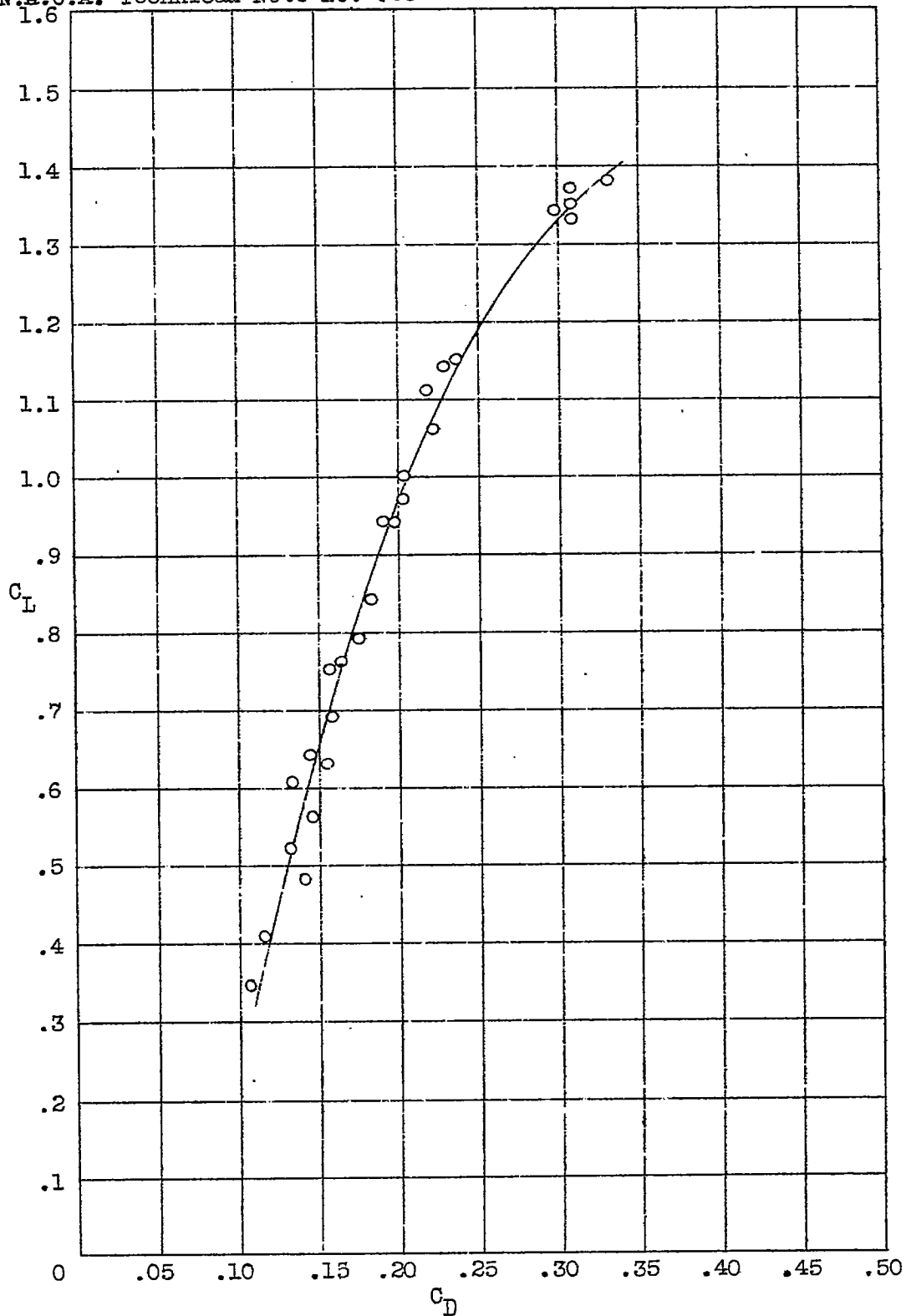

Fig. 11 Polar curve for the Mc Dennell airplane with slots closed and flaps down

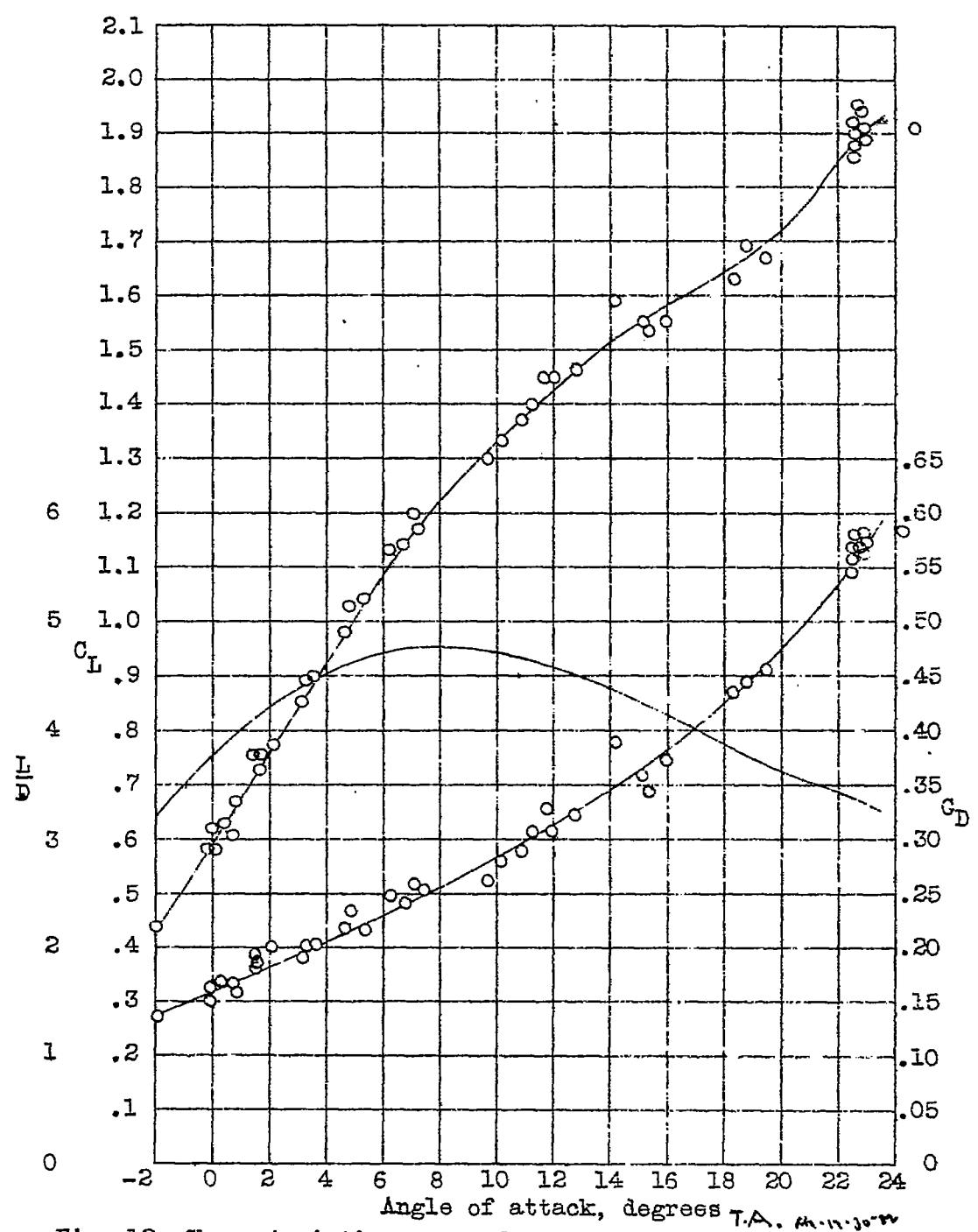

Fig. 12 Characteristic curves for the McDonnell airplane with slots open and flaps down

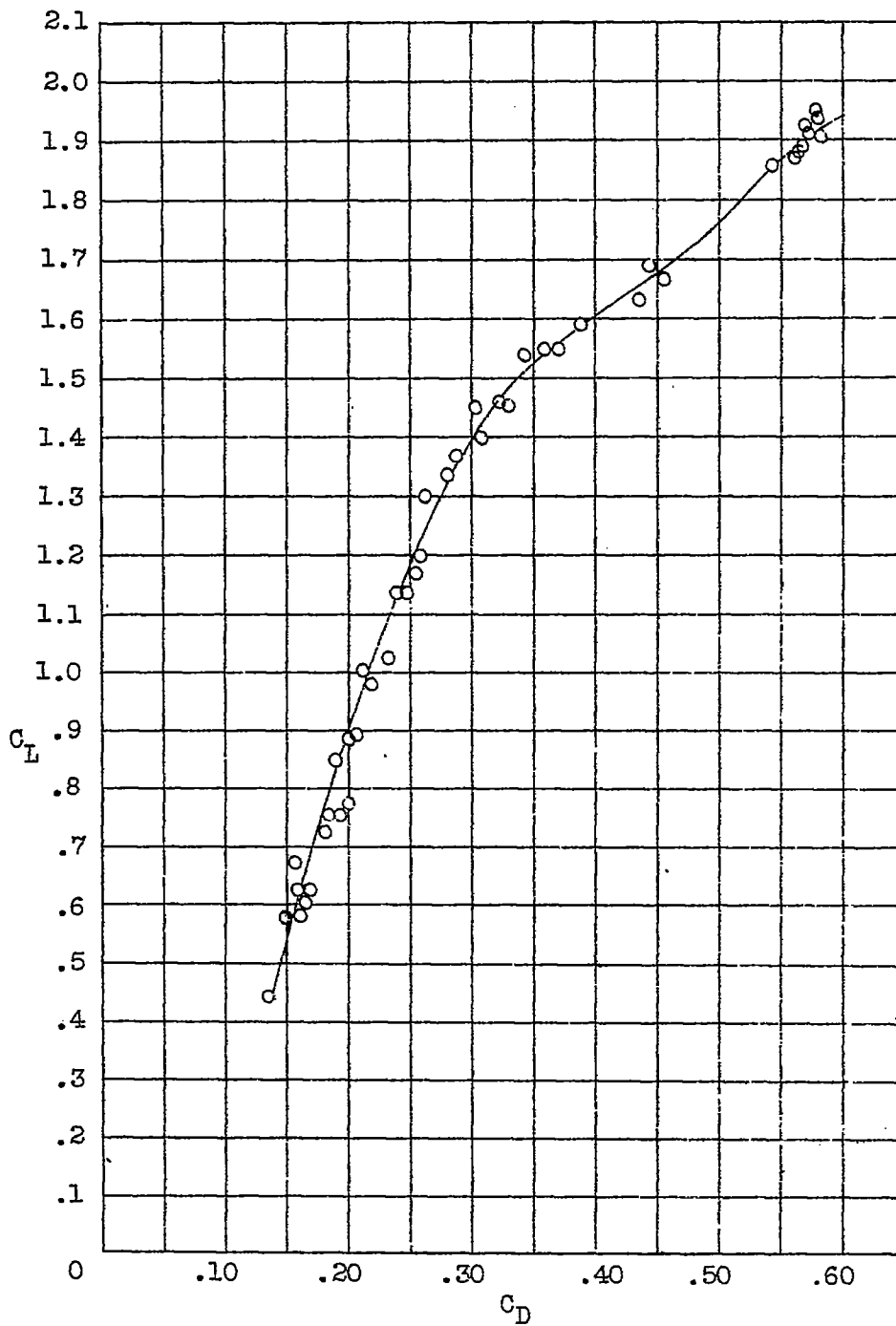

Fig. 13 Polar curve for the McDonnell airplane with slots open and flaps down

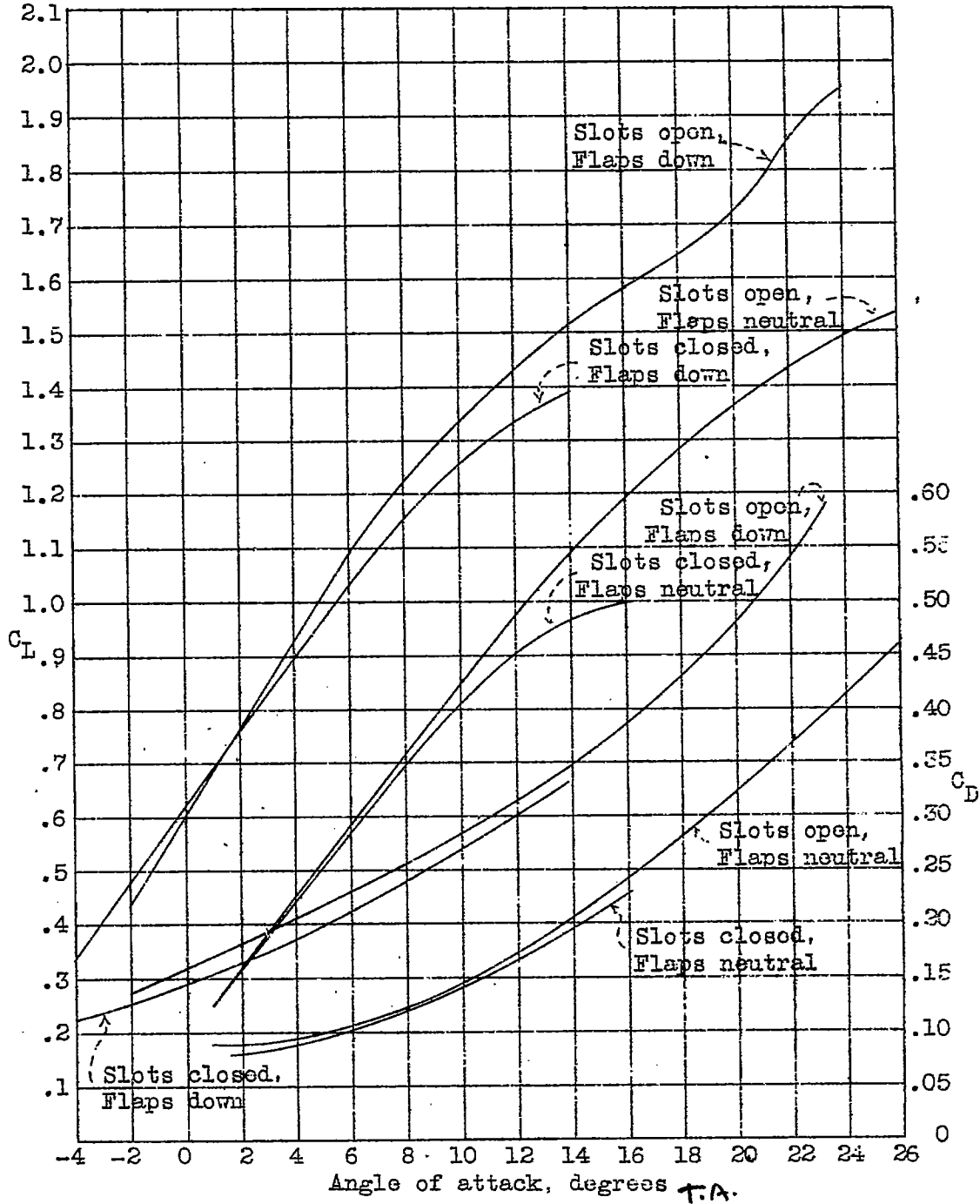

Fig. 14 Characteristic curves for the McDonnell airplane for all conditions of slots and flaps tested

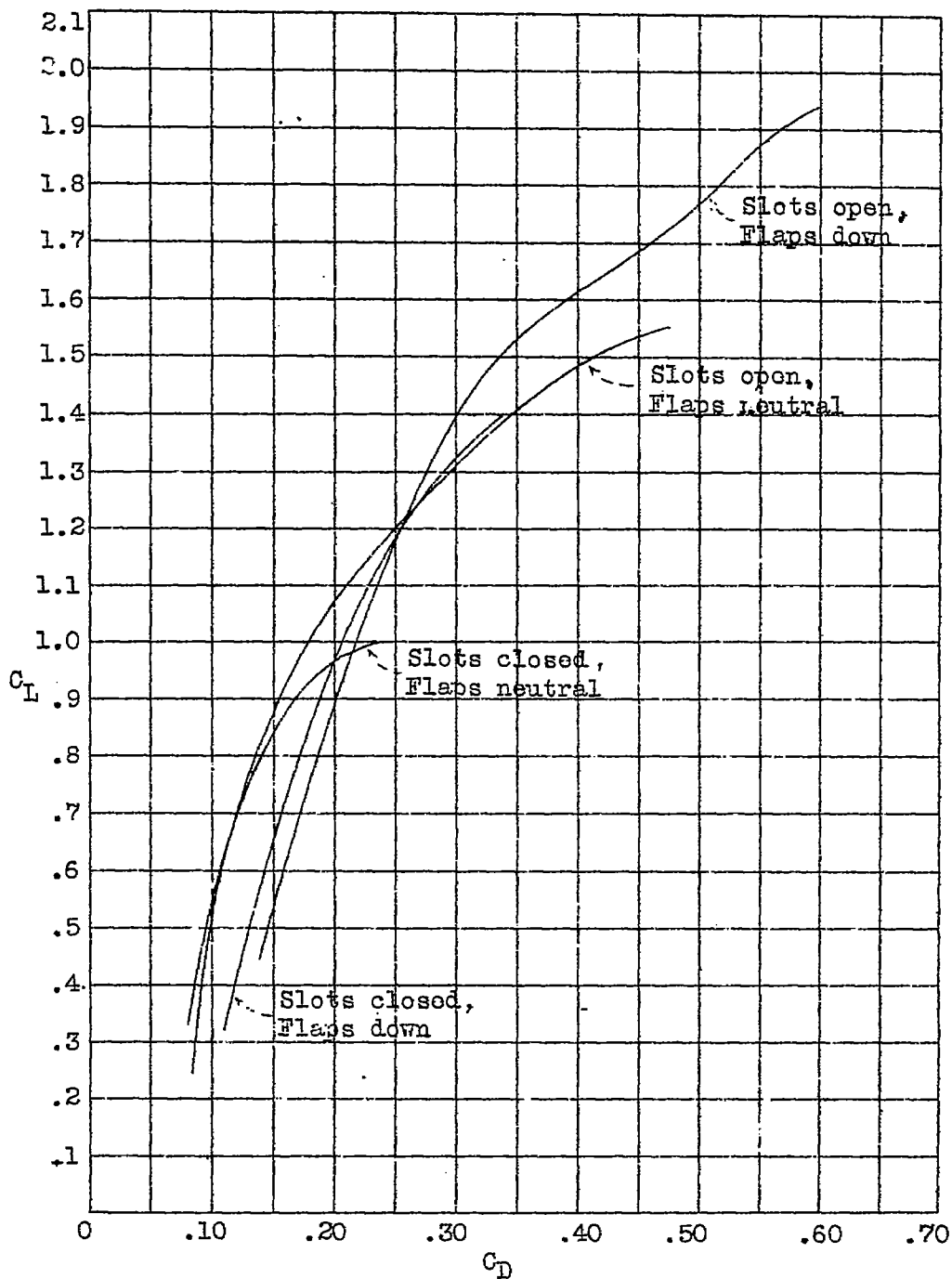

Fig. 15 Polar curves for the McDonnell airplane for all conditions of slots and flaps tested