

10647
NACA TN 4305

TECH LIBRARY KAFB, NH
0067142

NATIONAL ADVISORY COMMITTEE FOR AERONAUTICS

TECHNICAL NOTE 4305

WIND-TUNNEL INVESTIGATION OF EFFECTS OF SPOILER LOCATION,
SPOILER SIZE, AND FUSELAGE NOSE SHAPE ON DIRECTIONAL
CHARACTERISTICS OF A MODEL OF A TANDEM-
ROTOR HELICOPTER FUSELAGE

By James L. Williams

Langley Aeronautical Laboratory
Langley Field, Va.



Washington

July 1958

AEMCO
TECHNICAL LIBRARY
AFL 201



TECHNICAL NOTE 4305

WIND-TUNNEL INVESTIGATION OF EFFECTS OF SPOILER LOCATION,
SPOILER SIZE, AND FUSELAGE NOSE SHAPE ON DIRECTIONAL
CHARACTERISTICS OF A MODEL OF A TANDEM-
ROTOR HELICOPTER FUSELAGE

By James L. Williams

SUMMARY

A low-speed investigation was made in the Langley stability tunnel to study the effect of spoiler location, spoiler size, and fuselage nose shape on the directional stability characteristics of a model of a tandem-rotor helicopter fuselage.

The model was found to be directionally unstable at certain positive angles of attack. This instability was found to result, in general, from a large unstable fuselage moment that resulted from the potential flow pressure peaks in the vicinity of the fuselage nose and a low tail effectiveness, a factor that was shown to be associated with the adverse effect of the fuselage sidewash on the tail. The use of a spoiler 0.45 inch high at a position 3.50 inches from the fuselage nose was an effective means for making the fuselage directionally stable at all angles of attack investigated, a result that had been obtained previously for a nonoverlap-type fuselage. Decreasing the spoiler height from 0.45 to 0.30 inch generally resulted in a decrease in magnitude of the stabilizing yawing-moment coefficient at angles of attack of -30° , -10° , and 30° ; however, at an angle of attack of 10° the smaller spoiler was ineffective in stabilizing the fuselage-tail configuration. Substituting a blunt nose section for the tapered nose section resulted in a fuselage-tail configuration that was directionally stable at all angles of attack of the investigation except an angle of attack of 30° .

INTRODUCTION

The results of wind-tunnel tests (ref. 1) have indicated that a model of a tandem-rotor helicopter fuselage having a bent fuselage form and tapered nose section was directionally unstable at certain angles of attack. The results contained in reference 2 for a similar model have

shown that no appreciable improvement in the directional stability was obtained by means of a fuselage afterbody revision. Flight tests of a configuration similar to that of reference 2 have substantiated the presence of directional instability in that the tandem rotor helicopter has poor directional stability characteristics in the autorotative flight conditions (ref. 3).

The results of an investigation (ref. 4) on a model of a tandem nonoverlap-type fuselage (a fuselage having a bent fuselage form and a blunt nose shape) in the Langley stability tunnel have shown that placing spoilers around the fuselage nose was an effective means of improving the directional stability characteristics in that the spoilers generally stabilized the previously unstable fuselage-tail configuration. As noted in reference 4, the spoiler probably destroyed the potential flow about the fuselage and thereby resulted in a decrease in the unstable fuselage-alone yawing moment. Reference 5 contains results of tests on the model of reference 2 (bent fuselage with tapered nose shape) with various spoiler configurations at a small negative angle of attack; however, these results have indicated no improvement in the directional stability due to the spoiler. The difference in the results of references 4 and 5 suggests, therefore, that the effect of the spoilers in reducing the unstable yawing moment of the fuselage probably depends to a large degree on spoiler location, angle of attack, and possibly fuselage nose shape.

The purpose of the present investigation was to study the effect of spoiler location, spoiler size, and fuselage nose shape on the static lateral stability characteristics of a model of a tandem-rotor helicopter fuselage. This investigation consisted of the measurement of the aerodynamic forces and moments throughout a range of sideslip angles at four angles of attack. A short study of the air flow behind the fuselage model by means of the tuft-grid technique of reference 6 is also presented.

SYMBOLS

The data presented herein are referred to the stability system of axes with the origin located at fuselage station 24.85. The positive directions of forces, moments, and angles are shown in figure 1. The symbols and coefficients employed are defined as follows:

C_D drag coefficient, $\frac{\text{Drag}}{q_2 S_d}$

C_l rolling-moment coefficient, $\frac{\text{Rolling moment}}{q_2 S_d l}$

C_Y side-force coefficient, $\frac{\text{Side force}}{q2S_d}$

C_n yawing-moment coefficient, $\frac{\text{Yawing moment}}{q2S_d l}$

$$C_{n\beta} = \frac{\partial C_n}{\partial \beta}$$

l distance between rotor hub centers, 3.18 ft

$2S_d$ total rotor disk area, 17.10 sq ft

V free-stream velocity, ft/sec

q dynamic pressure, $\rho V^2/2$, lb/sq ft

ρ mass density of air, slugs/cu ft

α angle of attack of fuselage reference line, deg

β angle of sideslip, deg

Subscripts:

0.75 . . . 5.00 distance from tip of nose to spoiler position, in.

Model components:

S spoiler

SS spoiler strip

MODEL, APPARATUS, AND TESTS

The model used in the present investigation was a 0.075-scale model of a current tandem-rotor helicopter fuselage having a bent fuselage form and tapered nose. This model is referred to hereinafter as fuselage 1. A detailed drawing of the model is presented as figure 2(a), and a photograph of the model mounted on the single strut support as figure 3. The laminated mahogany model was constructed so that approximately 12 inches of the nose section was interchangeable with a section that was similar to the blunt-nose shape of fuselage 3 of reference 4. This modification permitted tests to determine some effects of nose shape on the aerodynamic

characteristics of the helicopter fuselage model. A sketch of the blunt-nose configuration (referred to hereinafter as fuselage 2) is presented in figure 4 and a photograph in figure 5.

The vertical and horizontal tails were constructed as a unit and were removable to permit tests of the fuselage alone. Details of the vertical and horizontal tails are given in figure 2(a) and table I.

Seven spoiler locations were investigated on fuselage 1. (See fig. 2 for these positions.) The spoilers which extended completely around the fuselage nose were made from 1/16-inch-thick duralumin and projected 0.30 or 0.45 inch from the fuselage surface at each location. Photographs of several typical spoiler positions investigated and their designation are presented as figure 3. The spoiler strips (SS) located in an approximately horizontal position (figs. 2(b) and 3(c)) were about 8 inches in length.

The spoilers used with the blunt nose section (fuselage 2) were made from 1/16-inch-thick sheet brass and projected about 0.20 inch from the fuselage surface (fig. 5(b)). The spoiler strips used on fuselage 2 were approximately 7 inches long.

The models were mounted rigidly on a single strut support, at fuselage station 24.85, in the 6- by 6-foot test section of the Langley stability tunnel. The forces and moments were measured by means of a six-component mechanical balance system. All force tests were made at a dynamic pressure of 39.7 pounds per square foot, which corresponds to a velocity of about 125 miles per hour. The test Reynolds number was about 4.59×10^6 , based on the overall fuselage length. The angles of attack investigated for all configurations were 30° , 10° , -10° , and -30° for angles of sideslip that ranged, except for several configurations, from 25° to -25° . The horizontal tail was set at an angle of incidence of approximately 11° for all tail-on tests.

The tuft-grid tests were made at a dynamic pressure of 24.9 pounds per square foot, which corresponds to a Reynolds number of about 3.64×10^6 , and a velocity of about 100 miles per hour.

CORRECTIONS

The data obtained in this investigation were not corrected for support-strut interference or blockage effects. Previous tests of a similar model have indicated that these corrections are not important to the interpretation of the results.

RESULTS AND DISCUSSION

Presentation of Data

The side-force coefficient, yawing-moment coefficient, and the tuft-grid pictures of the air flow behind the fuselage model are presented in figures 6 to 13. Since the purpose of the present paper is to provide an evaluation of the directional stability, the discussion is concerned only with these coefficients; however, the rolling-moment coefficient is presented in figures 14 to 19 and the drag coefficient for certain conditions in figure 20 because of the effects that these parameters have on the dynamic stability and performance, respectively.

Directional Stability Characteristics of Fuselage 1

Effect of spoiler location.- The effect of spoiler location on the variation of yawing-moment coefficient with angle of sideslip for fuselage 1 with tail is presented in figures 6 and 7, and the variation of $C_{n\beta}$ (measured through $\beta = 0^\circ$) with spoiler location is presented in figure 8. A study of these figures shows that at $\alpha = 10^\circ$ and $\alpha = 30^\circ$ the complete model configuration without spoiler is directionally unstable (as indicated by the negative slope of the curve of yawing-moment coefficient plotted against β) and only the spoiler (0.45 inch high) located 3.50 inches from the fuselage nose ($S_{3.50}$) resulted in a directionally stable (as indicated by the positive slope of the curve of yawing-moment coefficient plotted against β) configuration at all angles of attack of the investigation.

An examination of the data (figs. 6 to 8) for the remaining spoiler locations shows that at $\alpha = 30^\circ$ any of the spoiler locations investigated (except $S_{0.75}$) resulted in a directionally stable configuration. At $\alpha = 10^\circ$, however, only the spoiler located 3.50 inches from the fuselage nose stabilized the unstable fuselage-tail configuration.

The results presented in figures 6 to 8 for the negative angles of attack ($\alpha = -10^\circ$ and $\alpha = -30^\circ$) show that fuselage 1 with tail was directionally stable. A study of these figures for $\alpha = -10^\circ$ shows that the addition of the spoiler at any of the positions investigated generally resulted in a decrease in the positive values of $C_{n\beta}$ (decreased stability). At $\alpha = -30^\circ$, the use of the spoiler from the most forward location ($S_{0.75}$) up to 3.50 inches from the fuselage nose resulted in an increase in the positive values of $C_{n\beta}$ (increased stability). Any further increase in spoiler distance decreased the magnitude of $C_{n\beta}$;

however, in no case did the adverse effect of spoiler destabilize fuselage 1 with tail.

The favorable effect of spoiler ($S_{3.50}$) that resulted in a directionally stable configuration (fuselage 1 with tail) at $\alpha = 10^\circ$ and $\alpha = 30^\circ$ was similar to the effect obtained for fuselage 3 of reference 4 where the use of spoilers stabilized the unstable fuselage-tail arrangement.

Effect of strip spoilers.- In an attempt to increase the magnitude of the yawing-moment coefficient at the larger sideslip angles, spoiler strips (SS) were used with $S_{3.50}$ on fuselage 1 with tail. The results presented in figure 9 show that at positive angles of attack the spoiler strips were effective in extending to higher sideslip angles the point at which the unstable break in the yawing-moment coefficient occurs. In fact, at $\alpha = 10^\circ$ the yawing-moment coefficient increased linearly up to the maximum sideslip angle. In the low angle-of-sideslip range at $\alpha = 30^\circ$, the spoiler strips had an adverse effect on the directional stability in that the fuselage-tail configuration was neutrally stable. (Compare configurations with and without spoiler strips.)

The results for the negative angles of attack indicate that at $\alpha = -10^\circ$ the spoiler strips had little effect on the yawing-moment characteristics; however, at $\alpha = -30^\circ$, the spoilers resulted in a large decrease in the directional stability.

Effect of spoiler size.- The effect of substituting a 0.30-inch-high spoiler for the 0.45-inch-high spoiler is shown in figure 9. At $\alpha = 10^\circ$, the 0.30-inch-high spoiler was ineffective in stabilizing fuselage 1 with tail, whereas the configuration with the larger spoiler was directionally stable. For the remaining angles of attack, 30° , -10° , and -30° , decreasing the spoiler height from 0.45 to 0.30 inch generally resulted in a decrease in magnitude of the stable yawing-moment coefficient over most of the angle-of-sideslip range.

Effect of tail and spoiler on fuselage 1.- The yawing-moment characteristics of fuselage 1 as affected by the tail and spoiler ($S_{3.50}$) are presented in figure 10. An examination of this figure shows that at positive angles of attack the tail was ineffective in overcoming the large unstable yawing moment of fuselage 1. A study of the tuft-grid pictures of the air flow behind the fuselage (fig. 11) for $\alpha = 10^\circ$ and 30° at four angles of sideslip shows that the tail was, in general, adversely affected by fuselage sidewash which results in a low tail effectiveness. Similar effects have been shown to exist for the nonoverlap-type fuselage configuration in reference 4. The low tail effectiveness along with the large unstable fuselage-alone moment accounts to a large degree for the directional instability of the fuselage-tail configuration.

From a study of figure 10 for $\alpha = -10^\circ$ and -30° , it can be seen that fuselage 1 was directionally stable for a limited sideslip range. These results agree with the results of reference 7 which have indicated that this stability of the fuselage alone was caused by the fuselage bend. Adding the tail to the fuselage increased the magnitude and extended to higher sideslip angles the stable variation shown for the yawing-moment coefficient of the fuselage alone.

A comparison of the data for the fuselage with and without spoiler ($S_{3.50}$) at $\alpha = 10^\circ$ and $\alpha = 30^\circ$ shows that the spoiler, by destroying the potential flow about the fuselage nose, resulted in a large decrease in the unstable fuselage moment. This effect (decreased fuselage moment) along with the tail contribution resulted in a directionally stable complete model configuration (fuselage 1 with tail and spoiler). The spoilers, as would be expected, gave some increase in drag. (See fig. 20.) The reduction in the unstable moment due to the spoiler is reflected in the side-force coefficient, particularly at $\alpha = 30^\circ$ (fig. 10(c)) where the side force was reversed for both the tail-on and tail-off configurations. This effect is apparent also for the results obtained at $\alpha = 10^\circ$ but was smaller in magnitude. A study of the results for the negative angles of attack indicates that at $\alpha = -10^\circ$ the spoiler had an adverse effect on the fuselage-alone stability; however, the destabilizing effect of spoiler did not result in an unstable fuselage-tail configuration. For $\alpha = -30^\circ$, the addition of the spoiler increased the magnitude and extended to higher sideslip angles the fuselage-alone stability. The effect of the spoiler was reflected in the side-force coefficient at an angle of attack of -30° and this effect was similar to the trends indicated at the positive angles of attack.

Effect of top or bottom half of $S_{3.50}$. The effect of using only either the top or the bottom half of the best spoiler ($S_{3.50}$) on the yawing-moment coefficient of fuselage 1 with tail can be seen from a study of the results in figure 12. These data show that at positive angles of attack neither the top nor the bottom half of $S_{3.50}$ alone was effective in stabilizing fuselage 1 with tail.

For the negative angles of attack (figs. 12(b) and 12(d)), the results indicate that either the top or the bottom half of $S_{3.50}$ had, in general, only a small effect on the stable fuselage-tail configuration, although at $\alpha = -30^\circ$ the top half of $S_{3.50}$ resulted in an increase in the directional stability of the fuselage-tail configuration.

Directional Stability Characteristics of Fuselage 2

Effect of tail on fuselage 2.- The nose section of fuselage 1 was replaced by a blunt nose section to obtain fuselage 2. The variation of yawing-moment coefficient with angle of sideslip for fuselage 2 with and without tail is presented in figure 13. These results show that fuselage 2 alone was directionally stable at $\alpha = 10^\circ$, -10° , and -30° and unstable at $\alpha = 30^\circ$. Adding the tail to the fuselage increased the magnitude of the stable fuselage-alone characteristics at $\alpha = 10^\circ$, -10° , and -30° ; however, at $\alpha = 30^\circ$, because of the low tail effectiveness and large unstable fuselage moment, the fuselage-tail configuration was directionally unstable.

Effect of spoiler.- A study of the results (fig. 13) for fuselage 2 with and without spoiler indicates that the spoiler not only decreased the magnitude of the destabilizing yawing-moment coefficient at $\alpha = 30^\circ$ but also decreased the magnitude of the stabilizing yawing-moment coefficient at $\alpha = 10^\circ$, -10° , and -30° . A comparison of the complete model configurations (fuselage 2 with tail) with and without spoiler shows that the use of spoilers on the fuselage improved the directional stability at $\alpha = 30^\circ$, but at $\alpha = 10^\circ$, -10° , and -30° , the spoilers resulted in a decrease in directional stability. This decrease in directional stability however, did not result in an unstable complete model configuration at these angles. This effect of spoiler on the complete model resulted from the effect of spoiler on the fuselage alone which has been discussed previously.

Comparison of Fuselage 1 and Fuselage 2

Of the two configurations investigated, spoilers off, the fuselage with blunt nose (fuselage 2) had better directional stability characteristics than the tapered-nose configuration (fuselage 1) in that fuselage 2 with tail was directionally stable, over a limited sideslip range, at all angles of attack except $\alpha = 30^\circ$. (Compare figs. 9 and 13.) When the spoilers and spoiler strips were added to the configurations, however, the fuselage with tapered nose (fuselage 1 with tail, S_{3.50}, and SS) had better directional characteristics in that this configuration was stabilized at all angles of attack whereas the blunt-nose configuration (fuselage 2 with tail, S, and SS) remained directionally unstable at $\alpha = 30^\circ$.

An examination of the data (figs. 10 and 13) for the configurations without spoilers shows that substituting a blunt nose for the tapered nose stabilized the fuselage at $\alpha = 10^\circ$ but resulted in a decrease in directional stability at $\alpha = -30^\circ$ for both tail-on and tail-off configurations. In general, fuselage 1 and fuselage 2 had similar

yawing-moment characteristics at $\alpha = 30^\circ$ (directionally unstable) and $\alpha = -10^\circ$ (directionally stable).

CONCLUSIONS

The results of a low-speed investigation in the Langley stability tunnel of the directional stability characteristics of a model of a tandem-rotor helicopter fuselage have indicated the following conclusions:

1. The model was directionally unstable at certain positive angles of attack. This instability resulted in general from the large unstable fuselage moment, caused by the potential flow pressure peaks in the vicinity of the fuselage nose, and a low tail effectiveness, a factor that was shown to be associated with the adverse effect of fuselage sidewash on the tail.

2. The use of a spoiler 0.45 inch high at a position 3.50 inches from the fuselage nose was an effective means for making the helicopter fuselage model directionally stable at all angles of attack of the investigation (-30° , -10° , 10° , and 30°), a result that has been obtained previously for a similar fuselage configuration. As would be expected the spoilers resulted in some increase in the drag.

3. Decreasing the spoiler height from 0.45 to 0.30 inch generally resulted in a decrease in magnitude of the stabilizing yawing-moment coefficient at all angles of attack except 10° where the smaller size spoiler was ineffective in making the fuselage-tail configuration directionally stable.

4. Substituting a blunt-nose section for the tapered-nose section resulted in a fuselage-tail configuration that was directionally stable for a limited sideslip range at all angles of attack of the investigation except an angle of attack of 30° .

Langley Aeronautical Laboratory,
National Advisory Committee for Aeronautics,
Langley Field, Va., April 29, 1958.

REFERENCES

1. Beebe, John, and Bradshaw, H. R.: Wind-Tunnel Tests of a 0.10-Scale HRP-2 Helicopter Without Rotors. Part I - Longitudinal and Lateral Characteristics With Original Afterbody. Rep. C-246, Aero 774, David W. Taylor Model Basin, Navy Dept., Aug. 1949.
2. Beebe, John, and Kuldell, P. D.: Wind-Tunnel Tests of a 0.10-Scale Model of the HRP-2 Helicopter Without Rotors. Part II - Longitudinal and Lateral Characteristics With Revised Afterbody. Rep. C-266, Aero 774, David W. Taylor Model Basin, Navy Dept., Oct. 1949.
3. Jackson, Robert C., and Peterson, Harold W.: Phase II Flight Tests of the YH-21 Helicopter. AF Tech. Rep. No. AFFTC 53-6, Air Force Flight Test Center (Edwards, Calif.), Mar. 1953.
4. Williams, James L.: Directional Stability Characteristics of Two Types of Tandem Helicopter Fuselage Models. NACA TN 3201, 1954.
5. Burton, Harry, and Mutimer, George R.: Wind-Tunnel Tests of a 0.10-Scale Model of the HRP-2 Helicopter Without Rotors With Nose Fin and Other Devices To Improve Directional Stability. Aero Rep. 910 (TED No. TMB AD-3197), David W. Taylor Model Basin, Navy Dept., Nov. 1956.
6. Bird, John D., and Riley, Donald R.: Some Experiments on Visualization of Flow Fields Behind Low-Aspect-Ratio Wings by Means of a Tuft Grid. NACA TN 2674, 1952.
7. Williams, James L.: Wind-Tunnel Investigation of Effects of Fuselage Cross-Sectional Shape, Fuselage Bend, and Vertical-Tail Size on Directional Characteristics of Nonoverlap-Type Helicopter Fuselage Models Without Rotors. NACA TN 3645, 1956.

TABLE I

PERTINENT GEOMETRIC CHARACTERISTICS OF MODELS

Fuselage length, ft	3.94
Vertical tail:	
Aspect ratio	0.83
Taper ratio	1.00
NACA airfoil section	0012
Span, at leading edge, ft	0.53
Root chord, ft	0.300
Area, sq ft	0.293
Span, at trailing edge, ft	0.457
Horizontal tail:	
Aspect ratio	3.32
Taper ratio	0.63
NACA airfoil section	0018
Span, ft	0.937
Root chord, ft	0.317
Area, sq ft	0.265

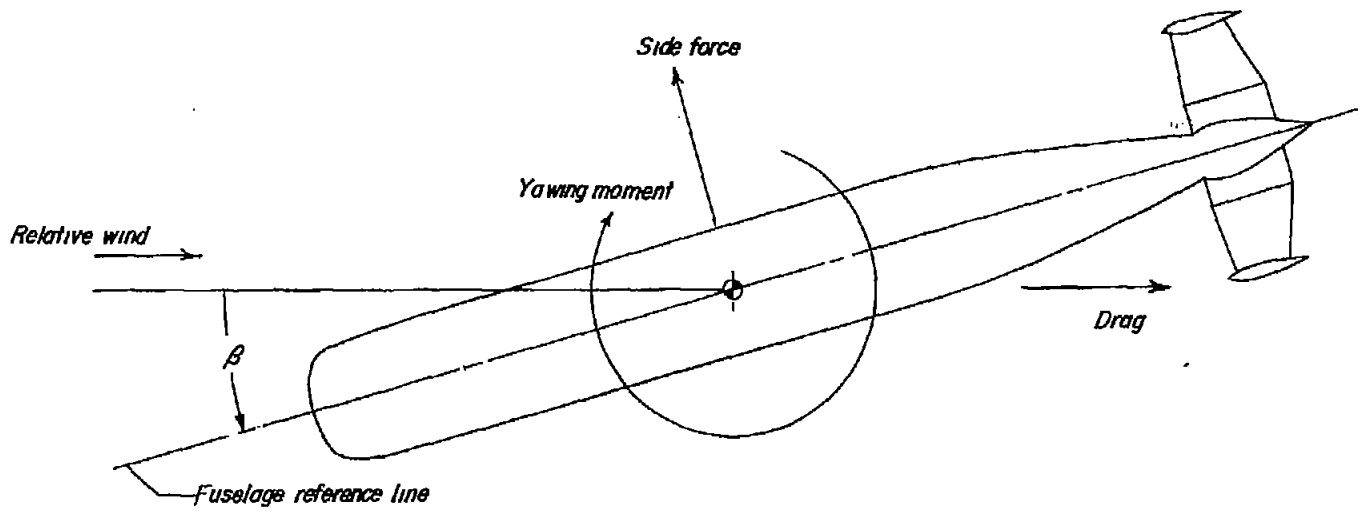
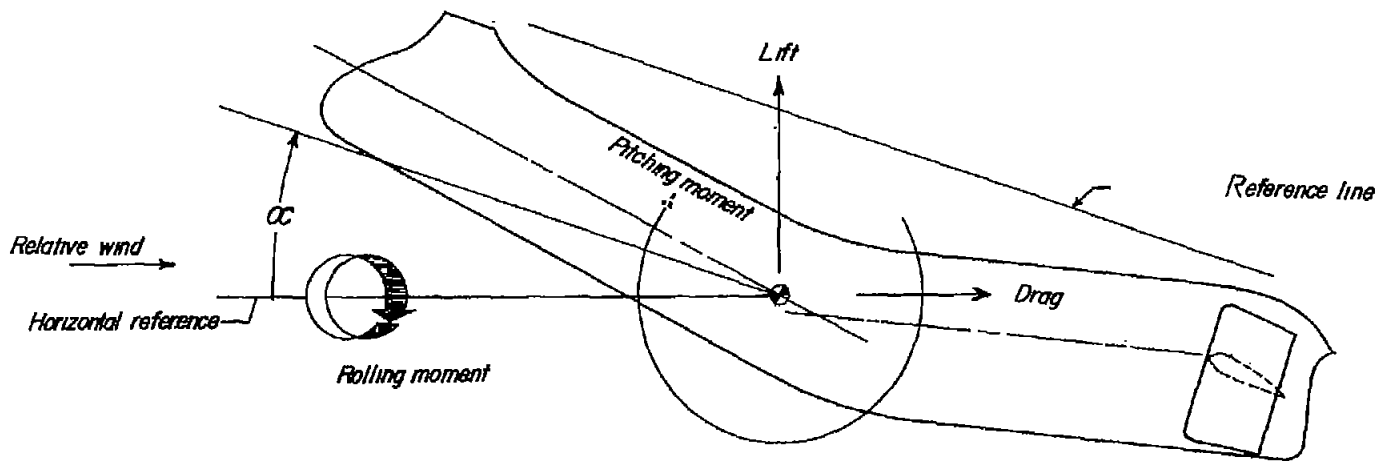
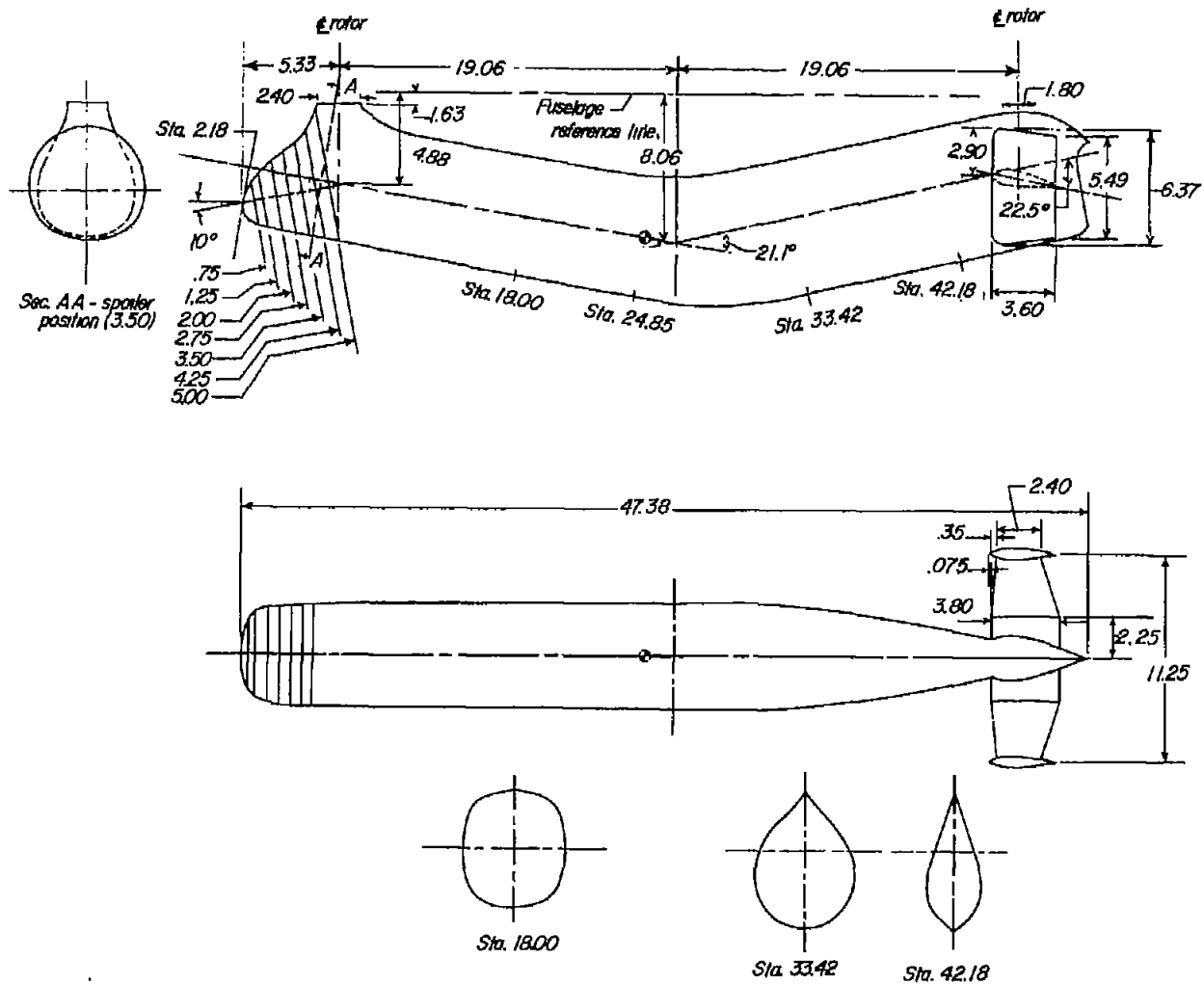
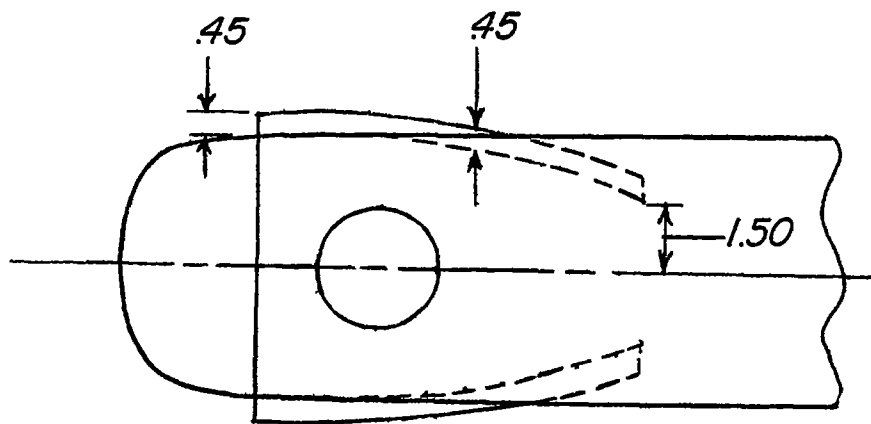
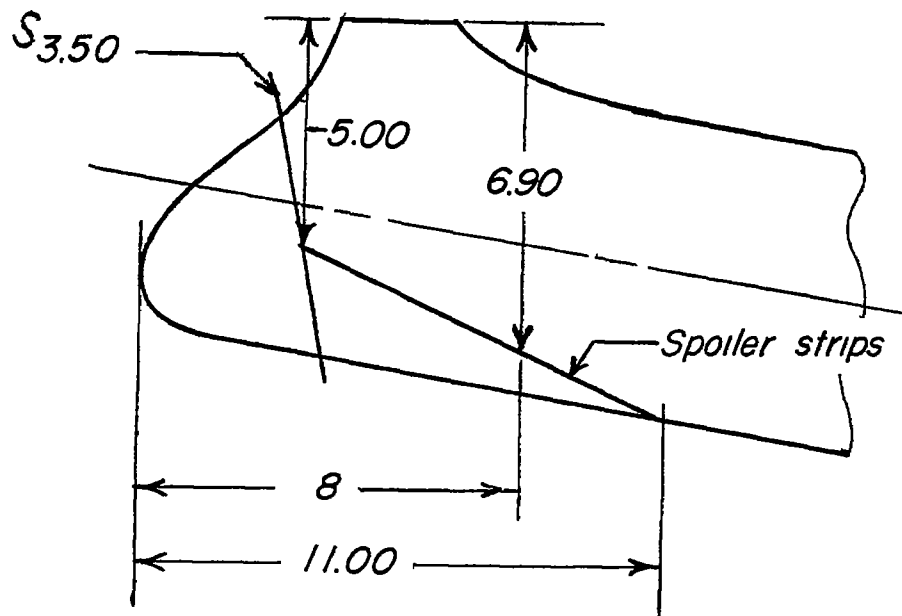

Figure 1.- System of axes used.



(a) Fuselage and tail dimensions and spoiler location.

Figure 2.- Spoiler locations and details of fuselage 1 with tail. All dimensions are in inches.



(b) Dimensions of spoiler and spoiler strips.

Figure 2.- Concluded.

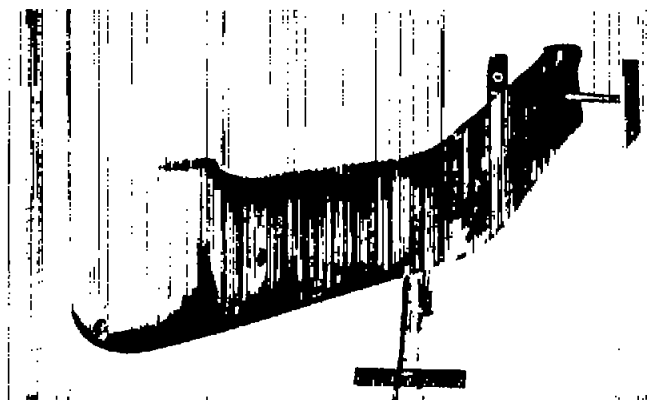

(a) Fuselage 1 with tail.

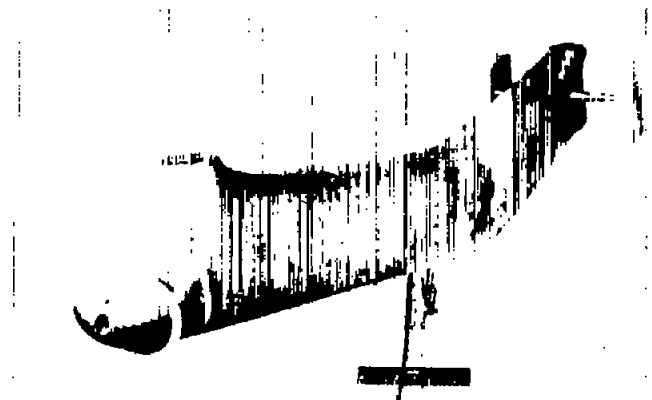

(b) Fuselage 1 with tail and $S_{1.25}$.

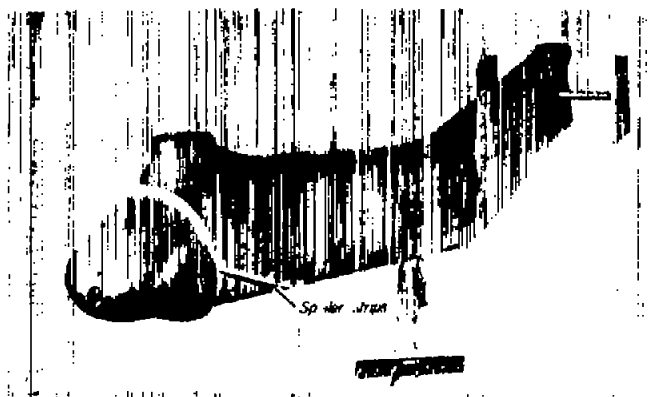

(c) Fuselage 1 with tail, $S_{3.50}$, and SS.



(d) Fuselage 1 with tail and $S_{5.00}$.

Figure 3.- Views of fuselage 1 with and without various spoilers. L-58-1666

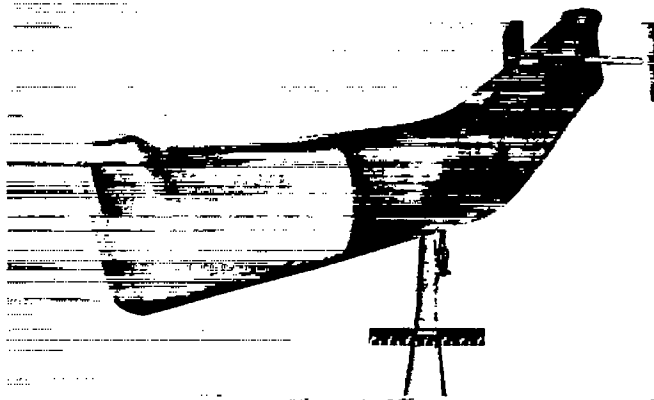

(a) Fuselage 2 with tail.

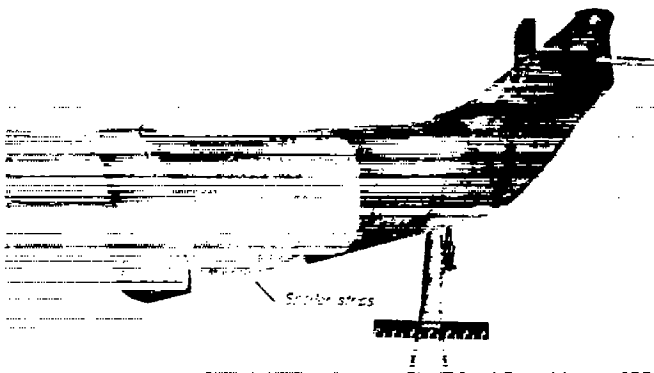

(b) Fuselage 2 with tail, S, and SS. I-58-1667

Figure 5.- View of fuselage 2 with tail and with and without spoiler.

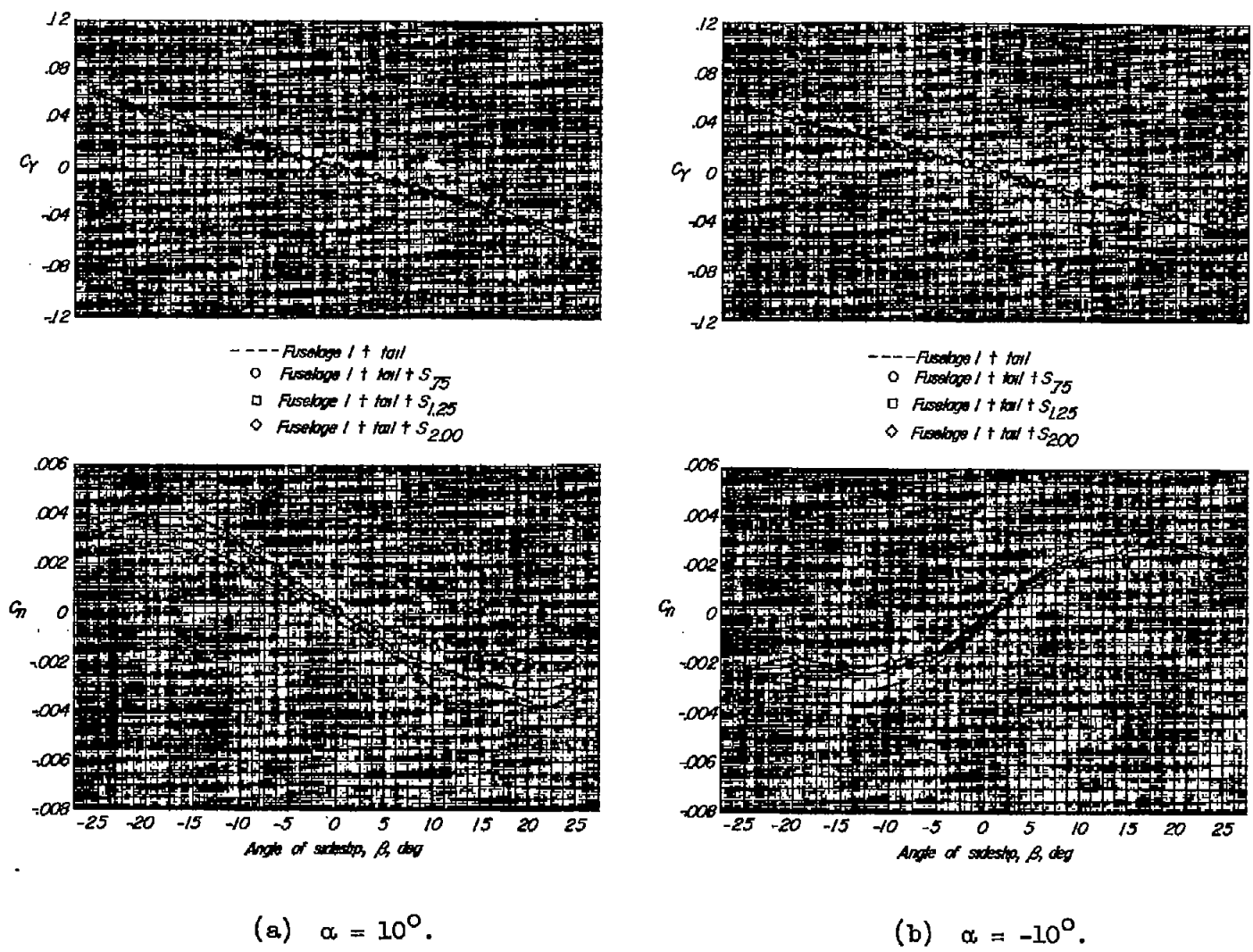

(a) $\alpha = 10^\circ$.

(b) $\alpha = -10^\circ$.

Figure 6.- Effect of spoiler (0.45 inch high) on side-force and yawing-moment characteristics in sideslip at several angles of attack. Spoilers located 0.75, 1.25, and 2.00 inches from fuselage nose.

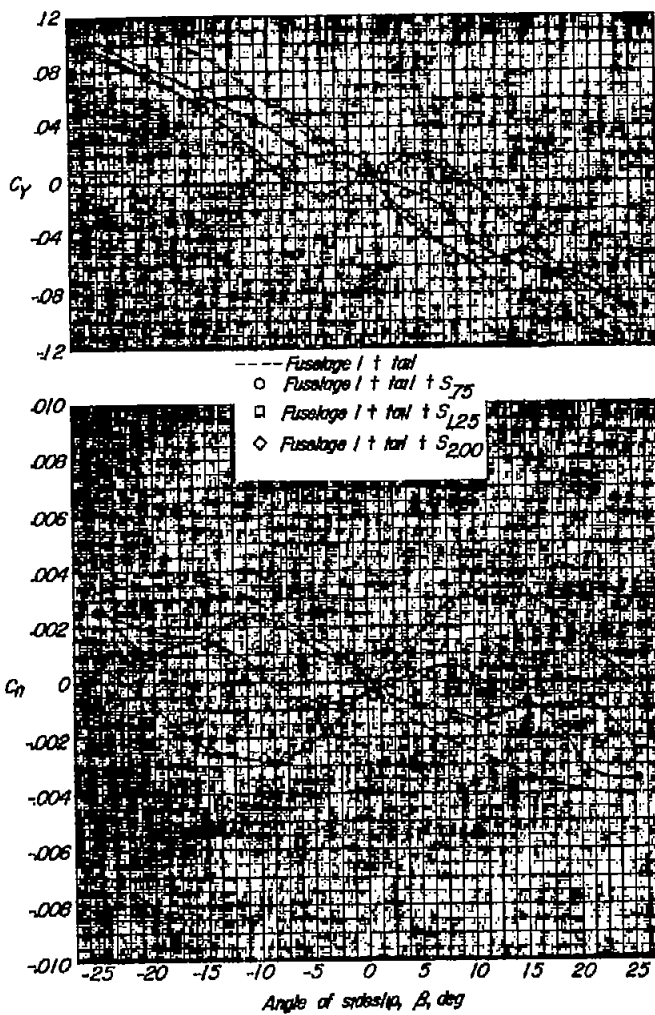

(c) $\alpha = 30^\circ$.

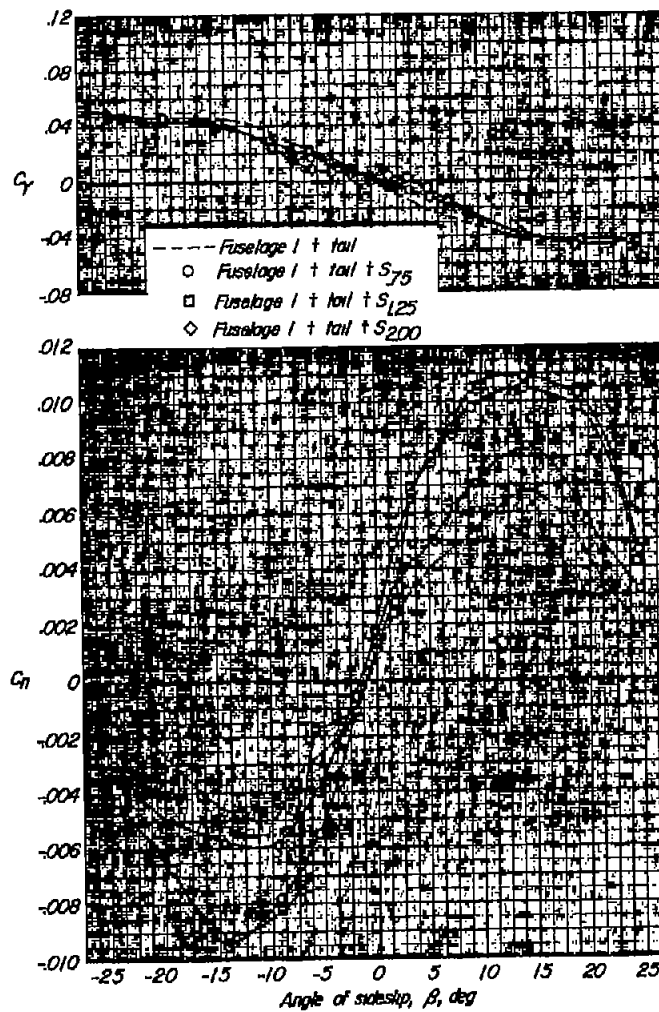

(d) $\alpha = -30^\circ$.

Figure 6.- Concluded.

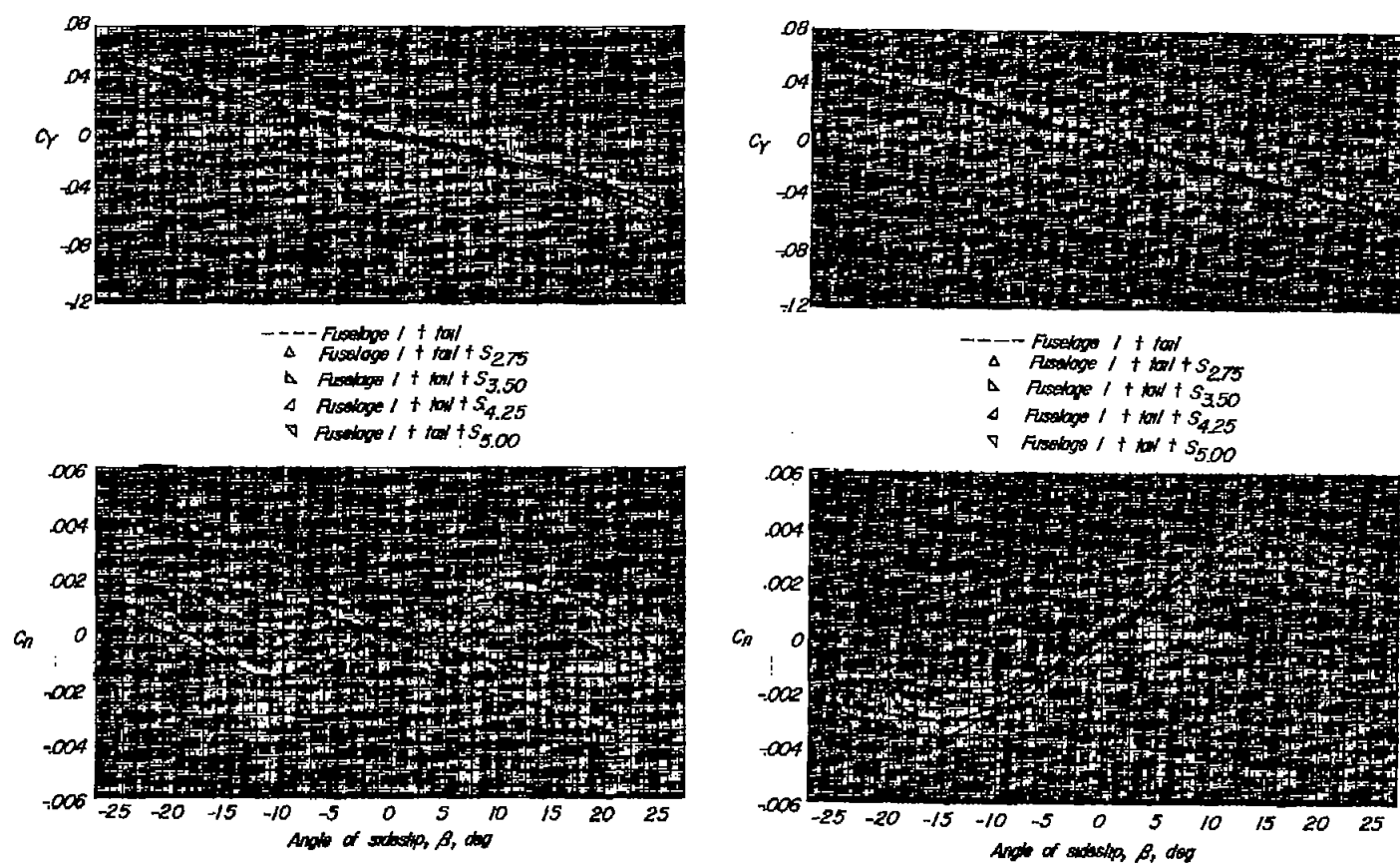

(a) $\alpha = 10^\circ$.

(b) $\alpha = -10^\circ$.

Figure 7.- Effect of spoiler (0.45 inch high) on side-force and yawing-moment characteristics in sideslip at several angles of attack. Spoilers located 2.75, 3.50, 4.25, and 5.00 inches from the fuselage nose.

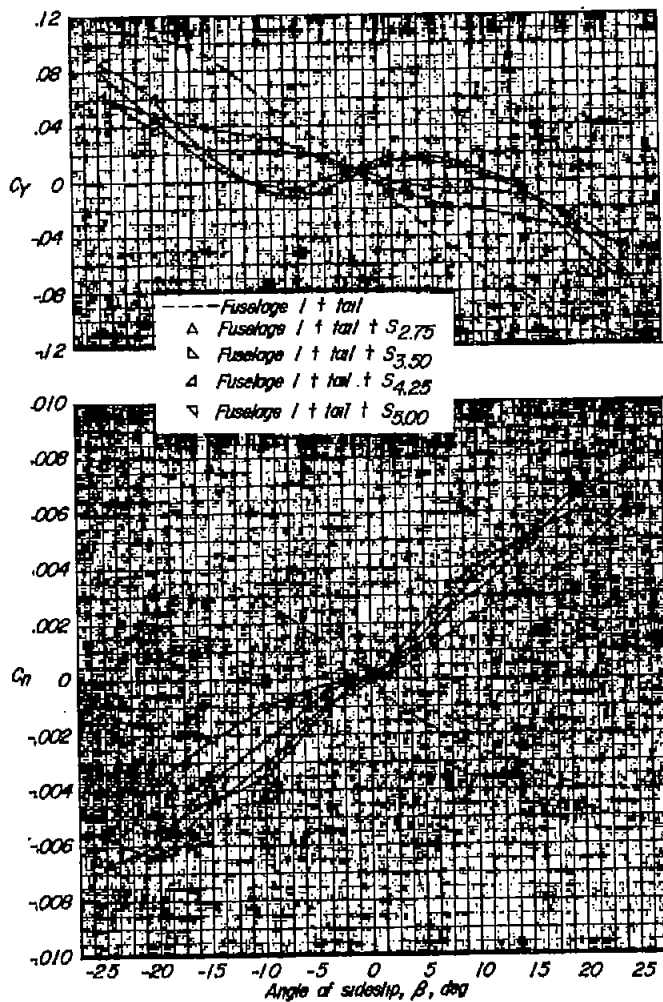

(c) $\alpha = 30^\circ$.

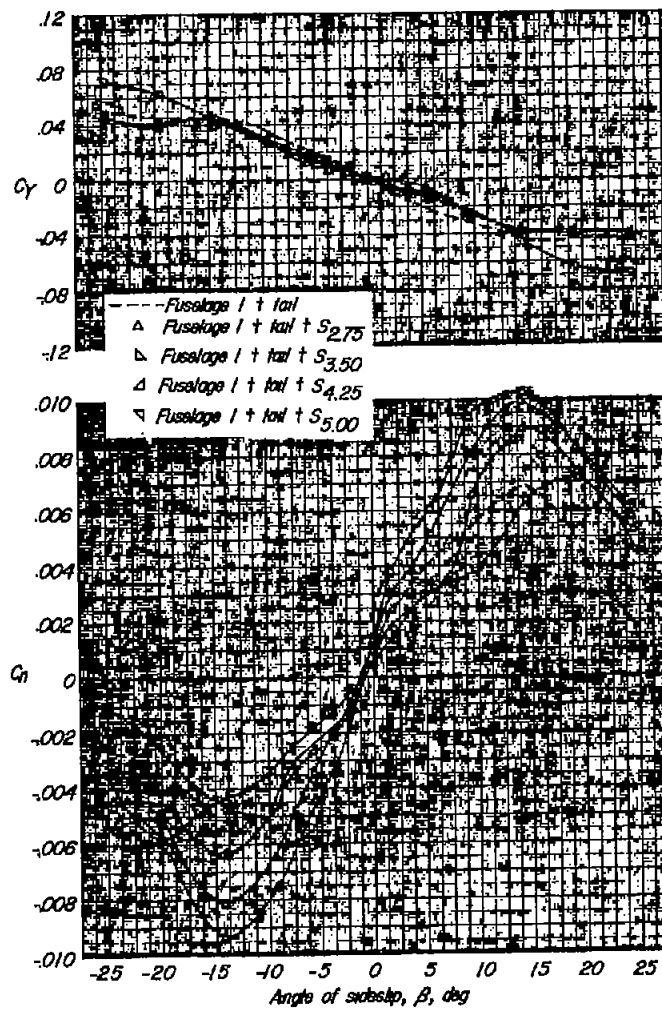

(d) $\alpha = -30^\circ$.

Figure 7.- Concluded.

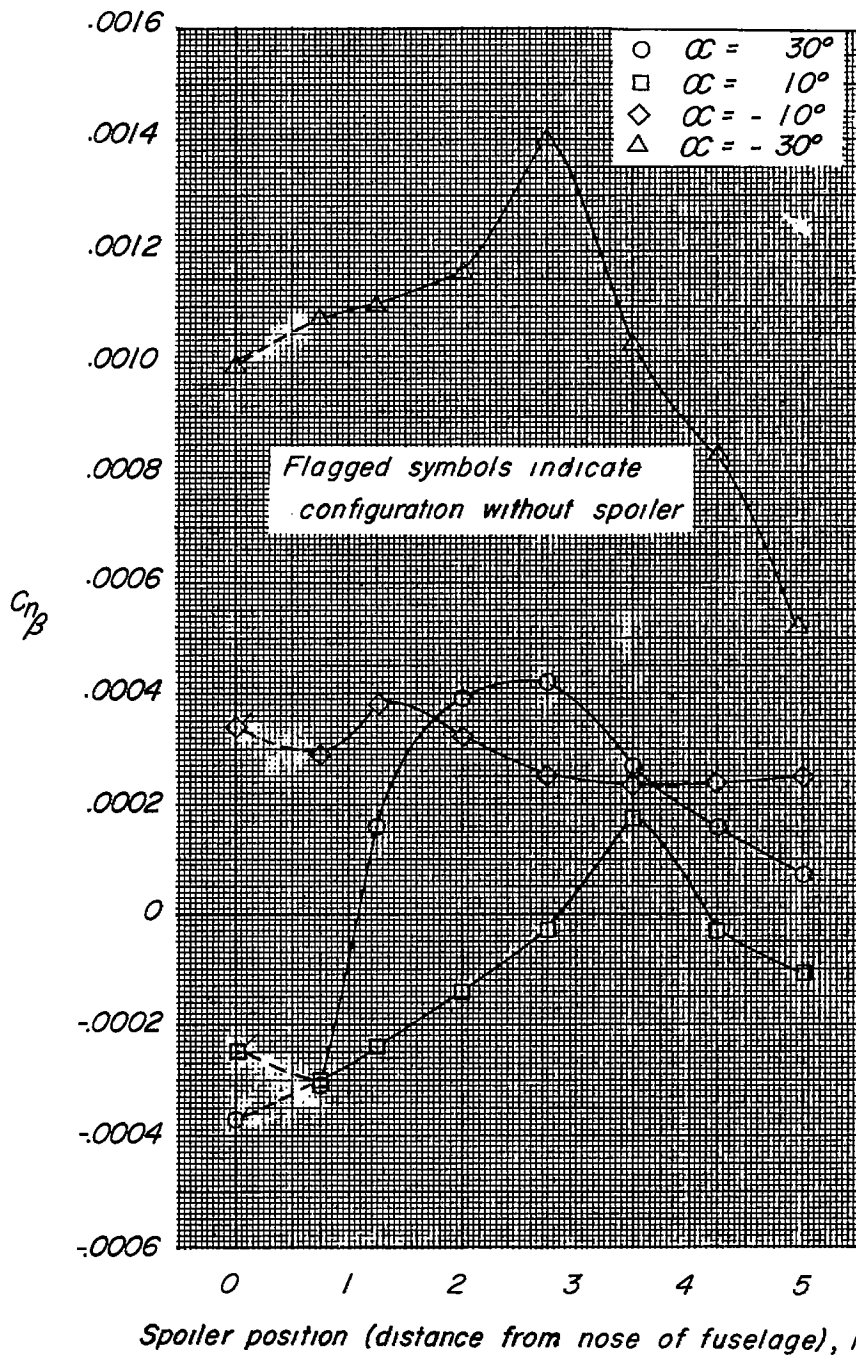
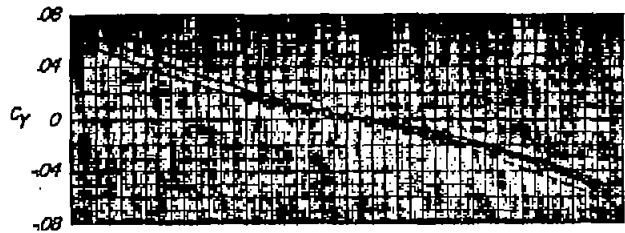
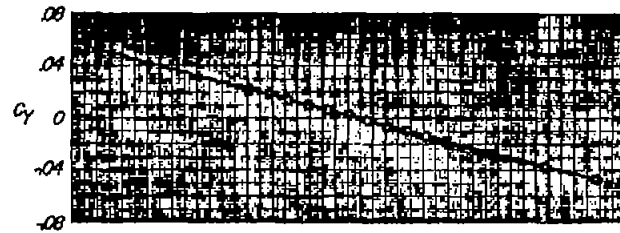

Figure 8.- Variation of directional stability parameter $C_{n\beta}$ (measured through $\beta = 0^\circ$) with spoiler location at several angles of attack. Spoilers were 0.45 inch high.



- Fuselage I + tail
- Fuselage I + tail + $S_{3.50}$ (0.45 m. high)
- Fuselage I + tail + $S_{3.50}$ (0.30 m. high)
- ◇ Fuselage I + tail + $S_{3.50}$ (0.45 m. high) + SS (0.45 m. high)



- Fuselage I + tail
- Fuselage I + tail + $S_{3.50}$ (0.45 m. high)
- Fuselage I + tail + $S_{3.50}$ (0.30 m. high)
- ◇ Fuselage I + tail + $S_{3.50}$ (0.45 m. high) + SS (0.45 m. high)

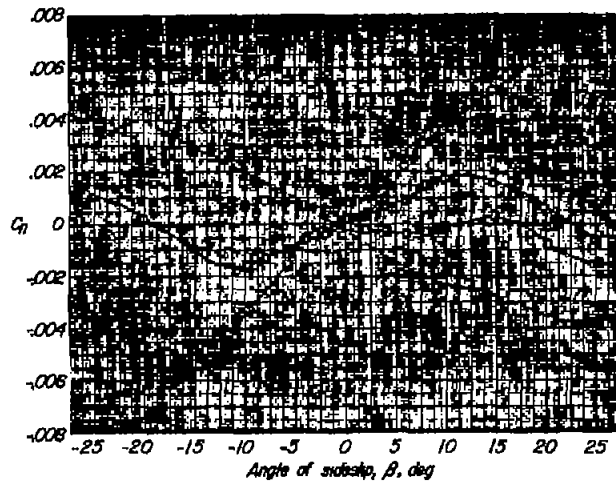

(a) $\alpha = 10^\circ$.

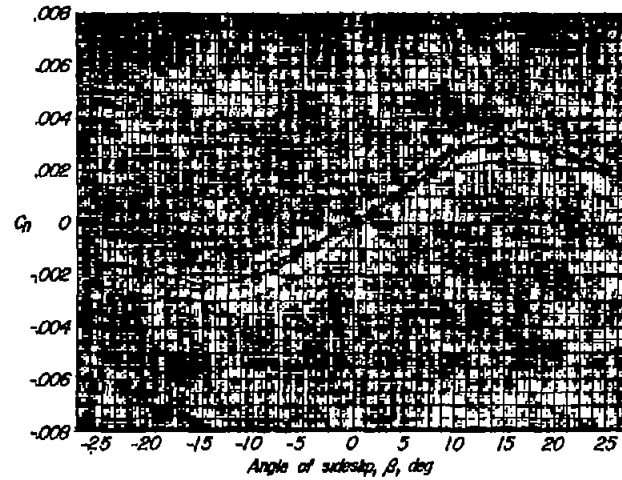

(b) $\alpha = -10^\circ$.

Figure 9.- Effect of spoiler size and spoiler strips on side-force and yawing-moment characteristics in sideslip at several angles of attack.

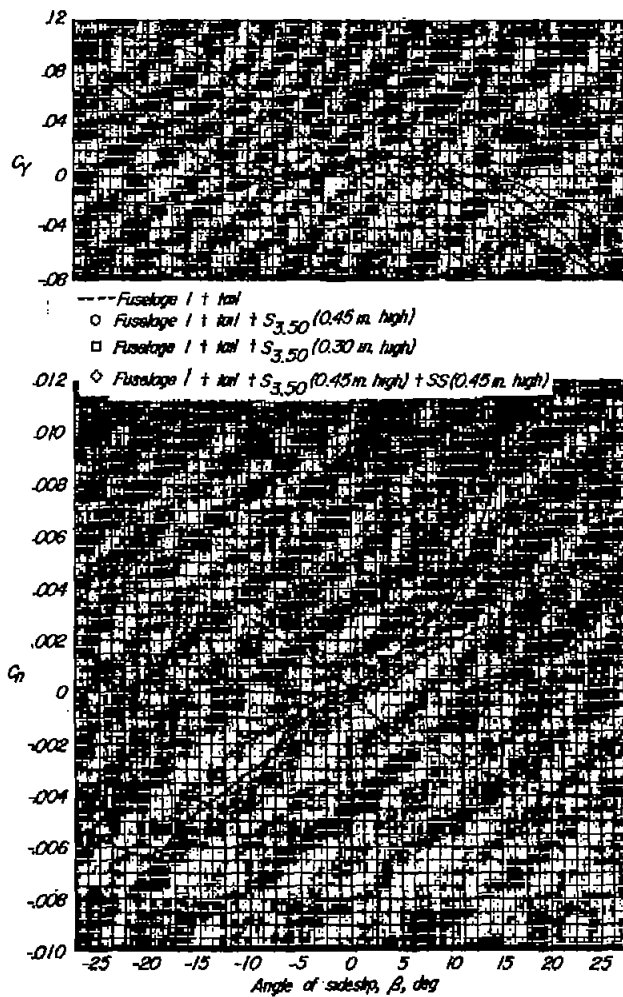

(c) $\alpha = 30^\circ$.

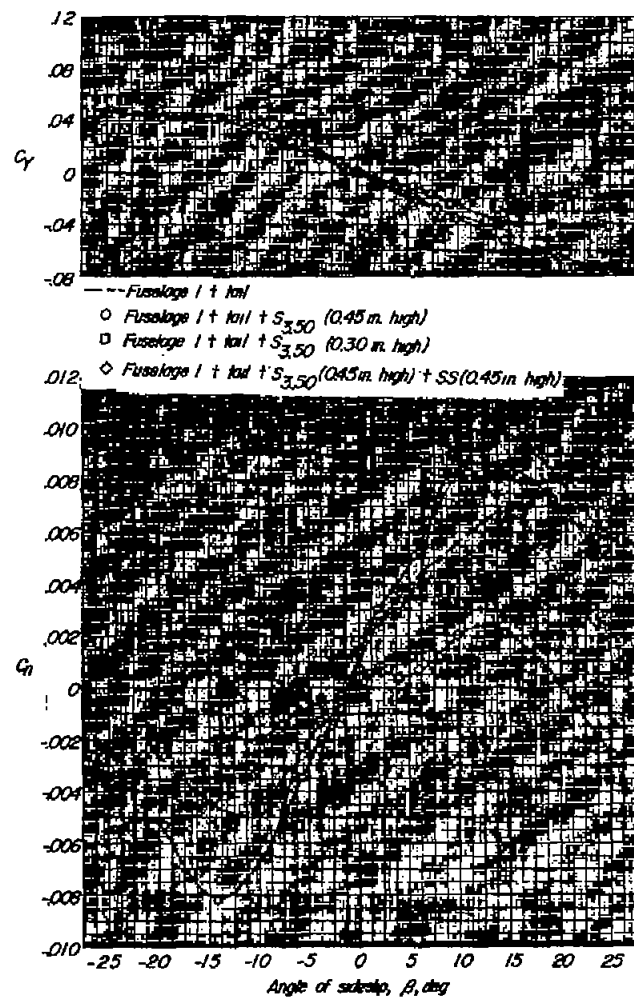

(d) $\alpha = -30^\circ$.

Figure 9.- Concluded.

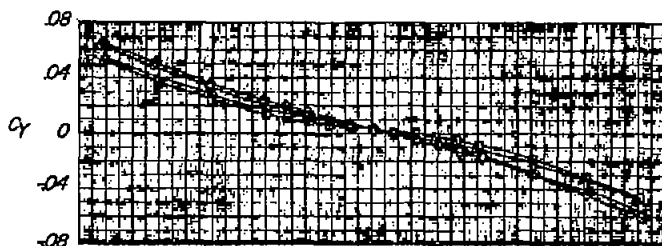

- Fuselage alone
- Fuselage alone + $S_{3.50}$
- ◇ Fuselage + tail
- △ Fuselage + tail + $S_{3.50}$



- Fuselage alone
- Fuselage alone + $S_{3.50}$
- ◇ Fuselage + tail
- △ Fuselage + tail + $S_{3.50}$

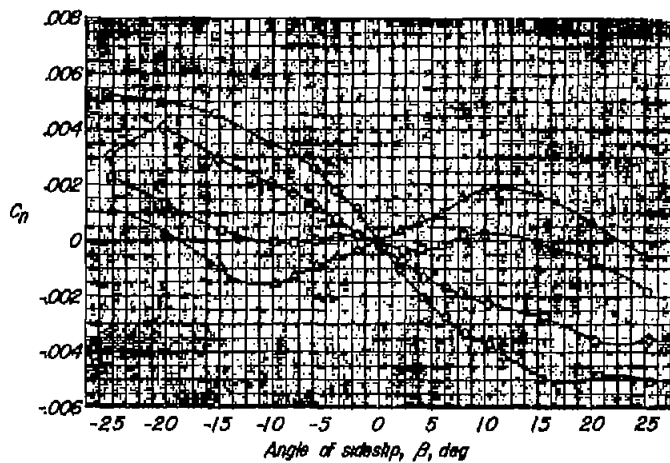

(a) $\alpha = 10^\circ$.

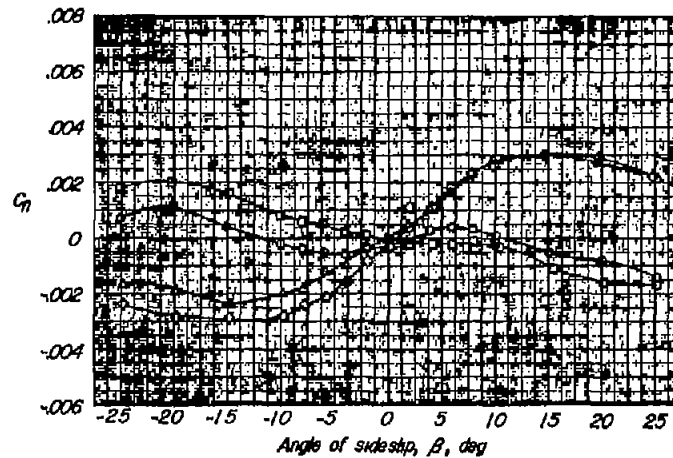

(b) $\alpha = -10^\circ$.

Figure 10.- Effect of tail and spoiler on side-force and yawing-moment characteristics in sideslip of fuselage alone at several angles of attack.

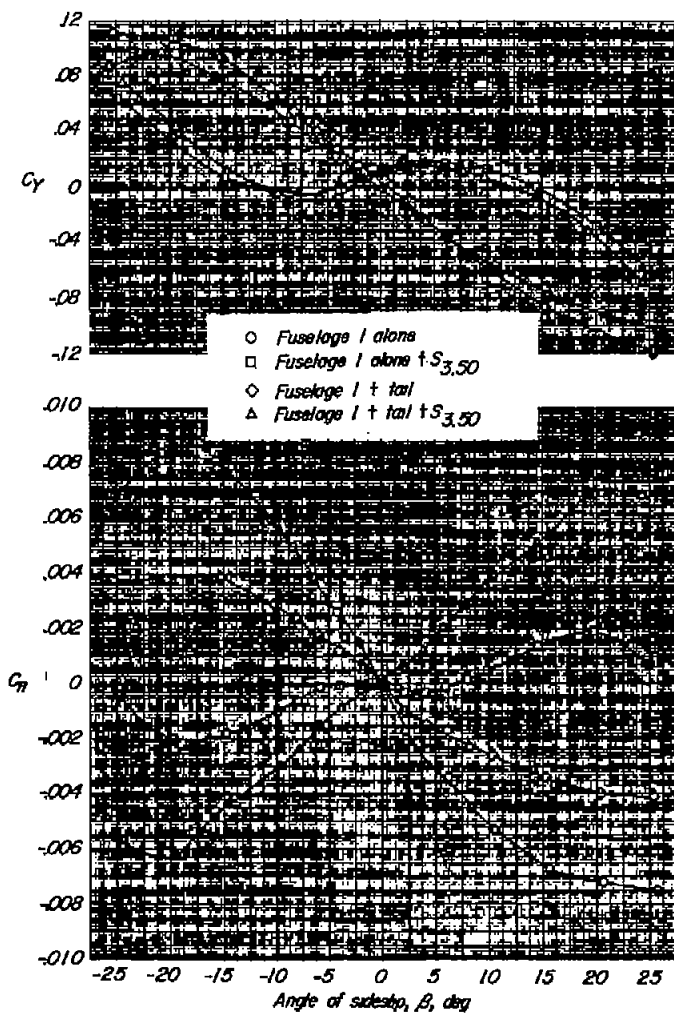

(c) $\alpha = 30^\circ$.

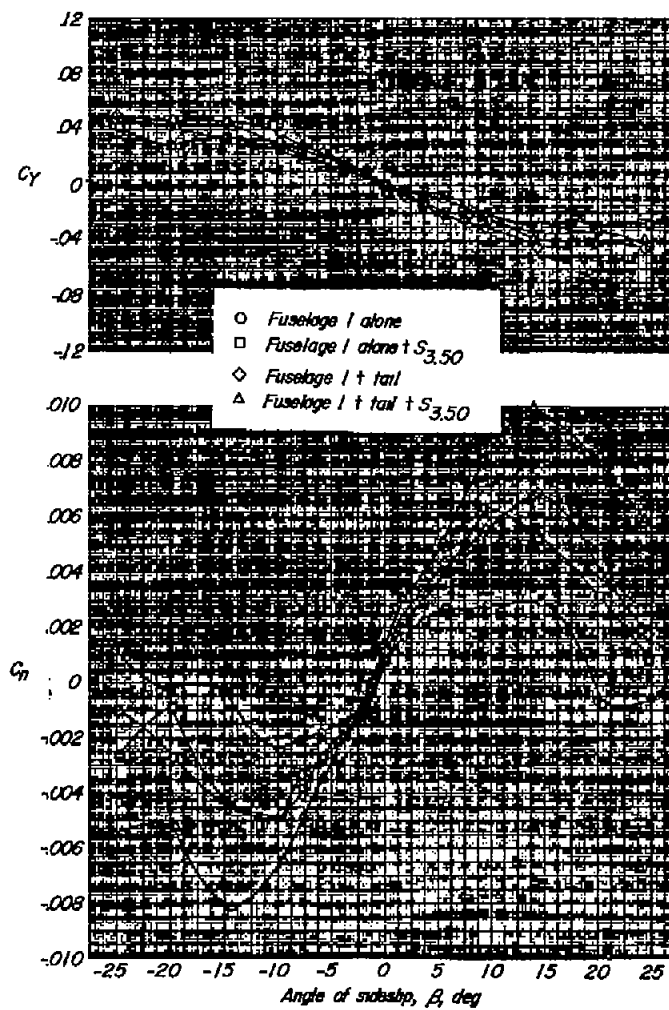

(d) $\alpha = -30^\circ$.

Figure 10.- Concluded.

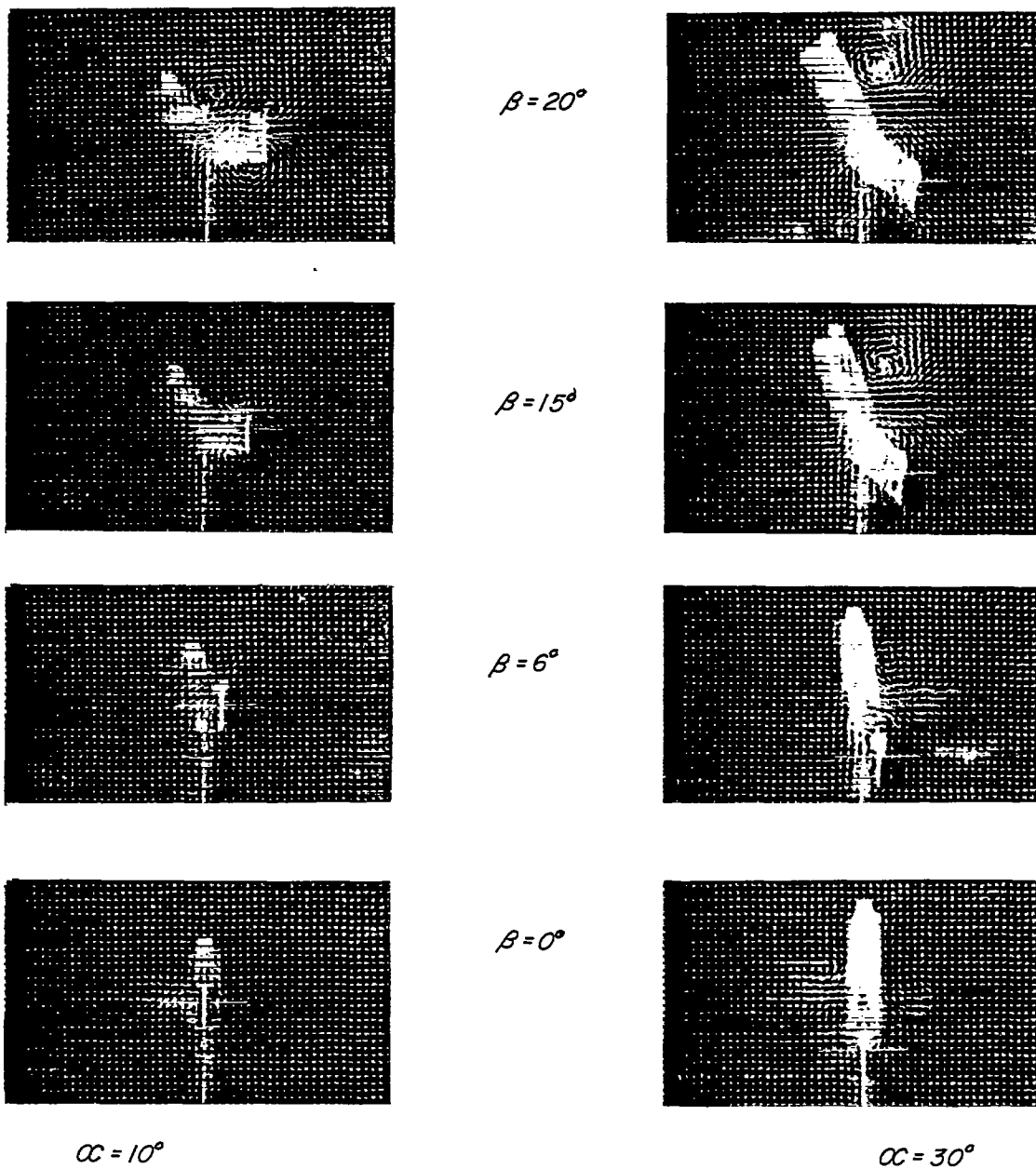
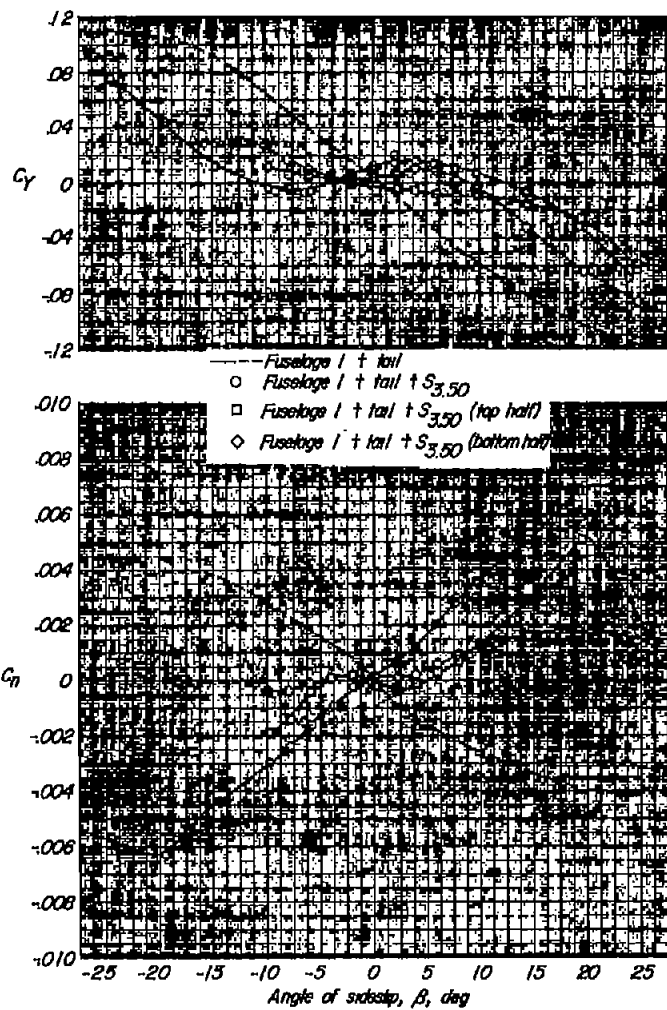
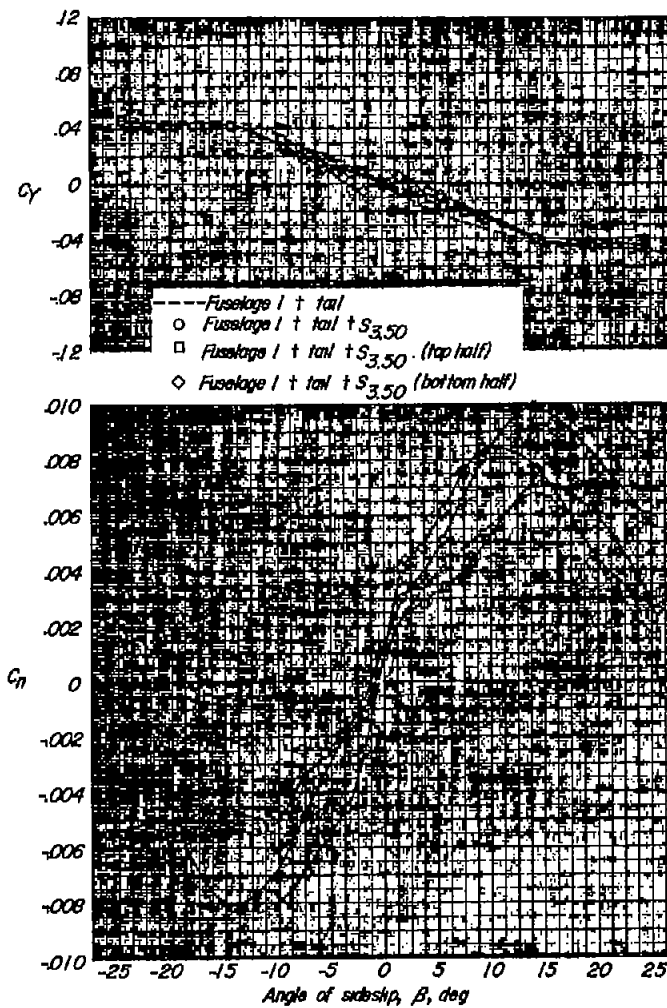

Figure 11.- Tuft-grid pictures of fuselage 1 without tail. L-58-1668
 $q = 24.9$ pounds per square foot.



(c) $\alpha = 30^\circ$.



(d) $\alpha = -30^\circ$.

Figure 12.- Concluded.

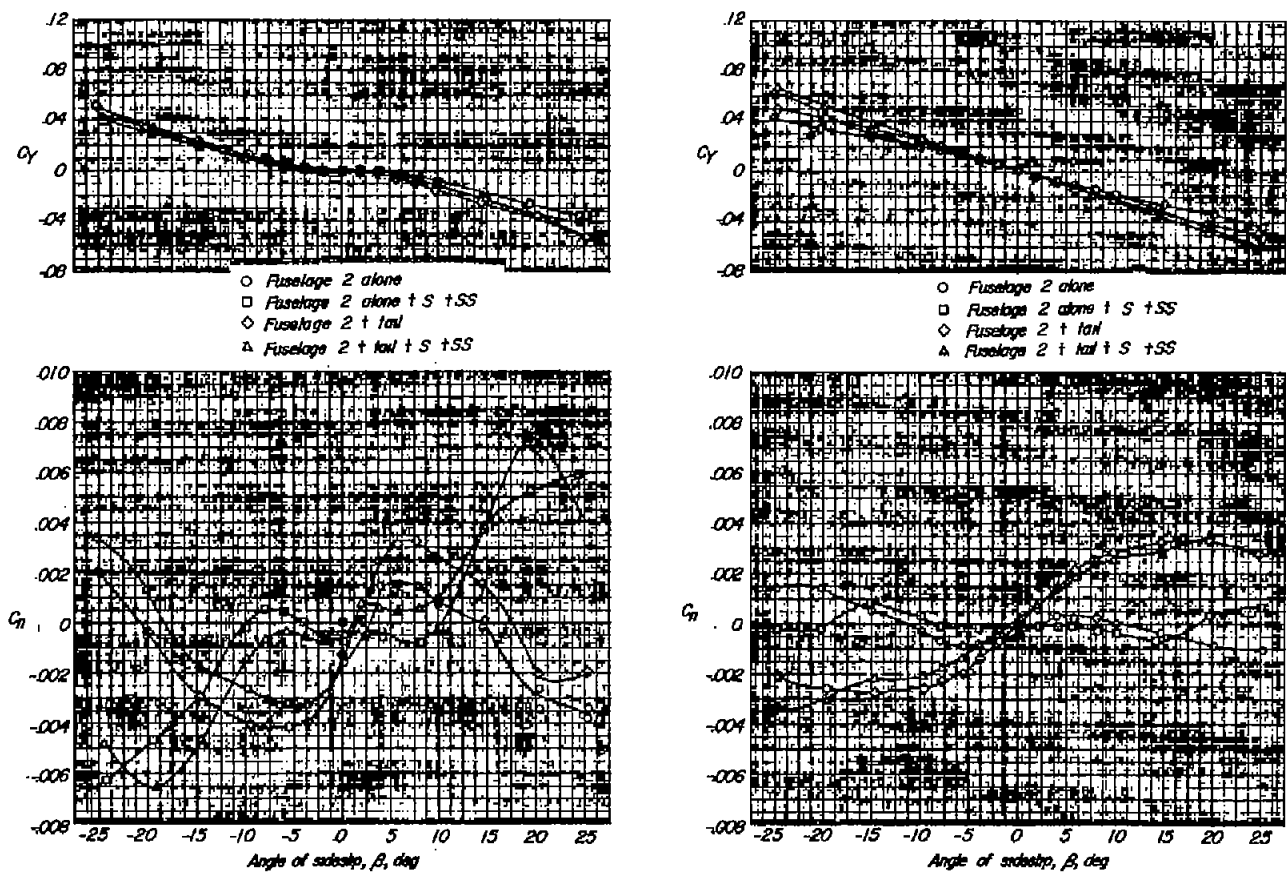

(a) $\alpha = 10^\circ$.

(b) $\alpha = -10^\circ$.

Figure 13.- Effect of spoilers on side-force and yawing-moment characteristics in sideslip of fuselage 2 at several angles of attack.

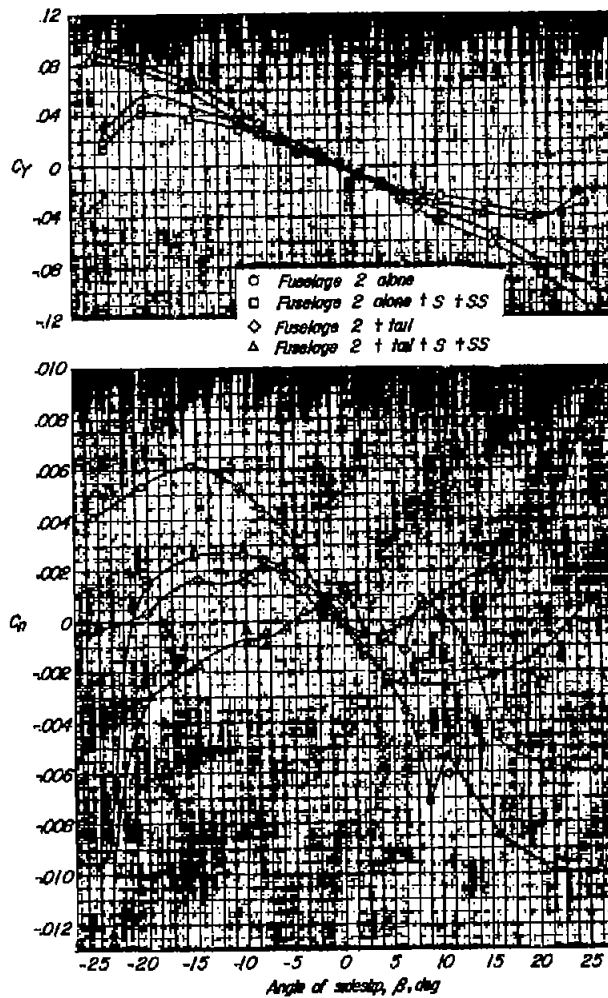

(c) $\alpha = 30^\circ$.

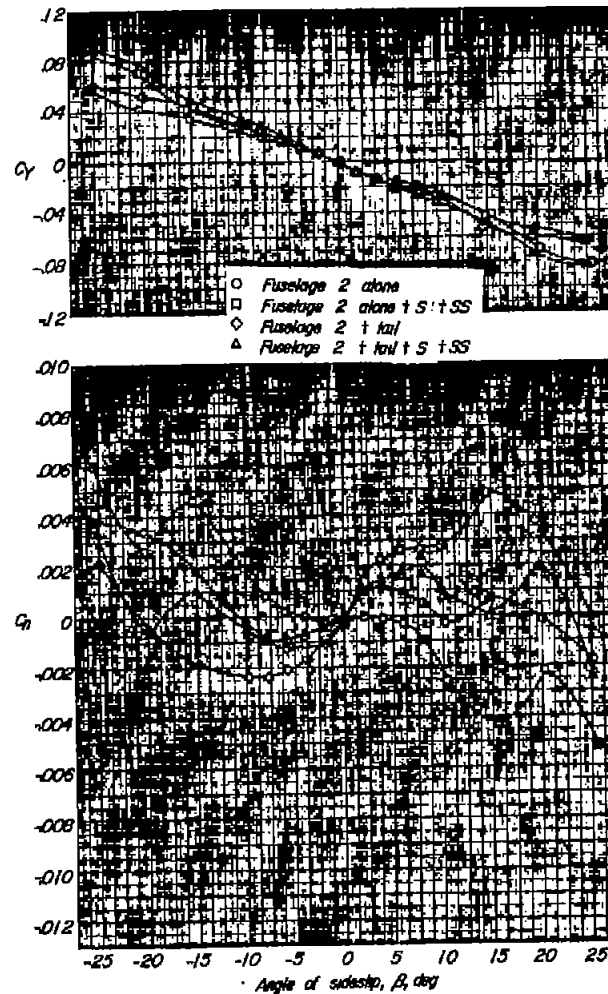

(d) $\alpha = -30^\circ$.

Figure 13.- Concluded.

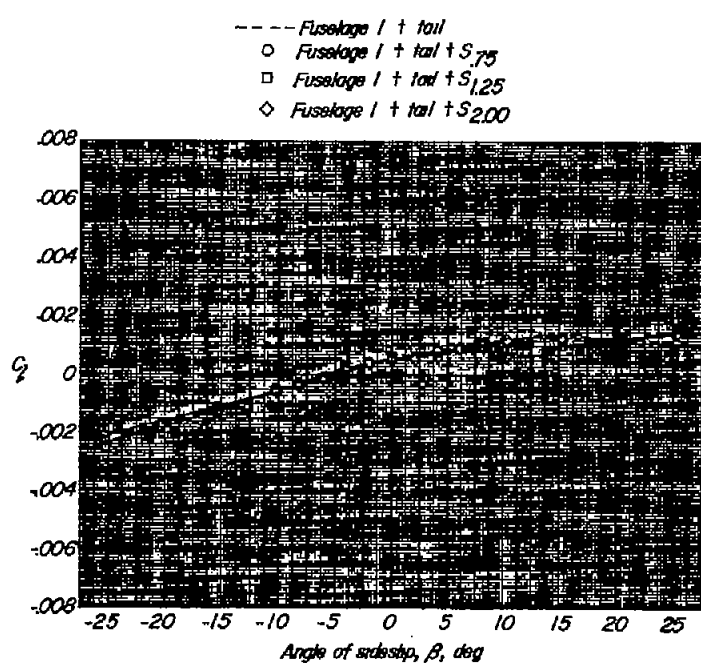

(a) $\alpha = 10^\circ$.

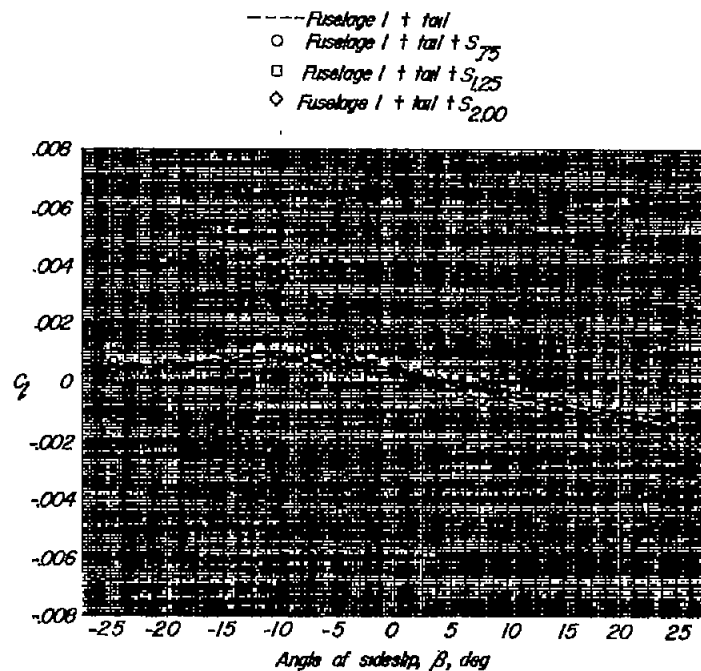

(b) $\alpha = -10^\circ$.

Figure 14.- Effect of spoiler on rolling-moment characteristics in sideslip at several angles of attack. Spoilers located 0.75, 1.25, and 2.00 inches from fuselage nose.

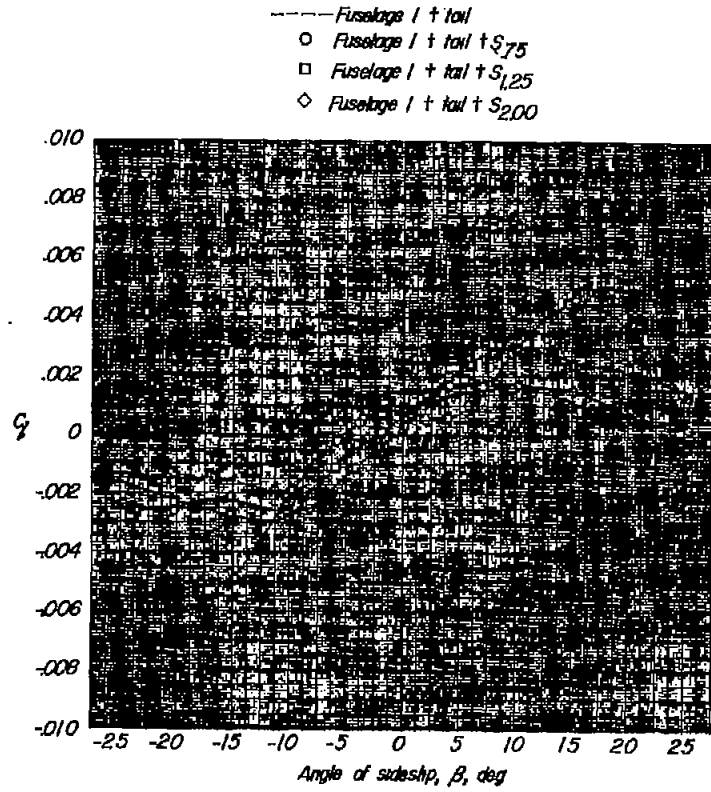

(c) $\alpha = 30^\circ$.

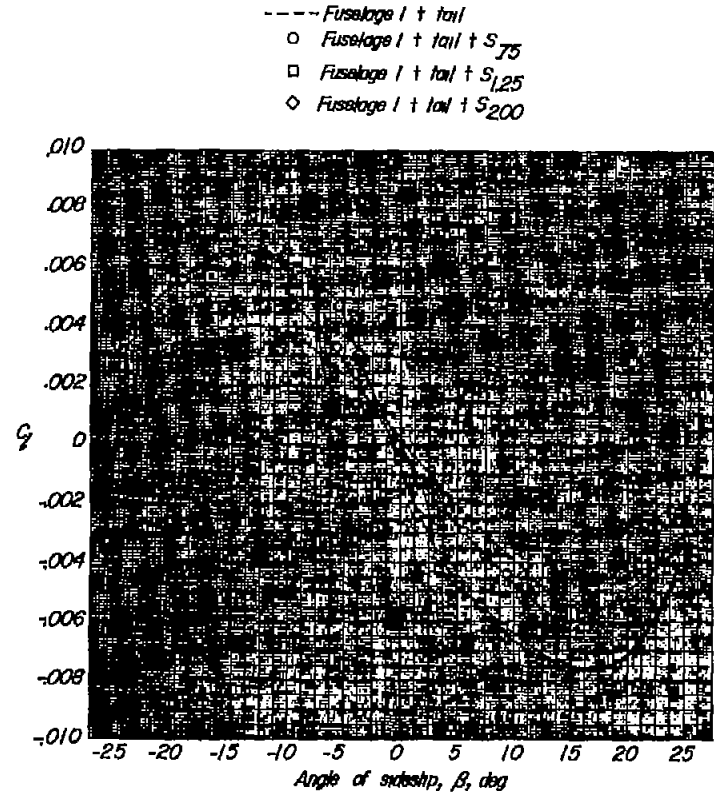

(d) $\alpha = -30^\circ$.

Figure 14.- Concluded.

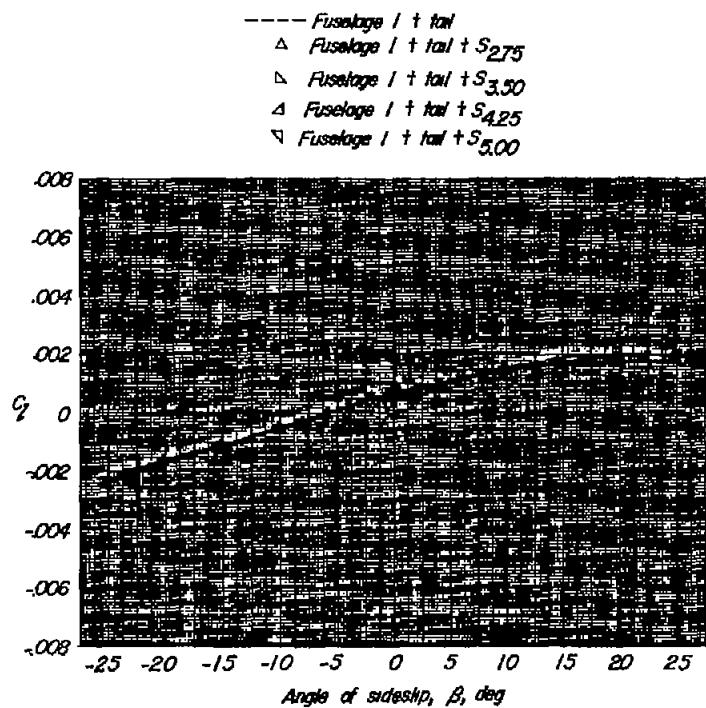

(a) $\alpha = 10^\circ$.

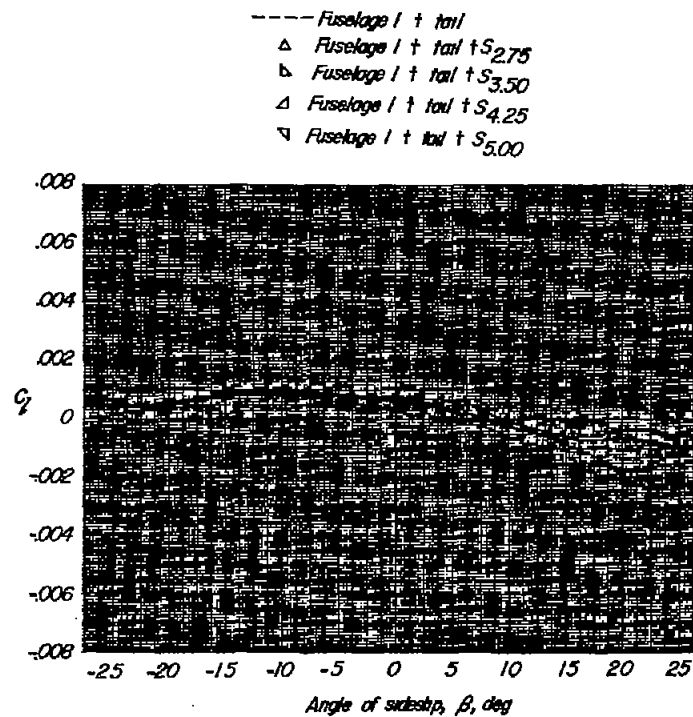

(b) $\alpha = -10^\circ$.

Figure 15.- Effect of spoilers on rolling-moment characteristics in sideslip at several angles of attack. Spoilers located 2.75, 3.50, 4.25, and 5.00 inches from fuselage nose.

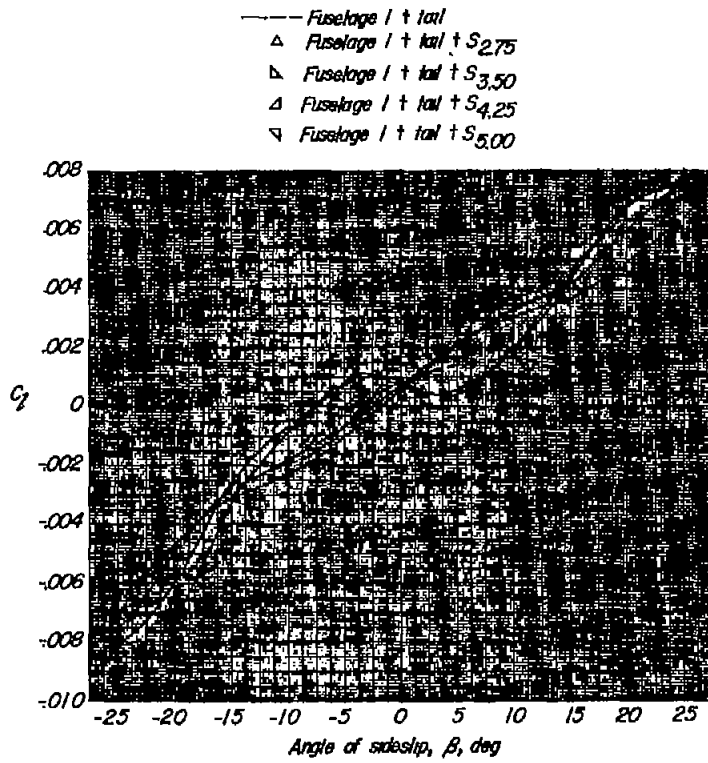

(c) $\alpha = 30^\circ$.

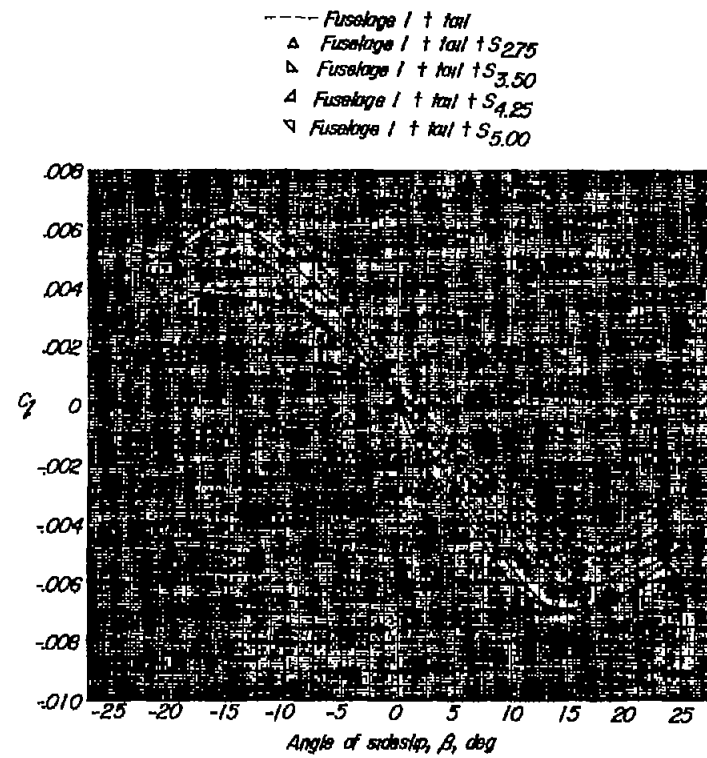

(d) $\alpha = -30^\circ$.

Figure 15.- Concluded.

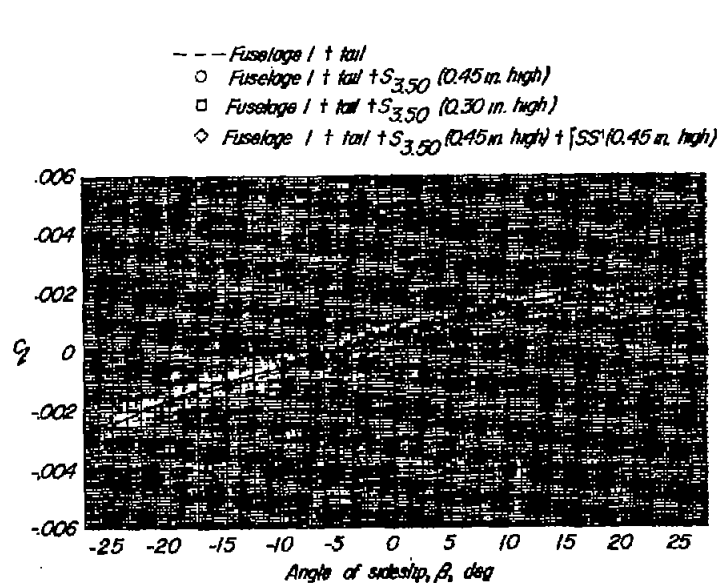

(a) $\alpha = 10^\circ$.

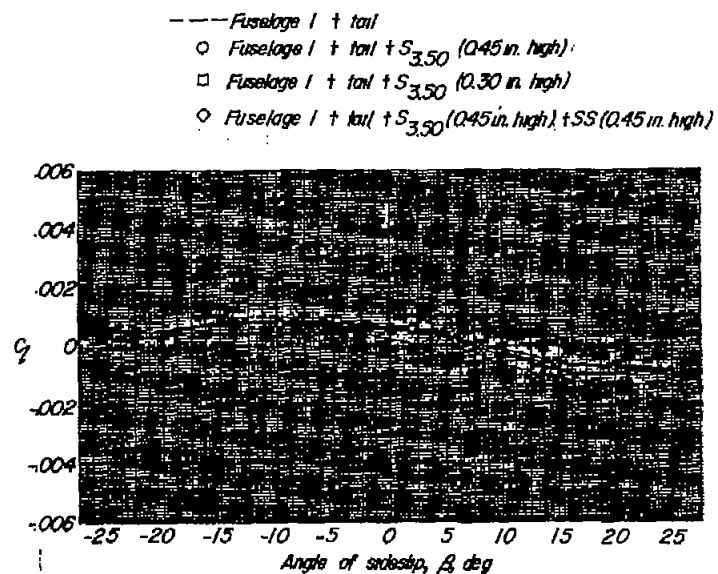

(b) $\alpha = -10^\circ$.

Figure 16.- Effect of spoiler size and spoiler strips on rolling-moment characteristics in side-slip at several angles of attack.

- Fuselage + tail
- Fuselage + tail + $S_{3.50}$ (0.45 in. high)
- Fuselage + tail + $S_{3.50}$ (0.30 in. high)
- ◇ Fuselage + tail + $S_{3.50}$ (0.45 in. high) + SS (0.45 in. high)

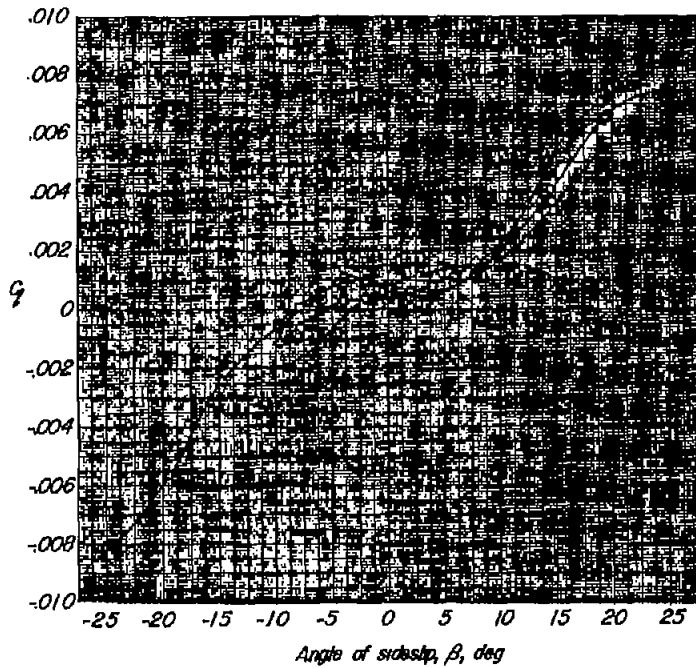

(c) $\alpha = 30^\circ$.

- Fuselage + tail
- Fuselage + tail + $S_{3.50}$ (0.45 in. high)
- Fuselage + tail + $S_{3.50}$ (0.30 in. high)
- ◇ Fuselage + tail + $S_{3.50}$ (0.45 in. high) + SS (0.45 in. high)

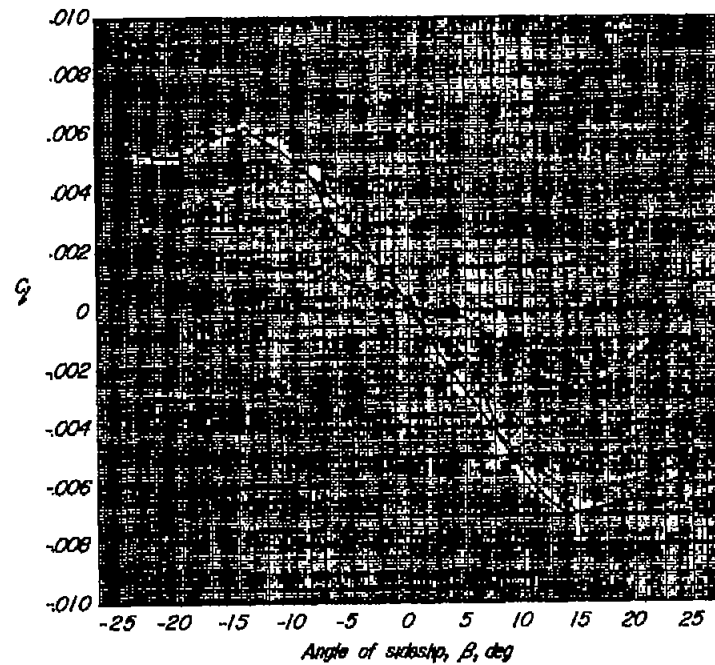

(d) $\alpha = -30^\circ$.

Figure 16.- Concluded.

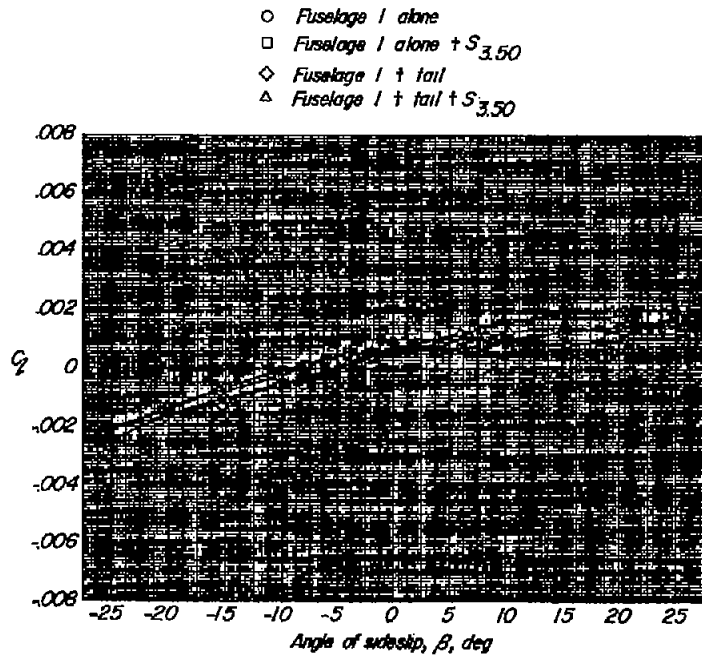

(a) $\alpha = 10^\circ$.

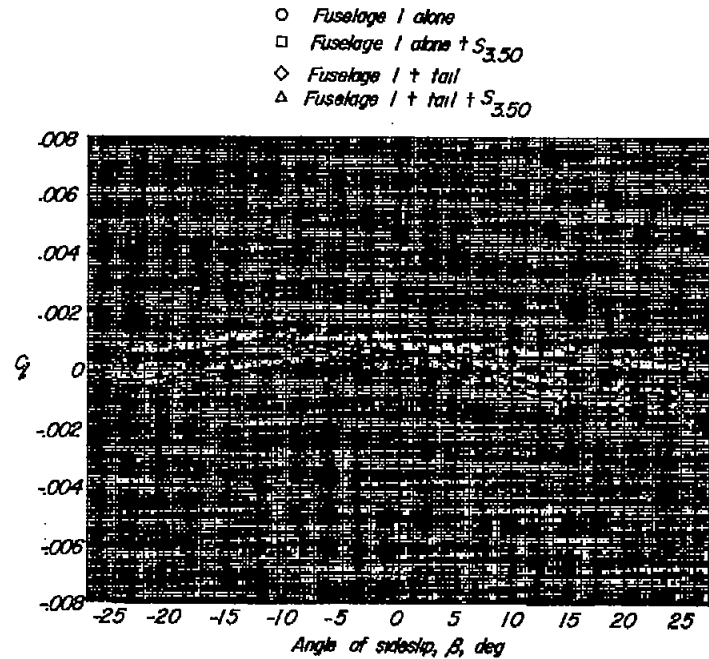

(b) $\alpha = -10^\circ$.

Figure 17.- Effect of tail and spoiler on rolling-moment characteristics in sideslip of fuselage alone at several angles of attack.

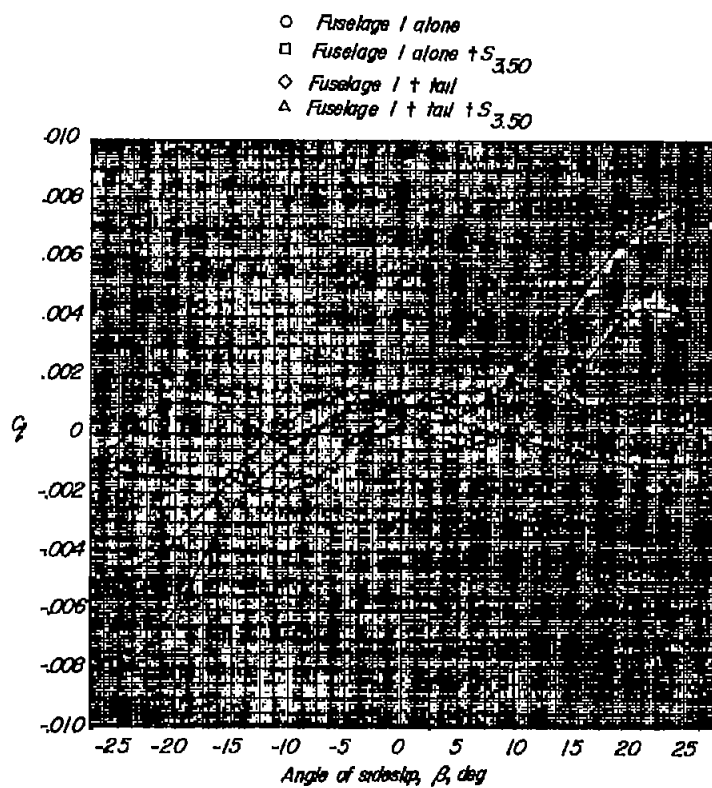

(c) $\alpha = 30^\circ$.

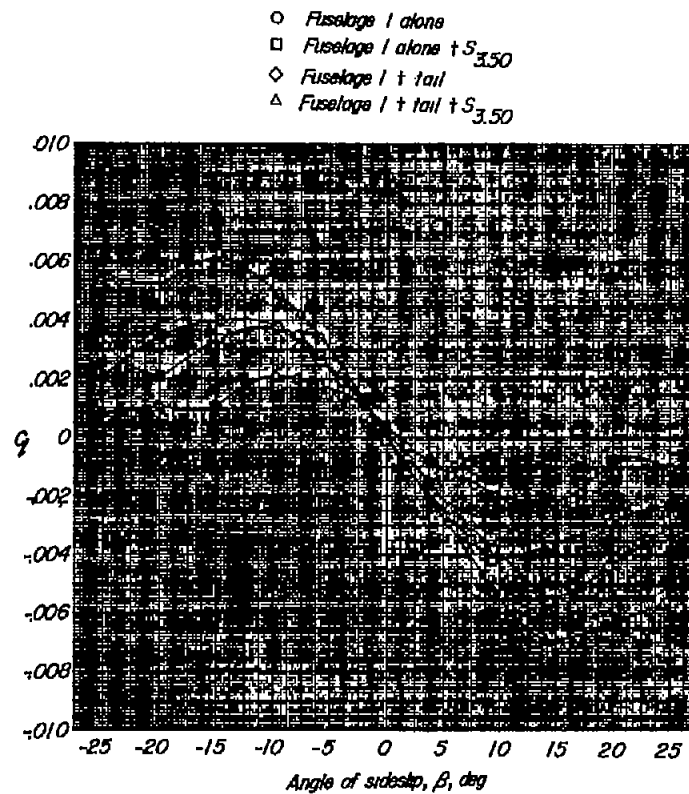

(d) $\alpha = -30^\circ$.

Figure 17.- Concluded.

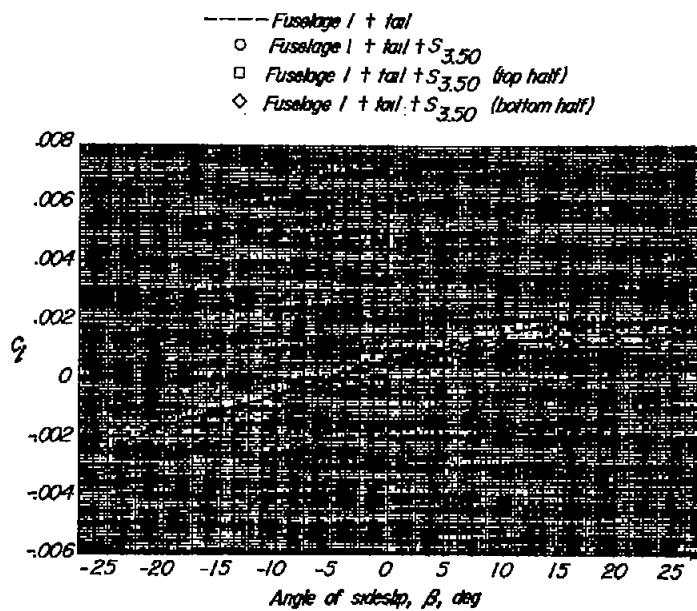

(a) $\alpha = 10^\circ$.

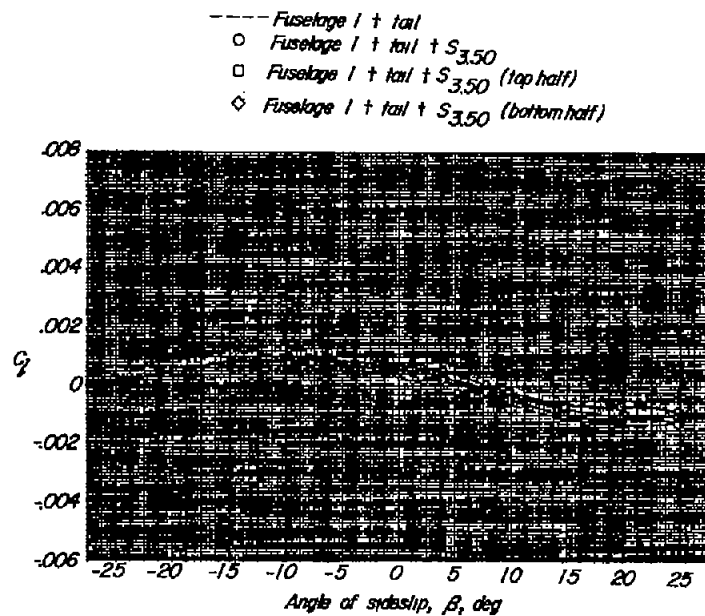

(b) $\alpha = -10^\circ$.

Figure 18.- Effect of using only one-half of spoiler on rolling-moment characteristics in sideslip at several angles of attack.

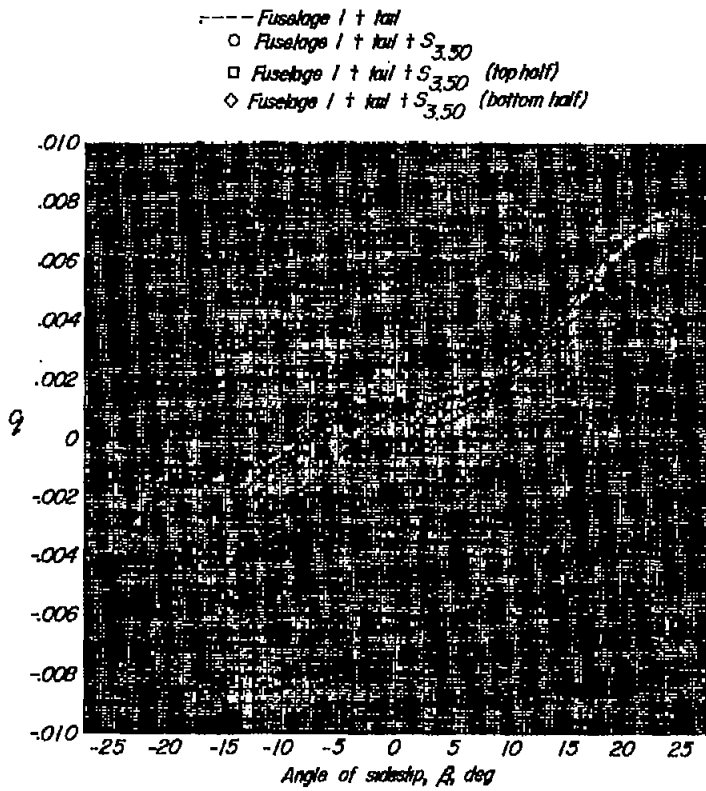

(c) $\alpha = 30^\circ$.

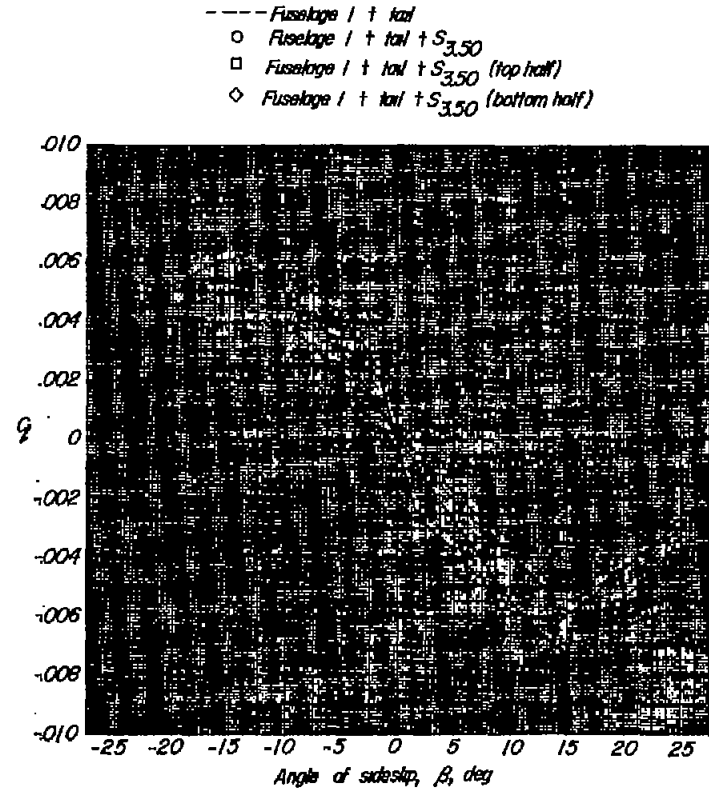

(d) $\alpha = -30^\circ$.

Figure 18.- Concluded.

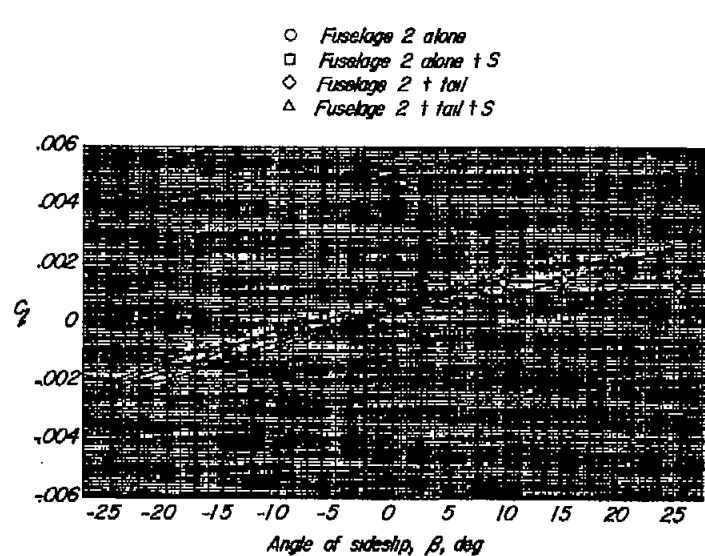

(a) $\alpha = 10^\circ$.

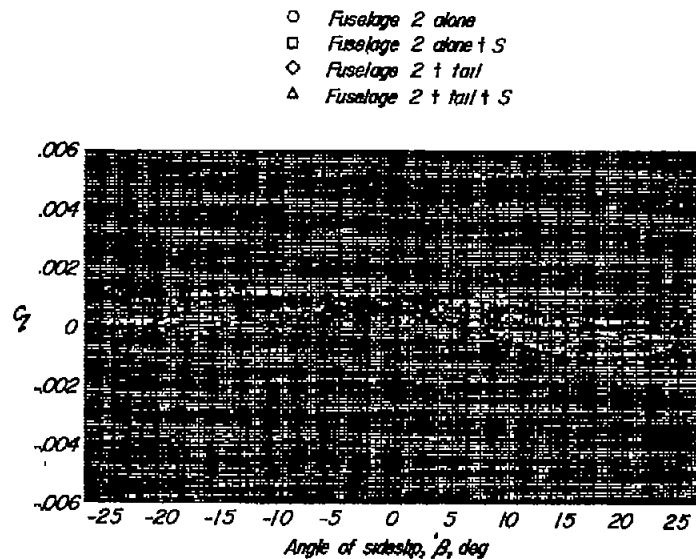

(b) $\alpha = -10^\circ$.

Figure 19.- Effect of spoilers on rolling-moment characteristics in sideslip of fuselage 2 at several angles of attack.

- Fuselage 2 alone
- Fuselage 2 alone + S
- ◇ Fuselage 2 + tail
- △ Fuselage 2 + tail + S

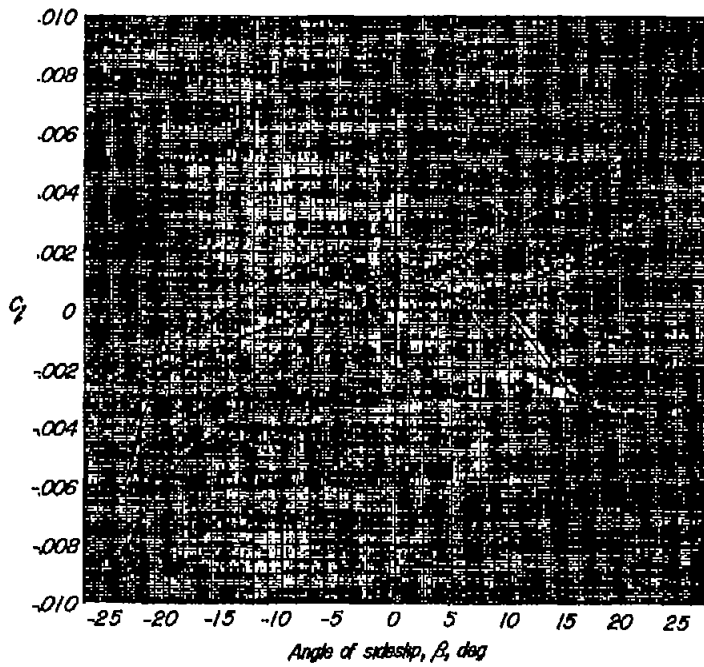

(c) $\alpha = 30^\circ$.

- Fuselage 2 alone
- Fuselage 2 alone + S
- ◇ Fuselage 2 + tail
- △ Fuselage 2 + tail + S

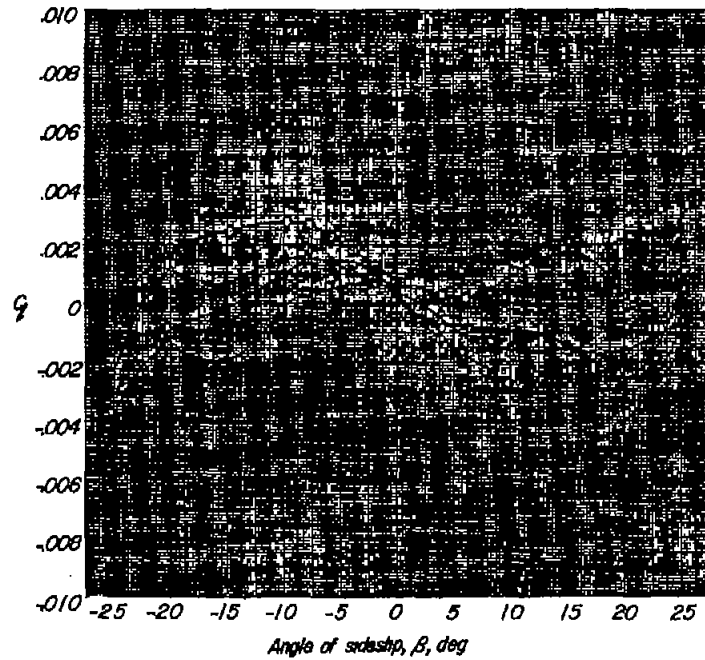

(d) $\alpha = -30^\circ$.

Figure 19.- Concluded.

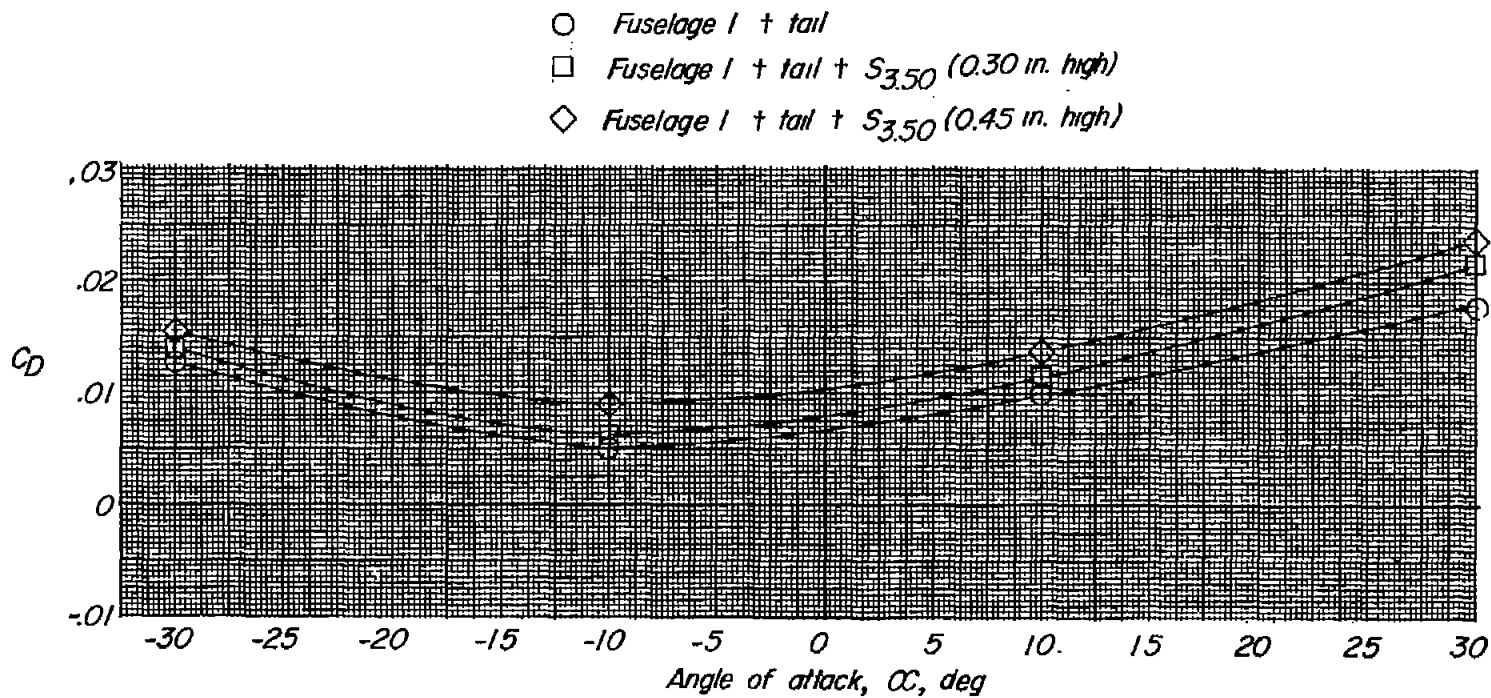

Figure 20.- Variation of drag coefficient with angle of attack ($\beta = 0$) for fuselage 1 with tail.