

*Library, L. M. A. I.*

*Copy 2*

TECHNICAL NOTES

NATIONAL ADVISORY COMMITTEE FOR AERONAUTICS

---

No. 460

---

FULL-SCALE WIND-TUNNEL RESEARCH ON  
TAIL BUFFETING AND WING-FUSELAGE INTERFERENCE OF  
A LOW-WING MONOPLANE

By Manley J. Hood and James A. White  
Langley Memorial Aeronautical Laboratory

---

Washington  
May, 1933



NATIONAL ADVISORY COMMITTEE FOR AERONAUTICS

TECHNICAL NOTE NO. 460

FULL-SCALE WIND-TUNNEL RESEARCH ON  
TAIL BUFFETING AND WING-FUSELAGE INTERFERENCE OF  
A LOW-WING MONOPLANE

By Manley J. Hood and James A. White

SUMMARY

This report is a presentation of some preliminary results of an investigation conducted in the N.A.C.A. full-scale wind tunnel to determine the best means of reducing the tail buffeting and wing-fuselage interference of a low-wing monoplane. Data indicating the effects of an N.A.C.A. engine cowling, fillets, auxiliary airfoils of short span, reflexed trailing edge, propeller slipstream, and various combinations of these features are included.

The results of the tests showed that the N.A.C.A. cowling reduced the interference and buffeting to magnitudes small enough to be considered unobjectionable at angles of attack up to within  $3^{\circ}$  or  $4^{\circ}$  of the stall. The fillets, either alone or in combination with the N.A.C.A. cowling or a reflexed trailing edge, reduced the buffeting and interference to unobjectionable magnitudes at angles of attack up to the stall. A large fillet, when used alone, reduced the buffeting oscillations to one seventh their original amplitudes thus giving the greatest reduction obtained. The best all-round results were obtained by the use of fillets together with the N.A.C.A. cowling. This combination reduced the tail buffeting oscillations to one fourth their original amplitudes, increased the maximum lift 11 percent, decreased the minimum drag 9 percent, and increased the maximum ratio of lift to drag 19 percent.

INTRODUCTION

The increasing use of low-wing monoplanes has emphasized the susceptibility of this type of airplane to detrimental wing-fuselage interference. This interference was first indicated by inferior aerodynamic characteristics of the low-wing as compared to the high-wing monoplane.

In addition to reducing the aerodynamic efficiency, this interference produces other highly objectionable conditions resulting from the eddying wake from the region of the wing-fuselage intersection flowing over the empennage. The position of the tail surfaces in this eddying wake sometimes makes difficult the attainment of satisfactory longitudinal control and stability. The buffeting action of the eddying wake often causes an irregular oscillation, or shaking, of the tail surfaces. Tail buffeting may become severe enough in some cases to result in structural failure. It has been charged by one group of investigators (references 1 and 2) with having been the cause of an accident to a low-wing monoplane which disintegrated in the air, although another group of investigators (references 3 and 4) did not concur in this opinion.

A number of devices for reducing the wing-fuselage interference have been proposed (references 5 to 9, inclusive). This note presents the effects of several of them, as determined by an investigation in the N.A.C.A. full-scale wind tunnel.

The primary result of the wing-fuselage interference appeared to be a premature breaking down of the air flow in the region of the intersection of the wing with the fuselage. For this reason, the devices for reducing the interference were designed to postpone the breaking down of the flow in this region to the angle of attack at which the entire wing stalled. The devices tested were: two different fillets at the wing-fuselage intersection; a reflexed trailing edge on the wing near the fuselage, both alone and in combination with a fillet; short-span auxiliary airfoils in three different positions; and an N.A.C.A. engine cowling, alone and in combination with each of the other devices except the auxiliary airfoils.

The value of these devices in reducing the interference was studied in several different ways: Visual observations of the air flow in the region of the wing-fuselage intersections were made with strings; the velocity and direction of the air flow in the region of the empennage were measured; the lift and drag characteristics were determined for all the conditions investigated; longitudinal control and stability were investigated by measuring the pitching moments with various elevator settings and with the empennage removed; and the amplitude and frequency of the vertical movements of the stabilizer tip were measured. The above characteristics were measured

both with and without the slipstream from the airplane's propeller.

This is a preliminary report and covers only the observations of the air flow in the region of the wing-fuselage intersection, the lift and drag characteristics, and the tail vibrations. The complete results will be presented in a later report.

#### APPARATUS

Wind tunnel.- The tests discussed in this report were made in the N.A.C.A. full-scale wind tunnel described in reference 10.

Airplane.- The McDonnell airplane, a low-wing type, which was originally built for entry in the Daniel Guggenheim Safe Aircraft Competition in 1929, was used for the tests described in this report. It was chosen for these tests because it had been reported by pilots to be subject to tail buffeting. Flight tests of the McDonnell airplane are described in reference 11. The airplane, equipped with the large fillet and mounted on the balance in the full-scale wind tunnel, is shown in figure 1. A 3-view drawing, giving its principal dimensions, is shown on figure 2. The airplane was equipped with a Warner "Scarab" engine having a rating of 110 horsepower at 1,850 r.p.m. The leading-edge slots and trailing-edge flaps with which the airplane was equipped were not used in this series of tests. The flaps were locked in the neutral position and the slots were prevented from opening by covering the slats and forward part of the wings with doped fabric. After preliminary tests had been made, a walkway that raised the top surface of the right wing five eighths of an inch above the normal profile from 15 to 69 percent of the chord and from the fuselage to 10 inches outboard was removed, and the gaps (fig. 3) between the wings and fuselage were covered. The stabilizer was set at an incidence of  $0.6^\circ$  with respect to the thrust axis for all the tests.

N.A.C.A. engine cowling.- The N.A.C.A. engine cowling consisted of a hood that was placed over the engine and nose of the airplane without altering the original fuselage lines. The hood was designed in accordance with the information in reference 12 except that it consisted of only one thickness of metal, and consequently its cross

section did not resemble an airfoil profile. Figure 4 shows the nose of the airplane in the original condition and with the hood in place.

Fillets.— The wing-fuselage fillets (figs. 5 to 8, inclusive) were designed to reduce the rate at which it was necessary for the air in this region to diverge in order to follow the surfaces. The radius was small at the leading edge and a short distance back started increasing smoothly to a maximum at the trailing edge, behind which the fillet was faired into the fuselage. The principal difference between the two fillets was their size; hence, they will be referred to as the small fillet (figs. 5 and 7) and the large fillet (figs. 6 and 8). Another difference was that the small fillet had a constant radius from the leading edge back to 41 percent of the chord, whereas the radius of the large fillet began to increase at 6.6 percent of the chord behind the leading edge.

Reflexed trailing edge.— The modification of the wing root, herein called a reflexed trailing edge (fig. 9), was designed to decrease the incidence at the wing root. The lower surface of the wing, which had an upward curvature (N.A.C.A.-M6 profile), was extended to the rear and a new upper surface was formed by straight elements from the new trailing edge to the points of tangency with the upper surface of the original wing. The fillet that was tested in combination with this reflexed trailing edge (fig. 10) was similar to the large one previously described.

Auxiliary airfoils.— The auxiliary airfoils used in these tests were of the N.A.C.A 22 profile, had a 10-inch chord (14.7 percent of the main wing chord), and extended 30 inches from the fuselage on each side. They were first located in a position similar to that found to be the optimum in the investigation reported in reference 13, with the trailing edge 15 percent of the main wing chord ahead of and 8.2 percent above the leading edge of the main wing, and the chord parallel to the main wing chord. In the second position the trailing edge of the auxiliary was 6.5 percent directly above the leading edge of the main wing, and the incidence of the auxiliary was  $-30^{\circ}$  with respect to the chord of the main wing. In the third position the trailing edge was 5.2 percent behind and 7.5 percent above the leading edge of the main wing, and the incidence was  $-25.5^{\circ}$ .

## METHODS

Lift and drag measurements.-- The power-off lift and drag characteristics were determined with the propeller removed. The power-on characteristics were determined with the propeller running at such a speed that its thrust just balanced the drag of the airplane (making due allowance for jet-boundary effect), in order to simulate steady flight conditions. These characteristics were all measured at an air speed of between 55 and 60 miles per hour, except that at the higher angles of attack the speed was reduced during the power-on tests in order to make the drag of the airplane low enough to be balanced by the propeller thrust.

Investigation of air flow.-- The flow of air in the region of the wing-fuselage intersection was studied by making visual observations of its effect on light strings held at various points in this region by observers in the cockpits.

Records of tail buffeting.-- The vertical movements of the tip of the stabilizer were recorded on a moving film by an N.A.C.A. control-position recorder (reference 14) modified to give a 1-inch deflection of the image on the film for a 1.65-inch vertical movement of the stabilizer tip and from these records the amplitude and frequency were determined. The instrument was mounted on a solid base in the balance room and connected to the right stabilizer tip with an 0.008-inch-diameter piano wire that, except for about 2 inches at the top, was shielded from the air stream by a tube. The natural vibration frequency of the instrument and piano wire was about 34 vibrations per second. As this is four times the frequency of the fastest stabilizer oscillations recorded, it insures that the instrument was capable of accurately following the movements of the stabilizer. Play and friction in the linkage of the instrument resulted in small errors in the indicated amplitudes of stabilizer oscillations which probably did not exceed one eighth inch. During most of these tests the tail of the airplane was supported by a rigid "A" frame fastened to the tailpost. In order to determine the effect of this rigid support records were made of the movements of the stabilizer tip and the rear end of the fuselage while the tail of the airplane was free from external support, and the airplane was prevented from turning about the main supports at the landing-wheel axles



only by cables secured to the forward part of the fuselage. Most of the measurements of stabilizer-tip movements were made at an air speed of about 58 miles per hour but a few were made at different air speeds between 35 and 60 miles per hour to determine the effect of air speed on the buffeting.

## RESULTS

Lift and drag characteristics.-- The power-off lift and drag characteristics are presented as polars and lift and drag curves in four groups. The first group (figs. 11 and 12) shows a comparison of the results obtained with the various fillets, both alone and with the N.A.C.A. engine cowling. The second group (figs. 13 and 14) shows curves for the airplane with the reflexed trailing edge alone and in combinations with engine cowling and fillet. The third group (figs. 15 and 16) shows the effects of the auxiliary airfoils in different positions. The fourth group (figs. 17 and 18) is a summary of the first three groups. Curves showing theoretical induced drag, computed on the basis of the geometrical aspect ratio (6.23) of the wing, and the lift and drag characteristics for the airplane in the original condition are shown with each group. Three representative polars are shown with their experimental points (figs. 19 to 21, inclusive).

The power-on lift characteristics are shown plotted against angle of attack for the airplane in the original condition (fig. 22), and when equipped with the large fillet and N.A.C.A. engine cowling (fig. 23). These characteristics for all other conditions tested were practically identical to those shown in figure 23. The curves show values of lift coefficient with the engine developing a thrust equal to the drag, which is the same condition as in steady flight. As it was not practicable to hold the engine speed so as to give exactly zero drag, three readings were taken at each angle of attack at approximately the proper engine speed, and the lift at zero net drag, determined by plotting these three readings against net drag. No means were available for determining the thrust of the propeller; so it was not possible to determine exactly either the effect of the slipstream on the drag characteristics of the airplane or the part of the total lift that was due to the vertical component of the propeller thrust. An approximate correction, however, for this vertical component of thrust was applied in order to

make the difference between the power-off and power-on lift curves more nearly represent the effect of the slipstream; and the lift curves are shown both with and without this correction. These approximate corrections were arrived at by computing, for each angle of attack, the vertical component of a thrust large enough to overcome the drag of the airplane without the slipstream.

All the results have been corrected for wind-tunnel effects to make them comparable to actual flight. All coefficients were based on the original wing area of 196.5 square feet.

Air flow.- The action of the strings that were used to study the air flow in the region of the wing-fuselage intersection indicated that, except when the airplane was equipped with some of the most effective devices, the breaking down of the air flow over the upper surface of the wing originated near its intersection with the fuselage and spread laterally as the angle of attack was increased. With the airplane in the original condition the turbulent flow extended approximately 3 feet outboard from the fuselage at 14° angle of attack. The approximate angles of attack at which the air flow over the root of the wing first broke down when the airplane was equipped with the various devices were as follows:

Original condition	5°
N.A.C.A. engine cowling	14°
Small fillet	12°
Large fillet	15°
Small fillet and N.A.C.A. engine cowling	17° (at stall)
Large fillet and N.A.C.A. engine cowling	17° (at stall)
Reflexed trailing edge	7°
Reflexed trailing edge and N.A.C.A. engine cowling	16° (at stall)



Reflexed trailing edge and fillet	Above stall
Reflexed trailing edge, fillet, and N.A.C.A. engine cowling	Above stall
Auxiliary airfoil in first position	7°
Auxiliary airfoil in second position	7°
Auxiliary airfoil in third position	10°

In cases when auxiliary airfoils were used, vortices trailing from their tips were evident. When the N.A.C.A. cowling was used, particularly when in combination with any of the fillets and both with and without the slipstream, the action of the strings indicated the presence of vortices which were approximately concentric with the fillets and trailed to the rear. The vortex on the right side turned counterclockwise and the one on the left clockwise as viewed from the rear.

Tail buffeting.— Typical records of stabilizer-tip movements are shown on figure 24.

Maximum amplitude of the movements of the stabilizer tip under various conditions is shown plotted against angle of attack in degrees above and below the angle of maximum lift (fig. 25). Amplitude in this figure represents the total deflection of the tip from the maximum positive to the maximum adjacent negative position, and is expressed in inches of movement in the direction normal to the stabilizer. The amplitude of stabilizer-tip movements with the propeller operating is not included in figure 25 because it did not vary consistently enough to permit drawing curves. All the maximum deflections measured with power on fell between 0.1 and 0.4 inch for angles of attack below the stall. The figure applies only to amplitudes measured when the rear end of the fuselage was externally supported. When it was free from external support the amplitude of stabilizer-tip movement was nearly doubled, but corresponding movements of the rear end of the fuselage were only about one fifth as great as those of the stabilizer tip. Figure 26 shows the variation in

amplitude with changes of air speed between 35 and 60 miles per hour.

The natural vibration frequencies of the stabilizer were as follows:

With rear end of fuselage rigidly supported	7.3 vibrations per second
With rear end of fuselage free from external support	8.5 vibrations per second

The predominant frequencies when buffeting were approximately the same as the natural frequencies.

The stiffness of the stabilizer and fuselage was such that, when the rear end of the fuselage was externally supported, the stabilizer tip was deflected 1 inch by a force of 60 pounds concentrated at the tip.

#### DISCUSSION

Lift and drag characteristics.— The shape of the polar for the airplane in the original condition (fig. 19), compared with the theoretical induced drag polars based on the geometrical aspect ratio of the entire wing (6.2) and that of the part on one side of the fuselage (2.9), and also the slope of the lift curve (fig. 12), indicate that the abnormal increase in drag and reduction in lift at the higher angles of attack was largely due to the fact that the lift normally given by the roots of the wings and the span across the fuselage had been destroyed by the breakdown of the flow near the wing-fuselage intersection so that the part of the wing outboard of the disturbed region on each side of the fuselage was acting independently as a separate wing of lower aspect ratio.

The N.A.C.A. engine cowlings, either fillet, or the combined reflexed trailing edge and fillet eliminated most of the adverse interference, as is indicated by the straightness of the lift curves and parallelism of the polars to the induced drag polar (figs. 11, 12, 17, and 18). All these devices increased the angle of attack at which the flow over the wing roots became unstable to within 3° or 4° of the angle of attack of maximum lift, and the com-

combined reflexed trailing edge and fillet postponed the breakdown to well beyond the angle at which the main part of the wing stalled. The minimum drag coefficient was slightly increased by the combined reflexed trailing edge and fillet, not affected by the small fillet, and reduced from 0.0637 to 0.0625 by the large fillet and to 0.0590 by the N.A.C.A. engine cowling.

The magnitude of the improvement obtained by the use of the cowling alone indicated that, as might be expected, conditions which disturb the air flow ahead of the region of the wing-fuselage intersection may have important effects on the degree of interference.

It was found that when fillets were used alone the large one was slightly superior (figs. 11 and 12). When they were used in combination with the N.A.C.A. cowling, however, the small fillet gave results (not shown in this report) almost identical with those obtained with the large fillet and cowling.

An unstable flow in the region of maximum lift when the airplane was equipped with either the N.A.C.A. cowling or the fillet was evidenced by the double lift curves and polars (figs. 17, 18, and 20). The use of the cowling and fillet in combination eliminated this unstable condition (fig. 21). The combination reduced the minimum drag by an amount practically equal to the sum of the reductions given by the two devices when used alone.

The reflexed trailing edge, when used alone, had a negligible effect on the lift and drag characteristics.

The auxiliary airfoils gave their best results when in the third position, but even then the improvement over the original condition was only about one half that obtained with the fillets or cowling. It is probable, however, that the optimum position was not found, because only three were tested.

The effect of the slipstream was sufficient to prevent a premature breakdown of the flow near the wing-fuselage intersection in all except the original condition, and in this condition it postponed the breakdown from about  $5^{\circ}$  to  $12^{\circ}$  angle of attack. It is not practicable, however, to depend on the slipstream for maintaining the smooth flow, especially during landing.

Preliminary tests showed that the presence of the raised walkway had no appreciable effect on the characteristics of the airplane when equipped with the small fillet and that when the airplane was not equipped with any of the special devices removing the walkway and covering the gaps between the wing and fuselage had a negligible effect.

The maximum lift coefficient of the airplane in its original condition, as determined by these tests, was considerably higher than the highest lift coefficient (with slots closed and flaps neutral) measured in flight. This apparent discrepancy was due to the fact that the airplane did not have sufficient longitudinal control to permit flying at angles of attack above  $16^{\circ}$ . (See reference 11.)

The best lift and drag characteristics were obtained when fillets and N.A.C.A. cowling were used together. The use of this combination eliminated most of the wing-fuselage interference, increased the maximum lift 11 percent above its original value, decreased the minimum drag 9 percent, and increased the maximum ratio of lift to drag 19 percent.

Air flow.— The observations made of the air flow with strings agreed well with the lift curves and polars in showing the angles of attack at which the air flow first broke down over the wing roots, and indicating the relative effectiveness of the different devices in reducing the wing-fuselage interference.

Tail buffeting.— The effectiveness of the various devices in reducing tail buffeting is best visualized by reference to figure 25. The buffeting oscillations were reduced to amplitudes small enough to be considered unobjectionable throughout the range of normal flight attitudes by the use of the fillets, either alone or in any combination with the N.A.C.A. engine cowling or reflexed trailing edge. The use of the large fillet alone reduced the oscillations to one seventh their original amplitudes and the use of the same fillet with the N.A.C.A. cowling, the combination which gave the best lift and drag characteristics, reduced the oscillations to one fourth their original amplitudes.

In general, the devices which gave the greatest improvement in lift and drag characteristics also gave the greatest reduction in tail buffeting. The N.A.C.A. cowling was an exception to this rule. When it was used either alone or in combination with other devices, the ampli-

tudes of the buffeting oscillations were slightly greater than would be expected from the improvement in lift and drag.

The slipstream was shown to be practically as effective as the fillets in reducing buffeting with the airplane in the original condition, but had only a small effect when the airplane was equipped with fillets or cowling.

In all cases the stabilizer vibrated at a predominant frequency that was practically the same as the natural frequency of the surface and the amplitude varied irregularly in a manner similar to that shown on the typical records (fig. 24).

The vibrations of the stabilizer obtained under the conditions of these tests do not necessarily correspond exactly to those that would be obtained in flight, because of the way in which the airplane was supported, but they do afford good comparisons between the degrees of buffeting existing under the various conditions tested. The special tests made with the rear end of the fuselage free from external support indicate that the amplitude of stabilizer vibrations which would exist in flight would be considerably greater than those shown on figure 25. The frequency is apparently dependent upon the natural frequency of the tail structure.

The severity of buffeting was shown to increase rapidly with increase in air speed between 35 and 60 miles per hour (fig. 26). It cannot be assumed, however, that this increase would continue at velocities above those investigated, because the relations may be affected by resonance between the natural frequency of the tail and the frequency of the buffeting eddies. An investigation of the frequencies of eddies trailing from the wing roots of different airplanes would yield information which would be very useful in tail surface design.

#### CONCLUSIONS

1. Fillets reduced the wing-fuselage interference and tail buffeting to unobjectionable magnitudes throughout the range of normal flight attitudes.
2. N.A.C.A. engine cowling reduced the wing-fuselage

interference and tail buffeting to unobjectionable magnitudes at angles of attack up to within  $3^{\circ}$  of the stall.

3. The reflexed trailing edge slightly increased the amplitude of tail oscillations due to buffeting.

4. The auxiliary airfoils, in the positions tested, reduced the interference and buffeting but were considerably inferior to the fillets.

5. Buffeting was least when the large fillet was used alone. This fillet reduced the amplitude of stabilizer-tip oscillations at an angle of attack  $2^{\circ}$  below the stall from the 1.37 inches obtained with the airplane in the original condition to 0.18 inch.

6. The combination of fillets and N.A.C.A. engine cowling gave the best all-round results. This combination reduced the total amplitude of stabilizer-tip oscillations at an angle of attack  $2^{\circ}$  below maximum lift from the original 1.37 inches to 0.32 inch, increased the maximum lift 11 percent, decreased the minimum drag 9 percent, and increased the maximum lift/drag ratio 19 percent.

Langley Memorial Aeronautical Laboratory,  
National Advisory Committee for Aeronautics,  
Langley Field, Va., April 18, 1933.

#### REFERENCES

1. Accidents Investigation Sub-committee: Accident to the Aeroplane G-AAZK at Meopham, Kent, on 21st July, 1930. R. & M. No. 1360, British A.R.C., 1931.
2. Aerodynamics Staff of the National Physical Laboratory: Two Reports on Tail Buffeting. R. & M. No. 1457, British A.R.C., 1932.
3. Blenk, Hermann; Hertel, Heinrich; and Thalau, Karl: The German Investigation of the Accident at Meopham (England). T.M. No. 669, N.A.C.A., 1932.
4. Blenk, Hermann: "Über neuere englische Arbeiten zur Frage des Leitwerkschüttelns. Z.F.M., vol. 24, No. 1, Jan. 14, 1933.



5. Klein, A. L.: Effect of Fillets on Wing-Fuselage Interference. Paper presented before A.S.M.E., Berkley, Calif., June 9 and 10, 1932.
6. Jacobs, H. H., and Anderson, H. L.: Wind Tunnel Tests of Fokker XA-7 with Cockpit Cowls, Auxiliary Stub Wings, Reflexed Trailing Edge, and Airfoil Wing-Bracing Struts. Air Corps Technical Report, Serial No. 3623, Materiel Division, Army Air Corps, 1932.
7. Biechteler, Curt: Versuche zur Beseitigung von Leitwerkschütteln. Z.F.M., vol. 24, No. 1, Jan. 14, 1933.
8. Stieger, H. J.: Wing Construction. Roy. Aero. Soc. Jour., vol. XXXVI, No. 262, Oct., 1932.
9. Muttrey, E.: Investigation of the Effect of the Fuselage on the Wing of a Low-Wing Monoplane. T.M. No. 517, N.A.C.A., 1929.
10. DeFrance, Smith J.: The N.A.C.A. Full-Scale Wind Tunnel. T.R. No. 459, N.A.C.A., 1933.
11. Soule, Hartley A.: The Effect of Slots and Flaps on the Lift and Drag of the McDonnell Airplane as Determined in Flight. T.N. No. 398, N.A.C.A., 1931.
12. Weick, Fred E.: Drag and Cooling with Various Forms of Cowling for a "Whirlwind" Radial Air-Cooled Engine. T.R. No. 313, N.A.C.A., 1929.
13. Weick, Fred E., and Bamber, Millard J.: Wind-Tunnel Tests of a Clark Y Wing with a Narrow Auxiliary Airfoil in Different Positions. T.R. No. 428, N.A.C.A., 1932.
14. Ronan, K. M.: An Instrument for Recording the Position of Airplane Control Surfaces. T.N. No. 154, N.A.C.A., 1923.

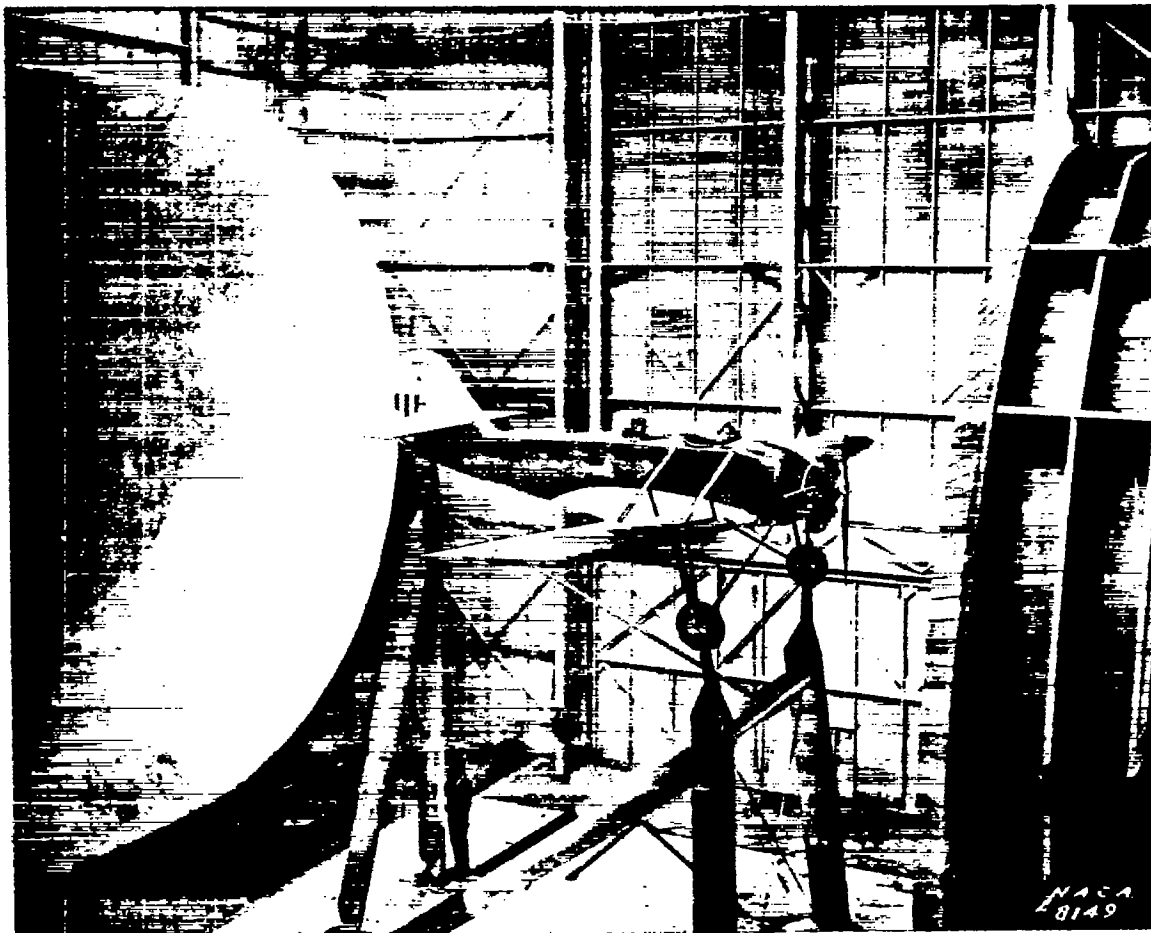

Figure 1. - McDonnell airplane  
with large fillet  
in full- scale wind tunnel

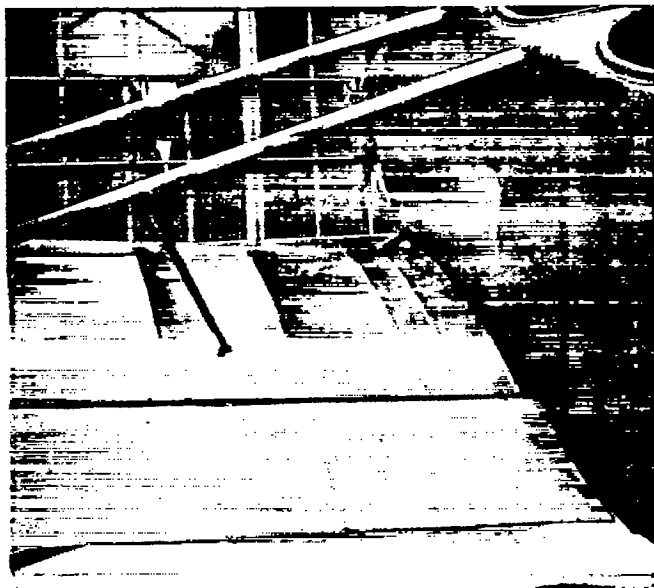

Figure 3. - Wing- fuselage  
intersection  
of McDonnell airplane

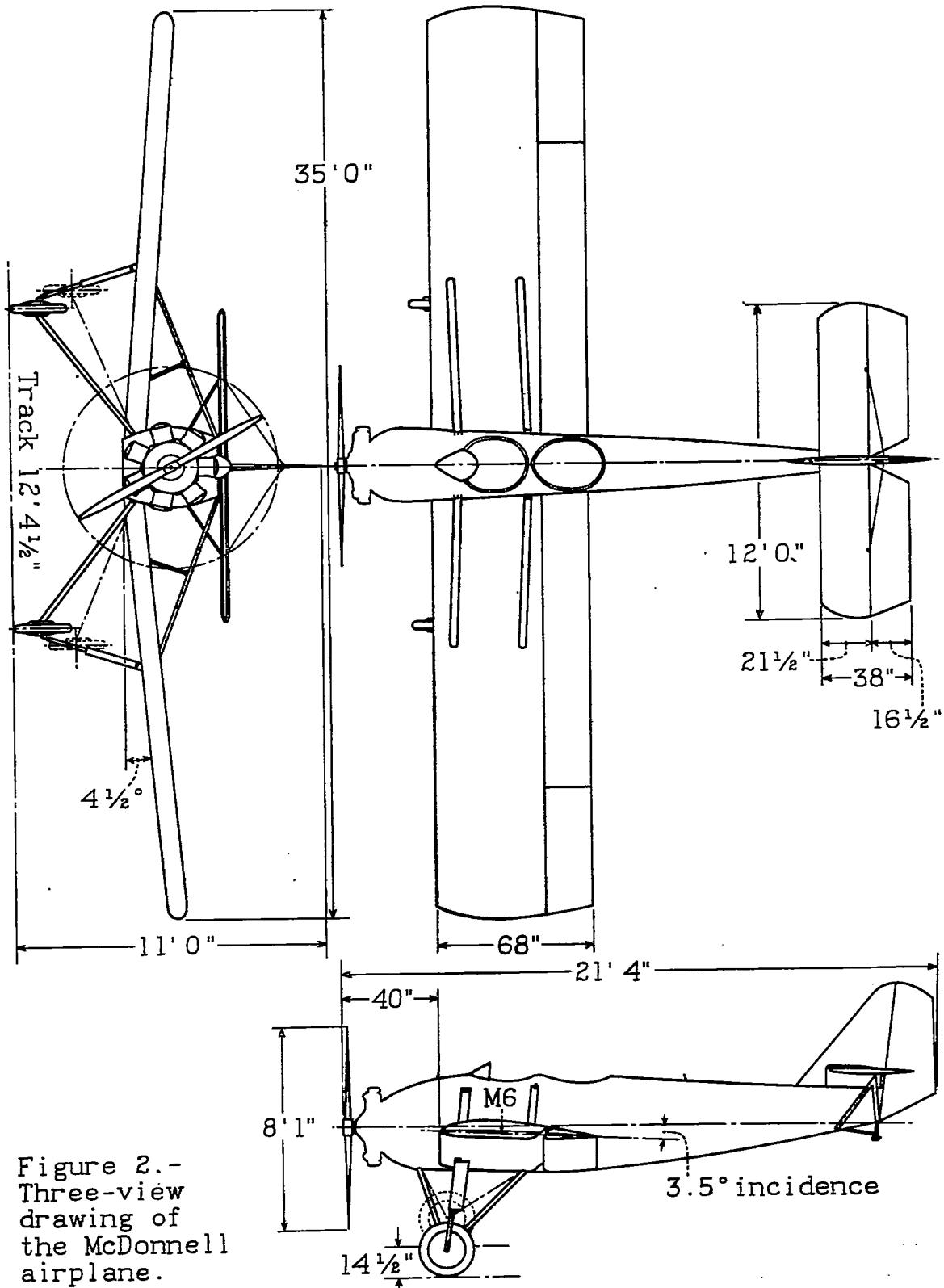

Figure 2.-  
Three-view  
drawing of  
the McDonnell  
airplane.

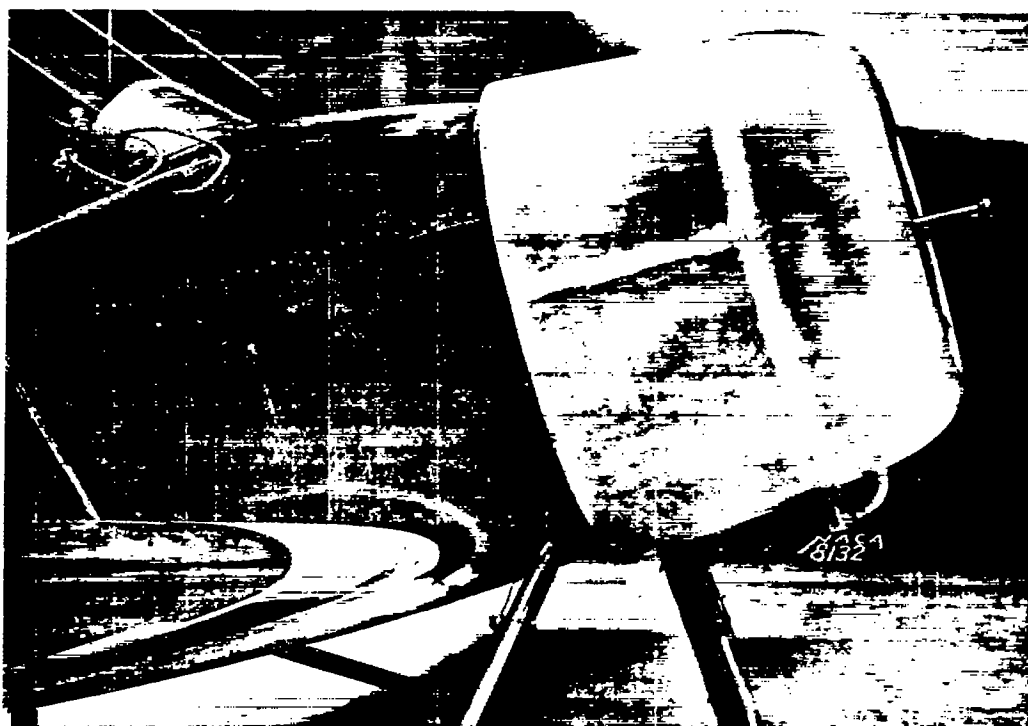
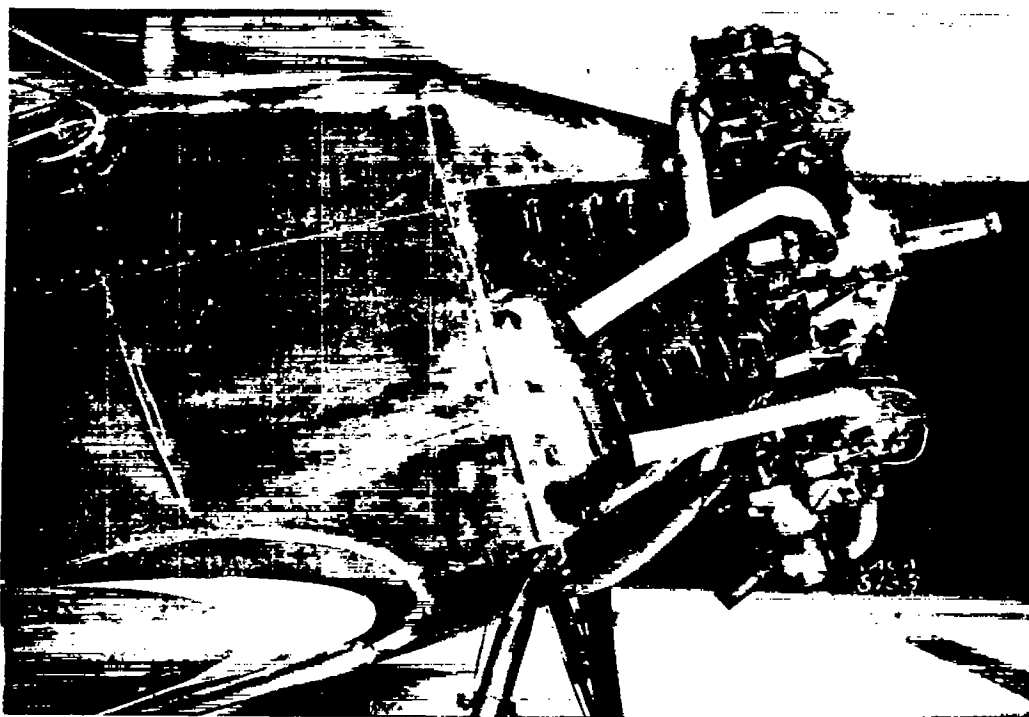

Figure 4.- Nose of McDonnell airplane in original condition  
and with N.A.C.A. engine cowling.

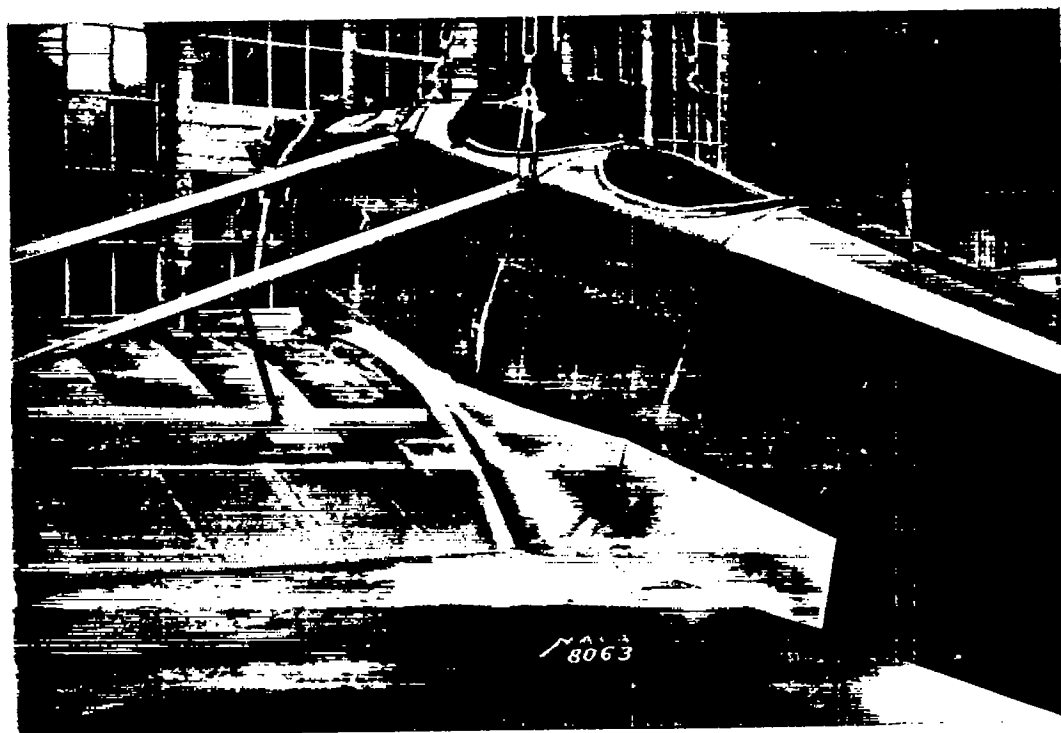
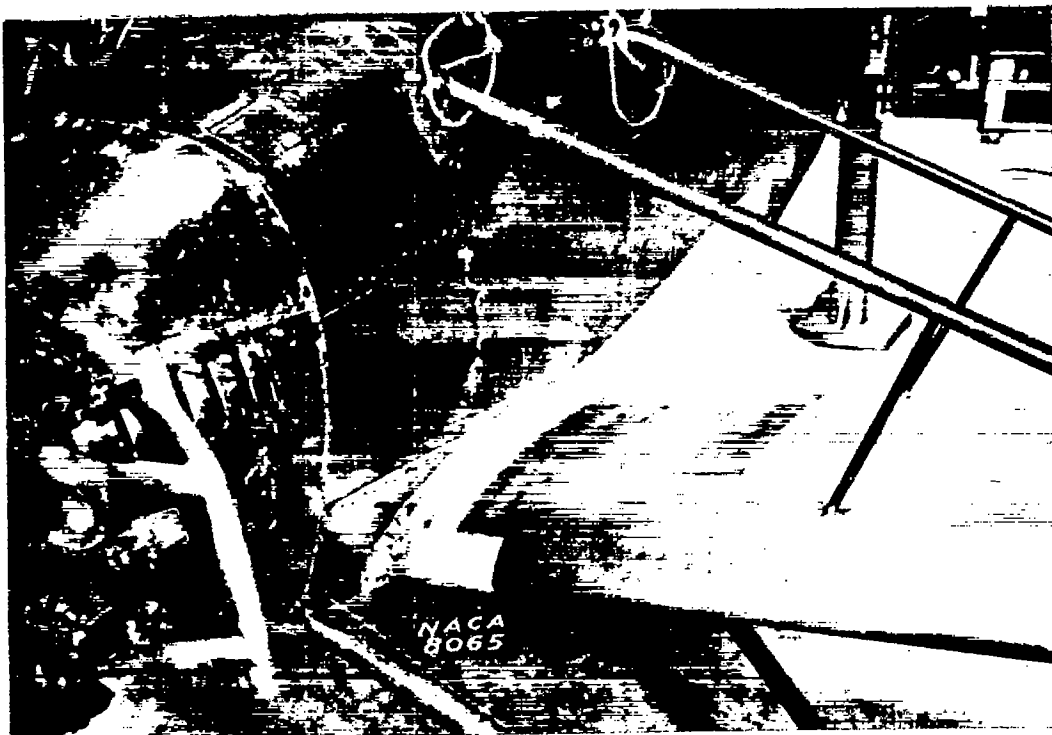

Figure 5.- Small fillet on McDonnell airplane

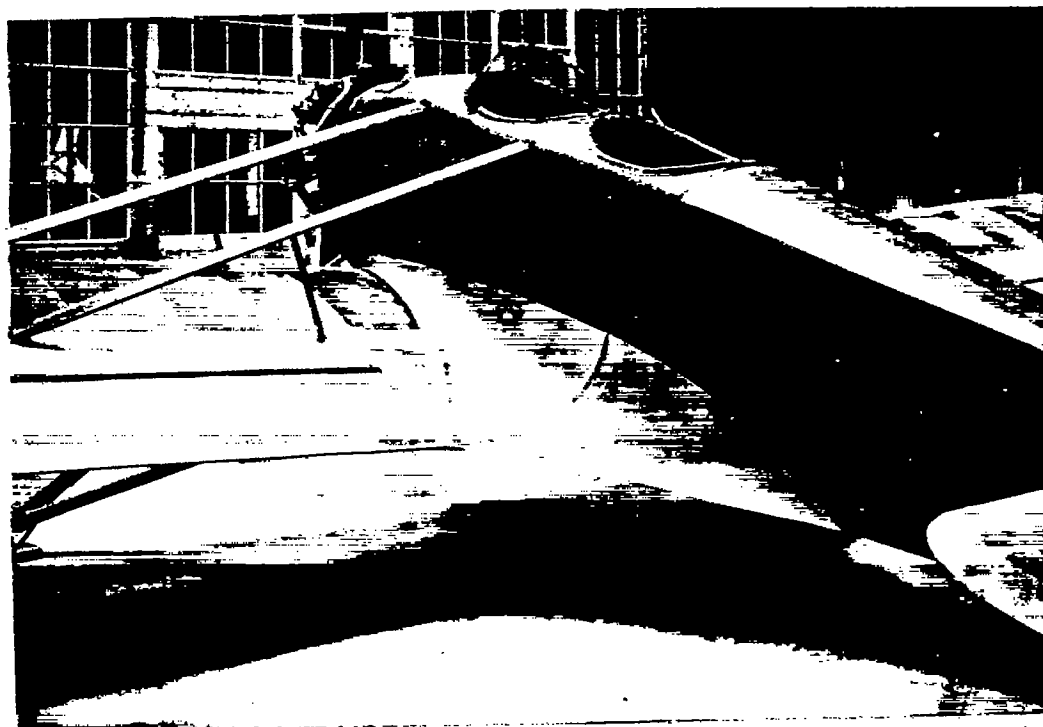
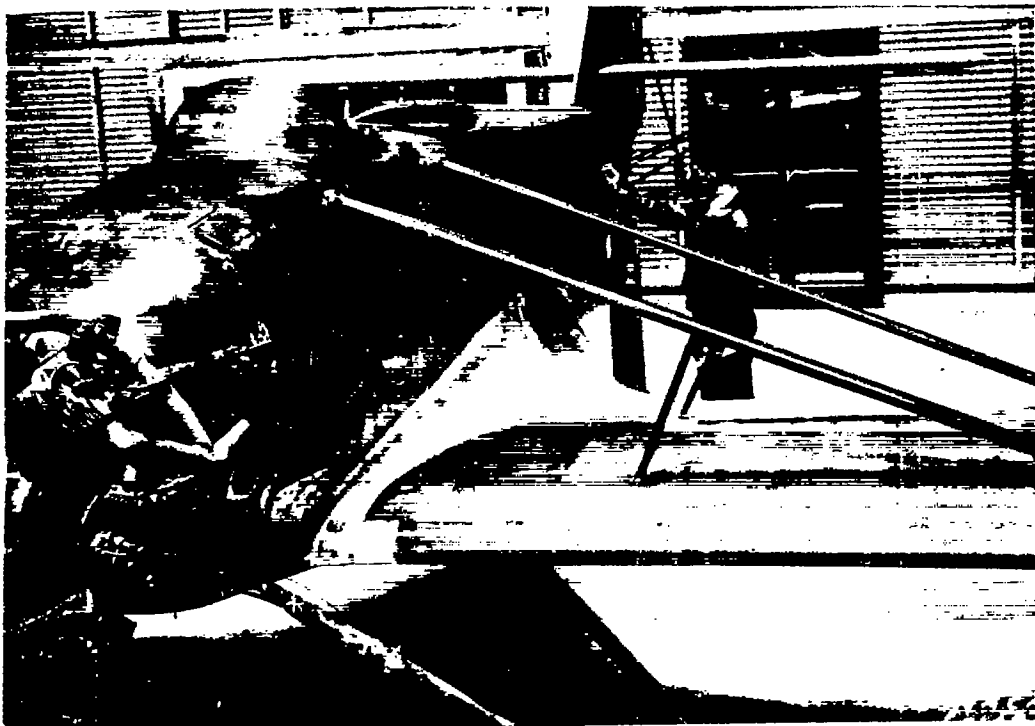
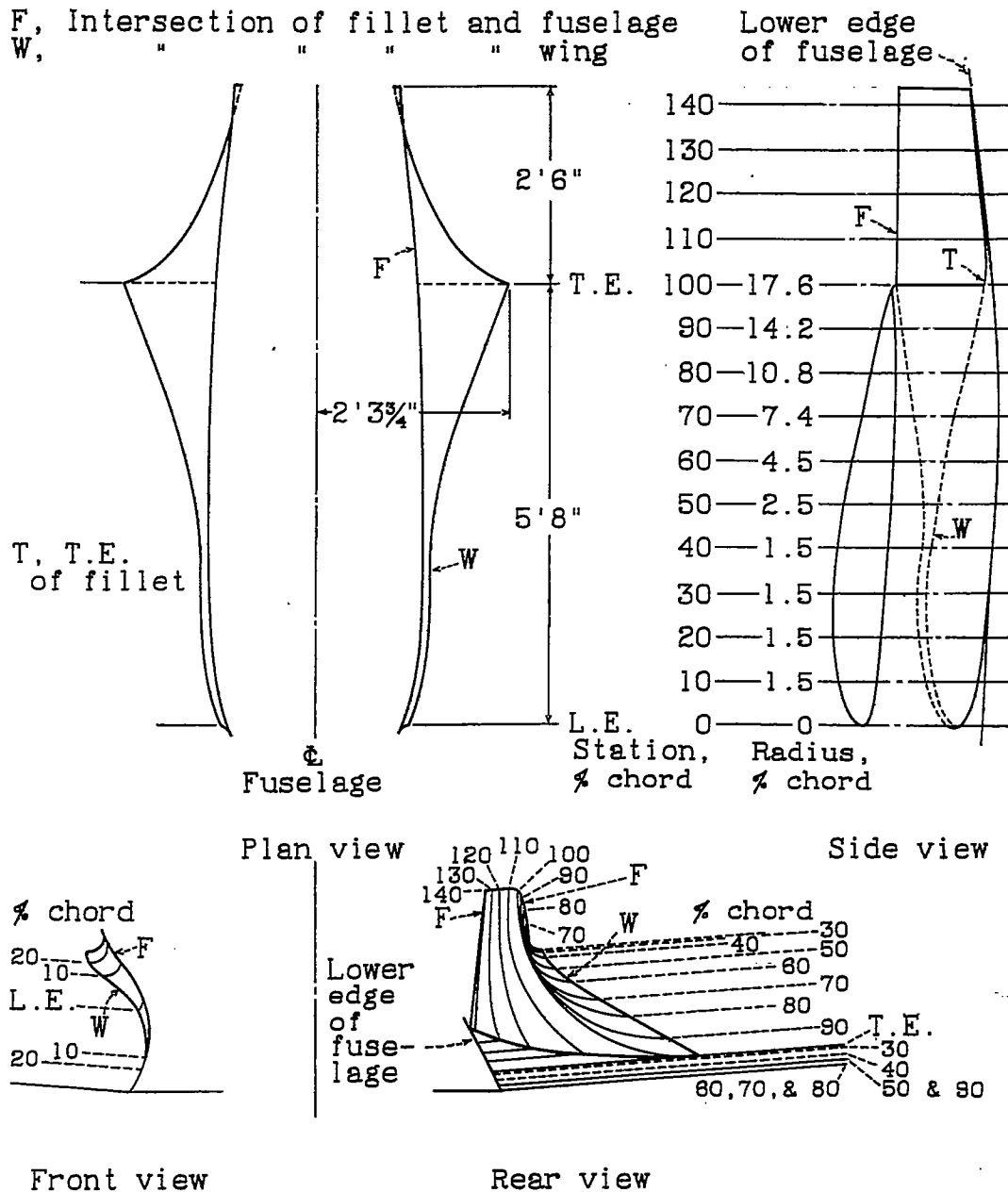

Figure 6.- Large fillet on McDonnell airplane





Note.-Front and rear views are to twice the scale of the plan and side views

Figure 7-Drawing of the small fillet

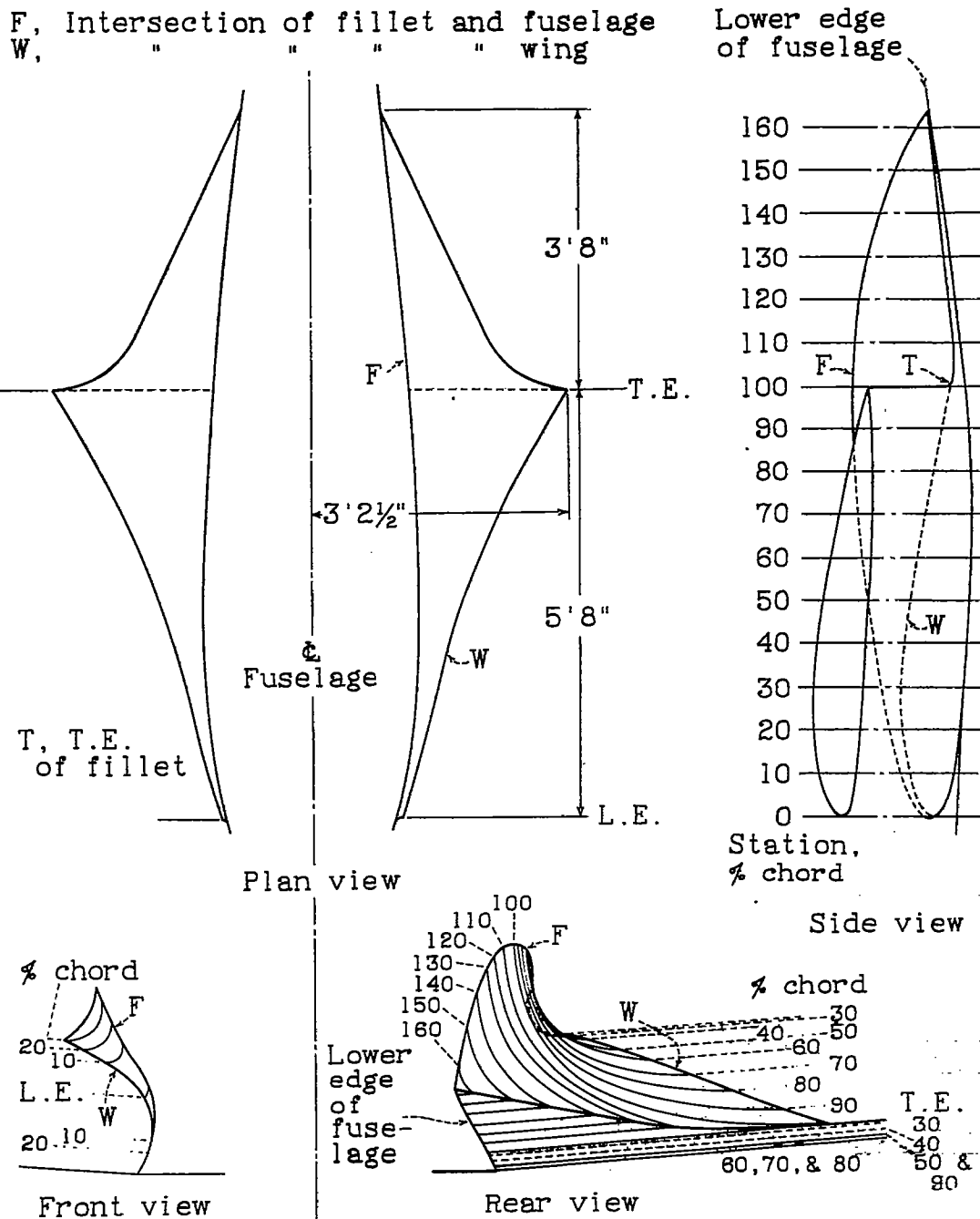

Note.-Front and rear views are to twice the scale of the plan and side views

Figure 8-Drawing of the large fillet

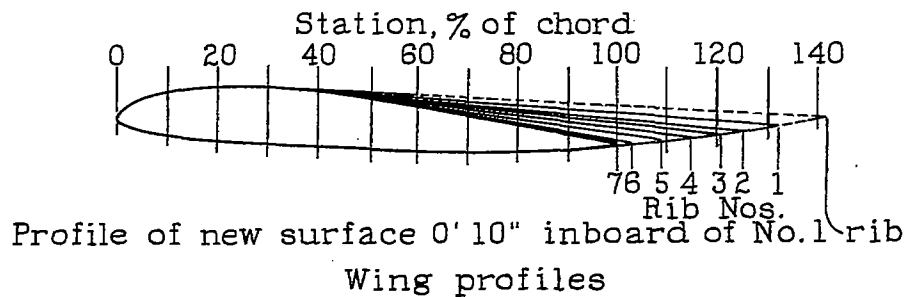
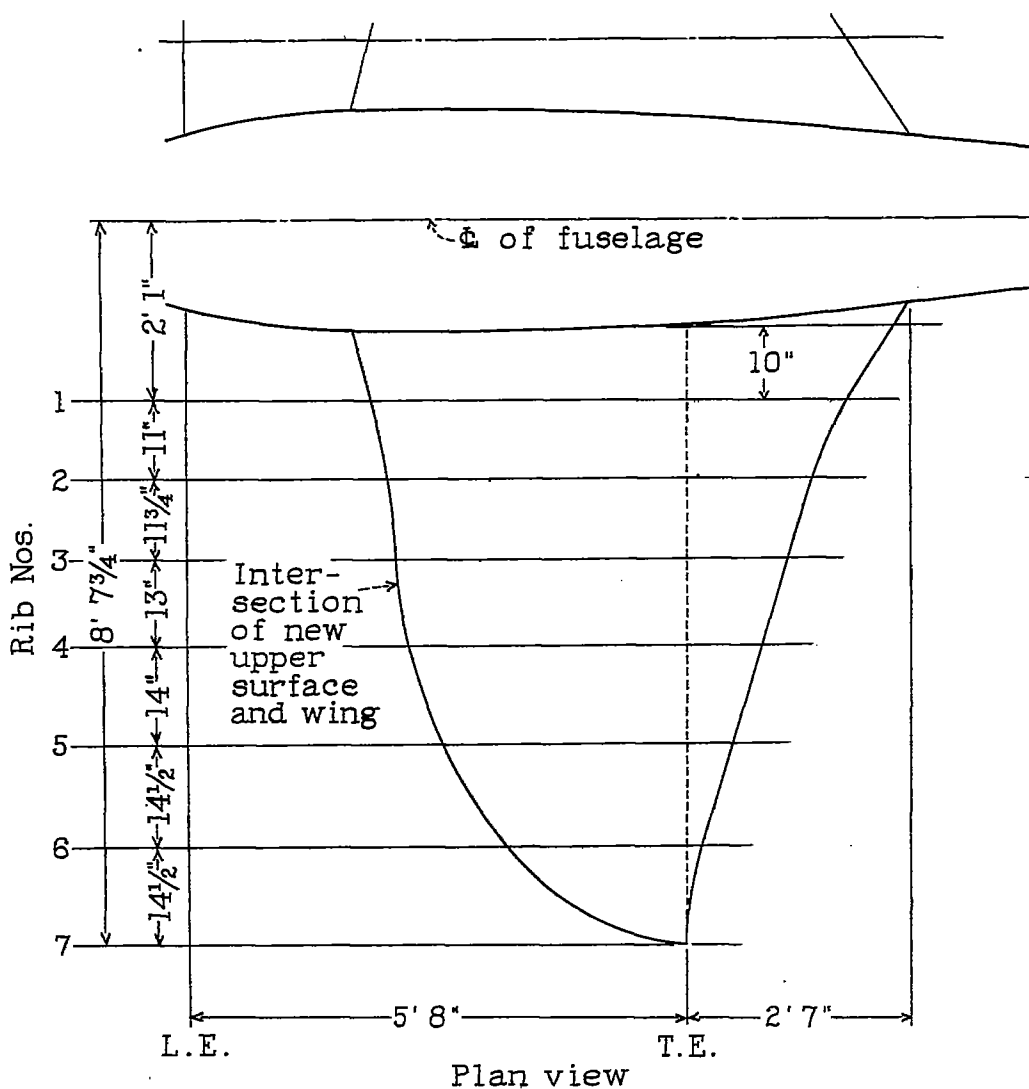

Figure 9-Drawing of the reflexed trailing edge

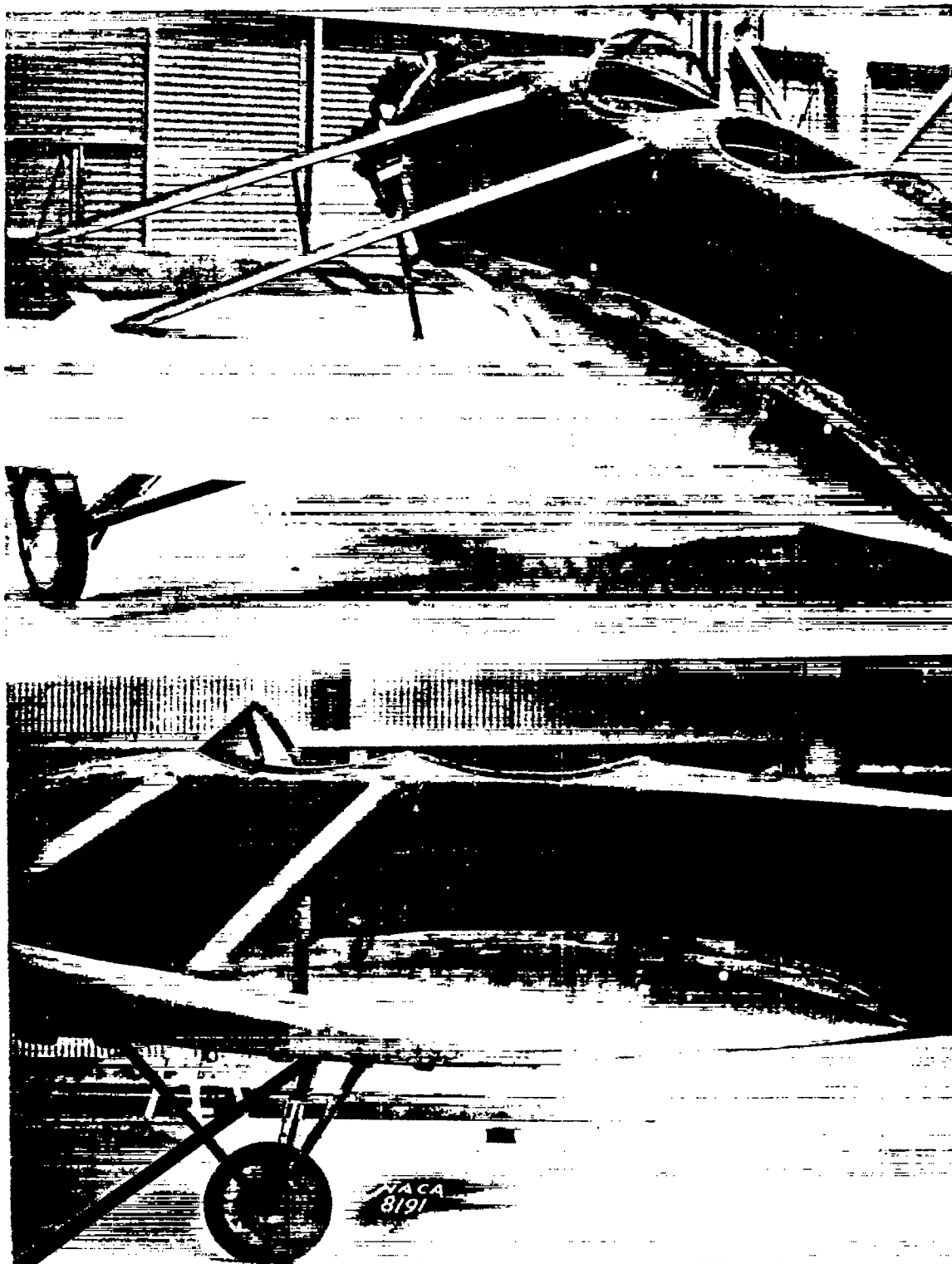

Figure 10.- Reflexed trailing edge with fillet on McDonnell airplane

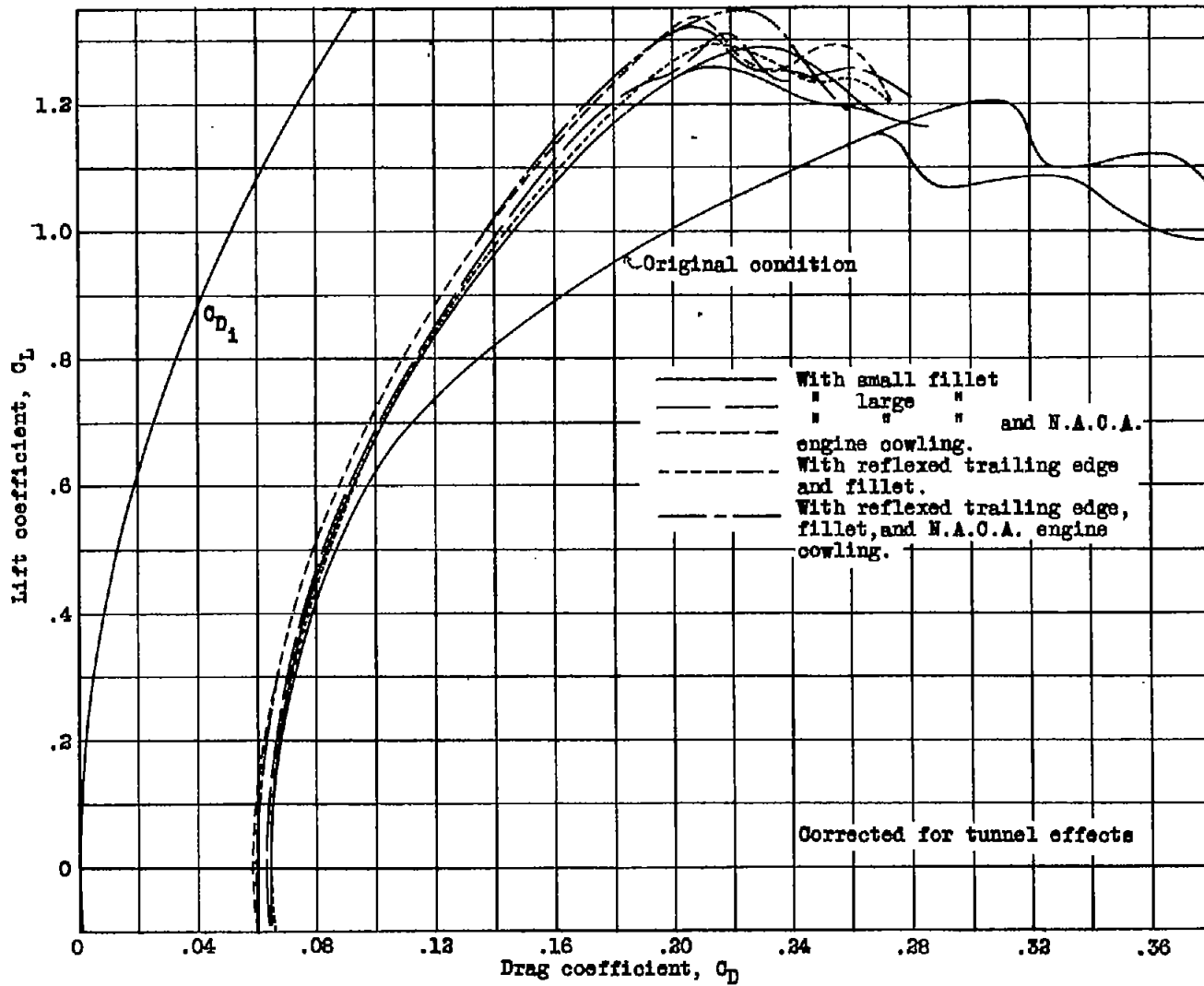

Figure 11.-Polars for McDonnell airplane with various fillets.

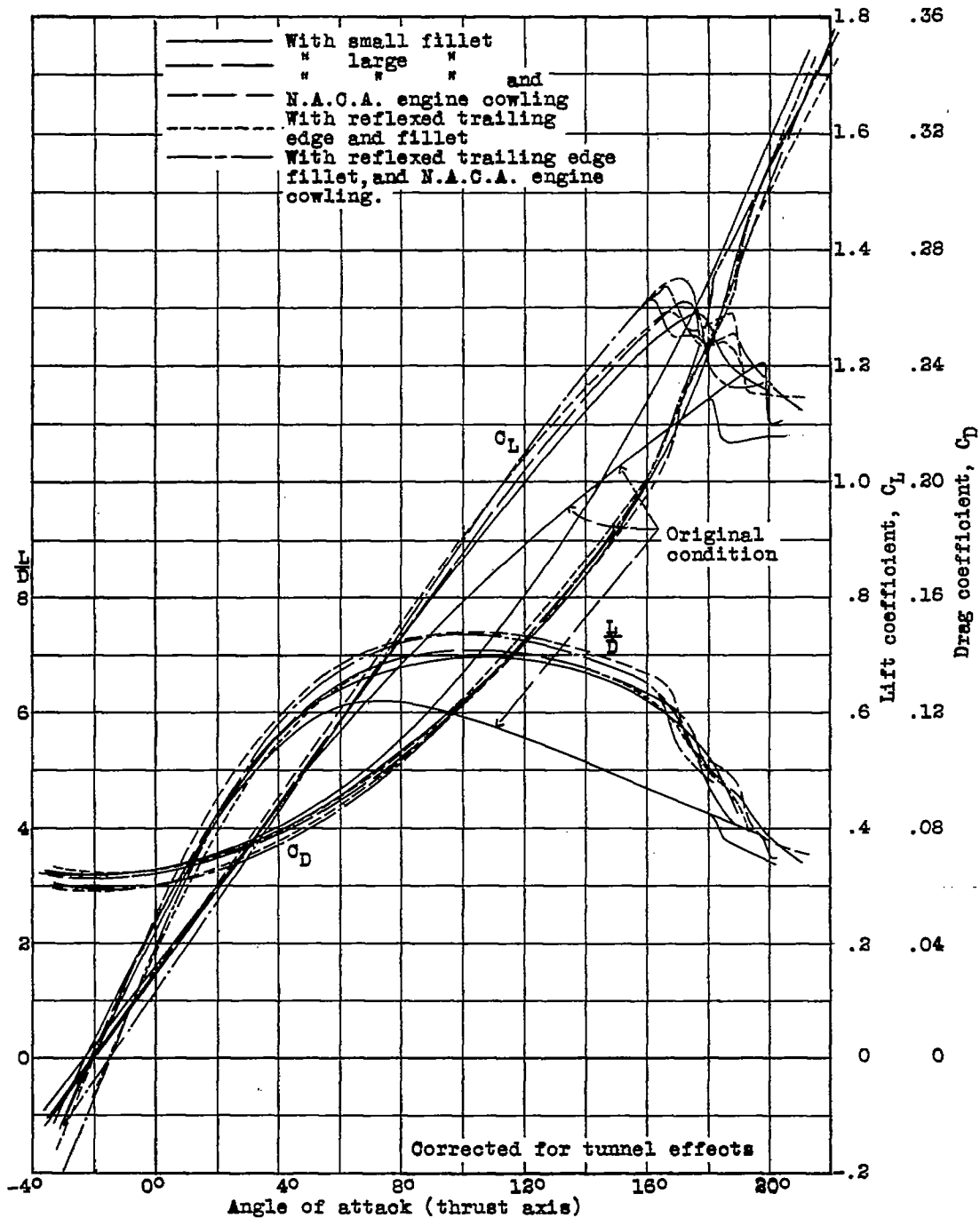

Figure 12.-Lift and drag of McDonnell airplane with various fillets.



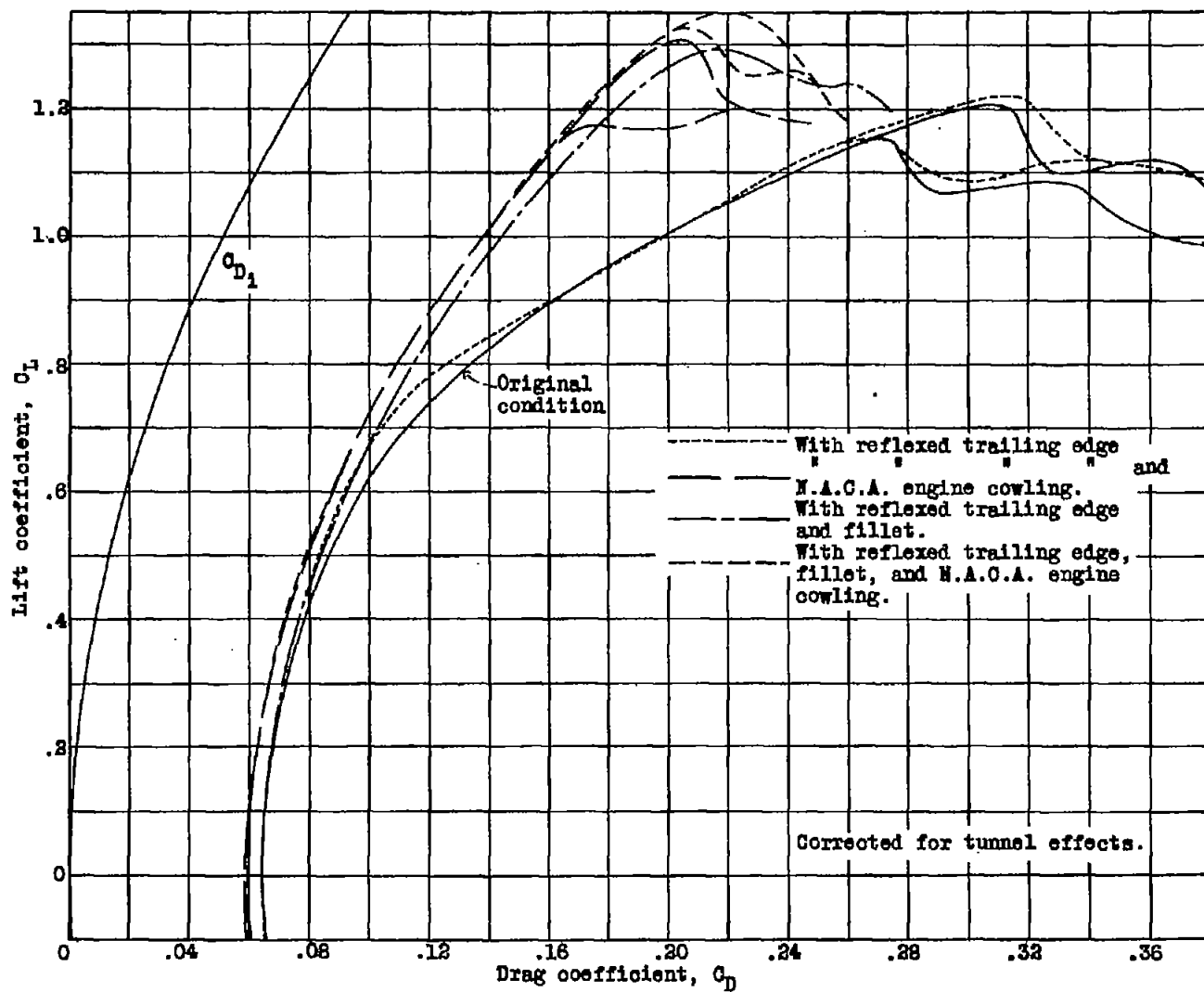

Figure 13.-Polars for McDonnell airplane with reflexed trailing edge.

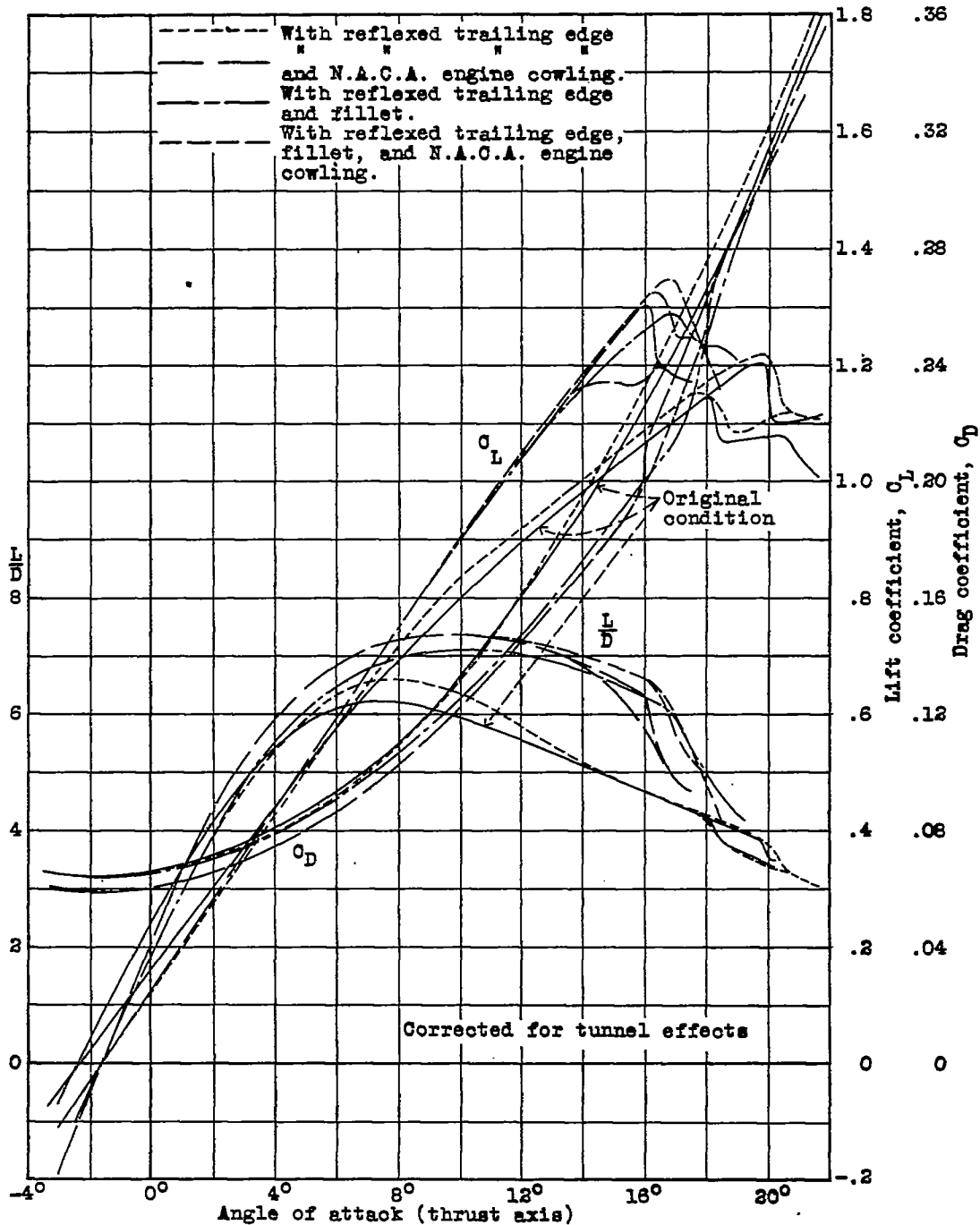

Figure 14.-Lift and drag of McDonnell airplane with reflexed trailing edge.

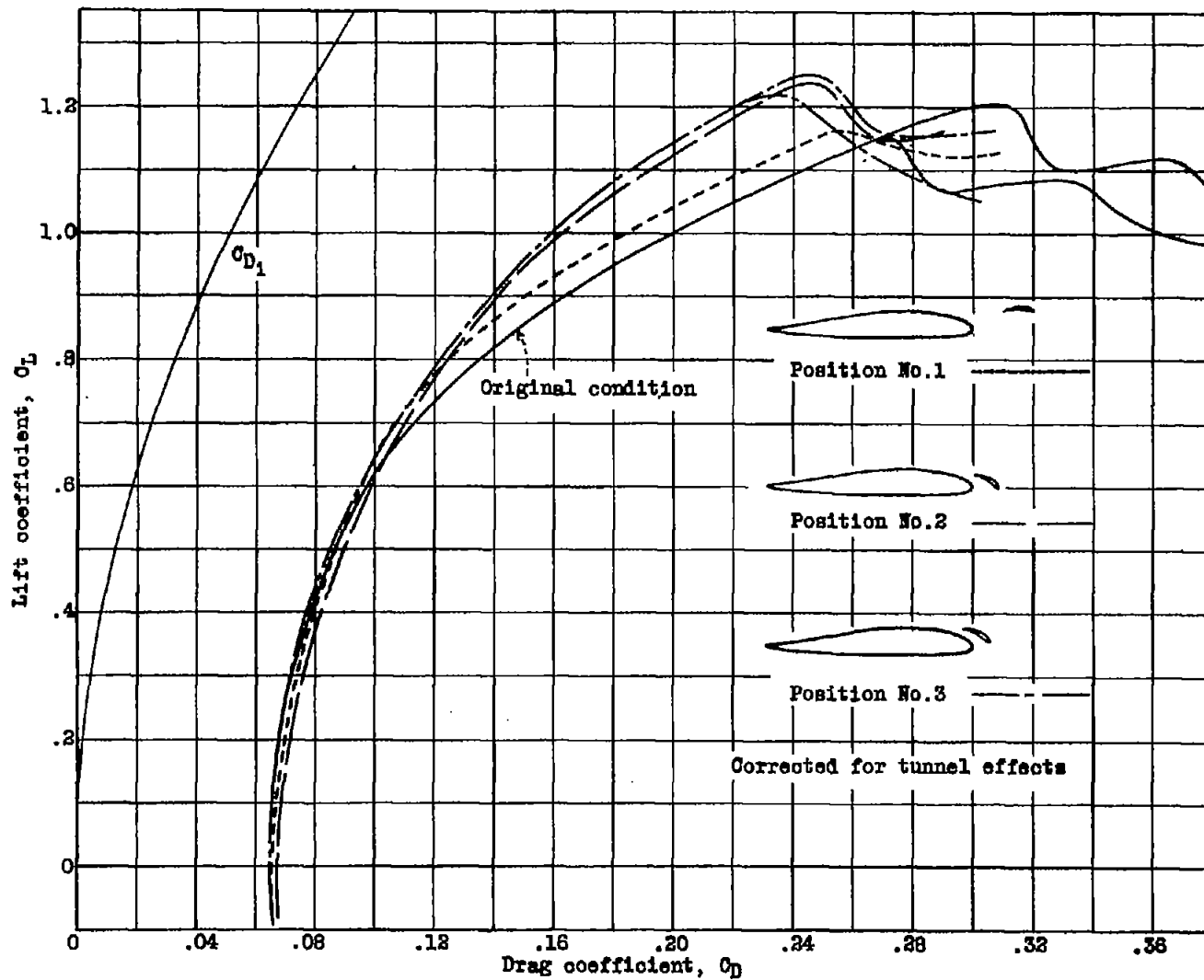

Figure 15.-Polars for McDonnell airplane with auxiliary airfoils.

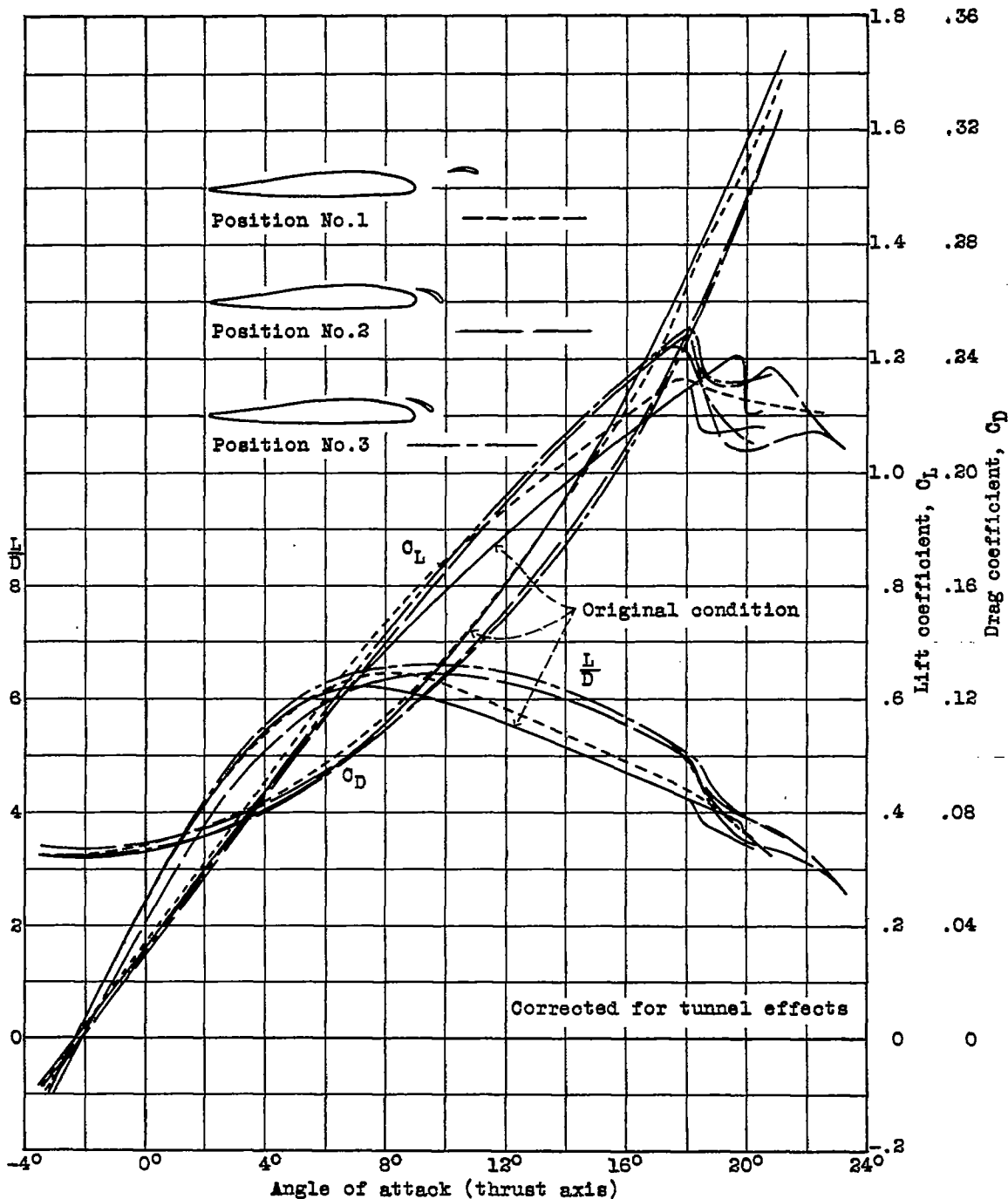

Figure 16.-Lift and drag of McDonnell airplane with auxiliary airfoils.

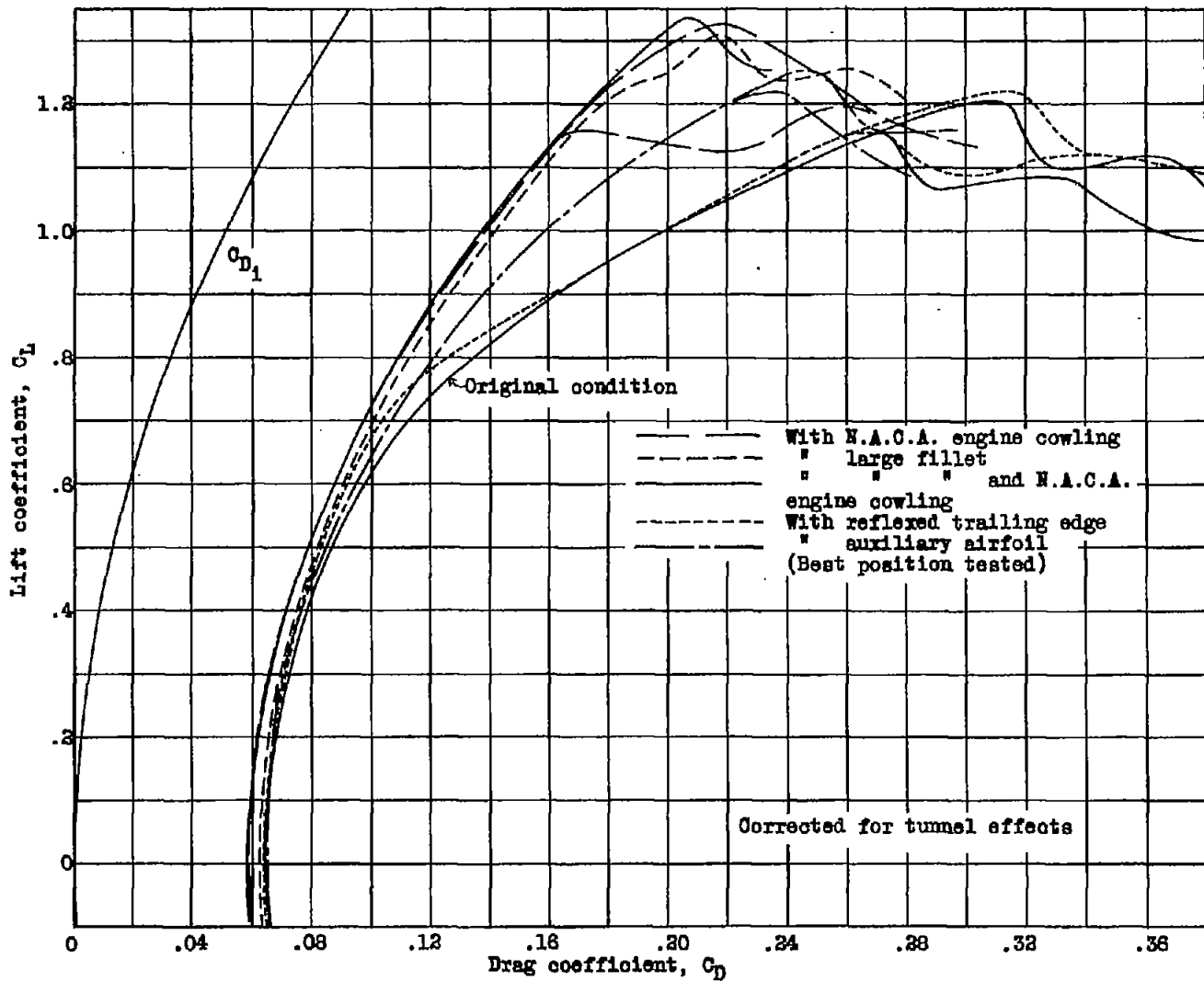

Figure 17.-Polars for McDonnell airplane comparing various devices.

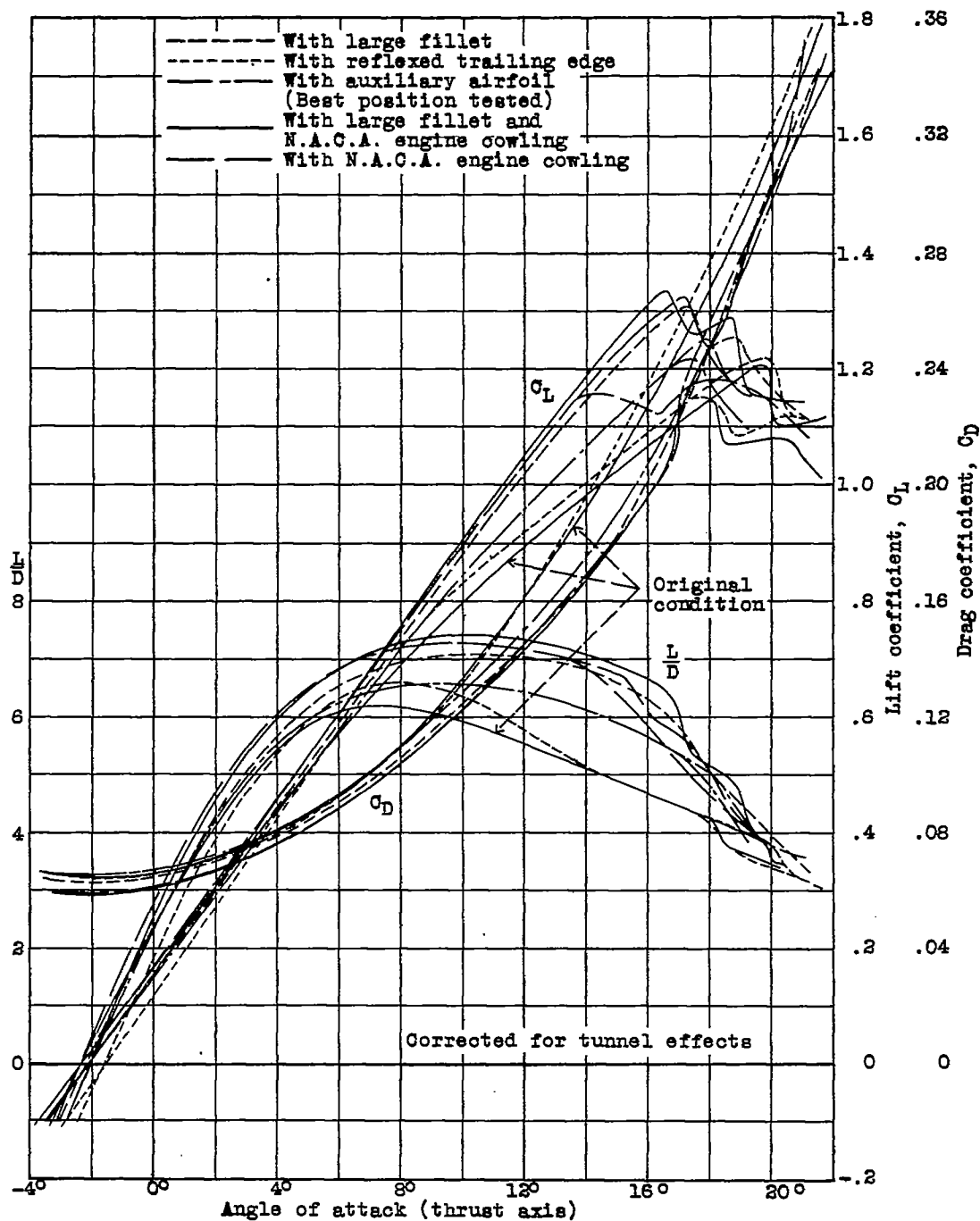

Figure 18.-Lift and drag of McDonnell airplane comparing various devices.



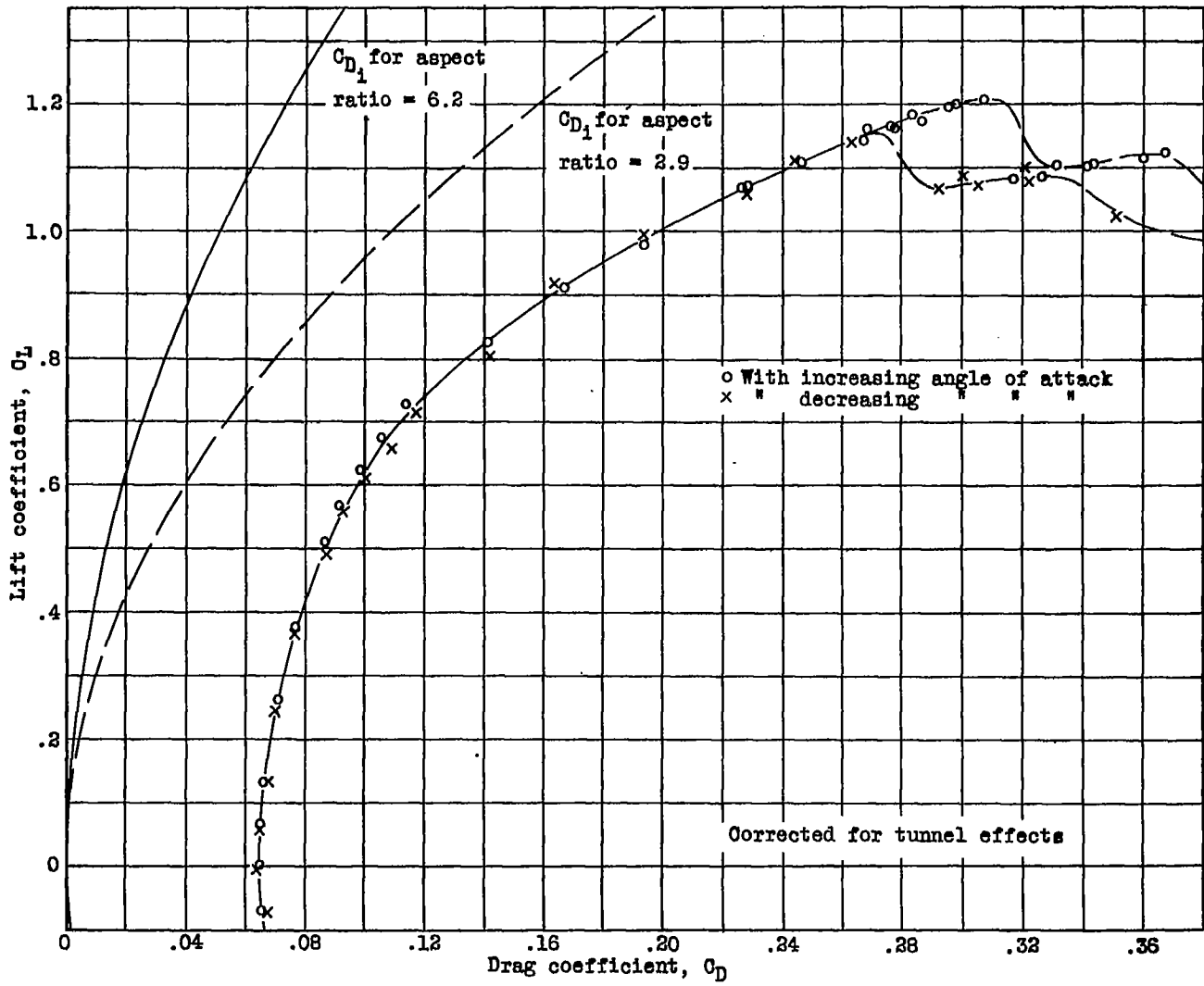

Figure 19.-Polar for McDonnell airplane in original condition.

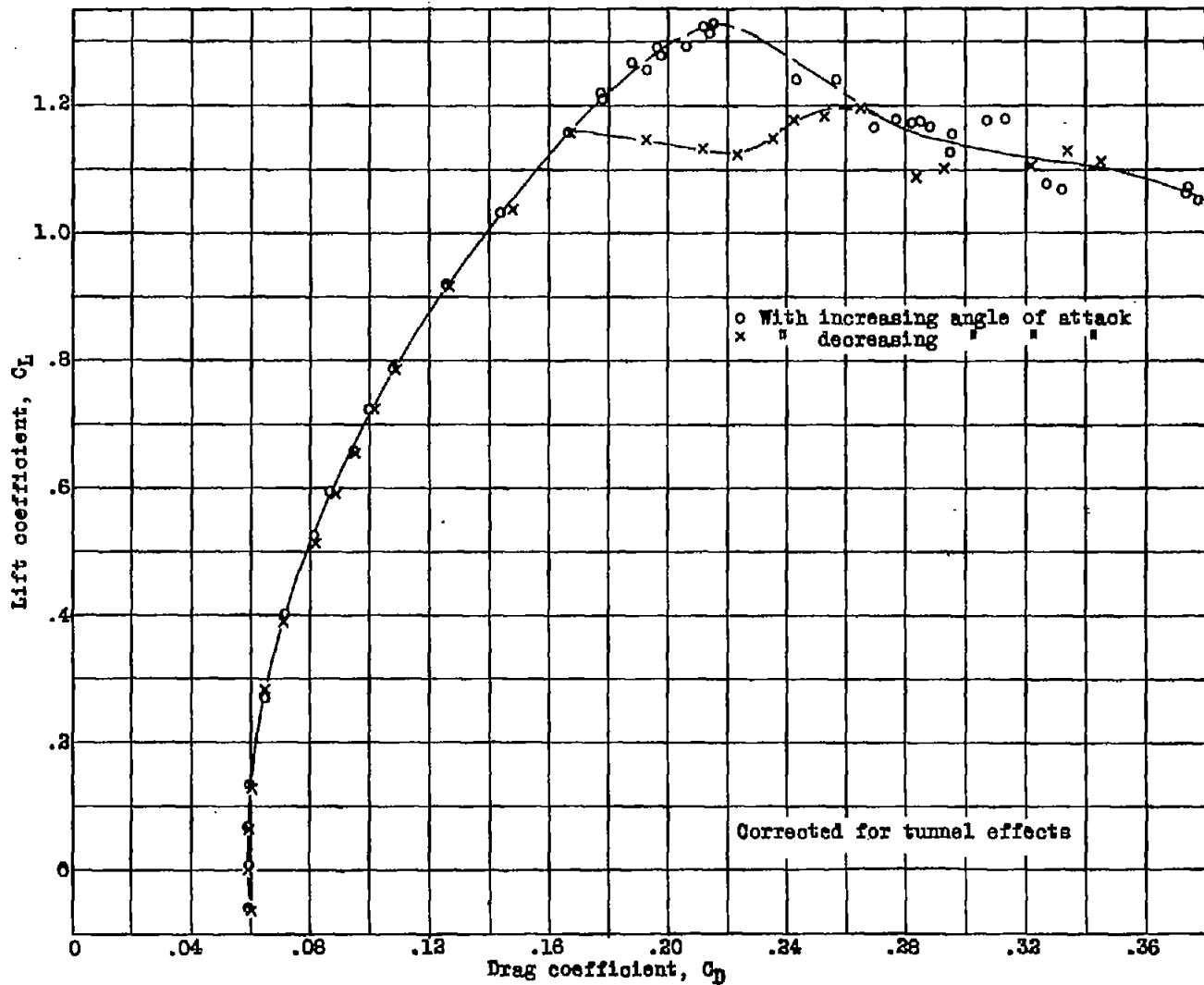

Figure 20.-Polar for McDonnell airplane with N.A.C.A. engine cowling.

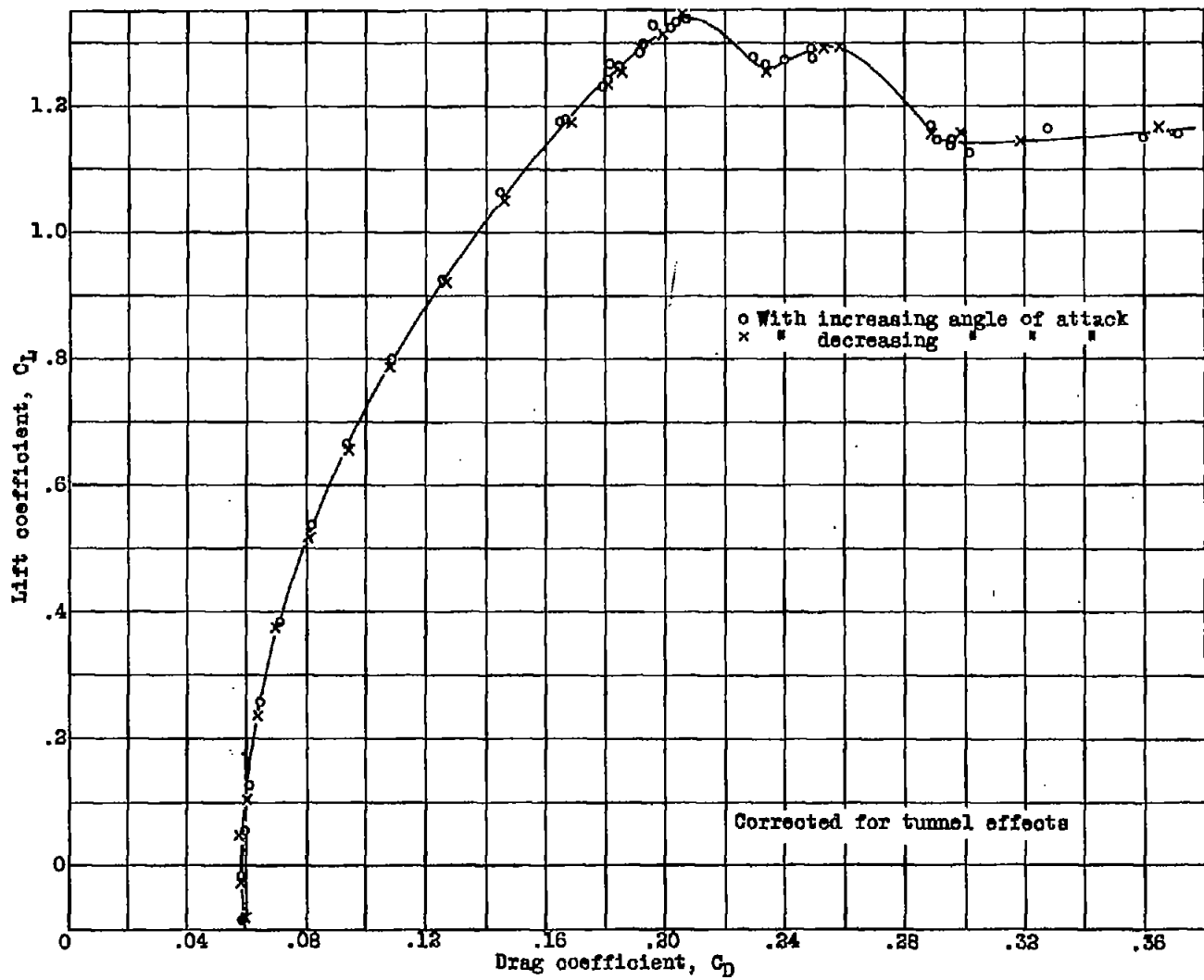

Figure 21.-Polar for McDonnell airplane with large fillet and N.A.C.A. engine cowling.

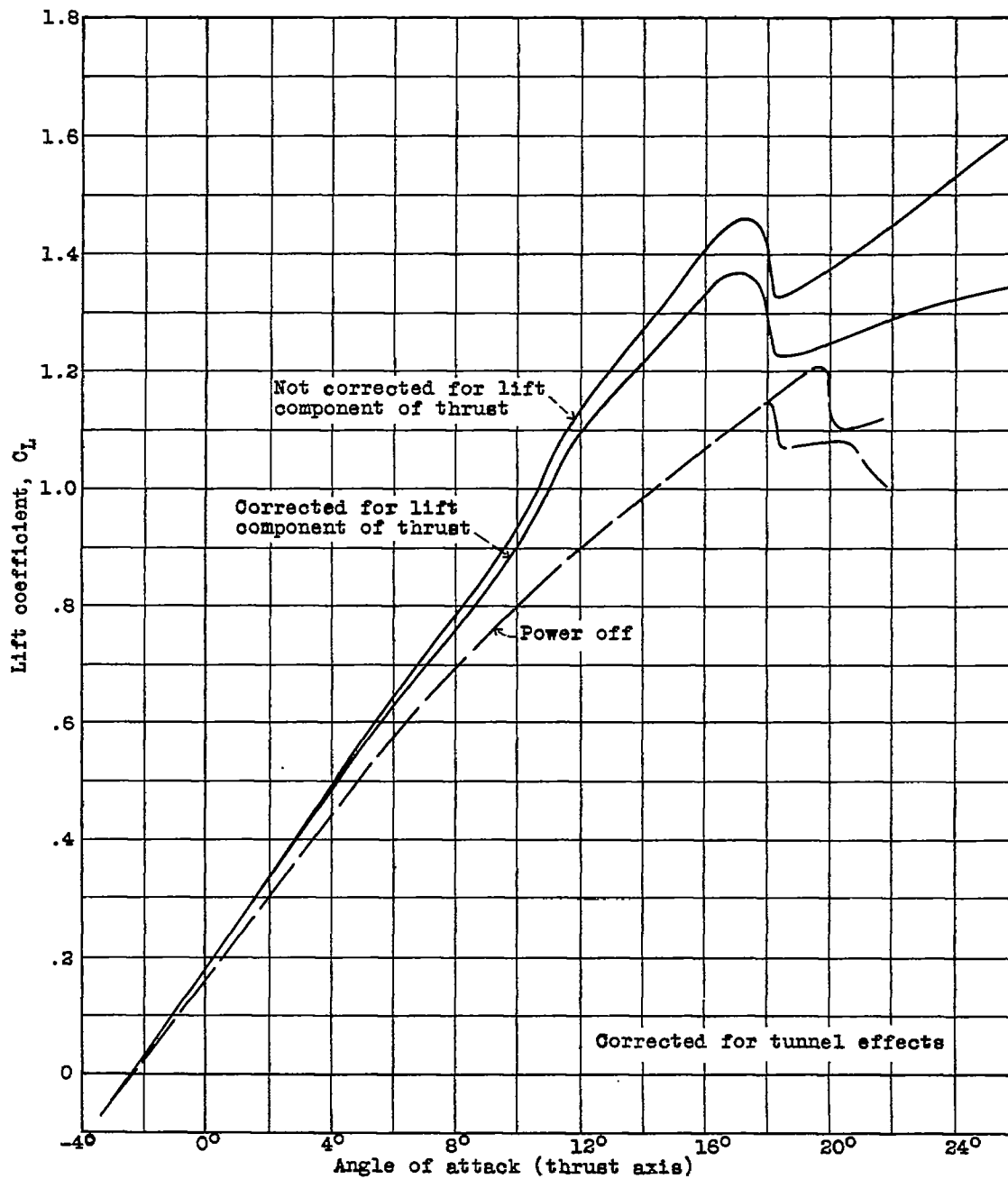

Figure 22.-Power-on lift of McDonnell airplane in original condition.

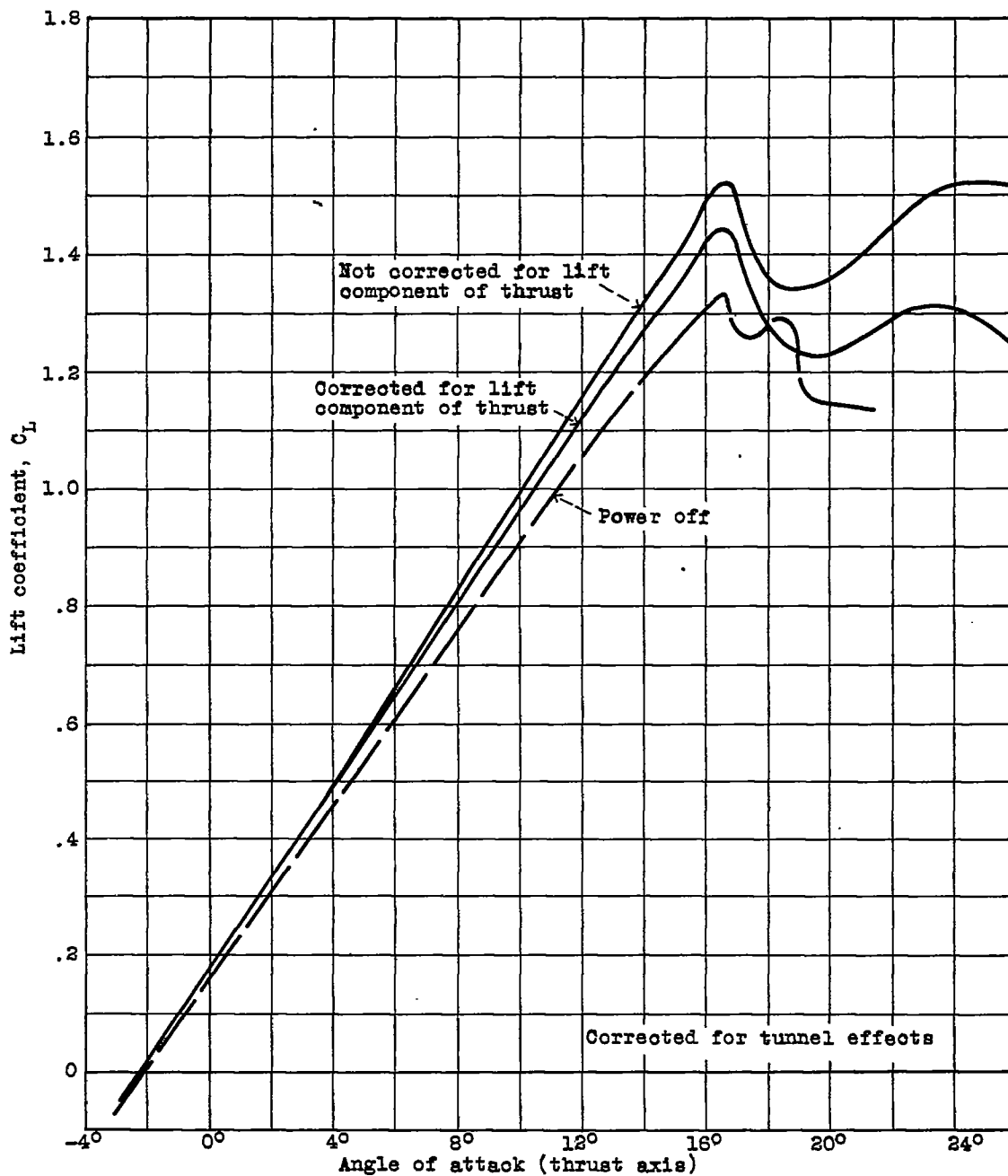
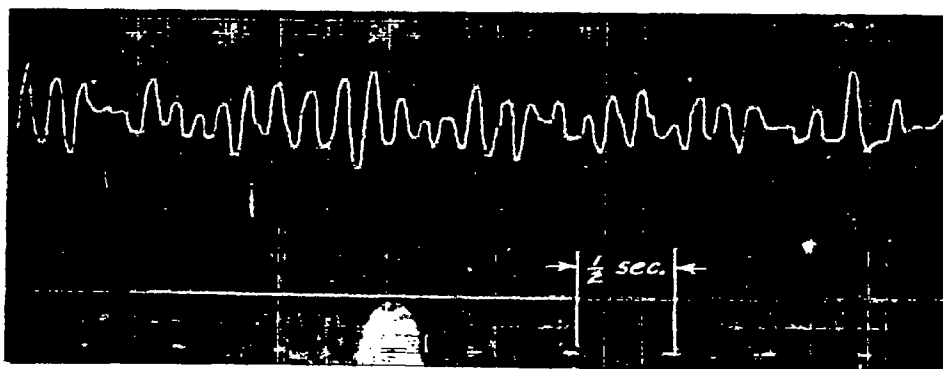
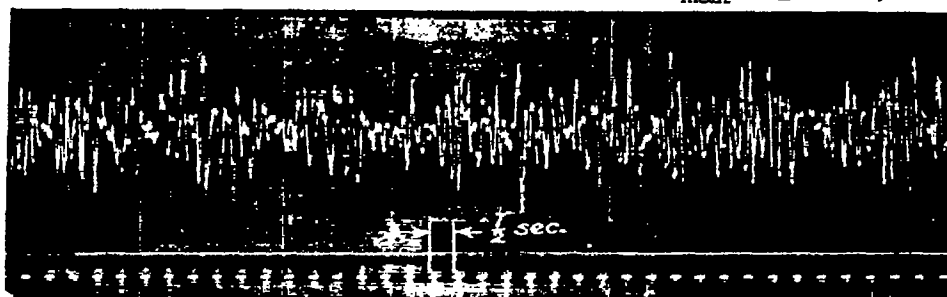

Figure 23.-Power-on lift of McDonnell airplane with large fillet and N.A.C.A. engine cowling.



ORIGINAL CONDITION  
Angle of attack =  $14.1^\circ$ ,  $5.6^\circ$  Below  $C_{Lmax}$ ,  $C_L = 0.990$



ORIGINAL CONDITION  
Angle of attack =  $17.8^\circ$ ,  $1.9^\circ$  Below  $C_{Lmax}$ ,  $C_L = 1.142$

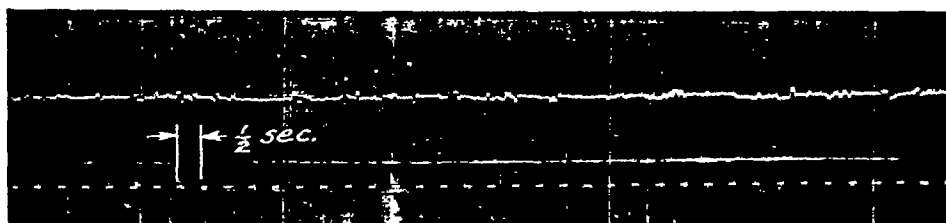

WITH LARGE FILLET  
Angle of attack =  $14.1^\circ$ ,  $3.3^\circ$  Below  $C_{Lmax}$ ,  $C_L = 1.145$

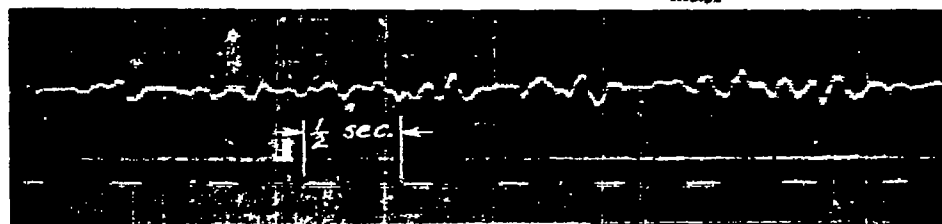

WITH LARGE FILLET  
Angle of attack =  $17.8^\circ$ ,  $0.6^\circ$  Above  $C_{Lmax}$ ,  $C_L = 1.250$

Deflection for 1-inch vertical  
movement of stabilizer

Figure 24.-  
Typical records of  
stabilizer-tip movements

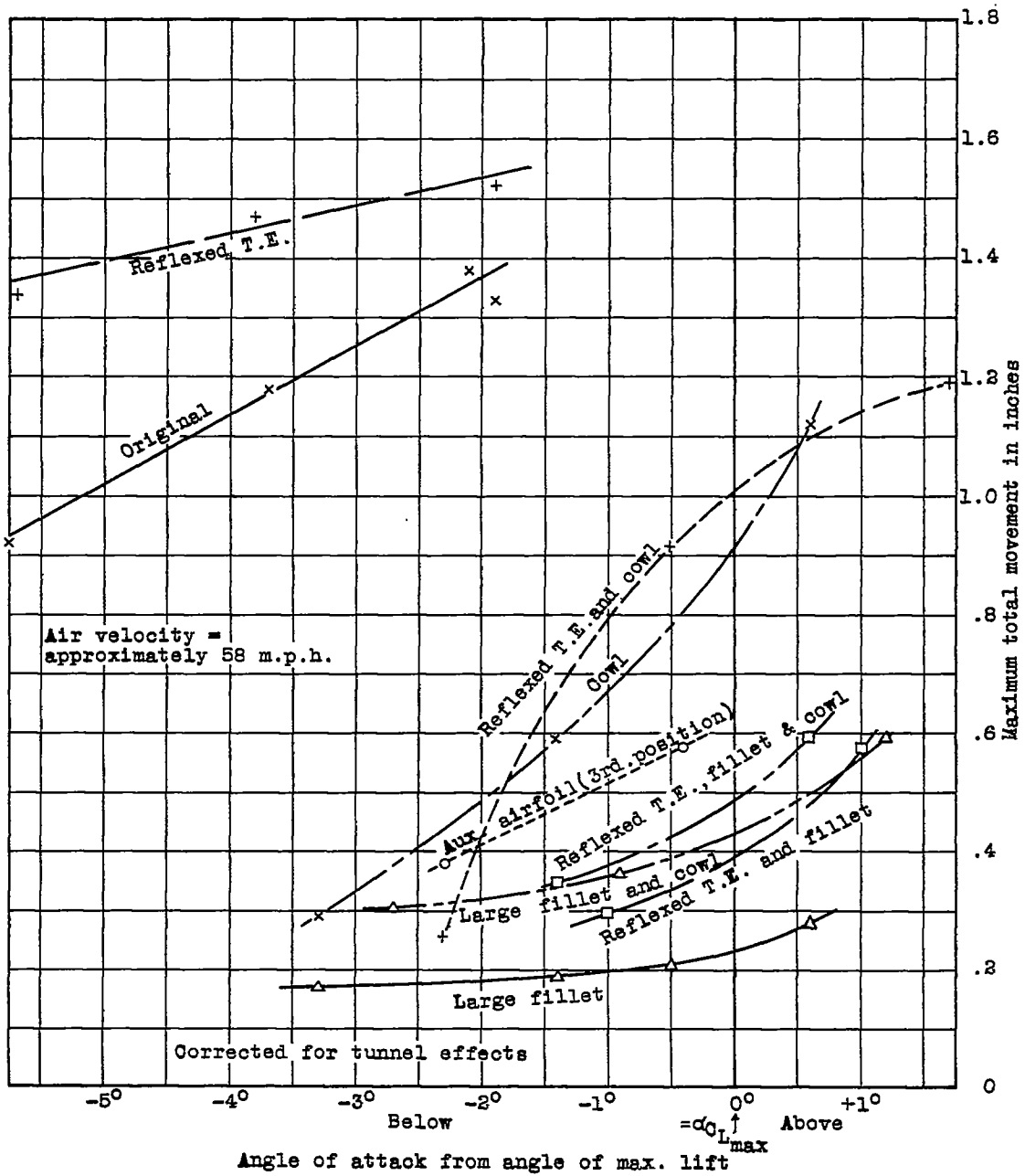

Figure 25.-Amplitude of stabilizer-tip movements under various conditions.

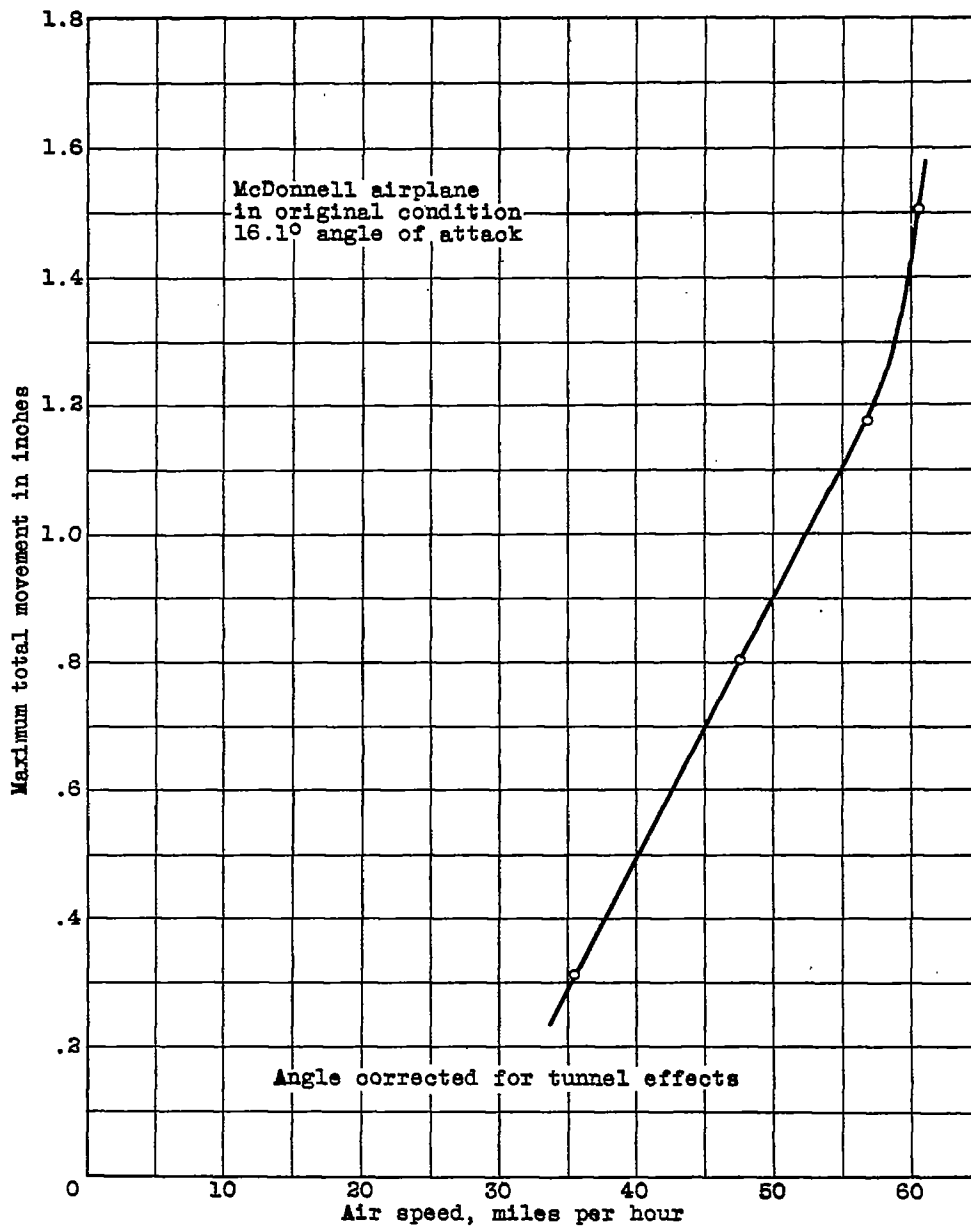

Figure 26.-Variation in stabilizer-tip movements with changes in air speed.