

185
950
Library R.M.A.L.

[Handwritten signature]

TECHNICAL NOTES

NATIONAL ADVISORY COMMITTEE FOR AERONAUTICS

No. 578

FULL-SCALE WIND-TUNNEL AND FLIGHT TESTS
OF A FAIRCHILD 22 AIRPLANE EQUIPPED WITH A FOWLER FLAP

By C. H. Dearborn and H. A. Soule
Langley Memorial Aeronautical Laboratory

WASHINGTON

Washington
August 1936



NATIONAL ADVISORY COMMITTEE FOR AERONAUTICS

TECHNICAL NOTE NO. 578

FULL-SCALE WIND-TUNNEL AND FLIGHT TESTS
OF A FAIRCHILD 22 AIRPLANE EQUIPPED WITH A FOWLER FLAP

By C. H. Dearborn and H. A. Soule

SUMMARY

Full-scale wind-tunnel and flight tests were made of a Fairchild 22 airplane equipped with a Fowler flap to determine the effect of the flap on the performance and control characteristics of the airplane. In the wind-tunnel tests of the airplane with the horizontal tail surfaces removed, the flap was found to increase the maximum lift coefficient from 1.27 to 2.41. In the flight tests, the flap was found to decrease the minimum speed from 58.8 to 44.4 miles per hour. The required take-off run to attain an altitude of 50 feet was reduced from 935 feet to 700 feet by the use of the flap, the minimum distance being obtained with five-sixths full deflection. The landing run from a height of 50 feet was reduced one-third. The longitudinal and directional control was adversely affected by the flap, indicating that the design of the tail surfaces is more critical with a flapped than a plain wing.

INTRODUCTION

At the request of the Bureau of Aeronautics, Navy Department, the Committee is conducting a series of tests of different types of flapped wings on a Fairchild 22 airplane. The tests consist of the measurement of the primary aerodynamic characteristics of the airplane with each type of flap in the full-scale wind tunnel and of the measurement of control and other characteristics, not readily determined in the tunnel, in flight. The tests of the Fowler wing, the first of the series, have been completed and are herein reported.

The Fowler wing has a variable area and camber, and consists of two separate airfoils of different chords. The larger airfoil is the basic wing and the smaller one

is the Fowler flap, which in its retracted position fits into a recess in the lower surface of the basic wing at its trailing edge. The flap is operated by moving it downward and to the rear along a circular arc, thereby increasing both the chord and camber of the wing combination. In the extended position the flap is situated with its leading edge approximately under the trailing edge of the basic wing and with its chord line 29° relative to the chord line of the basic wing. The flap is a slight distance below the trailing edge of the basic wing so that a slot is formed between the main wing and the nose of the flap.

The area of the Fowler wing used in the tests was 23 percent smaller than that of the standard wing for the airplane; a comparison has therefore been made of the test data with corresponding data for a wing of standard area, in addition to the comparison made between the characteristics of the Fowler wing itself with the flap retracted and extended. An analysis has also been made and included of the gliding and power-on performance of the airplane based on the full-scale-tunnel data.

AIRPLANE

The Fairchild 22 airplane is a small, externally braced, parasol monoplane. (See fig. 1.) It is normally equipped with a rectangular wing with rounded tips having a span of 32 feet 10 inches, a chord of 5 feet 6 inches, and an N-22 airfoil section. The area of this wing is 171 square feet and its weight approximately 200 pounds. Lateral control is provided by conventional ailerons of 12-inch (18.2 percent c) chord, extending across practically the entire trailing edge of the wing (83 percent b).

The Fowler wing has a span of 31 feet, a basic chord of 4 feet 4 inches, and an area of 132 square feet, 77 percent that of the standard wing. The section of the basic wing is the N.A.C.A. 2415 and of the flap, the N.A.C.A. 2412. The flap (fig. 2) has a chord of 15-1/2 inches (30 percent c) and a span of 22 feet 1/2 inch (71 percent b). It is operated by means of a crank mounted on the left side of the fuselage, six turns of the crank being required to deflect the flap to its full extent, 32.2° from the retracted position or 29° relative to the

wing chord. The relation of the factors defining the flap position to the turns of the crank is given in figure 3. The trailing edge of the wing outboard of the flap is fitted with balanced ailerons having chords of 15 inches (29 percent c) (fig. 4). The ailerons are rigged up 5° when in neutral and are operated differentially as shown in figure 5.

Despite its smaller basic area, the Fowler wing and flap operating mechanism weigh approximately 300 pounds, or 50 percent more than the standard wing. It was installed on the airplane with an angle of wing setting of 5° so that with the flap retracted the fuselage would be at the same attitude at zero wing lift as when equipped with the standard wing. The installation is shown in the three-view drawing (fig. 1) and the photographs (figs. 6 and 7). Dimensions and data of the airplane pertinent to the tests are given in figure 1 and table I.

WIND-TUNNEL TESTS

Test Conditions

All wind-tunnel tests were made with the horizontal tail surfaces and the propeller removed from the airplane (fig. 8). Tests were first conducted to determine the aerodynamic characteristics of the airplane for five flap positions, including the fully retracted and extended positions. These tests were made at a tunnel air speed of approximately 58 miles per hour and covered an angle-of-attack range from -14° to 20° . Tests were then made to determine the scale effect on the maximum lift coefficient for the fully retracted and fully extended positions of the flap over a speed range from 30 to 70 miles per hour. The scale effect on the minimum drag coefficient for the flap-retracted condition was investigated over a speed range from 30 to 120 miles per hour. Rolling moments were measured at several angles of attack to determine the relative effectiveness of the ailerons with the flap in its two extreme positions.

Results and Discussion

The results herein presented have been corrected for tunnel effects, and all coefficients are based on the basic-wing dimensions. The center-of-gravity position

used in the computation of moment coefficients is the same as that used in previous investigations of high-lift devices on the Fairchild 22 airplane; namely, $5/8$ inch below the thrust axis and $14-1/2$ inches aft the leading edge of the wing.

The aerodynamic characteristics of the airplane for five flap positions are presented in figures 9(a) to (e). These figures show that, as the flap displacement is increased, the angles of zero lift occur at increasingly larger negative angles, the slope of the lift curve increases (probably owing to the fact that the increase in wing area was not considered in the computation of the coefficients), the angles of maximum lift remain nearly constant, and the pitching-moment coefficients show large increases. The maximum value of the lift-drag ratio (fig. 10) decreases gradually with increasing flap displacements and the rate of increase in the maximum lift coefficient is greatest for the large flap displacements. For the full displacement of the flap a maximum lift coefficient of 2.41 was obtained, which is an increase of 90 percent over the maximum lift coefficient of 1.27 obtained with the flap fully retracted.

The scale effect on the maximum lift coefficient for the retracted and extended positions of the flap, and the scale effect on the minimum drag coefficient with the flap retracted are given in figures 11 and 12, respectively. The scale effect on the maximum lift coefficient is less with the flap fully extended than retracted. The scale effect on the minimum drag coefficient with the flap retracted is pronounced in the lower range of Reynolds Numbers but, in the higher range, the drag coefficient approaches a constant value.

Rolling- and yawing-moment coefficients for deflections of the ailerons with the flap retracted are given in figure 13. Similar results for the flap fully extended are shown in figure 14. During the tests the differential movement of the ailerons was influenced to some extent by slack in the control system that could not be readily eliminated. The approximate relative movement of the ailerons, as observed during the tests, is shown in figure 5.

Performance Computations

In order to reduce the number of flight tests required, the effect of the Fowler flap on the performance

of the airplane was determined by computations made on the basis of the full-scale-tunnel data for a test velocity of 58 miles per hour. It should be appreciated, however, that while the comparisons made on the basis of these data show the manner in which the performance is affected by the use of flaps, in no case do the figures represent the true performance of the airplane because, in particular, the horizontal tail surfaces were not in place during the tunnel tests, the horsepower-available curve used is only approximate, and the effect of velocity on the lift and drag coefficients (shown by figs. 11 and 12) was not considered.

The Fowler wing furnished for the tests was made smaller than the standard wing presumably in an attempt to improve the all-round performance of the airplane instead of simply to decrease the landing speed. For this reason it was desirable to compare the performance for the Fowler installation with that for the standard wing. Unfortunately, the standard wing was never tested in the full-scale tunnel under the same conditions as was the Fowler wing and consequently an N.A.C.A. CYH wing, having the same area and approximately the same lift and drag characteristics (reference 1) as the standard wing, was arbitrarily chosen for the comparison.

Computed gliding characteristics.- Gliding characteristics of the airplane with each of the two wings are shown by the velocity diagrams of figure 15. This figure is based on the gross weight of 1,600 pounds. The disposable loads with the two wings are different by an amount equal to the difference in the wing weights. With the N.A.C.A. CYH wing, the minimum gliding speed is 50.6 miles per hour; with the Fowler wing with flap retracted, it is 60.7. Of this increase, 7 miles per hour may be attributed to the difference in wing area and only 3.1 miles per hour to the difference in the maximum lift coefficients. The Fowler wing with the flap fully extended gives a minimum speed of 44 miles per hour, a decrease of 6.6 miles per hour over that of the N.A.C.A. CYH. If equal disposable loads are assumed and the gross weight with the N.A.C.A. CYH wing is taken as 1,500 pounds, the minimum speed with this wing would be 49 miles per hour, which is still 5 miles per hour greater than that obtained with the Fowler wing.

The maximum L/D ratio for the airplane is slightly higher with the N.A.C.A. CYH wing than with the Fowler

wing, and the minimum gliding angle correspondingly less, being 5.4° as opposed to 5.6° . With the Fowler wing, however, the gliding angle may be varied from 5.6° at maximum L/D ratio to 9.6° at maximum lift, whereas with the N.A.C.A. CYH wing the possible variation is only from 5.4° to 7.4° . The horizontal distance that must be traveled in descending 100 feet in altitude may be varied with the Fowler wing from 591 to 1,020 feet, and with the N.A.C.A. CYH wing from 770 to 1,058 feet, a factor of considerable importance in the case of forced landings resulting from engine failure. The gliding angles are, of course, independent of weight and therefore the difference in the wing weights need not be considered in this connection.

Computed power-on characteristics.— Figure 16 gives the power-required curves for the N.A.C.A. CYH and the Fowler wings, from which a comparison may be made of the high-speed and climbing characteristics of the airplane with the two wings. The power curves, like the velocity diagrams, are computed on the basis of equal gross weight. Because of the reduction of wing area, the Fowler wing gives a high speed of 113.7 miles per hour as opposed to the 110.1 miles per hour obtained with the N.A.C.A. CYH wing. The ratio of high speed to the low speed in gliding flight (fig. 15) gives a speed range of 2.6 for the Fowler wing, whereas for the N.A.C.A. CYH wing the speed range is 2.2. On the basis of equal disposable loads, the airplane with the N.A.C.A. CYH wing has a speed range of 2.25.

Although the reduced area of the Fowler wing is beneficial in that it permits a higher speed for the same power, the climbing characteristics of the airplane are adversely affected by it. The maximum rate of climb with this wing is 571 feet per minute and the maximum angle of climb is 5.2° , while even with equal gross weight the maximum rate of climb of the N.A.C.A. CYH wing is 594 feet per minute and the angle 5.8° . With the disposable load reduced to that of the airplane with the Fowler wing, the maximum rate of climb with the N.A.C.A. CYH wing is 663 feet per minute and the maximum angle 6.7° .

The reduction in the rate and angle of climb with the Fowler wing for a given gross weight results from the higher angles of attack required for a given speed because of the smaller wing area. The minimum parasite-drag area (fig. 17) is obtained at an angle of attack of the fuselage of 1° . In the region of angles of attack corresponding to the climbing speeds, the parasite-drag area increases

with angle of attack to such an extent that, despite the smaller profile drag, the total drag with the Fowler wing at a given speed is greater than that with the plain wing. For example, with the N.A.C.A. CYH wing, maximum rate of climb occurs at a speed corresponding to a lift coefficient of 0.73 and an angle of attack of 3.4° . For the same gross weight and at the same speed the Fowler wing requires a lift coefficient of 0.96 and an angle of attack of 6.8° . Not only is the induced drag for the Fowler wing greater than that for the N.A.C.A. CYH wing but the parasite-drag areas (fig. 17) corresponding to the two conditions are 7.10 and 7.35 square feet, respectively.

It does not follow from the previously noted effects of the changes in wing weight and area that similar changes in a high-performance airplane would have equal relative importance. The increase in power required caused by such changes is primarily dependent on the geometric arrangement and wing loading of the airplane but is independent of the power available. Thus, for an airplane having a large amount of excess power, the percentage reduction for similar changes in the wing area would be small.

The Fowler flap, during its initial travel, moves almost straight aft from the basic wing, consequently increasing the effective area without greatly changing the camber. From the previous observations on the effect of changing the wing area, it will be appreciated that with this particular flap there is a possibility that the climbing characteristics will be slightly better with the flap partly extended than with it fully retracted. This possibility has been investigated and figure 18 has been prepared to show the horsepower required for various flap positions. The envelope curve represents the minimum power required for any flap setting. The figure shows that the angle of climb is greatest with the flap partly extended but that the rate of climb is best with the flap retracted. Additional computations have shown that a slightly higher ceiling is also attained with partial flap deflection.

CONCLUSIONS

1. The Fowler flap increased the maximum lift coefficient of the Fairchild 22 airplane from 1.27 to 2.41.

2. The angle of attack for maximum lift was not appreciably changed but the angle for zero lift was decreased by the Fowler flap.

3. The Fowler flap produced a large increase in the diving moment of the wing.

4. The 50 percent increase in weight of the Fowler wing over the standard wing counteracted to some extent the effect of the increased lift coefficient obtained with the Fowler wing.

5. The range of gliding angles in the slow speed range was doubled by use of the Fowler flap as compared with the standard wing.

6. The decreased area of the Fowler wing, although of advantage in increasing the high speed of the airplane, adversely affected the climbing performance.

7. Greater values of angle of climb and ceiling were shown by the computations to be possible with the Fowler flap partly extended than with it fully retracted.

FLIGHT TESTS

Method

The flight tests consisted of measurements to show the effect of the flap on the low speed of the airplane, the climbing characteristics, the take-off and landing run, the longitudinal stability, and the rudder effectiveness. The low speed was measured by means of an air-speed recorder, which had been previously calibrated against a suspended pitot-static head. The take-off and landing runs were measured by means of a method described in reference 2 involving the use of a phototheodolite. The effect of the flap on the longitudinal stability and control characteristics was determined by measurement of the elevator control force and the elevator position throughout the speed range with the flap both retracted and extended. The effect of the flap on the rudder control was found by recording the position of the rudder for steady flight with power both on and off. A spring balance attached to the flap operating crank was used to measure the flap op-

erating force. The weights for the various flight tests have been noted in the discussion. The center-of-gravity position for the flight tests was as indicated in table I.

Results and Discussion

Minimum speed.- As previously mentioned, the discussion of the performance characteristics of the airplane is based on the full-scale-tunnel tests of the airplane with the horizontal tail surfaces removed. Although these data are satisfactory for the purpose of the comparisons made, it was thought desirable to obtain the actual low speeds and maximum lift coefficients of the airplane for the two extreme flap positions in flight. Results of the flight tests are given in the following table.

Fowler Wing

Propeller stopped in vertical position. Weight 1,574 lb.

Flap retracted		Flap extended	
V_{min}	C_{Lmax}	V_{min}	C_{Lmax}
m.p.h.		m.p.h.	
58.8	1.35	44.4	2.37

The maximum lift coefficient obtained in flight with the standard Fairchild 22 wing is the same as that for the flap-up condition but, because of the larger area, the low speed was 51.5 miles per hour for the same weight.

A comparison of the maximum lift coefficients obtained in flight with those obtained in the full-scale wind tunnel shows an appreciable discrepancy. The tunnel tests were made without the horizontal tail surface in place. In flight there is an appreciable reduction in the effective lift coefficient of the wing owing to the down load on the tail required to balance the wing pitching moment. The approximate magnitude of this reduction in lift coefficient has been determined on the basis of the pitching moments determined in the full-scale wind tunnel. A comparison of the flight and tunnel values follows:

	Maximum lift coefficient	
	Flap retracted	Flap extended
Flight	1.35	2.37
Full-scale tunnel no horizontal tail surfaces.	1.27	2.41
tail correction applied.	1.25	2.25

The tunnel values after correction for the tail load appear to be about 0.1 less than the flight values for either flap position. The reason for this discrepancy is being investigated.

The previously discussed values of C_{Lmax} were obtained with the front windshield in place, whereas the F-22 airplane is normally operated in flight tests without it. It is of interest to note that without the windshield the maximum lift coefficients obtained in flight were 1.44 with flap retracted and 2.46 with flap extended. Thus, the windshield reduced the maximum lift coefficient 0.09 for either flap position. Another interesting point relating to the minimum speed is that with full throttle the minimum speed was reduced 5 miles per hour below that obtained with propeller idling or locked.

Climbing characteristics.- The rate of climb of the airplane at 2,000 feet altitude was measured at various speeds for several flap deflections in order to check the conclusion that the angle of climb would probably be better with the flap partly extended than with it fully retracted. The results of the test are given in figure 19. As the precision of the rate-of-climb measurements depends on the constancy of the engine performance and the constancy of the wind gradient with altitude and as the tests extended over several days, too much credit should not be given to the 5 percent increase in the rate of climb with flap extended 2-1/4 turns of the crank over that with the flap closed. The data, however, are sufficiently precise to show that the maximum rate of climb with the flap extended 2-1/4 turns is at least as great as with the flap

closed and, as the maximum rate of climb occurs at a lower speed with the flap extended 2-1/4 turns, the angle of climb for this flap setting is better than with the flap closed.

Take-off characteristics.— The effect of flap position on the take-off run of the airplane is shown in figure 20. The distance required to clear a 50-foot obstacle is given in addition to the distance required to leave the ground. The take-offs are comparable. The procedure was to determine in flight the readings of the pilot's air-speed meter at the stall with full throttle for each flap position. In the actual take-off runs the tail skid was lifted off the ground as soon as the aerodynamic forces were sufficient to do so, the fuselage was held approximately horizontal during the accelerating run, and the airplane was pulled off the ground at a speed of 2 to 3 miles per hour in excess of the stalling speed. During the climb of 50 feet the speed was maintained constant at the speed for the take-off.

The results show that no great gain in the take-off run was obtained until the flaps were extended about three turns of the crank. From the third to the fourth turn of the crank there was a considerable reduction in the required take-off distance. The minimum take-off distance required to clear 50 feet was obtained with the flap extended four to six turns. The variation of flap position between these limits produced very little effect. In this connection it should be noted that some difficulty was met in maintaining straight flight at low speed with the flap fully extended because of the ineffectiveness of the rudder, as will be explained later, and there is a possibility that the take-off run might have been shortest with flap fully extended but for this difficulty. The principal gain was in the ground run, which was reduced from 490 to 315 feet, or 175 feet; whereas the total run was decreased from 935 to 700 feet, or 235 feet. Thus the air run was reduced 60 feet, or approximately one-third of the reduction gained in the ground run.

Landing characteristics.— In the landing tests of the Fowler wing, only the normal braked landing was considered; that is, the type of landing the pilot would normally make after becoming familiar with the handling characteristics of the airplane. In addition to the ground run, the distance required to land from 50-foot

altitude was measured. The results of the tests are given in figure 21, which shows that the total landing run from a height of 50 feet can be reduced about one-third by use of the flaps. Of interest is the reduction of air run of 50 percent obtained because of the steeper glide angle with the flap extended.

Comparative data for normal landings of the airplane with the standard wing are given in figure 22. The landings were made with a weight of 1,450 pounds and into a wind of 8 to 10 miles per hour, about twice the wind velocity encountered during the tests of the Fowler wing. The difference in weight is approximately equal to the difference in wing weight. The increased wind accounts for a shortening of the total run of about 100 feet and ground run of 50 feet. Application of these corrections indicates that, for the same wind conditions, normal landings with the standard wing require about the same distance as with the Fowler wing with flap retracted. The ground run is slightly shorter because of the lower speed at contact but is compensated for by the increase of the length of the approach.

Longitudinal-control characteristics.- The effect of the Fowler flap on the longitudinal-control characteristics of the airplane is illustrated by curves of elevator angle and elevator control force for the standard tail surfaces in figure 23. With the flap retracted the variation of elevator angles and stick forces is normal. The elevator is moved progressively, trailing edge down, to increase the speed, and a progressively increasing push on the stick is required to accomplish this elevator movement. With the flap extended the elevator must be moved downward to increase the speed up to 70 miles per hour. Above this speed, however, the airplane is statically unstable. In order to increase the speed above 70 miles per hour, the elevator must first be further depressed and, after the desired speed change is obtained, the elevator must be brought up to a position above that required to maintain 70 miles per hour. This instability indicates the need of greater tail area for the flap-extended condition.

The curve of stick force for the flap-down condition also shows a reversal of slope. In this case, however, the change of slope occurs at 59 miles per hour instead of at 70 miles per hour. The reversal of stick force may be expected with static instability, or above 70 miles

per hour. The portion of the stick force curve between 59 and 70 miles per hour is of interest as an example of a type of instability noted on the airplane with various types of flap. With the normal wing or with the flap retracted, the tail area depends primarily on the rate of change of wing pitching moment with angle of attack. The actual magnitude of the moment is usually small. With the flap extended, the wing pitching moment is greatly increased, although its variation with angle of attack may be practically unchanged. Consequently, for stick-free stability, the magnitude of the tail moment that can be obtained with a given tail area becomes of considerable importance. For example, the minimum pitching-moment coefficient for the airplane without the tail and with the flap extended, as given by the full-scale-tunnel data, is -0.316 . If it is assumed that the tail moment is generated solely by the tail lift and the ratio of velocity at the tail to the velocity of the airplane is 1.0, the negative tail lift coefficient required for balance would be 0.511. The tests reported in reference 3 indicate that with the elevator free the maximum lift coefficient of a tail surface is of the order of 0.5. This value will vary, of course, with the tail shape and section, the interference effects, and the weight of the elevator but it is indicative of the conditions for the Fowler wing. On this basis, no matter what stabilizer setting was used, no stick-free balance speed should be expected with the flap extended. Actually, because of the difference between the true and assumed conditions, a balance speed of 59 miles per hour occurred. Both types of instability were eliminated by increasing the stabilizer area so as to increase the horizontal tail area from 26.2 to 37.4 square feet, or 43 percent.

Lateral-control characteristics.- The pilots considered the effectiveness of the Fowler ailerons to be slightly greater than that of the standard ailerons for the airplane. The difference in the rolling-moment coefficient between the flap-retracted and flap-extended conditions noted in the tunnel tests was not discernible in flight. The handling characteristics at the stall, however, were better with the flap retracted than with it extended or with the standard wing, probably because of the higher speed. The stick forces were satisfactory throughout the entire flying range but tended to increase with increasing air speed a greater amount than with the standard ailerons.

Directional-control characteristics.- The adverse effects of the flap on the rudder are illustrated by figure

24. The loss of rudder effectiveness was first noted in connection with the take-off tests when it was found that with flaps fully extended, full left rudder was required at take-off to prevent the airplane from turning to the right. The figure gives the rudder angles required for straightaway flight at various speeds. The curves have been corrected on the assumption that, were the airplane perfectly rigged, the rudder angle would be zero for the half-throttle condition. The loss of rudder effectiveness is shown by the greater amount of rudder that must be carried for the same speed and power conditions with flaps extended. Even for the condition assumed, three-quarters of the full rudder travel would be required for the take-off with the flap fully extended. This condition is not confined to the Fowler flap but is given here as an illustration of the general effect of flaps on the rudder control, indicating the need for larger rudder or fin surface for airplanes with wing flaps.

Flap operating force.- The force required to operate the Fowler flap at various speeds is shown in figure 25. The forces are well within the range of the physical capabilities of the average pilot. The highest force recorded was 10 pounds, which was obtained at a relatively high speed and at maximum deflection. For normal operation there is no need for exceeding a force of 7 pounds. Aside from the small magnitude of the force required for full deflection, it should be noted that for over one-half the travel the force was such that the flap tended to increase its deflection. The pilots rather liked the condition on this airplane although they appreciated that, if the magnitude of the forces were greater, it might be annoying not to be certain as to which direction the force should be applied when the flap was unlocked at partial deflection.

Miscellaneous remarks.- During the course of the tests it was noted that the tail buffeting present with all flaps previously tested on this airplane was greatly lessened with the Fowler flap. This flap extended across the center section, whereas the previous flaps had a 3-foot cutout at this point. Apparently the slot between the flap and the wing tends to reduce the turbulence in the flap wake that strikes the tail at certain angles of attack and is believed to be the cause of the buffeting. All flaps on this airplane, including the Fowler, tend to cause a certain amount of general instability aside from the items already noted. During straight flight in relatively smooth air the airplane may suddenly change attitude

longitudinally or drop a wing. It tends to recover immediately without oscillation, but the pilots consider the phenomenon annoying.

CONCLUSIONS

1. The minimum speed of the Fairchild airplane was reduced from 58.8 miles per hour with the Fowler flap retracted to 44.4 miles per hour with it extended.

2. The take-off run to an altitude of 50 feet was decreased from 935 to a minimum of 700 feet by extending the flap approximately five-sixths of its travel, three-quarters of the reduction being accounted for in the ground run.

3. The horizontal distance in landing from a height of 50 feet and coming to a stop was reduced approximately one-third by use of the Fowler flap.

4. Both the directional and longitudinal control of the airplane were adversely affected by the Fowler flap in common with other types of flap previously tested on this airplane, indicating that the tail surface requirements are more critical for airplanes with flapped than unflapped wings.

5. The highest flap operating force recorded was 10 pounds at 79 miles per hour. The force decreased with air speed to approximately 4 pounds for full deflection at 52 miles per hour.

Langley Memorial Aeronautical Laboratory,
National Advisory Committee for Aeronautics,
Langley Field, Va., May 27, 1936.

REFERENCES

1. DeFrance, S. J.: Effect of the Surface Condition of a Wing on the Aerodynamic Characteristics of an Airplane. T.N. No. 495, N.A.C.A., 1934.
2. Thompson, F. L., Peck, W. C., and Beard, A. P.: Air Conditions Close to the Ground and the Effect on Airplane Landings. T.R. No. 489, N.A.C.A., 1934.
3. Smith, R. H.: Lift, Drag, and Elevator Hinge Moments of Handley Page Control Surfaces. T.R. No. 278, N.A.C.A., 1927.

TABLE I

CHARACTERISTICS OF FAIRCHILD 22 AIRPLANE WITH FOWLER WING

Wing:

Area, S	132 sq. ft.
Span, b	31 ft.
Chord of basic airfoil, c	4 ft. 4 in.
Mean geometric chord (used in full-scale-wind-tunnel calculations of pitching-moment coefficients)	4.25 ft.
Aspect ratio	7.27
Airfoil section	N.A.C.A. 2415
Angle of wing setting	5°
Dihedral	0°

Fowler flap:

One section extended between ailerons:

Span, b_f	22 ft. 1/2 in. (71 percent b)
Chord, c_f	15-1/2 in. (30 percent c)
Airfoil section	N.A.C.A. 2412

Fully deflected position:

L. E. of flap in relation to T. E. of wing	2 in. below, 1/8 in. forward
Angle relative to basic wing chord	29°

Ailerons:

Span	3 ft. 8 in. (24 percent b/2)
Chord, c_a	15 in. (29 percent c)

Balance chord 4 in. (27 percent c_a)

Neutral setting (rel-
ative to wing chord). . . Up 5°

Deflection from neutral . . . Up 36°
Down 21°

Stabilizer:

Area:

Original 15.8 sq. ft.

After modification , . . 27.0 sq. ft.

Span 10 ft.

Deflection (relative
to thrust axis). Up 4.1°
Down 2.5°

Elevator:

Area 10.4 sq. ft.

Deflection (relative to
thrust axis) Up 28°
Down 27°

Distance from L. E. of
wing to elevator hinge . . . 14 ft. 3 in. or 3.36 S/b

Fin:

Area 4.1 sq. ft.

Rudder:

Area 6.0 sq. ft.

Deflection Right 20°
Left 20°

Weighing data:

Weight 1,574 to 1,600 lb.

c.g. position (used as origin for full-scale-tunnel
pitching-moment coefficients):

Aft leading edge of wing . . . 14-1/2 in.

Below thrust axis 5/8 in.

c.g. position (flight tests):

Aft leading edge of wing . . . 19-3/8 in.

Above thrust axis 1-3/8 in.

Engine:

Four-cylinder inverted air-cooled Cirrus

Rated horsepower 95 at 2,100 r.p.m.

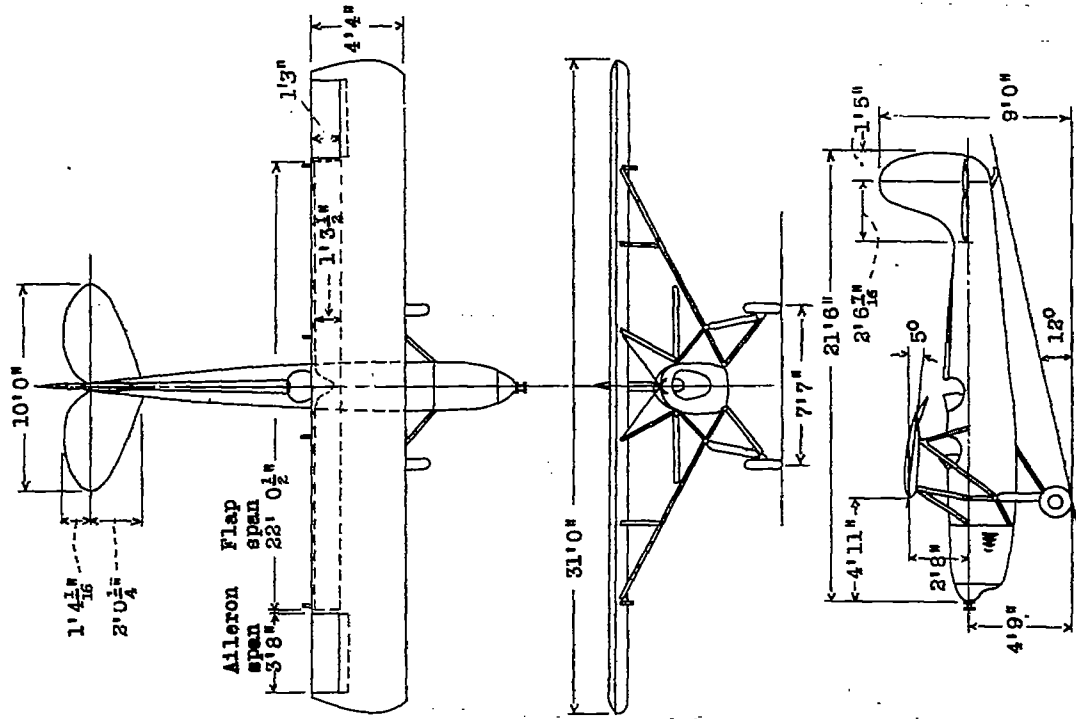
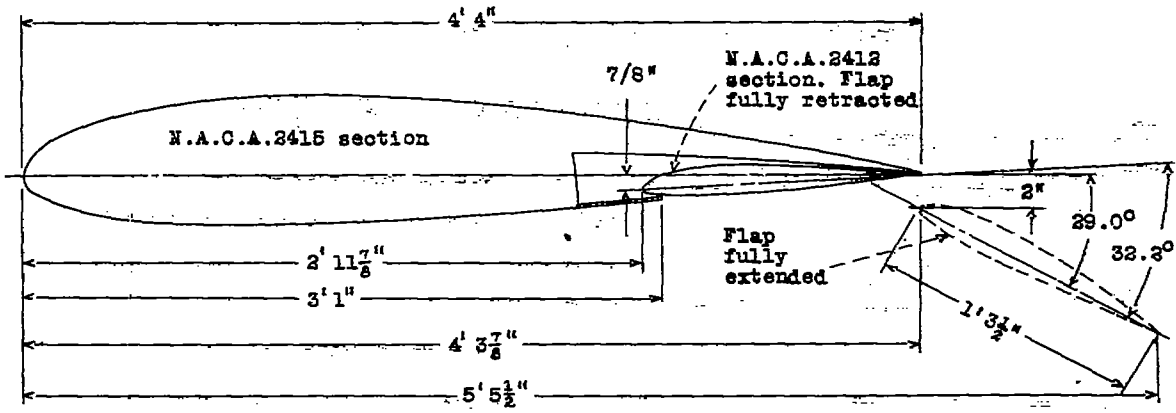

Figure 1.-Installation of Fowler wing on Fairchild-22 airplane.



22
31

Figure 2.-Sectional view of Fowler wing showing extreme positions of flap.

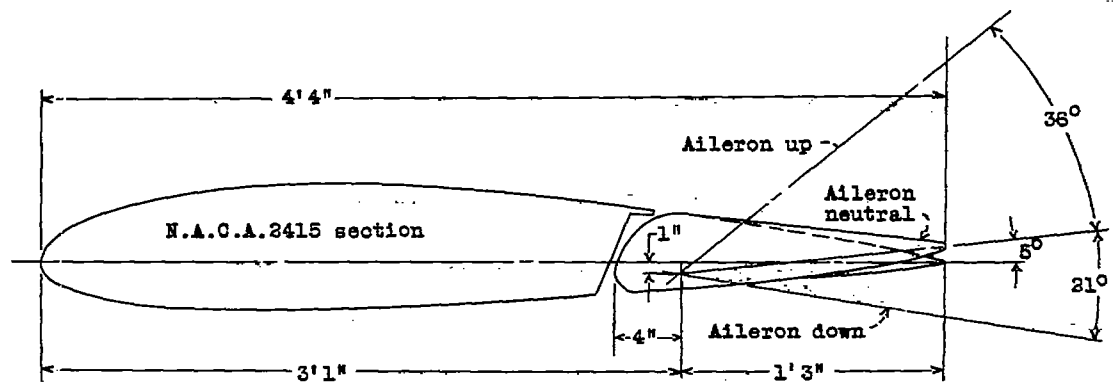

Figure 4.- Sectional view of Fowler wing showing aileron positions.

Figure 3.- Variation of flap position with turns of operating crank.

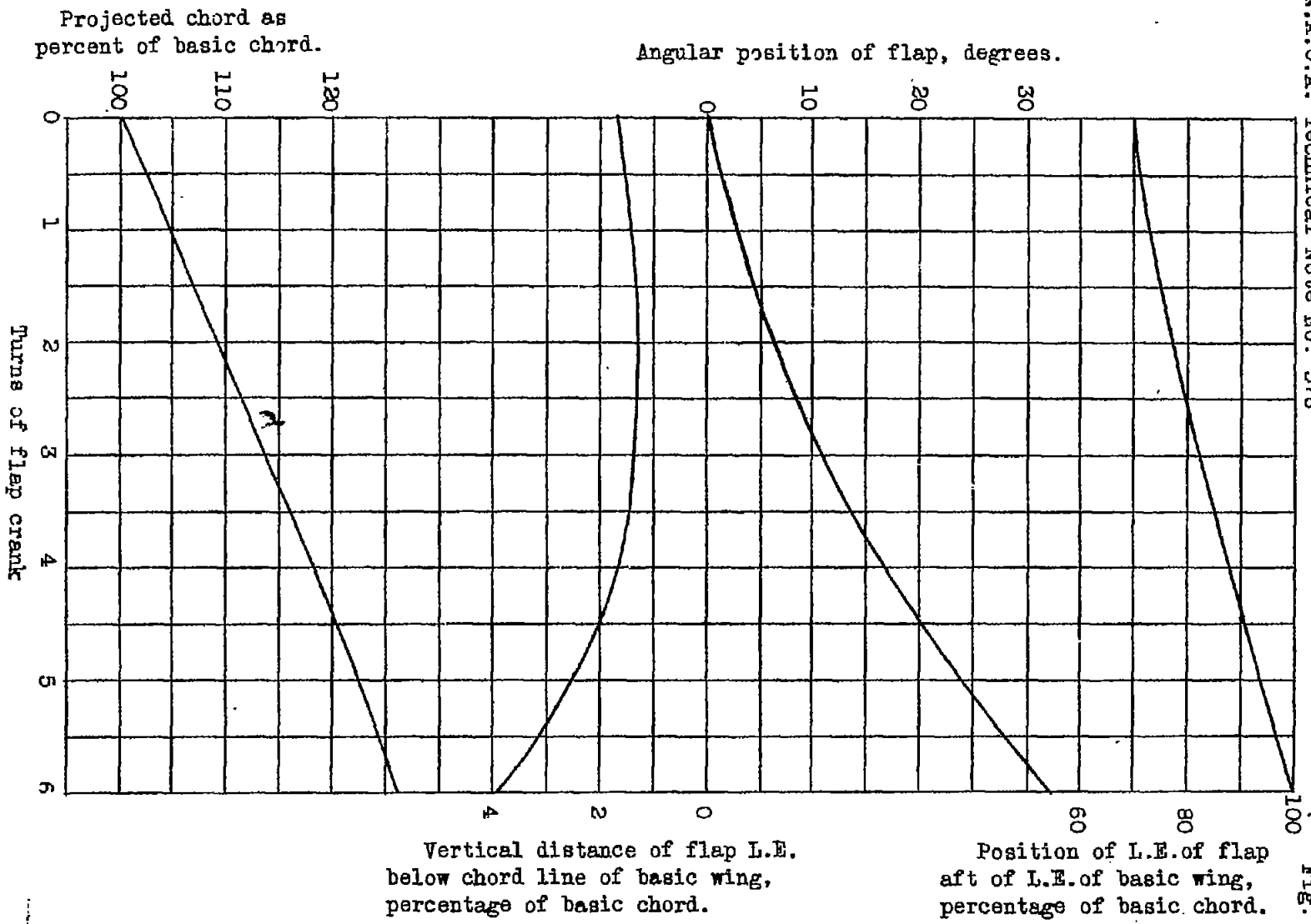

Fig. 3

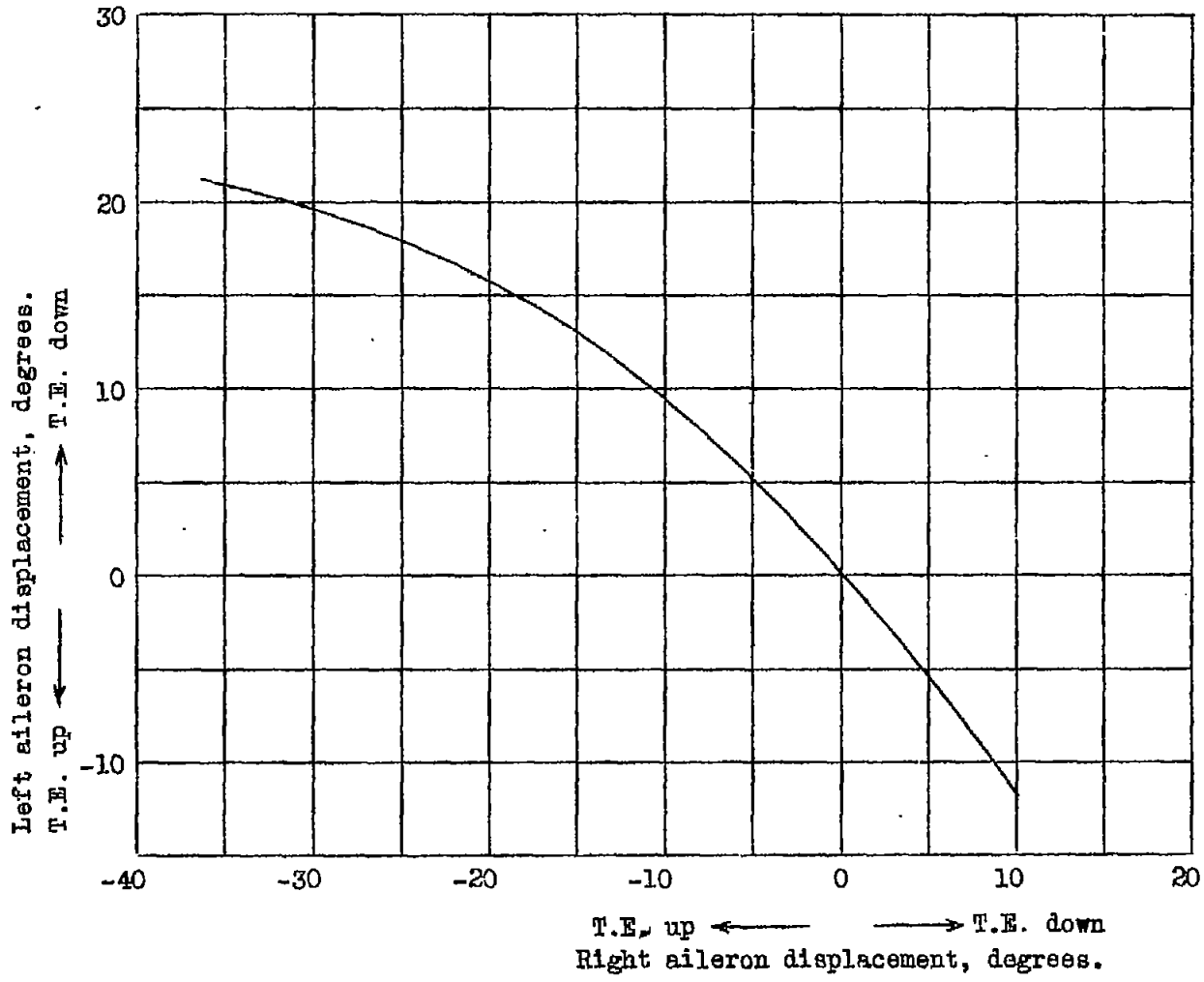

Figure 5.- Differential motion of ailerons from neutral for Fairchild 22 airplane with 30-percent Fowler flap.

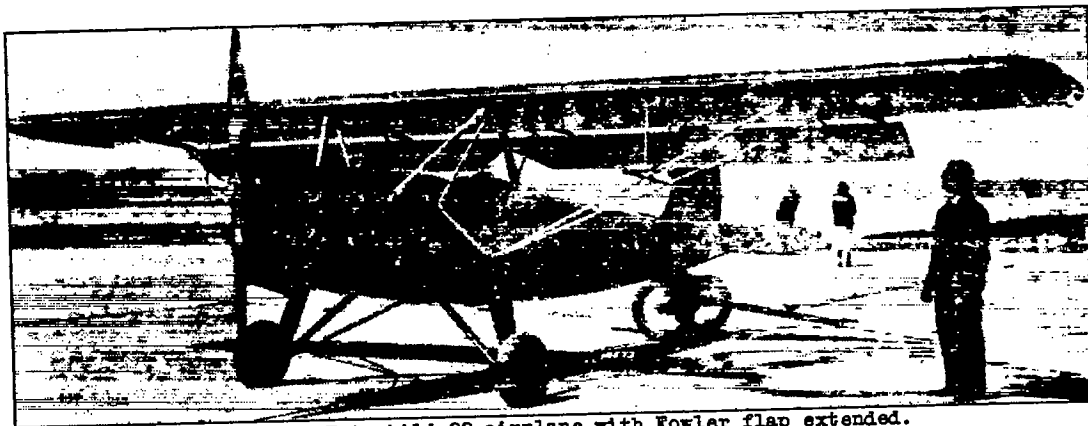

Figure 6.-Fairchild 22 airplane with Fowler flap extended.

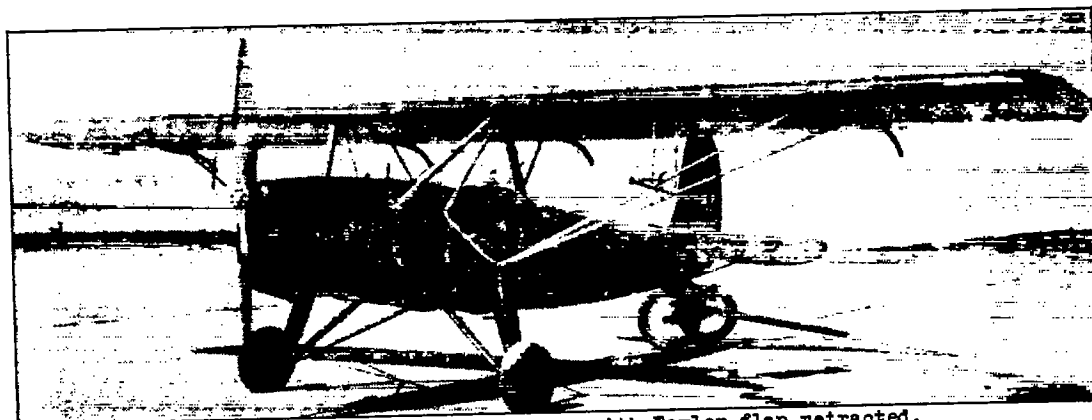

Figure 7.-Fairchild 22 airplane with Fowler flap retracted.

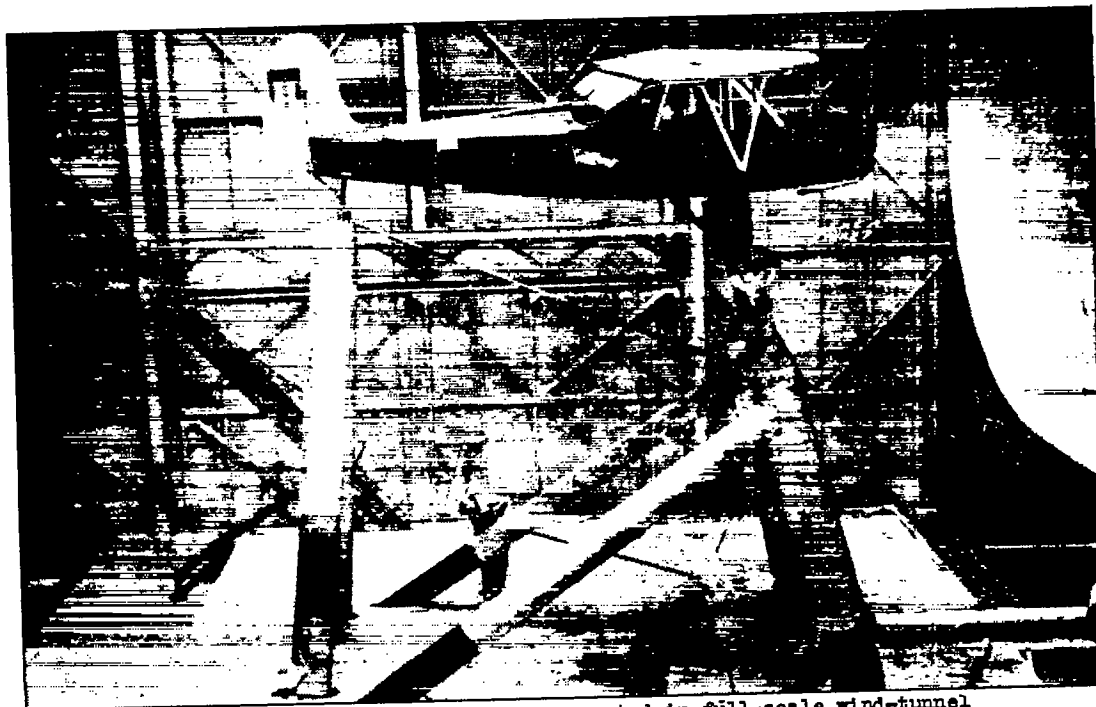

Figure 8.-Fairchild 22 airplane mounted in full-scale wind-tunnel

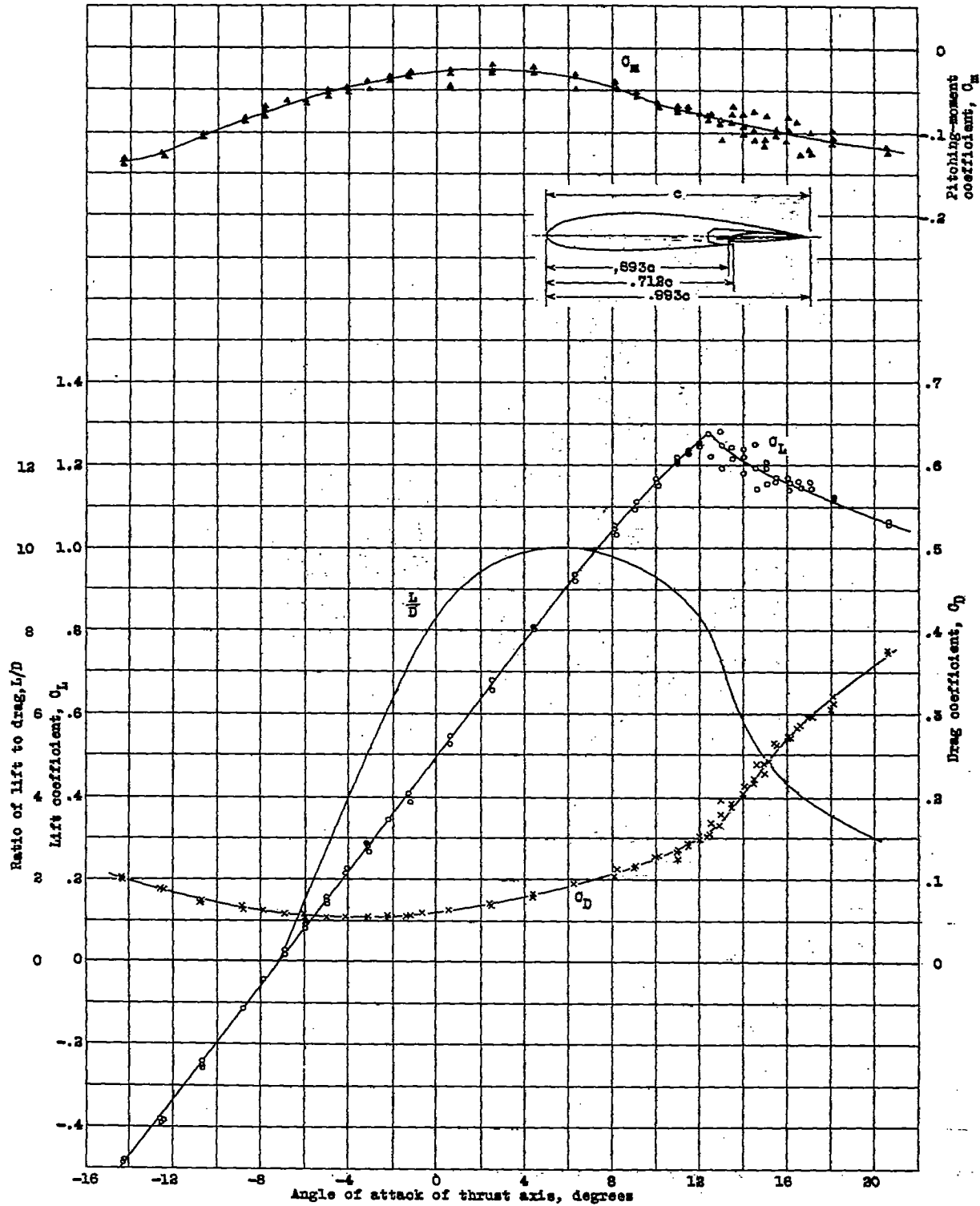

Figure 8a.- Aerodynamic characteristics of Fairchild-22 airplane with 30-percent Fowler flap. Flap retracted. Propeller and horizontal tail surfaces removed. Results corrected for tunnel effects. Test velocity, approximately 69 m.p.h.

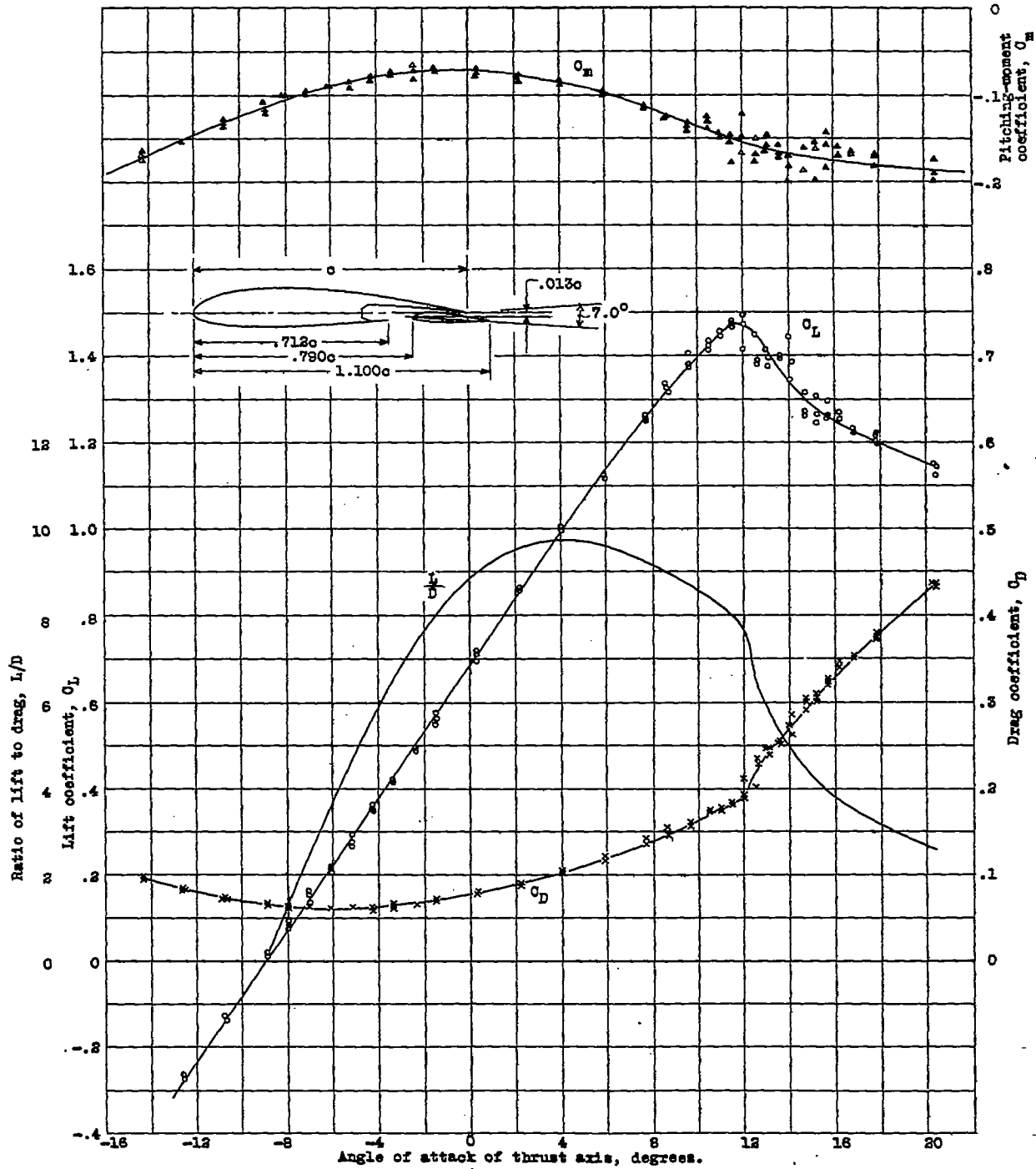

Figure 9b.- Aerodynamic characteristics of Fairchild-28 airplane with 30-percent Fowler flap. Flap extended 2.35 turns of crank. Propeller and horizontal tail surfaces removed. Results corrected for tunnel effects. Test velocity, approximately 55 m.p.h.

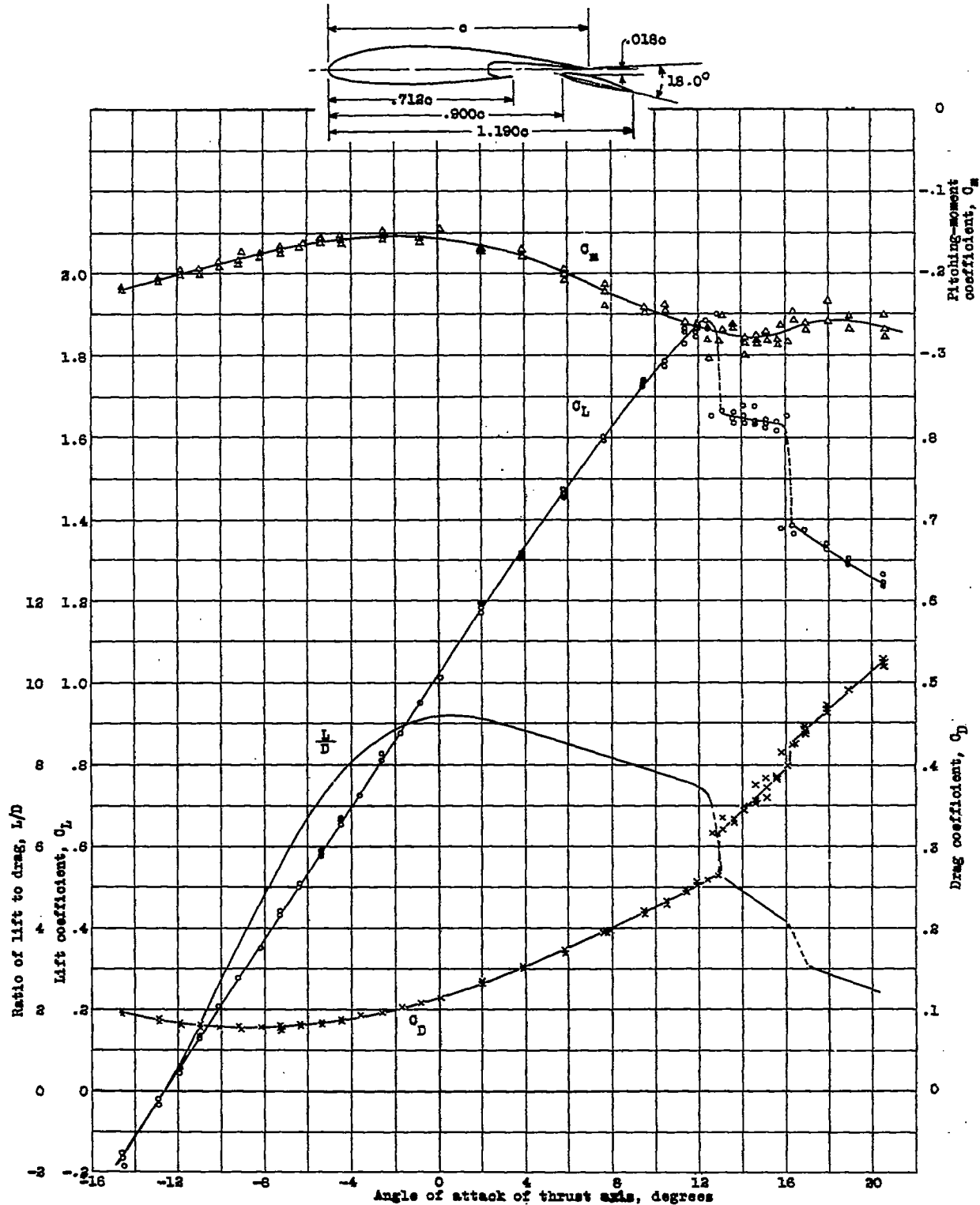

Figure 9c.- Aerodynamic characteristics of Fairchild 22-airplane with 30-percent Fowler flap. Flap extended 4.25 turns of crank. Propeller and horizontal tail surfaces removed. Results corrected for tunnel effects. Test velocity, approximately 58 m.p.h.

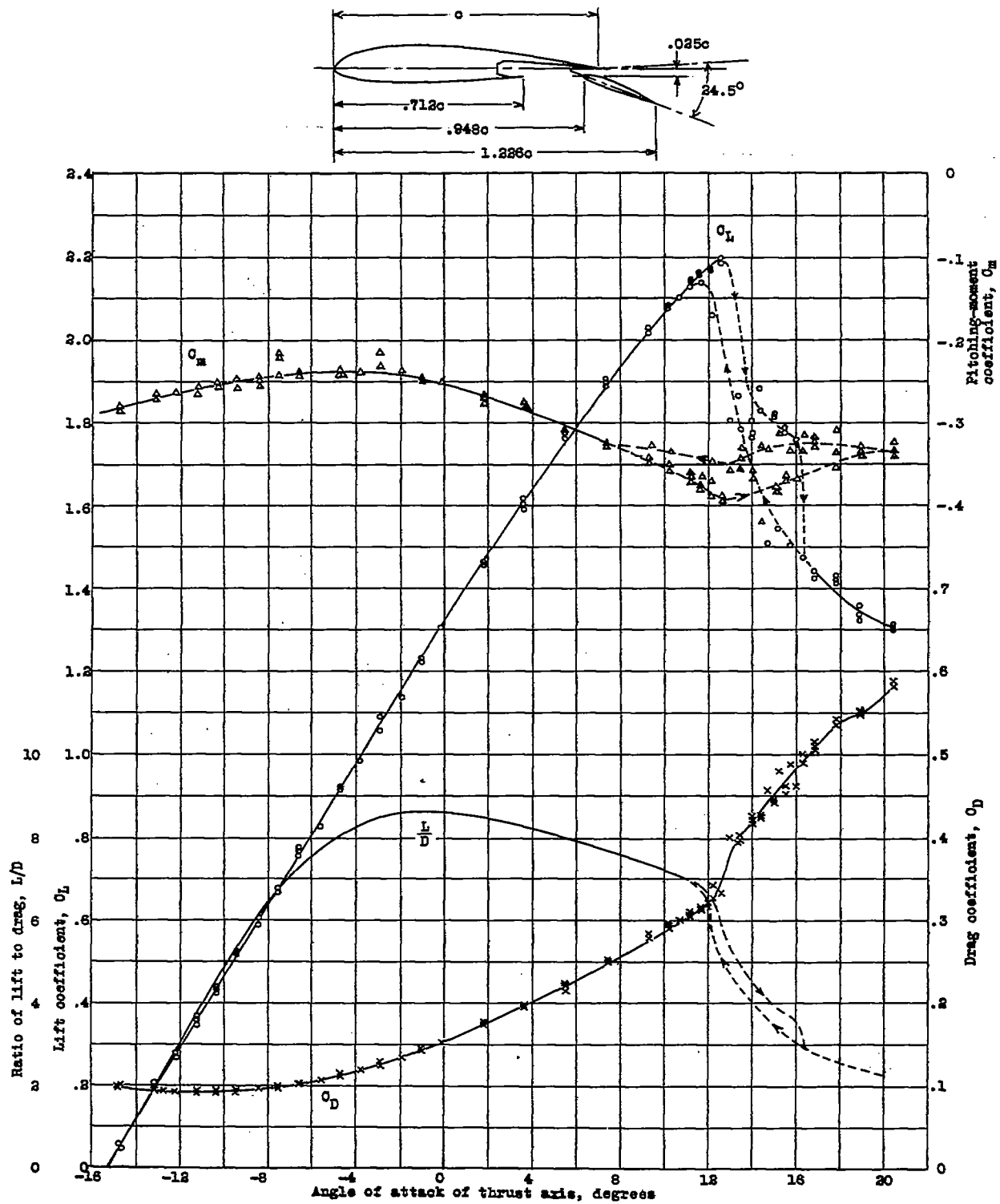

Figure 9d.- Aerodynamic characteristics of Fairchild-23 airplane with 30-percent Fowler flap. Flap extended 5.05 turns of crank. Propeller and horizontal tail surfaces removed. Results corrected for tunnel effects. Test velocity, approximately 58 m.p.h.

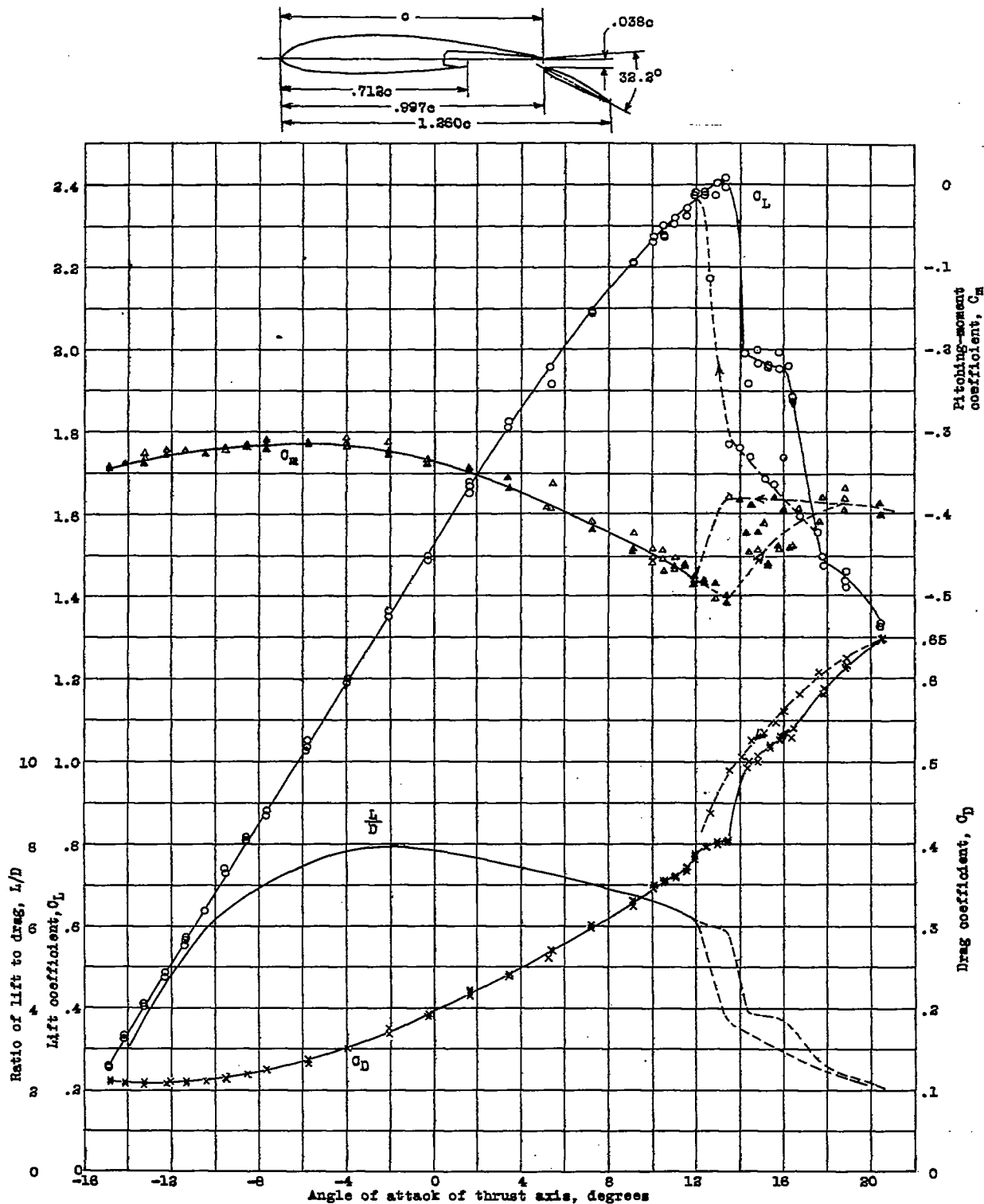

Figure 9e.- Aerodynamic characteristics of Fairchild-28 airplane with 30-percent Fowler flap. Flap fully extended (8 turns of crank). Propeller and horizontal tail surfaces removed. Results corrected for tunnel effects. Test velocity, approximately 88 m.p.h.

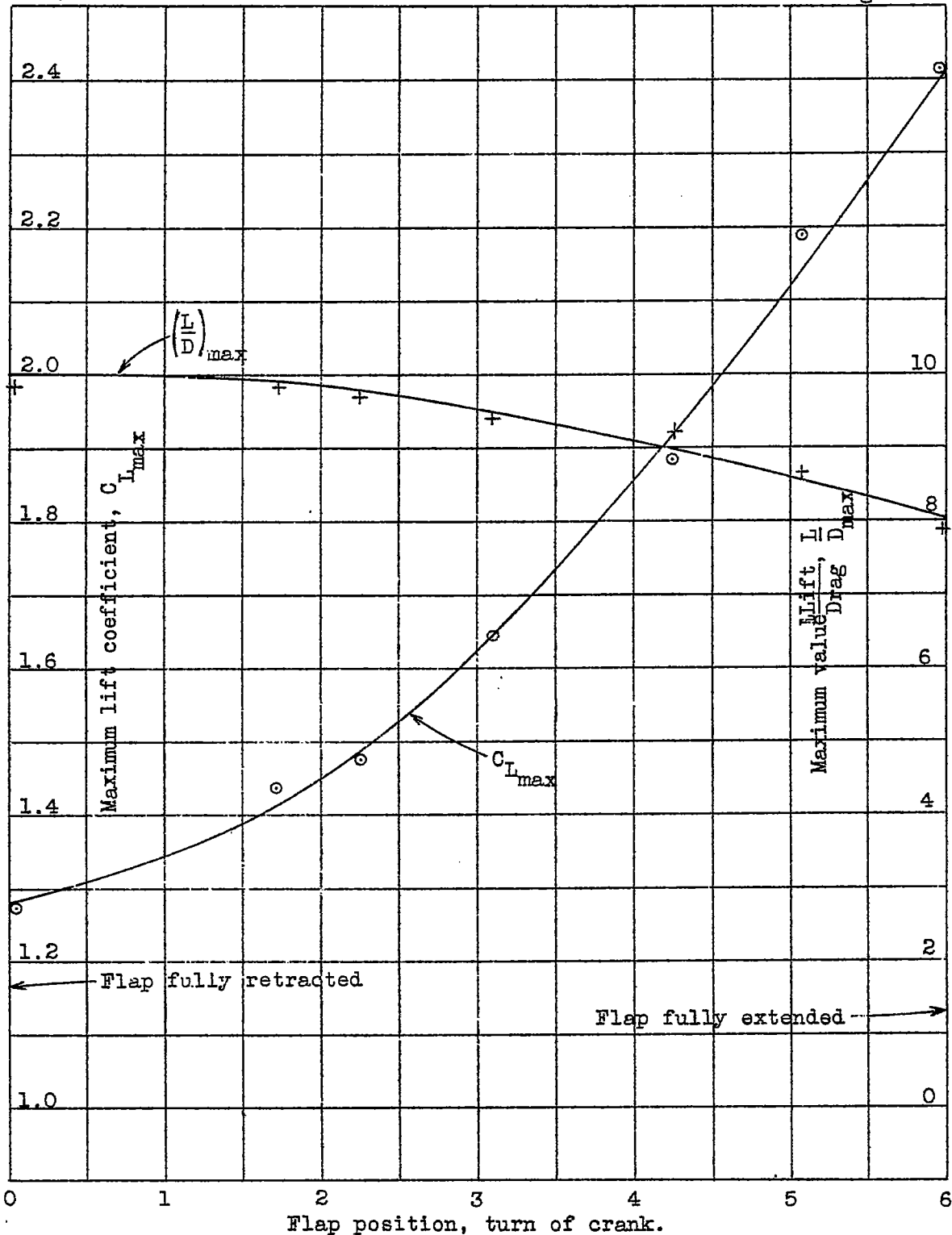

Figure 10.- Variation of maximum lift-drag ratio and maximum lift coefficient with crank position. Fairchild 22 airplane with 30-percent Fowler flap, propeller and horizontal tail surfaces removed.

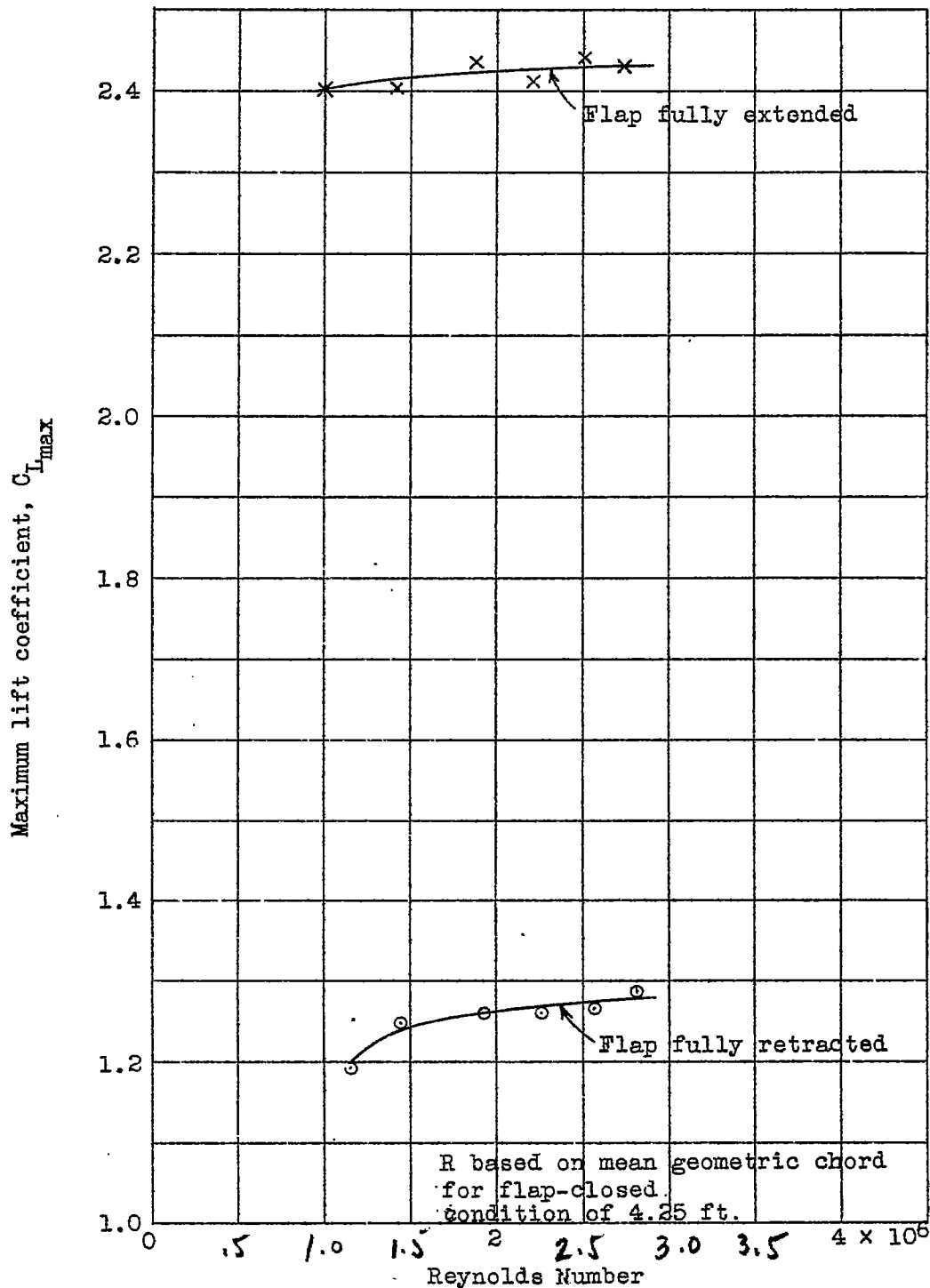

Figure 11.- Scale effect on maximum lift coefficient. Fairchild 22 airplane with 30-percent Fowler flap, propeller and horizontal tail surfaces removed.

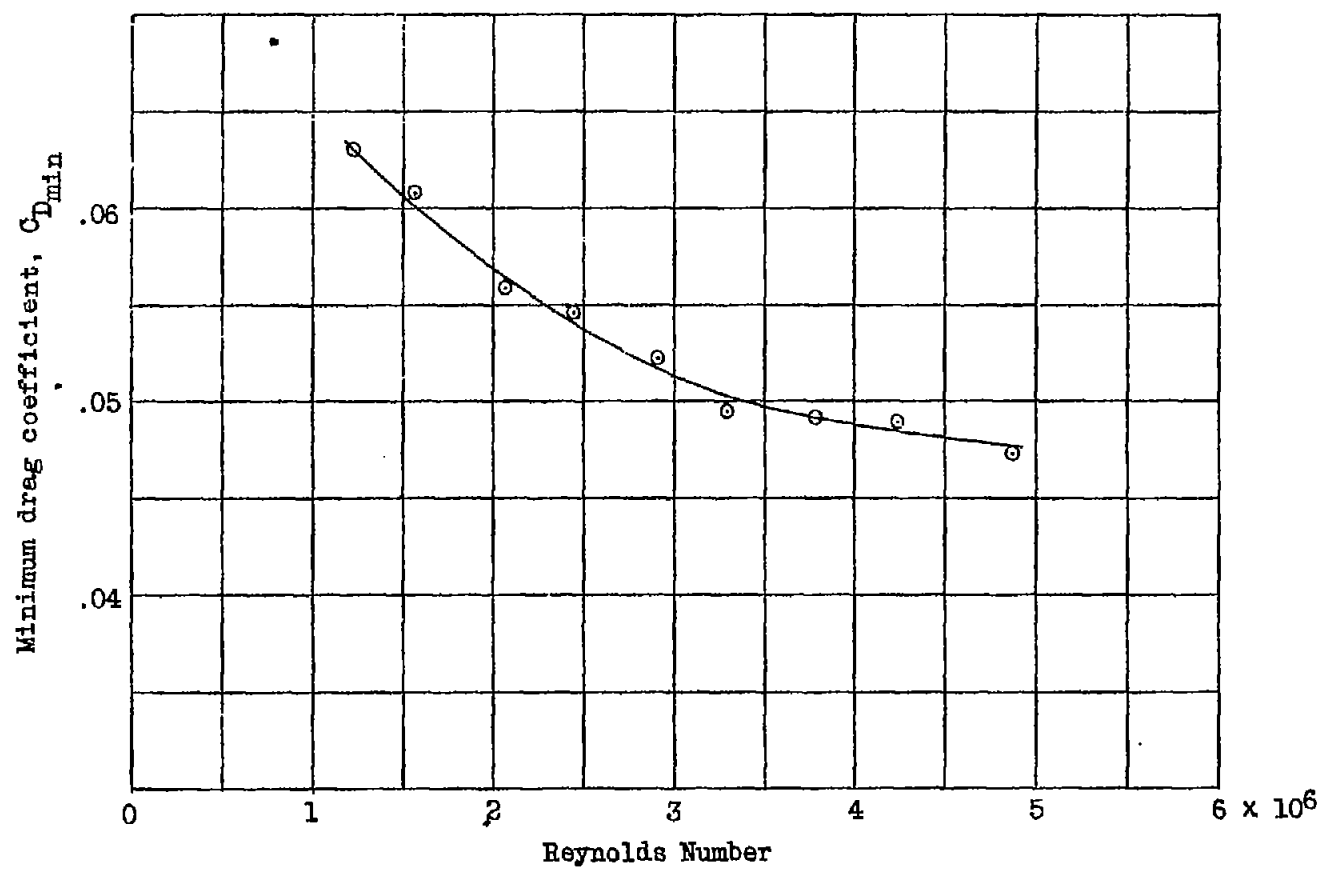

Figure 12.- Scale effect on the minimum drag coefficient with flap retracted. Fairchild 22 airplane with 30-percent Fowler flap. Flap fully retracted. Propeller and horizontal tail surfaces removed.

Fig. 12

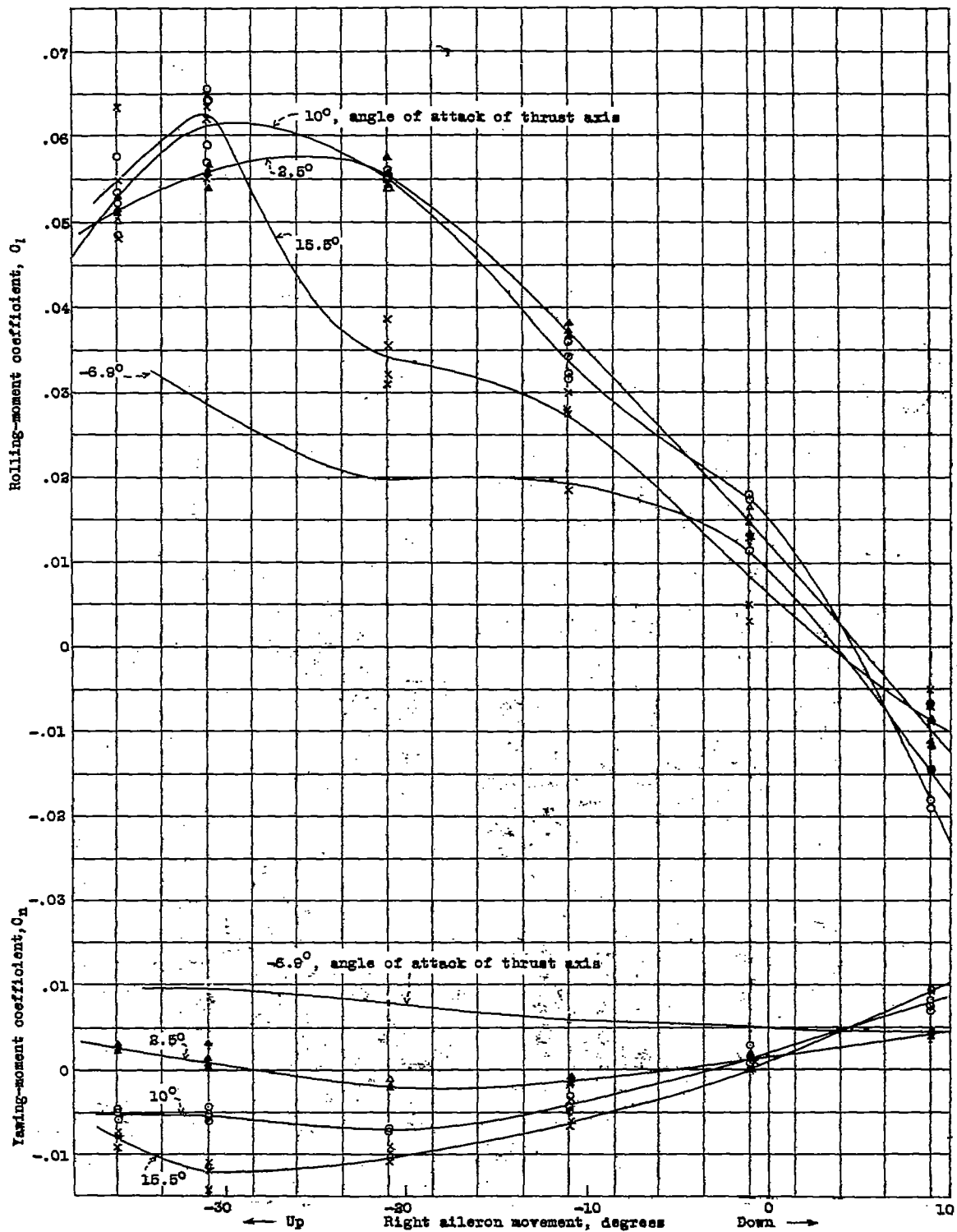

Figure 15.- Rolling- and yawing-moment coefficients due to ailerons. Flap retracted. Fairchild-22 airplane with 20-percent Fowler flap. Propeller and horizontal tail surfaces removed.

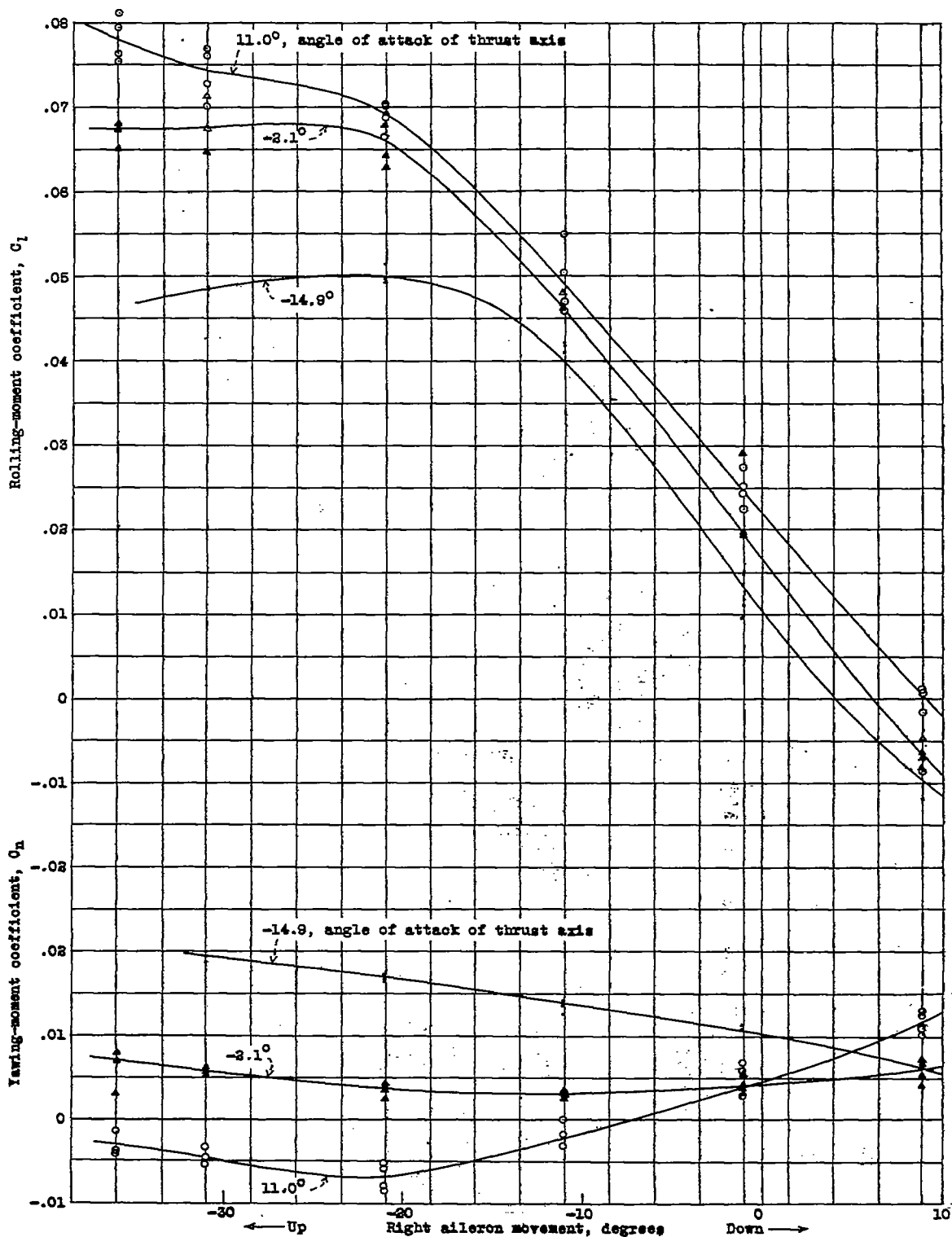

Figure 14.- Rolling and yawing-moment coefficients due to ailerons. Flap extended. Fairchild-22 airplane with 30-percent Fowler flap. Propeller and horizontal tail surfaces removed.

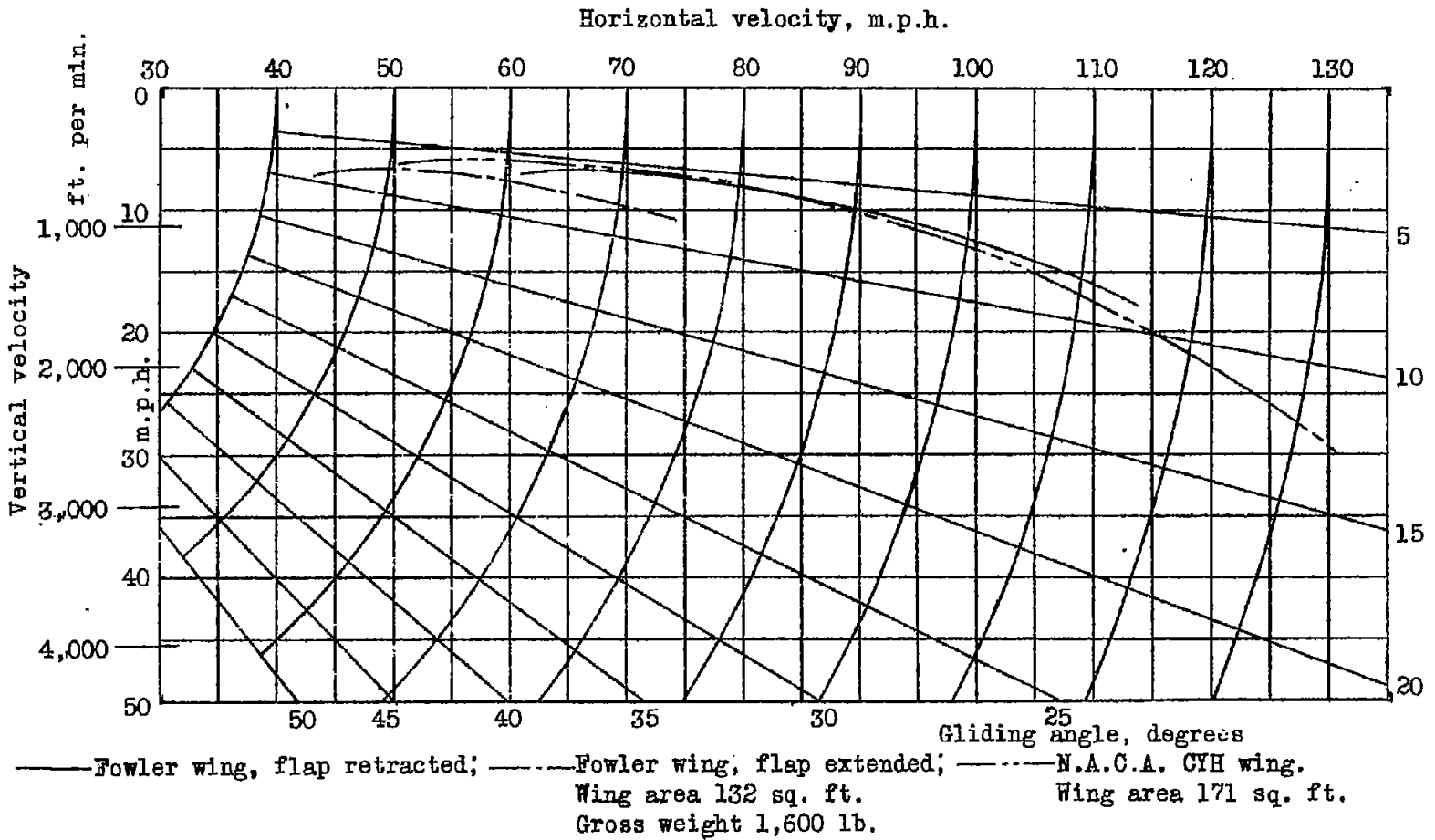
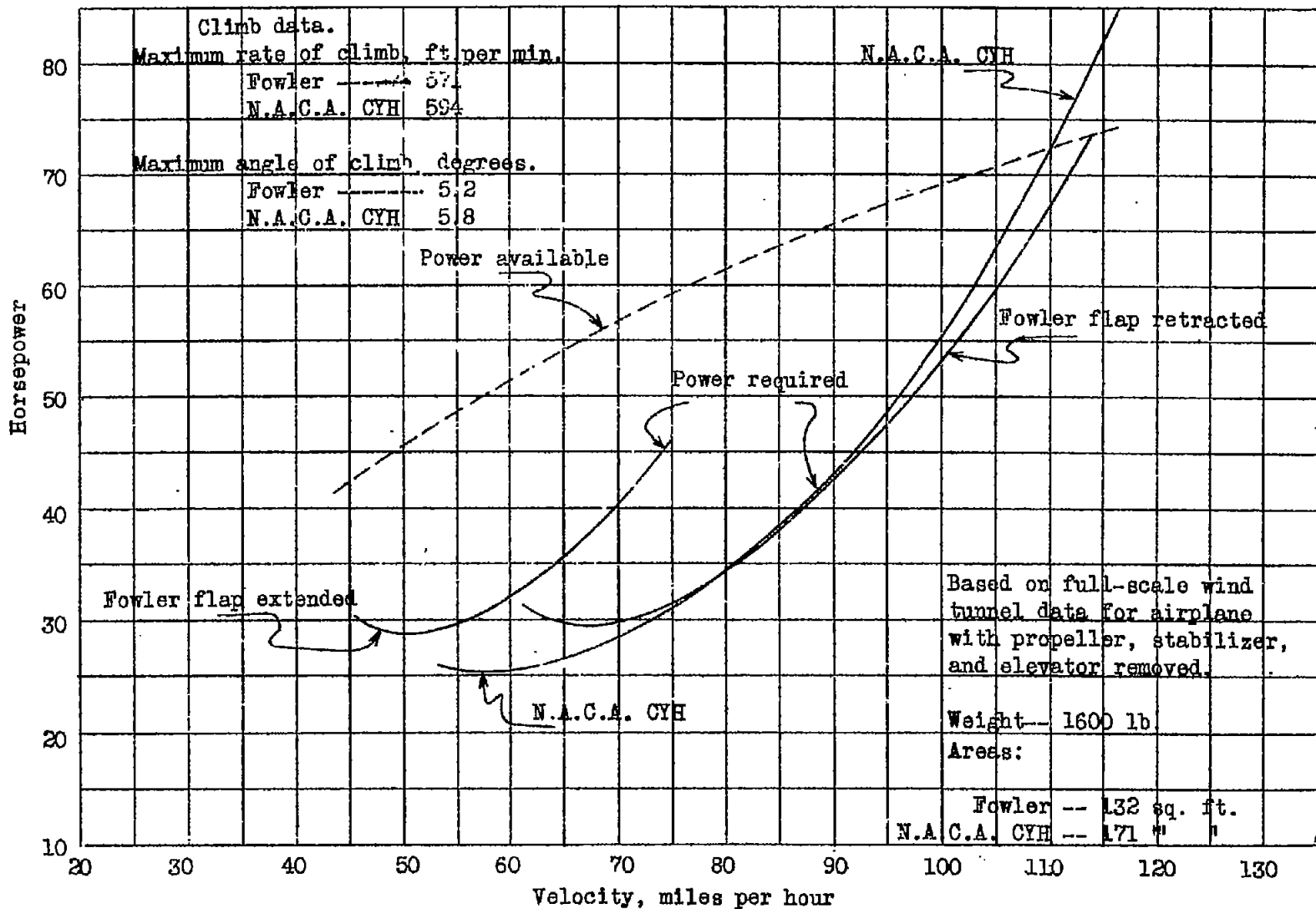

Figure 15.- Velocity diagrams for Fairchild 22 airplane with Fowler wing.
 Based on full-scale wind tunnel data with propeller, stabilizer
 and elevator removed.



N.A.C.A. Technical Note No. 578

Fig. 16

Figure 16.- Power curves for Fairchild 22 airplane for extreme positions of Fowler flap.

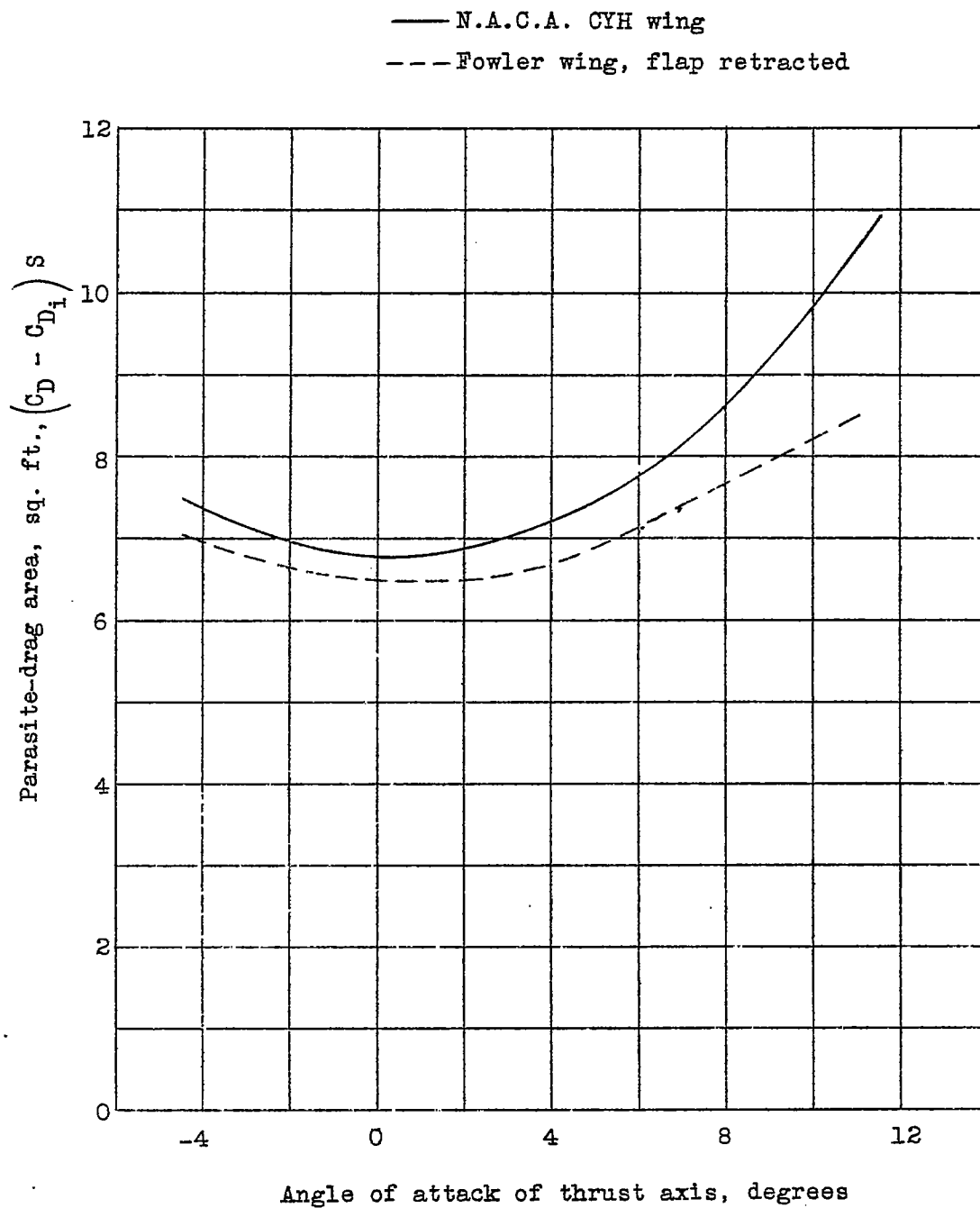

Figure 17.- Parasite-drag area of Fairchild 22 airplane.

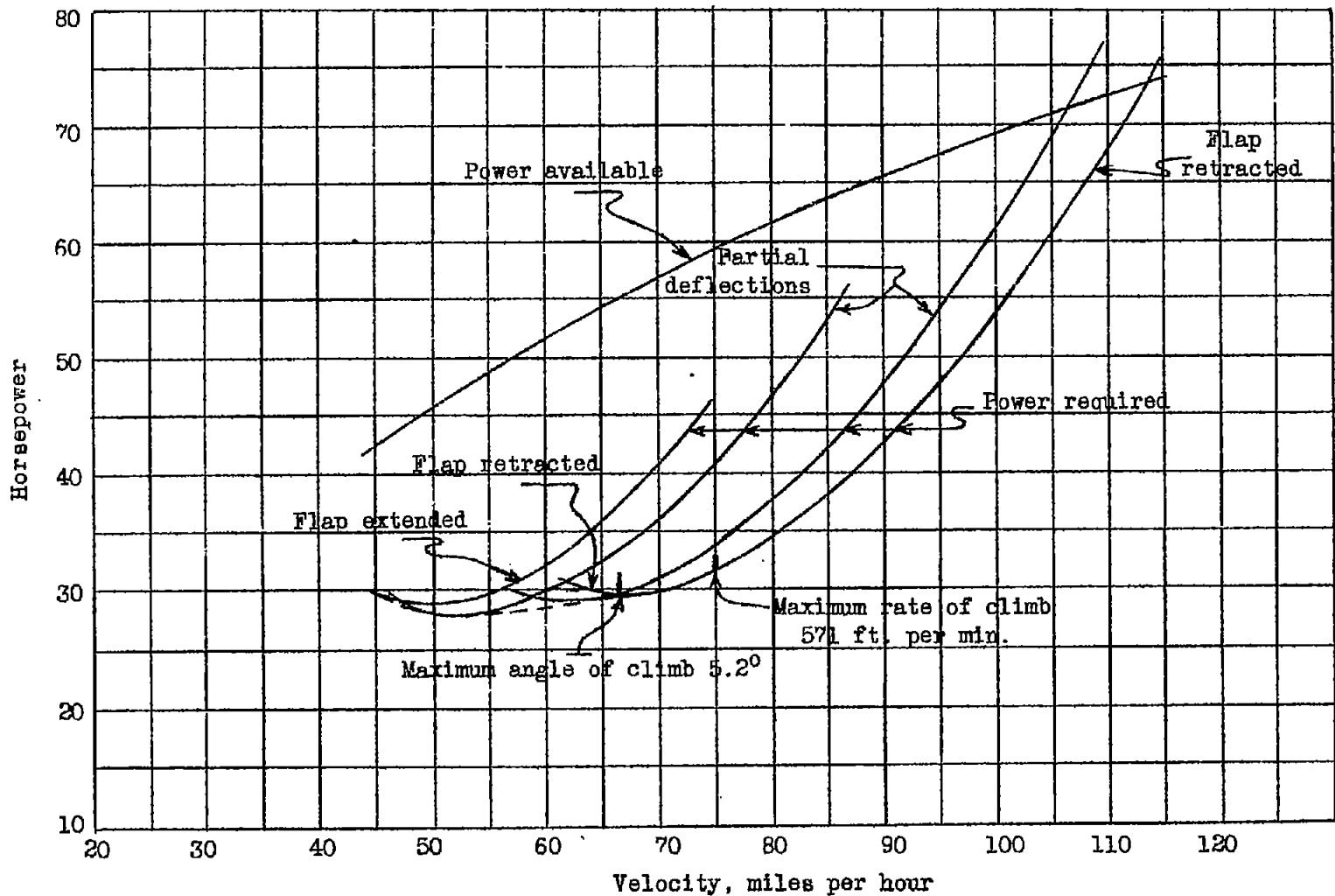

Figure 18.- Effect of position of Fowler flap on power required. Based on full-scale wind tunnel data for airplane with propeller, stabilizer and elevator removed. Weight 1,600 lb. Area 132 sq.ft.

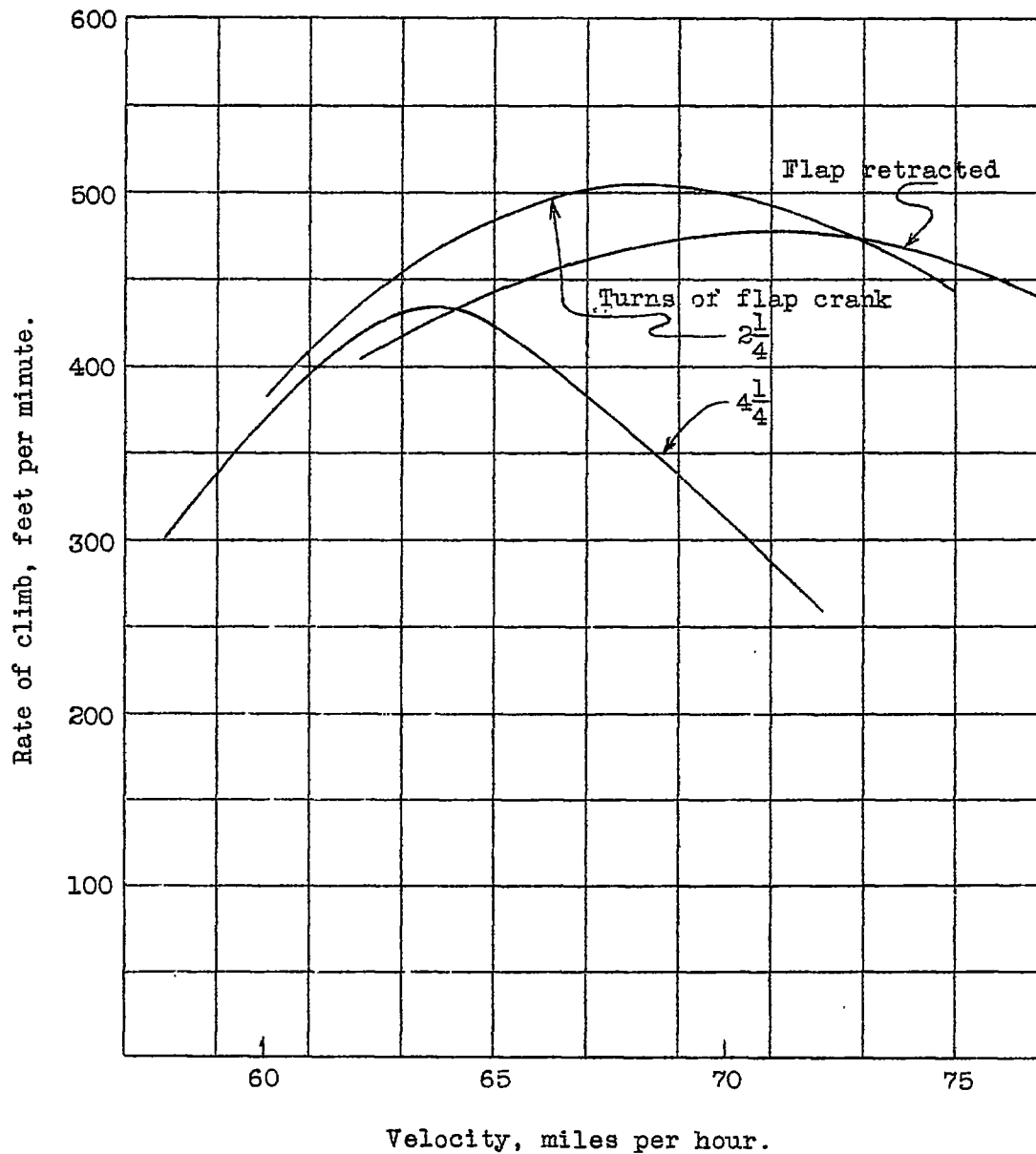

Figure 19.- Effect of position of Fowler flap on rate of climb.
Altitude, 2,000 ft.; Weight, 1,560 lb.

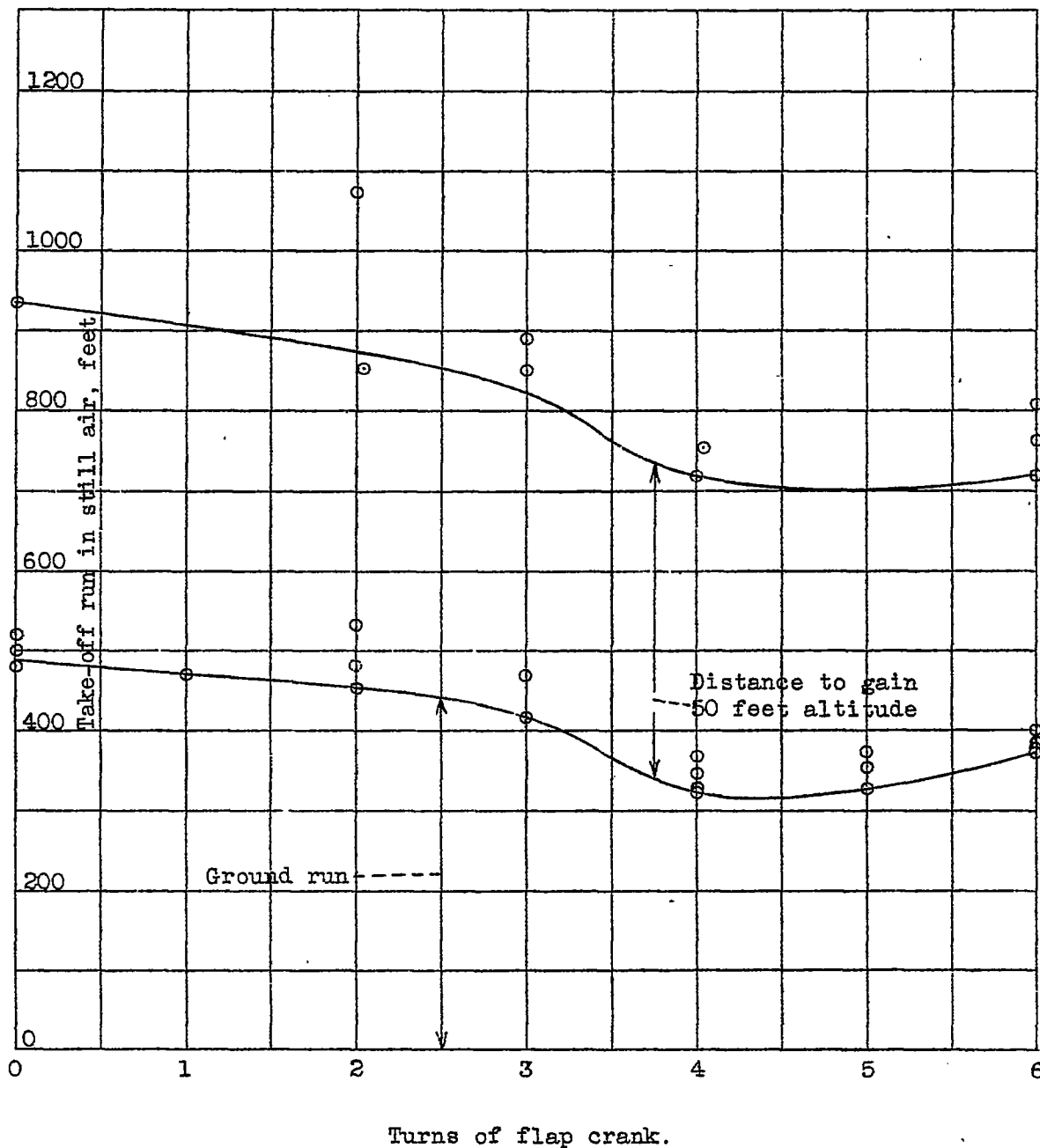

Figure 20.- Variation of take-off run with position of Fowler flap.
Gross weight, 1,580 lb.

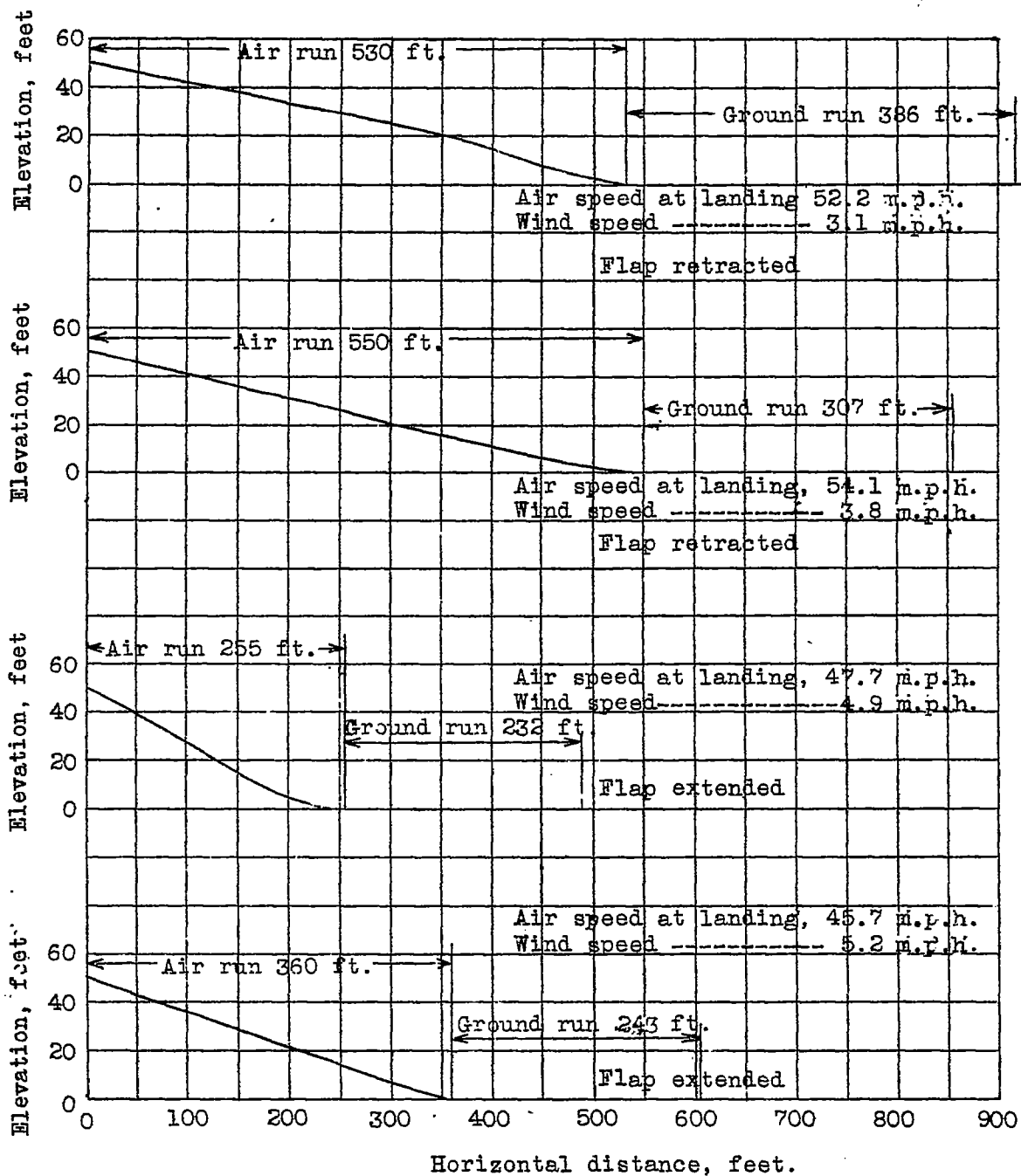
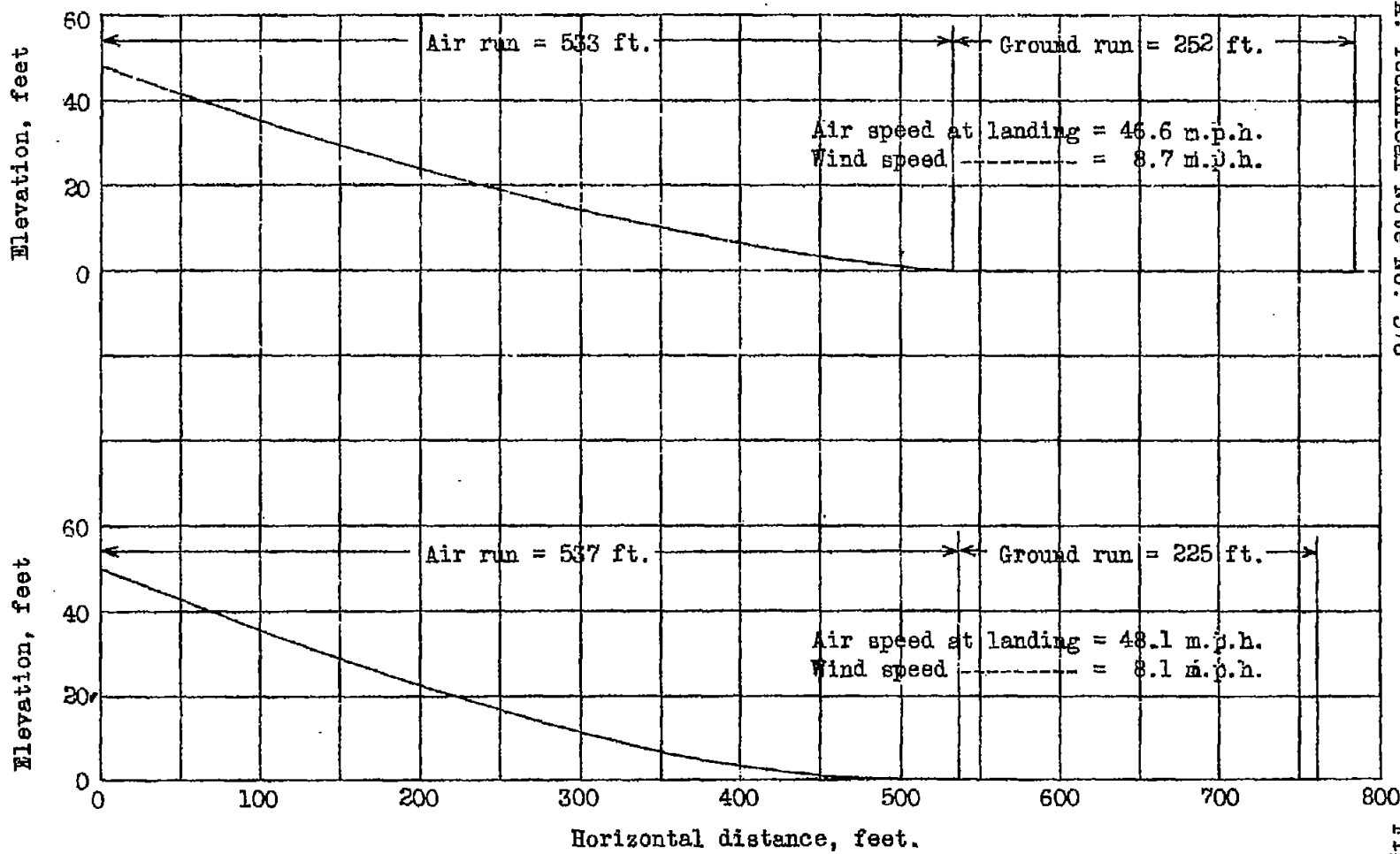

Figure 21.- Effect of Fowler flap on landing run of Fairchild 22 airplane.
 Weight 1,580 lb. Normal operation of wheel brakes.



N.A.C.A. Technical Note No. 578

Fig. 22

Figure 22.- Landing run of Fairchild 22 airplane with standard wing.
Weight, 1,450 lb. Normal operation of wheel brakes.

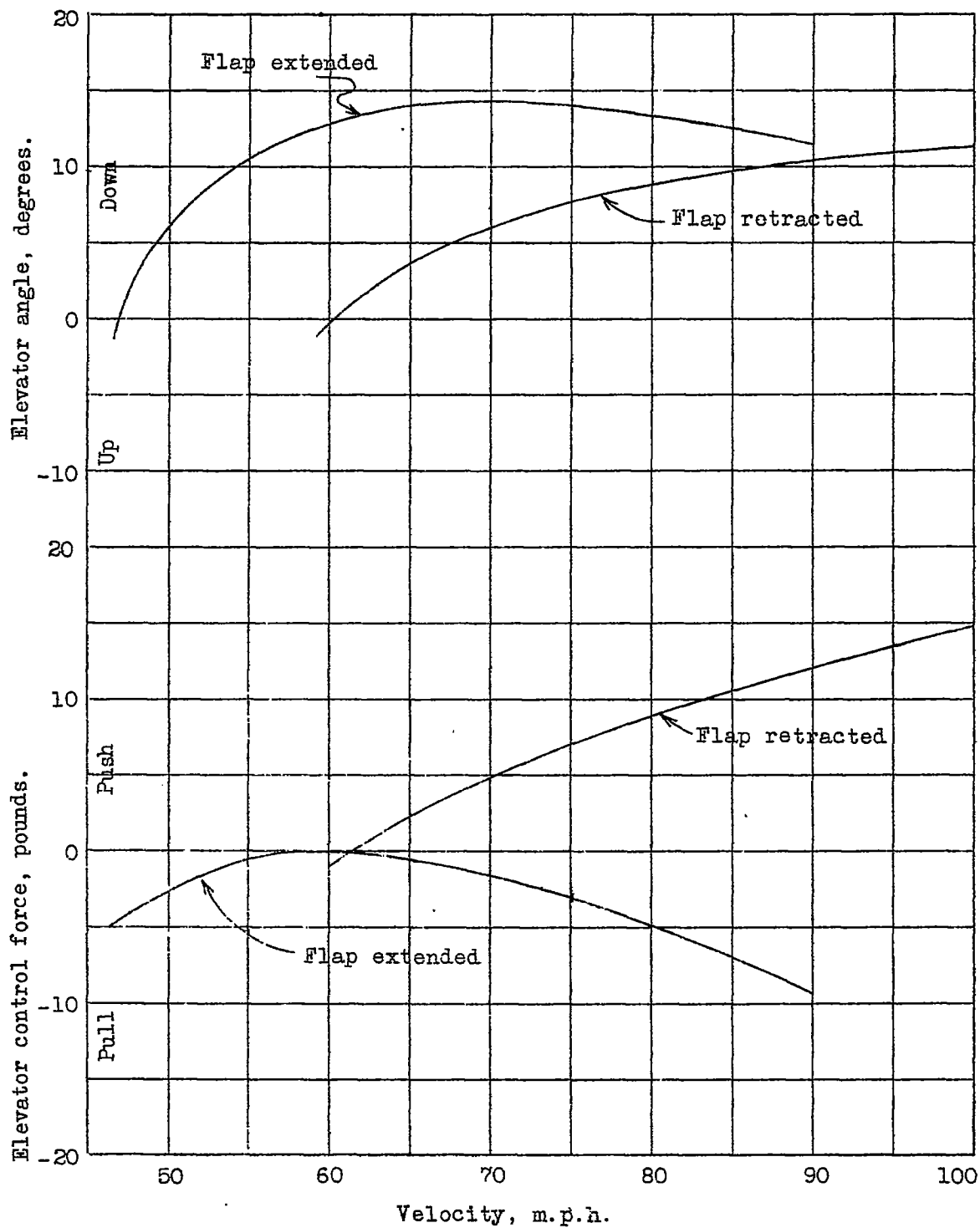

Figure 23.- Effect of Fowler flap on elevator angles and stick forces. Power-off. Stabilizer, full tail heavy.

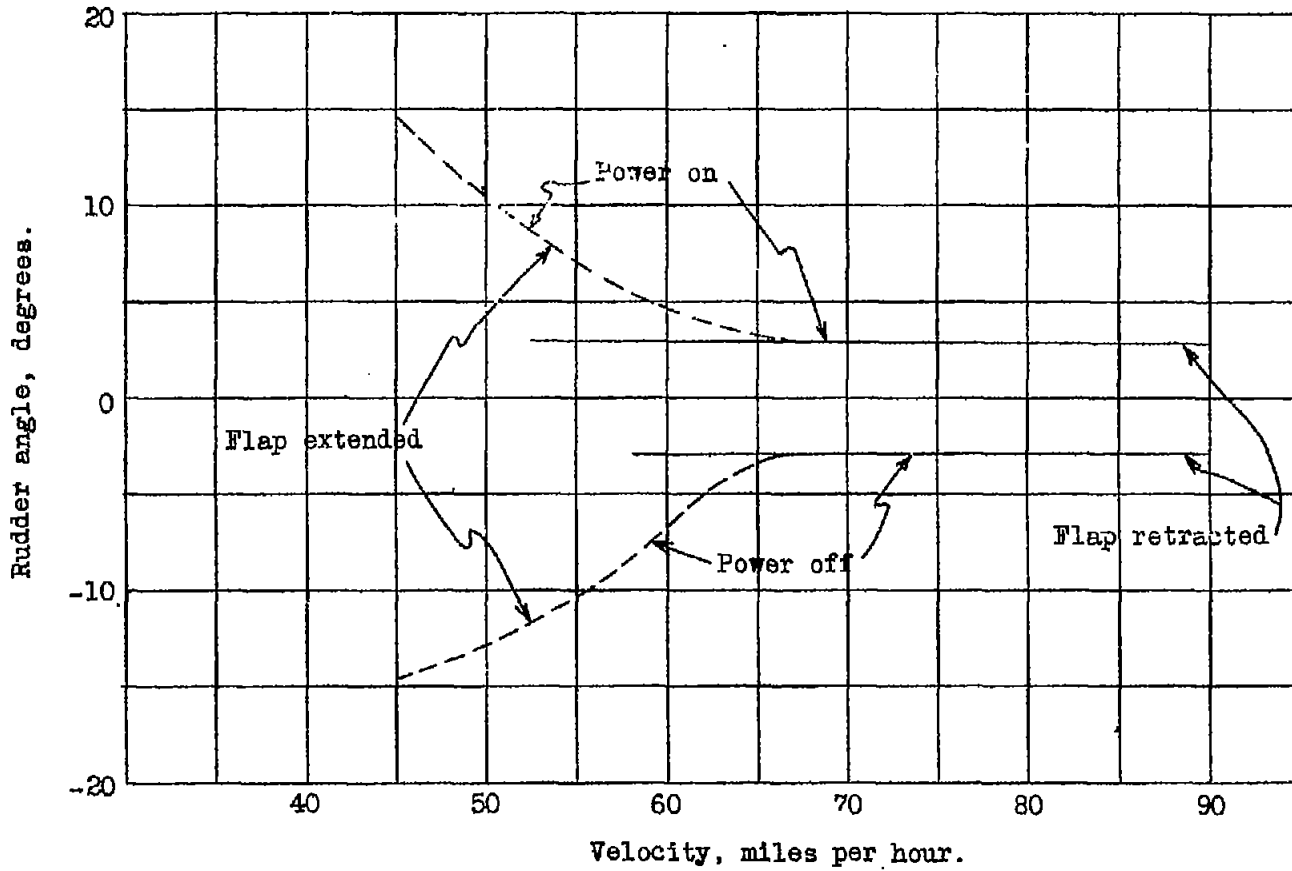

Figure 24.- Effect of Fowler flap on rudder position for straight flight.
Corrected for unsymmetrical rigging.

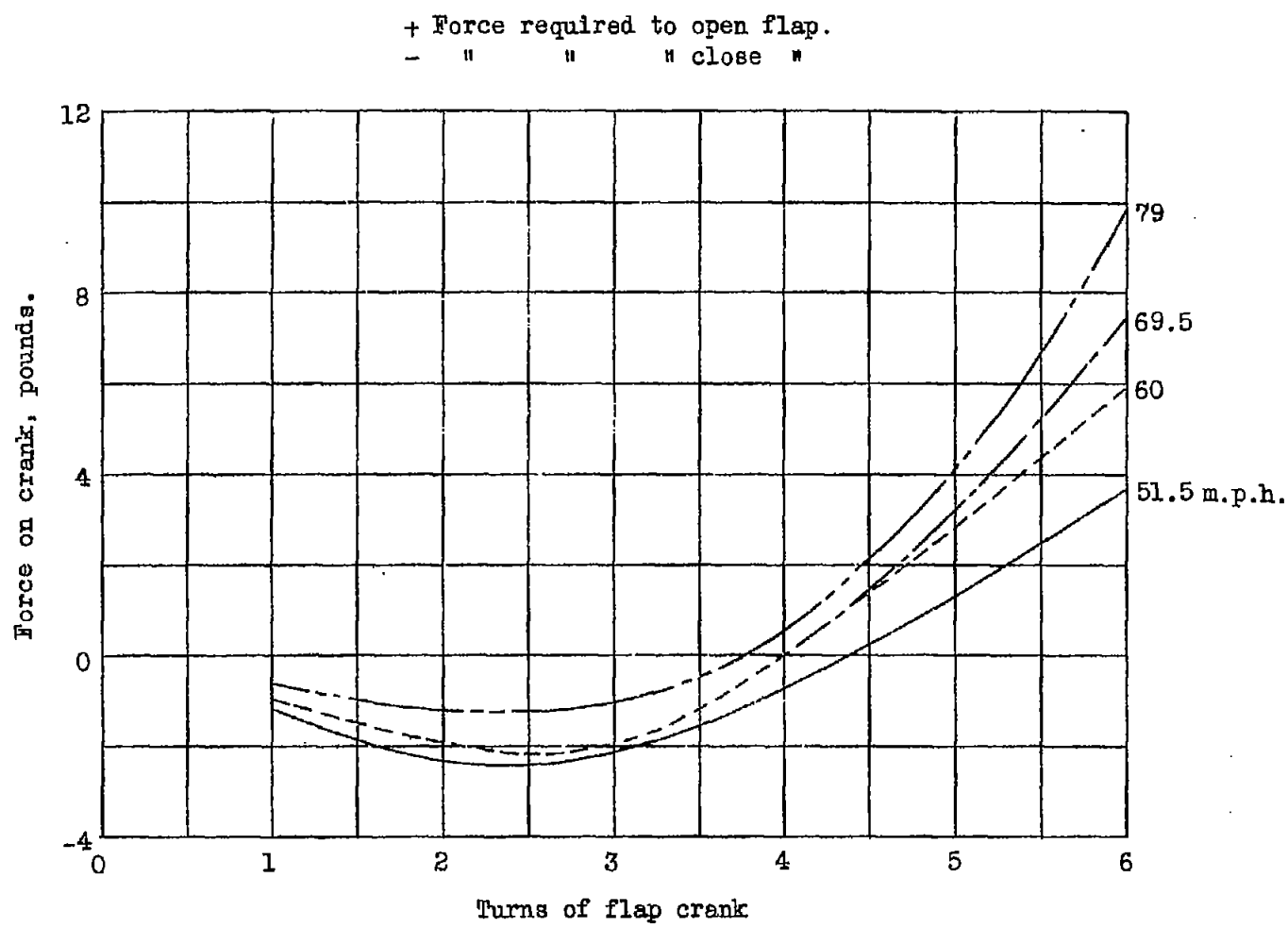

Figure 25.- Force required to operate Fowler flap.