

for Aeronautics
MAILED
SEP 23 1938

THIS DOCUMENT PROVIDED BY THE ABBOTT AEROSPACE
TECHNICAL LIBRARY
ABBOTTAEROSPACE.COM

To: *Library L.M.A.L.*

TECHNICAL NOTES

NATIONAL ADVISORY COMMITTEE FOR AERONAUTICS

No. 664

FREE-SPINNING WIND-TUNNEL TESTS OF A LOW-WING MONOPLANE

WITH SYSTEMATIC CHANGES IN WINGS AND TAILS

III. MASS DISTRIBUTED ALONG THE WINGS

By Oscar Seidman and A. I. Neihouse
Langley Memorial Aeronautical Laboratory

Washington
September 1938

NATIONAL ADVISORY COMMITTEE FOR AERONAUTICS

TECHNICAL NOTE NO. 664

FREE-SPINNING WIND-TUNNEL TESTS OF A LOW-WING MONOPLANE
WITH SYSTEMATIC CHANGES IN WINGS AND TAILS

III. MASS DISTRIBUTED ALONG THE WINGS

By Oscar Seidman and A. I. Neihouse

SUMMARY

Eight wings and three tails, covering a wide range of aerodynamic characteristics, were independently ballasted so as to be interchangeable with no change in mass distribution. For each of the 24 resulting wing-tail combinations, observations were made of the steady spin for four control settings and of recoveries for five control manipulations, the results being presented in the form of charts comparing the spin characteristics. The tests are part of a general investigation that is being made in the N.A.C.A. free-spinning tunnel to determine the effects of systematic changes in wing and tail arrangement upon the steady-spinning and the recovery characteristics of a conventional low-wing monoplane for various loading conditions.

The present loading was derived from the basic loading condition (representative of an average of values for 21 American airplanes for which the moments of inertia were available) by moving weight from the center of gravity toward the wing tips so that the distribution of mass along the wings was increased.

For the tail with deepened fuselage, raised stabilizer, and full-length rudder, recovery was satisfactory and the results were similar to those reported for the basic-loading condition. For the tail with deepened fuselage, raised stabilizer, and short rudder, an adverse effect resulted as compared with the basic-loading results for the wings with Army tips and N.A.C.A. 23012 or N.A.C.A. 6718 section and for the wing with flaps. For the more nearly conventional tail, an adverse effect resulted for the wing with Army tips and N.A.C.A. 23012 section, both with and without flaps. For the wing with N.A.C.A. 0009 section and for the Army standard wing, this loading appeared to have a somewhat favorable effect.

INTRODUCTION

The N.A.C.A. has undertaken a systematic investigation in the free-spinning wind tunnel to determine, by major independent variations, which of the dimensional and the mass characteristics of an airplane most greatly affect the spin (reference 1).

The results of tests of eight wings and three tails for a basic loading condition, representative of an average of values for 21 American airplanes for which the moments of inertia were available, have been reported in reference 1. In reference 2 were presented the results for the loading obtained by moving weight from the wing tips toward the center of gravity, the model thereby having its mass distributed chiefly along the fuselage. The present paper contains the results of a similar series of tests for a loading obtained by moving weight from the center of gravity toward the wing tips, the model thereby having its mass distributed chiefly along the wing.

The major wing variables include tip shape, airfoil section, plan form, and flaps. The Army standard tapered wing, also included in the test program, combines changes in plan form and thickness. The three tail arrangements range from a combination utilizing full-length rudder and raised stabilizer on a deep fuselage, designed to be extremely efficient in providing yawing moment for recovery, to a more nearly conventional type with the rudder completely above a shallow fuselage and badly shielded by the horizontal surfaces. The present results are compared with the results obtained for the basic loading condition.

APPARATUS AND METHODS

A general description of model construction and testing technique in the N.A.C.A. free-spinning tunnel is given in reference 3.

The models are constructed of balsa, reinforced with spruce and bamboo. In order to reduce the weight, the fuselage and the wings are hollowed out, the external contours being maintained by silk tissue paper on reinforcing ribs. The desired loading is attained by suitable distribution of lead weights.

Figures 1 to 5 show special structural features of the model used in the present investigation. The wing and tail units are independently removable and interchangeable to permit testing any combination. The exchange of units can be made without any change in mass distribution. A clockwork delay-action mechanism is installed to actuate the controls for recovery, simulating the rapid motions that would be imparted by a pilot.

The model was not scaled from any particular airplane but was designed to be a representative low-wing cabin monoplane with a cowled radial engine and with landing gear retracted. Dimensional characteristics of the model and of the eight wings and the three tails are given on the line drawings of figures 1, 2, and 3. The present model loading condition was derived from the basic condition (reference 1) by removing weight from the center of gravity and installing it in the wing tips. For convenience in making comparisons, the model may be considered a 1/15-scale model of either a fighter or a four-place cabin airplane, tested at an altitude of 6,000 feet. The full-scale characteristics for the present loading and for tail C would be:

Weight (W) - - - - -	4,720 lb.
Mean chord (c) - - - - -	75 in.
Span (b) - - - - -	37.5 ft.
Wing area (S) - - - - -	234.4 sq. ft.
Aspect ratio - - - - -	6
Distance from c.g. to elevator hinge - - - - -	16.6 ft.
Distance from c.g. to rudder hinge - - - - -	16.9 ft.
Fin area - - - - -	6.8 sq. ft.
Rudder area - - - - -	6.9 sq. ft.
Stabilizer area - - - - -	19.8 sq. ft.
Elevator area - - - - -	12.9 sq. ft.
Control travel - - - - -	Rudder: $\pm 30^\circ$ Elevator: 30° up 20° down

Principal moments of inertia:

$$A = mk_x^2 \text{ --- -- -- -- -- } 4,150 \text{ slug-ft.}^2$$

$$B = mk_y^2 \text{ --- -- -- -- -- } 3,970 \text{ slug-ft.}^2$$

$$C = mk_z^2 \text{ --- -- -- -- -- } 7,540 \text{ slug-ft.}^2$$

The nondimensional mass-distribution parameters (described in reference 4) for the present loading condition are:

$$\mu = \frac{W}{g\rho S b} = 7$$

$$\frac{Wb^2}{g(C-A)} = 61$$

$$\frac{C-B}{C-A} = 1.10$$

$$\frac{b}{k_x} = 7.08$$

$$\frac{x}{c} = 0.25$$

$$\frac{z}{c} = 0$$

The quantity x/c is the ratio of the distance of the center of gravity back of the loading edge of the mean chord to the mean chord; and z/c is the ratio of the distance of the center of gravity below the thrust line to the mean chord.

Figures 1 and 4 show the model with the basic wing (wing 1) and tail C installed. This wing is of N.A.C.A. 23012 section with rectangular plan form and Army tips. (The tip contour is derived as described in reference 5.) In common with the other wings, it has an area of 150 square inches, a span of 30 inches, and no dihedral, twist, or sweepback.

The seven remaining wings (figs. 2 and 5) have varied dimensional characteristics as follows:

- Wing 2: N.A.C.A. 23012 section, rectangular with Army tips, 20 percent split flaps deflected 60° .
- Wing 3: N.A.C.A. 23012 section, rectangular with rectangular tips.
- Wing 4: N.A.C.A. 23012 section, rectangular with faired tips.
- Wing 5: N.A.C.A. 0009 section, rectangular with Army tips.
- Wing 6: N.A.C.A. 6718 section, rectangular with Army tips.
- Wing 7: N.A.C.A. 23012 section, 5:2 taper with Army tips.
- Wing 8: N.A.C.A. 23018-09 section, Army standard plan form (square center section, 2:1 taper in both plan form and thickness, and Army tips).

Each wing was mounted on the model at an angle of incidence equal to its angle of zero lift. The stabilizer of the model was at zero incidence for each tail. There was no fin offset.

The three tails designated A, B, and C are shown in figures 3 and 5. Tail C, representing a conventional shallow fuselage with rudder completely above the tail cone, has the following dimensional characteristics:

Vertical tail area: 6 percent wing area (3 percent rudder and 3 percent fin).

Fuselage side area, back of leading edge of stabilizer:
2 percent wing area.

Vertical tail length (from quarter-chord point to rudder hinge axis): 45 percent wing span.

Horizontal tail area: 14 percent wing area (5.5 percent elevator and 8.5 percent stabilizer).

Horizontal tail length (from quarter-chord point to elevator hinge axis): 44 percent wing span.

Tail B was derived from tail Q by increasing the fuselage depth, raising the stabilizer and the elevators, and installing approximately the original fin and rudder atop the deepened fuselage. For tail B, the vertical areas are:

Vertical tail area: 6 percent wing area.

Fuselage side area: 5.5 percent wing area.

Tail A was similar to tail B except for full-length rudder construction and slightly increased elevator cut-out. For tail A, the vertical areas are:

Vertical tail area: 8 percent wing area (5 percent rudder and 3 percent fin).

Fuselage side area: 3.4 percent wing area.

TESTS AND RESULTS

For each wing and tail combination, spin tests were made for four control settings:

- (a) Rudder 30° with the spin and elevators neutral.
- (b) Rudder 30° with the spin and elevators 20° down.
- (c) Rudder 30° with the spin and elevators 30° up.
- (d) Rudder neutral and elevators neutral.

Recovery from (a) and (b) was attempted by reversal of the rudder, from (c) by complete reversal of both controls and also by neutralizing both controls, and from (d) by moving both controls to full against the spin. All tests were for right spins.

The angle of attack α , angle of sideslip β (positive inward in a right spin), turns for recovery, spin coefficient $\Omega b/2V$, and rate of descent $-V$, are plotted in 12 charts (figs. 6 to 17), grouped so as to permit ready comparison of the effects of tip shape, section, plan form, flaps, and the Army standard wing.

The data on these charts are believed to represent the true model values within the following limits (see reference 3):

α - - - - -	$\pm 3^\circ$
β - - - - -	$\pm 1-1/2^\circ$
Turns for recovery - - - - -	$\pm 1/4$ turn
$\Omega b/2V$ - - - - -	± 3 percent
V - - - - -	± 2 percent

For certain spins in which it is difficult to control the spin in the tunnel, owing to high air speed or wandering motion, the foregoing limits may be exceeded.

As noted in references 3 and 4, there may in some instances be variations between model spin-test results and corresponding full-scale spin-test results of a given airplane, probably because of the difference of the Reynolds Number between the tests.

DISCUSSION

Tests with tail A (figs. 6 to 9).— In figure 6, results are shown for different wings with tail A for rudder 30° with the spin and elevators neutral. It may be seen that the rectangular wings with rectangular or faired tips (wings 3 and 4) gave the steepest spins ($\alpha = 45^\circ$ compared with 62° for the flattest) and the most rapid recoveries (1-1/2 turns); whereas, the wing with 5:2 taper (wing 7) and the wing with flaps deflected (wing 2) gave the slowest recoveries (about four turns).

With elevators 20° down (fig. 7) the spins were, in general, a few degrees steeper and recoveries were slightly more rapid than with elevators neutral. Elevators up (fig. 8) tended further to steepen the spins. The wings with N.A.C.A. 0009 and 6718 sections, however, spun slightly flatter with elevators up than with elevators full down; and the rectangular wings with rectangular or faired tips would spin with elevators up, whereas they would not spin with elevators down. In all cases, recoveries were rapid (less than two turns) by complete reversal of both controls. When the controls were moved only to neutral, the recoveries were generally slower. The recorded turns for recovery for wings 1 and 7 varied from three to infinity for different runs. With controls neutral (fig. 9), spins could be

obtained for the rectangular wings with Army tips of N.A.C.A. 23012 section, with and without flaps, and of N.A.C.A. 6718 section, and also for the wing of 5:2 taper (wings 1, 2, 6, and 7, respectively).

For all the control settings, the rectangular wings with rectangular or faired tips gave the steepest spins and the quickest recoveries. There was a small effect of section, the wing of N.A.C.A. 0009 section giving more outward sideslip and faster recovery than wings of the other two sections. The wing of N.A.C.A. 6718 section gave the least outward sideslip. Recovery for the wing with flaps and for the wing of 5:2 taper was slower than for the other wings. The Army standard wing gave steeper spins and faster recoveries than the basic wing (wing 1).

For tail A, the results for this loading as compared with those for the basic loading (reference 1) showed only small differences. For all control settings, there was a tendency for the rectangular wing of N.A.C.A. 0009 section with Army tips (wing 5) and the standard Army wing of N.A.C.A. 23018-09 section (wing 8) to give steeper spins and for the rectangular wing of N.A.C.A. 23012 section with 20 percent full-span split flaps deflected 60° (wing 2), the rectangular wing of N.A.C.A. 6718 section with Army tips (wing 6), and the 5:2 taper wing of N.A.C.A. 23012 section with Army tips (wing 7) to give flatter spins than were obtained for the basic-loading condition.

Tests with tail B (figs. 10 to 13).— Figure 10, which gives results for various wings with tail B for rudder with the spin and elevators neutral, shows steeper spins for all wings as compared with tail A, but recoveries for wings 1, 2, 6, and 7 were unsatisfactory with tail B. This result shows the importance of unshielded rudder area in effecting satisfactory recovery characteristics. As with tail A, the rectangular wings with rectangular or faired tips gave the steepest spins. Wing 1 showed a wide variation in the turns for recovery.

With elevators 20° down (fig. 11), there was little difference in the steady spin as compared with elevators neutral but recovery was, in general, slightly more rapid; wing 6 showed a wide range in recovery turns. With elevators up (fig. 12), the spin was steepened and recoveries by complete reversal of both controls were satisfactory for all wings. When both controls were merely neutralized, wing 6 again exhibited a large variation in turns required.

With both controls neutral (fig. 13), spins could be obtained only for wings 1, 2, 6, and 7. Moving the controls against the spin gave slow recoveries. It is interesting to note that the steady spins with tail B for controls neutral were very similar to the corresponding spins with tail A but that recoveries with tail B were definitely slower.

For all control settings, the roctangular wing with rectangular or faired tips gave the steepest spins and it is believed that recoveries with it would have been most rapid; the rectangular wing of N.A.C.A. 0009 section and Army tips showed steeper spins, faster recoveries, and more outward sideslip as compared with the rectangular wings of N.A.C.A. 23012 and N.A.C.A. 6718 sections with Army tips. The wing of N.A.C.A. 23012 section gave the flattest spins but the wing of N.A.C.A. 6718 section gave the least outward sideslip and the slowest recovery. Flaps retarded recovery. The 5:2 taper wing gave steeper spins than the basic wing and the standard Army wing gave steeper spins and more rapid recovery than the 5:2 taper wing.

For tail B, wings 1, 2, and 6 showed flatter spins and slower recoveries with this loading than with the basic loading. Wings 5 and 8 gave steeper spins for the present loading and the effect on wings 3 and 4 could not be determined.

Tests with tail C (figs. 14 to 17).— With tail C, as with tail B, the effects of differences in wing characteristics were more marked than with tail A. Figure 14 shows that, for rudder with the spin and elevators neutral, the rectangular wings with rectangular or faired tips still gave the steepest spins, the greatest outward sideslip, and the most rapid recovery. The wing of N.A.C.A. 0009 section and the Army wing gave slower recovery and the other wings gave no recovery.

With elevators down (fig. 15), the results were similar to those for elevators neutral. The wings that had given recovery by rudder reversal for elevators neutral now indicated more rapid recovery for elevators down. With elevators up (fig. 16), spins were somewhat steeper than for elevators neutral and recovery by complete reversal of both controls was satisfactory except for the rectangular wing of N.A.C.A. 23012 section with Army tips, which gave a recovery in 3-1/4 turns without flaps and gave no recov-

ery with flaps. With both controls neutral (fig. 17), results were very similar to those obtained for rudder with the spin and elevators down.

For all control settings, the rectangular wing with rectangular or faired tips gave steeper spins and more rapid recovery than the other wings. The wing of N.A.C.A. 0009 section gave steeper spins, more outward sideslip, and better recovery than the two comparable wings of which the N.A.C.A. 23012 gave the flattest spin and the N.A.C.A. 6718 gave the least outward sideslip. The 5:2 taper wing gave results generally similar to those for the basic wing. The wing with flaps gave no recovery by any control manipulation used. The Army wing gave steeper spins than the basic wing and gave recoveries for all control manipulation, whereas the basic wing gave recovery only for complete reversal of both controls.

With the present loading, the basic wing, the wing with flaps, and the wing of N.A.C.A. 6718 section tended to give slower recoveries as compared with the basic loading; the Army wing and the wing of N.A.C.A. 0009 section tended to give faster recoveries. The other wings showed little effect.

CONCLUSIONS

By analysis of the data presented, the general effects of wing or tail arrangement and of control position and the apparent relationships between spin characteristics may be determined for the loading condition of mass distributed along the wings.

Effects of wings:

1. Tip shape.— Rectangular and faired tips give the steepest spins and the most rapid recoveries. The Army tip gives consistently flatter spins and slower recoveries.

2. Section.— The wing of N.A.C.A. 0009 section gives the steepest spins and the most rapid recoveries and shows the greatest outward sideslip. The wing of N.A.C.A. 23012 section gives the flattest spins and the wing of N.A.C.A. 6718 section gives the least outward sideslip.

3. Flaps.-- Flaps tend to retard recovery.

4. Plan form.-- The wing of 5:2 taper gives more outward sideslip than the basic wing, but there is little difference in the turns for recovery.

5. Army standard wing.-- The Army 'standard wing gives somewhat steeper spins, faster recovery, and more outward sideslip than the basic wing.

Effects of tail arrangement:

1. The tail with raised stabilizer and elevators, increased fuselage depth, and full-length rudder (tail A) gives the most satisfactory recoveries. For rudder full with the spin, the tail with raised stabilizer and elevators, increased fuselage depth, and rudder completely above the fuselage (tail B) gives the steepest spins.

2. The tail with shallow fuselage and rudder completely above the tail cone (tail C) gives the slowest recoveries.

Effects of control setting:

1. Recoveries from spins with elevators down are somewhat more rapid than from spins with elevators neutral.

2. Holding the elevators up generally results in the steepest spins from which, by reversal of both controls, are obtained the most rapid recoveries.

Relationships between spin characteristics:

1. Steep spins are usually associated with high rate of descent, low $\Omega b/2V$, and rapid recovery.

2. In general, more rapid recovery is obtained from the spins with the greatest outward sideslip.

Comparison with results for basic loading:

1. The basic wing, the wing with flaps, and the wing of N.A.C.A. 6718 section show flatter spins and slower recoveries with this loading as compared with the basic loading. The wing of N.A.C.A. 0009 section and the Army standard wing give steeper spins and faster recoveries with the present loading. The remaining wings show no consistent effects.

2. With this loading, the spins with the greatest outward sideslip gave the fastest recoveries; whereas, for the basic loading, there appeared to be no relationship between the sideslip of the steady spin and turns required for recovery.

Langley Memorial Aeronautical Laboratory,
National Advisory Committee for Aeronautics,
Langley Field, Va., August 12, 1938.

REFERENCES

1. Seidman, Oscar, and Neihouse, A. I.: Free-Spinning Wind-Tunnel Tests of a Low-Wing Monoplane with Systematic Changes in Wings and Tails. I - Basic Loading Condition. T.N. No. 608, N.A.C.A., 1937.
2. Seidman, Oscar, and Neihouse, A. I.: Free-Spinning Wind-Tunnel Tests of a Low-Wing Monoplane with Systematic Changes in Wings and Tails. II - Mass Distributed Along the Fuselage. T.N. No. 630, N.A.C.A., 1937.
3. Zimmerman, C. E.: Preliminary Tests in the N.A.C.A. Free-Spinning Wind Tunnel. T.R. No. 557, N.A.C.A., 1936.
4. Bamber, M. J., and House, R. O.: Spinning Characteristics of the XN2Y-1 Airplane Obtained from the Spinning Balance and Compared with Results from the Spinning Tunnel and from Flight Tests. T.R. No. 607, N.A.C.A., 1937.
5. Shortall, Joseph A.: Effect of Tip Shape and Dihedral on Lateral-Stability Characteristics. T.R. No. 548; N.A.C.A., 1935.

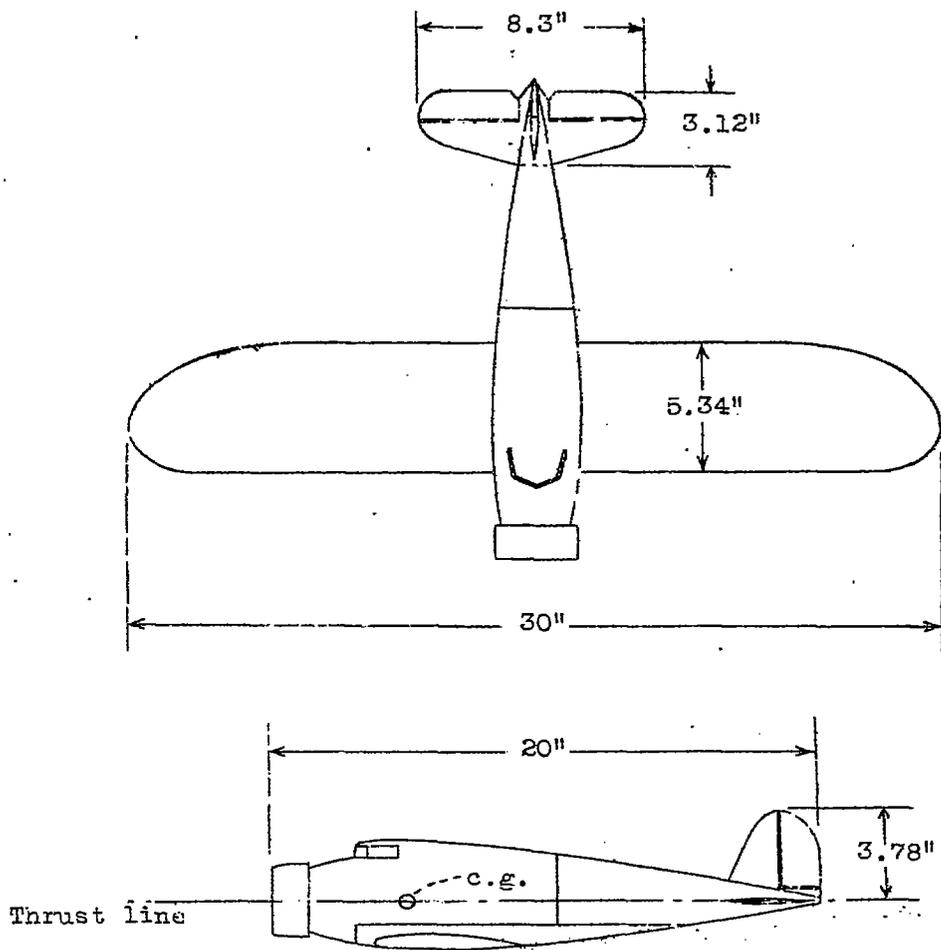

Figure 1.- Low-wing monoplane model with detachable tail and wing.

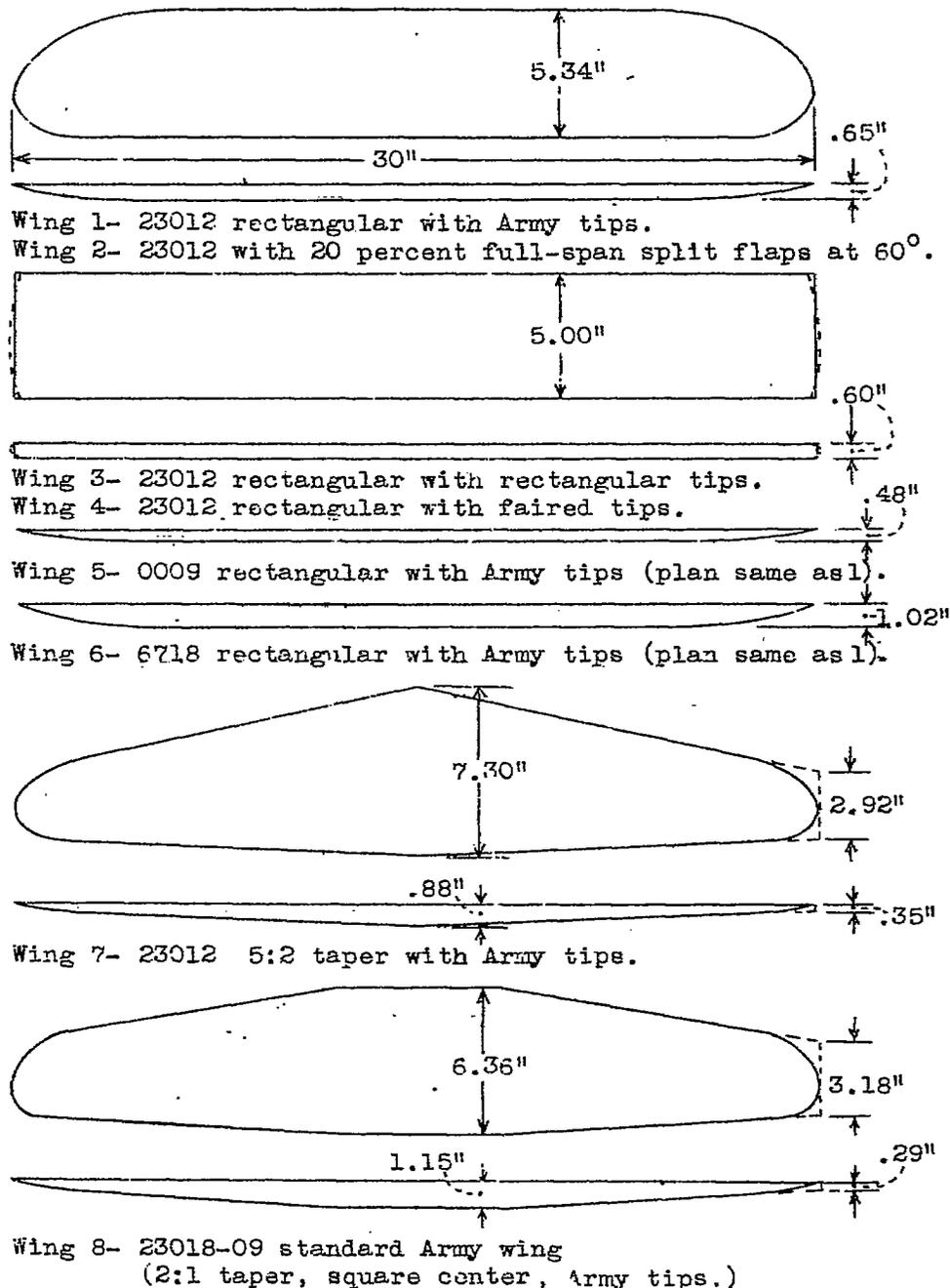

Figure 2.- Wings used on low-wing monoplane.
 N.A.C.A. wing sections.

T.L. , thrust line

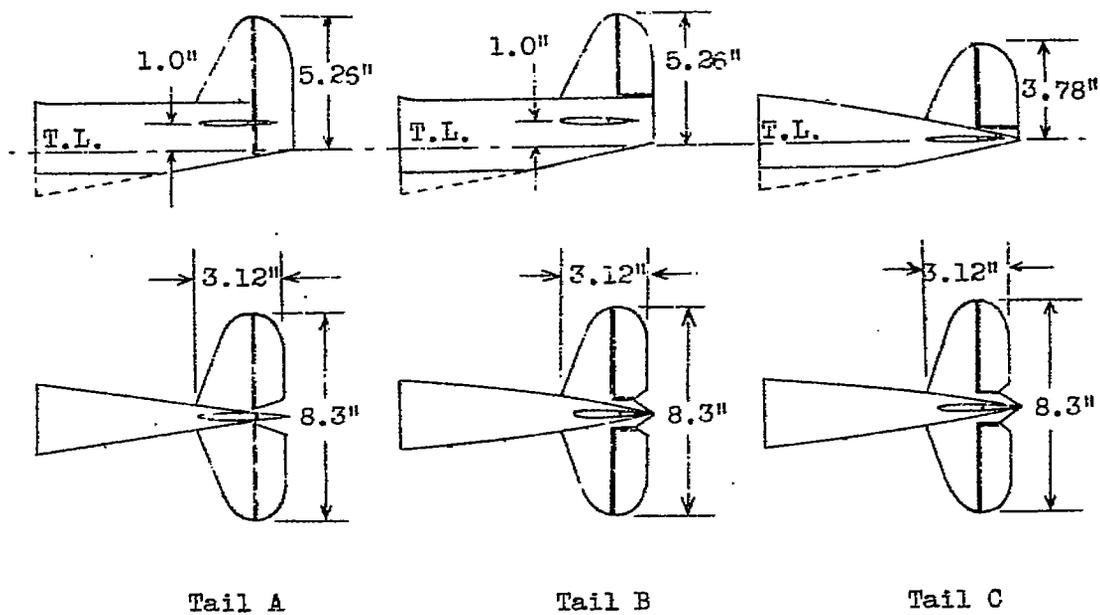
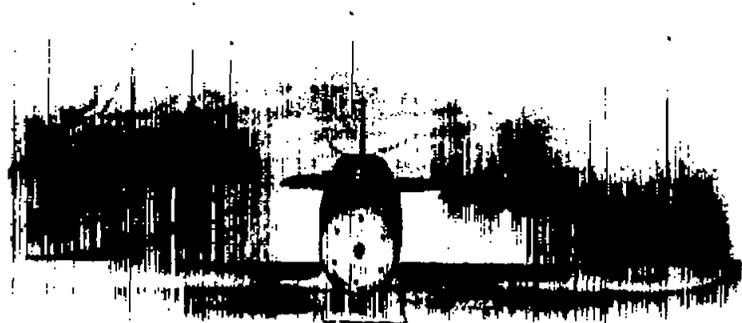
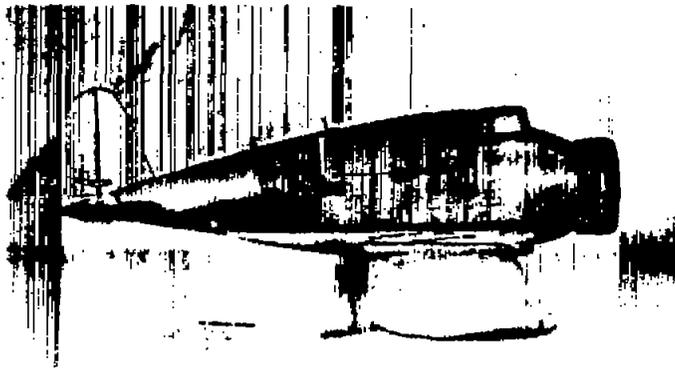

Figure 3.- Tails used on low-wing monoplane.



(a) Front view.



(c) Side view, showing detachable parts.

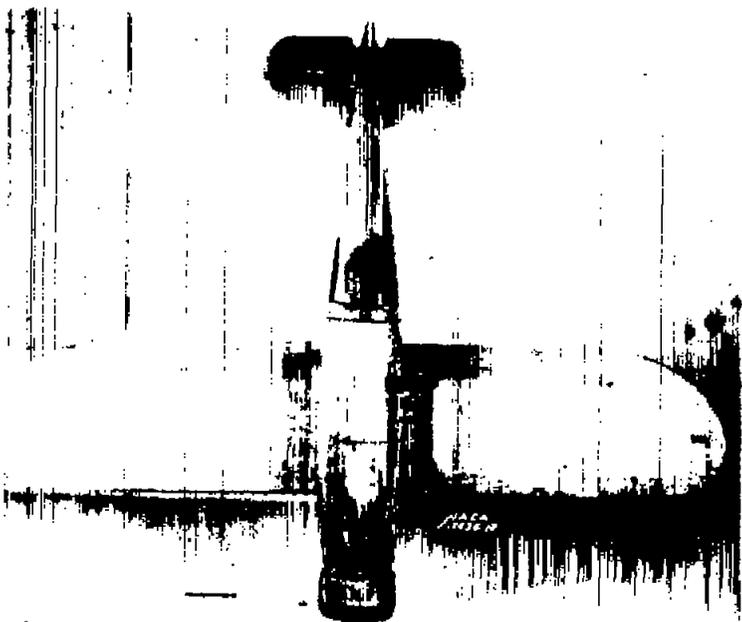

(b) Plan view.

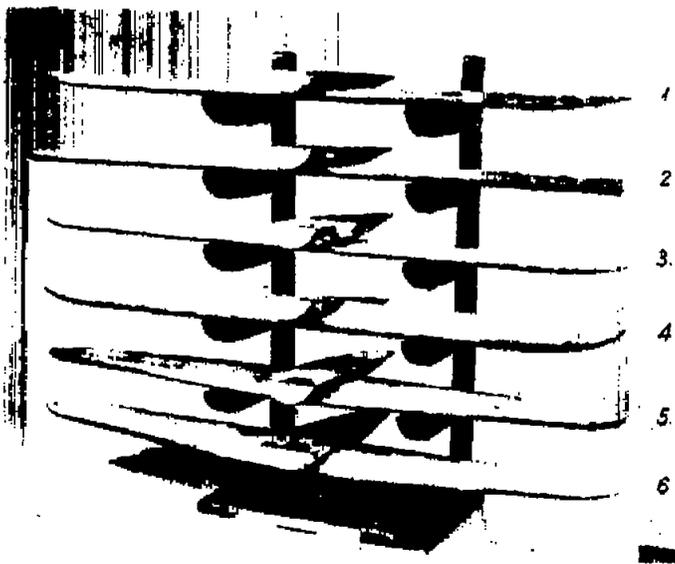

(1) Wings 1 and 2, (2) Wings 3 and 4, (3) Wing 5,
(4) Wing 6, (5) Wing 7 (6) Wing 8.
(d) Low-wing monoplane wings.

Figure 4. - Low-wing monoplane model.

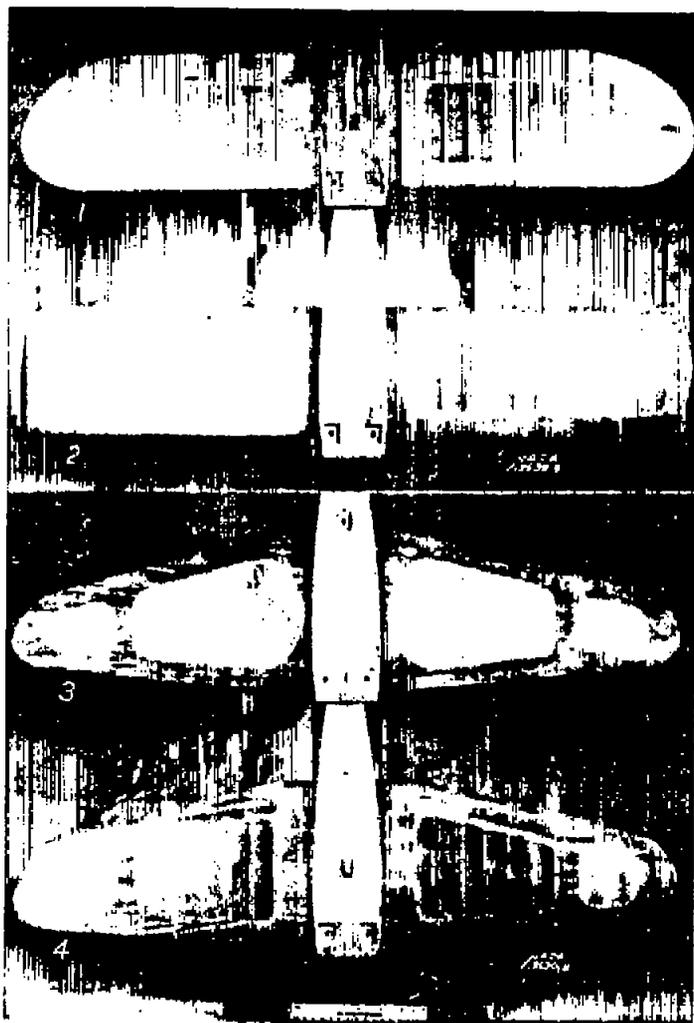

- (a) (1) Rectangular wing with Army tips. (2) Rectangular wing with interchangeable rectangular and faired tips.
(3) 5:2 tapered wing with Army tips. (4) 2:1 Army standard tapered wing with square center.

- (b) (1) Tail A, deep fuselage and long rudder.
(2) Tail B, deep fuselage and short rudder.
(3) Tail C, shallow fuselage and short rudder.

Figure 5.- Interchangeable wings and tails of low-wing monoplane model.

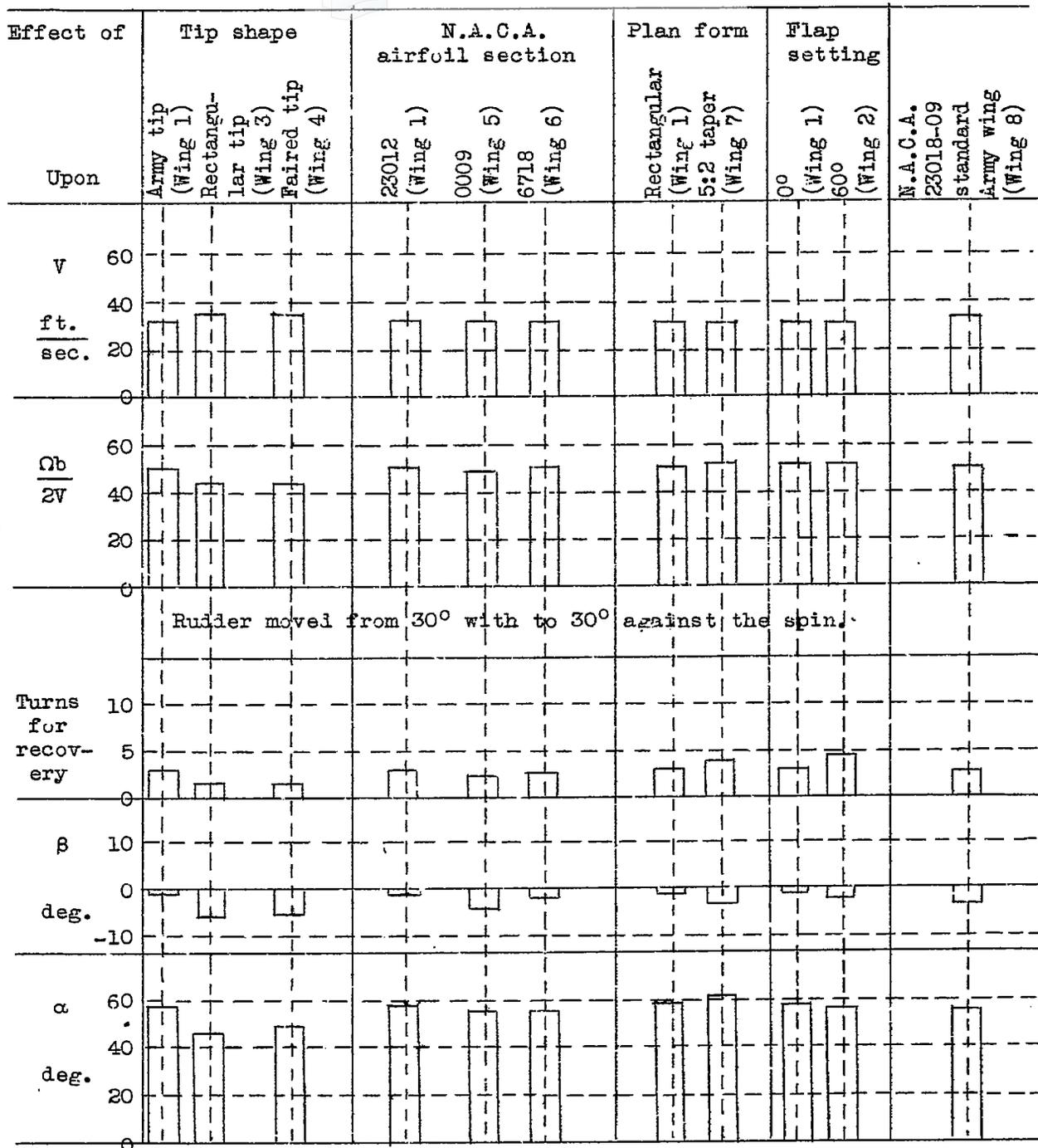

Figure 6.- The effect of various wings on the spin characteristics. (Wing has rectangular plan form, Army tips, N.A.C.A. 23012 section, except as noted.) Mass distributed along the wing. Tail A; Rudder 30° with; Elevators 0°; Ailerons 0°.

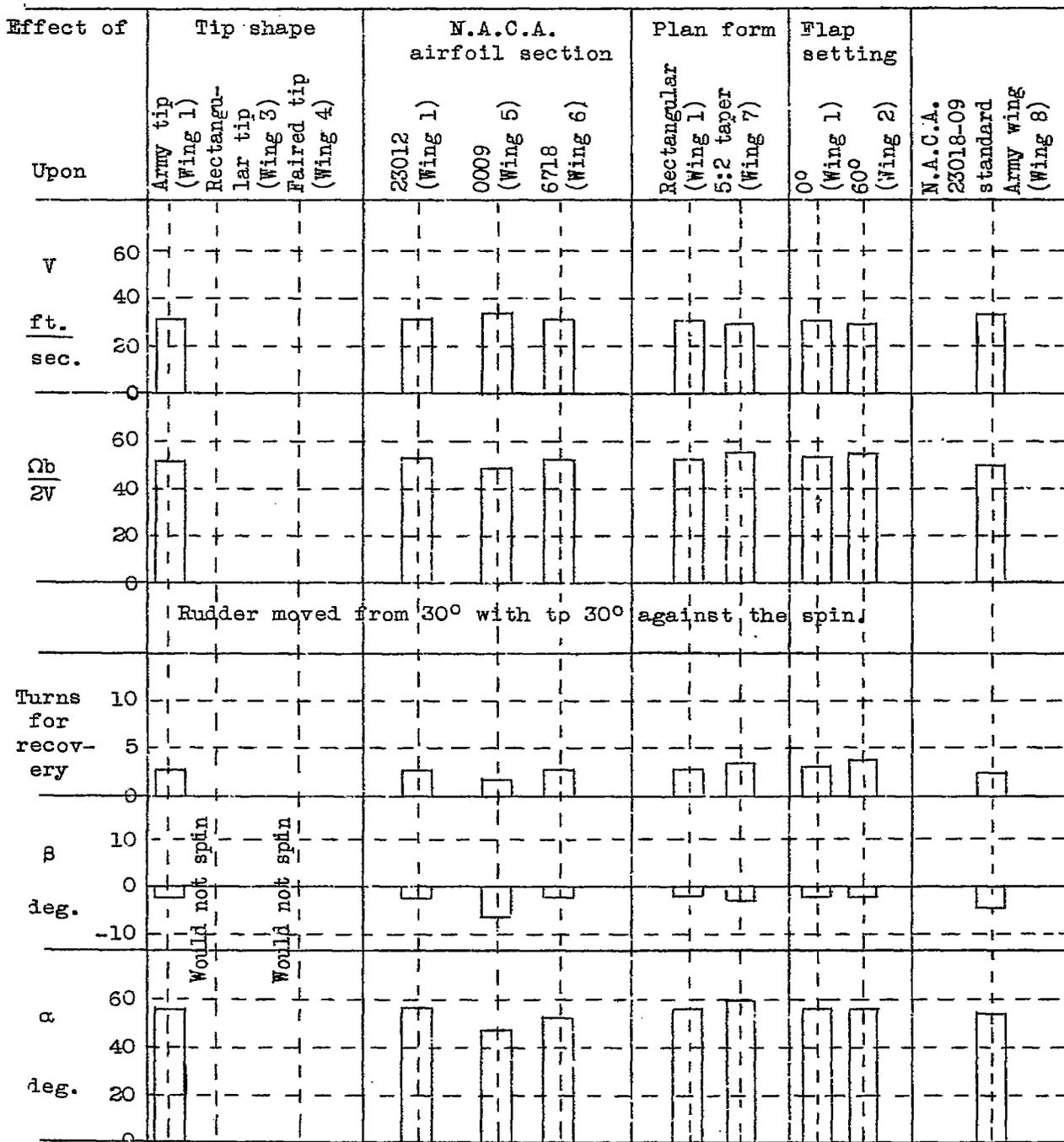

Figure 7.- The effect of various wings on the spin characteristics. (Wing has rectangular plan form, Army tips, N.A.C.A. 23012 section, except as noted.) Mass distribution along the wing. Tail A; Rudder 30° with; Elevators 20° down; ailerons 0°.

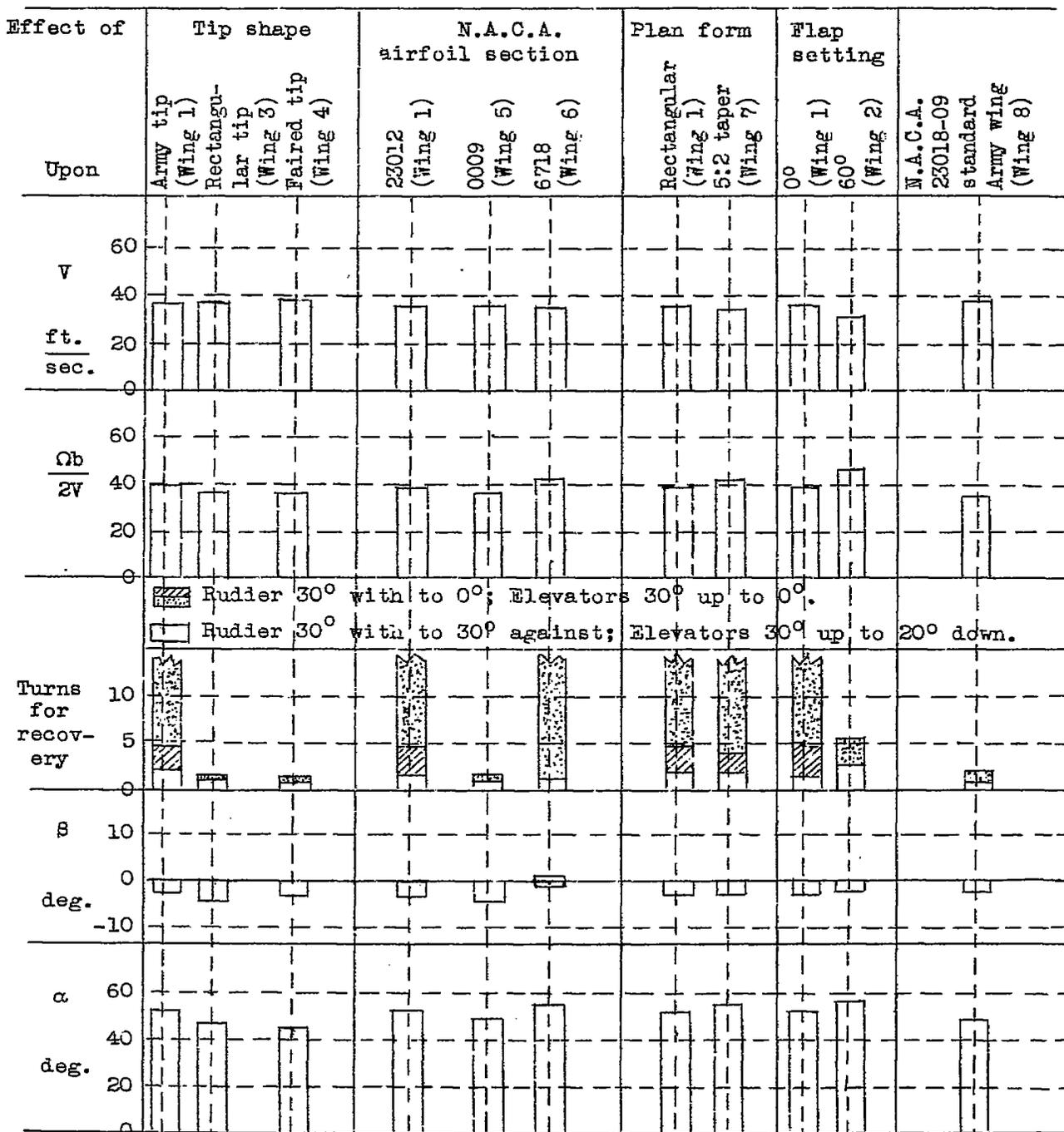

Figure 8.- The effect of various wings on the spin characteristics. (Wing has rectangular plan form, Army tips, N.A.C.A. 23012 section, except as noted.) Mass distributed along the wing. Tail A; Rudder 30° with; Elevators 30° up; Ailerons 0°.

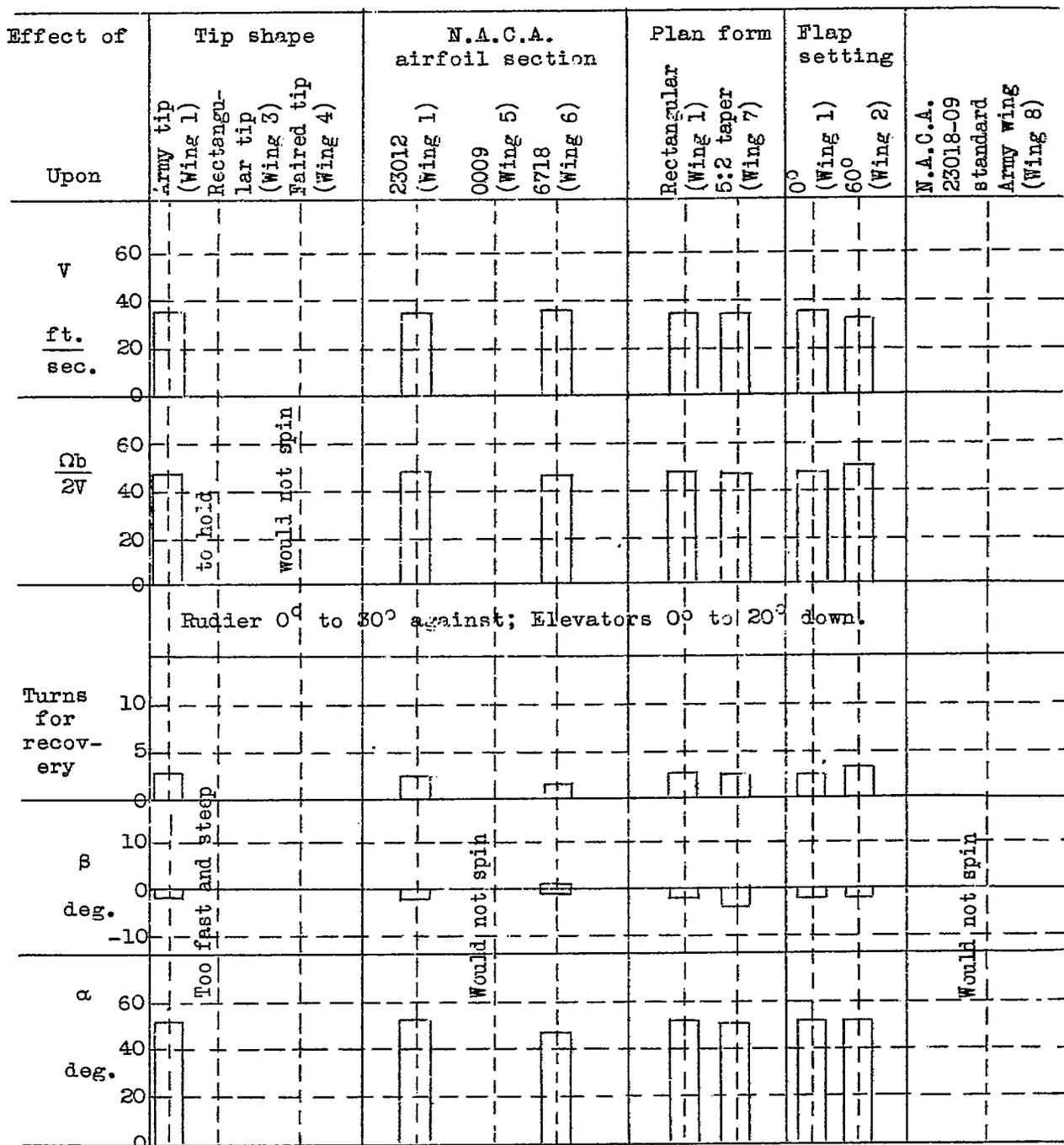

Figure 9.- The effect of various wings on the spin characteristics. (Wing has rectangular plan form, Army tips, N.A.C.A. 23012 section, except as noted.) Mass distributed along the wing. Tail A; Rudder 0°; Elevators 0°; Ailerons 0°.

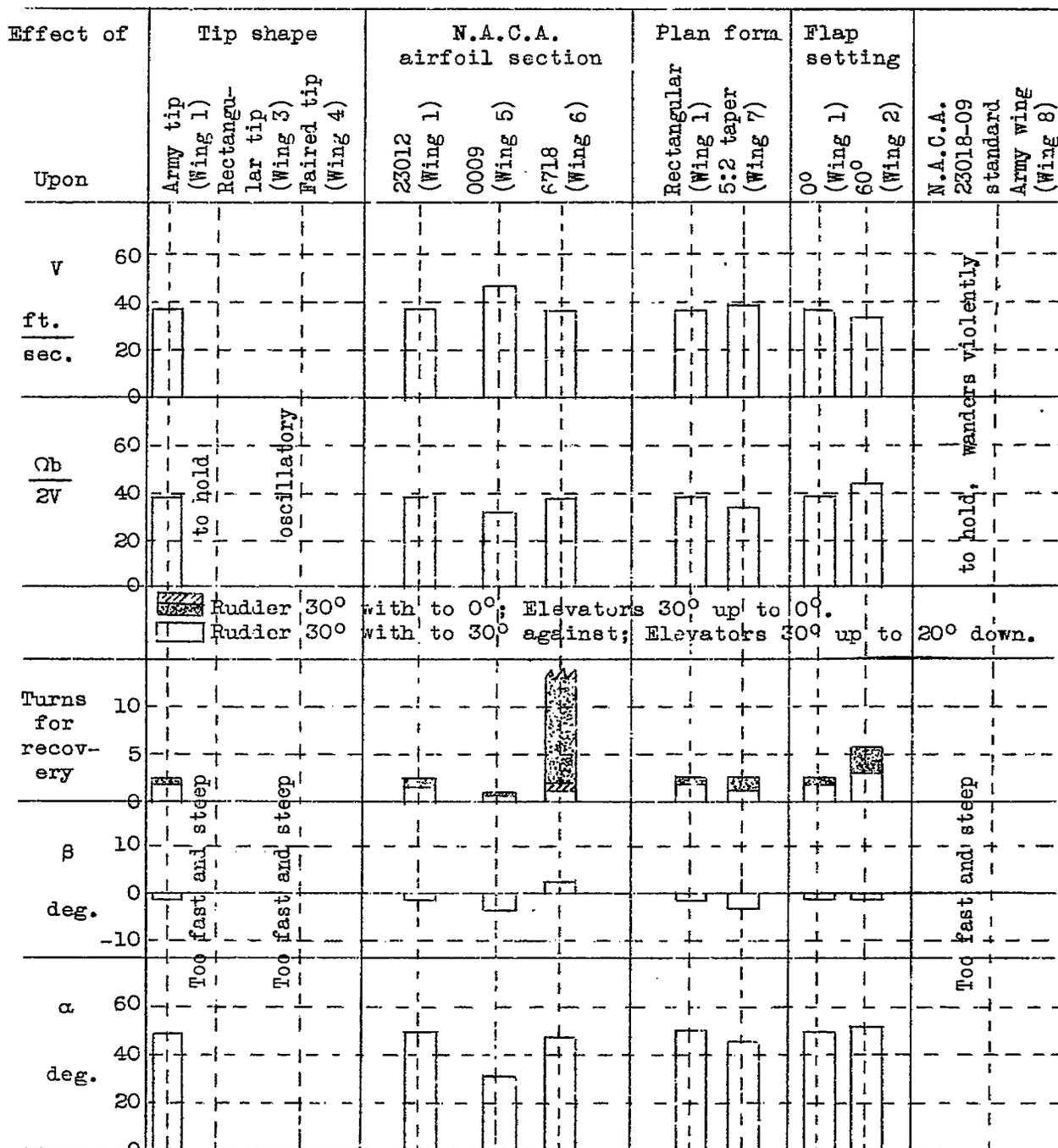

Figure 12.- The effect of various wings on the spin characteristics. (Wing has rectangular plan form, Army tips, N.A.C.A. 23012 section, except as noted.) Mass distributed along the wing. Tail B; Rudder 30°; Elevators 30° up; Ailerons 0°.

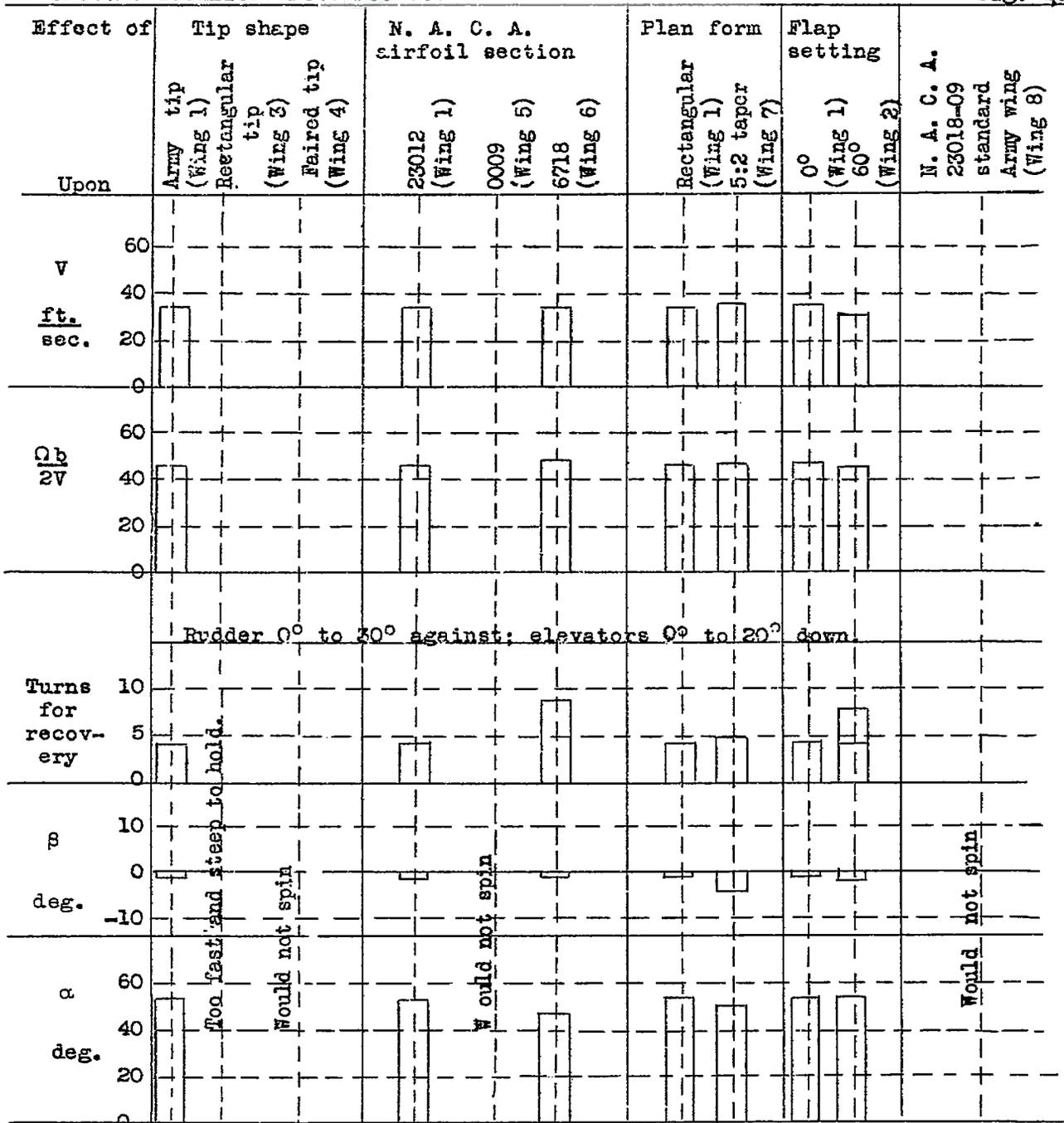

Figure 13.- The effect of various wings on the spin characteristics. (Wing has rectangular plan form, Army tips, N. A. C. A. 23012 section, except as noted.) Mass distributed along the wing. Tail B: Rudder 0°; Elevators 0°; Ailerons 0°.

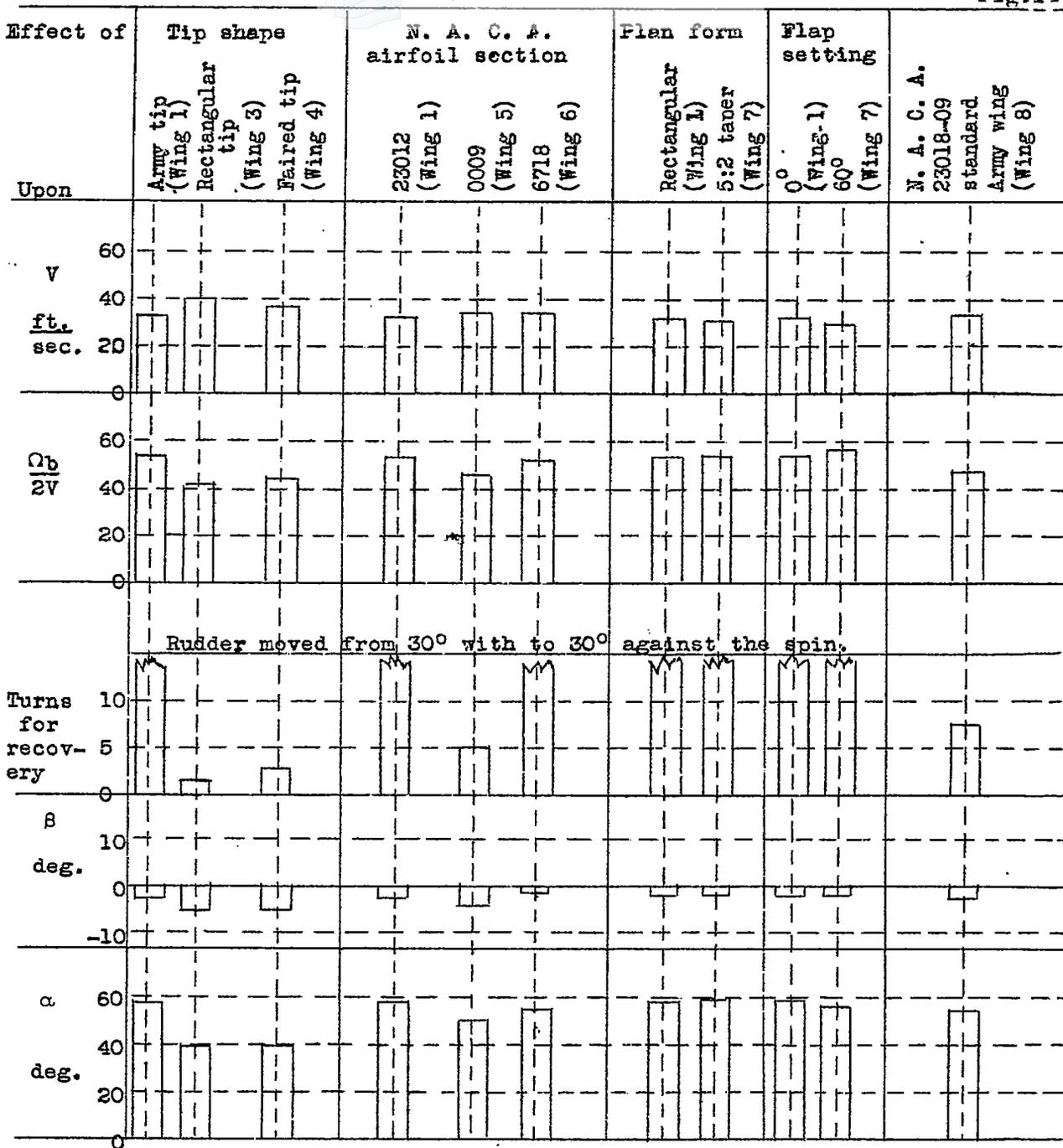

Figure 14.- The effect of various wings on the spin characteristics. (Wing has rectangular plan form, Army tips, N. A. C. A. 23012 section, except as noted.) Mass distributed along the wing. Tail C; Rudder 30° with; Elevators 0°; Ailerons 0°.

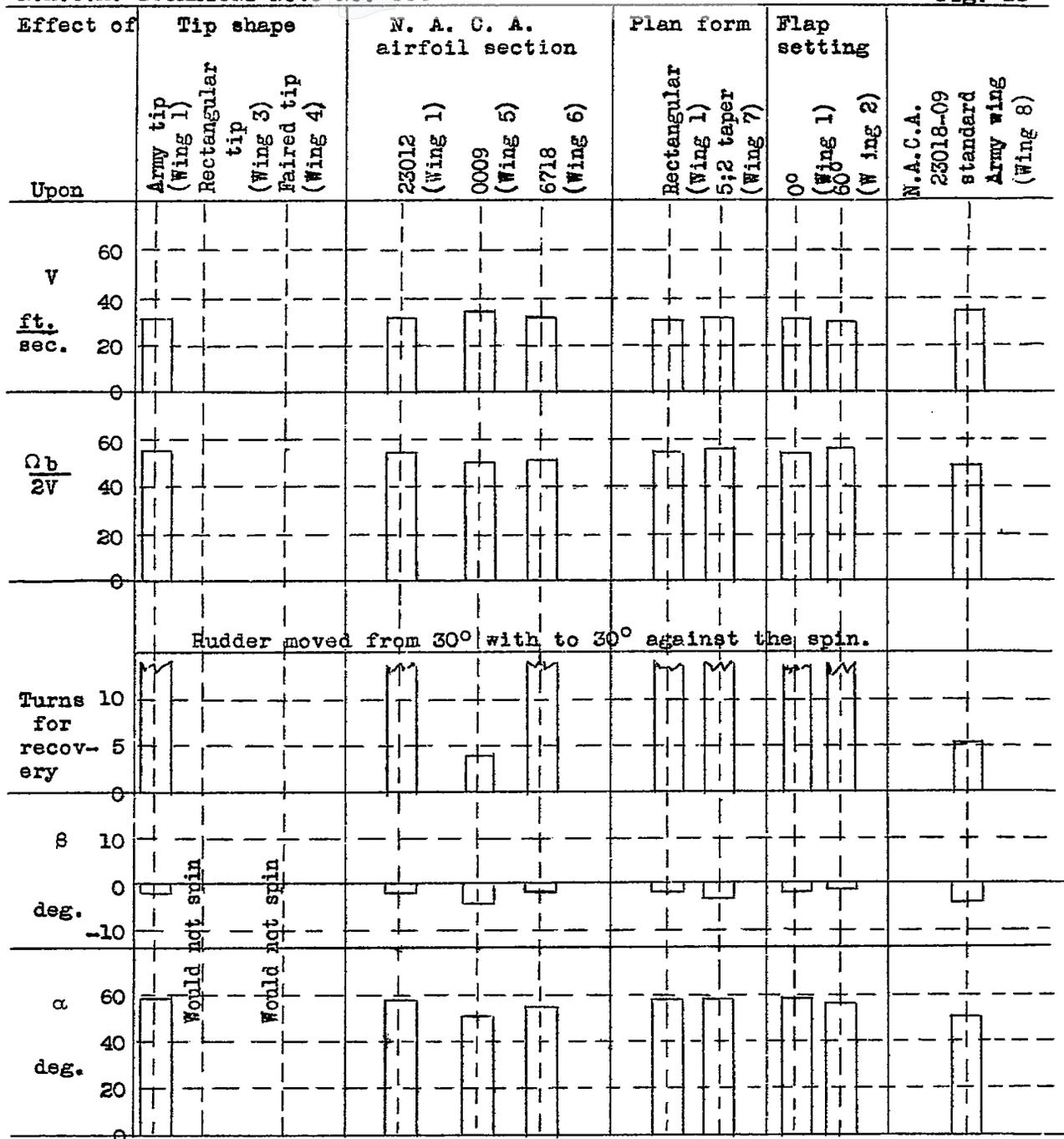

Figure 15.-- The effect of various wings on the spin characteristics. (Wing has rectangular plan form, Army tips, N. A. C. A. 23012 section, except as noted,) Mass distributed along wing. Tail C; Rudder 30° with; Elevators 20° down; Ailerons 0°.

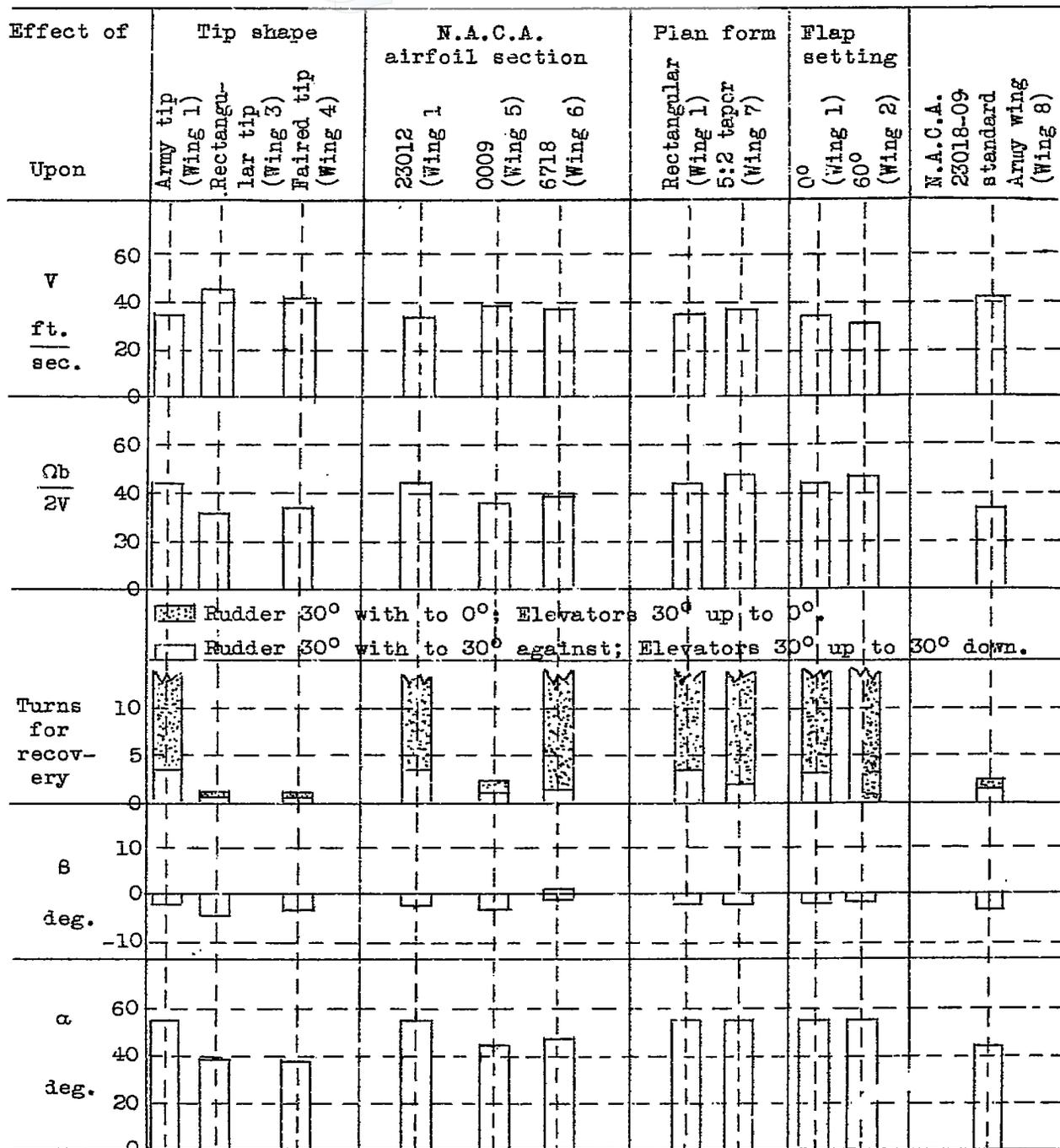

Figure 16.- The effect of various wings on the spin characteristics. (Wing has rectangular plan form, Army tips, N.A.C.A. 23012 section, except as noted.) Mass distributed along the wing. Tail C; Rudder 30° with; Elevators 30° up; Ailerons 0°.

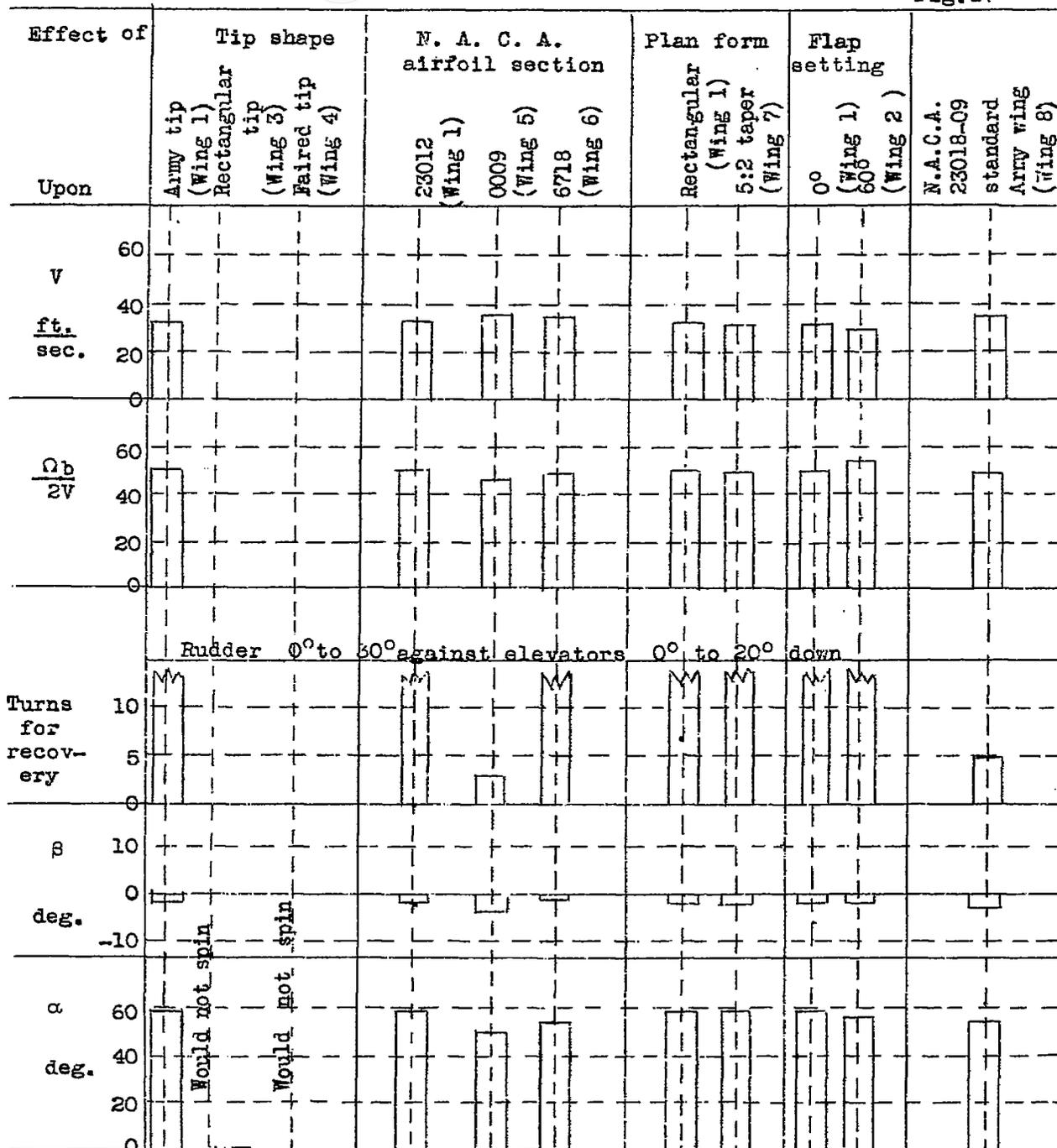

Figure 17.- The effect of various wings on the spin characteristics. (Wing has rectangular plan form, Army tips, N. A. C. A. 23012 section, except as noted.) Mass distributed along wing. Tail C; Rudder 0°; Elevators 0°; Ailerons 0°.