

APR 3 1940

TECHNICAL NOTES

NATIONAL ADVISORY COMMITTEE FOR AERONAUTICS

No. 755 ●

WIND-TUNNEL INVESTIGATION OF AN N.A.C.A. 23030
AIRFOIL WITH VARIOUS ARRANGEMENTS OF SLOTTED FLAPS

By I. G. Recant
Langley Memorial Aeronautical Laboratory

Washington
March 1940

NATIONAL ADVISORY COMMITTEE FOR AERONAUTICS

TECHNICAL NOTE NO. 755

WIND-TUNNEL INVESTIGATION OF AN N.A.C.A. 23030
AIRFOIL WITH VARIOUS ARRANGEMENTS OF SLOTTED FLAPS

By I. G. Recant

SUMMARY

An investigation was made in the N.A.C.A. 7- by 10-foot wind tunnel of a large-chord N.A.C.A. 23030 airfoil with a 40- and a 25.66-percent-chord slotted flap to determine the section aerodynamic characteristics of the airfoil as affected by flap chord, slot shape, flap position, and flap deflection. The flap positions for maximum lift, the positions for minimum drag at moderate and high lift coefficients, and the complete section aerodynamic characteristics of selected optimum arrangements are given. Envelope polars of various flap arrangements are included. The relative merits of slotted flaps of different chords on the N.A.C.A. 23030 airfoil are discussed, and a comparison is made of each flap size with a corresponding flap size on the N.A.C.A. 23021 and 23012 airfoils.

The lowest profile drags at moderate lift coefficients were obtained with an easy entrance to the slot. The 25.66-percent-chord slotted flap gave somewhat lower drag than the 40-percent-chord flap for lift coefficients less than 1.8, but the 40-percent-chord flap gave considerably lower drag for lift coefficients from 1.8 to 2.5 and a larger value of the maximum lift coefficient. The drag coefficients at moderate and high lift coefficients were greater with both sizes of flap on the N.A.C.A. 23030 airfoil than on either the N.A.C.A. 23021 or the N.A.C.A. 23012 airfoil. The maximum lift coefficient for the deflections tested with either flap was practically independent of airfoil thickness.

INTRODUCTION

The National Advisory Committee for Aeronautics has been conducting an extensive investigation of wing-flap

combinations for the purpose of improving safety and performance. For take-off and initial climb, a wing-flap combination capable of producing moderately high lift with low drag is desirable. On the other hand, landing requirements probably make a device with high lift and variable drag desirable. Furthermore, such a device should give a small increase in drag when the flap is retracted and should give low operating forces and a minimum change in pitching moment with change in flap deflection.

Of the various types of flap investigated by the N.A.C.A., the slotted flaps are apparently most nearly capable of meeting these specifications; medium-chord and large-chord slotted flaps for the N.A.C.A. 23012 and 23021 airfoils have been developed (references 1 to 4). The present report gives the results of tests of the N.A.C.A. 23030 airfoil with slotted flaps of 40-percent and 25.66-percent chord. With the completion of the present tests, data are therefore available for the aerodynamic design of slotted flaps on airfoils of any probable thickness.

MODELS

Plain Airfoil

The basic airfoil, which was built of laminated pine to the N.A.C.A. 23030 profile, has a 3-foot chord and a 7-foot span. The trailing-edge section was made easily removable so that it can be readily replaced by different flap arrangements. The ordinates for this airfoil are given in table I.

Slotted-Flap Arrangements

The slot shapes and flaps were built of laminated pine. The slot shapes were bolted to the main airfoil in place of the plain trailing edge, and the flaps were mounted on the airfoil by means of special fittings that permitted wide variation in location with respect to the slot lips. The basic airfoil, the flaps, and the slot shapes were fair and were made to a tolerance of ± 0.015 inch.

Flaps. - Two flaps were tested, one with a chord 40

percent of the wing chord and the other with a chord 25.66 percent of the wing chord. These flaps are not geometrically similar, but both were designed with a small nose radius to keep the width of the breaks in the lower surface of the airfoil narrow with the flaps retracted. The upper surface of the forward portion of each flap is an arc of a circle tangent to the lower surface of the slot lip. (See figs. 1 and 2.) Both flaps are designated 1 because they are comparable with flaps 1 used with the N.A.C.A. 23012 and 23021 airfoils (references 1 to 4). For convenience, the 40-percent-chord flap will hereinafter be referred to as the "wide-chord" flap and the 25.66-percent-chord flap will be referred to as the "medium-chord" flap.

Slot shapes.- Two types of slot shape were used with each size of flap. These types are designated a and b. (See figs. 1 and 2.) Shapes a and b for the wide-chord flap are not geometrically similar to shapes a and b for the medium-chord flap. Shapes a for both flap sizes, however, were designed to give a minimum break in the lower surface of the airfoil with the flaps retracted and shapes b are comparable with shape h of reference 1, which gave the lowest drag for high and intermediate lift coefficients. The slot lips for each flap size are longer than the slot lips for corresponding flap sizes on the N.A.C.A. 23012 and the N.A.C.A. 23021 airfoils. (See references 1 to 4.)

TESTS

The model was mounted vertically in the closed test section of the N.A.C.A. 7- by 10-foot wind tunnel (references 1 and 5) so that it completely spanned the jet except for small clearances at each end. The main airfoil was rigidly attached to the balance frame by torque tubes, which extended through the upper and the lower boundaries of the tunnel. The angle of attack of the model was set from outside the tunnel by rotating the torque tubes with a calibrated drive. Approximately two-dimensional flow is obtained with this type of installation and the section characteristics of the model under test can be determined.

All tests, except those to determine the effect of scale, were made at a dynamic pressure of 16.37 pounds per square foot, corresponding to a velocity of approxi-

4 . N.A.C.A. Technical Note No. 755

mately 80 miles per hour under standard atmospheric conditions and to an average test Reynolds Number of about 2,190,000. Because of the turbulence in the wind tunnel, the effective Reynolds Number, R_e , (reference 6) was approximately 3,500,000. For all tests, the value of R_0 is based on the chord of the airfoil with the flap retracted and on a turbulence factor of 1.6 for the tunnel.

Plain Airfoil

The lift, the drag, and the pitching moment of the basic airfoil were measured over the complete angle-of-attack range from -6° to the stall.

Slotted-Flap Arrangements

Tests were first made with each size of flap and both slot shapes to determine the effect on the drag of the breaks in the wing surface at the slot entrance and the slot lip when the flap was retracted. The effect of the flap hinges with the flaps in the retracted position was also investigated. Tests were then made with each flap size and each slot shape at various flap deflections and positions to determine the optimum paths from considerations of low drag at small flap deflections and high lift at large flap deflections. The wide-chord and the medium-chord flaps were deflection from 0° to 50° and from 0° to 60° , respectively, in 10° increments. In all cases, lift, drag, and pitching moment were measured through an angle-of-attack range from -6° to the stall.

Scale-effect tests were also made of the medium-chord flap in its optimum position for maximum lift when deflected 40° .

RESULTS AND DISCUSSION

Coefficients

All the test results are given in standard section nondimensional coefficient form corrected for tunnel-wall effect and turbulence as explained in reference 1.

c_l section lift coefficient (l/qc).

c_{d_o} section profile-drag coefficient (d_o/qc).
 $c_{m(a.c.)_o}$ section pitching-moment coefficient about
 aerodynamic center of plain airfoil
 ($m(a.c.)_o/qc^2$).

where

l section lift.
 d_o section profile drag.
 $m(a.c.)_o$ section pitching moment.
 q dynamic pressure ($\rho V^2/2$).
 c chord of basic airfoil with flap fully re-
 tracted.

and

α_o angle of attack for infinite aspect ratio.
 δ_f flap deflection.
 c_f flap chord.

Precision

The accuracy of the various measurements in the tests is believed to be within the following limits:

α_o ----- $\pm 0.1^\circ$	$c_{d_o}(c_l = 1.0)$ --- ± 0.0006
$c_{l_{max}}$ ----- ± 0.03	$c_{d_o}(c_l = 2.5)$ --- ± 0.002
$c_{m(a.c.)_o}$ -- ± 0.003	δ_f ----- $\pm 0.2^\circ$
$c_{d_{o_{min}}}$ ----- ± 0.0003	Flap position --- $\pm 0.001c$

A correction for the effect of the flap-hinge fittings has been applied to the data for the flap-retracted conditions. This correction amounted to about 5 percent of the minimum drag of the plain airfoil. No attempt was made to determine the effect of the hinges with the flaps

deflected. The relative merits of the various flap arrangements, however, are believed to be inappreciably affected because the same fittings were used throughout the tests for a given flap size.

Plain Airfoil

Aerodynamic characteristics.— The complete section aerodynamic characteristics of the plain N.A.C.A. 23030 airfoil are given in figure 3. As these data have been discussed in reference 7, no further comment is required.

Effect on profile drag of breaks in surface of airfoil due to slot.— The effect of the breaks in the airfoil surface on the drag coefficient with the flap retracted is shown in figure 4 for the wide-chord flap and in figure 5 for the medium-chord flap. The variation of increment of profile-drag coefficient (Δc_{d_0}) was irregular in almost all cases. With only the slot lip of the wide-chord-flap arrangement unsealed, Δc_{d_0} was negligible below a lift coefficient of 0.6 and rose to a value of 0.0018 at $c_l = 0.8$. In the case of the medium-chord flap, the Δc_{d_0} due to this break was too small to measure.

When the breaks in the upper and the lower surfaces caused by wide-chord flap 1-a were unsealed, Δc_{d_0} varied from 0.0006 to 0.0035, while the breaks caused by medium-chord flap 1-a gave values of Δc_{d_0} varying from about 0.0004 at $c_l = 0$ to 0 at $c_l = 0.8$. The Δc_{d_0} for the wide-chord flap 1-b unsealed was about 5 times that for wide-chord flap 1-a, and the Δc_{d_0} with the medium-chord flap 1-b unsealed was about 10 times that of the corresponding 1-a arrangement. Much of the drag increment due to the breaks in the wing lower surface with either slot shape with the flap retracted can probably be eliminated by the use of an auxiliary flap or a door to seal the breaks.

Slotted-Flap Arrangements

Determination of optimum arrangements for maximum lift.— The data in this section are presented as contours (figs. 6 to 9) of flap-nose position relative to the slot lip for constant values of lift coefficient. These con-

tours were prepared from the results of tests at numerous positions for each flap deflection. The nose of the flap is defined as the point of tangency of the leading-edge arc and a line perpendicular to the wing chord line when the flap is in the neutral position. (See figs. 1 and 2.)

From these contours, it should be possible to select the best flap path from considerations of maximum lift coefficient for each flap deflection. If, for structural reasons, it is impossible to use the best aerodynamic path, the contours permit the evaluation of the effect of any deviation. Complete section aerodynamic characteristics of selected optimum arrangements for each flap deflection are given in a later section.

Contours of maximum lift coefficient for the wide-chord flaps 1-a and 1-b are given in figures 6 and 7; figures 8 and 9 give the contours for the medium-chord flaps 1-a and 1-b. A number of these contours, including some for high flap deflections, are unclosed because a large enough area was not covered by the tests. It is believed, however, that the range tested will include any path chosen for mechanical practicability. In any case, the contours would close back of the lip.

The wide-chord flap was deflected from 10° to 50° and the medium-chord flap was deflected from 10° to 60° . These ranges, although too narrow to establish definitely the ultimate maximum lift coefficient of each flap, are the same as those investigated for the slotted flaps on the N.A.C.A. 23012 and the N.A.C.A. 23021 airfoils. The maximum lift coefficients obtained in the tests for the wide-chord flaps 1-a and 1-b are 2.82 and 2.90, respectively. These lift coefficients were obtained with the flaps deflected 50° and located at a point 2.5 percent of the wing chord ahead of and 6 percent below the slot lip. Medium-chord flap 1-a gives a maximum lift coefficient of 2.59 when deflected 60° and located 2.5 percent of the wing chord ahead of and 4 percent below the slot lip. The maximum lift coefficient given by medium-chord flap 1-b is 2.68 when deflected 60° and located 0.5 percent of the wing chord behind and 4 percent below the slot lip.

The contours of maximum lift coefficients at flap deflections of 10° and 20° for all flap arrangements are included to make the data more complete, because the optimum flap positions for these deflections will probably be chosen from considerations of low drag and practicability of mechanical operation.

Determination of optimum arrangements for profile drag.- The optimum positions from considerations of low drag at moderate lift coefficients likely to be used for take-off were chosen from contours of flap-nose position for constant drag at $c_l = 1.0$ and 1.5 for the 10° and the 20° flap deflections. Figures 10 and 11 show the contours for the wide-chord flaps 1-a and 1-b, and figures 12 and 13 give the contours for the medium-chord flaps 1-a and 1-b. Most of these contours do not close, but it is believed that sufficient positions have been investigated to cover any probable flap path.

Insufficient data were available to give contours at $c_l = 2.0$, but the position for minimum c_{d_0} at $c_l = 1.5$ and $\delta_f = 20^\circ$ is also the position at which c_{d_0} is minimum at $c_l = 2.0$ and $\delta_f = 20^\circ$ for both the wide- and the medium-chord flaps 1-b. The minimum profile drag at $c_l = 2.0$ is higher when $\delta_f = 30^\circ$ than when $\delta_f = 20^\circ$ for both flap sizes.

The best flap positions, aerodynamically, for the 10° and the 20° flap deflections are indicated by figures 10 to 13. The figures also permit the evaluation of the detrimental effect due to deviation from these positions.

Section aerodynamic characteristics of selected optimum arrangements.- The optimum positions for each flap arrangement were selected from considerations of low drag at the 10° and the 20° flap deflections and of maximum lift coefficient at the higher flap deflections. The complete aerodynamic characteristics of these optimum positions are given in figures 14 to 17. These figures also include data for positions that are not on the best aerodynamic path in order to make possible the estimation of the characteristics of a path, the reproduction of which would be structurally simpler. The table in each figure gives the flap position for each flap deflection. The path for each flap arrangement plotted in the sketch on the figures is a structurally feasible one that closely follows the aerodynamic optimum. These compromise paths are hereinafter referred to as the "selected" optimum paths. The characteristics given are typical and data for positions other than those shown are available upon request.

Comparison of selected optimum arrangements.- Envelope polars, obtained from figures 14 to 17, for both flap sizes, each with slot shapes a and b, are shown in fig-

ures 18 and 19. A comparison of these polars indicates that, except at low values of the lift coefficient, slotted flap 1-b is better from considerations of drag than 1-a for both flap sizes. On this basis, the wide-chord flap 1-b is more suitable for take-off than 1-a for lift coefficients above 0.7, and the medium-chord flap 1-b is better than 1-a at lift coefficients greater than 0.4. It should be noted that, below a lift coefficient of about 0.5, the plain wing has less drag than any of the arrangements with the flap deflected. A door to seal the breaks in the lower surface of the wing would therefore make all the arrangements approximately equivalent to the plain wing at the lower values of c_l .

Slotted flap 1-b is superior to 1-a for either the wide- or the medium-chord flaps when they are compared on a basis of increment of maximum lift coefficient for a given flap deflection, the flaps in all cases being moved along the selected optimum paths. (See figs. 20 and 21.)

The diving moment at the same lift coefficient is greater for slotted flaps 1-b than for slotted flaps 1-a, the difference being more pronounced for the wide-chord flap than for the medium-chord flap (figs. 14 to 17).

Comparison of slotted flaps of different chord.— A comparison of the wide-chord flap 1-b and the medium-chord flap 1-b is made in figure 22. The medium-chord flap gives a lower drag than the wide-chord flap at lift coefficients lower than 1.8 and would therefore be more desirable for take-off in this range. The wide-chord flap, however, would be more suitable for take-off for a range of lift coefficients from 1.8 to about 2.5. This flap also gives a higher value of maximum lift coefficient for the range of flap deflections tested. The pitching-moment coefficient given by the wide-chord flap is greater, however, than that given by the medium-chord flap at the same lift coefficient.

The variation of increment of maximum lift coefficient with flap chord for a flap deflection of 50° is shown in figure 23. The fairing of this curve is, of course, arbitrary, but the indications are that a greater gain in increment of maximum lift may be expected by increasing the flap chord from 10 percent to 25.66 percent than from 25.66 percent to 40 percent. This result would be in agreement with the results for the slotted flaps of different chord on the N.A.C.A. 23012 airfoil (reference

2). There apparently is no justification for using the wide-chord flap merely because it gives a somewhat higher $c_{l_{max}}$, since the hinge moment, being proportional to the square of the flap chord, would be considerably larger with this flap than with the medium-chord flap.

Effect of scale on increment of maximum lift coefficient.— The effect of scale on the increment of maximum lift coefficient for the medium-chord flap 1-b is shown in figure 24. The increment of $c_{l_{max}}$ increases with increasing scale from $Re = 1$ to about 1.5 million. At higher Reynolds Numbers, no increase in $\Delta c_{l_{max}}$ occurs. The curve indicates that the increment of maximum lift coefficient may be considered independent of scale in the range of Reynolds Numbers from 1,500,000 to 3,500,000.

Comparison of wide- and medium-chord slotted flaps on airfoils of different thickness.— The results of the present tests together with the results reported in references 1 to 4 make possible an evaluation of the effect of airfoil thickness on the characteristics of airfoils equipped with slotted flaps. Such an evaluation is made in figure 25, which gives the envelope polars for the wide-chord flap 1-b on the N.A.C.A. 23012 (reference 2), N.A.C.A. 23021 (reference 4), and N.A.C.A. 23030 airfoils. As may be expected, the drag at a given lift coefficient increases as the thickness of the airfoil increases. It is of interest to note, however, that the maximum lift coefficient at $\delta_f = 50^\circ$ and the drag at that lift coefficient are about the same for the three airfoils.

A comparison of medium-chord flap 2-h on the N.A.C.A. 23012 (reference 1), flap 2-b on the N.A.C.A. 23021 (reference 3), and flap 1-b on the N.A.C.A. 23030 airfoils is made in figure 26. Here again the drag for a given lift coefficient increases with wing thickness. Although the maximum lift and the drag at this lift are about the same for the 12-percent and the 21-percent-thick airfoils, the envelope polar for the 30-percent-thick airfoil lies inside the polars for the other airfoils throughout the lift range.

The $c_{l_{max}}$ for the plain airfoils substantially decreases as the airfoil thickness increases (reference 7), and this result might be expected for airfoils with slot-

ted flaps. Inspection of figure 27, however, shows that the maximum lift coefficient of the slotted-flap airfoils are not greatly affected by wing thickness. The $c_{l,max}$ of the airfoils with the medium-chord slotted flap decreases about 5 percent with an increase in thickness from 12 to 30 percent, as compared with a decrease of about 30 percent for the plain airfoils over the same range of thickness. In the case of airfoils with a wide-chord slotted flap, no change in maximum lift coefficient occurs with increasing wing thickness. If structural requirements necessitate a thick section, the use of slotted flaps will therefore largely eliminate any loss in maximum lift coefficient that is associated with the thick section when used without flaps. Similar results have been obtained with split flaps (reference 7).

CONCLUDING REMARKS

An easy slot entrance was better than a sharp entrance with both the 25.66-percent-chord flap and the 40-percent-chord flap, except for low drag with the flap retracted. The wide-chord flap was better than the medium-chord flap from considerations of maximum lift coefficient and low drag at lift coefficients of 1.8 to 2.5, although the gain in maximum lift coefficient was relatively small. Both flap sizes gave progressively lower values of drag coefficient at moderate and high lift coefficients on the N.A.C.A. 23021 and 23012 airfoils than on the N.A.C.A. 23030 airfoil. The maximum lift coefficient with either flap was approximately independent of airfoil thickness.

Langley Memorial Aeronautical Laboratory,
National Advisory Committee for Aeronautics,
Langley Field, Va., February 28, 1940.

REFERENCES

1. Wenzinger, Carl J., and Harris, Thomas A.: Wind-Tunnel Investigation of an N.A.C.A. 23012 Airfoil with Various Arrangements of Slotted Flaps. T.R. No. 664, N.A.C.A., 1939.
2. Harris, Thomas A.: Wind-Tunnel Investigation of an N.A.C.A. 23012 Airfoil with Two Arrangements of a Wide-Chord Slotted Flap. T.N. No. 715, N.A.C.A., 1939.
3. Wenzinger, Carl J., and Harris, Thomas A.: Wind-Tunnel Investigation of an N.A.C.A. 23021 Airfoil with Various Arrangements of Slotted Flaps. T.R. No. 677, N.A.C.A., 1939.
4. Duschik, Frank: Wind-Tunnel Investigation of an N.A.C.A. 23021 Airfoil with Two Arrangements of a 40-Percent-Chord Slotted Flap. T.N. No. 728, N.A.C.A., 1939.
5. Harris, Thomas A.: The 7 by 10 Foot Wind Tunnel of the National Advisory Committee for Aeronautics. T.R. No. 412, N.A.C.A., 1931.
6. Jacobs, Eastman N., and Sherman, Albert: Airfoil Section Characteristics as Affected by Variations of the Reynolds Number. T.R. No. 586, N.A.C.A., 1937.
7. Wenzinger, Carl J., and Harris, Thomas A.: Wind-Tunnel Investigation of N.A.C.A. 23012, 23021, and 23030 Airfoils with Various Sizes of Split Flap. T.R. No. 668, N.A.C.A., 1939.

Table I

Ordinates for N.A.C.A. 23030 Airfoil
 (Stations and ordinates in percent of wing chord)

Station	Ordinate	
	Upper	Lower
0	4.82	0
1.25	7.37	-2.63
2.5	8.90	-4.27
5	11.05	-6.54
7.5	12.57	-8.28
10	13.68	-9.65
15	15.20	-11.52
20	16.07	-12.61
25	16.46	-13.20
30	16.57	-13.46
40	15.89	-13.13
50	14.38	-12.11
60	12.34	-10.47
70	9.86	-8.42
80	7.03	-6.09
90	3.87	-3.40
95	2.15	-1.86
100	.315	-.315

L.E. radius: 9.90. Slope of
 radius through end of
 chord: 0.305.

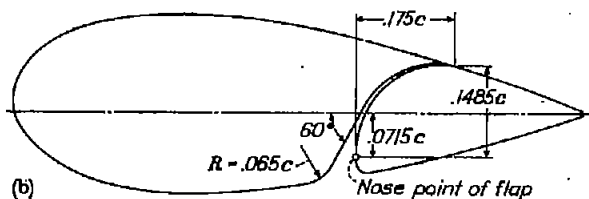
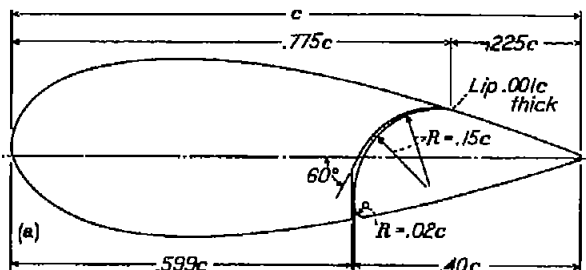

(a) Flap 1-a (b) Flap 1-b
 Figure 1.- Sections of N.A.C.A. 23030 airfoil with arrangements of 0.40c slotted flap 1.

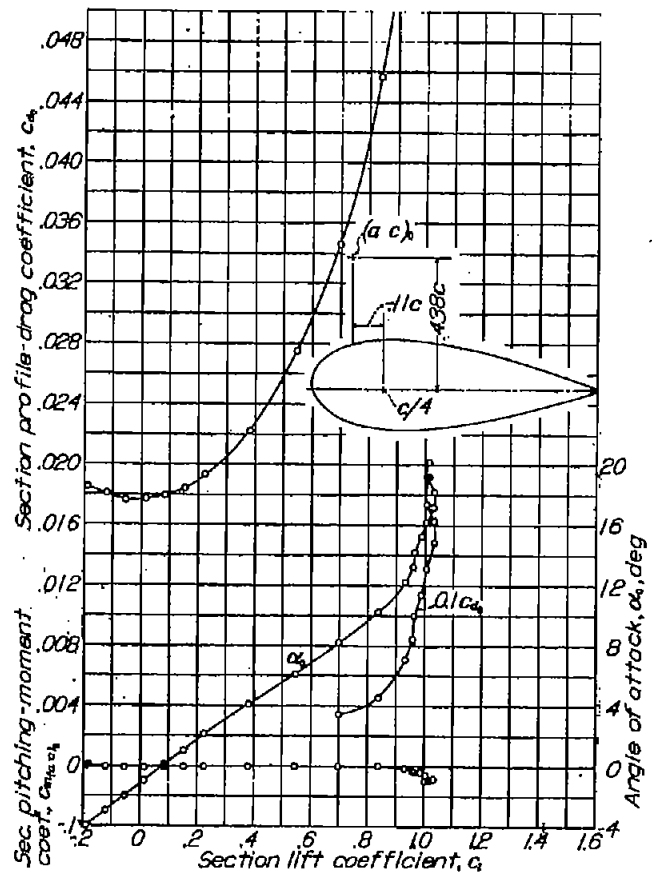
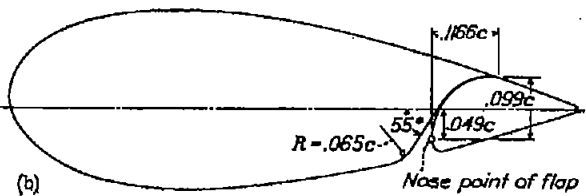
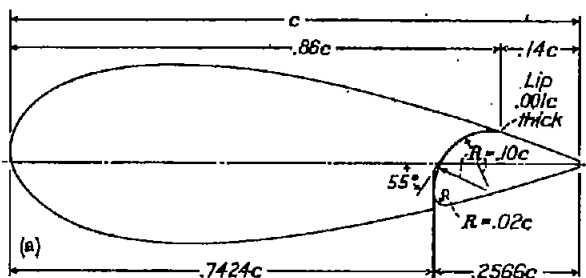

Figure 3.- Section aerodynamic characteristics of N.A.C.A. 23030 plain airfoil.

(a) Flap 1-a (b) Flap 1-b
 Figure 2.- Sections of N.A.C.A. 23030 airfoil with arrangements of 0.256c slotted flap 1.

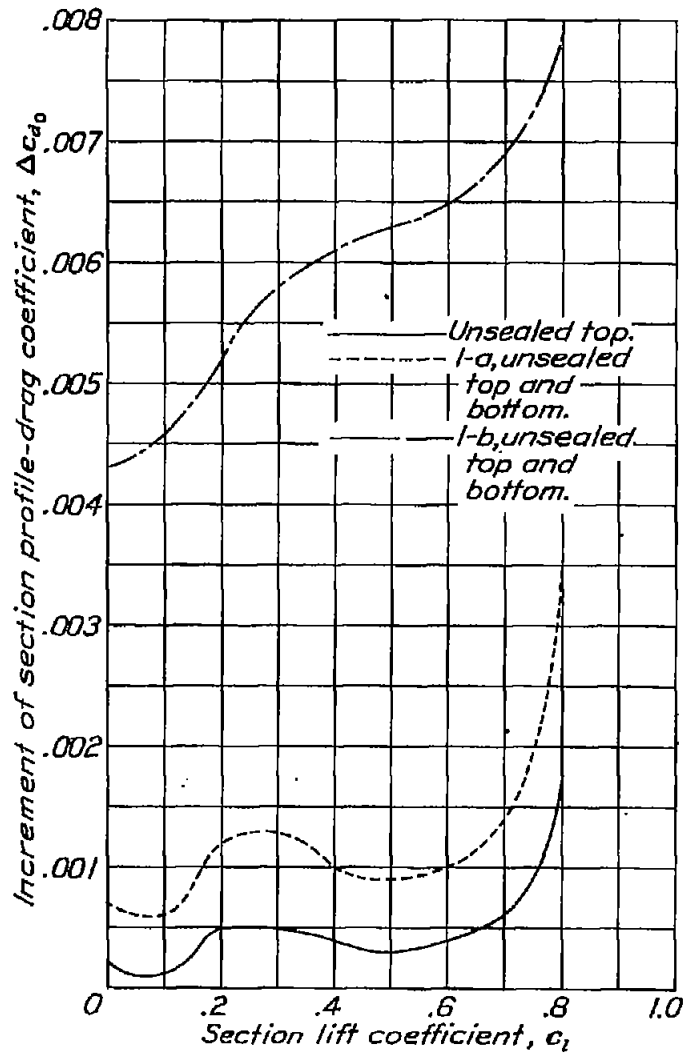

Figure 4.- Effect of slot openings in surface of airfoil on section profile-drag coefficient. The 0.40c slotted flap; $\delta_f = 0^\circ$

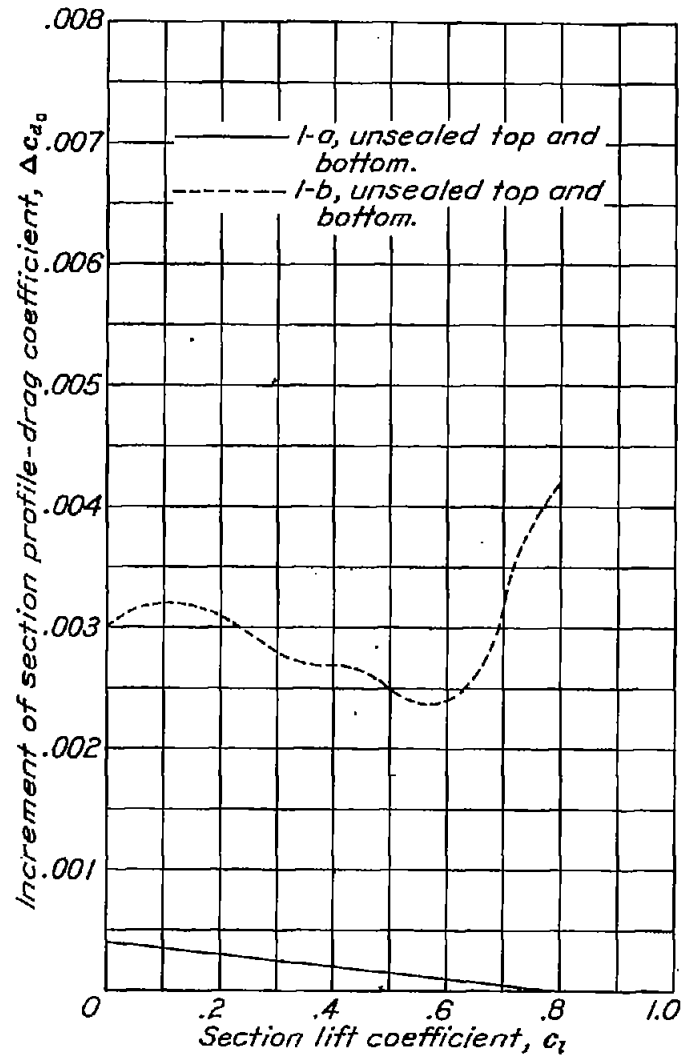
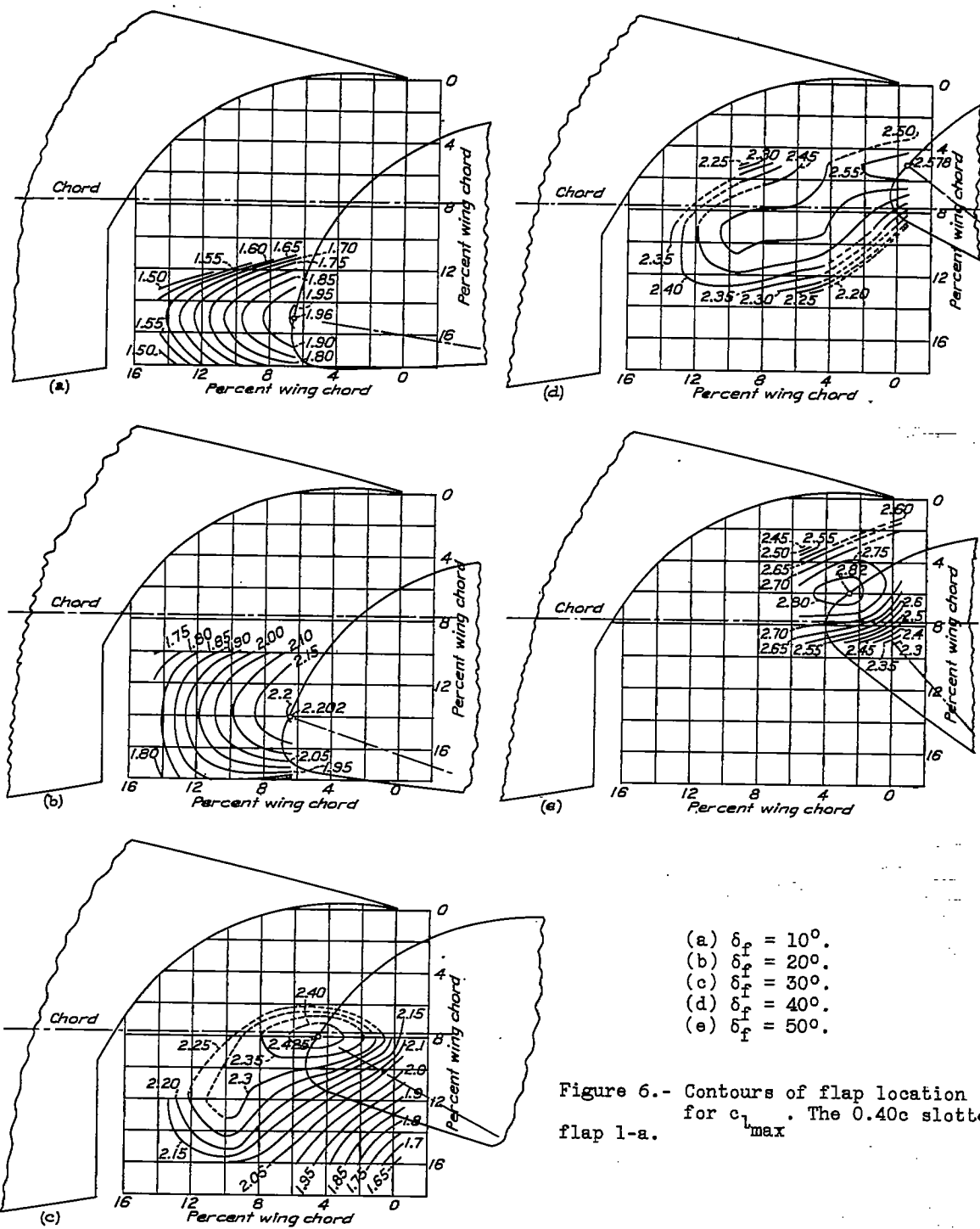
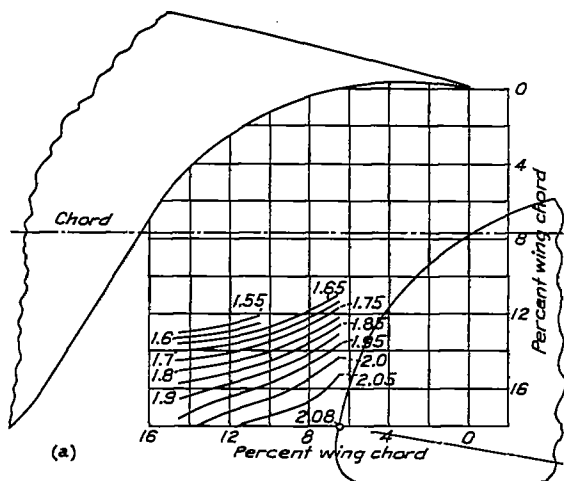
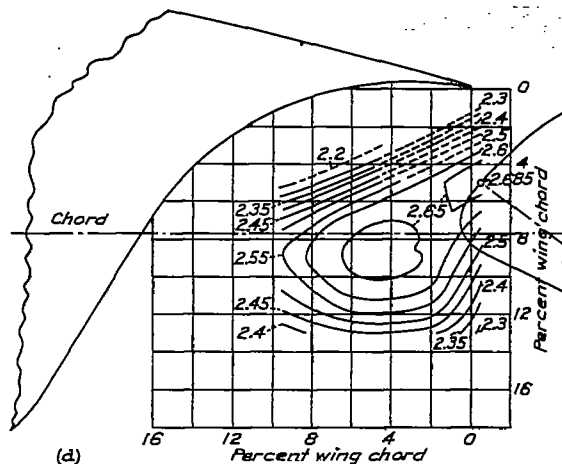

Figure 5.- Effect of slot openings in surface of airfoil on section profile-drag coefficient. The 0.2588c slotted flap; $\delta_f = 0^\circ$





(a)



(d)

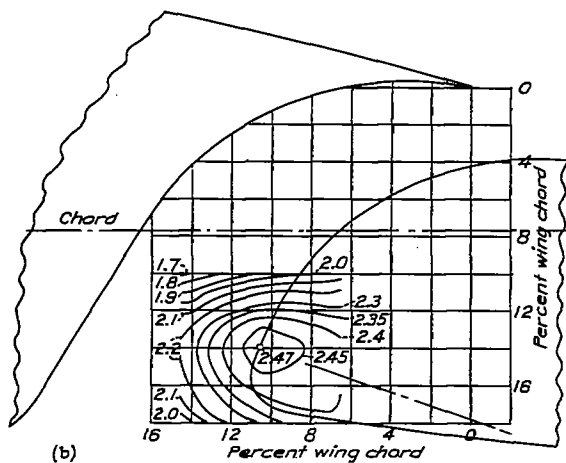

(b)

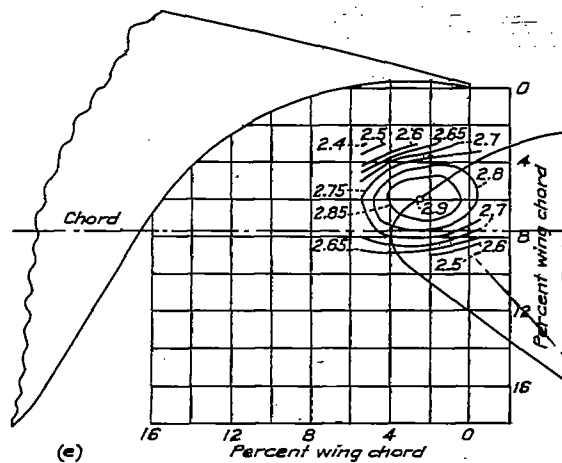

(e)

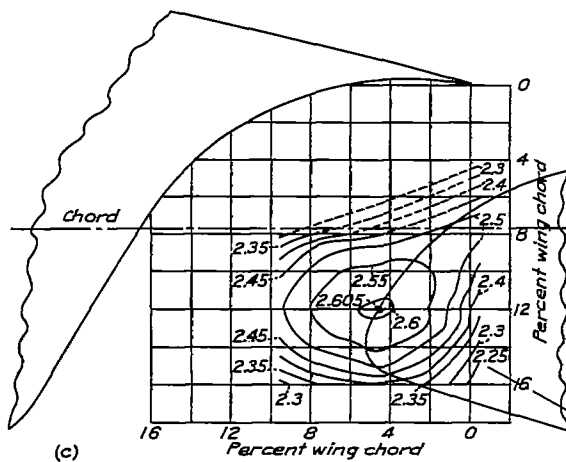

(c)

- (a) $\delta_{fp} = 10^\circ$.
- (b) $\delta_{fp} = 20^\circ$.
- (c) $\delta_{fp} = 30^\circ$.
- (d) $\delta_{fp} = 40^\circ$.
- (e) $\delta_{fp} = 50^\circ$.

Figure 7.- Contours of flap location for $c_{l_{max}}$. The 0.40c slotted flap 1-b.

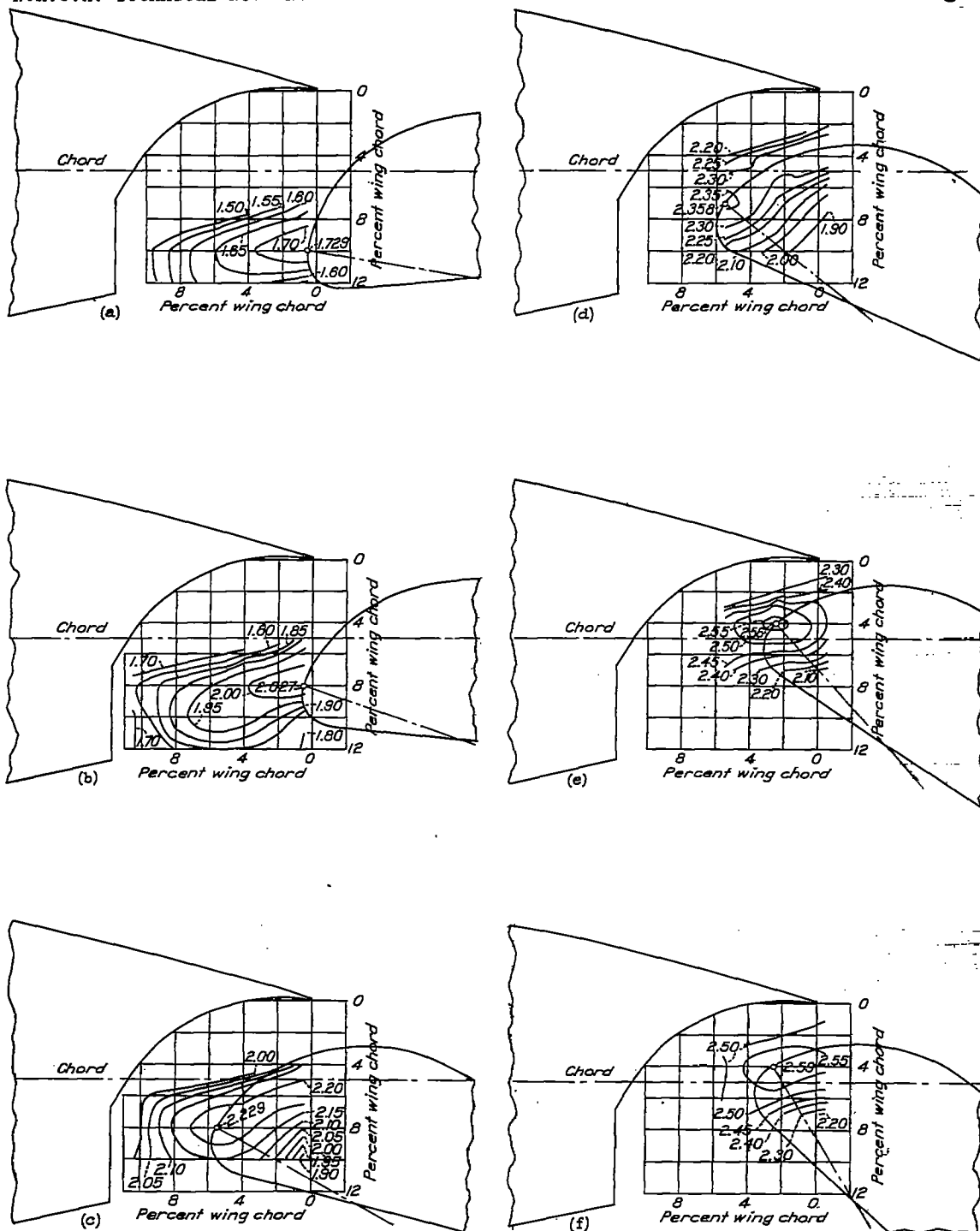

(a) $\delta_f=10^\circ$. (b) $\delta_f=20^\circ$. (c) $\delta_f=30^\circ$.

(d) $\delta_f=40^\circ$. (e) $\delta_f=50^\circ$. (f) $\delta_f=60^\circ$.

Figure 8.- Contours of flap location for $c_{l_{max}}$. The 0.2566c slotted flap 1-a.

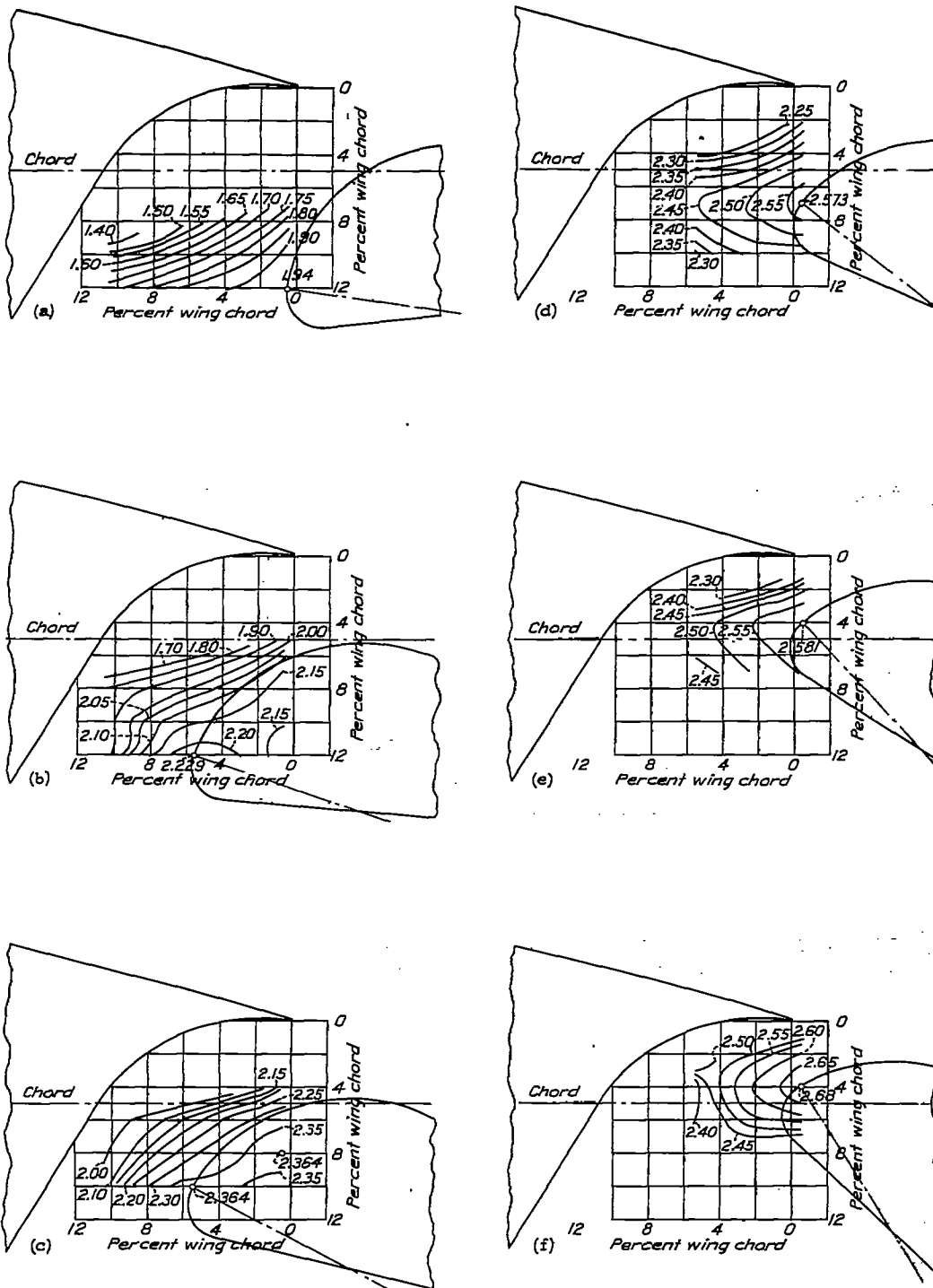

(a) $\delta_f = 10^\circ$. (b) $\delta_f = 20^\circ$. (c) $\delta_f = 30^\circ$. (d) $\delta_f = 40^\circ$. (e) $\delta_f = 50^\circ$. (f) $\delta_f = 60^\circ$.

Figure 9.- Contours of flap location for $c_{l_{max}}$. The 0.2566c slotted flap 1-b.

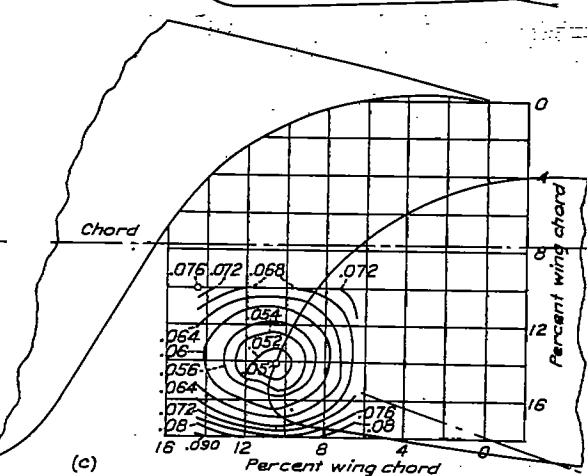
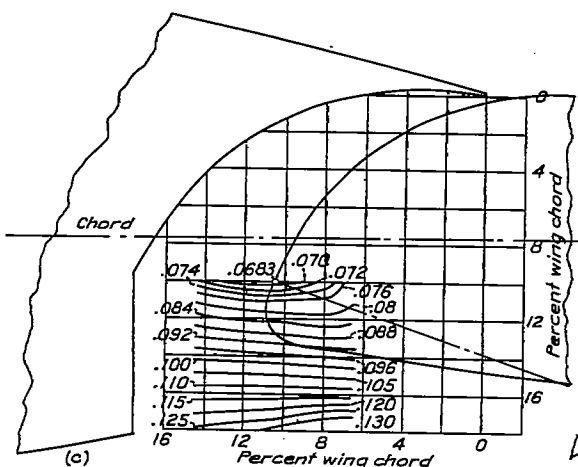
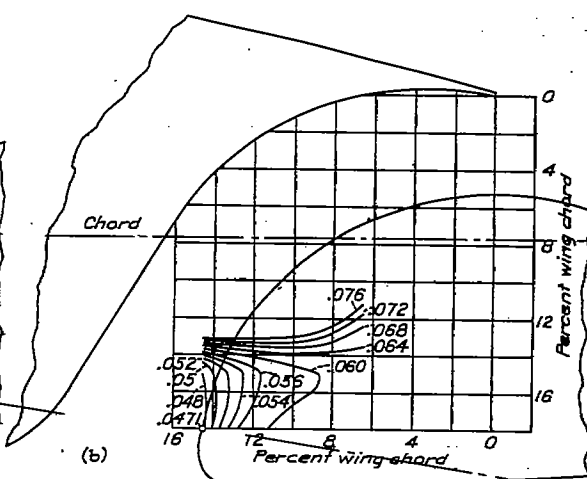
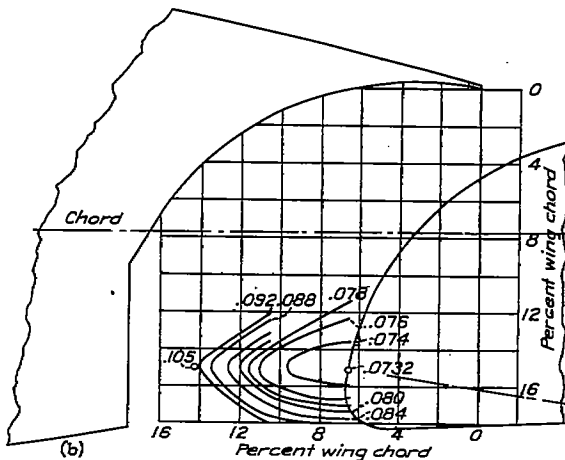
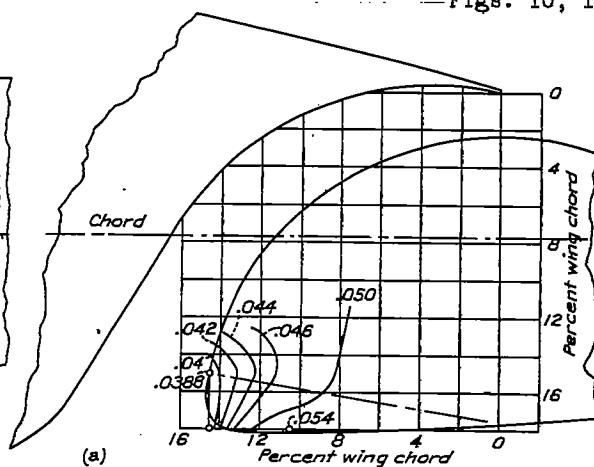
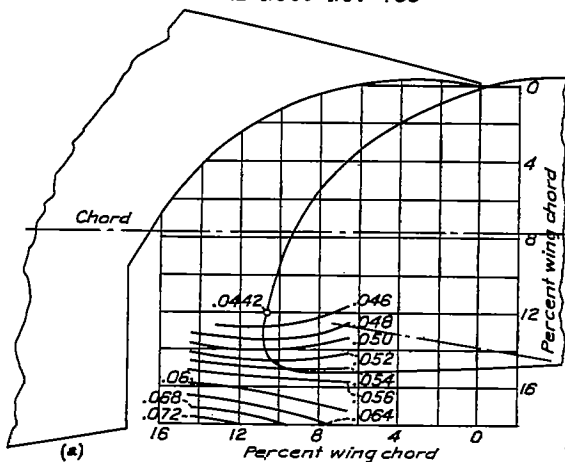

(a) $\delta_f = 1.0; c_l = 1.0$; (b) $\delta_f = 10^\circ; c_l = 1.5$.
 (c) $\delta_f = 20^\circ; c_l = 1.5$.

(a) $\delta_f = 10^\circ, c_l = 1.0$. (b) $\delta_f = 10^\circ, c_l = 1.5$.
 (c) $\delta_f = 20^\circ, c_l = 1.5$.

Figure 10.- Contours of flap location for c_{d_0} . The 0.40c slotted flap 1-a.

Figure 11.- Contours of flap location for c_{d_0} . The 0.40c slotted flap 1-b.

N.A.C.A. Technical Note No. 755

Figs. 12,13

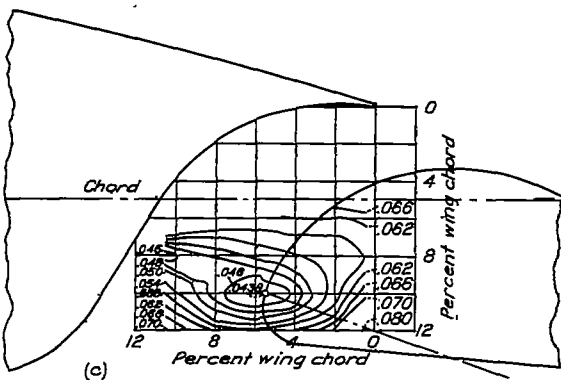
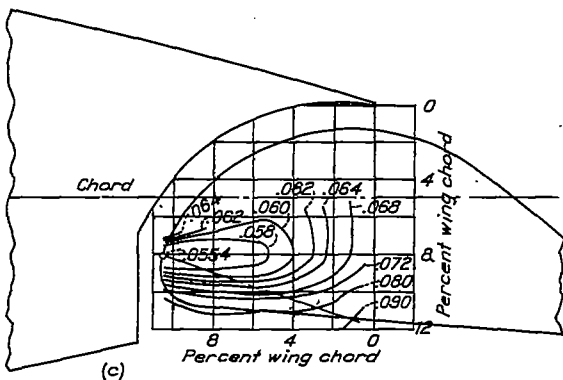
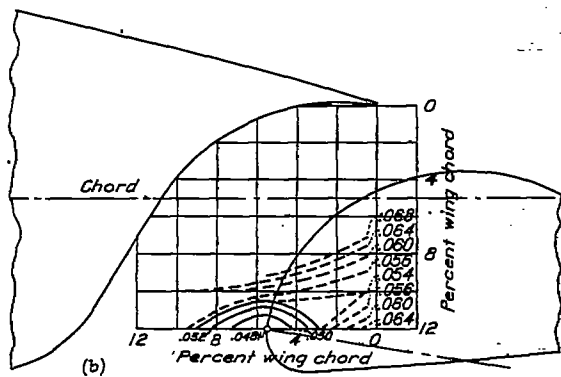
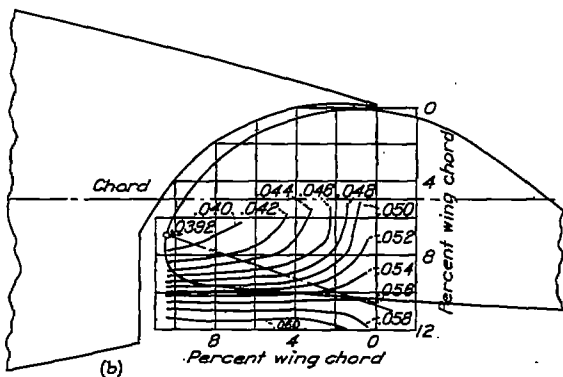
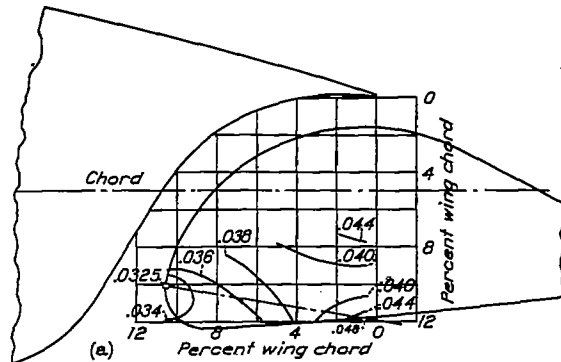
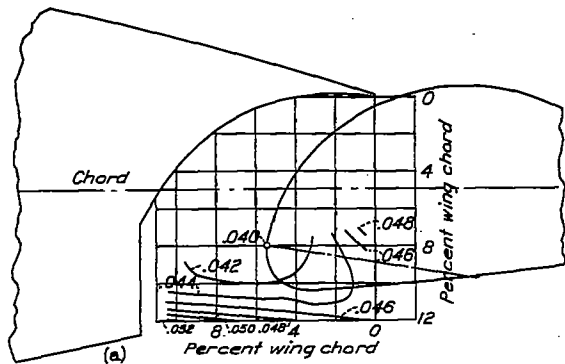

(a) $\delta_f = 10^\circ$; $c_l = 1.0$. (b) $\delta_f = 20^\circ$; $c_l = 1.0$.
 (c) $\delta_f = 20^\circ$; $c_l = 1.5$.

Figure 12.- Contours of flap location for c_{d0} . The 0.2566c slotted flap 1-a.

(a) $\delta_f = 10^\circ$; $c_l = 1.0$. (b) $\delta_f = 10^\circ$; $c_l = 1.5$.
 (c) $\delta_f = 20^\circ$; $c_l = 1.5$.

Figure 13.- Contours of flap location for c_{d0} . The 0.2566c slotted flap 1-b.

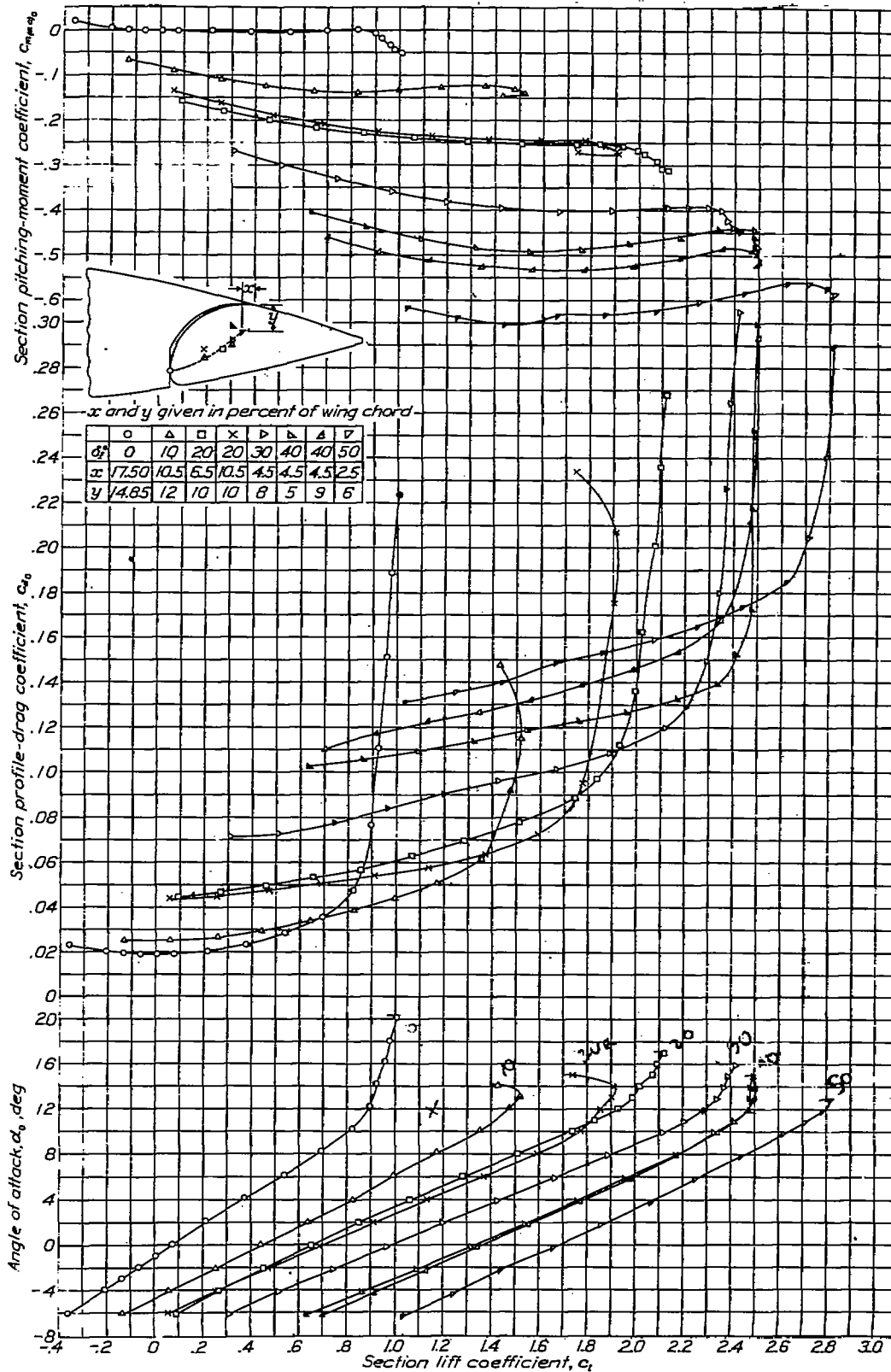

Figure 14.- Section aerodynamic characteristics of N.A.C.A. 23030 airfoil with 0.40c slotted flap 1-a.

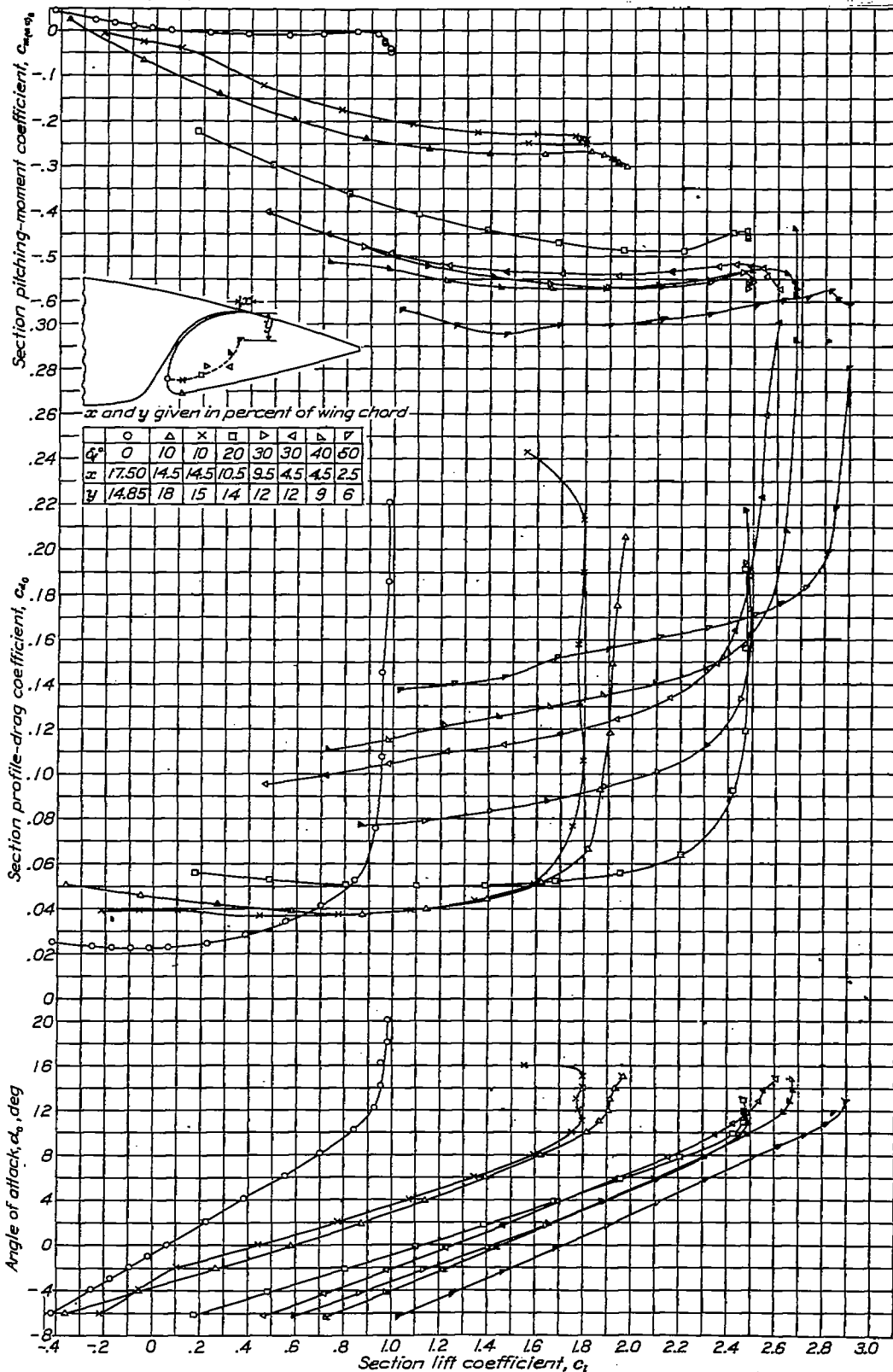

Figure 15.- Section aerodynamic characteristics of N.A.C.A. 25030 airfoil with 0.40c slotted flap 1-b.

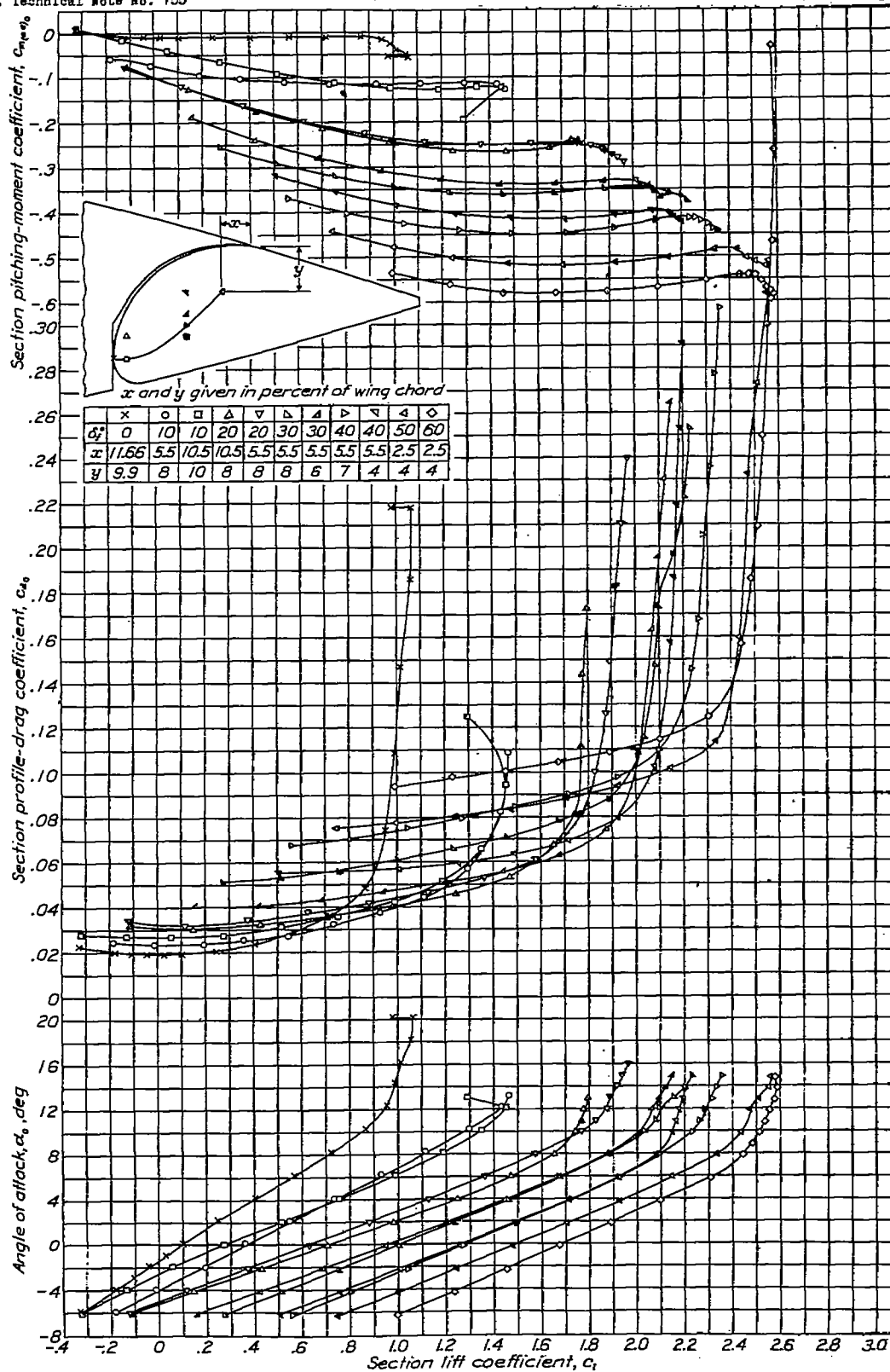

Figure 16.- Section aerodynamic characteristics of W.A.C.A. 23030 airfoil with 0.256c slotted flap 1-a.

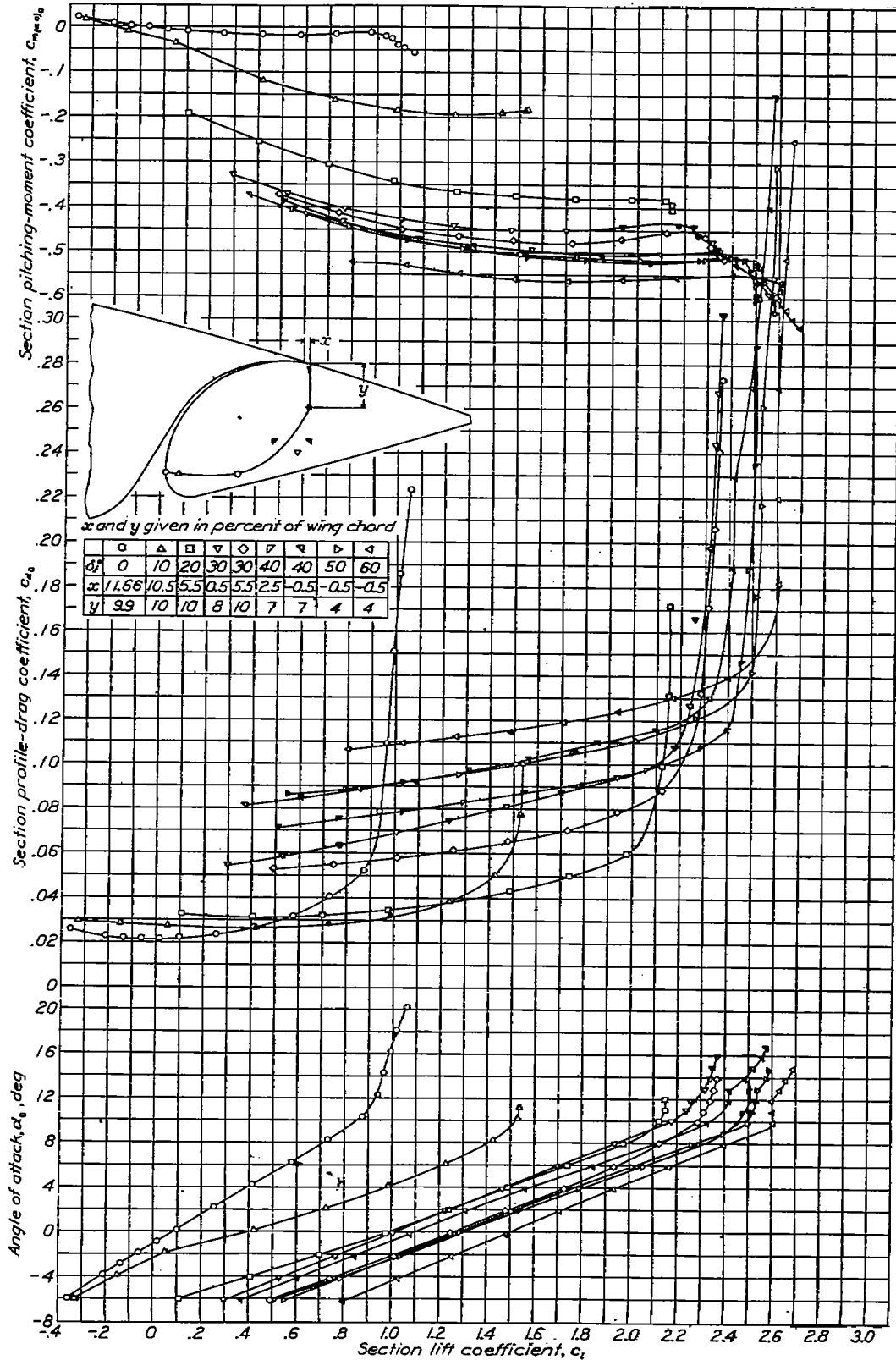

Figure 17.- Section aerodynamic characteristics of N.A.C.A. 23030 airfoil with 0.256c slotted flap I-b.

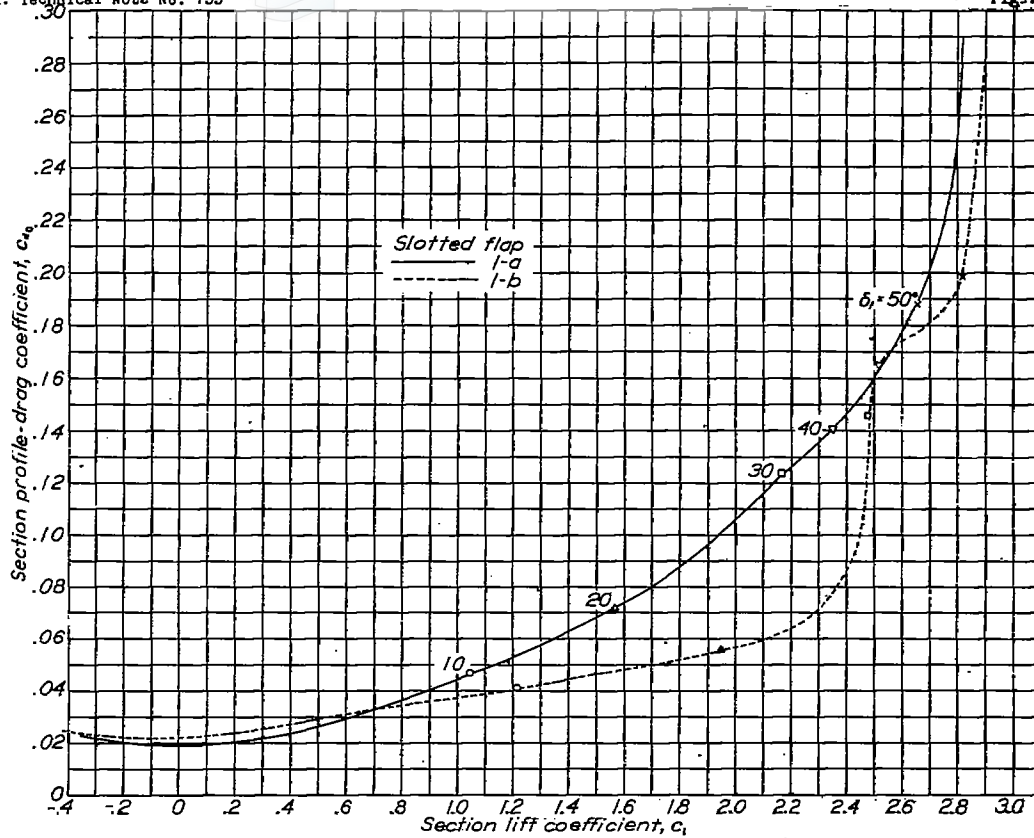

Figure 18.- Comparison of 0.40c slotted flaps on N.A.C.A. 23030 airfoil.

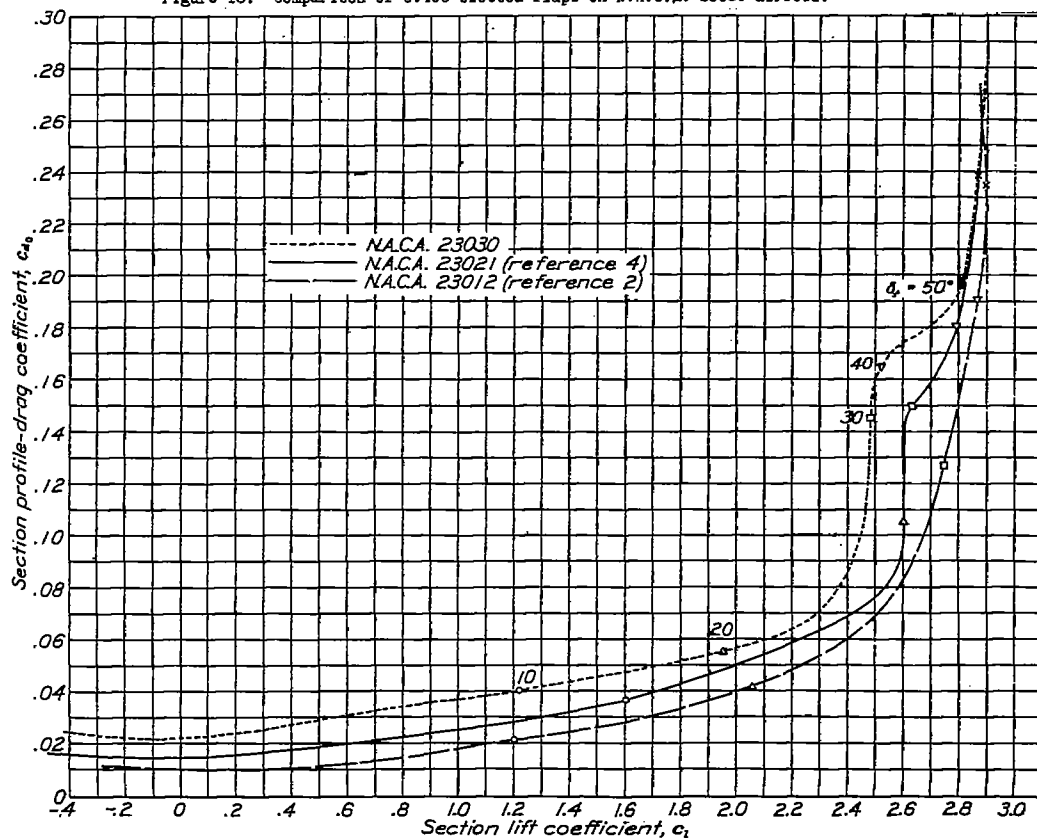

Figure 25.- Comparison of 0.40c slotted flap 1-b on N.A.C.A. 23030, 23021, and 23012 airfoils.

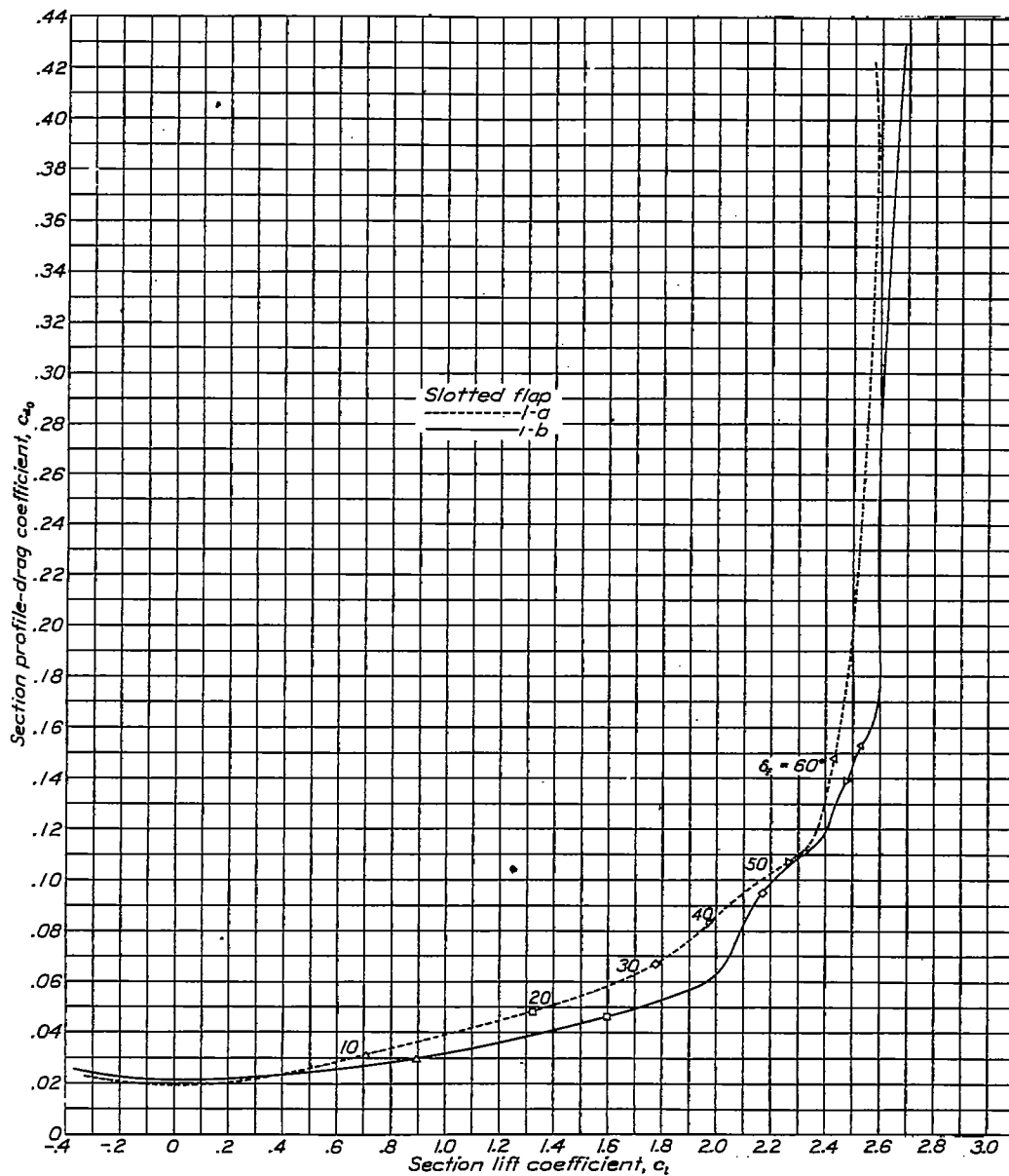

Figure 19.- Comparison of 0.2566c slotted flaps on N.A.C.A. 23030 airfoil.

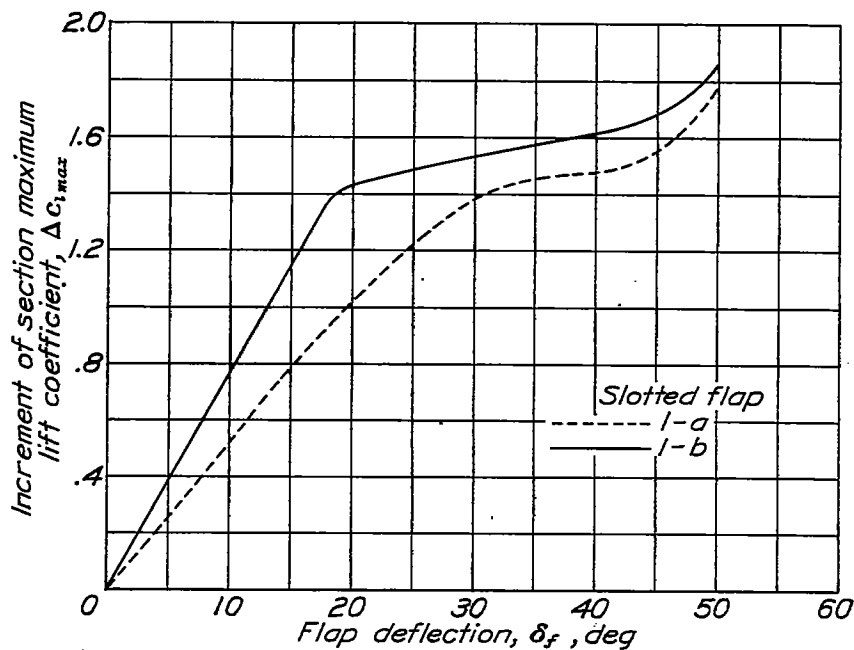

Figure 20.- Comparison of increments of section maximum lift coefficient for flaps 1-a and 1-b when moved and deflected along the selected optimum paths. The N.A.C.A. 23030 airfoil with 0.40c slotted flaps.

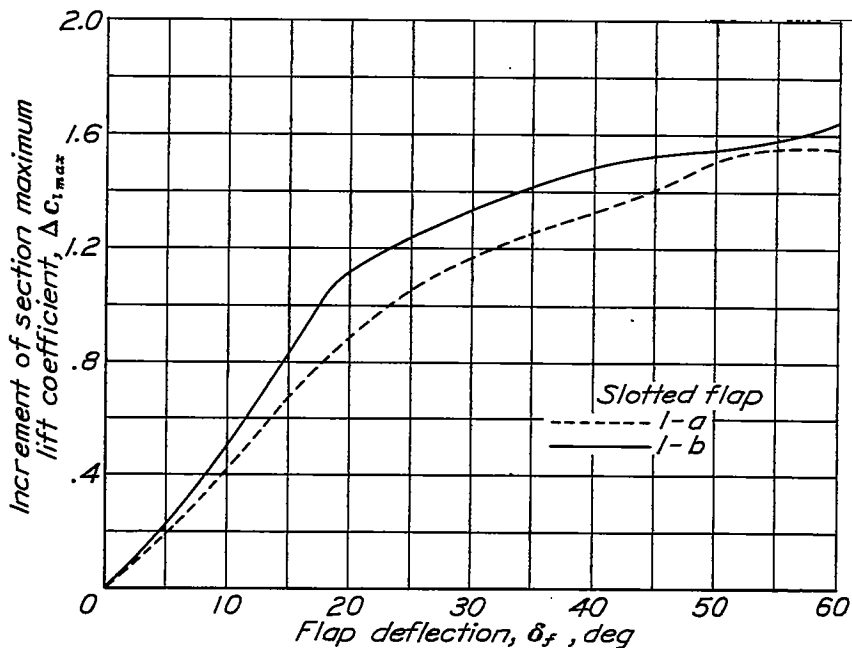

Figure 21.- Comparison of increments of section maximum lift coefficient for flaps 1-a and 1-b when moved and deflected along the selected optimum paths. The N.A.C.A. 23030 airfoil with 0.2566c slotted flaps.

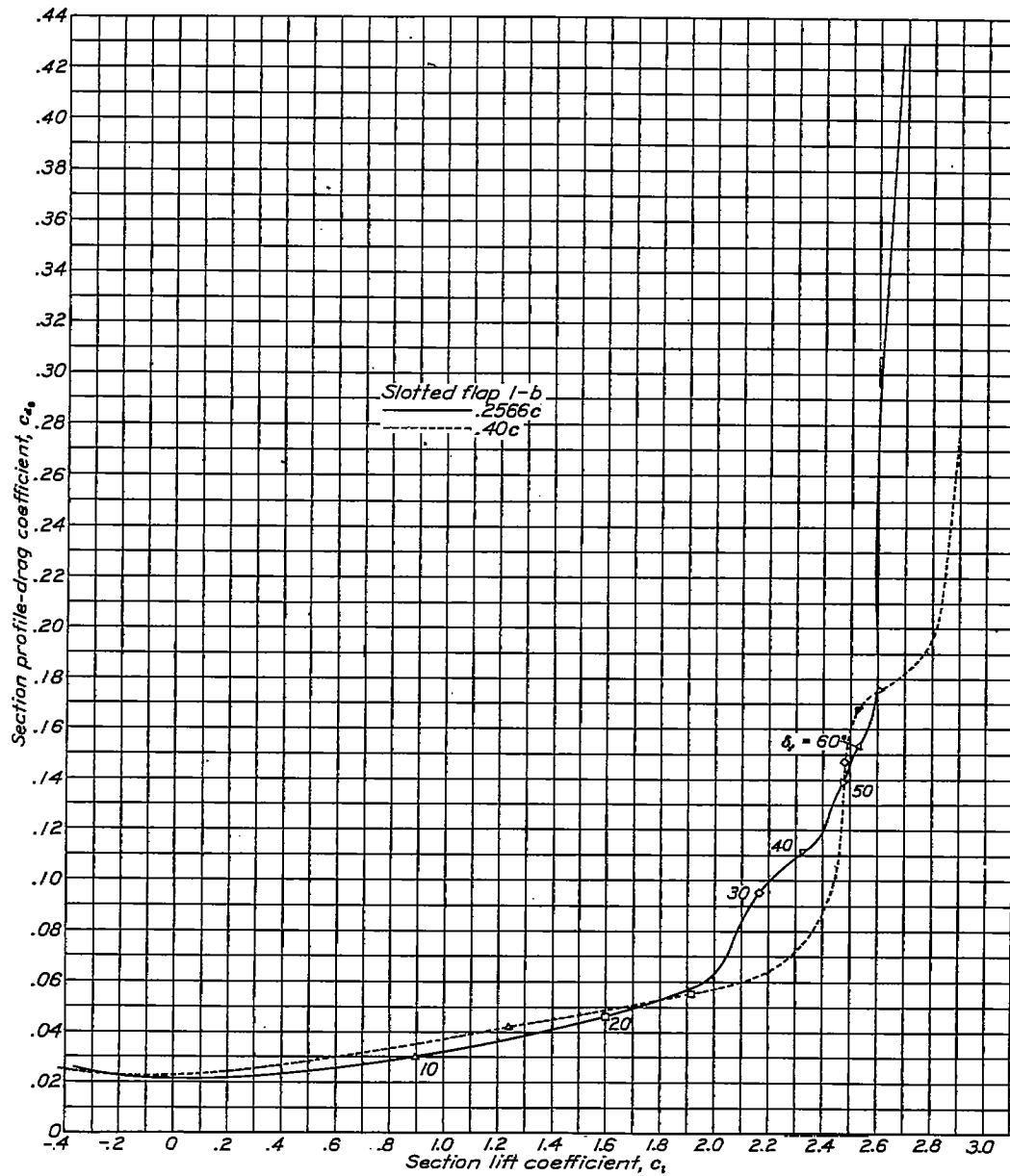

Figure 22.- Comparison of slotted flaps 1-b of different chords on N.A.C.A. 23030 airfoil.

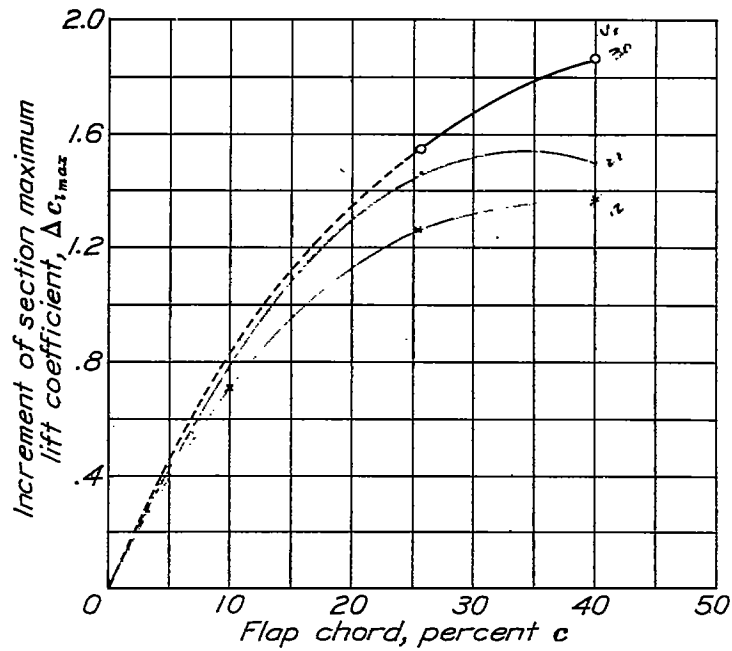

Figure 23.- Variation of increment of section maximum lift coefficient with flap chord. Slotted flaps 1-b on N.A.C.A. 23030 airfoil. $\delta_f = 50^\circ$

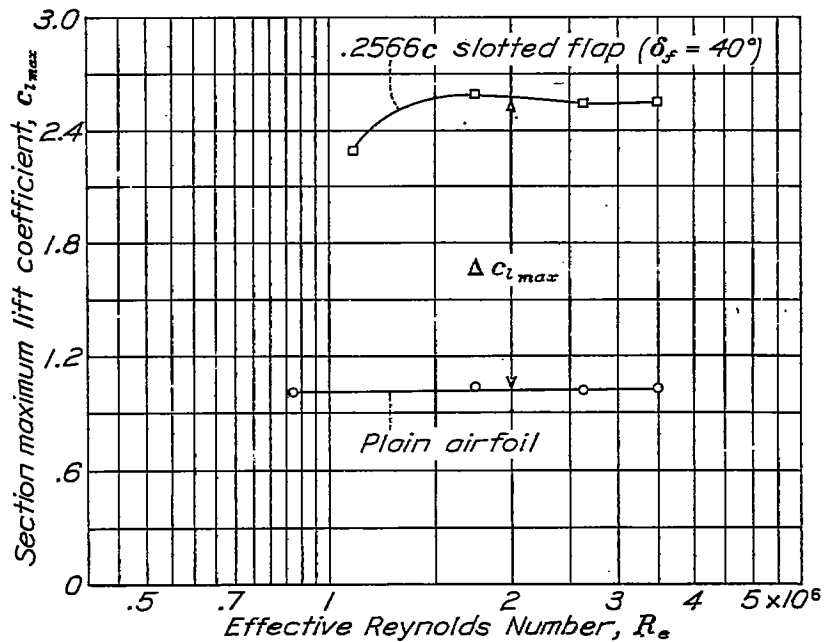

Figure 24.- Scale effect on section maximum lift coefficient for N.A.C.A. 23030 airfoil with and without 0.2566 c slotted flap 1-b.

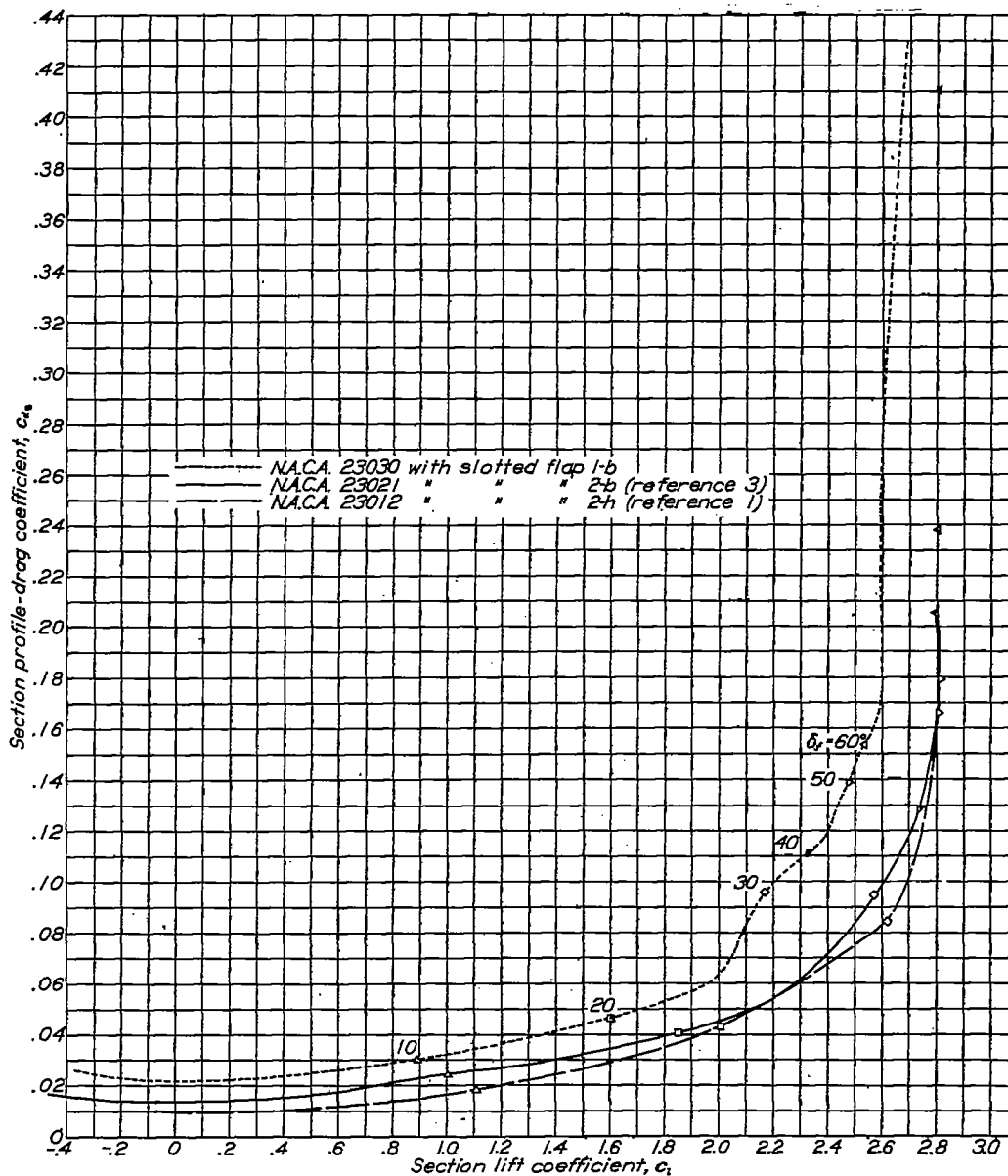

Figure 26.- Comparison of 0.2566c slotted flaps on N.A.C.A. 23012, 23021, and 23030 airfoils.

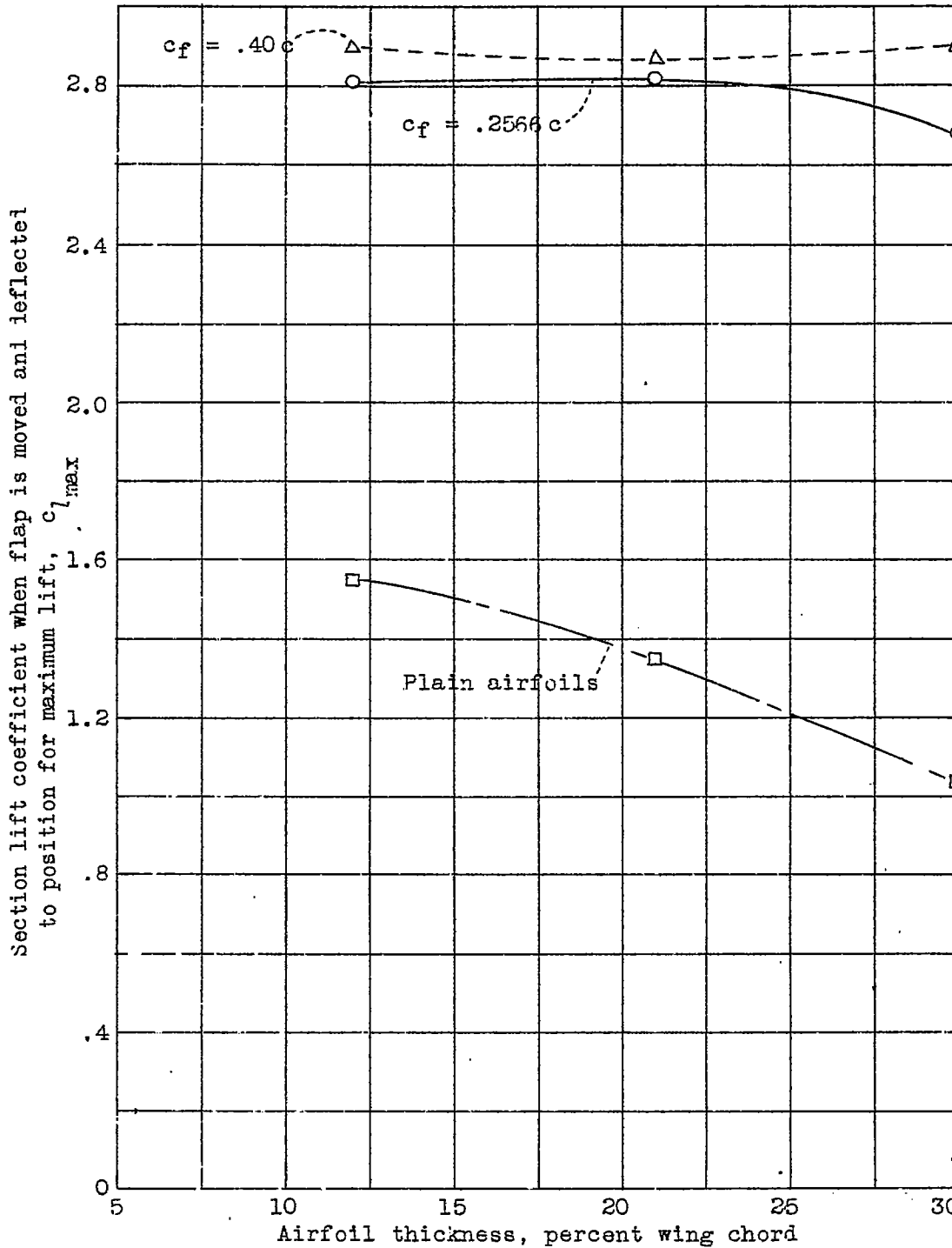

Figure 27.- Effect of airfoil thickness on maximum lift coefficient of N.A.C.A. 230 airfoils with and without slotted flaps.