

This document contains classified information affecting the National Defense of the United States within the meaning of the Espionage Act, USC 50:31 and 52. Its transmission or the revelation of its contents in any manner to an unauthorized person is prohibited by law. Information so classified may be imparted only to persons in the military and naval Services of the United States, appropriate civilian officers and employees of the Federal Government who have a legitimate interest therein, and to United States citizens of known loyalty and discretion who of necessity must be informed thereof.

TECHNICAL LIBRARY
ABBOTTAEROSPACE.COM

DEC 10 1940

NIA CIA

CLASSIFICATION CANCELLED

~~RESTRICTED~~

TECHNICAL NOTES

NATIONAL ADVISORY COMMITTEE FOR AERONAUTICS

*Review class. removed from file
from Dept. of Aeronautics
9-27-44*

No. 787

FACTORS AFFECTING HEAT TRANSFER IN
THE INTERNAL-COMBUSTION ENGINE

By P. M. Ku
Massachusetts Institute of Technology

Presented to
the Langley
Aeronautical
Laboratory.

Washington
December 1940

NATIONAL ADVISORY COMMITTEE FOR AERONAUTICS

TECHNICAL NOTE NO. 787

FACTORS AFFECTING HEAT TRANSFER IN
THE INTERNAL-COMBUSTION ENGINE

By P. M. Ku

SUMMARY

A method was developed for the direct measurement of the average heat-transfer coefficient from the gases in the cylinder during the cycle of operation of an internal-combustion engine. Experimental measurements were made with a heat collector projecting through a spark-plug hole into the combustion chamber of the test engine, in order to examine the effects of several engine-operating and design parameters on the mean heat transfer to the collector.

For an engine of a fixed compression ratio and valve timing, operating with a given mixture ratio, with ignition adjusted to give maximum pressure at the same crank-angle position, the mean heat transfer was found to be a function of the air consumption only, no matter what changes the volumetric efficiency, inlet-air density, or mean piston speed might undergo. The heat transfer was found to vary with the 0.5 power of air consumption in both a slow-speed and a high-speed C.F.R. engine. This figure was surprisingly constant for all tests.

The effect of the heat-resistive coating formed by the combustion deposits on the surface of the heat collector was also examined. Starting with a clean heat collector, the heat transfer fell about 20 percent during the first 15 hours of operation, after which it fell off at a very slow rate, becoming constant after about 40 hours of operation.

INTRODUCTION

There are several methods for evaluating heat losses in the internal-combustion engine. These methods may be broadly divided into two categories: one based upon the

thermodynamic analysis of indicator diagrams (references 1 and 2), and the other based upon the measurement of the total amount of heat absorbed by water jackets (references 3, 4, and 5) or cooling air (reference 6). The changes that actually occur in the engine cylinder are so complicated in nature that no method of theoretical analysis or experimental investigation may claim to have yielded entirely satisfactory results.

Investigators of the first category often contend that the direct measurement of heat absorbed by jacket water or cooling air has no actual bearing on the thermodynamics of the engine, as an unknown proportion of exhaust heat absorbed by the exhaust port and its surroundings, as well as the uncertain amount of piston-friction heat, inevitably creep into the measurement. This argument is quite correct. However, the analysis based upon the indicator diagram does not appear to give results which finally justify the amount of labor called for, and it does not give a good picture of the mechanism of heat transfer and factors controlling same, so that the practical application of such analysis is rather limited. It would be of great thermodynamic interest if sufficiently reliable indicator diagrams were obtainable at high speeds, so that instantaneous gas temperatures could be computed from these diagrams without serious error.

The present investigation is an attempt to evaluate the effects of air consumption, mean piston speed, mixture ratio, and compression ratio on the mean heat transfer from the hot gases to a heat collector screwed into the combustion chamber of the spark-ignition engine. Heat exchange between the cylinder walls and the heat collector was reduced to the possible minimum by the provision of a dead-air space around the heat collector, and by equalizing the temperatures of the two bodies. The interesting features of this arrangement are:

- (1) Heat transfer from the exhaust system was absent.
- (2) Heat transfer under conditions of sonic velocity during the exhaust "blow-down" period was almost completely absent.
- (3) Effect of piston-friction heat was almost completely excluded.

In other words, the heat transfer determined by this method corresponded to the loss during the thermodynamic cycle of operation. Also, the labor and inaccuracy of the indicator-diagram method was saved.

The author desires to take this opportunity to express his thanks to Professors C. F. Taylor and E. S. Taylor, of the Massachusetts Institute of Technology, for the advice and help they have rendered. He is also indebted to Professor A. R. Rogowski, Mr. W. A. Leary, and Mr. C. H. Wang for their assistance at various times.

GENERAL EQUATION OF HEAT TRANSFER

In the evaluation of the heat transfer from the hot cylinder gases to the cylinder, it is necessary to consider the relative proportions of heat transmitted by radiation and convection. An accurate estimation of radiation is extremely difficult (references 7, 8, 9, 10, 11, and 12); but from what is known it appears certain that the heat transfer due to radiation is very small. In the modern high-speed internal-combustion engine, in which heat transfer takes place mainly by forced convection, radiation may be taken as negligible.

For the heat transfer by means of forced convection, it may be shown (reference 13) that, for a given engine

$$Q = K_1 (T_g - T_w) L^2 (\rho s)^n \left(\frac{L}{\mu}\right)^{n-1} \quad (1)$$

where

- Q mean heat transfer per unit time
- T_g effective gas temperature
- T_w average cylinder-wall temperature
- ρ effective gas density
- μ effective gas viscosity (absolute)
- L a characteristic length of the engine
- s mean piston speed (2 S N)

- S stroke
- N engine speed
- K_1, n constants

Neglecting the variation in μ , which is probably small for ordinary operating conditions, equation (1) may be written

$$Q = K_2 L^{1+n} (\rho s)^n (T_g - T_w) \quad (2)$$

But

$$\rho = K_3 (e \rho_i)$$

Hence

$$\begin{aligned} Q &= K_4 (e \rho_i s)^n L^{1+n} (T_g - T_w) \\ &= K_4 (e \rho_i s L^2)^n L^{1-n} (T_g - T_w) \\ &= K_5 G^n L^{1-n} (T_g - T_w) \end{aligned} \quad (3)$$

where

- e volumetric efficiency*
- ρ_i inlet-air density
- G air consumption per unit time
- K_2, K_3, K_4, K_5 constants

It is of interest to note that the heat transfer from the hot gases to the cylinder is a function of air consumption, no matter what changes the volumetric efficiency, inlet-air density, or mean piston speed may undergo.

Equation (3) may be written in a more generalized form to include some of the important design and operating parameters:

* Volumetric efficiency is herein defined as the ratio of the weight of air actually taken into the cylinder to the weight of air which would fill the piston displacement at the inlet density.

$$Q = K_s G^n L^{1-n} (T_g - T_w) f(r, \alpha, \frac{F}{A}, \theta) \quad (4)$$

in which

f indicates an unknown function

r compression ratio

α valve timing

$\frac{F}{A}$ fuel-air ratio

θ ignition advance

In equation (4) the effect of the quantity θ is to alter the instantaneous values of gas temperature, gas pressure, gas density and viscosity, etc., all of which are functions of the indicator diagram. It will be noted with reference to figure 1 that for different engine-operating conditions the indicator diagrams are very similar in stroke if the ignition advance is set to give pressure peaks at the same crank-angle position. Thus the ignition advance giving the pressure peak at the same crank-angle position would appear to be the rational basis of comparison.

In other words, equation (3) is valid for geometrically similar engines of the same compression ratio and valve timing, operating with the same mixture ratio, with ignition adjusted to give maximum pressure at the same crank-angle position.

APPARATUS AND EXPERIMENTAL NOTES

This investigation covers tests on a slow-speed and a high-speed C.F.R. engine, of maximum permissible speeds of 1800 and 3600 rpm, respectively. In the slow-speed C.F.R. engine a constant mixture ratio could not be very well maintained in a 3-minute run, on account of the unsatisfactory fuel-supply system. In the high-speed C.F.R. engine, a rather elaborate scheme was employed, in which the fuel was injected into a vaporizing tank by means of a pump operating at 25 pounds per square inch supply pres-

sure. The injection nozzle was made to deliver fuel at a pressure of 1200 pounds per square inch, the spray angle being 12° and the atomization good. The fuel was then mixed with air in the vaporizing tank, which was steam-jacketed to insure good vaporization. With this arrangement it was possible to obtain an almost perfectly homogeneous mixture to be taken into the cylinder. Reference 14 contains a more complete description of the inlet system. The mixture remained constant for practically any length of time by keeping the fuel-supply pressure as well as the mixture temperature constant. Figure 2 shows the high-speed C.F.R. engine set-up, and figure 3 shows the view of the heat collector in position.

Heat collector.— Apart from the complication introduced by the exhaust heat and the piston-friction heat, difficulty was experienced by previous investigators with direct measurement of heat given up to the jacket water. Considerable difficulty was found in keeping the engine-jacket temperature constant. When the rate of flow of water was made large enough to give a steady temperature rise, the temperature rise was too small for a reasonably accurate estimation of heat transfer. If, on the other hand, the rate of water circulation was made sufficiently small, steam "pockets" were formed in the jacket which disturbed the temperature readings.

This difficulty was overcome by the use of a heat collector shown sectionally in figure 4. A quite similar arrangement had been employed 14 years ago for heat measurement during motoring tests (reference 3); but for reasons obscure to the present author the work was not carried further to power runs. In its present version the heat collector consists mainly of two concentric steel tubes, put together by a suitable supporting element. Joints were made watertight by press fitting. No brazing or welding was used.

The heat collector was then screwed into the combustion chamber of the engine under test through a spark-plug hole. Cold water was made to enter the inner tube, while hot water ran out from the outer tube. The rate of heat transfer was determined by measuring the weight of circulating water as well as the inlet and outlet water temperatures.

The area of the portion of heat collector exposed to the hot gases was 3.75 square inches and its volume, 0.44

cubic inch. Owing to the volume taken up by the heat collector the compression ratio of the engine was altered. A calibration curve for the various compression ratios covered by the experiment is given in figure 5.

In order to guard against heat exchange between the heat collector and the cylinder walls, a dead-air space was provided in the supporting part of the heat collector. Clearly, a complete absence of metallic contact was not possible, and the air in the dead-air space was not really "dead" in the sense that small-scale turbulence always existed, hence reducing the effective heat insulation of the air space. As a necessary precaution the temperatures of the water jacket and the heat-collector outlet were adjusted to the same value throughout the experiment, except in the first 40 hours of preliminary runs, in order to eliminate heat transfer from the supporting part of the collector.

It was remarked that when steam pockets were formed, the temperature readings became very unsteady, because the formation of steam bubbles caused the heat-transfer characteristics to change considerably. In the present work water was kept circulating without stagnation points, and the outlet temperature of the heat collector was kept below 150° F. There was no evidence of steam formation. A sufficiently large temperature rise was obtainable, yet the temperature fluctuation was only of the order of $\pm 0.5^\circ$ F in a 3-minute run, corresponding roughly to a half-percent error. Even when the heat-collector outlet temperature was raised to 180° F, no greater temperature fluctuation was observed.

Temperature control. The scheme for the control of temperature is shown in figure 6. The effective head of water in the supply tank was maintained constant, and the rate of flow was adjusted by a needle valve. An extremely fine control of temperature was obtainable. The engine-jacket water was circulated by means of a centrifugal pump, cold water being admitted for temperature adjustment. With this arrangement, the engine-jacket temperature could be maintained at $\pm 3^\circ$ F from the heat-collector outlet temperature in a 3-minute run.

In a work of this kind, it is imperative that a perfect temperature equilibrium be reached prior to taking formal readings. From 1 to 1½ hours would generally be required for an engine starting from cold. About 15 min-

utes were allowed when engine conditions had been altered. The oil temperature was not specially controlled but was always around 140° F.

Air measurement.-- In this work an NACA Roots-type supercharger was used as an air meter. Calibration against a Durley orifice showed that one revolution of the meter corresponded to 0.180 cubic foot of air. Surging in the intake system was suppressed by a surge tank of sufficient capacity.

Fuel-air-ratio measurement.-- The mixture ratio was normally taken from a Cambridge Exhaust-Gas Analyzer. In tests in which mixture ratio was important, the fuel and air were timed and the mixture ratio was computed.

On the high-speed C.F.R. engine set-up, an electrical device was provided for taking the fuel and air readings simultaneously.

The Cambridge analyzer was found to give readings sufficiently accurate for most purposes.

Speed measurement.-- The engine speed was read by a hand tachometer in tests on the slow-speed C.F.R. engine. A Strobotac operating from a controlled 60-cycle line, was used on the high-speed C.F.R. engine (reference 14).

Procedure.-- The major factors, the effect of which were to be examined, were: volumetric efficiency, inlet-air density, and mean piston speed. Trials were accordingly made with

- (1) Constant s and varying $(e \rho_1)$: by throttling the engine while the engine speed was held constant.
- (2) Constant ρ_1 and varying $(e s)$: by keeping the same inlet-air density while the engine speed was varied.
- (3) Constant $(e \rho_1)$ and varying s : by throttling the engine in such a way that the air consumption per stroke was the same.
- (4) Varying s , e , and ρ_1 : by varying engine speed and engine throttle at random.

The effect of volumetric efficiency alone was not separately examined, owing to the fact that it could not be varied over a sufficiently wide range without having affected the inlet-air density at the same time.

The ignition advance was adjusted to give best power in all runs except those where it was intentionally varied. The best-power-ignition advance was found to give consistently a pressure peak at from 12° to 15° after top dead center. Tests thus made were therefore on a rational basis of comparison.

The effects of mixture ratio, ignition advance, and compression ratio were also examined from a dimensional standpoint.

It is seen from equation (4) that, in order to evaluate the effect of one parameter alone, it is necessary to keep all the other parameters constant. For example, in order to examine the effect of the mean piston speed or engine speed, it is not sufficient to keep the inlet-air density constant. Account must also be taken of the variation of volumetric efficiency. In order to examine the effect of mixture ratio, ignition advance, or compression ratio, it is not sufficient to keep the mean piston speed constant; the air consumption must be kept constant so as to make the comparison dimensionally correct. It has appeared to the writer that some authorities have failed to take notice of this point.

RESULTS AND DISCUSSIONS

This report outlines the conditions of heat transfer corresponding to the thermodynamic cycle of operation in a particular region in the engine cylinder. The conditions of heat transfer in another region will necessarily assume a different magnitude but will, it is believed, follow a similar trend.

It will also be seen immediately that there was a remarkable agreement between tests on the slow-speed and the high-speed C.F.R. engine. This fact may be attributed to the similarity in engine design. Whether it will be so in engines of entirely different designs cannot be stated without experimental verification. Nevertheless, as the problem is related to the thermodynamic cycle only, it appears reasonable to expect a materially similar trend.

Heat transfer by radiation.— The heat collector was completely chromium-plated in order to determine if radiation from the hot gases could be measured. It was at first thought that if the heat transfer became greater as soot and lead oxides were deposited on the polished tube surface, the difference in heat transfer could be attributed to radiation. Subsequently no such indication was observed. It may be concluded that radiation heat transfer was at least smaller than the experimental error.

Effect of heat-resistive coating.— In lieu of the trend as suspected, the mean heat transfer was found to decline very decidedly as a result of these coatings. This tendency is shown in figure 7, in which the heat flow per unit time is plotted against hours of operation for the same amount of air flow. This tendency was found to have practically ceased after 40 hours of operation. The coating was 0.002 inch in thickness after about 80 hours of operation.

Effect of mixture ratio.— The effect of mixture ratio on the mean heat transfer is shown in figures 8 and 9. This effect is plainly due to the change in gas temperature, for in equation (4), r , α , and θ do not enter because these parameters were kept under dimensionally correct basis, G was a constant by adjustment, and L for the heat collector, was also a constant.

The maximum heat transfer was found to occur with a fuel-air ratio of 0.074, or with a mixture approximately 7 percent richer than chemically correct, which corresponds to the mixture ratio giving maximum gas temperature.

Effect of ignition advance.— By a similar argument the effect of ignition advance may also be attributed to the change of gas temperature. The relation between the mean heat transfer and ignition advance is shown in figures 10 and 11, for the slow-speed and the high-speed C.F.R. engines, respectively. The experiment covered a range of ignition advance from 0° to 50° crank angle. It was not possible to advance the ignition to more than 50° , as preignition set in and the engine ran very irregularly. At 50° ignition advance the engine missed fire once in about 12 power strokes.

Effect of compression ratio.— Figures 12 and 13 show that a slight increase in mean heat transfer accompanied an increase in compression ratio. An increase in compres-

sion ratio is known to raise the compression temperature and the flame temperature slightly and to lower the expansion temperature and the exhaust temperature to a greater extent. Hence the total effective heat transfer from the engine and its exhaust system is ordinarily found to decrease with an increase in compression ratio. In this investigation, however, the heat transfer from the exhaust system was largely absent. Therefore, it is logical that the mean heat transfer was found to increase slightly with an increase in compression ratio.

Effect of throttling.— The effect of throttling, as shown in figure 14, can be readily explained by equation (4). Throttling decreases the flame temperature and the expansion temperature slightly and increases the compression temperature to a greater extent. The net effect of throttling on the term $(T_g - T_w)$, is probably small. The variation of the mean heat transfer with throttling may be mainly ascribed to the effect of change in density, which in turn affects the air consumption. The exponent n was found to be very nearly 0.5.

Effect of mean piston speed.— From equation (3) it is clear that the effect of mean piston speed on the mean heat transfer is the same as that of air consumption when the volumetric efficiency and inlet-air density are kept constant. The exponent n was also very nearly 0.5. (See fig. 15.)

Effect of air consumption.— Figures 16 and 17 show the relation between the mean heat transfer and the air consumption when the volumetric efficiency, mean piston speed, and inlet-air density are varied at random, as well as the compression ratio. Some results from the first 40 hours of preliminary runs are also included to show that while the heat-resistive coating affected the absolute magnitude of heat transfer, it did not alter the relation between heat transfer and air consumption. The value of the exponent n was remarkably consistent and was always of the order of 0.5.

CONCLUSIONS

(1) The method described here enables one to measure the mean heat transfer corresponding to the thermodynamic cycle of operation of the internal-combustion engine directly and with a fair degree of accuracy.

(2) From the hot gases to the cylinder walls, heat transfer may take place by radiation and forced convection. The heat transfer due to radiation could not be detected in this experiment.

(3) The mean heat transfer in a given cylinder due to forced convection, may be expressed by the equation

$$Q = K G^n L^{1-n} (T_g - T_w) f(r, \alpha, \frac{P}{A}, \theta)$$

The mean heat transfer is a function of the air consumption, no matter what changes the volumetric efficiency, inlet-air density, or mean piston speed may undergo. The exponent n was found to be of the order of 0.5 for the two engines tested, and was very consistent.

(4) The mean heat transfer was found to be a maximum with a mixture about 7 percent richer than chemically correct. It increased with the ignition advance at a gradually increasing rate until the engine ceased to run regularly. It also increased slightly as the compression ratio was raised.

Massachusetts Institute of Technology,
 Cambridge, Mass., September 1940.

REFERENCES

1. Janeway, R. N.: Interpretation of the Indicator Card. S.A.E. Jour., Nov. 1929.
2. Lanchester, F. W.: The Energy Balance Sheet of the Internal Combustion Engine. Jour. and Proc. Inst. of Mech. Eng'rs, June 1939.
3. Moss, H.: Heat Transfer in Internal Combustion Engines. R. & M. No. 1129, British A.R.C., 1928.
4. Taylor, C. F.: Distribution of Heat Loss to the Jackets in an Internal Combustion Engine Cylinder. Jour. of the Aeronautical Sciences, June 1936.
5. Janeway, R. N.: Quantitative Analysis of Heat Transfer in Engines. S.A.E. Jour., Sept. 1938.

6. Pinkel, B.: Heat-Transfer Processes in Air-Cooled Engine Cylinders. Rep. No. 612, NACA, 1938.
7. Nusselt, W.: Der Wärmeübergang in der Verbrennungskraftmaschine. Z.V.D.I., July 14, and July 21, 1923.
8. Nusselt, W.: Der Wärmeübergang in der Dieselmachine. Z.V.D.I., April 3, 1926.
9. Steele, S., Wharton, A., and Roeder, C. H.: Infra-Red Radiations from Otto-Cycle Engine Explosions. Engineering, Jan. 1936.
10. Steele, S.: Infra-Red Radiations from Otto-Cycle Engine Explosions. Engineering, March 1936.
11. Bisang, L.: Ausstrahlung des Verbrennungsraumes schnelllaufender Diesel- und Otto-motoren. Untersuchung mit einer ultrarot-empfindlichen Photozelle. Z.V.D.I., July 3, 1937.
12. Stambuleanu, A.: Der Wärmeaustausch durch Strahlung zwischen den inneren Zylinder-flächen eines schnelllaufender Viertakt-Vergasermotors als Funktion der mittleren Kolbengeschwindigkeit. A.T.Z., June 1939.
13. Taylor, C. F., and Taylor, E. S.: The Internal Combustion Engine, p. 131. International Textbook Co., Scranton, Pa., 1938.
14. Taylor, E. S., Leary, W. A., and Diver, J. R.: Effect of Fuel-Air Ratio, Inlet Temperature, and Exhaust Pressure on Detonation. Rep. No. 699, NACA, 1940.

APPENDIX

HEAT TRANSFER AND ENGINE OUTPUT

It can be shown that the indicated horsepower, I , of an internal-combustion engine may be expressed

$$I = K_6 G f_1 \left(r, \alpha, \frac{F}{A}, \theta \right) \quad (5)$$

For geometrically similar engines of the same compression ratio and valve timing, operating with the same mixture ratio, with ignition adjusted to give maximum pressure at the same crank-angle position, the indicated horsepower is proportional to the air consumption.

Figure 18 shows the relation between the indicated horsepower and the air consumption for the slow-speed C.F.R. engine at three different compression ratios with optimum mixture ratio and ignition advance. There was no valve overlap and the valve timing was the same for the three cases.

Comparing equations (4) and (5),

$$\begin{aligned} \frac{Q}{I} &= K_7 G^{n-1} L^{1-n} (T_g - T_w) f_2 \left(r, \alpha, \frac{F}{A}, \theta \right) \\ &= K_7 (e \rho_1 s)^{n-1} L^{n-1} (T_g - T_w) f_2 \left(r, \alpha, \frac{F}{A}, \theta \right) \quad (6) \end{aligned}$$

Thus for a given engine the mean heat transfer expressed as a fraction of the indicated output decreases as the output increases. For geometrically similar engines, it decreases as the engine size increases. For geometrically similar engines running at the same piston speed with the same inlet-air density, (Q/I) is proportional to (L^{n-1}) and $(T_g - T_w)$, provided the function f_2 remains unchanged.

Curve	F/A	Load factor	s, ft/min
a	Optimum	3/4	600
b	0.091	-	900
c	0.080	-	900
d	-	-	900

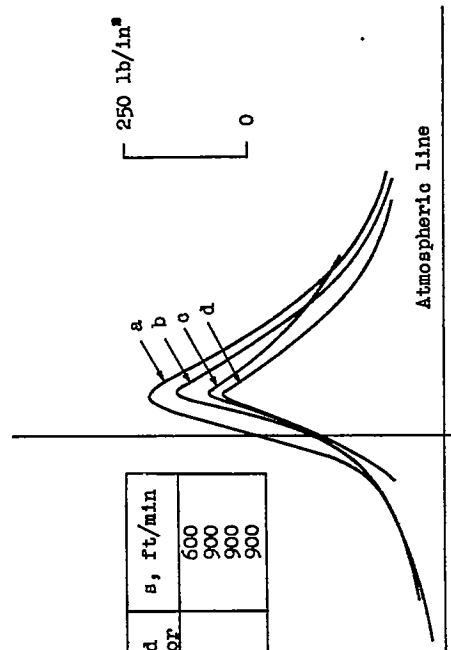

Figure 1.- Indicator diagrams with the best-power ignition advances. 100 octane fuel; slow-speed C. F. R. engine.

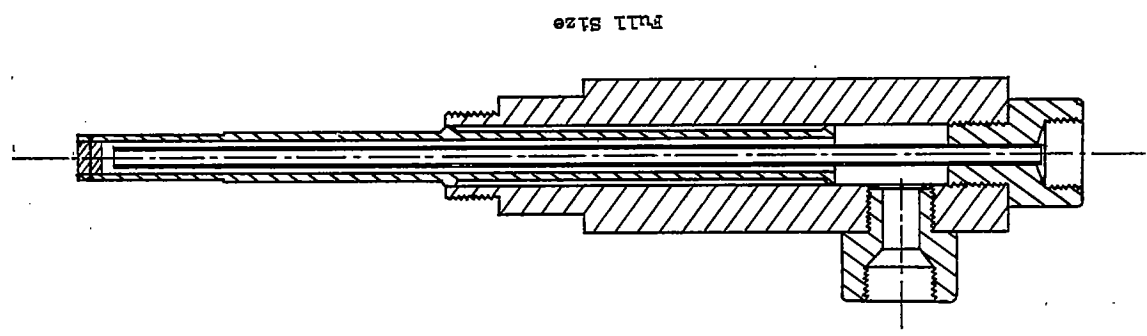

Figure 4. - The heat collector.

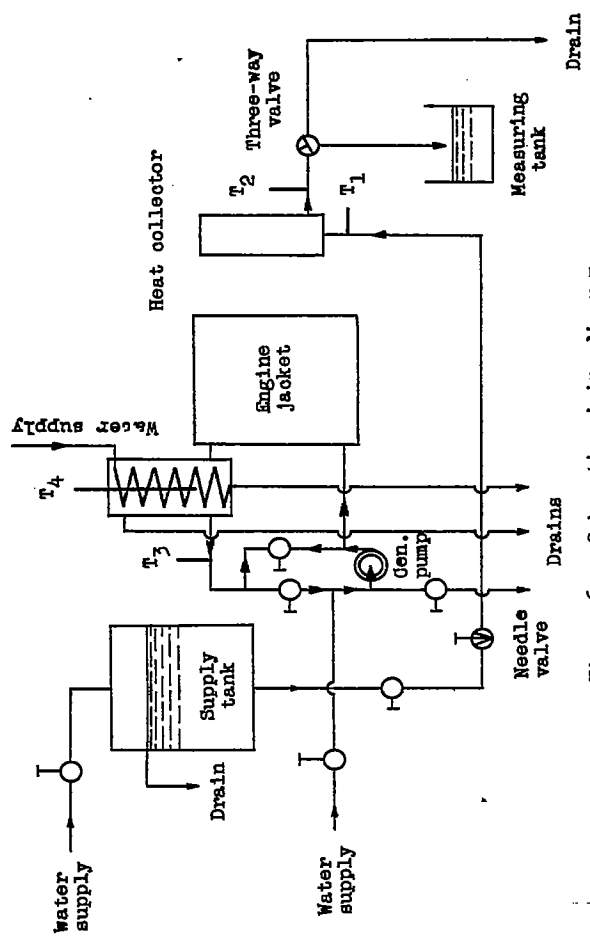

Figure 6. - Schematic piping diagram.

NACA Technical Note No. 787

Figs. 2,3

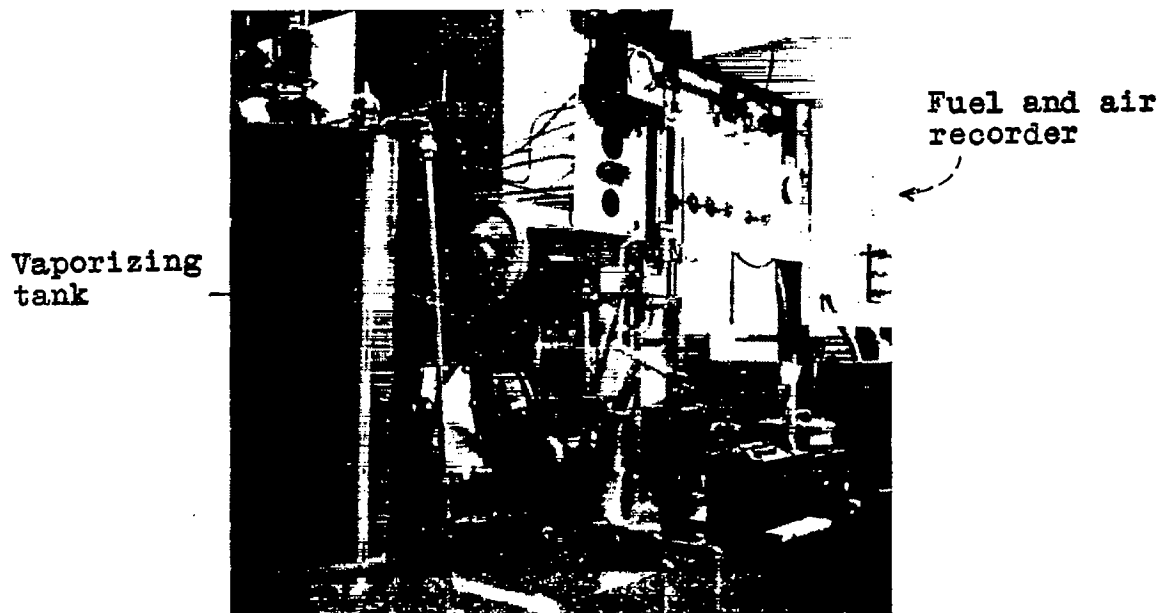

Figure 2. - The high-speed C. F. R. engine set-up, showing the vaporizing tank and the electrical fuel- and air- recording device.

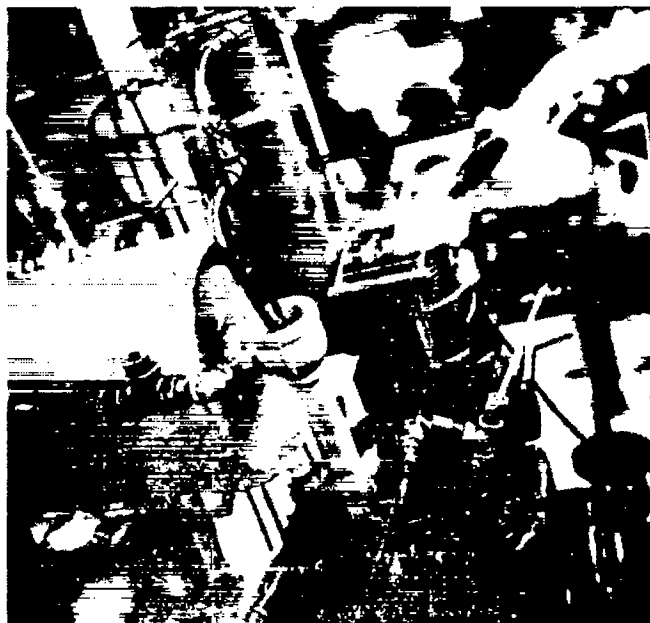

Figure 3. - View of the heat collector in position.

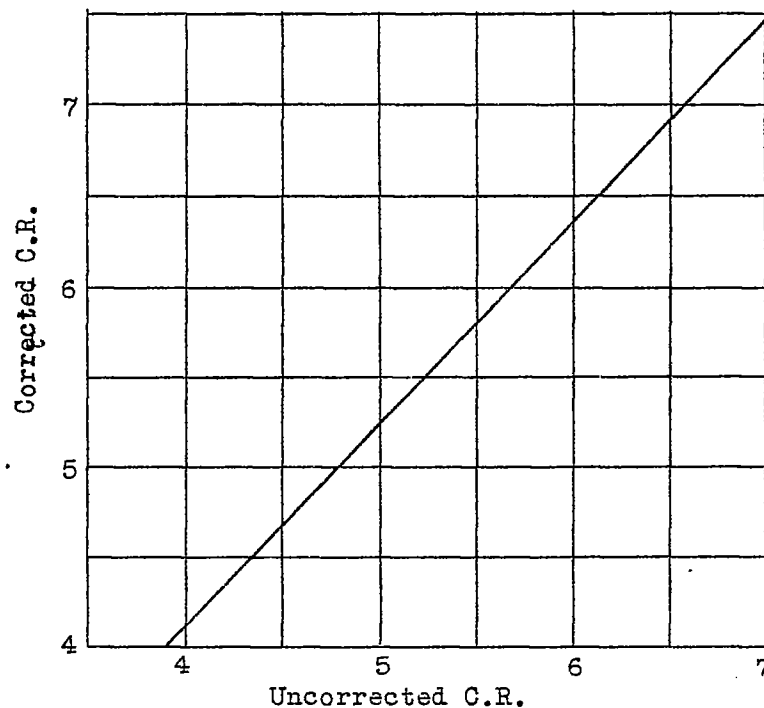

Figure 5.- Corrected compression ratio after insertion of the heat collector.

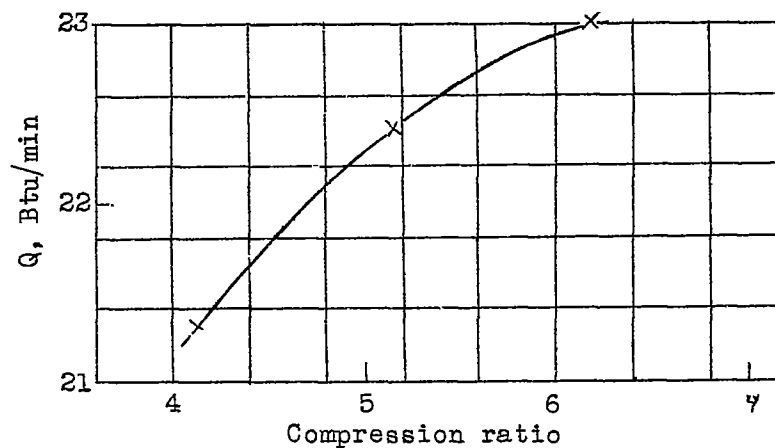
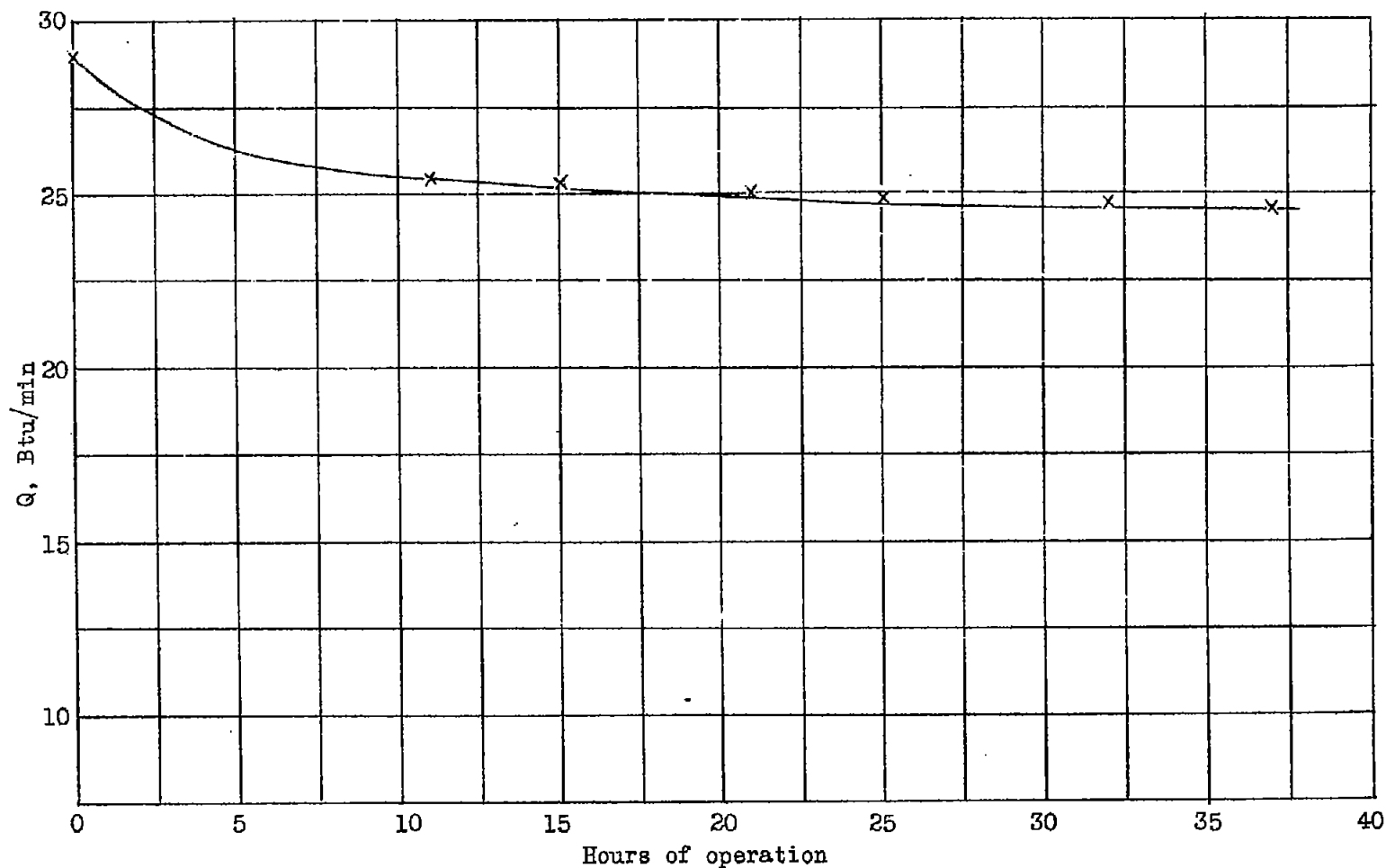

Figure 12.- Variation of heat transfer with compression ratio.
100 octane fuel; optimum θ ; $F/A = 0.0757$; $G = 0.80$
lb/min; $T_2 = 145^\circ\text{F.}$; $T_3 = 145^\circ\text{F.}$; slow-speed C.F.R. engine.



NACA Technical Note No. 787

Figure 7.- Effect of heat-resistive coating on heat transfer. Compression ratio = 5.15; optimum F/A and θ ; 87 octane fuel; $G = 0.80$ lb/min; $T_2 = 90^\circ\text{F.}$; $T_3 = 210^\circ\text{F.}$; slow-speed C.F.R. engine.

Fig. 7

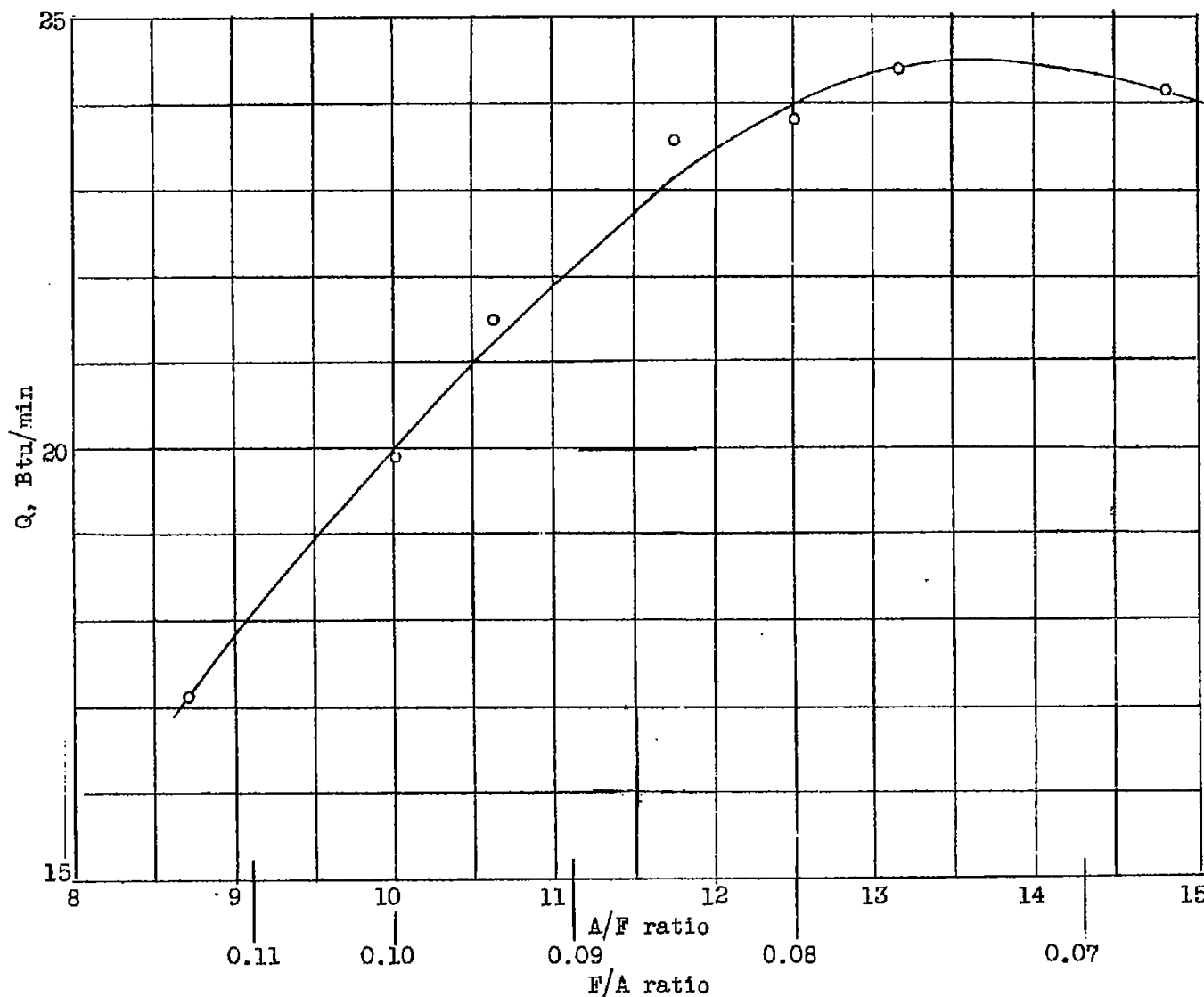

Figure 8.- Variation of heat transfer with mixture ratio. Slow-speed C.F.R. engine; compression ratio = 5.15; optimum θ ; 87 octane fuel; $s = 915$ ft/min; $G = 0.83$ lb/min; $T_2 = 150^\circ\text{F}$; $T_3 = 150^\circ\text{F}$.

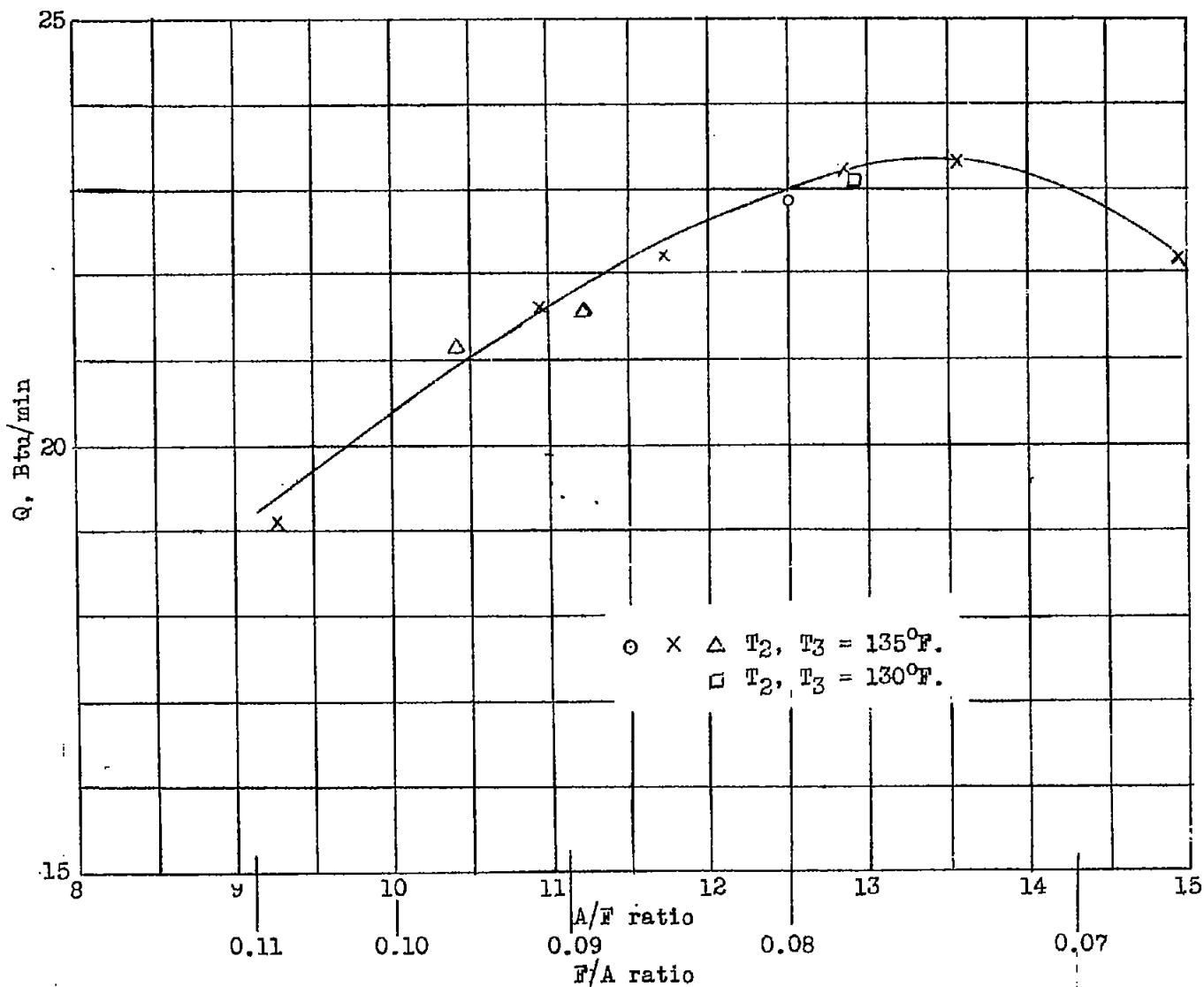

Figure 9.- Variation of heat transfer with mixture ratio. High-speed C.F.R. engine; compression ratio = 5.10; optimum θ ; 100 octane fuel; $s = 900$ ft/min; $G = 0.76$ lb/min.

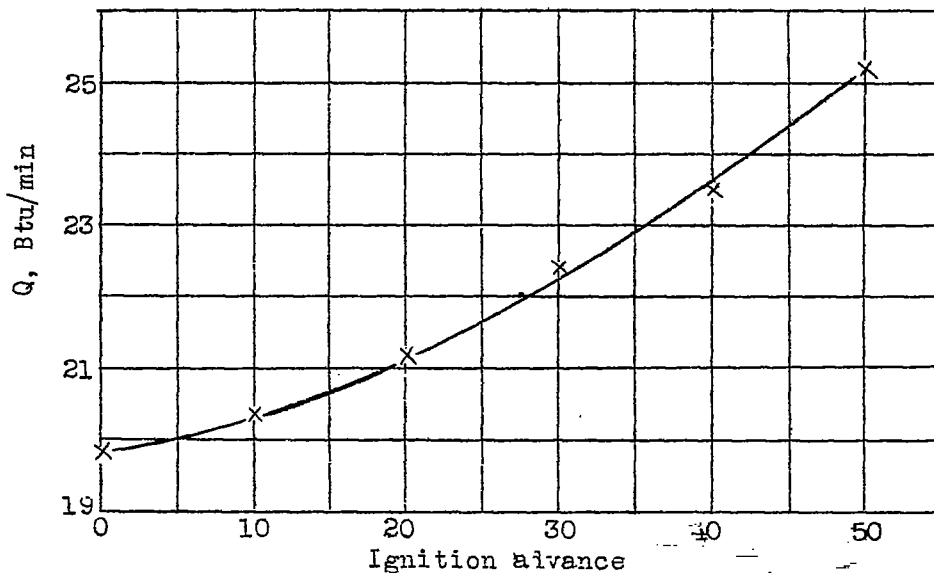

Figure 10.- Variation of heat transfer with ignition advance.
 Slow-speed C.F.R. engine; compression ratio = 5.15;
 100 octane fuel; $F/A = 0.074$; $s = 915$ ft/min; $G = 0.83$ lb/min;
 $T_2 = 150^\circ\text{F.}$; $T_3 = 150^\circ\text{F.}$

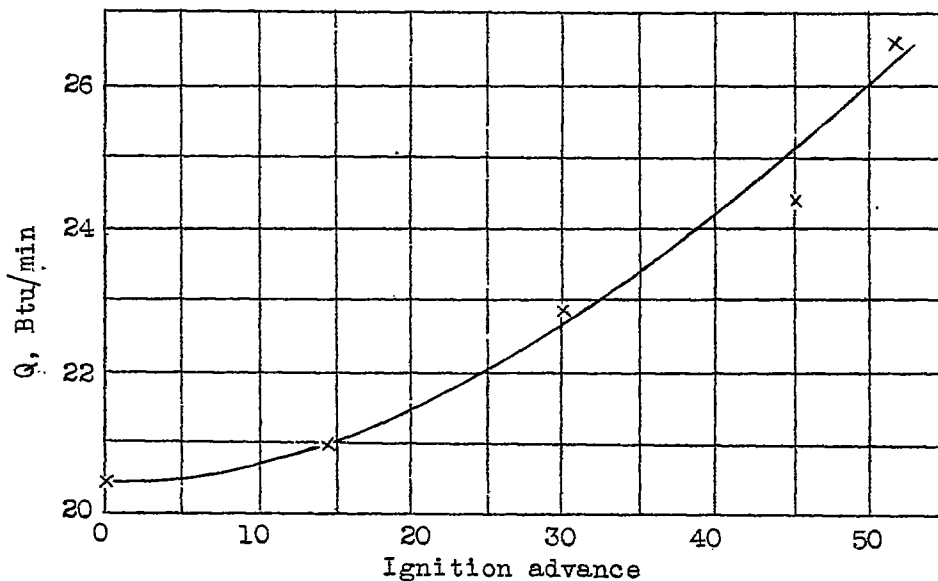

Figure 11.- Variation of heat transfer with ignition advance.
 High-speed C.F.R. engine; compression ratio = 5.10;
 100 octane fuel; $F/A = 0.080$; $s = 900$ ft/min; $G = 0.76$ lb/min;
 $T_2 = 130^\circ\text{F.}$; $T_3 = 130^\circ\text{F.}$

MACA Technical Note No. 787

Figs. 13, 15, 16

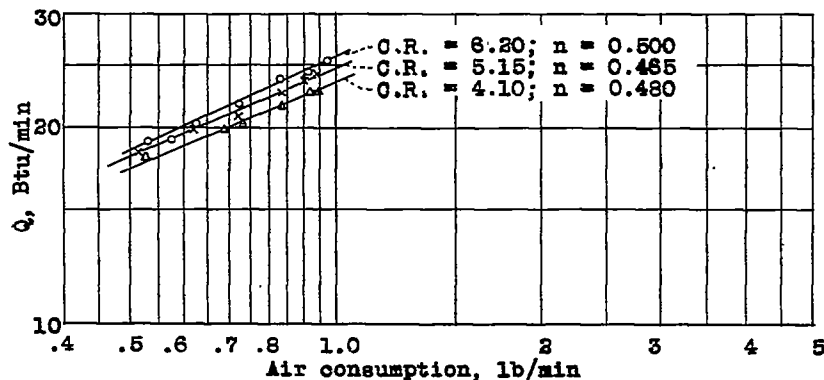

Figure 13.- Variation of heat transfer with compression ratio. 100 octane fuel; optimum θ ; $F/A = 0.0757$; $T_2 = 145^\circ F$; $T_3 = 145^\circ F$; slow-speed C.F.R. engine.

Curve (No.)	C.F.R. engine	C.R.	$T_2, ^\circ F$	$T_3, ^\circ F$	Fuel	Hours of operations
4	Slow	5.15	210	90	87	11
5	Slow	5.15	210	90	87	15
18	Slow	5.15	150	150	100	Over 40
25	High	5.10	140	140	100	Over 40

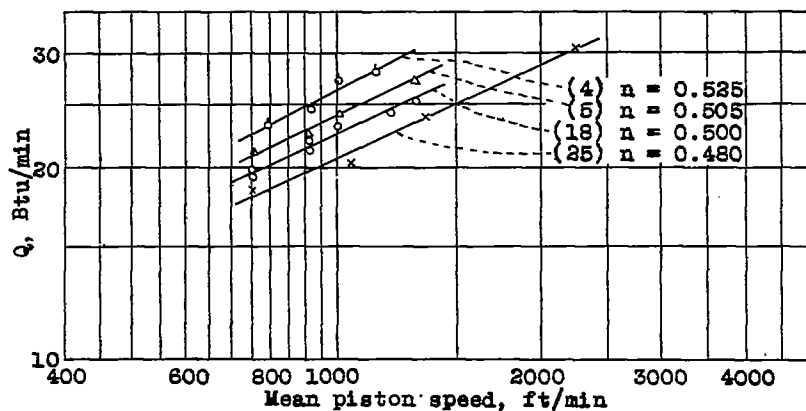
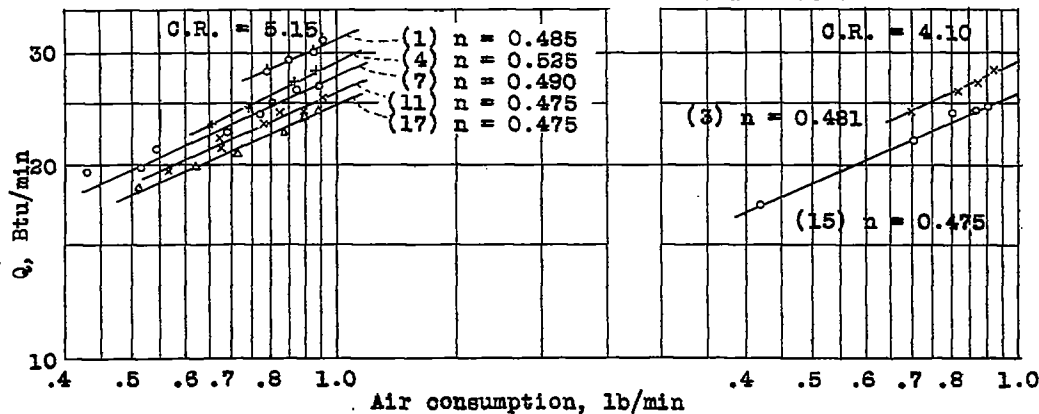

Figure 15.- Variation of heat transfer with mean piston speed. Optimum F/A and θ ; varying mean piston speed.

Curve No.	C.R.	F/A	$T_2, ^\circ F$	$T_3, ^\circ F$	Hours of operation
1	5.15	0.080	212	90	0
3	4.10	0.080	212	90	7
4	5.15	0.080	212	90	11
7	5.15	0.080	212	90	21
11	5.15	0.078	212	150	35
15	4.10	0.078	150	150	Over 40
17	5.15	0.078	150	150	Over 40

Figure 16.- Variation of heat transfer with air consumption. Slow-speed C.F.R. engine; varying (e_s), (e_{p1}), T_2 and T_3 ; optimum θ ; 97 or 100 octane fuel.



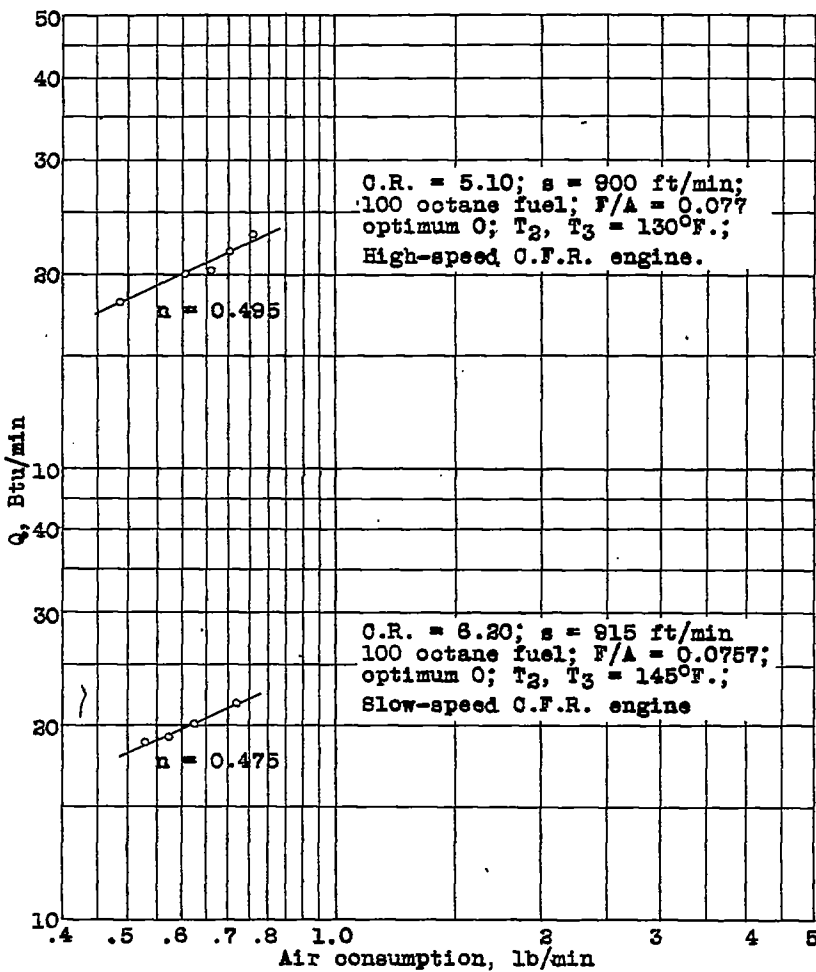

Figure 14.- Variation of heat transfer with air consumption due to effect of throttling at constant piston speed.

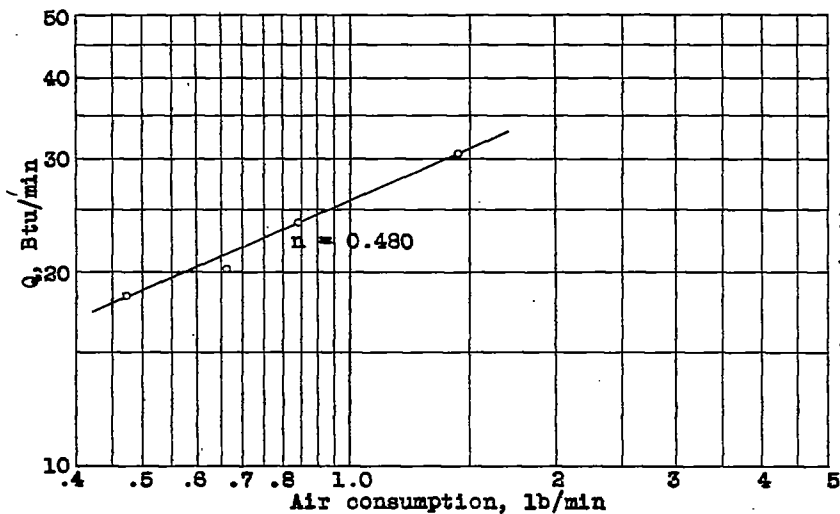

Figure 17.- Variation of heat transfer with air consumption. High-speed C.F.R. engine; optimum F/A and θ ; C.R. = 5.10; $T_2 = 140^\circ\text{F.}$; $T_3 = 140^\circ\text{F.}$

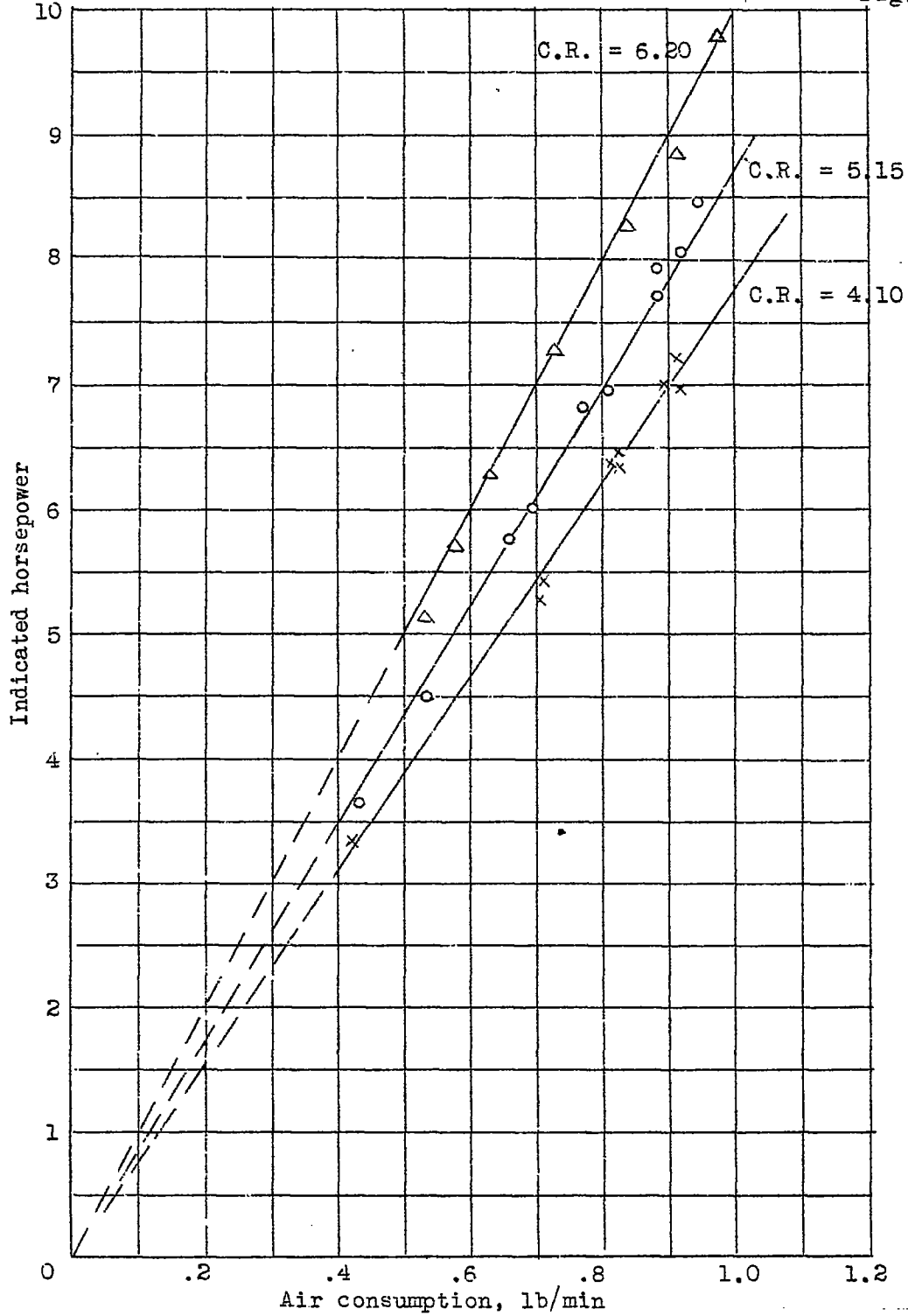

Figure 18.- Variation of indicated horsepower with air consumption. Optimum F/A and θ ; varying s , e , and p_1 ; slow-speed C.F.R. engine.