

853

L. H. L.
Structure Research Section

THIS DOCUMENT PROVIDED BY THE ABBOTT AEROSPACE
TECHNICAL LIBRARY
ABBOTT AEROSPACE.COM

RESTRICTED

TECHNICAL NOTES

NATIONAL ADVISORY COMMITTEE FOR AERONAUTICS

No. 853

LIBRARY COPY

JUL 9 1942

LANGLEY RESEARCH CENTER
LIBRARY, NASA
HAMPTON, VIRGINIA

BENDING WITH LARGE DEFLECTION OF A CLAMPED RECTANGULAR PLATE
WITH LENGTH-WIDTH RATIO OF 1.5 UNDER NORMAL PRESSURE

By Samuel Levy and Samuel Greenman
National Bureau of Standards

CLASSIFIED DOCUMENT

This document contains classified information affecting the National Defense of the United States within the meaning of the Espionage Act, USC 50:31 and 32. Its transmission or the revelation of its contents in any manner to an unauthorized person is prohibited by law. Information so classified may be imparted only to persons in the military and naval Services of the United States, appropriate civilian officers and employees of the Federal Government who have a legitimate interest therein, and to United States citizens of known loyalty and discretion who of necessity must be informed thereof.

FOR REFERENCE

Washington
July 1942

NOT TO BE TAKEN FROM THIS ROOM

NATIONAL ADVISORY COMMITTEE FOR AERONAUTICS

TECHNICAL NOTE NO. 853

BENDING WITH LARGE DEFLECTION OF A CLAMPED RECTANGULAR PLATE
WITH LENGTH-WIDTH RATIO OF 1.5 UNDER NORMAL PRESSURE

By Samuel Levy and Samuel Greenman

SUMMARY

The Von Karman equations for a thin flat plate with large deflections are solved for the special case of a plate with clamped edges having a ratio of length to width of 1.5 and loaded by uniform normal pressure. Center deflections, membrane stresses, and extreme-fiber bending stresses are given as a function of pressure for center deflections up to twice the thickness of the plate. For small deflections the results coincide with those obtained by Hencky from the linear theory.

The maximum stresses and center deflection at high pressures differ less than 3 percent from those derived by Boobnov for an infinitely long plate with clamped edges. This agreement suggests that clamped plates with a length-to-width ratio greater than 1.5 may be regarded as infinitely long plates for purposes of design.

INTRODUCTION

An exact solution for the small deflection of a rectangular plate with clamped edges having a ratio of length to width of 1.5 was given by Hencky in reference 6 and an approximate solution for large deflection was presented by Way in reference 7.

Exact solutions for plates with clamped edges under normal pressure producing large deflections have been derived for the two extreme cases of the square plate (reference 1) and the infinitely long plate (reference 2). Comparison of these two solutions shows that the maximum stresses and the center deflections differ more than 20 percent.

Experimental work (reference 3) indicates that a rectangular plate having a length equal to twice its width behaves practically as an infinitely long plate,

It was decided to investigate theoretically the transition from the square plate to the infinitely long plate by deriving the solution for a plate of finite length so that $b/a = 1.5$.

FUNDAMENTAL EQUATIONS

Symbols

Consider an initially flat rectangular plate of uniform thickness (see fig. 1), and let

a width

b length ($1.5a$)

h thickness

p normal pressure, assumed uniform

w normal displacement of points of middle surface

E Young's modulus

μ Poisson's ratio (0.316)

$D = \frac{Eh^3}{12(1-\mu^2)}$ flexural rigidity

x, y coordinate axes lying along edges of plate with origin at one corner

m_x, m_y edge bending moments per unit length about x and y axes, respectively

$\sigma_x, \sigma_y, \tau_{xy}$ extreme-fiber stresses

$\sigma'_x, \sigma'_y, \tau'_{xy}$ membrane stresses

$\sigma''_x, \sigma''_y, \tau''_{xy}$ extreme-fiber bending stresses

$w_{m,n}$ deflection coefficients

ϵ tensile strain

γ shear strain

- F stress function
- $b_{m,n}$ stress coefficients
- \bar{p}_x, \bar{p}_y average median-fiber stresses in x and y directions, respectively
- $p_a(x,y)$ auxiliary pressure replacing edge moments
- $p_b(x,y)$ uniform normal pressure p expressed as a Fourier series
- $p_c(x,y) = p_a(x,y) + p_b(x,y)$
- $p_{m,n}$ coefficient in Fourier series for pressure, $p_c(x,y)$
- c moment arm of auxiliary pressure distribution, $p_a(x,y)$
- k_m, t_n coefficients in Fourier series for m_x and m_y , respectively
- m, n numbers that take on odd integral values, such as 1, 3, 5, 7, ...

Expressions for Stresses and Strains

The membrane stresses are related to the stress function F by (reference 2, p. 343)

$$\left. \begin{aligned} \sigma'_x &= \frac{\partial^2 F}{\partial y^2} \\ \sigma'_y &= \frac{\partial^2 F}{\partial x^2} \\ \tau'_{xy} &= -\frac{\partial^2 F}{\partial x \partial y} \end{aligned} \right\} \quad (1)$$

The extreme-fiber bending stresses in the plate are related to the deflections by (reference 2, pp. 40, 41, and 44)

$$\left. \begin{aligned} \sigma''_x &= -\frac{Eh}{2(1-\mu^2)} \left(\frac{\partial^2 w}{\partial x^2} + \mu \frac{\partial^2 w}{\partial y^2} \right) \\ \sigma''_y &= -\frac{Eh}{2(1-\mu^2)} \left(\frac{\partial^2 w}{\partial y^2} + \mu \frac{\partial^2 w}{\partial x^2} \right) \\ \tau''_{xy} &= -\frac{Eh}{2(1+\mu)} \frac{\partial^2 w}{\partial x \partial y} \end{aligned} \right\} \quad (2)$$

The extreme-fiber bending stresses at the edges of the plate are related to the bending moments per unit length by (reference 2, p. 45)

$$\left. \begin{aligned} \sigma''_x &= \frac{6}{h^3} m_y & \sigma''_y &= \frac{6\mu}{h^3} m_y & \text{at } x=0,a \\ \sigma''_x &= \frac{6\mu}{h^3} m_x & \sigma''_y &= \frac{6}{h^3} m_x & \text{at } y=0,b \end{aligned} \right\} \quad (3)$$

The strains at the middle surface of the plate are, from equation (1):

$$\left. \begin{aligned} \epsilon'_x &= \frac{1}{E} (\sigma'_x - \mu \sigma'_y) = \frac{1}{E} \left(\frac{\partial^2 F}{\partial y^2} - \mu \frac{\partial^2 F}{\partial x^2} \right) \\ \epsilon'_y &= \frac{1}{E} (\sigma'_y - \mu \sigma'_x) = \frac{1}{E} \left(\frac{\partial^2 F}{\partial x^2} - \mu \frac{\partial^2 F}{\partial y^2} \right) \\ \gamma'_{xy} &= \frac{2(1+\mu)}{E} \tau'_{xy} = -\frac{2(1+\mu)}{E} \frac{\partial^2 F}{\partial x \partial y} \end{aligned} \right\} \quad (4)$$

Relation between Edge Moments and Lateral Pressure

The required edge moments m_x, m_y will be replaced by an auxiliary pressure distribution $p_a(x,y)$ near the edges of the plate as shown in figure 2. Expressing this pressure distribution by a Fourier series (reference 4)

and letting the value of c approach zero, the auxiliary pressure is

$$p_a(x,y) = \sum_{m=1,3,\dots}^{\infty} \frac{4\pi m}{a^2} m_y \sin \frac{m\pi x}{a} + \sum_{n=1,3,\dots}^{\infty} \frac{4\pi n}{b^2} m_x \sin \frac{n\pi y}{b} \quad (5)$$

The edge moments m_x, m_y may be expressed by a Fourier series:

$$\left. \begin{aligned} m_x &= \frac{4b^2}{\pi^3} p \sum_{m=1,3,\dots}^{\infty} k_m \sin \frac{m\pi x}{a} \\ m_y &= \frac{4a^2}{\pi^3} p \sum_{n=1,3,\dots}^{\infty} t_n \sin \frac{n\pi y}{b} \end{aligned} \right\} \quad (6)$$

where k_m, t_n are coefficients to be determined later. Combining equations (5) and (6) gives

$$p_a(x,y) = \frac{16p}{\pi^2} \sum_{m=1,3,\dots}^{\infty} \sum_{n=1,3,\dots}^{\infty} (nk_m + mt_n) \sin \frac{m\pi x}{a} \sin \frac{n\pi y}{b} \quad (7)$$

The uniform pressure p may also be expressed by a Fourier series (reference 4) as

$$p_b(x,y) = \frac{16p}{\pi^2} \sum_{m=1,3,\dots}^{\infty} \sum_{n=1,3,\dots}^{\infty} \frac{1}{mn} \sin \frac{m\pi x}{a} \sin \frac{n\pi y}{b} \quad (8)$$

The addition of the uniform normal pressure $p_b(x,y)$ to the auxiliary pressure $p_a(x,y)$ that replaces the edge moments gives the total pressure acting

$$\begin{aligned}
 p_c(x,y) &= \frac{16p}{\pi^2} \sum_{m=1,3,\dots}^{\infty} \sum_{n=1,3,\dots}^{\infty} \left(\frac{1}{mn} + nk_m + mt_n \right) \sin \frac{m\pi x}{a} \sin \frac{n\pi y}{b} \\
 &= \sum_{m=1,3,\dots}^{\infty} \sum_{n=1,3,\dots}^{\infty} p_{m,n} \sin \frac{m\pi x}{a} \sin \frac{n\pi y}{b} \quad (9)
 \end{aligned}$$

where

$$p_{m,n} = \frac{16p}{\pi^2} \left(\frac{1}{mn} + nk_m + mt_n \right) \quad (10)$$

Relation between Stress Function F , Deflection w ,
 and Pressure Coefficients $p_{m,n}$

As the edge moments m_x and m_y have been replaced by the auxiliary pressure distribution $p_a(x,y)$ (see equation (7)), the general solution (reference 5) for the simply supported rectangular plate may be applied. This solution was derived in terms of a Fourier series from Von Kármán's equations (reference 2, p. 343):

$$\left. \begin{aligned}
 \frac{\partial^4 F}{\partial x^4} + 2 \frac{\partial^4 F}{\partial x^2 \partial y^2} + \frac{\partial^4 F}{\partial y^4} &= E \left[\left(\frac{\partial^2 w}{\partial x \partial y} \right)^2 - \frac{\partial^2 w}{\partial x^2} \frac{\partial^2 w}{\partial y^2} \right] \\
 \frac{\partial^4 w}{\partial x^4} + 2 \frac{\partial^4 w}{\partial x^2 \partial y^2} + \frac{\partial^4 w}{\partial y^4} &= \frac{p_c(x,y) h}{D} + \frac{h}{D} \left(\frac{\partial^2 F}{\partial y^2} \frac{\partial^2 w}{\partial x^2} + \frac{\partial^2 F}{\partial x^2} \frac{\partial^2 w}{\partial y^2} - 2 \frac{\partial^2 F}{\partial x \partial y} \frac{\partial^2 w}{\partial x \partial y} \right)
 \end{aligned} \right\} (11)$$

The deflection is described in reference 5 by

$$w = \sum_{m=1,3,\dots}^{\infty} \sum_{n=1,3,\dots}^{\infty} w_{m,n} \sin \frac{m\pi x}{a} \sin \frac{n\pi y}{b} \quad (12)$$

and the pressure by equation (9)

$$p_c(x,y) = \sum_{m=1,3,\dots}^{\infty} \sum_{n=1,3,\dots}^{\infty} p_{m,n} \sin \frac{m\pi x}{a} \sin \frac{n\pi y}{b} \quad (13)$$

The stress function F is given by:

$$F = \frac{\bar{p}_y x^2}{2} + \frac{\bar{p}_x y^2}{2} + \sum_{m=0,2,4,\dots}^{\infty} \sum_{n=0,2,4,\dots}^{\infty} b_{m,n} \cos \frac{m\pi x}{a} \cos \frac{n\pi y}{b} \quad (14)$$

It is shown that, for zero displacement normal to the edges of the plate,

$$\left. \begin{aligned} \bar{p}_x - \mu \bar{p}_y &= \frac{Eh^2}{8a^2} \sum_{m=1,3,\dots}^{\infty} \sum_{n=1,3,\dots}^{\infty} m^2 w_{m,n}^2 \\ \bar{p}_y - \mu \bar{p}_x &= \frac{Eh^2}{8b^2} \sum_{m=1,3,\dots}^{\infty} \sum_{n=1,3,\dots}^{\infty} n^2 w_{m,n}^2 \end{aligned} \right\} \quad (15)$$

The general solution (reference 5) gives the membrane stress function coefficients $b_{m,n}$ in terms of the deflection function coefficients $w_{m,n}$. (The first 26 of these coefficients $b_{m,n}$ are given in table 1.) Reference 5 also gives the general form of the family of equations relating the pressure p_c and the deflection coefficients $w_{m,n}$. (The first 60 terms in each of the first 33 of these equations are given in table 2 for Poisson's ratio $\mu = 0.316$.) As an example of the use of table 2, the first six terms of the first equation are

$$\begin{aligned} 0 &= \frac{w_{1,1}}{h} - 0.0862 \frac{pa^4}{Eh^4} - 0.0862k_1 \frac{pa^4}{Eh^4} - 0.0862t_1 \frac{pa^4}{Eh^4} \\ &+ 1.451 \left(\frac{w_{1,1}}{h} \right)^3 - 0.972 \left(\frac{w_{1,1}}{h} \right)^2 \frac{w_{1,3}}{h} \end{aligned} \quad (16)$$

The values of $\frac{w_{m,n}}{h}$ not given in table 2 can be de-

terminated with sufficient accuracy by neglecting cubic terms. They are then given by

$$\frac{w_{m,n}}{h} = \frac{pa^4}{Eh^4} \frac{0.1798}{\left(m^2 + \frac{n^2}{2.25}\right)^2} \left(\frac{1}{mn} + nk_m + mt_n\right) \quad (17)$$

Magnitude of Edge Moments m_x and m_y

The edge moments must now be determined to satisfy the condition of zero slope at the edges of the plate. Setting the slope at the edges $x = 0$, $x = a$ equal to zero gives from equation (12),

$$0 = \sum_{m=1,3,\dots}^{\infty} \sum_{n=1,3,\dots}^{\infty} mw_{m,n} \sin \frac{n\pi y}{b} \quad (18)$$

Similarly, setting the slope at the edges $y = 0$, $y = b$ equal to zero gives

$$0 = \sum_{m=1,3,\dots}^{\infty} \sum_{n=1,3,\dots}^{\infty} nw_{m,n} \sin \frac{m\pi x}{a} \quad (19)$$

Equation (18) is equivalent to the equations

$$\left. \begin{aligned} 0 &= w_{1,1} + 3w_{3,1} + 5w_{5,1} + \dots \\ 0 &= w_{1,3} + 3w_{3,3} + 5w_{5,3} + \dots \\ 0 &= w_{1,5} + 3w_{3,5} + 5w_{5,5} + \dots \end{aligned} \right\} \quad (20a)$$

and equation (19) is equivalent to the equations

$$\left. \begin{aligned} 0 &= w_{1,1} + 3w_{1,3} + 5w_{1,5} + \dots \\ 0 &= w_{3,1} + 3w_{3,3} + 5w_{3,5} + \dots \\ 0 &= w_{5,1} + 3w_{5,3} + 5w_{5,5} + \dots \end{aligned} \right\} \quad (20b)$$

Substituting the values given in table 2 and equation (17) for the deflection coefficients $w_{m,n}$ in equations (20a) and (20b) gives the equations in table 3. As an example of the use of table 3, the first few terms in the first equation are

$$\begin{aligned}
 0 = & -0.08862 \frac{pa^4}{Eh^4} - 0.1260t_1 \frac{pa^4}{Eh^4} - 0.0862k_1 \frac{pa^4}{Eh^4} - 0.006045k_3 \frac{pa^4}{Eh^4} - \dots \\
 & + 1.446 \left(\frac{w_{1,1}}{h} \right)^3 - 0.938 \left(\frac{w_{1,1}}{h} \right)^2 \frac{w_{1,3}}{h} + 0.596 \left(\frac{w_{1,1}}{h} \right)^2 \frac{w_{3,1}}{h} + \dots
 \end{aligned}
 \tag{21}$$

Additional values of k_m and t_n , for which terms involving the cubes of the deflection coefficients may be omitted, are obtained by substitution from equation (17) into equations (20a) and (20b) with the result:

$$\left. \begin{aligned}
 0 = \sum_{m=1,3,\dots}^{\infty} \frac{1}{\left(m^2 + \frac{n^2}{2.25} \right)^2} \left(\frac{1}{n} + mnk_m + m^2t_n \right) \\
 0 = \sum_{n=1,3,\dots}^{\infty} \frac{1}{\left(m^2 + \frac{n^2}{2.25} \right)^2} \left(\frac{1}{m} + n^2k_m + mnt_n \right)
 \end{aligned} \right\} \tag{22}$$

SOLUTION

Values of Deflection Coefficients $w_{m,n}$
 and Edge-Moment Coefficients k_m and t_n

The method of obtaining the required values of the deflection coefficients $w_{m,n}$ and the edge-moment coef-

ficients k_m and t_n consists in assuming values for $\frac{w_{1,1}}{h}$ and solving for $\frac{ps^4}{Eh^4}$, $\frac{w_{1,3}}{h}$, $\frac{w_{3,1}}{h}$, . . . k_1 , t_1 , k_3 , t_3 , . . . by successive approximation from the simultaneous equations in tables 2 and 3 and in equations (17) and (22). These calculations have been made for 12 values of $\frac{w_{1,1}}{h}$ and the corresponding values of the first 40 deflection coefficients $w_{m,n}$ and of the first 14 moment coefficients k_m , t_n are given in tables 4 and 5, respectively. The error arising from the use of only the first 60 terms in the equations in table 2 will be considered in a later section.

Center Deflection

From equation (12), the center deflection is

$$w_{\text{center}} = \sum_{m=1,3,\dots}^{\infty} \sum_{n=1,3,\dots}^{\infty} - (-1)^{\frac{m+n}{2}} w_{m,n} \quad (23)$$

The center deflection is obtained by substituting from table 4 into equation (23) with the results given in table 6 and in figure 3. Figure 3 shows that the deflection against pressure curve deviates increasingly from a straight line with increasing pressure. At a deflection equal to the plate thickness, the pressure is about 60 percent higher than that given by the linear theory (reference 6); whereas, at a deflection equal to twice the plate thickness, the pressure is about 250 percent higher than that given by the linear theory.

Shape of Deflected Surface

The deflection of the plate along the transverse center line is obtained by substituting the deflection

coefficients $w_{m,n}$ (table 4) into equation (12) and setting $y = b/2$. This calculation has been made for very small deflections $\frac{w_{center}}{h} \ll 1$, and for the highest de-

flection calculated, $\frac{w_{center}}{h} = 1.972$, with the results

given in figure 4. It is apparent that, as the center deflection increases under increasing normal pressure, catenary tensions become appreciable and the inflection point is shifted toward the edges of the plate.

Bending Stress at Midpoint of Long Edge

The extreme-fiber stress is a maximum on the pressure side of the plate at the midpoint of the longer edge. The extreme-fiber bending stress at this point was obtained by substituting equations (6) into equations (3). This substitution gives, for the extreme-fiber bending stress perpendicular to the longer edge at its midpoint,

$$\left(\frac{\sigma''_x a^2}{Eh^2} \right)_{x=0, y=b/2} = \frac{24}{\pi^3} \frac{pa^4}{Eh^4} (t_1 - t_3 + t_5 - t_7 + \dots) \quad (24)$$

The values of t_n and $\frac{pa^4}{Eh^4}$ given in table 5 were substituted in equation (24) with the results given in table 6 and in figure 5. Figure 5 shows that the bending stress at the midpoint of the longer edge deviates increasingly from the linear theory (reference 6). The deviation is about 35 percent when the deflection is equal to the plate thickness and about 115 percent when the deflection is twice the plate thickness.

The extreme-fiber bending stress at the center of the plate was not computed, since previous work on square and on infinitely long plates (references 1 and 2, respectively) shows this stress to be considerably smaller than at the midpoint of the longer edge.

Membrane Stresses

The membrane stresses in the plate are obtained by substituting equation (14) into equations (1) and using equations (15) and the equations in table 1 to determine the values of the stress coefficients \bar{P}_x , \bar{P}_y , and $b_{m,n}$. This method gives, for the membrane stress perpendicular to the longer edge at its midpoint,

$$\begin{aligned} \left(\frac{\sigma'_x a^2}{Eh^2} \right)_{x=0, y=b/2} &= 2.792 \left(\frac{w_{1,1}}{h} \right)^2 + 23.62 \left(\frac{w_{3,1}}{h} \right)^2 \\ &+ 4.338 \left(\frac{w_{1,3}}{h} \right)^2 + 25.17 \left(\frac{w_{3,3}}{h} \right)^2 + 7.405 \left(\frac{w_{1,5}}{h} \right)^2 + 65.30 \left(\frac{w_{5,1}}{h} \right)^2 \\ &- 3.749 \frac{w_{1,1}}{h} \frac{w_{1,3}}{h} + 0.9100 \frac{w_{1,1}}{h} \frac{w_{3,1}}{h} - 2.052 \frac{w_{1,1}}{h} \frac{w_{3,3}}{h} \\ &+ 1.959 \frac{w_{1,1}}{h} \frac{w_{1,5}}{h} + 0.2002 \frac{w_{1,1}}{h} \frac{w_{5,1}}{h} - 8.502 \frac{w_{1,3}}{h} \frac{w_{3,1}}{h} \\ &+ 5.700 \frac{w_{1,3}}{h} \frac{w_{3,3}}{h} - 1.077 \frac{w_{1,1}}{h} \frac{w_{1,5}}{h} - 3.772 \frac{w_{1,3}}{h} \frac{w_{5,1}}{h} \\ &- 44.10 \frac{w_{3,1}}{h} \frac{w_{3,3}}{h} + 16.49 \frac{w_{3,1}}{h} \frac{w_{1,5}}{h} + 3.737 \frac{w_{3,1}}{h} \frac{w_{5,1}}{h} \\ &- 13.74 \frac{w_{3,3}}{h} \frac{w_{1,5}}{h} - 28.51 \frac{w_{3,3}}{h} \frac{w_{5,1}}{h} + 13.41 \frac{w_{1,5}}{h} \frac{w_{5,1}}{h} + \dots (25) \end{aligned}$$

and, for the membrane stress at the center of the plate parallel to the shorter edge,

$$\begin{aligned}
 \left(\frac{\sigma'_x a^2}{Eh^2} \right)_{x=a/2, y=b/2} &= 2.795 \left(\frac{w_{1,1}}{h} \right)^2 + 23.64 \left(\frac{w_{3,1}}{h} \right)^2 \\
 &+ 4.338 \left(\frac{w_{1,3}}{h} \right)^2 + 25.16 \left(\frac{w_{3,3}}{h} \right)^2 + 7.406 \left(\frac{w_{1,5}}{h} \right)^2 + 65.30 \left(\frac{w_{5,1}}{h} \right)^2 \\
 &- 6.12 \frac{w_{1,1}}{h} \frac{w_{1,3}}{h} - 0.958 \frac{w_{1,1}}{h} \frac{w_{3,1}}{h} + 2.497 \frac{w_{1,1}}{h} \frac{w_{3,3}}{h} \\
 &+ 7.91 \frac{w_{1,1}}{h} \frac{w_{1,5}}{h} + 0.2438 \frac{w_{1,1}}{h} \frac{w_{5,1}}{h} + 11.60 \frac{w_{1,3}}{h} \frac{w_{3,1}}{h} \\
 &- 6.935 \frac{w_{1,3}}{h} \frac{w_{3,3}}{h} - 8.79 \frac{w_{1,3}}{h} \frac{w_{5,1}}{h} - 6.115 \frac{w_{1,3}}{h} \frac{w_{5,1}}{h} \\
 &- 44.75 \frac{w_{3,1}}{h} \frac{w_{3,3}}{h} - 30.70 \frac{w_{3,1}}{h} \frac{w_{1,5}}{h} - 3.740 \frac{w_{3,1}}{h} \frac{w_{5,1}}{h} \\
 &+ 22.29 \frac{w_{3,3}}{h} \frac{w_{1,5}}{h} + 29.25 \frac{w_{3,3}}{h} \frac{w_{5,1}}{h} + 26.56 \frac{w_{1,5}}{h} \frac{w_{5,1}}{h} + \dots (26)
 \end{aligned}$$

The values of $\frac{w_{m,n}}{h}$ given in table 4 have been substituted into equations (25) and (26) with the results given in table 6 and figure 5. Figure 5 shows that, for pressures less than $280 \text{ pa}^4/Eh^4$ (deflections less than twice the plate thickness), the membrane stresses are small compared with the bending stress at the midpoint of the longer edge. It is also interesting to notice that the membrane stress remains almost the same in going from the edge to the center of the plate. This result shows that the stress distribution at the transverse center line ($y = b/2$) of a plate with $b/a = 1.5$ approaches the condition of constant membrane stress characteristic of an infinitely long plate ($b/a \rightarrow \infty$).

The maximum extreme-fiber stress (fig. 5), is obtained by adding the bending and the membrane stresses.

Convergence of Solution

The exactness of the solution may be increased to any desired degree by increasing the number of cubic terms in the equations in table 2. In the present solution the 4 linear terms and 56 of the cubic terms were included. The effect of limiting the number of cubic terms is brought out in table 7 giving the results of solutions using 0, 1, 10, and 56 cubic terms. The 0-cubic-term solution corresponds to the linear theory; the 1-cubic-term solution takes account of the cube of $\frac{w_{1,1}}{h}$; the 10-cubic-term solution takes account of cubic products of $\frac{w_{1,1}}{h}$, $\frac{w_{1,3}}{h}$, and $\frac{w_{3,1}}{h}$; and the 56-cubic-term solution takes account of cubic products of $\frac{w_{1,1}}{h}$, $\frac{w_{1,3}}{h}$, $\frac{w_{3,1}}{h}$, $\frac{w_{3,3}}{h}$, $\frac{w_{1,5}}{h}$, and $\frac{w_{5,1}}{h}$. Comparison of the results indicates that, for a pressure ratio $\frac{pa^4}{Eh^4}$ of 74.5 (center deflection about one plate thickness), the convergence is rapid both for center deflection and extreme-fiber bending stress at the mid-point of the longer side; whereas, for a pressure ratio $\frac{pa^4}{Eh^4}$ of 282 (center deflection about twice the plate thickness), the convergence is still rapid for center deflection but less rapid for bending stress. It is estimated from table 7 that the maximum error in table 6 is less than 2 percent.

Comparison with Results Obtained by Previous Authors

An exact solution of the problem of the clamped rectangular (3:2) plate with small deflections was obtained by Hencky (reference 6). His results are plotted in figures 3 and 5 as linear theory. It is evident that, for small deflections, Hencky's results are in agreement with the results of the present paper.

The only previous analysis of the large deflection problem known to the author is that by Way (reference 7), who used the Ritz energy method with polynomials satisfying the boundary conditions and containing 11 undetermined constants. Although his calculations were made for a Poisson's ratio of 0.3, it is known from Way's analysis of circular plates (reference 2, p. 340, fig. 132) that small

changes in Poisson's ratio do not appreciably alter the solution. In figures 6 and 7 are compared the results obtained by Way, using 0.3 for Poisson's ratio, and the results obtained in the present paper, using 0.316 for Poisson's ratio. The center deflection, according to Way, differs less than 3 percent from that obtained here and the extreme-fiber bending stress at the middle of the longer side differs less than 5 percent. The membrane stresses obtained by Way are, however, about 40 percent larger than those for the present paper. This discrepancy in membrane stress provides an explanation of the fact, noted by Way in reference 7 (p. 127), that his total stresses exceeded those for an infinitely long plate instead of being slightly less, as they must actually be.

Comparison with Other "Exact" Solutions for Clamped Plates

The values of the center deflection and the maximum stress are compared in figures 8 and 9 with the results for an infinitely long rectangular plate (reference 2, pp. 10-17), a square plate (reference 1), and a circular plate (reference 8). As would be expected, the 3:2 rectangular plate is more rigid than the infinitely long rectangular plate of the same width; it is more flexible than the square plate of the same width; and it is still more flexible than the circular plate having a diameter equal to the width of the rectangular (3:2) plate.

The smallness of the difference in deflection and in stress between the plate with $b/a = 1.5$ and the infinitely long plate leads to the conclusion that clamped plates with length-width ratios greater than 1.5 may be regarded as infinitely long plates for purposes of design.

CONCLUSIONS

The Von Kármán equations have been solved for the special case of a plate with clamped edges having a ratio of length to width of 1.5 and loaded by uniform normal pressure.

At a center deflection equal to the plate thickness, the pressure is about 60 percent higher than that given by the linear theory (reference 6); whereas, at a deflection equal to twice the plate thickness, the pressure is about $3\frac{1}{2}$ times that given by the linear theory.

As the center deflection increases under increasing normal pressure, catenary tensions become appreciable and the inflection point is shifted toward the edges of the plate.

The bending stress at the midpoint of the longer edge deviates about 35 percent from the linear theory when the deflection equals the plate thickness. The deviation increases to 115 percent at a deflection equal to twice the plate thickness.

The membrane stresses are small compared with the bending stress at the midpoint of the longer edge. The membrane stress remains almost the same in going from the edge to the center of the plate. This result shows that the stress distribution at the transverse center line approaches the condition of constant membrane stress characteristic of an infinitely long plate.

The convergence of the solution is such that estimated maximum error is less than 2 percent.

Comparison with Hencky's linear theory gives agreement for small deflections. Comparison with Way's approximate large deflection theory shows agreement within 3 percent for center deflection and 5 percent for extreme-fiber bending stress at the middle of the longer side. The membrane stresses by Way are, however, about 40 percent larger than those obtained here. This discrepancy in membrane stress provides an explanation of the fact, noted by Way, that his total stresses exceeded those for an infinitely long plate instead of being slightly less, as they must actually be.

Comparison with the exact solution for an infinitely long plate leads to the conclusion that clamped plates with length-width ratios greater than 1.5 may be regarded as infinitely long plates for purposes of design.

National Bureau of Standards,
Washington, D. C., April 14, 1942.

REFERENCES

1. Levy, Samuel: Square Plate with Clamped Edges under Normal Pressure Producing Large Deflections. T.N. No. 847, NACA, 1942.
2. Timoshenko, S.: Theory of Plates and Shells. McGraw-Hill Book Co., Inc., 1940.
3. Ramberg, Walter, McPherson, Albert E., and Levy, Samuel: Normal-Pressure Tests of Rectangular Plates. T.N. No. 849, NACA, 1942.
4. Woods, F. S.: Advanced Calculus. Ginn and Co., 1926, p. 295.
5. Levy, Samuel: Bending of Rectangular Plates with Large Deflections. T.N. No. 846, NACA, 1942.
6. Hencky, H.: Über den Spannungszustand in rechteckigen ebenen Platten. Doctor's diss., Darmstadt. R. Oldenbourg (Munich), 1913.
7. Way, Stewart: Uniformly Loaded, Clamped, Rectangular Plates with Large Deflection. Proc., Fifth Int. Cong. Appl. Mech. (Cambridge, Mass., 1938). John Wiley & Sons, Inc., 1939, pp. 123-128.
8. Way, Stewart: Bending of Circular Plates with Large Deflection. A.S.M.E. Trans., APM-56-12, vol. 56, no. 8, Aug. 1934, pp. 627-636.

Table 1- Value of Stress Coefficients $b_{m,n}$ in Terms of Deflection Coefficients $w_{m,n}$

$$b_{0,2} = \frac{E}{28.44} (2w_{1,1}^2 + 18w_{3,1}^2 + 50w_{5,1}^2 - 4w_{1,1}w_{1,3} - 4w_{1,3}w_{1,5} - 36w_{3,1}w_{3,3} - 4w_{1,5}w_{1,7} - 4w_{1,7}w_{1,9} - 4w_{1,9}w_{1,11} - 4w_{1,11}w_{1,13} - 36w_{3,3}w_{3,5} + 98w_{7,1}^2 \dots)$$

$$b_{0,4} = \frac{E}{455.1} (16w_{1,1}w_{1,3} - 16w_{1,1}w_{1,5} - 16w_{1,3}w_{1,7} - 16w_{1,5}w_{1,9} - 16w_{1,7}w_{1,11} - 16w_{1,9}w_{1,13} - 16w_{1,11}w_{1,15} + 144w_{3,1}w_{3,3} - 144w_{3,1}w_{3,5} - 144w_{3,3}w_{3,7} \dots)$$

$$b_{0,6} = \frac{E}{2304} (36w_{1,1}w_{1,5} - 36w_{1,1}w_{1,7} + 18w_{1,3}^2 - 36w_{1,3}w_{1,9} - 36w_{1,5}w_{1,11} - 36w_{1,7}w_{1,13} - 36w_{1,9}w_{1,15} + 324w_{3,1}w_{3,5} - 324w_{3,1}w_{3,7} + 162w_{3,3}^2 - 324w_{3,3}w_{3,9} \dots)$$

$$b_{0,8} = \frac{E}{7282} (64w_{1,1}w_{1,7} - 64w_{1,1}w_{1,9} - 64w_{1,3}w_{1,5} - 64w_{1,3}w_{1,11} - 64w_{1,5}w_{1,13} - 64w_{1,7}w_{1,15} - 576w_{3,1}w_{3,9} \dots)$$

$$b_{0,10} = \frac{E}{17778} (100w_{1,1}w_{1,9} - 100w_{1,1}w_{1,11} + 100w_{1,3}w_{1,7} - 100w_{1,3}w_{1,13} + 50w_{1,5}^2 - 100w_{1,5}w_{1,15} + 900w_{3,1}w_{3,9} - 900w_{3,1}w_{3,11} + 900w_{3,3}w_{3,7} \dots)$$

Table 1 (cont.)

$$b_{0,12} = \frac{E}{36864} (144w_{1,1}w_{1,11} - 144w_{1,1}w_{1,13} + 144w_{1,3}w_{1,9} - 144w_{1,3}w_{1,15} \\ + 144w_{1,5}w_{1,7} + 1296w_{3,1}w_{3,11} - 1296w_{3,1}w_{3,13} + 1296w_{3,3}w_{3,9} \\ + 1296w_{3,5}w_{3,7} \dots)$$

$$b_{2,0} = \frac{E}{144.0} (2w_{1,1}^2 - 4w_{1,1}w_{3,1} + 18w_{1,3}^2 - 36w_{1,3}w_{3,3} \\ + 50w_{1,5}^2 - 100w_{1,5}w_{3,5} + 98w_{1,7}^2 - 196w_{1,7}w_{3,7} \\ + 162w_{1,9}^2 + 242w_{1,11}^2 + 338w_{1,13}^2 - 4w_{3,1}w_{5,1} \dots)$$

$$b_{2,2} = \frac{E}{300.4} (16w_{1,1}w_{1,3} + 16w_{1,1}w_{3,1} + 64w_{1,3}w_{1,5} - 64w_{1,3}w_{3,1} \\ - 16w_{1,3}w_{3,5} + 144w_{1,5}w_{1,7} - 144w_{1,5}w_{3,3} - 64w_{1,5}w_{3,7} \\ + 256w_{1,7}w_{1,9} - 256w_{1,7}w_{3,5} + 400w_{1,9}w_{1,11} - 400w_{1,9}w_{3,7} \\ + 576w_{1,11}w_{1,13} + 64w_{3,1}w_{5,1} - 16w_{3,1}w_{5,3} \dots)$$

$$b_{2,4} = \frac{E}{1111} (-4w_{1,1}w_{1,3} + 36w_{1,1}w_{1,5} + 36w_{1,1}w_{3,3} - 4w_{1,1}w_{3,5} \\ + 100w_{1,3}w_{1,7} + 100w_{1,3}w_{3,1} - 4w_{1,3}w_{3,7} + 196w_{1,5}w_{1,9} \\ - 196w_{1,5}w_{3,1} - 36w_{1,5}w_{3,9} + 324w_{1,7}w_{1,11} - 324w_{1,7}w_{3,3} \\ + 484w_{1,9}w_{1,13} - 484w_{1,9}w_{3,5} + 676w_{1,11}w_{1,15} + 196w_{3,1}w_{5,3} \dots)$$

Table 1 (cont.)

$$b_{2,6} = \frac{E}{3600} (-16w_{1,1}w_{1,5} + 64w_{1,1}w_{1,7} + 64w_{1,1}w_{3,5} - 16w_{1,1}w_{3,7} \\ + 144w_{1,3}w_{1,9} + 144w_{1,3}w_{3,3} + 256w_{1,5}w_{1,11} + 256w_{1,5}w_{3,1} \\ - 16w_{1,5}w_{3,11} + 400w_{1,7}w_{1,13} - 400w_{1,7}w_{3,1} + 576w_{1,9}w_{1,15} \\ - 576w_{1,9}w_{3,3} - 784w_{1,11}w_{3,5} \dots)$$

$$b_{2,8} = \frac{E}{9474} (-36w_{1,1}w_{1,7} + 100w_{1,1}w_{1,9} + 100w_{1,1}w_{3,7} - 36w_{1,1}w_{3,9} \\ - 4w_{1,3}w_{1,5} + 196w_{1,3}w_{1,11} + 196w_{1,3}w_{3,5} - 4w_{1,3}w_{3,11} \\ + 324w_{1,5}w_{1,13} + 324w_{1,5}w_{3,3} - 4w_{1,5}w_{3,13} + 484w_{1,7}w_{3,1} \\ + 484w_{1,7}w_{1,15} - 676w_{1,9}w_{3,1} - 900w_{1,11}w_{3,3} \dots)$$

$$b_{2,10} = \frac{E}{21120} (-64w_{1,1}w_{1,9} + 144w_{1,1}w_{1,11} + 144w_{1,1}w_{3,9} - 64w_{1,1}w_{3,11} \\ - 16w_{1,3}w_{1,7} + 256w_{1,3}w_{1,13} + 256w_{1,3}w_{3,7} - 16w_{1,3}w_{3,13} \\ + 400w_{1,5}w_{1,15} + 400w_{1,5}w_{3,5} + 576w_{1,7}w_{3,3} + 784w_{1,9}w_{3,1} \\ - 1024w_{1,11}w_{3,1} - 1296w_{1,13}w_{3,3} - 1600w_{1,15}w_{3,5} \dots)$$

$$b_{2,12} = \frac{E}{41616} (-100w_{1,1}w_{1,11} + 196w_{1,1}w_{1,13} + 196w_{1,1}w_{3,11} - 100w_{1,1}w_{3,13} \\ - 36w_{1,3}w_{1,9} + 324w_{1,3}w_{1,15} + 324w_{1,3}w_{3,9} - 4w_{1,5}w_{1,7} \\ + 484w_{1,5}w_{3,7} + 676w_{1,7}w_{3,5} + 900w_{1,9}w_{3,3} + 1156w_{1,11}w_{3,1} \\ - 1444w_{1,13}w_{3,1} - 1764w_{1,15}w_{3,3} \dots)$$

Table 1 (cont.)

$$b_{4,0} = \frac{E}{2304} (16w_{1,1}w_{3,1} - 16w_{1,1}w_{5,1} + 144w_{1,3}w_{3,3} - 144w_{1,3}w_{5,3} + 400w_{1,5}w_{3,5} + 784w_{1,7}w_{3,7} \dots)$$

$$b_{4,2} = \frac{E}{2844} (-4w_{1,1}w_{3,1} + 36w_{1,1}w_{3,3} + 36w_{1,1}w_{5,1} - 4w_{1,1}w_{5,3} + 100w_{1,3}w_{3,1} + 196w_{1,3}w_{3,5} - 196w_{1,3}w_{5,1} + 324w_{1,5}w_{3,3} + 484w_{1,5}w_{3,7} - 484w_{1,5}w_{5,3} + 676w_{1,7}w_{3,5} + 1156w_{1,9}w_{3,7} \dots)$$

$$b_{4,4} = \frac{E}{4807} (64w_{1,1}w_{3,5} + 64w_{1,1}w_{5,3} - 64w_{1,3}w_{3,1} + 256w_{1,3}w_{3,7} + 256w_{1,3}w_{5,1} + 256w_{1,5}w_{3,1} + 576w_{1,5}w_{3,9} - 576w_{1,5}w_{5,1} + 576w_{1,7}w_{3,3} + 1024w_{1,9}w_{3,5} \dots)$$

$$b_{4,6} = \frac{E}{9216} (-4w_{1,1}w_{3,5} + 100w_{1,1}w_{3,7} + 100w_{1,1}w_{5,5} - 36w_{1,3}w_{3,3} + 324w_{1,3}w_{3,9} + 324w_{1,3}w_{5,3} - 196w_{1,5}w_{3,1} + 676w_{1,5}w_{3,11} + 676w_{1,5}w_{5,1} + 484w_{1,7}w_{3,1} + 900w_{1,9}w_{3,3} + 1444w_{1,11}w_{3,5} \dots)$$

$$b_{4,8} = \frac{E}{17778} (-16w_{1,1}w_{3,7} + 144w_{1,1}w_{3,9} - 16w_{1,3}w_{3,5} + 400w_{1,3}w_{3,11} - 144w_{1,5}w_{3,3} + 784w_{1,5}w_{3,13} + 784w_{1,5}w_{5,3} - 400w_{1,7}w_{3,1} + 784w_{1,9}w_{3,1} + 1296w_{1,11}w_{3,3} \dots)$$

Table 1 (cont.)

$$b_{6,0} = \frac{E}{11664} (36w_{1,1}w_{5,1} + 324w_{1,3}w_{5,3} + 18w_{3,1}^2 + 162w_{3,3}^2 \dots)$$

$$b_{6,2} = \frac{E}{12844} (-16w_{1,1}w_{5,1} + 64w_{1,1}w_{5,3} + 256w_{1,3}w_{5,1} + 784w_{1,5}w_{5,3} \\ + 144w_{3,1}w_{3,3} + 576w_{3,3}w_{3,5} \dots)$$

$$b_{6,4} = \frac{E}{16727} (-4w_{1,1}w_{5,3} + 100w_{1,1}w_{5,5} - 196w_{1,3}w_{5,1} + 676w_{1,5}w_{5,1} \\ - 36w_{3,1}w_{3,3} + 324w_{3,1}w_{3,5} + 900w_{3,3}w_{3,7} \dots)$$

$$b_{6,6} = \frac{E}{24354} (-144w_{1,3}w_{5,3} - 576w_{1,5}w_{5,1} - 144w_{3,1}w_{3,5} + 576w_{3,1}w_{3,7} \\ + 1296w_{3,3}w_{3,9} \dots)$$

$$b_{8,0} = \frac{E}{36864} (64w_{3,1}w_{5,1} \dots)$$

$$b_{8,2} = \frac{E}{38940} (-4w_{3,1}w_{5,1} + 196w_{3,1}w_{5,3} + 324w_{3,3}w_{5,1} \dots)$$

$$b_{8,4} = \frac{E}{45511} (-16w_{3,1}w_{5,3} - 144w_{3,3}w_{5,1} \dots)$$

$$b_{10,0} = \frac{E}{90000} (50w_{5,1}^2 \dots)$$

NACA Technical Note No. 853

TABLE 2.-- Equations between Pressure Coefficients $P_{m,n}$ and Deflection Coefficients $W_{m,n}$

	0 =	0 =	0 =	0 =	0 =	0 =	0 =
1	$\frac{W_{1,1}}{h}$	$\frac{W_{3,1}}{h}$	$\frac{W_{5,1}}{h}$	$\frac{W_{7,1}}{h}$	$\frac{W_{9,1}}{h}$	$\frac{W_{11,1}}{h}$	$\frac{W_{13,1}}{h}$
$\frac{pa^4}{Eh^4}$	-.0882	-.000672	-.0000555	-.00001051	-.00000301	-.000001110	-.000000482
$\frac{pa^4}{Eh^4}$	-.0882k ₁	-.002015k ₂	-.0002775k ₃	-.0000736k ₄	-.0000271k ₅	-.00001220k ₁₁	-.00000627k ₁₃
$\frac{pa^4}{Eh^4}$	-.0882t ₁	-.000605t ₁	-.001388t ₁	-.000514t ₁	-.000244t ₁	-.0001242t ₁	-.0000814t ₁
$\left(\frac{W_{1,1}}{h}\right)^2$	1.451	-.001487	0	0	0	0	0
$\left(\frac{W_{1,1}}{h}\right)^2 \frac{W_{1,3}}{h}$	-.972	.01149	0	0	0	0	0
$\left(\frac{W_{1,1}}{h}\right)^2 \frac{W_{3,1}}{h}$	-.1920	.264	-.000711	0	0	0	0
$\left(\frac{W_{1,1}}{h}\right)^2 \frac{W_{5,3}}{h}$	0	-.0689	.000845	0	0	0	0
$\left(\frac{W_{1,1}}{h}\right)^2 \frac{W_{1,5}}{h}$	0	0	0	0	0	0	0
$\left(\frac{W_{1,1}}{h}\right)^2 \frac{W_{5,1}}{h}$	0	-.00517	.0945	-.000203	0	0	0
$\frac{W_{1,1}}{h} \left(\frac{W_{1,3}}{h}\right)^2$	5.38	-.0642	0	0	0	0	0
$\frac{W_{1,1}}{h} \left(\frac{W_{3,1}}{h}\right)^2$	11.30	0	.00692	-.000233	0	0	0
$\frac{W_{1,1}}{h} \left(\frac{W_{5,3}}{h}\right)^2$	10.50	0	.0213	-.00250	0	0	0
$\frac{W_{1,1}}{h} \left(\frac{W_{1,5}}{h}\right)^2$	10.50	-.1382	0	0	0	0	0
$\frac{W_{1,1}}{h} \left(\frac{W_{5,1}}{h}\right)^2$	29.35	0	0	0	.000509	-.0000531	0
$\frac{W_{1,1}}{h} \frac{W_{1,3}}{h} \frac{W_{3,1}}{h}$.983	-.232	.00918	0	0	0	0
$\frac{W_{1,1}}{h} \frac{W_{1,5}}{h} \frac{W_{3,3}}{h}$	-1.301	.387	-.0247	0	0	0	0
$\frac{W_{1,1}}{h} \frac{W_{1,3}}{h} \frac{W_{1,5}}{h}$	-2.095	.0982	0	0	0	0	0
$\frac{W_{1,1}}{h} \frac{W_{1,3}}{h} \frac{W_{5,1}}{h}$	0	.0667	-.0628	.00462	0	0	0
$\frac{W_{1,1}}{h} \frac{W_{3,1}}{h} \frac{W_{3,3}}{h}$	-5.89	0	-.01457	.001197	0	0	0
$\frac{W_{1,1}}{h} \frac{W_{3,1}}{h} \frac{W_{1,5}}{h}$	0	0	0	0	0	0	0
$\frac{W_{1,1}}{h} \frac{W_{3,1}}{h} \frac{W_{5,1}}{h}$	-.443	.1009	0	.00471	-.0002050	0	0
$\frac{W_{1,1}}{h} \frac{W_{5,3}}{h} \frac{W_{1,5}}{h}$	1.342	-.332	.0271	0	0	0	0

TABLE 2.- Continued.

$\frac{w_{1,1}}{h} \frac{w_{3,3}}{h} \frac{w_{3,1}}{h}$.525	-.1058	0	-.00216	.000730	0	0
$\frac{w_{1,1}}{h} \frac{w_{1,3}}{h} \frac{w_{3,1}}{h}$	0	0	0	0	0	0	0
$\left(\frac{w_{1,3}}{h}\right)^3$	0	0	0	0	0	0	0
$\left(\frac{w_{1,3}}{h}\right)^2 \frac{w_{3,1}}{h}$	-2.755	.740	-.0209	0	0	0	0
$\left(\frac{w_{1,3}}{h}\right)^2 \frac{w_{3,3}}{h}$	0	0	0	0	0	0	0
$\left(\frac{w_{1,3}}{h}\right)^2 \frac{w_{1,3}}{h}$	2.935	-.1837	0	0	0	0	0
$\left(\frac{w_{1,3}}{h}\right)^2 \frac{w_{3,1}}{h}$	0	-.1520	.1998	-.00718	0	0	0
$\frac{w_{1,3}}{h} \left(\frac{w_{3,1}}{h}\right)^2$	-4.96	0	-.0253	-.001727	0	0	0
$\frac{w_{1,3}}{h} \left(\frac{w_{3,3}}{h}\right)^2$	0	0	0	0	0	0	0
$\frac{w_{1,3}}{h} \left(\frac{w_{1,3}}{h}\right)^2$	0	0	0	0	0	0	0
$\frac{w_{1,3}}{h} \left(\frac{w_{3,1}}{h}\right)^2$	-9.72	0	0	0	-.002445	.000416	0
$\frac{w_{1,3}}{h} \frac{w_{3,1}}{h} \frac{w_{3,3}}{h}$	16.59	0	.1209	-.01307	0	0	0
$\frac{w_{1,3}}{h} \frac{w_{3,1}}{h} \frac{w_{1,3}}{h}$	4.25	-.704	.0847	0	0	0	0
$\frac{w_{1,3}}{h} \frac{w_{3,1}}{h} \frac{w_{3,1}}{h}$	2.855	-.387	0	-.01845	.001781	0	0
$\frac{w_{1,3}}{h} \frac{w_{3,3}}{h} \frac{w_{1,3}}{h}$	-4.78	.850	-.1031	0	0	0	0
$\frac{w_{1,3}}{h} \frac{w_{3,3}}{h} \frac{w_{3,1}}{h}$	-7.68	.878	0	.0298	-.00582	0	0
$\frac{w_{1,3}}{h} \frac{w_{1,3}}{h} \frac{w_{3,1}}{h}$	0	.469	-.1952	.0313	0	0	0
$\left(\frac{w_{3,1}}{h}\right)^3$	0	2.02	0	0	-.0000201	0	0
$\left(\frac{w_{3,1}}{h}\right)^2 \frac{w_{3,3}}{h}$	0	-1.839	0	0	.000292	0	0

$\left(\frac{w_{s,1}}{h}\right)^2 \frac{w_{1,s}}{h}$	0	0	0	0	0	0	0
$\left(\frac{w_{s,1}}{h}\right)^2 \frac{w_{s,1}}{h}$	2.155	0	.793	0	0	-.0000288	0
$\frac{w_{s,1}}{h} \left(\frac{w_{s,s}}{h}\right)^2$	0	4.09	0	0	-.001701	0	0
$\frac{w_{s,1}}{h} \left(\frac{w_{1,s}}{h}\right)^2$	-5.92	1.719	-.0886	0	0	0	0
$\frac{w_{s,1}}{h} \left(\frac{w_{s,1}}{h}\right)^2$	0	5.76	0	.01522	0	0	-.00001529
$\frac{w_{s,1}}{h} \frac{w_{s,s}}{h} \frac{w_{1,s}}{h}$	-14.18	0	-.1660	.02185	0	0	0
$\frac{w_{s,1}}{h} \frac{w_{s,1}}{h} \frac{w_{s,1}}{h}$	-4.53	0	-.585	0	0	.000374	0
$\frac{w_{s,1}}{h} \frac{w_{1,s}}{h} \frac{w_{s,1}}{h}$	0	0	0	0	0	0	0
$\left(\frac{w_{s,s}}{h}\right)^3$	0	0	0	0	0	0	0
$\left(\frac{w_{s,s}}{h}\right)^2 \frac{w_{1,s}}{h}$	5.27	0	.1281	-.01610	0	0	0
$\left(\frac{w_{s,s}}{h}\right)^2 \frac{w_{s,1}}{h}$	8.63	0	.910	0	0	-.001024	0
$\frac{w_{s,s}}{h} \left(\frac{w_{1,s}}{h}\right)^2$	0	0	0	0	0	0	0
$\frac{w_{s,s}}{h} \left(\frac{w_{s,1}}{h}\right)^2$	0	-2.12	0	-.0339	0	0	.0001128
$\frac{w_{s,s}}{h} \frac{w_{1,s}}{h} \frac{w_{s,1}}{h}$	8.44	-1.205	0	-.0897	.01172	0	0
$\left(\frac{w_{1,s}}{h}\right)^3$	0	0	0	0	0	0	0
$\left(\frac{w_{1,s}}{h}\right)^2 \frac{w_{s,1}}{h}$	0	-.642	.568	-.0393	0	0	0
$\frac{w_{1,s}}{h} \left(\frac{w_{s,1}}{h}\right)^2$	0	0	0	0	0	0	0
$\left(\frac{w_{s,1}}{h}\right)^3$	0	0	2.12	0	0	0	0

NACA Technical Note No. 853
 TABLE 2 (Continued)

	0 =	0 =	0 =	0 =	0 =	0 =	0 =
1	$\frac{W_{1,1}}{h}$	$\frac{W_{1,3}}{h}$	$\frac{W_{3,3}}{h}$	$\frac{W_{3,5}}{h}$	$\frac{W_{7,5}}{h}$	$\frac{W_{9,5}}{h}$	$\frac{W_{11,5}}{h}$
$\frac{P_0^4}{Eh^4}$	-.000000236	-.00240	-.0001183	-.00001427	-.00000305	-.000000922	-.000000349
$\frac{P_0^4}{Eh^4}$	-.00000354k _{1,5}	-.02160k ₁	-.00320k ₃	-.000642k ₅	-.0001921k ₇	-.0000746k ₉	-.0000345k _{1,11}
$\frac{P_0^4}{Eh^4}$	-.0000531t ₁	-.00720t ₃	-.00320t ₅	-.001070t ₇	-.000448t ₉	-.000224t ₁₁	-.0001267t ₁₃
$\left(\frac{W_{1,1}}{h}\right)^3$	0	-.02705	0	0	0	0	0
$\left(\frac{W_{1,1}}{h}\right)^2 \frac{W_{1,3}}{h}$	0	.448	-.00805	0	0	0	0
$\left(\frac{W_{1,1}}{h}\right)^2 \frac{W_{3,1}}{h}$	0	.0410	-.0364	.00000802	0	0	0
$\left(\frac{W_{1,1}}{h}\right)^2 \frac{W_{3,3}}{h}$	0	-.0542	.1298	-.001499	0	0	0
$\left(\frac{W_{1,1}}{h}\right)^2 \frac{W_{1,5}}{h}$	0	-.0875	.00832	0	0	0	0
$\left(\frac{W_{1,1}}{h}\right)^2 \frac{W_{3,5}}{h}$	0	0	.00325	-.02025	.00000851	0	0
$\frac{W_{1,1}}{h} \left(\frac{W_{1,3}}{h}\right)^2$	0	0	0	0	0	0	0
$\frac{W_{1,1}}{h} \left(\frac{W_{3,1}}{h}\right)^2$	0	-.414	0	-.001217	.00000241	0	0
$\frac{W_{1,1}}{h} \left(\frac{W_{3,3}}{h}\right)^2$	0	0	0	0	0	0	0
$\frac{W_{1,1}}{h} \left(\frac{W_{1,5}}{h}\right)^2$	0	0	0	0	0	0	0
$\frac{W_{1,1}}{h} \left(\frac{W_{3,5}}{h}\right)^2$	0	-.811	0	0	0	-.0000757	.000001522
$\frac{W_{1,1}}{h} \frac{W_{1,3}}{h} \frac{W_{3,1}}{h}$	0	-.459	.205	-.00650	0	0	0
$\frac{W_{1,1}}{h} \frac{W_{1,3}}{h} \frac{W_{3,3}}{h}$	0	0	0	0	0	0	0
$\frac{W_{1,1}}{h} \frac{W_{1,3}}{h} \frac{W_{1,5}}{h}$	0	.490	-.0593	0	0	0	0
$\frac{W_{1,1}}{h} \frac{W_{1,3}}{h} \frac{W_{3,1}}{h}$	0	0	-.0948	.0931	-.00368	0	0
$\frac{W_{1,1}}{h} \frac{W_{3,1}}{h} \frac{W_{3,3}}{h}$	0	1.382	0	.01295	-.001042	0	0
$\frac{W_{1,1}}{h} \frac{W_{3,1}}{h} \frac{W_{1,5}}{h}$	0	.354	-.1753	.01490	0	0	0
$\frac{W_{1,1}}{h} \frac{W_{3,1}}{h} \frac{W_{3,1}}{h}$	0	.238	-.0559	0	-.001486	.00000902	0
$\frac{W_{1,1}}{h} \frac{W_{3,3}}{h} \frac{W_{1,5}}{h}$	0	-.400	.1307	-.01303	0	0	0

NACA Technical Note No. 853
 TABLE 2 (Continued)

$\frac{w_{1,1}}{h} \frac{w_{3,3}}{h} \frac{w_{5,1}}{h}$	0	-.642	.1837	0	.00793	-.000534	0
$\frac{w_{1,1}}{h} \frac{w_{1,5}}{h} \frac{w_{5,1}}{h}$	0	0	.1041	-.0616	.00897	0	0
$\left(\frac{w_{1,5}}{h}\right)^3$	0	1.632	-.0640	0	0	0	0
$\left(\frac{w_{1,5}}{h}\right)^2 \frac{w_{3,1}}{h}$	0	0	0	0	0	0	0
$\left(\frac{w_{1,5}}{h}\right)^2 \frac{w_{5,5}}{h}$	0	-1.297	.688	-.0404	0	0	0
$\left(\frac{w_{1,5}}{h}\right)^2 \frac{w_{1,5}}{h}$	0	0	0	0	0	0	0
$\left(\frac{w_{1,5}}{h}\right)^2 \frac{w_{5,1}}{h}$	0	0	0	0	0	0	0
$\frac{w_{1,5}}{h} \left(\frac{w_{3,1}}{h}\right)^2$	0	2.64	0	.0315	-.001942	0	0
$\frac{w_{1,5}}{h} \left(\frac{w_{5,5}}{h}\right)^2$	0	4.52	0	.0714	-.01305	0	0
$\frac{w_{1,5}}{h} \left(\frac{w_{1,5}}{h}\right)^2$	0	4.89	-.387	0	0	0	0
$\frac{w_{1,5}}{h} \left(\frac{w_{5,1}}{h}\right)^2$	0	5.17	0	0	0	.00568	-.000708
$\frac{w_{1,5}}{h} \frac{w_{3,1}}{h} \frac{w_{3,5}}{h}$	0	0	0	0	0	0	0
$\frac{w_{1,5}}{h} \frac{w_{3,1}}{h} \frac{w_{1,5}}{h}$	0	-1.310	.450	-.0391	0	0	0
$\frac{w_{1,5}}{h} \frac{w_{3,1}}{h} \frac{w_{5,1}}{h}$	0	-1.087	.465	0	.0312	-.002445	0
$\frac{w_{1,5}}{h} \frac{w_{3,5}}{h} \frac{w_{1,5}}{h}$	0	0	0	0	0	0	0
$\frac{w_{1,5}}{h} \frac{w_{5,5}}{h} \frac{w_{5,1}}{h}$	0	0	0	0	0	0	0
$\frac{w_{1,5}}{h} \frac{w_{1,5}}{h} \frac{w_{5,1}}{h}$	0	0	-.396	.1491	-.0203	0	0
$\left(\frac{w_{5,1}}{h}\right)^3$	0	0	-.324	0	0	0	0
$\left(\frac{w_{5,1}}{h}\right)^2 \frac{w_{3,3}}{h}$	0	0	2.165	0	0	-.0002820	0

NACA Technical Note No. 853
 TABLE 2 (Continued)

$\left(\frac{w_{s,1}}{h}\right)^2 \frac{w_{1,s}}{h}$	0	-1.257	0	-.0493	.00582	0	0
$\left(\frac{w_{s,1}}{h}\right)^2 \frac{w_{s,1}}{h}$	0	-.655	0	-.1859	0	0	.0000000316
$\frac{w_{s,1}}{h} \left(\frac{w_{s,3}}{h}\right)^2$	0	0	0	0	0	0	0
$\frac{w_{s,1}}{h} \left(\frac{w_{1,s}}{h}\right)^2$	0	0	0	0	0	0	0
$\frac{w_{s,1}}{h} \left(\frac{w_{s,1}}{h}\right)^2$	0	0	-1.120	0	-.00583	0	0
$\frac{w_{s,1}}{h} \frac{w_{s,3}}{h} \frac{w_{1,s}}{h}$	0	3.040	0	.0823	-.01328	0	0
$\frac{w_{s,1}}{h} \frac{w_{s,1}}{h} \frac{w_{s,1}}{h}$	0	3.135	0	.823	0	0	-.000378
$\frac{w_{s,1}}{h} \frac{w_{1,s}}{h} \frac{w_{s,1}}{h}$	0	1.879	-.637	0	-.0496	.00730	0
$\left(\frac{w_{s,3}}{h}\right)^3$	0	0	1.451	0	0	-.001499	0
$\left(\frac{w_{s,3}}{h}\right)^2 \frac{w_{1,s}}{h}$	0	0	0	0	0	0	0
$\left(\frac{w_{s,3}}{h}\right)^2 \frac{w_{s,1}}{h}$	0	0	0	0	0	0	0
$\frac{w_{s,3}}{h} \left(\frac{w_{1,s}}{h}\right)^2$	0	-2.685	1.608	-.1239	0	0	0
$\frac{w_{s,3}}{h} \left(\frac{w_{s,1}}{h}\right)^2$	0	0	3.50	0	.0738	0	0
$\frac{w_{s,3}}{h} \frac{w_{1,s}}{h} \frac{w_{s,1}}{h}$	0	-2.68	.984	0	.0465	-.00822	0
$\left(\frac{w_{1,s}}{h}\right)^3$	0	0	0	0	0	0	0
$\left(\frac{w_{1,s}}{h}\right)^2 \frac{w_{s,1}}{h}$	0	0	0	0	0	0	0
$\frac{w_{1,s}}{h} \left(\frac{w_{s,1}}{h}\right)^2$	0	-2.53	0	0	0	-.01147	.00209
$\left(\frac{w_{s,1}}{h}\right)^3$	-.00000263	0	0	-.502	0	0	0

NACA Technical Note No. 853
 TABLE 2 (Continued)

	$0 =$	$0 =$	$0 =$	$0 =$	$0 =$	$0 =$	$0 =$
1	$\frac{w_{1,3}}{h}$	$\frac{w_{1,5}}{h}$	$\frac{w_{3,5}}{h}$	$\frac{w_{5,5}}{h}$	$\frac{\pi_{7,5}}{h}$	$\frac{w_{8,5}}{h}$	$\frac{w_{11,5}}{h}$
$\frac{pa^4}{Eh^4}$	-.0000001543	-.000245	-.0000286	-.00000551	-.000001425	-.000000471	-.0000001873
$\frac{pa^4}{Eh^4}$	-.00001806k _{1s}	-.00613k ₁	-.002320k _s	-.000690k _s	-.000248k ₇	-.0001059k _s	-.0000515k ₁₁
$\frac{pa^4}{Eh^4}$	-.0000782t _s	-.001226t _s	-.001333t _s	-.000690t _s	-.000349t _s	-.0001907t _s	-.0001151t _s
$\left(\frac{w_{1,1}}{h}\right)^2$	0	0	0	0	0	0	0
$\left(\frac{w_{1,1}}{h}\right)^2 \frac{w_{1,3}}{h}$	0	-.01488	.0000427	0	0	0	0
$\left(\frac{w_{1,1}}{h}\right)^2 \frac{w_{3,1}}{h}$	0	0	0	0	0	0	0
$\left(\frac{w_{1,1}}{h}\right)^2 \frac{w_{3,3}}{h}$	0	.00957	-.01541	0	0	0	0
$\left(\frac{w_{1,1}}{h}\right)^2 \frac{w_{1,5}}{h}$	0	.1492	-.00948	0	0	0	0
$\left(\frac{w_{1,1}}{h}\right)^2 \frac{w_{5,1}}{h}$	0	0	0	0	0	0	0
$\frac{w_{1,1}}{h} \left(\frac{w_{1,3}}{h}\right)^2$	0	.0417	-.00253	0	0	0	0
$\frac{w_{1,1}}{h} \left(\frac{w_{3,1}}{h}\right)^2$	0	0	0	0	0	0	0
$\frac{w_{1,1}}{h} \left(\frac{w_{3,3}}{h}\right)^2$	0	.0751	0	0	-.0001518	0	0
$\frac{w_{1,1}}{h} \left(\frac{w_{1,5}}{h}\right)^2$	0	0	0	0	0	0	0
$\frac{w_{1,1}}{h} \left(\frac{w_{5,1}}{h}\right)^2$	0	0	0	0	0	0	0
$\frac{w_{1,1}}{h} \frac{w_{1,3}}{h} \frac{w_{3,1}}{h}$	0	.0604	-.0371	.000461	0	0	0
$\frac{w_{1,1}}{h} \frac{w_{1,3}}{h} \frac{w_{3,3}}{h}$	0	-.0681	.0451	-.001522	0	0	0
$\frac{w_{1,1}}{h} \frac{w_{1,3}}{h} \frac{w_{1,5}}{h}$	0	0	0	0	0	0	0
$\frac{w_{1,1}}{h} \frac{w_{1,3}}{h} \frac{w_{3,1}}{h}$	0	0	.0227	-.02855	.000510	0	0
$\frac{w_{1,1}}{h} \frac{w_{3,1}}{h} \frac{w_{3,3}}{h}$	0	-.2015	0	-.00318	.00001970	0	0
$\frac{w_{1,1}}{h} \frac{w_{3,1}}{h} \frac{w_{1,5}}{h}$	0	-.1680	.1190	-.01170	0	0	0
$\frac{w_{1,1}}{h} \frac{w_{3,1}}{h} \frac{w_{3,1}}{h}$	0	0	0	0	0	0	0
$\frac{w_{1,1}}{h} \frac{w_{3,3}}{h} \frac{w_{1,5}}{h}$	0	0	0	0	0	0	0

NACA Technical Note No. 853
 TABLE 2 (Continued)

$\frac{w_{1,1}}{h} \frac{w_{3,3}}{h} \frac{w_{5,1}}{h}$	0	.1200	-.0523	0	-.00378	.0000325	0
$\frac{w_{1,1}}{h} \frac{w_{1,3}}{h} \frac{w_{5,1}}{h}$	0	0	-.0972	.0725	-.00804	0	0
$\left(\frac{w_{1,3}}{h}\right)^2$	0	0	0	0	0	0	0
$\left(\frac{w_{1,3}}{h}\right)^2 \frac{w_{5,1}}{h}$	0	-.1118	.0456	-.00323	0	0	0
$\left(\frac{w_{1,3}}{h}\right)^2 \frac{w_{5,3}}{h}$	0	0	0	0	0	0	0
$\left(\frac{w_{1,3}}{h}\right)^2 \frac{w_{1,5}}{h}$	0	.848	-.0847	0	0	0	0
$\left(\frac{w_{1,3}}{h}\right)^2 \frac{w_{5,1}}{h}$	0	0	-.0401	.0286	-.001700	0	0
$\frac{w_{1,3}}{h} \left(\frac{w_{5,1}}{h}\right)^2$	0	-.2141	0	-.00828	.000284	0	0
$\frac{w_{1,3}}{h} \left(\frac{w_{5,3}}{h}\right)^2$	0	0	0	0	0	0	0
$\frac{w_{1,3}}{h} \left(\frac{w_{1,5}}{h}\right)^2$	0	0	0	0	0	0	0
$\frac{w_{1,3}}{h} \left(\frac{w_{5,1}}{h}\right)^2$	0	-.431	0	0	0	-.001925	.0001578
$\frac{w_{1,3}}{h} \frac{w_{5,1}}{h} \frac{w_{5,3}}{h}$	0	.517	0	.01880	-.002005	0	0
$\frac{w_{1,3}}{h} \frac{w_{5,1}}{h} \frac{w_{1,5}}{h}$	0	0	0	0	0	0	0
$\frac{w_{1,3}}{h} \frac{w_{5,1}}{h} \frac{w_{5,1}}{h}$	0	.286	-.1507	0	-.01086	.000548	0
$\frac{w_{1,3}}{h} \frac{w_{5,3}}{h} \frac{w_{1,5}}{h}$	0	-.915	.467	-.0599	0	0	0
$\frac{w_{1,3}}{h} \frac{w_{5,3}}{h} \frac{w_{5,1}}{h}$	0	-.456	.1499	0	.01828	-.001613	0
$\frac{w_{1,3}}{h} \frac{w_{1,5}}{h} \frac{w_{5,1}}{h}$	0	0	0	0	0	0	0
$\left(\frac{w_{5,1}}{h}\right)^2$	0	0	0	0	0	0	0
$\left(\frac{w_{5,1}}{h}\right)^2 \frac{w_{5,3}}{h}$	0	0	-.408	0	0	.00001907	0

NACA Technical Note No. 853
 TABLE 2 (Continued)

$\left(\frac{w_{s,1}}{h}\right)^2 \frac{w_{1,s}}{h}$	0	1.047	0	.0449	-.00548	0	0
$\left(\frac{w_{s,1}}{h}\right)^2 \frac{w_{s,1}}{h}$	0	0	0	0	0	0	0
$\frac{w_{s,1}}{h} \left(\frac{w_{s,s}}{h}\right)^2$	0	0	.426	0	0	-.0002285	0
$\frac{w_{s,1}}{h} \left(\frac{w_{1,s}}{h}\right)^2$	0	0	0	0	0	0	0
$\frac{w_{s,1}}{h} \left(\frac{w_{s,1}}{h}\right)^2$.0000000165	0	0	0	0	0	0
$\frac{w_{s,1}}{h} \frac{w_{s,s}}{h} \frac{w_{1,s}}{h}$	0	0	0	0	0	0	0
$\frac{w_{s,1}}{h} \frac{w_{s,1}}{h} \frac{w_{s,1}}{h}$	0	-.733	0	-.2605	0	0	.0000348
$\frac{w_{s,1}}{h} \frac{w_{1,s}}{h} \frac{w_{s,1}}{h}$	0	-.782	.485	0	.0584	-.00831	0
$\left(\frac{w_{s,s}}{h}\right)^3$	0	0	0	0	0	0	0
$\left(\frac{w_{s,s}}{h}\right)^2 \frac{w_{1,s}}{h}$	0	1.850	0	.0514	-.01320	0	0
$\left(\frac{w_{s,s}}{h}\right)^2 \frac{w_{s,1}}{h}$	0	.566	0	.1233	0	0	-.0001857
$\frac{w_{s,s}}{h} \left(\frac{w_{1,s}}{h}\right)^2$	0	0	0	0	0	0	0
$\frac{w_{s,s}}{h} \left(\frac{w_{s,1}}{h}\right)^2$	-.0001408	0	-.803	0	-.0314	0	0
$\frac{w_{s,s}}{h} \frac{w_{1,s}}{h} \frac{w_{s,1}}{h}$	0	0	0	0	0	0	0
$\left(\frac{w_{1,s}}{h}\right)^3$	0	1.920	-.2065	0	0	0	0
$\left(\frac{w_{1,s}}{h}\right)^2 \frac{w_{s,1}}{h}$	0	0	0	0	0	0	0
$\frac{w_{1,s}}{h} \left(\frac{w_{s,1}}{h}\right)^2$	0	2.51	0	0	0	.01672	-.00285
$\left(\frac{w_{s,1}}{h}\right)^3$	0	0	0	0	0	0	0

NACA Technical Note No. 853
 TABLE 2 (Continued)

	0 =	0 =	0 =	0 =	0 =	0 =	0 =
1	$\frac{w_{1s,s}}{h}$	$\frac{w_{1,t}}{h}$	$\frac{w_{3,t}}{h}$	$\frac{w_{5,t}}{h}$	$\frac{w_{7,t}}{h}$	$\frac{w_{9,t}}{h}$	$\frac{w_{11,t}}{h}$
$\frac{pa^4}{Eh}$	-.0000000851	-.0000495	-.00000903	-.00000235	-.000000731	-.0000003705	-.0000001148
$\frac{pa^4}{Eh}$	-.00002765k _s	-.00243k ₁	-.001328k ₃	-.000575k ₅	-.000251k ₇	-.0001190k ₉	-.0000619k ₁₁
$\frac{pa^4}{Eh}$	-.0000719t _s	-.000347t ₁	-.000583t ₃	-.000410t ₅	-.000251t ₇	-.0001530t ₉	-.0000973t ₁₁
$\left(\frac{w_{1,1}}{h}\right)^2$	0	0	0	0	0	0	0
$\left(\frac{w_{1,1}}{h}\right)^2 \frac{w_{1,3}}{h}$	0	0	0	0	0	0	0
$\left(\frac{w_{1,1}}{h}\right)^2 \frac{w_{3,1}}{h}$	0	0	0	0	0	0	0
$\left(\frac{w_{1,1}}{h}\right)^2 \frac{w_{3,3}}{h}$	0	0	0	0	0	0	0
$\left(\frac{w_{1,1}}{h}\right)^2 \frac{w_{5,1}}{h}$	0	-.00456	.0000900	0	0	0	0
$\left(\frac{w_{1,1}}{h}\right)^2 \frac{w_{5,3}}{h}$	0	0	0	0	0	0	0
$\frac{w_{1,1}}{h} \left(\frac{w_{1,3}}{h}\right)^2$	0	-.00474	.00001822	0	0	0	0
$\frac{w_{1,1}}{h} \left(\frac{w_{3,1}}{h}\right)^2$	0	0	0	0	0	0	0
$\frac{w_{1,1}}{h} \left(\frac{w_{3,3}}{h}\right)^2$	0	-.0380	0	-.000841	0	0	0
$\frac{w_{1,1}}{h} \left(\frac{w_{5,1}}{h}\right)^2$	0	0	0	0	0	0	0
$\frac{w_{1,1}}{h} \left(\frac{w_{5,3}}{h}\right)^2$	0	0	0	0	0	0	0
$\frac{w_{1,1}}{h} \frac{w_{1,3}}{h} \frac{w_{3,1}}{h}$	0	0	0	0	0	0	0
$\frac{w_{1,1}}{h} \frac{w_{1,3}}{h} \frac{w_{3,3}}{h}$	0	.01611	-.01428	.0000797	0	0	0
$\frac{w_{1,1}}{h} \frac{w_{1,3}}{h} \frac{w_{5,1}}{h}$	0	.0332	-.00454	0	0	0	0
$\frac{w_{1,1}}{h} \frac{w_{1,3}}{h} \frac{w_{5,3}}{h}$	0	0	0	0	0	0	0
$\frac{w_{1,1}}{h} \frac{w_{3,1}}{h} \frac{w_{3,3}}{h}$	0	0	0	0	0	0	0
$\frac{w_{1,1}}{h} \frac{w_{3,1}}{h} \frac{w_{5,1}}{h}$	0	.03245	-.02215	.000920	0	0	0
$\frac{w_{1,1}}{h} \frac{w_{3,1}}{h} \frac{w_{5,3}}{h}$	0	0	0	0	0	0	0
$\frac{w_{1,1}}{h} \frac{w_{3,3}}{h} \frac{w_{5,1}}{h}$	0	-.0272	.0251	-.00352	0	0	0

NACA Technical Note No. 853
 TABLE 2 (Continued)

$\frac{w_{1,1}}{h} \frac{w_{3,2}}{h} \frac{w_{5,1}}{h}$	0	0	0	0	0	0	0
$\frac{w_{1,1}}{h} \frac{w_{1,5}}{h} \frac{w_{5,1}}{h}$	0	0	.0228	-.0204	.001021	0	0
$\left(\frac{w_{1,3}}{h}\right)^3$	0	0	0	0	0	0	0
$\left(\frac{w_{1,3}}{h}\right)^2 \frac{w_{3,1}}{h}$	0	.0208	-.01120	.000468	0	0	0
$\left(\frac{w_{1,3}}{h}\right)^2 \frac{w_{3,5}}{h}$	0	0	0	0	0	0	0
$\left(\frac{w_{1,3}}{h}\right)^2 \frac{w_{1,5}}{h}$	0	0	0	0	0	0	0
$\left(\frac{w_{1,3}}{h}\right)^2 \frac{w_{5,1}}{h}$	0	0	.01730	-.01268	.000548	0	0
$\frac{w_{1,3}}{h} \left(\frac{w_{3,1}}{h}\right)^2$	0	0	0	0	0	0	0
$\frac{w_{1,3}}{h} \left(\frac{w_{3,5}}{h}\right)^2$	0	0	0	0	0	0	0
$\frac{w_{1,3}}{h} \left(\frac{w_{1,5}}{h}\right)^2$	0	.0750	-.01728	0	0	0	0
$\frac{w_{1,3}}{h} \left(\frac{w_{5,1}}{h}\right)^2$	0	0	0	0	0	0	0
$\frac{w_{1,5}}{h} \frac{w_{3,1}}{h} \frac{w_{5,5}}{h}$	0	-.1502	0	-.00796	.000274	0	0
$\frac{w_{1,5}}{h} \frac{w_{3,1}}{h} \frac{w_{1,5}}{h}$	0	-.1124	.0698	-.00827	0	0	0
$\frac{w_{1,5}}{h} \frac{w_{3,1}}{h} \frac{w_{5,1}}{h}$	0	0	0	0	0	0	0
$\frac{w_{1,5}}{h} \frac{w_{3,5}}{h} \frac{w_{1,5}}{h}$	0	0	0	0	0	0	0
$\frac{w_{1,5}}{h} \frac{w_{3,5}}{h} \frac{w_{5,1}}{h}$	0	.1490	-.0867	0	-.00808	-.000491	0
$\frac{w_{1,5}}{h} \frac{w_{1,5}}{h} \frac{w_{5,1}}{h}$	0	0	-.0819	.0538	-.00580	0	0
$\left(\frac{w_{3,1}}{h}\right)^3$	0	0	0	0	0	0	0
$\left(\frac{w_{3,1}}{h}\right)^2 \frac{w_{3,5}}{h}$	0	0	0	0	0	0	0

NACA Technical Note No. 853
 TABLE 2 (Continued)

$\left(\frac{w_{s,1}}{h}\right)^2 \frac{w_{1,s}}{h}$	0	-.1013	0	-.00999	.000997	0	0
$\left(\frac{w_{s,1}}{h}\right)^2 \frac{w_{s,1}}{h}$	0	0	0	0	0	0	0
$\frac{w_{s,1}}{h} \left(\frac{w_{s,s}}{h}\right)^2$	0	0	-.1757	0	0	.00000880	0
$\frac{w_{s,1}}{h} \left(\frac{w_{1,s}}{h}\right)^2$	0	0	0	0	0	0	0
$\frac{w_{s,1}}{h} \left(\frac{w_{s,1}}{h}\right)^2$	0	0	0	0	0	0	0
$\frac{w_{s,1}}{h} \frac{w_{s,s}}{h} \frac{w_{1,s}}{h}$	0	.273	0	.0224	-.00362	0	0
$\frac{w_{s,1}}{h} \frac{w_{s,1}}{h} \frac{w_{s,1}}{h}$	0	0	0	0	0	0	0
$\frac{w_{s,1}}{h} \frac{w_{1,s}}{h} \frac{w_{s,1}}{h}$	0	.2105	-.1268	0	-.01682	.00204	0
$\left(\frac{w_{s,s}}{h}\right)^3$	0	0	0	0	0	0	0
$\left(\frac{w_{s,s}}{h}\right)^2 \frac{w_{1,s}}{h}$	0	0	0	0	0	0	0
$\left(\frac{w_{s,s}}{h}\right)^2 \frac{w_{s,1}}{h}$	0	-.219	0	-.0774	0	0	.0000868
$\frac{w_{s,s}}{h} \left(\frac{w_{1,s}}{h}\right)^2$	0	-.1600	.1152	-.02026	0	0	0
$\frac{w_{s,s}}{h} \left(\frac{w_{s,1}}{h}\right)^2$.00001683	0	0	0	0	0	0
$\frac{w_{s,s}}{h} \frac{w_{1,s}}{h} \frac{w_{s,1}}{h}$	0	-.344	.1475	0	.01793	-.00331	0
$\left(\frac{w_{1,s}}{h}\right)^3$	0	0	0	0	0	0	0
$\left(\frac{w_{1,s}}{h}\right)^2 \frac{w_{s,1}}{h}$	0	0	0	0	0	0	0
$\frac{w_{1,s}}{h} \left(\frac{w_{s,1}}{h}\right)^2$	0	-.2995	0	0	0	-.00563	.000862
$\left(\frac{w_{s,1}}{h}\right)^3$	0	0	0	0	0	0	0

NACA Technical Note No. 853
 TABLE 2 (Continued)

	0 =	0 =	0 =	0 =	0 =
l	$\frac{w_{1,0}}{h}$	$\frac{w_{3,0}}{h}$	$\frac{w_{5,0}}{h}$	$\frac{w_{7,0}}{h}$	$\frac{w_{9,0}}{h}$
$\frac{pa^4}{Eh^4}$	-.00001461	-.00000329	-.000001072	-.000000386	-.0000001221
$\frac{pb^4}{Eh^4}$	-.001183k ₁	-.000801k ₃	-.000434k ₅	-.000224k ₇	-.0001182k ₉
$\frac{pc^4}{Eh^4}$	-.0001315t ₀	-.000267t ₀	-.000241t ₀	-.0001744t ₀	-.0001182t ₀
$\left(\frac{w_{1,1}}{h}\right)^3$	0	0	0	0	0
$\left(\frac{w_{1,1}}{h}\right)^2 \frac{w_{1,3}}{h}$	0	0	0	0	0
$\left(\frac{w_{1,1}}{h}\right)^2 \frac{w_{3,1}}{h}$	0	0	0	0	0
$\left(\frac{w_{1,1}}{h}\right)^2 \frac{w_{5,3}}{h}$	0	0	0	0	0
$\left(\frac{w_{1,1}}{h}\right)^2 \frac{w_{1,5}}{h}$	0	0	0	0	0
$\left(\frac{w_{1,1}}{h}\right)^2 \frac{w_{5,1}}{h}$	0	0	0	0	0
$\frac{w_{1,1}}{h} \left(\frac{w_{1,3}}{h}\right)^2$	0	0	0	0	0
$\frac{w_{1,1}}{h} \left(\frac{w_{3,1}}{h}\right)^2$	0	0	0	0	0
$\frac{w_{1,1}}{h} \left(\frac{w_{5,3}}{h}\right)^2$	0	0	0	0	0
$\frac{w_{1,1}}{h} \left(\frac{w_{1,5}}{h}\right)^2$.00706	-.000692	0	0	0
$\frac{w_{1,1}}{h} \left(\frac{w_{5,1}}{h}\right)^2$	0	0	0	0	0
$\frac{w_{1,1}}{h} \frac{w_{1,3}}{h} \frac{w_{3,1}}{h}$	0	0	0	0	0
$\frac{w_{1,1}}{h} \frac{w_{1,5}}{h} \frac{w_{3,3}}{h}$	0	0	0	0	0
$\frac{w_{1,1}}{h} \frac{w_{1,3}}{h} \frac{w_{1,5}}{h}$	-.00418	.0000850	0	0	0
$\frac{w_{1,1}}{h} \frac{w_{1,5}}{h} \frac{w_{5,1}}{h}$	0	0	0	0	0
$\frac{w_{1,1}}{h} \frac{w_{3,1}}{h} \frac{w_{5,3}}{h}$	0	0	0	0	0
$\frac{w_{1,1}}{h} \frac{w_{3,1}}{h} \frac{w_{1,5}}{h}$	0	0	0	0	0
$\frac{w_{1,1}}{h} \frac{w_{5,1}}{h} \frac{w_{5,3}}{h}$	0	0	0	0	0
$\frac{w_{1,1}}{h} \frac{w_{3,3}}{h} \frac{w_{1,5}}{h}$.01081	-.00813	.000248	0	0

NACA Technical Note No. 853
 TABLE 2 (Continued)

$\frac{w_{1,1} w_{s,s} w_{s,1}}{h h h}$	0	0	0	0	0
$\frac{w_{1,1} w_{1,s} w_{s,1}}{h h h}$	0	0	0	0	0
$\left(\frac{w_{1,s}}{h}\right)^2$	-.000494	0	0	0	0
$\left(\frac{w_{1,s}}{h}\right)^2 \frac{w_{s,1}}{h}$	0	0	0	0	0
$\left(\frac{w_{1,s}}{h}\right)^2 \frac{w_{s,s}}{h}$.00505	-.00378	.0000453	0	0
$\left(\frac{w_{1,s}}{h}\right)^2 \frac{w_{1,s}}{h}$	0	0	0	0	0
$\left(\frac{w_{1,s}}{h}\right)^2 \frac{w_{s,1}}{h}$	0	0	0	0	0
$\frac{w_{1,s}}{h} \left(\frac{w_{s,1}}{h}\right)^2$	0	0	0	0	0
$\frac{w_{1,s}}{h} \left(\frac{w_{s,s}}{h}\right)^2$	-.0277	0	-.001857	.0000234	0
$\frac{w_{1,s}}{h} \left(\frac{w_{1,s}}{h}\right)^2$	0	0	0	0	0
$\frac{w_{1,s}}{h} \left(\frac{w_{s,1}}{h}\right)^2$	0	0	0	0	0
$\frac{w_{1,s} w_{s,1} w_{s,s}}{h h h}$	0	0	0	0	0
$\frac{w_{1,s} w_{s,1} w_{1,s}}{h h h}$.0247	-.01657	.001412	0	0
$\frac{w_{1,s} w_{s,1} w_{s,1}}{h h h}$	0	0	0	0	0
$\frac{w_{1,s} w_{s,s} w_{1,s}}{h h h}$	0	0	0	0	0
$\frac{w_{1,s} w_{s,s} w_{s,1}}{h h h}$	0	0	0	0	0
$\frac{w_{1,s} w_{1,s} w_{s,1}}{h h h}$	0	.0328	-.02305	.001986	0
$\left(\frac{w_{s,1}}{h}\right)^2$	0	0	0	0	0
$\left(\frac{w_{s,1}}{h}\right)^2 \frac{w_{s,s}}{h}$	0	0	0	0	0

NACA Technical Note No. 853
 TABLE 2 (Concluded)

$\left(\frac{w_{s,1}}{h}\right)^2 \frac{w_{1,s}}{h}$	0	0	0	0	0
$\left(\frac{w_{s,1}}{h}\right)^2 \frac{w_{s,1}}{h}$	0	0	0	0	0
$\frac{w_{s,1}}{h} \left(\frac{w_{s,s}}{h}\right)^2$	0	0	0	0	0
$\frac{w_{s,1}}{h} \left(\frac{w_{1,s}}{h}\right)^2$	-.0303	.0250	-.00440	0	0
$\frac{w_{s,1}}{h} \left(\frac{w_{s,1}}{h}\right)^2$	0	0	0	0	0
$\frac{w_{s,1}}{h} \frac{w_{s,s}}{h} \frac{w_{1,s}}{h}$	-.0875	0	-.00942	.000908	0
$\frac{w_{s,1}}{h} \frac{w_{s,1}}{h} \frac{w_{s,1}}{h}$	0	0	0	0	0
$\frac{w_{s,1}}{h} \frac{w_{1,s}}{h} \frac{w_{s,1}}{h}$	0	0	0	0	0
$\left(\frac{w_{s,s}}{h}\right)^2$	0	-.0270	0	0	0
$\left(\frac{w_{s,s}}{h}\right)^2 \frac{w_{1,s}}{h}$	0	0	0	0	0
$\left(\frac{w_{s,s}}{h}\right)^2 \frac{w_{s,1}}{h}$	0	0	0	0	0
$\frac{w_{s,s}}{h} \left(\frac{w_{1,s}}{h}\right)^2$	0	0	0	0	0
$\frac{w_{s,s}}{h} \left(\frac{w_{s,1}}{h}\right)^2$	0	0	0	0	0
$\frac{w_{s,s}}{h} \frac{w_{1,s}}{h} \frac{w_{s,1}}{h}$.1218	-.0603	0	-.00966	.001280
$\left(\frac{w_{1,s}}{h}\right)^2$	0	0	0	0	0
$\left(\frac{w_{1,s}}{h}\right)^2 \frac{w_{s,1}}{h}$	0	-.0409	.0295	-.00454	0
$\frac{w_{1,s}}{h} \left(\frac{w_{s,1}}{h}\right)^2$	0	0	0	0	0
$\left(\frac{w_{s,1}}{h}\right)^3$	0	0	0	0	0

Table 3.- Equations for Determining the Moment Coefficients k_m and t_n

	0 =	0 =	0 =	0 =	0 =	0 =	0 =
$\frac{pa^4}{Eh^4}$	-.08882	-.002886	-.0003807	-.0000993	-.0000363	-.0000163	-.0000084
$\frac{pa^4}{Eh^4}$	-.1280t ₁	-.03605t ₂	-.02121t ₃	-.01516t ₄	-.01179t ₅	-.00864t ₁₁	-.00815t ₁₂
$\frac{pa^4}{Eh^4}$	-.0862k ₁	-.02160k ₁	-.00613k ₁	-.00243k ₁	-.001183k ₁	-.00659k ₁	-.000404k ₁
$\frac{pa^4}{Eh^4}$	-.006045k ₃	-.00960k ₃	-.00666k ₃	-.00398k ₃	-.002403k ₃	-.001506k ₃	-.000992k ₃
$\frac{pa^4}{Eh^4}$	-.001388k ₅	-.00321k ₅	-.00345k ₅	-.002875k ₅	-.00217k ₅	-.001595k ₅	-.001168k ₅
$\frac{pa^4}{Eh^4}$	-.000515k ₇	-.001345k ₇	-.001743k ₇	-.001757k ₇	-.001568k ₇	-.001311k ₇	-.001063k ₇
$\frac{pa^4}{Eh^4}$	-.000244k ₉	-.000671k ₉	-.000953k ₉	-.001071k ₉	-.001066k ₉	-.000982k ₉	-.000883k ₉
$\frac{pa^4}{Eh^4}$	-.000134k ₁₁	-.000380k ₁₁	-.000566k ₁₁	-.000681k ₁₁	-.000734k ₁₁	-.000714k ₁₁	-.000668k ₁₁
$\frac{pa^4}{Eh^4}$	-.000082k ₁₃	-.000235k ₁₃	-.000359k ₁₃	-.000450k ₁₃	-.000501k ₁₃	-.000517k ₁₃	-.000510k ₁₃
$\left(\frac{w_{1,1}}{h}\right)^2$	1.446	-.02705	0	0	0	0	0
$\left(\frac{w_{1,1}}{h}\right)^2 \frac{w_{1,3}}{h}$	-.938	.424	-.01475	0	0	0	0
$\left(\frac{w_{1,1}}{h}\right)^2 \frac{w_{3,1}}{h}$.596	-.0682	0	0	0	0	0
$\left(\frac{w_{1,1}}{h}\right)^2 \frac{w_{3,3}}{h}$	-.2025	.328	-.0367	0	0	0	0
$\left(\frac{w_{1,1}}{h}\right)^2 \frac{w_{1,5}}{h}$	0	-.0625	.1208	-.00429	0	0	0
$\left(\frac{w_{1,1}}{h}\right)^2 \frac{w_{5,1}}{h}$.456	-.0914	0	0	0	0	0
$\frac{w_{1,1}}{h} \left(\frac{w_{1,3}}{h}\right)^2$	5.19	0	.0341	-.00469	0	0	0
$\frac{w_{1,1}}{h} \left(\frac{w_{3,1}}{h}\right)^2$	11.33	-.420	0	0	0	0	0
$\frac{w_{1,1}}{h} \left(\frac{w_{3,3}}{h}\right)^2$	10.59	0	.0740	-.0392	0	0	0
$\frac{w_{1,1}}{h} \left(\frac{w_{1,5}}{h}\right)^2$	10.08	0	0	0	.00498	-.001064	0
$\frac{w_{1,1}}{h} \left(\frac{w_{5,1}}{h}\right)^2$	29.35	-.812	0	0	0	0	0
$\frac{w_{1,1}}{h} \frac{w_{1,3}}{h} \frac{w_{3,1}}{h}$.333	.1235	-.0486	0	0	0	0
$\frac{w_{1,1}}{h} \frac{w_{1,5}}{h} \frac{w_{3,3}}{h}$	-.264	0	.0596	-.02633	0	0	0
$\frac{w_{1,1}}{h} \frac{w_{1,3}}{h} \frac{w_{1,5}}{h}$	-1.797	.3121	0	.0196	-.00392	0	0

NACA Technical Note No. 855
 TABLE 3 (Continued)

$\frac{w_{1,1}}{h} \frac{w_{1,3}}{h} \frac{w_{5,1}}{h}$	-.0806	.1553	-.0710	0	0	0	0
$\frac{w_{1,1}}{h} \frac{w_{3,1}}{h} \frac{w_{3,3}}{h}$	-5.95	1.440	-.2173	0	0	0	0
$\frac{w_{1,1}}{h} \frac{w_{3,1}}{h} \frac{w_{1,5}}{h}$	0	-.0974	.1305	-.0284	0	0	0
$\frac{w_{1,1}}{h} \frac{w_{3,1}}{h} \frac{w_{5,1}}{h}$	-.109	.0600	0	0	0	0	0
$\frac{w_{1,1}}{h} \frac{w_{3,3}}{h} \frac{w_{1,5}}{h}$.482	-.073	0	.0305	-.01234	0	0
$\frac{w_{1,1}}{h} \frac{w_{3,3}}{h} \frac{w_{5,1}}{h}$.199	-.100	-.0628	0	0	0	0
$\frac{w_{1,1}}{h} \frac{w_{1,5}}{h} \frac{w_{5,1}}{h}$	0	.0671	.0146	-.0264	0	0	0
$\left(\frac{w_{1,3}}{h}\right)^2$	0	1.440	0	0	-.000494	0	0
$\left(\frac{w_{1,3}}{h}\right)^2 \frac{w_{3,1}}{h}$	-.640	0	.00885	-.0105	0	0	0
$\left(\frac{w_{1,3}}{h}\right)^2 \frac{w_{3,3}}{h}$	0	.510	0	0	-.00600	0	0
$\left(\frac{w_{1,3}}{h}\right)^2 \frac{w_{1,5}}{h}$	2.384	0	.594	0	0	-.000705	0
$\left(\frac{w_{1,3}}{h}\right)^2 \frac{w_{5,1}}{h}$.493	0	.0008	-.0077	0	0	0
$\frac{w_{1,3}}{h} \left(\frac{w_{3,1}}{h}\right)^2$	-5.07	2.78	-.2535	0	0	0	0
$\frac{w_{1,3}}{h} \left(\frac{w_{3,3}}{h}\right)^2$	0	4.78	0	0	-.0368	0	0
$\frac{w_{1,3}}{h} \left(\frac{w_{1,5}}{h}\right)^2$	0	3.79	0	.0231	0	0	-.000376
$\frac{w_{1,3}}{h} \left(\frac{w_{5,1}}{h}\right)^2$	-9.74	5.21	-.447	0	0	0	0
$\frac{w_{1,3}}{h} \frac{w_{3,1}}{h} \frac{w_{3,3}}{h}$	17.10	0	.600	-.1880	0	0	0
$\frac{w_{1,3}}{h} \frac{w_{3,1}}{h} \frac{w_{1,5}}{h}$	-2.46	-.156	0	.0556	-.0180	0	0
$\frac{w_{1,3}}{h} \frac{w_{3,1}}{h} \frac{w_{5,1}}{h}$	1.641	.504	-.2372	0	0	0	0
$\frac{w_{1,3}}{h} \frac{w_{3,3}}{h} \frac{w_{1,5}}{h}$	-2.75	0	.1885	0	0	-.00744	0
$\frac{w_{1,3}}{h} \frac{w_{3,3}}{h} \frac{w_{5,1}}{h}$	-4.89	0	.0931	-.104	0	0	0

NACA Technical Note No. 853
 TABLE 3 (Continued)

$\frac{w_{1,s}}{h} \frac{w_{1,s}}{h} \frac{w_{s,1}}{h}$.650	-.585	0	-.018	-.0029	0	0
$\left(\frac{w_{s,1}}{h}\right)^3$	6.06	-.972	0	0	0	0	0
$\left(\frac{w_{s,1}}{h}\right)^2 \frac{w_{s,s}}{h}$	-5.51	6.49	-1.223	0	0	0	0
$\left(\frac{w_{s,1}}{h}\right)^2 \frac{w_{1,s}}{h}$	0	-1.463	1.233	-.1442	0	0	0
$\left(\frac{w_{s,1}}{h}\right)^2 \frac{w_{s,1}}{h}$	6.12	-1.584	0	0	0	0	0
$\frac{w_{s,1}}{h} \left(\frac{w_{s,s}}{h}\right)^2$	12.25	0	1.276	-.527	0	0	0
$\frac{w_{s,1}}{h} \left(\frac{w_{1,s}}{h}\right)^2$	-1.206	0	0	0	.0227	-.00750	0
$\frac{w_{s,1}}{h} \left(\frac{w_{s,1}}{h}\right)^2$	17.39	-3.401	0	0	0	0	0
$\frac{w_{s,1}}{h} \frac{w_{s,s}}{h} \frac{w_{1,s}}{h}$	-14.86	3.36	0	.360	-.1282	0	0
$\frac{w_{s,1}}{h} \frac{w_{s,s}}{h} \frac{w_{s,1}}{h}$	-7.45	7.25	-2.035	0	0	0	0
$\frac{w_{s,1}}{h} \frac{w_{1,s}}{h} \frac{w_{s,1}}{h}$	0	-.514	1.014	-.270	0	0	0
$\left(\frac{w_{s,s}}{h}\right)^3$	0	4.34	0	0	-.0810	0	0
$\left(\frac{w_{s,s}}{h}\right)^2 \frac{w_{1,s}}{h}$	5.78	0	2.015	0	0	-.02834	0
$\left(\frac{w_{s,s}}{h}\right)^2 \frac{w_{s,1}}{h}$	11.17	0	1.180	-.606	0	0	0
$\frac{w_{s,s}}{h} \left(\frac{w_{1,s}}{h}\right)^2$	0	1.52	0	.0844	0	0	-.002889
$\frac{w_{s,s}}{h} \left(\frac{w_{s,1}}{h}\right)^2$	-6.59	11.01	-2.629	0	0	0	0
$\frac{w_{s,s}}{h} \frac{w_{1,s}}{h} \frac{w_{s,1}}{h}$	4.44	.52	0	.195	-.1153	0	0
$\left(\frac{w_{1,s}}{h}\right)^3$	0	0	1.300	0	0	0	0
$\left(\frac{w_{1,s}}{h}\right)^2 \frac{w_{s,1}}{h}$.639	0	0	0	-.0070	-.00089	0
$\frac{w_{1,s}}{h} \left(\frac{w_{s,1}}{h}\right)^2$	0	-2.61	2.63	-.3294	0	0	0
$\left(\frac{w_{s,1}}{h}\right)^3$	10.60	-2.51	0	0	0	0	0

NACA Technical Note No. 853

TABLE 3 (Continued)

$\frac{pa^4}{Eh^4}$	0 =	0 =	0 =	0 =	0 =	0 =	0 =
	-.0953	-.001306	-.0001693	-.0000440	-.0000181	-.0000073	-.0000037
$\frac{pa^4}{Eh^4}$	-.2539k ₁	-.0795k ₂	-.04767k ₃	-.0340k ₄	-.02841k ₅	-.02153k _{1,1}	-.01832k _{1,3}
$\frac{pa^4}{Eh^4}$	-.0882t ₁	-.00605t ₁	-.001388t ₁	-.000514t ₁	-.000244t ₁	-.0001342t ₁	-.0000814t ₁
$\frac{pa^4}{Eh^4}$	-.0216t ₃	-.00980t ₃	-.00321t ₃	-.001344t ₃	-.000672t ₃	-.000380t ₃	-.0002346t ₃
$\frac{pa^4}{Eh^4}$	-.00613t ₅	-.00567t ₅	-.00345t ₅	-.001740t ₅	-.000954t ₅	-.000566t ₅	-.000356t ₅
$\frac{pa^4}{Eh^4}$	-.00243t ₇	-.00398t ₇	-.00287t ₇	-.001760t ₇	-.001071t ₇	-.000681t ₇	-.000450t ₇
$\frac{pa^4}{Eh^4}$	-.001184t ₉	-.002403t ₉	-.00217t ₉	-.001570t ₉	-.001084t ₉	-.000723t ₉	-.000501t ₉
$\frac{pa^4}{Eh^4}$	-.000659t ₁₁	-.001508t ₁₁	-.001593t ₁₁	-.001311t ₁₁	-.000982t ₁₁	-.000712t ₁₁	-.000517t ₁₁
$\frac{pa^4}{Eh^4}$	-.000404t ₁₃	-.000991t ₁₃	-.001187t ₁₃	-.001062t ₁₃	-.000863t ₁₃	-.000689t ₁₃	-.000510t ₁₃
$\left(\frac{w_{1,1}}{h}\right)^3$	1.370	-.001497	0.	0.	0.	0	0
$\left(\frac{w_{1,1}}{h}\right)^2 \frac{w_{1,3}}{h}$.298	-.01245	0	0	0	0	0
$\left(\frac{w_{1,1}}{h}\right)^2 \frac{w_{3,1}}{h}$	-.0690	.155	-.000687	0	0	0	0
$\left(\frac{w_{1,1}}{h}\right)^2 \frac{w_{3,3}}{h}$	-.1148	.2434	-.00365	0	0	0	0
$\left(\frac{w_{1,1}}{h}\right)^2 \frac{w_{1,5}}{h}$.452	-.02181	0	0	0	0	0
$\left(\frac{w_{1,1}}{h}\right)^2 \frac{w_{5,1}}{h}$	0	.00458	.0338	-.000177	0	0	0
$\frac{w_{1,1}}{h} \left(\frac{w_{1,3}}{h}\right)^2$	5.55	-.0767	0	0	0	0	0
$\frac{w_{1,1}}{h} \left(\frac{w_{3,1}}{h}\right)^2$	10.08	0	.00330	-.000228	0	0	0
$\frac{w_{1,1}}{h} \left(\frac{w_{3,3}}{h}\right)^2$	10.59	0	.01681	-.00296	0	0	0
$\frac{w_{1,1}}{h} \left(\frac{w_{1,5}}{h}\right)^2$	10.55	-.1442	0	0	0	0	0
$\frac{w_{1,1}}{h} \left(\frac{w_{5,1}}{h}\right)^2$	26.92	0	0	0	.000282	-.0000485	0
$\frac{w_{1,1}}{h} \frac{w_{1,3}}{h} \frac{w_{3,1}}{h}$	-.092	.1975	-.00802	0	0	0	0
$\frac{w_{1,1}}{h} \frac{w_{1,3}}{h} \frac{w_{3,3}}{h}$	-1.528	.512	-.0318	0	0	0	0
$\frac{w_{1,1}}{h} \frac{w_{1,3}}{h} \frac{w_{1,5}}{h}$	-.430	-.1098	0	0	0	0	0

NACA Technical Note No. 853
 TABLE 3 (Continued)

$\frac{W_{1,1}}{h} \frac{W_{1,3}}{h} \frac{W_{3,1}}{h}$	0	-.1042	.0742	-.00387	0	0	0
$\frac{W_{1,1}}{h} \frac{W_{3,1}}{h} \frac{W_{3,3}}{h}$	-2.75	0	.00838	-.001830	0	0	0
$\frac{W_{1,1}}{h} \frac{W_{3,1}}{h} \frac{W_{1,3}}{h}$.449	-.0880	-.00736	0	0	0	0
$\frac{W_{1,1}}{h} \frac{W_{3,1}}{h} \frac{W_{3,1}}{h}$.271	-.0868	0	.000252	-.0001779	0	0
$\frac{W_{1,1}}{h} \frac{W_{3,3}}{h} \frac{W_{1,3}}{h}$.049	.163	-.0344	0	0	0	0
$\frac{W_{1,1}}{h} \frac{W_{3,3}}{h} \frac{W_{3,1}}{h}$	-.801	.1243	0	.00268	-.000710	0	0
$\frac{W_{1,1}}{h} \frac{W_{1,3}}{h} \frac{W_{3,1}}{h}$	0	-.0141	.0349	-.00614	0	0	0
$\left(\frac{W_{1,3}}{h}\right)^3$	4.89	-.192	0	0	0	0	0
$\left(\frac{W_{1,3}}{h}\right)^2 \frac{W_{3,1}}{h}$	-3.188	.890	-.0338	0	0	0	0
$\left(\frac{W_{1,3}}{h}\right)^2 \frac{W_{3,3}}{h}$	-3.85	1.970	-.1208	0	0	0	0
$\left(\frac{W_{1,3}}{h}\right)^2 \frac{W_{1,3}}{h}$	7.167	-.6072	0	0	0	0	0
$\left(\frac{W_{1,3}}{h}\right)^2 \frac{W_{3,1}}{h}$	0	-.2314	.2440	-.01184	0	0	0
$\frac{W_{1,3}}{h} \left(\frac{W_{3,1}}{h}\right)^2$	1.89	0	.0278	-.00268	0	0	0
$\frac{W_{1,3}}{h} \left(\frac{W_{3,3}}{h}\right)^2$	13.31	0	.1975	-.03894	0	0	0
$\frac{W_{1,3}}{h} \left(\frac{W_{1,3}}{h}\right)^2$	15.49	-1.312	0	0	0	0	0
$\frac{W_{1,3}}{h} \left(\frac{W_{3,1}}{h}\right)^2$	3.54	0	0	0	.00487	-.000919	0
$\frac{W_{1,3}}{h} \frac{W_{3,1}}{h} \frac{W_{3,3}}{h}$	18.12	0	.1592	-.02118	0	0	0
$\frac{W_{1,3}}{h} \frac{W_{3,1}}{h} \frac{W_{1,3}}{h}$	-.24	.985	-.0978	0	0	0	0
$\frac{W_{1,3}}{h} \frac{W_{3,1}}{h} \frac{W_{3,1}}{h}$	1.02	.274	0	.0208	-.002814	0	0
$\frac{W_{1,3}}{h} \frac{W_{3,3}}{h} \frac{W_{1,3}}{h}$	-9.28	3.129	-.400	0	0	0	0
$\frac{W_{1,3}}{h} \frac{W_{3,3}}{h} \frac{W_{3,1}}{h}$	-8.92	1.161	0	.0544	-.01045	0	0

NACA Technical Note No. 853
 TABLE 3 (Concluded)

$\frac{w_{1,s}}{h} \frac{w_{1,s}}{h} \frac{w_{s,1}}{h}$	0	-.997	.4212	-.05233	0	0	0
$\left(\frac{w_{s,1}}{h}\right)^3$	0	1.048	0	0	-.0000201	0	0
$\left(\frac{w_{s,1}}{h}\right)^2 \frac{w_{s,s}}{h}$	0	2.616	0	0	-.000499	0	0
$\left(\frac{w_{s,1}}{h}\right)^2 \frac{w_{1,s}}{h}$.75	0	.0080	-.00296	0	0	0
$\left(\frac{w_{s,1}}{h}\right)^2 \frac{w_{s,1}}{h}$.190	0	.235	0	0	-.0000287	0
$\frac{w_{s,1}}{h} \left(\frac{w_{s,s}}{h}\right)^2$	0	4.99	0	0	-.002782	0	0
$\frac{w_{s,1}}{h} \left(\frac{w_{1,s}}{h}\right)^2$	-6.11	1.875	-.1193	0	0	0	0
$\frac{w_{s,1}}{h} \left(\frac{w_{s,1}}{h}\right)^2$	0	2.40	0	-.00237	0	0	-.0000015
$\frac{w_{s,1}}{h} \frac{w_{s,s}}{h} \frac{w_{1,s}}{h}$	-3.95	0	.1526	-.0352	0	0	0
$\frac{w_{s,1}}{h} \frac{w_{s,s}}{h} \frac{w_{s,1}}{h}$	1.21	0	.582	0	0	-.000586	0
$\frac{w_{s,1}}{h} \frac{w_{1,s}}{h} \frac{w_{s,1}}{h}$	2.600	-.374	0	.03048	-.00537	0	0
$\left(\frac{w_{s,s}}{h}\right)^3$	0	4.11	0	0	-.00450	0	0
$\left(\frac{w_{s,s}}{h}\right)^2 \frac{w_{1,s}}{h}$	14.32	0	.361	-.0828	0	0	0
$\left(\frac{w_{s,s}}{h}\right)^2 \frac{w_{s,1}}{h}$	7.93	0	.988	0	0	-.001765	0
$\frac{w_{s,s}}{h} \left(\frac{w_{1,s}}{h}\right)^2$	-9.14	5.60	-.5116	0	0	0	0
$\frac{w_{s,s}}{h} \left(\frac{w_{s,1}}{h}\right)^2$	0	4.37	0	.0305	0	0	-.000225
$\frac{w_{s,s}}{h} \frac{w_{1,s}}{h} \frac{w_{s,1}}{h}$	-.91	2.237	0	.1084	-.02459	0	0
$\left(\frac{w_{1,s}}{h}\right)^3$	9.60	-1.03	0	0	0	0	0
$\left(\frac{w_{1,s}}{h}\right)^2 \frac{w_{s,1}}{h}$	0	-.844	.708	-.0631	0	0	0
$\frac{w_{1,s}}{h} \left(\frac{w_{s,1}}{h}\right)^2$	2.86	0	0	0	.00978	-.00426	0
$\left(\frac{w_{s,1}}{h}\right)^3$	0	0	.614	0	0	0	0

Table 4

Value of deflection coefficients $\frac{w_{max}}{h}$ as a function of the normal ratio $\frac{pa^4}{Eh^4}$

$\frac{pa^4}{Eh^4}$	0	4.93	10.0	21.4	35.6	53.2	74.5	104	137	178	225	282
$\frac{w_{1.1}}{h}$	0	0.1	0.2	0.4	0.6	0.8	1.0	1.2	1.4	1.6	1.8	2.0
$\frac{w_{1.3}}{h}$	0	-.0065	-.0126	-.0221	-.0271	-.025	-.018	-.007	.009	.030	.049	.075
$\frac{w_{1.5}}{h}$	0	-.0041	-.0081	-.0165	-.0251	-.033	-.041	-.048	-.054	-.058	-.062	-.064
$\frac{w_{1.7}}{h}$	0	-.0020	-.0039	-.0078	-.0123	-.017	-.023	-.030	-.035	-.043	-.052	-.059
$\frac{w_{1.9}}{h}$	0	-.0009	-.0020	-.0041	-.0064	-.009	-.012	-.015	-.019	-.022	-.027	-.031
$\frac{w_{1.11}}{h}$	0	.0006	.0011	.0023	.0037	.005	.007	.008	.011	.013	.016	.017
$\frac{w_{1.13}}{h}$	0	-.0004	-.0007	-.0014	-.0023	-.003	-.004	-.006	-.007	-.009	-.009	-.011
$\frac{w_{1.15}}{h}$	0	-.0002	-.0005	-.0010	-.0016	-.002	-.003	-.004	-.005	-.006	-.007	-.008
$\frac{w_{1.17}}{h}$	0	-.0002	-.0003	-.0007	-.0011	-.002	-.002	-.003	-.003	-.004	-.005	-.005
$\frac{w_{1.19}}{h}$	0	-.0001	-.0002	-.0005	-.0008	-.001	-.001	-.002	-.002	-.003	-.003	-.004
$\frac{w_{1.21}}{h}$	0	-.0001	-.0002	-.0004	-.0006	-.001	-.001	-.001	-.002	-.002	-.003	-.003
$\frac{w_{1.23}}{h}$	0	-.0001	-.0001	-.0003	-.0004	-.001	-.001	-.001	-.001	-.002	-.002	-.002
$\frac{w_{1.25}}{h}$	0	-.0001	-.0001	-.0002	-.0003	-.001	-.001	-.001	-.001	-.001	-.001	-.002
$\frac{w_{1.27}}{h}$	0	.0000	-.0001	-.0002	-.0003	0.000	-.001	-.001	-.001	-.001	-.001	-.001
$\frac{w_{3.1}}{h}$	0	-.0137	-.0273	-.0526	-.0758	-.094	-.111	-.126	-.135	-.143	-.145	-.149
$\frac{w_{3.3}}{h}$	0	.0013	.0025	.0045	.0056	.006	.006	.006	.005	.004	.004	.003
$\frac{w_{3.5}}{h}$	0	.0005	.0011	.0022	.0032	.005	.005	.005	.006	.007	.008	.008
$\frac{w_{3.7}}{h}$	0	.0001	.0004	.0008	.0011	.001	.002	.002	.002	.003	.003	.004
$\frac{w_{3.9}}{h}$	0	.0001	.0002	.0004	.0006	.001	.001	.001	.001	.002	.002	.002

Table 4. Continued

$\frac{pa^4}{Eh^4}$	0	4.93	10.0	21.4	35.6	53.2	74.5	104	137	178	225	282
$\frac{w_{3.11}}{h}$	0	.0001	.0001	.0002	.0003	.000	.000	.001	.001	.000	.000	.000
$\frac{w_{5.1}}{h}$	0	-.0037	-.0074	-.0147	-.0224	-.030	-.037	-.046	-.053	-.060	-.066	-.073
$\frac{w_{5.3}}{h}$	0	.0002	.0004	.0007	.0008	.001	.000	-.001	-.002	-.002	-.003	-.005
$\frac{w_{5.5}}{h}$	0	.0001	.0004	.0005	.0009	.001	.001	.002	.003	.003	.002	.003
$\frac{w_{5.7}}{h}$	0	.0000	.0001	.0003	.0005	.000	.000	.001	.001	.002	.003	.003
$\frac{w_{5.9}}{h}$	0	.0000	.0000	.0001	.0002	.000	.000	.000	.000	.000	.000	.001
$\frac{w_{7.1}}{h}$	0	-.0014	-.0028	-.0058	-.0089	-.012	-.016	-.021	-.025	-.030	-.035	-.041
$\frac{w_{7.3}}{h}$	0	.0000	.0001	.0002	.0002	.000	.000	.000	.001	.000	-.001	-.002
$\frac{w_{7.5}}{h}$	0	.0000	.0001	.0002	.0004	.000	.000	.000	.001	.001	.001	.001
$\frac{w_{7.7}}{h}$	0	.0000	.0000	.0001	.0001	.000	.000	.000	.000	.000	.001	.001
$\frac{w_{9.1}}{h}$	0	-.0007	-.0014	-.0028	-.0043	-.006	-.008	-.010	-.013	-.014	-.017	-.020
$\frac{w_{9.3}}{h}$	0	.0000	.0000	.0001	.0001	.000	.000	.000	.000	-.001	-.001	-.001
$\frac{w_{11.1}}{h}$	0	-.0004	-.0008	-.0016	-.0024	-.003	-.004	-.006	-.007	-.008	-.010	-.011
$\frac{w_{13.1}}{h}$	0	-.0002	-.0005	-.0010	-.0015	-.002	-.003	-.003	-.004	-.005	-.006	-.007
$\frac{w_{15.1}}{h}$	0	-.0002	-.0003	-.0006	-.0010	-.001	-.002	-.002	-.003	-.003	-.004	-.005
$\frac{w_{17.1}}{h}$	0	-.0001	-.0002	-.0004	-.0007	-.001	-.001	-.002	-.002	-.002	-.003	-.003
$\frac{w_{19.1}}{h}$	0	-.0001	-.0001	-.0003	-.0005	-.001	-.001	-.001	-.001	-.002	-.002	-.002
$\frac{w_{21.1}}{h}$	0	-.0001	-.0001	-.0002	-.0004	-.001	-.001	-.001	-.001	-.001	-.001	-.002
$\frac{w_{23.1}}{h}$	0	.0000	-.0001	-.0002	-.0003	.000	.000	-.001	-.001	-.001	-.001	-.001
$\frac{w_{25.1}}{h}$	0	.0000	-.0001	-.0001	-.0002	.000	.000	.000	-.001	-.001	-.001	-.001
$\frac{w_{27.1}}{h}$	0	.0000	-.0001	-.0001	-.0002	.000	.000	.000	.000	-.001	-.001	-.001

Table 5
 Value of the moment coefficients, k_m and t_m , as a function of
 the normal pressure ratio $\frac{p a^4}{E h^4}$

$\frac{p a^4}{E h^4}$	0	4.93	10.0	21.4	35.6	53.2	74.5	104	137	178	225	282
k_1	-.180	-.180	-.179	-.173	-.165	-.156	-.147	-.137	-.129	-.120	-.114	-.105
k_3	.0220	.0219	.0214	.0194	.0170	.0146	.0122	.0096	.0074	.0054	.0040	.0028
k_5	.0086	.0086	.0085	.0080	.0076	.0071	.0066	.0061	.0056	.0051	.0047	.0044
k_7	.0039	.0039	.0038	.0036	.0036	.0033	.0031	.0031	.0030	.0030	.0030	.0030
k_9	.0020	.0020	.0020	.0020	.0018	.0018	.0017	.0017	.0017	.0017	.0017	.0017
k_{11}	.0012	.0011	.0011	.0010	.0010	.0010	.0010	.0010	.0010	.0010	.0010	.0010
t_1	-.582	-.580	-.573	-.547	-.512	-.474	-.437	-.406	-.375	-.347	-.321	-.302
t_3	.0213	.0214	.0198	.0149	.0083	.0013	-.0045	-.0092	-.0127	-.0152	-.0183	-.0205
t_5	.0252	.0253	.0251	.0236	.0213	.0188	.0163	.0136	.0108	.0086	.0068	.0052
t_7	.0142	.0143	.0142	.0140	.0137	.0132	.0125	.0119	.0112	.0100	.0092	.0083
t_9	.0081	.0081	.0081	.0081	.0079	.0078	.0073	.0071	.0068	.0063	.0059	.0053
t_{11}	.0048	.0050	.0051	.0052	.0051	.0051	.0048	.0046	.0045	.0041	.0038	.0036
t_{13}	.0030	.0031	.0031	.0032	.0032	.0032	.0032	.0031	.0030	.0029	.0028	.0027
t_{15}	.0017	.0018	.0018	.0019	.0019	.0019	.0018	.0018	.0018	.0017	.0018	.0015

Table 6
 Center deflection, bending, membrane, and extreme fiber stresses as a function
 of the lateral pressure, p , when Poisson's ratio = 0.316

$\frac{p a^4}{E h^4}$	0	4.93	10.0	21.4	35.6	53.2	74.5	104	137	178	225	282
$\frac{w}{h}, (x=\frac{a}{2}, y=\frac{b}{2})$	0	.1143	.2283	.4508	.6654	.864	1.066	1.263	1.441	1.632	1.812	1.972
$\frac{\sigma_x^b a^2}{E h^2}, (x=0, y=\frac{b}{2})$	0	2.24	4.47	9.08	14.03	19.2	24.5	31.5	38.1	45.5	52.6	61.6
$\frac{\sigma_x^m a^2}{E h^2}, (x=0, y=\frac{b}{2})$	0	.04	.14	.49	1.21	2.1	3.2	4.5	6.0	7.6	9.4	11.4
$\frac{\sigma_x^a a^2}{E h^2}, (x=0, y=\frac{b}{2})$	0	2.28	4.61	9.57	15.24	21.3	27.7	36.0	44.1	53.1	62.0	73.0
$\frac{\sigma_x^b a^2}{E h^2}, (x=\frac{a}{2}, y=\frac{b}{2})$	0	.04	.14	.54	1.19	2.1	3.0	4.2	5.5	7.0	8.4	10.2

TABLE 7.— Convergence of Solution as the Number of Cubic Terms Used in the Equations for Deflection and Moment Coefficients Is Increased from 0 to 56

	Using 0 cubic	Using 1 cubic	Using 10 cubics	Using 56 cubics
$\frac{pa^4}{Eh^4} = 74.5$				
$\frac{\sigma''_x a^2}{Eh^2}, \left(x=0, y=\frac{b}{2}\right)$	33.9	24.0	24.3	24.5
$\frac{w}{h}, \left(x=\frac{a}{2}, y=\frac{b}{2}\right)$	1.60	1.12	1.06	1.07
$\frac{pa^4}{Eh^4} = 282$				
$\frac{\sigma''_x a^2}{Eh^2}, \left(x=0, y=\frac{b}{2}\right)$	148	47.5	57.3	61.6
$\frac{w}{h}, \left(x=\frac{a}{2}, y=\frac{b}{2}\right)$	6.67	2.03	1.98	1.98

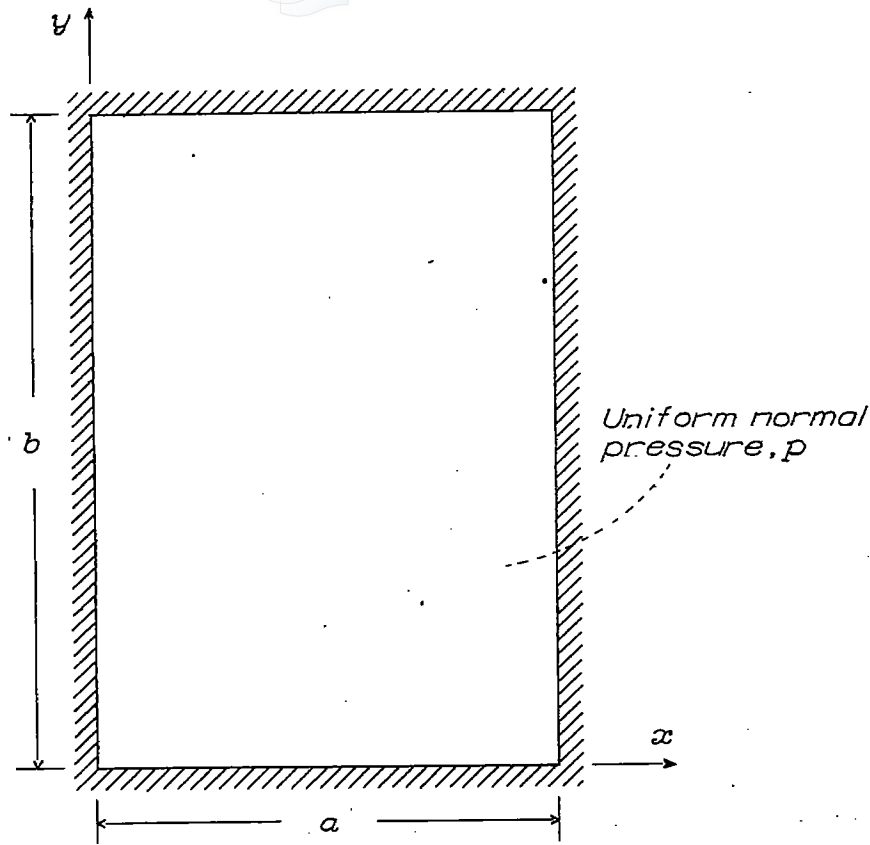

Figure 1.- Rectangular plate under uniform normal pressure, p .
 $b/a = 1.5$.

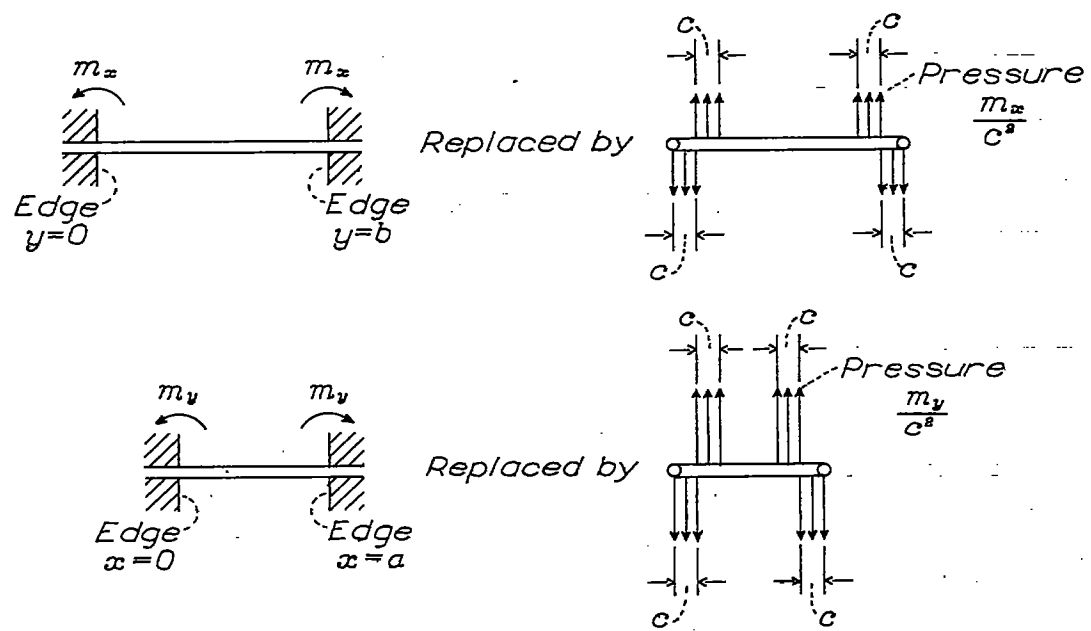

Figure 2.- Auxiliary pressure distribution replacing edge moments.

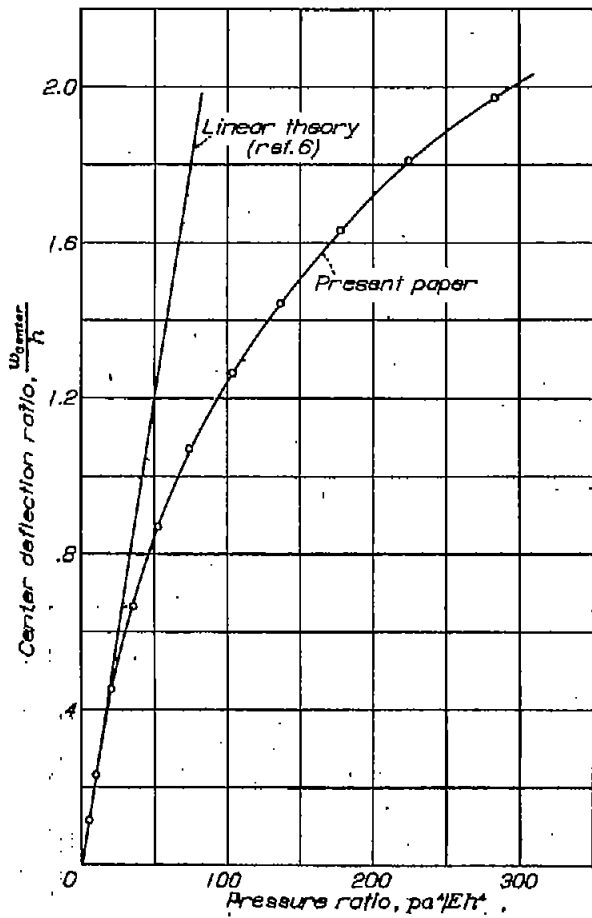

Figure 3.- Variation of center deflection ratio with pressure ratio.

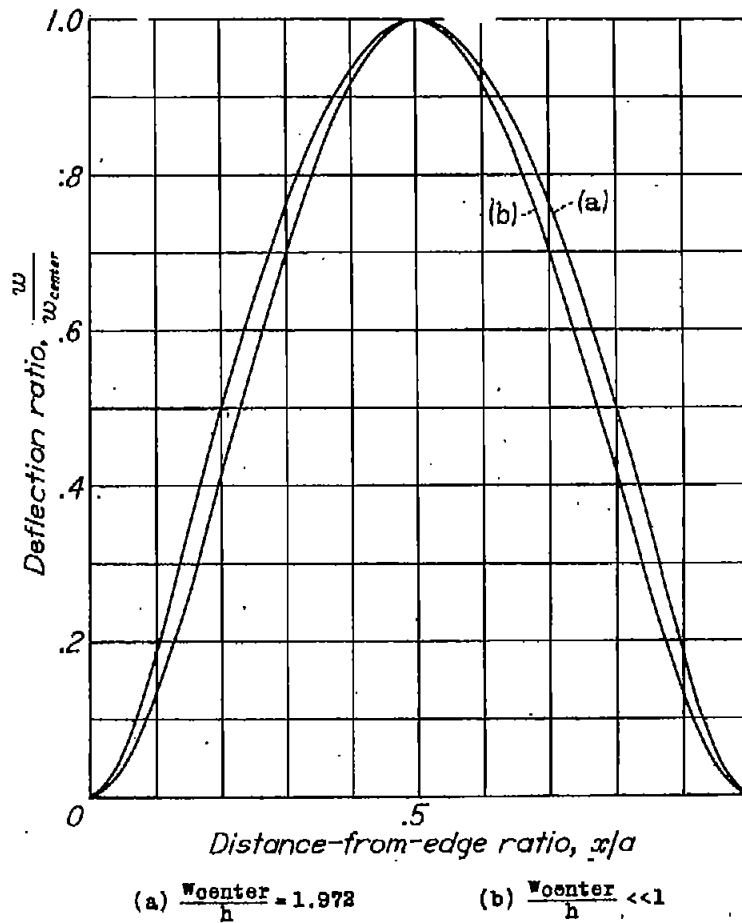
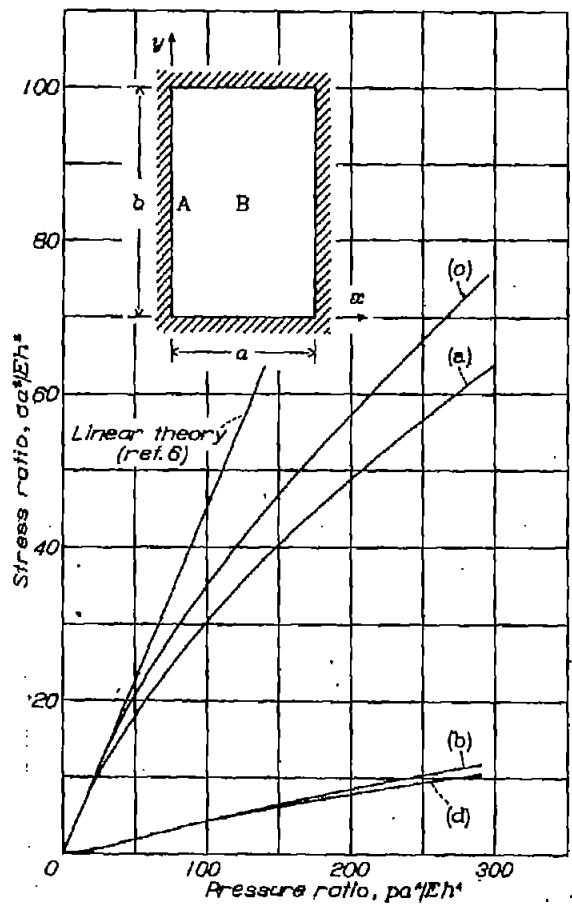

Figure 4.- Shape of deflected surface along transverse center line.



- (a) Extreme-fiber bending stress in x-direction at A.
- (b) Membrane stress in x-direction at A.
- (c) Maximum extreme-fiber stress in x-direction at A.
- (d) Membrane stress in x-direction at B.

Figure 5.- Variation of stress ratio with pressure ratio.

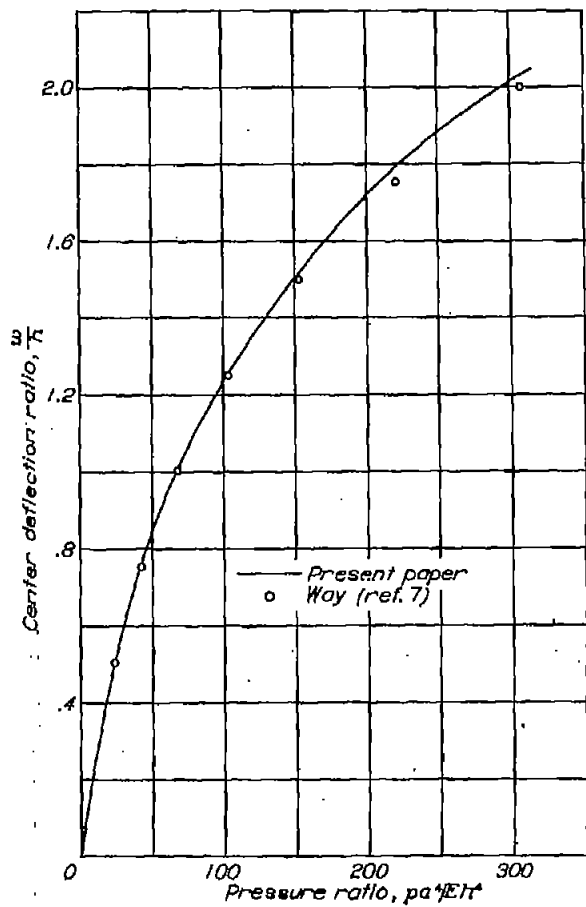
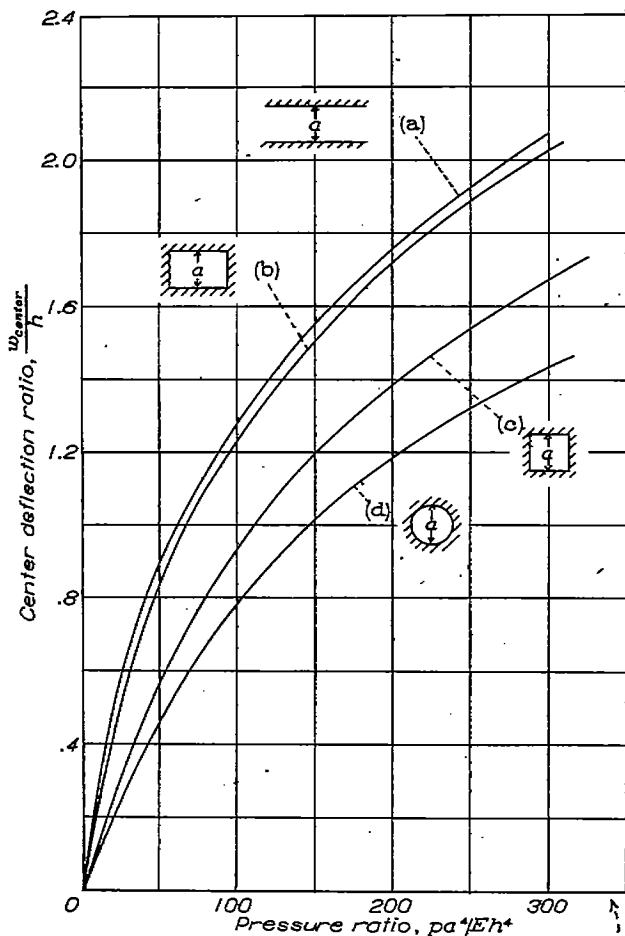
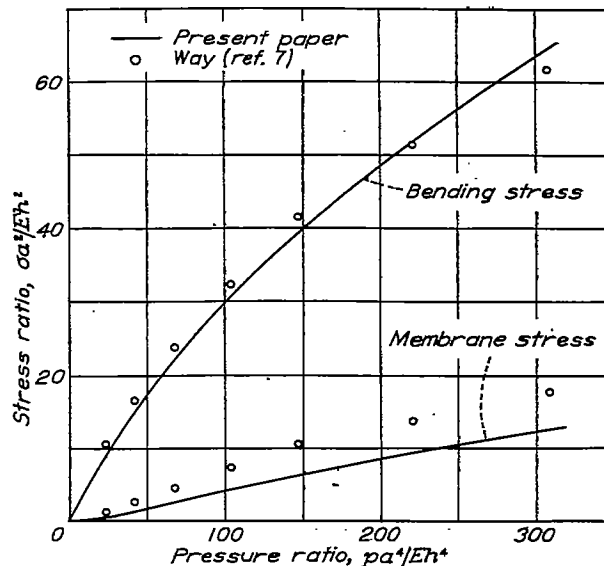

Figure 6.- Comparison with Way's energy solution. Center deflection.

Figure 7.- Comparison with Way's energy solution. Stresses at midpoint of longer edge.



- (a) Infinitely long rectangular plate, $\mu = 0.316$, reference 2.
- (b) 3:2 rectangular plate, $\mu = 0.316$, present paper.
- (c) Square plate, $\mu = 0.316$, reference 1.
- (d) Circular plate, $\mu = 0.3$, reference 8.

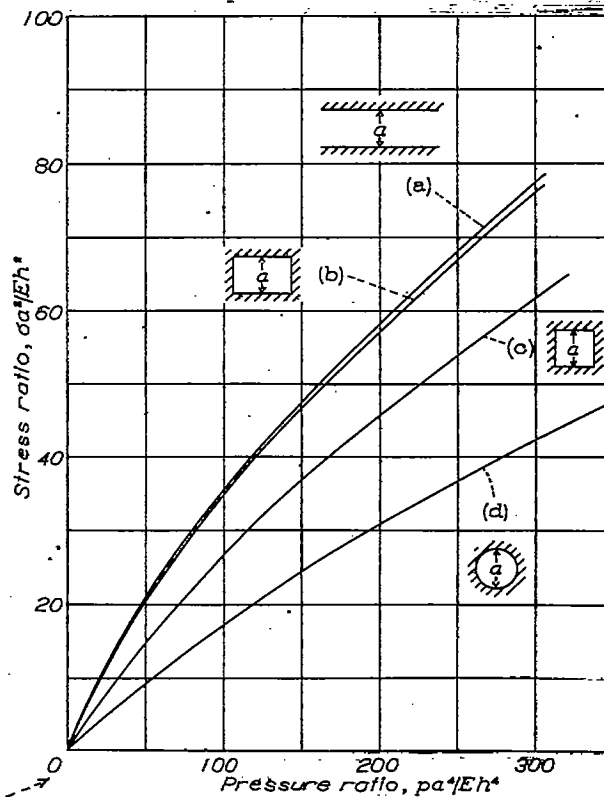

Figure 9.- Comparison of maximum stress for clamped plates.

Figure 8(left).- Comparison of deflection of clamped plates.