

RESTRICTED

# NATIONAL ADVISORY COMMITTEE FOR AERONAUTICS

## TECHNICAL NOTE

No. 945

### NONDESTRUCTIVE TEST METHODS FOR SPOT WELDS IN ALUMINUM ALLOYS

By R. C. McMaster, J. F. Manildi, and G. C. Woolsey  
California Institute of Technology



Washington  
November 1944

CLASSIFIED DOCUMENT

This document contains classified information affecting the National Defense of the United States within the meaning of the Espionage Act, USC 50:31 and 32. Its transmission or the revelation of its contents in any manner to an unauthorized person is prohibited by law. Information so classified

may be imparted only to persons in the military and naval Services of the United States, appropriate civilian officers and employees of the Federal Government who have a legitimate interest therein, and to United States citizens of known loyalty and discretion who of necessity must be informed thereof.

RESTRICTED



3 1176 01433 2697

RESTRICTED

NATIONAL ADVISORY COMMITTEE FOR AERONAUTICS

TECHNICAL NOTE NO. 945

NONDESTRUCTIVE TEST METHODS FOR SPOT WELDS  
IN ALUMINUM ALLOYS

By R. C. McMaster, J. F. Manildi, and C. C. Woolsey

## SUMMARY

This report presents the results of a study and research investigation of nondestructive test methods for spot welds in aluminum-alloy sheets. The purpose of the research was to investigate proposed nondestructive test methods for spot welds in aluminum alloys, to determine the feasibility of such tests, and to recommend those research methods found suitable for development and reduction to practical application.

Investigation was made of approximately 30 proposed nondestructive methods of testing spot welds, including electric-current conduction tests, eddy-current tests, thermal tests, sonic and vibration tests, material-property tests, penetrator tests, X-ray tests, and mechanical-proof tests. Preliminary tests and analysis of the requirements of a suitable nondestructive test indicated that penetrator, electrical, and X-ray tests showed the most promise, and extensive developments of each of these test methods were carried out. Each of these test methods then was tried on groups of several hundreds of industrially made spot welds, and the reliability and accuracy with which weld size, strength, and quality were predicted by each test were determined. Complete descriptions of test equipment and the results of measurements are included in this report, in many cases in the form of graphs. Also included are photographic tables of data on spot-weld nomenclature and metallurgy, weld classification, and the effects of conditions of welding upon weld size and structure.

It was found that, in terms of reliability, the most promising nondestructive test method is the radiographic inspection of spot welds, which can probably measure weld-nugget diameter and the presence of defects, such as cracks,

RESTRICTED

porosity, and spitting; - The most reliable non-radiographic test is the ring-penetrator or profile-penetrator test, which can measure weld-nugget diameter reliably under normal conditions of production welding. It does not measure the nature or extent of cracking, porosity, and spitting, except insofar as these defects change the depth of penetration under load. Neither the electrical, nor the penetrator tests are capable of determining the extent of the alclad inclusion into the weld nugget at the faying plane, or the decrease in weld strength resulting from this cause.

### INTRODUCTION

The need for practical nondestructive tests for spot welds in aluminum-alloy sheet is recognized in the aircraft industry. Present industrial process control and visual inspection procedures, while adequate for the production of secondary aircraft structures and, in some cases, for primary aircraft components, do not guarantee that all spot welds made in aluminum-alloy sheets for aircraft will meet minimum strength requirements. Consequently, spot-welding applications have been limited, for the most part, to secondary or unstressed structures. Until adequate process control, monitoring of the welding equipment, or reliable nondestructive tests are provided to guarantee weld quality, the spot-welding of primary aircraft structures tends to be limited.

When designers and inspectors are shown undeniable proof that weld quality is adequate, the spot-welding of primary aircraft structures may be expanded. A reliable nondestructive test for spot welds would provide this proof of weld quality.

The purpose of the research described in this report was to investigate proposed nondestructive test methods for spot welds in aluminum-alloy sheets, to determine the feasibility of such tests, and to recommend methods found suitable for further development and reduction to practical application. The National Advisory Committee for Aeronautics sponsored the research and contributed to its financial support. The investigation was carried out at California Institute of Technology under the supervision of Professor F. C. Lindvall.

## STATEMENT OF THE PROBLEM

### A. Requirements of Test

The nondestructive spot-weld test must be absolutely reliable, and should be practical, fast, efficient, and economical both in labor and equipment. It should be suitable for production testing and for occasional inspection checks on questionable welds at any point in the fabrication process. It should detect bad welds regardless of their cause.

To be more specific, the test must be:

1. Reliable.-- It should discriminate normal welds - that is, welds with static shear strengths 25 percent to 125 percent above the minimum acceptable strength - from welds with less than the minimum acceptable strength, with complete reliability. To obtain this reliability, the method should predict spot weld static shear strength within  $\pm 20$  percent of actual weld strength, and more accurately if possible, throughout the range of strengths from one-half the minimum acceptable strength to the highest strength obtained under normal production conditions in acceptable welds. A reasonable maximum accuracy to be expected from a nondestructive spot-weld test is that test indications should measure weld strength as closely as nugget diameter (which could be observed by destructively sectioning the weld) correlates with weld strength. Any nondestructive test which approaches this standard should be considered successful, for the relation between nugget diameter and weld strength is generally recognized as the most significant relation between a single weld parameter and the static shear strength of the weld.

2. Practical.-- It must be such that it can be used reliably by semiskilled personnel under normal production conditions.

3. Fast.-- Because of the large number of welds to be tested, a production testing device should preferably operate in a few seconds and be capable of being quickly transferred and positioned for testing. For this reason, its location with respect to the weld nugget should not be too critical.

4. Immediate in response.-- In production testing, the indication of weld strength should be immediate, to avoid delay and unnecessary identification of specific welds under test.

5. Independent of weld location.- Test results should not be invalidated by the proximity of other welds, or of corners, slots, or edges in the sheet, or of large masses of metal.

6. Independent of ambient conditions and of surface conditions of welded sheets.- Since weld testing may be done on production lines within buildings or out-of-doors, test results must not be affected by temperature, noise, vibration, dirt, humidity, or other test conditions dependent upon location. Sheet surfaces must not require excessive preparation, nor should surface conditions resulting from normal production processes invalidate the test.

7. Nondestructive.- The weld must not be damaged by the test, nor should the alclad layer be broken nor the sheet or part be distorted by the test.

In addition, it would be highly desirable, but not necessary, that the test equipment be portable and that it require access to only one side of the welded sheets. If used on fabricated pieces, it would be advantageous if the portion of the tester to be brought to the weld were small, weighing, only a few pounds at most, and were easy to move and set accurately in position. For production testing of small parts before further assembly, the work might be brought to a fixed testing machine. Although spot welds in aircraft are accessible from both sides of the work at some point in the fabrication process, a testing unit operating from only one side of the sheet would be very advantageous, provided reliability of measurement were not sacrificed to obtain this advantage.

## B. Weld Properties and Nomenclature

Figure 1 shows photomicrographs of both cross section and faying surface, and photomicrographs of significant regions, of a typical spot weld in alclad 24S-T aluminum-alloy sheet. The following nomenclature, which will be used throughout this report, refers to this figure.

1. The parent sheet (A) is the 24S-T aluminum-alloy sheet in the region outside the weld proper which has not been affected in any manner by the welding process. This alloy is composed of 4.5 percent copper, 0.6 percent manganese, and 1.5 percent magnesium, with aluminum and normal impurities making up the balance. (See reference 1.) The 24S-T (tempered) alloy develops about 41,000 psi shear

strength, while 24S-0 (annealed) alloy develops only 18,000 psi. The incipient melting temperature of this 24S alloy is 936° F. (See reference 2.)

2. The alclad layer (B) is a thin layer, approximately 5 percent of the parent sheet thickness, of commercially pure aluminum bonded to each surface of the parent sheet. Its prime purpose is to protect the parent sheet against corrosion. It is important that the welding operation should not impair the protection provided by this coating. This commercially pure aluminum develops about 9500 psi in shear and has melting point of about 1200° F. (See references 1 and 3.)

3. The weld nugget (C) is an ellipsoidal volume of metal which has been melted by the welding current, possibly being stirred so as to effect a redistribution of its chemical constituents, and has then solidified into two distinct zones as a cast structure. (See reference 4.) The dendritic zone (C') shows evidence of very rapid solidification, while the equiaxed zone (C'') shows evidence of relatively slower cooling. The nugget is softer than the parent sheet and develops only about 18,000 to 22,000 psi shear strength. (See reference 3.)

4. The corona region (D) surrounds the weld nugget at the faying plane and is that area of the alclad coating which has been subject to pressure and heat during the welding process. The nature of the corona may depend upon the surface preparation of the sheet before welding, and in the corona region there may be no bonding, partial bonding, or complete areal bonding depending upon the sheet condition and the conditions of welding. It is not safe to assume the bonded area of corona to be proportional to nugget area, for the purposes of nondestructive test development. The complete corona bonding may develop as much as 9500 to 10,500 psi shearing strength. (See reference 3.)

5. The alclad inclusion (E) into the weld nugget at the faying plane consists of aluminum of the alclad layer which has not been alloyed into the nugget. The extent of alclad inclusion is quite variable, and tends to be greater with thick alclad layers, and in low energy welds with thin nuggets. Excessive alclad inclusion weakens a weld in shear loading, since it decreases the effective nugget area at the faying plane. It is possible to develop a nugget in both sheets, yet have 100 percent alclad inclusion. (See reference 3.) In this case, the weld nugget contributes nothing whatever to the weld strength.



6. The penetration (F) of the weld nugget into the parent sheet measures the portion of the sheet thickness occupied by the weld nugget. Penetrations of 20 to 80 percent of the sheet thickness are usually considered acceptable. (See reference 5.) Excessive penetration (80 to 100 percent) usually indicates a brittle, cracked, or porous weld, and it is undesirable both because of lack of ductility in the weld, and because the cracks may spread to the surface breaking the alclad layer and permitting corrosion. Inadequate penetration (below 20 percent) is frequently accompanied by excessive alclad inclusion and inconsistency in strength.

7. The heat-affected zone (G) is that region of the parent metal surrounding the weld nugget the properties of which have been changed as a result of exposure to elevated temperatures. The shear and tensile strengths of the 24S-T alloy are reduced in this region. Structural changes, such as incipient melting of the material and intrusion of eutectic along grain boundaries, occur in this zone. (See reference 6.) Very large welds tend to "pull a button" when they fail under shear loading, the failure possibly occurring in part through this heat-affected zone. (See reference 7.) Welds which fail by shearing the nugget through the faying plane are not greatly affected by this zone insofar as the shear load required for failure is concerned.

8. The faying plane (H) is the plane of joining between the welded sheets. Bonding between the two sheets in this plane gives the weld its strength.

### C. Factors Contributing to Weld Shear Strength and Quality

Spot welds are seldom designed to be loaded in tension. The spot weld is much stronger under shear loading and is normally designed on the basis of static shear loads. The most commonly used measurement of weld strength is the static shear strength of a single spot lap joint. (See reference 5.) It is this static shear strength which must be predicted reliably by nondestructive tests to obtain their general acceptance. If static shear strength cannot be predicted reliably, the nondestructive test method must be considered a failure, regardless of how well it measures other weld properties.

Unfortunately, static shear strength alone is not a good measure of spot-weld quality. Weak welds without any nugget bonding whatever at the faying surface may pass minimum acceptable static shear strength requirements by virtue of

alclad bonding; yet these welds might fail in service. Very large welds with oversize, cracked, brittle nuggets and low ductility may show very high static shear strengths, yet contribute to early fatigue failure and rapid corrosion. An ideal nondestructive test should distinguish between these defects.

The single spot-weld parameter which by itself correlates most reliably with static shear strength is the weld-nugget diameter at the faying plane. More precisely, it is the net area of cast alloy (total nugget area less the area of the alclad inclusion) at the faying plane which determines weld strength. With excessive alclad inclusions, measurement of the over-all nugget diameter can be misleading to the extent of 100 percent error in predicting weld strengths. With normal alclad inclusions, the nugget diameter measures weld static shear strength with an error of  $\pm 10$  to  $\pm 20$  percent of actual weld strength. (See fig. 41.) For welds without excessive alclad inclusions or corona bonding, which fail by shearing the nugget through the faying plane, the correlation is quite reliable. For stronger welds which fail by "pulling a button," the correlation is less reliable, but in all such cases the weld strength is less than would be expected for failure by shearing through the nugget at the faying plane.

The second parameter, in addition to the net area of cast alloy at the faying plane, which contributes significantly to spot-weld shear strength, is the effective area of alclad or corona bonding at the faying plane. In cases where the cladding is fully bonded between the sheets near the weld, there occurs a strength contribution per unit area of bonded cladding, equal to approximately half the unit strength of the cast alloy. In weak welds, the area of bonded cladding may easily exceed the cast alloy area in the ratio of 3 or 4 to 1. In these cases the bonded cladding contributes a major portion of the static shear strength of the weld. This added strength would be evident in the static shear pull test, yet could not be relied upon for the life of a welded structure, as the alclad bond is of questionable nature.

It is difficult to measure the net area of alclad bonding, not including the area of nugget bonding, in a nondestructive test. However, if reliable independent measurements can be made of the total bonded area and of the net nugget area at the faying plane, their difference measures the area of bonded cladding.

Cracking and porosity within the weld nugget have



negligible effect upon static shear strength, except insofar as they affect the bonded area at the faying plane.

The influence of the different types of metallurgical structure on the characteristics of spot welds is not known at present, but it is probably of much less importance than factors such as size, shape, soundness, and freedom from cracking. (See reference 6.) Measurements have shown no reliable direct correlation between any metallurgical property and weld strength, except insofar as nugget geometry has been measured by structural properties.

#### D. Weld Types to be Discriminated

The task of developing nondestructive tests for spot welds is frequently given by production welding groups to research groups or outside organizations whose familiarity with production welding conditions is limited. All too frequently, these research workers have a falsely simplified concept of the nature, geometry, and structure of spot welds, on which to base their nondestructive test developments. It must therefore be recognized that the size, shape, and bonding, particularly of weak welds, are exceedingly variable. Static shear tests alone tell very little about weld geometry, size, and quality. Many anomalous conditions exist which tend to invalidate nondestructive test methods.

To aid in the development and interpretation of nondestructive spot-weld tests, a classification chart is given showing the faying surface and a section through the nugget for several typical spot welds made under industrial welding conditions. These welds were made on energy storage welders of both the magnetic and the condenser types, which tend to produce similar weld structures. No alternating-current welds are included, but similar results can be obtained with alternating-current welders under certain conditions.

For simplicity, the classification chart begins with very low energy welds, and progresses to larger and stronger welds made with increasing energy. In this manner the significance of the various weld regions in contributing to weld strength can be easily determined.

These welds were made on industrial spot-welding machines with all preparation and welding conditions normal, except energy setting or, in a few cases, forge pressure delay time. Thus, the net heat developed in the weld was used as the chief

variable in producing these weld types. The bad welds were purposefully made so for use in developing nondestructive spot-weld tests.

Type A Welds\* - Alclad Bonding Only with No Nugget Formation  
(See fig. 2.)

Weld A-1 represents the lowest energy setting of the welding machine producing observable bonding at the faying surface. A small region of the alclad layers has been heated and subjected to pressure, producing a weak bond possibly due to plastic deformation and keying at the faying surface. This weld fell apart upon handling. The bonded points are good conductors of heat and electricity across the faying surface between the sheets; the surrounding faying surface is a very poor conductor as a result of the presence of a thin layer of aluminum oxide, which acts as an insulator. No changes have occurred in the parent metal, and no nugget formation has occurred.

Weld A-2 was made under the same conditions as weld A-1, but more extensive bonding has occurred at the faying plane. The alclad layer has bonded over a slightly larger area. The static shear strength was 100 pounds. This bond, because of increased area, shows less over-all resistance to the flow of heat and electric current across the faying plane than the bond of weld A-1.

Weld A-3 made with increased energy shows a still larger area of alclad bonding, and developed a static shear strength of 215 pounds. The resistance of this bond to the flow of electric current and heat is still less than that of weld A-2, because of the increased bonding area.

All the welds of type A, frequently called "stuck" welds, involve only alclad or corona bonding without any nugget development whatever, and should be classified as worthless. This type of bonding results only under a locally ideal condition of surface preparation, such as wire brushing or careful etching. A fingerprint or the use of other methods of surface preparation may result in absolutely no bonding under the same conditions of welding. However, welds of this type have been noted with much larger area of alclad bonding, which develop more than the Army minimum acceptable static

---

\*Specimen welds shown are all made in 0.040-inch 24S-T alclad sheets. All are shown at 10X magnification.

shear strengths. The weld shear strength is directly proportional to the net area of true bonding, and the unit shear strength is near 10,000 psi. Nondestructive tests which measure the area of bonding at the faying plane tend to measure weld shear strength accurately, when alclad bonding is the only type of bonding present in the group of welds under test.

Type-B Welds - Elementary Nugget Formation  
(See fig. 3.)

Weld B-1 shows the effect of a different method of surface cleaning upon the bond at the faying surface. Sufficient welding energy to provide an elementary nugget in both sheets has been supplied, yet almost no bonding whatever has occurred save on the periphery of the heated area. This "weld" fell apart upon handling.

Weld B-2 represents a slightly higher weld energy than the welds of type A, with very elementary tendencies toward nugget formation. Nearly 100 percent of the bonded area consists of alclad bonding with an almost negligible area of cast alloy or nugget bonding. This weld failed at a shear load of 360 pounds, the increase in strength over weld A-3 resulting chiefly from the increased area of bonding.

Weld B-3 represents a further increase in weld energy, producing a "crescent" or "doughnut" shaped nugget development. Some of the alclad layer has been melted and alloyed with the nugget material, permitting the cast alloy of the nugget itself to form a direct bond over a small ring-shape area. This weld developed 580 pounds in static shear test, most of the gain in strength over weld B-2 resulting not from a change in the area of bonding, but rather from a change in the type of bonding - from alclad bonding to cast-alloy bonding in the nugget area. The cast-alloy bond usually develops about 20,000 psi unit shear strength, approximately twice that characteristic of the alclad bond. Thus this weld would not be discriminated from weld B-2 by non-destructive tests involving only the measurement of the total area of bonding at the faying surface.

Weld B-4, made with still greater energy, developed a flat nugget of larger size, but seems to lack alclad bonding entirely. Its strength of 480 pounds is consequently lower than might be expected. This failure of corona bonding may have resulted from local surface contamination of the faying plane, as by a fingerprint. Thus neither the relative size

of nugget nor the relative bonded area of this weld can measure its strength reliably in comparison with preceding welds. Nondestructive tests based only on measurement of the conducting area at the faying plane would classify this weld as near to weld A-2, which has about 50 percent of its area, yet only 21 percent of its strength, and so the tests would be 100 percent in error. Tests based on nugget size alone would classify it as stronger than weld B-3, and would probably be 40 to 50 percent in error.

Weld B-5 developed a flat nugget comparable to that of weld B-4, but the total bonded area covered only half the usual circular area, and contained only a small area of cast-alloy bonding. Consequently, this weld is weaker strength (340 lb) than welds B-2 and B-3.

All the welds of type B, frequently called doughnut or crescent welds, involve small regions of cast alloy or nugget development with or without extensive alclad bonding depending upon conditions of surface preparation. The cast-alloy bond develops about twice the unit shear strength of the complete alclad bond. Hence weld strength is not measured reliably by the total area of bonding at the faying surface. Usually the strength varies widely between successive welds made under these welding conditions, so that all these welds are undesirable because of lack of consistency, even though a group of these welds may pass the minimum acceptable shear strength requirement.

The changes in weld energy in this group of welds were obtained with constant energy (current relay) setting of the Sciaky welder by advancing the application of forging pressure by varying amounts of time.

#### Type-C Welds - Small Diameter Nuggets with Normal

##### Alclad Inclusions and Low Penetration (See fig. 4.)

Weld C-1 has a small nugget of normal shape and a reasonable amount of alclad inclusion, typical of welds made with higher energy than the type-B welds, but with insufficient energy to produce full-size nuggets. Little alclad bonding occurred on this weld. The weld strength is only 200 pounds. The penetration is low, amounting to about 30 percent of the sheet thickness.

Weld C-2 was made with greater energy than weld C-1 and has somewhat larger diameter and about 55 percent penetration. The strength is 380 pounds. The nature of the corona bond on this weld is questionable.

Type-C welds result under otherwise normal welding conditions when weld energy is slightly low for the production of normal size welds. If the corona bond happens to be extensive, the welds develop normal static shear strength. However, if corona bonding is absent, the weld strength is low. Inconsistency of strengths results, particularly if surface preparation and cleaning of the sheet were inadequate.

Type-D Welds - Normal Diameter Nuggets with Normal Penetration  
(See fig. 5.)

Weld D-1 is a weld of normal diameter, penetration, and shape. Its strength was 725 pounds. It has an adequate area of cast-alloy bonding at the faying surface, to which corona bonding adds further strength. The alclad inclusion is not excessive. The weld is "sound" - that is, it is free of cracks and porosity. The penetration is not excessive, since the heat-affected zone does not extend to the surface of the 24S-T alloy. This is the preferred type of weld. Its maximum strength has been realized because it failed by shearing through the nugget at the faying plane.

Weld D-2 is a weld of normal penetration and shape, with slightly larger diameter than weld D-1. It failed by pulling a button, with partial shearing of the nugget, and so developed only 580 pounds shear strength.

The welds of type D consistently develop acceptable static shear strength, and are characterized by normal diameter, well-shaped nuggets of reasonable penetration. The welds are usually sound and free from cracks, porosity, and lack of fusion.

Type-E Welds - Oversize Nuggets with Excessive  
Penetration, Cracks, Porosity, or Spitting  
(See fig. 6.)

Weld E-1 has a nugget of normal diameter with excessive penetration into one sheet, and a tendency toward cracking in the nugget. Sheet efficiency may be impaired by the

excessive penetration, and fatigue strength might be lowered through further growth of the cracks. Should the cracks extend themselves to the sheet surface, corrosion may further impair the weld quality. Strength was 700 pounds, no greater than that of a normal penetration weld with the same nugget diameter.

Weld E-2 shows excessive cracking in a weld of nearly normal nugget diameter and penetration. This results from inadequate electrode pressure during welding; in this particular case the application of forging pressure was purposefully delayed to obtain this result. The fatigue- and corrosion-resistant properties of the weld may be impaired. Strength was 590 pounds.

Nugget cracks usually lie in planes normal to the sheet surface, and radiate spokelike from the center of the nugget. Current and heat flow through the bonded area normal to the faying surface are not appreciably affected by such cracks. X-rays, or eddy-current flow parallel to the plane of the sheet, will detect this type of cracking.

Weld E-3 has a large diameter nugget with excessive penetration into one sheet. Cracking is frequently present in such oversize welds, particularly where inadequate tip pressure has been used. Further increase in nugget size offers little advantage, for possible increase in static shear strength is offset by probable reductions in fatigue strength, sheet efficiency, ductility, and corrosion resistance when excessive penetration and cracking result.

Weld E-4 has an abnormally large nugget with excessive penetration and cracks extending to the sheet surface. It developed a static shear strength of 1385 pounds, but the crack might serve as a focal point for corrosion or fatigue failure.

Weld E-5 exhibits "spitting" at the faying surface, a condition which usually is accompanied by porosity and reduced strength (640 lb).

Welds of type E may occasionally develop greater static shear strength than normal welds, but this gain is offset by a decrease in strength consistency, and a probability of excessive penetration and cracking.



## TESTS AND RESULTS

At the time this research was begun, several methods for the nondestructive testing of spot welds in aluminum alloys had been proposed. Each of these methods involved an attempt to measure the total area of bonding at the faying plane, through the flow of direct current, alternating or eddy current, heat, vibration, or sound waves across the faying plane at the bond. Tests showed that none of these measurements could predict weld strength reliably, and that the reason for their failure lay in their inability to discriminate between the relative areas of nugget bonding and of alclad bonding at the faying plane. If such tests were calibrated on welds having nugget bonding only, the measurements could falsely indicate the strength of a weld with predominantly alclad bonding to be as much as 100 percent above the true strength. For this reason, tests developed by several research laboratories failed to discriminate weld strength and quality and their development was abandoned.

During the past year, radiographic methods of inspecting spot welds have been developed to show great promise. (See references 4, 6, 8, 9, and 10.) The radiographing of spot welds, however, seemed unattractive to aircraft manufacturers because of the cost, time delay, and skill required in testing, as well as the possibility of misinterpretation of the radiographs or misuse of the method. The practicability of the method has not yet been proved for industrial production inspection. Therefore a specific directive to develop non-radiographic test methods, if possible, was given to this project.

For the use of research organizations interested in the development of nondestructive tests for spot welds, a brief description of proposed test methods is now given. Methods proposed and developed independently by California Institute of Technology are indicated with a (c) sign. Methods proposed elsewhere are indicated by a superscript letter. General information on the methods is included where it may prove useful. These methods include:

- (a) Visual Inspection of Spot Welds
- (b) Electric-Current (Conduction) Tests
- (c) Eddy-Current (Induction) Tests

- (d) Thermal (Heat-Flow) Tests
- (e) Sonic and Vibration Tests
- (f) Sheet-Surface-Condition Tests
- (g) Impressor or Penetrator Tests
- (h) Mechanical-Proof Tests
- (i) Radiographic Tests

#### A. Visual Inspection of Spot Welds

Quality control of spot welds in the aircraft industry is obtained at present by (See reference 5.):

1. Careful process control
2. Qualification testing of machines
3. Percentage destructive testing
4. Strength-consistency tests
5. Weld-metal-structure tests, and
6. Visual inspection of welded parts and structures

Visual inspection is the only nondestructive test which has received general acceptance in the industry.

A skilled inspector, familiar with the conditions of preparation and welding, and the characteristics of particular machines in a given plant, can obtain a great amount of information concerning weld quality by visual inspection of the finished parts. Parts showing excessive indentations of the sheet by the welder electrodes are of course rejected, for surfaces exposed to the air stream in which a smooth surface is required.

The presence of spits or flashes, or evidence of excessive tip pickup, often indicates bad welding conditions. Welds with cracks extending to the sheet surface are easily observed, and cannot be accepted because these cracks serve as focal points for corrosion. Evidences of excessive sheet separation indicate bad welding conditions, with possible

expulsion of metal from the weld zone and resultant cracks or porosity. Certain surface conditions can be correlated with ductility or, conversely, with brittleness in the weld. Under controlled conditions of welding, nugget size, weld energy, and timing of forge pressure can be correlated with surface indentation of the sheet. The research man must avoid developing nondestructive tests which measure these spot-weld parameters no more reliably than does visual inspection.

### B. Electric-Current Conduction

Indications obtained in electric-current conduction tests depend upon the measurement of resistance in the weld region. They depend in particular upon the geometry of the conducting path, and upon the specific resistivity of volumes and surface regions in that path. Because of the very low resistance of aluminum alloys, even with a current path limited to the weld region to obtain sensitivity to weld conditions, large currents, 10 to 100 amperes, usually are required. Sensitive pickup units with low internal resistance, designed to respond to 5 to 100 microvolts, are needed. Only a small portion of the total energy input to the weld region is available to actuate the indicating instrument in the pickup system. The relatively large effects of contact resistances and thermal electromotive forces must be reduced in the measuring circuits.

It is difficult to detect variations in the specific resistivity in the various metallurgical regions of the spot weld, from the outer surface of the sheet. Despite the fact that 24S-T has approximately twice the resistivity of 2S-O, and about 167 percent of the resistivity of 24S-O, the usual weld nugget has little resistivity effect upon electrical measurements from the outer surface of the sheet. There are no boundary regions of very high resistance between the nugget and the parent metal. For welds of normal or low penetration, the overlying layer of parent metal tends to mask small changes in resistivity within the nugget.

As an example of this condition, a rectangular prism containing half a weld nugget was cut from an 0.064-inch 24S-T alclad sheet containing typical spot welds. The sides of the prism were machined smooth and parallel, resulting in a block 0.064 by 0.020 by 1 inch containing half the weld nugget, as shown in figure 7. Direct current was passed through the strip from end to end. The potential distribution was measured by means of a potentiometer easily adjusted

to 1/2 percent of the total voltage drop in the piece, through the use of a sharpened aluminum alloy probe and a dividing engine. The potential distribution was found to be that shown in figure 7 for measurements on the side of the block which had been the faying plane. No significant discontinuities exist. Measurements on the opposite side of the block showed a linear potential distribution. Similar profiles in which the difference in voltage between two probes 0.04 inch apart was measured as the probe assembly was moved along the piece also showed no resistance discontinuities. In the absence of pores and cracks, therefore, it will be very difficult to use specific volume resistivity measurements from the outer surface of the welded sheets to measure weld size or quality.

It is feasible to detect variation in the total conducting area of the bond between the sheets at the faying plane of a spot weld. This may be done by using direct current flowing across the faying plane (normal to the sheet surface) at the bond. Several direct-current tests of this type have been proposed. Direct current flowing in the plane of the sheet does not measure the area of bonding, unless a sizable normal component of flow through the bond can be established. (See fig. 8.)

Advantages of direct-current methods lie in their simplicity and their immediate response.

Disadvantages of direct-current test methods lie in the difficulties of establishing satisfactory probe systems without excessive contact resistance or thermal electromotive forces, as well as in the small energy available in the pick-up system.

1. Two-side direct-current test<sup>a</sup>. - In this test, a large direct current is passed from a cylindrical current electrode (I) in contact with the sheet surface above the spot weld through the weld normal to the faying plane to a similar current electrode in contact with the sheet surface below the spot weld. (See fig. 9.) Potential probes (P) in contact with the outer sheet surfaces and connected to a low-resistance galvanometer, measure the potential drop through the weld. This test measures the total bonded area at the faying plane of the weld. For welds with small areas of bonding, the lines of current flow are crowded together at the faying plane and produce a relatively higher potential drop than with welds with a large area of bonding. (See figs. 10 and 11.) Higher potential readings thus tend to indicate smaller, and presumably weaker, welds.

Precautions to be observed in making this test are:

1. The current electrodes must be fixed relative to one another and be very carefully centered above the actual weld. (Incidentally, the weld may not be centered under the impression of the tip of the welder electrode.) A displacement of the current electrode 1/16 inch from the optimum point with respect to the weld may introduce a 100 percent change in potential indication. (See fig. 10.) Each area of the current electrode must make the same degree of contact, and carry the same proportion of the total current, on successive measurements, in spite of variations in the geometry of the indentation of the sheet surface by the welding tips.

2. The potential probes must be very carefully and permanently located with respect to the current electrodes. A displacement of 1/64 inch produces a large error in potential indication. Centering the potential probe symmetrically with respect to the current electrodes, so as to measure only the voltage drop due to current flow normal to the sheet surface, has been shown to give optimum sensitivity in these tests.

3. The potential probe should have a sharp tip of a hardened alloy, capable of puncturing the oxide film on the surface of the aluminum sheet without requiring the application of excessive pressure or penetrating a variable distance into the sheet. Low, constant contact resistance must be obtained. Furthermore, the potential probes must be made of an alloy which develops only a very small thermal electromotive force when in contact with aluminum. This is necessary because the potential drop across the weld amounts to only a few microvolts (0 to 50) in ordinary welds, for total currents large enough to heat the weld region appreciably.

4. The applied pressure and the total test current should not be large enough to cause further fusing of alclad at the faying surface, as this naturally introduces erroneous test indications.

5. Cleaning the sheet surfaces above the weld with steel wool and acetone tends to improve test consistency.

Inherent errors in this test method, present even when test equipment is correctly designed, accurately built, and properly used, are:

1. An error in predicting weld strength amounting to as much as 100 percent of actual weld strength, resulting from

the inability of this test to discriminate the relative areas of alclad and nugget bonding at the faying plane. Both types of bonding have low resistance in comparison with the unbonded oxide coated areas of the faying plane, and both types of bonding serve equally well as electrically conducting areas in this test.

2. An error of as much as 100 percent in potential indication, resulting from displacements of the electrode assembly by 1/32 inch or more from concentricity with the bonded area at the faying plane. Since there is no indication on the outer sheet surface of the exact location of the bond at the faying plane, save the indentation caused by the welder tips, this error cannot be remedied except by profiling the weld region to obtain a minimum indication. Results of typical profile electrical test on welds are given in figures 10 and 11.

3. An error of variable magnitude resulting from variations in the shape of the conducting area at the faying plane. A long narrow bonded area might develop the same shear strength as a circular bonded area of equal magnitude, but test indications would vary.

4. An error of variable magnitude resulting from the presence of adjacent welds or rivets near the weld under test. A portion of the testing current is shunted through these adjacent bonded areas, lowering the test indication. Similar large errors in indication may result when "spits" or expulsion of metal occur and bond the faying surface near the weld under test.

Improvements in this test method were obtained by following the listed precautions, and, in addition:

1. By modifying the originally proposed three-point current-electrode assemblies to use four to six points (ϕ) or areas of contact arranged in a circle, or a cylindrical electrode (ϕ) making a circular contact with the sheet surface. This eliminated errors occurring on welds with elementary nugget formation when chance alone determined whether only one, or two, of the current electrodes in the three-electrode assembly lay over the bonded portion of the weld.

2. By selecting the diameter of the circle of current electrode contact slightly larger than the bonded area of the normal weld, optimum sensitivity to weld area was obtained, with minimum shunting of current through adjacent welds.



3. By applying a measured pressure ( $p$ ) to the current electrodes which were accurately aligned in the form of a circle of spherical contacts or a cylindrical contact, variation in depth of penetration of the current electrodes into the sheet, and errors in alignment, were greatly reduced.

Advantages of the two-side direct-current test include: (a) its simplicity, (b) its great sensitivity to weld presence (indications increase by a factor of 80:1 as the electrode assembly is moved off a weld to a point halfway between two welds 1 inch apart), (c) its effectiveness in measuring the area of contact regardless of type of bonding present (the extent of alclad bonding is very difficult to measure by other methods):

Disadvantages of the two-side direct-current test include: (a) its inability to measure weld strength reliably, (b) its inherent errors, (c) the fact that it requires access to both sides of the weld, (d) the large testing currents required, (e) the small energy available in the potential circuit.

2. One-side direct-current test<sup>b</sup>.-- In this test, a direct current is passed between two current electrodes (I) both of which are in contact with the same outer sheet surface above the spot weld. The potential drop between two probes (p) placed on the center line of the current electrodes, also in contact with the same outer surface of the sheet, is measured by a potentiometer or low resistance galvanometer. (See fig. 12.) In the weld region, some of the current tends to flow down below the faying plane through the bonded area, reducing the current density in the upper sheet above the weld. Thus the potential gradient is lowered above a spot weld with a large area of bonding, and lower potential indications result.

Precautions identical with those listed for the two-side test must be observed with this method.

Inherent errors identical with those listed for the two-side test exist with this test method. In addition, the one-side test is very much less sensitive to the presence of a weld, and to its size, than the two-side test. Whereas the two-side test indication changes by a factor of 80:1 as the test assembly is moved from a location 1/2 inch from the weld to a point over the weld, the one-side test changes its indication less than 20 percent with a similar movement of the assembly. Since only a small fraction of the total current

flows below the faying plane at the weld, the percentage change in indication between small welds and large welds is less than 10 percent, under optimum test conditions involving only one weld in a 1-inch wide shear test strip. (See fig. 13 for typical results of tests made on 29 spot welds in 1-inch-wide, one-spot, lap-joint test strips of 0.064-inch 24S-T alclad sheet. In large sheets containing many welds, the change in indication becomes exceedingly small and very difficult to detect - experiments on industrially made welds showed this change to be entirely masked by the inverse effect of the indentation of the sheet by the welder electrode. (See fig. 14.) The limits of sensitivity of this method, determined by calculations, and checked by potential measurements in a large scale salt-water model of the conductor in the weld region, are very low. In practice it is difficult to realize even a fraction of the theoretical limit of sensitivity.

Improvements in this test method were obtained by following the listed precautions, and in addition, by modifying the electrode assembly to form a Wheatstone bridge circuit with the weld under one leg of the bridge. (See fig. 15.) The direct current passes through the sheet from electrode  $I_1$  to electrode  $I_2$ . The weld, if adequately bonded, lowers the resistance of one leg of the bridge. A potential appears between  $P_1$  and  $P_2$  due only to the effect of the weld in unbalancing the current distribution. A far greater percentage change in indication with change in weld size is obtained than with the unmodified one-side test. This test also discriminated welds with large bonded area from welds with small bonded area in single spot-weld 1-inch test strips, but suffered great loss of sensitivity when applied to large sheets with many welds.

The advantage of the one-side test lies in the fact that access is required to only one side of the welded structure. Although 90 to 95 percent of all spot welds in aircraft structures are accessible from both sides at some point in the fabrication process, this would enable the testing of welds even on closed structures.

The disadvantages of the one-side test lie in its inherent errors and in its very low sensitivity. Only small deflections can be obtained, even with long-period, high-sensitivity galvanometers in the potential circuit. Test indications are affected as much by sheet indentation as by the presence of weld bonding. No practical reliable form of this test has been developed as yet.

3. Lap-joint direct-current test (f). - In this test a direct current is passed through the weld between two current electrodes, one of which is in contact with the top surface of the upper sheet directly above the weld, while the other is in contact with the top surface of the lower sheet adjacent to the weld. (See fig. 16.) The major part of the current thus passes normally through the faying surface of the weld under investigation. The potential probes are located at the centers of the cylindrical current electrodes, in one form of the test assembly. Variations in the area of bonding at the weld introduce variations in the potential drop near the faying surface which tend to introduce variations in the total drop between the potential probes. Higher potential drops should occur with weak welds of small bonded area.

Precautions to be observed in making this test include those listed for the two-side direct-current test, except that the current electrode in contact with the lower sheet must be in a fixed position with respect to the weld, as close as possible to the weld. This electrode should contact only the lower sheet.

Inherent errors, similar to those listed for the two-side direct-current test, exist for this method. In addition, much larger errors, due to extended path of current flow along the lower sheet, result from variations in geometry of structure, edge effects, adjacent welds, and amount of overlap in the lap joint.

The disadvantage of this test is its very low sensitivity. The maximum possible variations in the total potential which could result from varying the geometry of bonding at the faying surface of the weld are only 5 to 10 percent of the total potential drop. This is not a sufficient degree of sensitivity. Uncontrollable variations due to other factors are of the same order of magnitude. In general the variations at the faying surface are completely masked, and the test is of no value.

Figure 17 shows the sensitivity of the assembly to the presence of a weld. The assembly was moved lengthwise over the surface of the weld, and readings taken every 1/16 inch. Comparison of this curve with figures 10 and 11 for the two-side test shows clearly how much less sensitive this assembly is to the presence of a weld. In the two-side test the ratio of potential measurement halfway between welds to potential measurement directly over the weld is about 80 to 1; whereas

In this case the ratio is only about 1.5 to 1. To determine the ability of the assembly to detect unfused "welds," tests were conducted on a group of welds in which 2 out of every 3 were not fused. (The welds were purposely made this way.) The results are tabulated on this page in table I. The same welds were then subjected to the two-side test and the results are recorded alongside. It is to be noted that the readings of the one-side test vary only a small percentage (5 to 10 percent) between fused and unfused welds (the fused welds were normal strength); whereas the two-side test gives roughly a 10,000 percent variation between these two types of weld. It may be reasonably concluded that the lap-joint test will not even detect with certainty a completely unfused weld. In view of this direct evidence, it was decided useless to conduct tests on welds where the strength variations were smaller. On the basis of the above facts, it seems certain that this particular one-side test is not useful. Since, with this apparatus, the weld was isolated as completely as is possible, other types of assemblies with more remote electrodes would certainly not be useful.

TABLE I

Weld	Electrical indication* One-side test	Electrical indication* Two-side test	Full strength
1	12.0	9.2	0
2	7.0	14.0	0
3	6.4	.087	725
4	6.8	10.5	0
5	6.4	12.5	0
6	6.4	.070	860
7	6.6	7.5	0
8	8.8	10.8	0
9	7.3	.071	805

\*Indication in  $\mu$  amperes per ampere

4. One-electrode direct-current test ( $\phi$ ).-- In this test, current passes into the weld region from one electrode (frequently a ring contact), and is collected from the spot-welded structure at remote points. Two potential probes (P) are radially displaced within the current electrode (I). (See fig. 18.) Over the center of a uniform sheet, very little potential difference appears across the potential probes when current flows away from the current electrode symmetrically through the sheet. If current flows into the lower sheet of a joint through a weld under the electrode assembly, a larger difference of potential appears between the radially displaced potential probes. The potential distribution in the weld region is similar to that obtained with heat flow from a source in contact with the sheet surface. Development of this type of test has been postponed, since the variability of the return current path makes this test less reliable than even the lap-joint direct-current test.

5. Alternating-current conduction tests ( $\phi$ ).-- Each of the types of test described for direct current might conceivably be used with alternating current, provided inductive pickup could be eliminated from the potential probes and leads, and a suitable detector for 5 to 50 microvolts alternating current supplied. Alternating-current galvanometers are too insensitive for use as potential indicators; so vacuum tube amplifiers with stable calibrations are usually indicated. A direct-current galvanometer used with a suitable copper-oxide rectifier of very low resistance can also be applied, for larger potential drops.

In addition to the precautions listed for direct-current tests, especial care must be used to avoid inductive pickup in the potential probes and leads. The resistance drop of potential across the weld is so small that the inductive pickup in unshielded potential leads would be several hundred times larger. Even though this induced voltage were 99 percent canceled by a reverse inductive voltage purposely introduced in the potential circuit, a large error in indication would remain. This difficulty nullifies other apparent advantages in the use of alternating current.

Inherent errors, identical with those listed for corresponding direct-current tests, exist with alternating-current conduction tests.

Advantages of alternating current over direct current in conduction tests lie in the simplicity of high-current power-

supply transformers and the possibility of instantaneous indications.

Disadvantages due to inductive pickup and lack of sensitive alternating-current potential indicators have been cited.

### C. Eddy-Current (Induction) Tests

Several types of eddy-current tests have been proposed. In these tests, alternating magnetic fields are established in the region of the weld, resulting in a flow of alternating electric current through closed paths within the welded sheets. Since the resistivity differences of the various regions of sound welds are too small to serve effectively for discrimination of weld quality, eddy-current tests, like conduction tests, must measure the area of bonding at the faying plane to predict weld strength. This can be achieved only by a flow of current normal to the faying surface at the bond.

In thin conducting sheets it is very difficult to establish a significant component of current flow normal to the sheet surface. A variety of induction assemblies have been tried, even using massive blocks of good conductor to force the magnetic field down into the sheet, with no success whatever in establishing a significant amount of current flow normal to the faying surface at the bond. Detection devices producing eddy currents flowing predominantly in planes parallel to the sheet surfaces have not been able to differentiate between good and bad spot welds. (See fig. 19.)

Eddy-current test devices respond sensitively to sheet-surface geometry, weld cracking, and porosity. (See reference 11.) They are applicable in detecting these conditions which may correlate with the fatigue strength of the weld, but which do not measure static shear strength. No eddy-current device proposed is known to measure static shear strength effectively.

Advantages of eddy-current test methods are: (1) Access is required to only one side of the welded sheet; (2) No electrical contact with the sheet surface is required; (3) Instantaneous indications are possible; (4) Depth sensitivity may be adjusted by choice of frequency.

Disadvantages of eddy-current test methods are: (1) Difficulty is encountered in establishing current flow normal to the bonded area at the faying surface; (2) Probe



assemblies pick up very little energy; (3) Cracks, porosity, and sheet indentation tend to affect indications far more than does the area of bonding at the faying plane; (4) Edge effects and adjacent welds affect indications; and (5) Even if eddy-current flow could be established normal to the faying plane at the weld bond, no discrimination between cast alloy bonding and alclad bonding (with only half the strength of the former) could be obtained.

1. Transformer-loading induction test ( $\beta$ ) .- The simplest eddy-current induction-test unit consists of a coil carrying alternating current placed above the conducting sheet so as to produce eddy currents which act as a secondary transformer load on the coil. Using cores of powdered iron in wax molded about small coils, the investigators have obtained a highly sensitive system of measuring sheet thickness, surface indentation, and resistance to the flow of eddy currents flowing in planes parallel to the sheet surface. No pickup coils or amplifiers are used; instead the coil and a suitable condenser are made parts of a series resonant arm of an alternating-current bridge, the flow of eddy currents in the sheet being reflected in the coil by increased primary coil current. (See fig. 20.) The change in inductance due to the secondary currents detunes the resonant circuit, and for a coil  $Q^*$  as low as 20, a 300-percent change in voltage across the condenser occurs when the unit is lifted from the surface of the conducting sheet. A 2-percent change in the thickness of an 0.080-inch sheet can be readily detected, without the bridge circuit, by measuring changes in voltage across the condenser with a vacuum tube voltmeter (1-percent changes are observable with the bridge circuit assembly).

The location of the eddy-current path in the conducting sheet can be controlled by the use of a concentric pole assembly which can be easily formed to any desired shape using the powdered iron in wax. A few of the more useful configurations are shown in figure 21. The depth of penetration of the eddy currents may be decreased by increasing the applied frequency. A quick check on eddy-current penetration may be obtained by bringing a massive block of conductor into contact with the sheet surface opposite the coil, and observing the highest frequency at which it affects the indication.

---

\* $Q$  is the ratio of stored energy to dissipated energy in the coil, and is given by  $Q = \omega L/R$ , where  $\omega = 2\pi$  times the frequency,  $L$  is the inductance, and  $R$  is the effective resistance of the coil.

No arrangement of pole pieces has yet been devised to force sizable components of the eddy currents to flow normal to the sheet surface at the weld. The flow of eddy currents in small circular paths in the plane of the sheets has proved very effective in detecting weld cracking and porosity. Such weld cracks are usually radial cracks, normal to the sheet surface, extending outward from the center of the weld nugget, and so lie directly across the path of the circular currents. (See figs. 6 and 20.) The indication measures the over-all extent of cracking and porosity, without measuring the geometry of individual cracks.

This device is also sensitive to the air gap between the pole pieces and the sheet surface. Thus it responds to indentation of the sheet by the electrodes of the welder, and actually has appeared to discriminate between good and bad welds through the measurement of the increased indentation which tends to accompany larger weld nuggets.

Precautions to be observed in using the transformer-eddy-current assembly are: (1) Frequency must be selected to obtain eddy-current penetration adequate for sensitivity to weld properties; (2) The air gap between pole pieces and sheet surface must be maintained constant; (3) Corrections must be made for changes in sheet thickness, material, and temper; and (4) It must be recognized that current flow is predominantly in the plane of the sheet and that the test does not measure static shear strength of spot welds, since its indications are independent of the bond between the sheets.

Inherent errors in this test method are (1) its inability to discriminate between porosity or small cracks, and certain larger crack defects, or local changes in the resistivity of the material.

Improvements in this test method were obtained by using low-loss powdered iron in a highly insulating wax, and operating at the highest frequency consistent with adequate penetration of eddy currents into the sheet under test.\* A high coil "Q" was thus obtained, resulting in a sharp, high resonant peak in the low-resistance circuit. By operating on the steep slope of the resonance curve (fig. 22), maximum sensitivity to sheet-resistivity conditions is obtained. By

\*Frequencies of 3,000 to 30,000 cycles were found useful with sheet thicknesses varying from 0.181 inch to 0.016 inch. Example: For 0.064-inch sheet,  $L = 34$  millihenries,  $C = 0.0025$   $\mu$ f,  $f = 17,000$  gave a change from 24 to 100 volts across condenser when coil assembly was lifted off sheet.

including the coil or capacity in one leg of an alternating-current bridge, the indicator may be set to zero when the coil is in position above normal sound sheet material, and vary its indication only when the coil is over cracks and unsound sheet material. By using concentric poles, the eddy-current path may be confined to a narrow ring, eliminating effects of adjacent edges, holes, and welds not under test.

Advantages of this test method are: (1) Access is required to only one side of the sheet; (2) No sheet preparation or cleaning is required, and no electrical contacts are made with the sheet; (3) Measurements may be made through paint or insulating coatings without damage or puncture; (4) No probes or low-energy indicating circuits are used - hence no difficulties due to contact resistance, thermal electromotive forces, inductive pickup, high-gain amplifiers or sensitive meters are encountered; (5) Wide flexibility, due to choice of frequency, geometry of pole assembly, and sharpness of tuning, can be obtained in applications; (6) The eddy-current pattern is ideal for the detection of radial cracks in spot welds; and (7) The device serves effectively as a thickness or alloy detector for conducting sheets.

Disadvantages of this method are: (1) Only eddy currents flowing in planes parallel to the sheet surface can be established readily; so bonding at the faying surface is not measured (thus spot-weld static shear strength cannot be measured); (2) Variations in the air gap between pole pieces and sheet surface have a large effect upon indications; (3) Indentations and variations in sheet thickness affect indications; (4) The exact geometry of cracks and porous defects cannot be determined.

2. Transformer-loading induction test modified for lap joints<sup>c</sup>. - A modification of the simple transformer-loading test makes possible the induction of eddy currents which flow normally through the weld bond at the faying surface, if a return path can be provided. An exciting coil with concentric cores is designed to fit over the lap joint, as shown in figure 23. Frequency is adjusted so that eddy currents are not induced in significant amounts at a depth greater than 1-sheet thickness. If the exciting coil is placed on the lap joint between two spot welds, the eddy currents flowing beneath the turns of the exciting coil (between the inner and outer magnetic poles) tend to follow a path through the upper sheet, down through one weld to the lower sheet, and return through the second weld. Small bonded areas at the welds tend to introduce resistance into the eddy-current path.

while with no conducting bond at the welds, a very high resistance is introduced. These conditions are reflected in the resonant primary circuit and indicated by a vacuum tube voltmeter.

Inherent errors in this test method make it practically worthless for spot-weld inspections. These errors include (1) all the inherent errors listed for the two-side direct-current test; (2) large errors due to edge effects, holes, rivets, and the irregular spacing between adjacent spot welds; (3) an error due to variations in overlap and in the distance of the weld from the lap edge of the sheet; (4) errors resulting from effects of welds in the return path (at least two welds affect each indication). The location of the spot welds with respect to the lap joint has a greater effect upon indications than does weld size or quality.

3. Pickup-coil eddy-current tests<sup>d</sup>. - In these tests, eddy currents are induced in the sheets under test by currents in exciting coils, and variations in the eddy-current pattern are detected by sensitive pickup coils connected through high-gain amplifiers to suitable indicators. (See reference 12.) In many designs, the pickup coils measure only the departure of the eddy-current pattern from the pattern in a uniform sheet. Several typical pickup units are shown in figure 24.

Pickup unit A<sup>d</sup> has an exciting coil and concentric poles similar to those described for the transformer induction test. In addition, however, a sensitive magnetic pickup system is symmetrically located within the center leg of the core. The two poles of the pickup are slightly displaced from each other. The pickup coil is shielded from the magnetic field of the exciting coil. With the normal circular flow of eddy currents established in sound continuous conducting sheet by the exciting coil, no magnetic flux variations occur in the core of the pickup coil. When the coil is placed over a crack or discontinuity, however, the modified eddy-current pattern produces an alternating magnetic field through the pickup coil. (See fig. 25.)

Pickup unit B<sup>e</sup> was specifically designed in the Naval Research Laboratory for use in testing spot welds, with the hope that a sizable component of eddy-current flow might be established across the faying surface into the lower sheet at the weld, producing an unbalance current in the pickup. The frame on which the coils are wound is made of transformer laminations. The magnetic field of the exciting coils is

additive so that the outer pole faces are of opposite magnetic polarity. An exciting frequency of 1000 cycles was used. Analysis of eddy-current patterns shows that if the weld is cracked or porous, or if eddy currents do flow below the faying plane through the weld bond, a pickup due to unbalance will result if the weld is unsymmetrically located with respect to the center pole on which the pickup coil is located. Scanning is required to obtain maximum information concerning a weld.

Naval Research Laboratory tests of this unit indicated:

1. This eddy-current method is not satisfactory for the detection of the quality of fusion between the two welded sheets.

2. The effect of porosity or cracks on the detector was such as to overshadow all other effects. This makes possible the detection of cracks or porosity with little difficulty.

Tests at the California Institute of Technology on similar units confirm these results.

Pickup unit C<sup>f</sup> was designed at the Lockheed Aircraft Corporation for use in testing spot welds. Large blocks of copper conductor were employed to force the magnetic field of the exciting coils into the welded sheet. Despite several modifications, the difficulty in establishing a sufficient eddy-current flow normal to the faying plane at the weld prevented successful measurement of the area of fusion at the weld.

In general, research has shown the pickup-coil eddy-current tests to be subject to the limitations and inherent errors previously listed for eddy-current tests. No successful method has been devised for measuring the bonded area at the faying plane through the use of eddy currents.

#### D. Thermal Test Methods

Thermal test methods involve the flow of heat through the weld region and the measurement of resultant temperatures or temperature gradients. The presence of the weld modifies the heat-flow pattern in an unwelded sheet:

1. Geometrically, since heat tends to flow normally



across the faying plane through the weld to the opposite sheet and so possibly measures weld-nugget diameter; and

2. Through its variable heat conductivity (if differences in conductivity do exist in various regions of the weld) and the presence of cracks and porosity. Heat capacity of the region under test affects the transient temperature response only.

Advantages.- Heat-flow methods are readily adaptable to one-side testing, as well as to two-side testing. No return paths are necessary. Heat flow may measure total weld diameter at faying surface.

Disadvantages.- Owing to heat-capacity effects, heat-flow methods cannot be instantaneous and usually are slow tests. Ambient temperature, surface thermal contact resistance, size of parts welded, original temperature of work, presence of cracks, nature of heating and method of temperature measurement - all change resultant temperatures and tend to invalidate readings. Thermocouples to measure temperature have small energy output, give slow readings and require sensitive indicators. Although heat-flow indications respond to weld cracking and porosity, they do not differentiate sufficiently between the cast-alloy nugget and the parent metal to measure nugget geometry. Also, heat-flow tests fail to differentiate between cast-alloy bonding and alclad bonding at the faying surface; so the static shear strength of welds is not accurately measured.

1. Heat-reservoir thermal test.- A copper heat reservoir (similar to a massive soldering iron) with two contact lugs carrying imbedded thermocouples (fig. 26) is heated to a temperature considerably above that of the weld to be tested. One lug is placed in contact with the sheet surface above the weld, and heat flows into the weld region by conduction. If a weld is present, heat flows through the bonded area of the faying plane to the lower sheet, and the total rate of heat flow from the reservoir is greater than when the weld is absent, for in the latter case only the upper sheet conducts heat away from the reservoir. The drop in temperature recorded by the thermocouple imbedded in the lug in contact with the sheet is a measure of the rate of heat flow from the reservoir to the sheet. The thermocouple imbedded in the second lug through which no heat flows measures the temperature of the reservoir. A sensitive galvanometer is employed to measure the differential output of the thermocouples.



Precautions to be observed in making this test are:

1. The heat-source lug must be accurately located above the weld, and must make contact with the same sheet area on each weld tested. (Variation in the shape of the electrode indentation makes this very difficult in practice.)

2. The sheets to be tested should not vary widely in temperature and should preferably be at ambient temperature.

3. The ambient air must be still - a slight draft changes indications far more than the presence of a weld.

Inherent errors in this test method, identical with those listed for the two-side direct-current test, exist.

1. In addition, a very large error results from variations in the thermal contact resistance at the sheet surface where heat is being introduced, due both to changes in contact area and to surface films of variable nature.

2. Changes in ambient temperature or air velocity, and in material temperature, affect indications greatly.

3. Progressive heating of the work as successive welds are tested changes indications, even on identical welds.

4. The presence of adjacent welds, rivets, edges, masses of metal, holes in the sheet, "spit" or expulsion of metal from the weld region - all result in erroneous indications.

Improvements on this test method were obtained by following the listed precautions, by insulating the heat reservoir and lugs from the ambient air, by cleaning the sheets and lugs and removing oxide before each test, by holding the unit on the sheet surface under controlled pressure a fixed period of time, and by working in a small closed room with work at room temperature. This latter item required a delay between weld measurements, the time being used for cooling and cleaning the sheet over the next weld with acetone.

Advantages of the heat-reservoir thermal test are:

(a) Access is required to only one side of the work; (b) The heater and temperature indicator may be in a single unit requiring only one application; and (c) No marking of or damage to welds results.

Disadvantages of this test include: (a) its inherent

errors, (b) its sensitivity to ambient-air conditions, (c) the difficulty of obtaining uniform thermal contact with the sheet surface, and (d) its inability to indicate weld static shear strength.

2. Induction heating tests ( $\phi$ ). - In these tests heat is supplied rapidly to a small area of the alclad sheet directly above the weld, at a measured rate or in fixed amount, by modified industrial induction surface hardening equipment. The frequency is chosen sufficiently high to limit the penetration of the heat-producing eddy currents to a thin layer at the sheet surface. Thus thermal contact resistances between heat source and sheet are eliminated as variables, and the rate and amount of heat production are controlled. When a large area of weld bonding is present, a large fraction of the generated heat flows normally across the faying plane into the lower sheet. With no weld bonding, all the heat must flow away in the upper sheet. (See fig. 27.) Thus the heat flow is sensitive to the area of bonding.

For one-side testing, the temperature indicator must lie under the induction heater on the same surface of the work - hence must not be affected by the high-frequency field. Only a carefully shielded thermocouple would be suitable. However, by closing the thermocouple circuit to its indicating galvanometer only after the high-frequency field is turned off, the cooling transient of the sheet surface may be recorded, provided the galvanometer responds with sufficient rapidity. Some success has been attained by the use of a thin layer of wax\* or thermoplastic in the sheet surface, by observing the diameter of the softened, melted area which results when the controlled quantity of heat is generated above the weld.

For two-side testing, the indicator is placed on the side of the work opposite the weld where it is not affected by the high-frequency field. In this case, the heat which reaches the temperature indicator must flow through the weld at the faying plane. The entire heating and cooling transient for the controlled heat generation cycle can be observed with great sensitivity to the size of the bonded area. Both thermocouple and wax-film indicators have proved to be effective.

---

\*Suitable calibrated wax temperature indicators are commercially available from the Fisher Scientific Co., Pittsburgh, Penna., in the form of Tempilstiks and Tempil Pellets.

The most convenient form of thermocouple indicator developed for this purpose consists of a low-thermal-capacity thermocouple supported against the sheet surface by a small rubber suction cup. The inner surface of the cup is coated with a heat-reflecting surface thermally insulated from the rubber, and the suction cup excludes the ambient air - hence despite sheet-surface condition, the thermocouple follows the sheet temperature closely. The second junction is similarly attached to the sheet at a remote point, so that only temperature differences due to the heating of the weld region are measured. Both junctions are quickly and easily attached to any point of the sheet surface by means of the suction cups, and may be pulled off and moved at will.

The laboratory wax-film indicator consists of a thin layer of parawax or thermoplastic material placed on the sheet surface. When cool and hard, a dry, colored powder or dye is sprinkled over the wax. When heat generated in the opposite sheet at the weld flows through the weld in sufficient quantity, the wax above the bonded area melts, and in this region the powder becomes imbedded. A complete joint may be tested at one time, and a permanent record obtained by subsequently placing a strip of Scotch tape over the line of welds. The tape picks up the powder over all areas except where the wax has melted and imbedded the powder. For practical use "Templestiks" may be used as temperature indicators. Large welds, small welds, and no bond whatever are readily discriminated from one another by the extent of melting of the wax.

Precautions to be observed in using the induction test are:

1. The induction heating unit must be accurately located above the weld. The temperature indicator must be equally accurately located, as the temperature gradient in the plane of the sheet is quite large.

2. The rate and amount of heat generation must be precisely controlled by synchronous or electronic timing units, if bonded area is to be determined accurately from temperature indications.

3. Ambient air should be quiescent. No condensed moisture should be present on the structure. All parts of the joint should be approximately at room temperature.

Inherent errors in this test method are similar to those listed for the heat-reservoir test, save that errors due to contact resistance are eliminated.

Advantages of the induction-heating method are: (a) The test may be made with access to either one or both surfaces of the work; (b) The method measures total bonded area reliably, and permanent records can be easily produced; and (c) Contact thermal resistances are eliminated as variables.

Disadvantages are: (a) Finite heating times (a few seconds) are required; (b) Careful positioning and control of ambient conditions is necessary; (c) Spot-weld shear strength is not measured reliably; and (d) Adjacent welds, edges, holes, and masses of metal introduce large errors.

3. Radiant heating tests (♯). - In these thermal tests, heat is supplied to the surface of the welded sheet by radiation, as from a concentrated heat lamp and focusing system. The sheet surface must be cleaned or painted to obtain uniform heat absorption over the test area. Thermocouples may be used on the one-side test if shielded from direct radiation, without internal heating effects present with induction heating methods. The method is slow and is subject to the previously listed errors of thermal tests. Temperature indications are obtained as in the induction heating test, when the indicator is on the opposite side of the weld from the radiant heat source.

4. Contact-drop heating test (♯). - One condition has been found in which electric current flowing from pointed electrodes into alclad sheet produces a contact drop of potential approximately constant at about 0.2 volt for currents from 20 to 90 amperes direct current, releasing considerable heat at the point of contact. This is equivalent to a point source of heat, and the rate of temperature rise per watt of energy input would be affected by weld presence. This method is especially suitable for use with wax-temperature indicators, either in one- or two-side test, although thermocouples may be used.

5. Differential heating tests (♯). - In methods 2, 3, and 4, effects of weld presence could be increased, and the effects of variable ambient conditions reduced by the heating of two areas, one over the weld and one not over the weld, under identical conditions, and measuring the differential temperature of the two regions by a thermocouple system. Because of the duplication of heating equipment required, this modification has not been investigated in this research.

### E. Sonic and Vibration Tests

Sonic and vibration tests are usually of three basic forms: measurements of vibration damping; measurements of wave reflections; measurements of the natural frequencies of oscillations. Each type has been proposed for the nondestructive testing of spot welds in aluminum alloy sheets.

Sonic and vibration tests, by their very nature, are more easily applied to pieces of fixed size and shape, to detect material properties and defects, than to structures of irregular and variable shape. Spot-welded structures offer a less promising field of application because of their complex shapes, which affect test indications considerably. Hence care must be taken to avoid the development of test procedures which cannot be reduced to practical forms applicable to spot welds.

1. Vibration damping tests.— One form of vibration or damping test proposed for spot-weld testing employs a driver to establish oscillations of adjustable frequency in the weld region and a detector to measure the resultant amplitude. For sonic and lower frequencies, a coupled electromagnetic-mechanical transducer (similar to the driving units of loud speakers) is employed as driver, while for supersonic, magnetostriction or quartz crystals are used.\* Power is supplied from variable frequency oscillators to these driving units. Detectors for measuring the resultant vibration amplitude usually consist of a piezo-electric pickup or other microphonic device, connected through suitable vacuum tube amplifiers to indicating instruments. (See fig. 28.)

The damping can be determined for a system of any shape, provided it can vibrate. In one method of measurement, constant energy is supplied the driver at varying frequency, to obtain in the detector a resonance curve (fig. 29) showing the amplitude of vibration as frequency is varied through one of the natural frequencies of the system. Theory indicates that the mechanical damping of resonance curves can be readily determined from their breadth. If  $\Delta f$  represents the breadth of the resonance curve at half the maximum amplitude, then the damping  $\delta$  is given by

---

\*Magnetostriction generators are useful from about 8,000 to 50,000 cycles, and quartz crystal generators are useful at higher frequencies.

$$\delta = 1.814 \frac{\Delta f_{\frac{1}{2}}}{f_{res}}$$

where the resonant frequency  $f_{res}$  and the frequency difference of the half amplitude points,  $\Delta f_{\frac{1}{2}}$ , are measured in cycles or vibrations per second.

A second method of measuring damping requires that oscillations be established, then be allowed to die out by disconnecting the driver. If the amplitude of successive vibrations are observed by the use of a cathode ray oscillograph or equivalent, the damping may be determined as

$$\delta = \ln_e \frac{A_n}{A_{n+1}}$$

where  $A_n$  and  $A_{n+1}$  are two consecutive amplitudes of the free vibration. Where the frequency is too high or too small to make possible this measurement, the damping may be determined from the time required for the amplitude of the resonant oscillation to fall to one-half its original value, by the relation

$$\delta = \frac{0.693}{t_{\frac{1}{2}} f_{res}}$$

This time  $t_{\frac{1}{2}}$ , or even the product  $t_{\frac{1}{2}} f_{res}$ , may be determined directly by the use of electron tube indicators, even with very high frequency oscillations. (See reference 13.)

In bars of fixed geometry, faults of any kind in the material combine to raise the damping, so that cavities, cracks, and porosity are easily determined. In spot welds, large differences of geometry may exist; in addition to possible cracks or porosity, and cast and wrought alloy, as well as pure aluminum cladding, are present simultaneously. The soft nugget material tends to increase damping, and a change in nugget volume could not be differentiated in tests from the introduction of cracking. Preliminary tests showed damping indications to depend upon too many weld properties to serve as a reliable indicator of spot-weld properties. Further development of the method was postponed while simpler test methods were exploited.

2. Wave-reflection tests (1). - It has been proposed that the area of bonding of spot welds might be measured by



supersonic waves, which would reflect from the faying surface of unbonded regions, but would pass through the faying surface at the weld bond. For one-side test methods, the presence of bonding might be detected through (a) the frequency at which standing waves (half-wave resonance) could be established between the oscillator and reflecting surface, or (b) the time required for a wave train to pass from the sender to the reflecting surface and return. (See fig. 30.)

A fine development of supersonic testing equipment has been carried out by Professor F. A. Firestone of the University of Michigan. His equipment produces three wave types - longitudinal, shear, and surface - and provides suitable detection and recording equipment. Using his Supersonic Reflectoscope, Professor Firestone has distinguished a spot which is welded from one which is not bonded as follows (quoted from a letter from Professor Firestone).

"A wave train of longitudinal waves is sent in at the upper face of the weld. The weld assembly is so thin that the first reflection from the other side of it cannot be distinguished, but the waves reverberate back and forth through the thickness of the weld assembly while the total distance of their travel back and forth may be several inches. Their successive impingement on the crystal generates a voltage which can be observed on the reflectoscope screen several inches after the sending out of the wave train. If, now, one holds his oily finger against the bottom face of the weld, these successive reflections will be damped out, thereby proving that the waves are really passing through to the bottom face and that there is, therefore, a weld.

"If there is no weld, a similar series of successive reflections is observed, but upon touching the oily finger to the bottom face of the weld there is no change in the appearance of the reflectogram, thereby proving that the waves are not entering the lower plate. Thus far, the method is not quantitative, but merely all or none.

"One can imagine improvements in the method as the result of research which would improve its usefulness. The above-mentioned tests were made with 5-megacycle longitudinal waves, but we have produced as high as 20 megacycles and we have also produced shear waves which travel half as fast as longitudinal waves so that this represents a factor of 8 reduction in wave length. With these shorter wave lengths it might be possible to actually explore over the surface of the weld and thereby determine the actual welded areas. This

would be particularly feasible on the heavier gages where the weld is comparatively large.

"One can imagine sending comparatively powerful continuous waves through the weld and have the back side coated with something like paraffin which would be melted in those areas where the wave energy was being received and would thereby outline the welded area."

"We have used longitudinal or shear waves for the accurate measurement of the thickness of a sheet when one side is inaccessible, using the general method of establishing a half-wave resonance through the thickness of the plate and then determining the frequency. This method might be applied to weld testing since, if there is no weld under the area being tested, the thickness thus indicated would be approximately that of one sheet, while if the weld exists the thickness is approximately that of two sheets.

"We can also produce surface waves which run over the surface of a metal part in much the same way that water waves travel. Surface waves could be sent along the lower face of the upper plate and reflection obtained from the closest point in the weld, even though that might be in the cladding."

Present indications are that detection of the area of bonding of a spot weld at the faying surface might thus be feasible by supersonic testing, but the ability of supersonic tests to discriminate between cast-alloy bonding and alclad bonding has not yet been demonstrated. Likewise, there would probably be some difficulty in detecting weld nugget geometry by wave-reflection methods. Hence, for the inspection of spot welds, supersonic-reflection test indications seem to be limited to measurements of the total bonded area at the faying surface. The two-side electrical test makes this measurement with simple testing equipment, and since this measurement alone is not a reliable indication of spot-weld strength, no elaborate development of supersonic test equipment has been included in this research program.

3. Nugget oscillation tests.- Assuming an ideal homogeneous weld nugget of flattened spheroidal shape, enclosed within a homogenous mass of harder, tempered parent metal with physical properties different from those of the weld nugget, the frequency of natural oscillations of the weld nugget may be calculated. It has been proposed to excite such nugget oscillations by means of a quartz crystal coupled to the sheet surface, as by an oil drop, and after a fixed

excitation period, to use the same crystal as a detector to observe the damping of the free oscillation. Correlations between natural frequency and nugget size, and between damping and ductility, cracking, and porosity have been predicted.

This test has not seemed sufficiently feasible to justify development. Weld nuggets are of very irregular shape and have internal inhomogeneities and defects. Weld nugget-volume does not measure weld strength precisely. The difference between nugget and parent metal properties is not sufficient to provide an effective discontinuity to the flow of vibration energy. The natural frequency of nugget oscillations would be extremely high. Effects of adjacent material and sheet geometry might affect test indications excessively. Simpler test methods offer more promise.

4. Ultra-sonic wave-pattern test (6). - This test differs from those previously outlined in the method of application of the energy source and in the method of pickup. A moderately high ultrasonic frequency has been used (about 1,000,000 vibrations per second) to obtain high resolving power by the sound waves. The sound is transmitted from an ultrasonic generator to the sheet surface below a spot weld by an anvil and the vibrations travel through the weld to the upper sheet surface. If oil or other liquids are placed thereon, radial circles centered over the weld will be observed. These are standing wave patterns the configurations of which may indicate the bonded area of the weld. By the substitution of a material such as collodion for the indicating oil, a permanent record of the weld has been obtained. The results so far obtained on this test are not conclusive but the method shows promise and should receive further consideration and investigation.

Advantages. - The weld geometry probably can be determined from this test, through the analysis of the wave-patterns produced. Obviously if little or no mechanical coupling exists between the upper and the lower sheets at the weld, bonding at the faying plane is lacking and resulting patterns differ from those denoting satisfactory bonding conditions.

Disadvantages of this test method are: (1) The equipment necessary to provide the test is rather elaborate, and includes an oscillator capable of supplying about 1 kilowatt of radio-frequency power to the ultrasonic generator, which in turn has auxiliary equipment necessary for continuous operation. This auxiliary equipment is somewhat compensated for

by the stable and reliable operation secured. (2) Training is required for one unskilled in this method of testing reliably to interpret patterns in terms of weld quality. (3) Errors may result from possible dispersion effects and variation in treatment and/or composition of material to be examined. (4) The coupling anvil should be properly centered on the bottom indentation to secure uniform mechanical coupling, and anvil contours should fit those of the weld indentation.

#### F. Sheet-Surface and Material-Property Tests

It has been suggested that spot-weld properties might be correlated with conditions measured at or near the sheet surface above the weld. Properties included are: sheet surface-indentation by welder electrodes, measurement of surface marks or condition, thickness of alclad layer, toughness, ductility, elasticity, impact resistance, scratch or tear resistance, and metallurgical structure at various depths from the sheet surface at the weld.

1. Welder-electrode indentation tests (6).-- Indentation of the surface of the alclad sheet by the welder electrode is a function of electrode size and shape, weld current and temperature transients, pressure program, and sheet properties. With reasonable control of current-wave shape and electrode-tip contour, and precise control of timing and amplitude of the tip pressure, the sheet indentation will correlate well with weld-nugget size. The larger the volume of melted alloy, the greater the indentation caused by the tips, provided the pressure program is precisely controlled and sufficient hold-down pressure is exerted to prevent expulsion of metal at the faying plane.

The sheet indentation may most easily be measured through the use of a sensitive dial gage graduated in 0.0001-inch units, provided with a suitable collar to rest on the sheet surface just outside the indentation. Eddy-current or electrical-capacitance gages may be employed, and provided with permanent record devices if desired.

Inherent errors in this test method result from normal production conditions, to an extent sufficient to invalidate the test. Large changes in electrode shape and contour produce correspondingly large changes in indentation, although the effect of repeated tip cleaning in a few hours' run on one set of tips is not extensive. Changes in tip pressure, or in forge pressure time delay, change indentation greatly.

The ease with which tip pressure and contour may be changed in production welding would prevent this test from attaining reliability.

As control of welding conditions improves, tip shape and pressure program will be more precisely controlled, in which case the validity of the tip indentation test will improve. (See fig. 31 for results of indentation measurements on industrially made welds.)

2. Sheet-surface property tests.- No measurements of physical properties of the sheet-surface layers have shown any correlation with weld size or quality. Marking or thickness of the alclad layer has no significance whatever. The structure and metallurgical properties of the 24S-T alloy are very little affected except in the weld nugget and narrow adjacent regions where incipient melting along grain boundaries and intrusion of eutectic occur. Only measurements of properties in and adjacent to the weld nugget correlate with weld strength and quality. Superficial surface tests measure nothing significant except when the weld nuggets penetrate to the sheet surface (excessive penetration).

#### G. Impressor or Penetrator Tests

In these tests a loaded penetrator or group of penetrators is forced into the welded sheet above and/or below the spot weld to such a distance that properties and extent of the softened cast alloy of the weld nugget, rather than of the tempered parent metal, determine the depth of penetration. Any other type of penetrator or hardness test has little significance. It has been found that the tempered parent metal is reasonably homogeneous except in a narrow zone adjacent to the weld nugget where incipient melting and intrusion of eutectic occur along grain boundaries, while on the other hand the entire volume of the weld nugget has been very appreciably softened. Hence penetrator tests measure weld-nugget geometry. By profiling the weld region with suitable penetrators, the shape of the weld nugget can be mapped quite accurately.

Although properly applied penetrator tests can measure weld-nugget geometry reliably, it must be noted that measurements from the outer surface of the welded sheet measure only the geometry of the outer boundary of the nugget in the sheet under test. The nature of the bond at the faying surface, particularly where excessive alclad inclusions exist, is not



measured in this test. The geometry of the nugget in the opposite sheet is not determined by penetrator tests on only one side of the weld.

Inherent errors in penetrator tests result from (1) inhomogeneities in the composition and heat treatment of the parent sheet, (2) variations in the thickness of the cladding layer of pure aluminum, (3) insensitiveness with weld nuggets of low penetration because of the thick layer of parent metal through which the penetration test must measure nugget geometry.

Advantages of properly conducted penetrator tests are: (1) The method is feasible for either one- or two-side testing; (2) The test actually measures nugget geometry (nugget diameter is the single weld parameter which correlates reliably with the static shear strength of spot welds); (3) Indications are nearly instantaneous.

Disadvantages of penetrator tests are: (1) The test becomes insensitive with thin nuggets; (2) Conditions at the faying plane are not measured.

1. One-side, one-point penetrator test.-- In this test, a single penetrator is forced into the sheet surface above the center of a spot weld, in a manner similar to ordinary hardness testing, but applied in this case to a nonhomogeneous structure. The change in penetration between the application of a pre-load (sufficient to force the penetrator through local surface regions) and application of full load (sufficient to force the penetrator into a region where the weld nugget affects penetration) is measured by a sensitive dial gage. The one-point measurement tends to measure nugget penetration at the center of the weld. (See fig. 32.) Nugget penetration is indirectly correlated with nugget volume and diameter, for welds made with similar electrodes under similar welding conditions. Hence the one-point-penetrator test predicts weld strength only through a chain of correlations with weld-nugget diameter.

Precautions to be observed in applying the one-point penetrator test are: (1) The penetrator must be very carefully located over the center of the weld nugget; (2) The shape and size of the penetrator must be fixed and constant; (3) The conditions of loading must be controlled accurately; (4) Tests must be made on welds all of which have been made with identical welder tip size and contour, and on the side of the sheet which was in contact with a particular electrode tip.



Inherent errors of this method include: (1) errors due to the lack of a reliable correlation between nugget diameter and nugget thickness, (2) errors due to unsymmetrically shaped nuggets or nuggets the centers of which are displaced from the faying plane, (3) errors due to inaccurate positioning.

Advantages of this method have been listed under penetrator tests. Standard hardness-testing machines may be used if desired. This test requires access to only one side of the work.

Disadvantages of this test are: (1) its relative unreliability, due to its indirect correlation with weld-nugget diameter, and (2) its inherent errors.

Typical results of one-side, one-point penetrator tests made on industrially made spot welds with a Rockwell Standard Hardness Testing machine as penetrator are shown in figure 33.

2. Simultaneous two-side, one-point penetrator tests. - This test method differs from the one-side, one-point test only in that simultaneous penetration tests from both sheet surfaces are made on the weld. This test has the slight advantage of checking symmetry with respect to the faying plane, and of detecting welds with nearly all the weld nugget on one side only of the faying plane. However, it requires access to both sides of the work.

3. Penetrator profile tests. - The penetrator profile test is the most reliable method of determining weld-nugget diameter, shape, and penetration. In this test a suitably loaded penetrator carries out a succession of measurements over the sheet surface and/or below the spot weld. The shape of the nugget along any section can be determined by penetrator profile measurements along a line over that section. (See fig. 34 for characteristic penetrator profiles of spot welds in 0.064-inch 24S-T alclad sheet.) Increased sensitivity to weld-nugget geometry is obtained with penetrator profile tests as sheet thickness is decreased. From penetrator-profile measurements, nugget size, shape, and thickness can be determined. Instead of a succession of point penetration measurements, a continuous profile by a rolling sphere or wheel following a linear or spiral path may be used. Simultaneous two-side penetration profile testing is feasible under some conditions.

Precautions: (1) The single-point penetrations must be

spaced sufficiently far apart to be independent of effects of preceding penetrations. (2) Rolling profile units must be very rigidly mounted to avoid deflection due to the large forces required to move them over the work. (3) Resultant grooves must not cause a "notch effect" to weaken the welded joint. (4) Sensitive measurements with respect to the sheet surface, accurate to nearly 1/10000 inch, are required.

Advantages of penetrator profile measurements lie in their complete mapping of weld-nugget geometry.

Disadvantages of penetrator profile measurements lie in (1) the complexity and accuracy required in suitable testing apparatus, (2) the time required for testing, (3) possible weakening of the joint by grooves.

4. Multipoint or ring-penetrator tests. - These tests are designed to obtain the significant information of the profile tests, with simpler equipment. A direct measurement of nugget diameter is made by a suitable ring impressor or circle of point penetrators capable of determining whether or not the nugget lies under the circle of penetrators. (See figs. 38 to 46.) If the nugget is smaller than the penetrator circle, or has excessively low penetration (20 percent), the penetrators indicate only parent metal to be present. If the nugget diameter approaches and passes that of the ring, penetrator indications detect this change sensitively. All nuggets of diameter much greater than the ring diameter, are recorded as large nuggets. For any sheet thickness, the range of very high test sensitivity can be matched to any chosen weld-nugget diameter by selection of the appropriate penetrator-ring diameter. One-side or simultaneous two-side testing is feasible. The accuracy of measurement of weld-nugget diameter and of weld strength is nearly identical with the accuracy with which weld strength and diameter can be correlated to the diameter observed by destructively sectioning the weld nugget. (See fig. 45.)

Precautions to be observed in applying ring-penetrator tests include: (1) The penetrator assembly must be accurately centered over the weld nugget. (The fact that the nugget does not always lie directly under the indentation "dimple" on the sheet surface introduces the largest error in this measurement.) (2) The size, shape, and arrangement of penetrators must remain constant. (3) Effects of variations in sheet temper must be compensated.

Inherent errors are (1) an error of increasing magnitude

with decreasing nugget penetration, due to decreasing test sensitivity. With less than 20 percent nugget penetration, test indicates no nugget. (However, alclad inclusions are usually excessive, and weld quality is very unreliable with such thin nuggets, which are usually of irregular or "doughnut" shape.) (3) Errors due to unusual variations in the temper of parent metal.

Advantages of the ring-penetrator test include (1) the reliability and accuracy with which nugget diameter is measured, (2) the simplicity of testing and indicating equipment, and (3) the direct, instantaneous indications of nugget size.

Disadvantages of this test include (1) its inherent errors, (2) its failure to measure conditions at the faying plane, such as extent of alclad bonding. Details of the development of equipment and the results of ring-penetrator tests on a large number of industrially made spot welds are given in appendix A of this report.

#### H. X-Ray Tests

In these tests, the welded sheet is exposed to low voltage X-rays or Grentz rays (10 kvp to 50 kvp). Fine-grain radiographic film is placed close to the opposite side of the sheet (fig. 35) or a fluroscopic screen might be used for visual inspection. Small differences in image density may be obtained under ideal exposure conditions. The longer the wave length of the X-rays, the greater the difference in density of various regions of the image (reference 9) and the greater the exposure required.

Resultant radiographs are complex and must be interpreted carefully. It is probable that under optimum conditions, radiographs will show (a) weld cracking and porosity, (b) nugget diameter, (c) area of alclad bonding, (d) spitting, flashing, and expulsion of metal at the faying plane. It is improbable that radiographs will show the extent of alclad inclusion into the nugget or the nature or extent of the corona bonding at the faying plane.

Tests of equipment built by the General Electric X-Ray Corporation and tried at the Glenn L. Martin Company in Baltimore, Md., as well as research at the Taylor Winfield Company (reference 4) of Warren, Ohio, and the Aluminum Company of America (reference 6) at New Kensington, Penna., indicate that the radiographic inspection of spot welds on

fine-grain film is probably feasible. Most radiographers do not believe fluoroscopic inspection of spot welds to be feasible because fluoroscopic screens in use today have a grain size some 10,000 times larger than fine-grain X-ray film, and because image intensity differences are small. Ionization gage inspection is likewise considered very difficult because of the complexity of spot-weld images.

1. Weld-outline test (reference 14).— In this test, a fluid containing radiographically opaque materials is caused to penetrate between the welded sheets at the faying plane. The penetrating qualities of the fluid cause it to cover the faying plane up to the very boundaries of the bonded zone at each weld. If the joint is now exposed to X-rays, while the image is recorded on X-ray film or viewed on a fluoroscopic screen, the welds appear as regions relatively transparent to X-rays surrounded by much more opaque areas. The outline of the actual total bonded area of each weld is thus detected readily.

Precautions to be observed in applying this test are:

(1) The fluid carrying the radiographically opaque materials must not damage or corrode the aluminum sheet, nor should the joint be spread in order to introduce the fluid; (2) Reasonably constant radiographic density should be obtained outside the weld region; (3) The fluid must penetrate to the boundary of the bonded area of the weld, and into any interstices between bonded areas.

Inherent errors may result if the fluid fails to penetrate to the boundary of the bonded area at all points. The contribution of the corona bonding to weld strength is not necessarily measured.

Advantages of the method are: (1) The total area of bonding can be measured reliably; (2) Exposure conditions need not be precisely controlled; (3) Special fine-grain films are not necessary; (4) X-rays from standard industrial equipment (30 kvp to 150 kvp) may be applied.

Disadvantages of the method are: (1) The inherent error listed; (2) The additional operations of flowing in the fluid before exposure and of cleaning the sheet after exposure; (3) The added cost of film and delay of developing film, requiring identification of welds; (4) A possible hazard to inspectors if fluoroscopic visual inspection is employed, without adequate precautions; (5) Relatively elaborate equipment and skilled operators are required. No experimental tests of this method were made in this research.

2. Radiographic tests (references 4, 6, 8, 9, and 10)<sup>6</sup>.-

In these tests, the welds are subjected to carefully controlled low voltage X-rays and the weld image is recorded on fine-grain photographic film placed behind the welded joint. The X-ray voltage should be stabilized to  $\pm 1/4$  kv., and should be as low as feasible, for adequate radiographic contrast. (Twelve kv X-rays produce appreciably greater contrast than forty kv X-rays, reference 9.) The effective focal area of the tube should be small in comparison with the target film distance. An effective focal area 1 millimeter square with a 36-inch target to film distance has given acceptable definition with standard industrial X-ray equipment. (See reference 6.) The film should have fine grain. (Eastman Type M and Agfa Superay B have been used successfully), be wrapped only in photographic paper with 1/16-inch lead backing behind the film, and be placed close to the weld. Two or three layers of X-ray film can be used without appreciable loss in definition.

Exposure conditions must be precisely controlled to obtain optimum contrast and definition.

Precautions to be observed include: (1) The film must be wrapped only in thin paper opaque to light but transparent to X-rays of low voltage; (2) Exposure conditions and film processing should be precisely controlled; (3) Personnel should be protected from X-rays.

Inherent errors include: (1) Errors resulting from inability of method to discriminate extent of included inclusion into the weld nugget. Such inclusion occurs frequently with thin, small weld nuggets, and lowers weld strength appreciably; (2) Errors resulting from lack of definition in radiographic images of spot welds with thin weld nuggets; (3) Errors in interpretation of spot-weld radiographic images.

Advantages of the test include: (1) Cracking, porosity, nugget diameter, and total bonded area are indicated, under optimum exposure conditions; (2) The weld is not damaged by the test; (3) The weld need not be located precisely; (4) Permanent records are obtained.

Disadvantages include: (1) The test requires access to both sides of the weld; (2) Long exposures (4 to 30 min) are required with standard radiographic equipment; (3) Film must be used, involving added cost; (4) Delay of developing takes time, requires identification of welds; (5) Relatively



elaborate equipment and skilled operators are required; (6) Careful interpretation of radiographs is required.

3. Fluoroscopic-inspection methods<sup>2</sup>.-- In these tests, the welds are subjected to carefully controlled X-rays and the resultant images are viewed by means of a fine-grain fluoroscopic screen placed close to the welded sheet. Under optimum conditions, images similar to those obtained with fine grain film might be expected.

However, available fluoroscopic screens are far too coarse-grained to obtain definition adequate for spot-weld inspection. Also the contrast between regions of the spot weld is too low for easy fluoroscopic inspection. The method has yet to be proved feasible.

Precautions are: (1) The inspector must be protected from excessive X-ray exposure; (2) To obtain reliable results careful "dark adaptation" of the eyes (30 min. in a completely darkened room) is required before inspection begins; (3) Lack of sensitivity or failure to indicate faults should not be taken as proof of weld quality.

Advantages of the method include: (1) No film is required; so inspection cost is low; (2) Results of inspection are available immediately; so no marking or identification of welds is needed; (3) Welds need not be located accurately for testing.

Disadvantages include: (1) A completely darkened room is needed for viewing the fluoroscopic screen; (2) Inspectors have time delays because of fatigue and time needed for dark adaptation; (3) Access is required to both sides of the weld; (4) Special equipment is required for the protection of personnel and support of specimen.

No fluoroscopic testing has been included in this research.

4. Ionization gage method<sup>\*</sup>.-- In this test, X-rays pass from the source through the welded sheets into a suitable ionization gage, which measures the quantity of X-rays passing through the sheets at the weld. (See fig. 36.) The gage may make either an over-all measurement, or profile the

---

\*This method is now under investigation by other research investigators.



weld region to obtain fine detail of the X-ray image of the weld. To avoid lengthy exposures exceedingly sensitive ionization gages are required, particularly for profiling the weld.

Inherent errors include: (1) Errors due to failure to observe fine detail of weld in the over-all test; (2) Possible effects of cracks and porosity; (3) Errors due to misalignment of the actual weld nugget and the ionization gage; (4) Errors due to excessive sheet indentation and other geometric factors.

Advantages include: (1) Response is immediate, making marking or identification of welds unnecessary; (2) Indications are independent of operator and could be automatic in operation.

Disadvantages include: (1) Access is required to both sides of the weld; (2) Careful locating of the weld is required; (3) Cracking or excessive sheet indentation may introduce erroneous indication.

No development of ionization gage-testing equipment has been included in this research.

### I. Mechanical-Proof Tests

In mechanical-proof tests, the spot weld is loaded to a predetermined fraction of acceptable strength in shear or tension by a suitable mechanical testing tool. With welds in extended sheets, it is very difficult to load individual spots in shear without excessive sheet distortion. As a result, most mechanical proof tests are designed to load the spot weld in tension. However, it must be recognized that tension strength is not necessarily proportional to the shear strength of the weld. Hence these tests are indicative of, but do not measure shear strength. They do discriminate between "stuck" welds and welds of acceptable strength.

The greatest disadvantage of mechanical-proof tests is the possibility that the proof load might damage the weld. This need not necessarily occur - in fact, it is probable that spot welds which were damaged by proof loading to a fraction of minimum acceptable strength would not be suitable for use in aircraft. Experience with static shear pull tests on thousands of spot welds fails to show any damage resulting from partial loading, in welds of acceptable strength and quality.

The advantage of proof tests lies in their complete reliability, when the load can be properly applied to an individual spot.

1. Pry-test methods.-- Following the method of the inspector who pries the sheets apart near the spot welds to detect weak welds, calibrated prying tools designed to exert known loads have been developed. Regardless of the force exerted by the operator, clutch or spring devices prevent the force applied to the weld from exceeding a certain maximum. Hence known proof loads may be applied without damage to good welds. The method has a direct appeal to the inspector because it follows proved inspection procedure with additional accuracy.

A precaution to be observed in applying pry tools is that the tool must be properly applied, and applied only to joints and sheet thicknesses for which it has been designed and adjusted, to avoid damage to the welds or structure.

Inherent errors include: (1) Errors resulting from the presence of other welds very close to the weld under test, if the load is distributed to these other welds; (2) Errors due to variable sheet stiffness.

Advantages of pry-testing tools are: (1) Measurements are simple and direct; (2) The load is applied to weld at faying plane, rather than through sheet.

Disadvantages of pry-testing tools are: (1) The sheets are separated and may be distorted by the test; (2) Welds are difficult to reach through large overlap; (3) Sheet surface is scratched at faying surface; (4) Damage to the weld may result from careless use.

No very practical forms of pry-testing tools have been developed in this research, although preliminary designs for such tools have been proposed.

2. Adhesive-bond tests.-- In this test, suitable small plates are bonded to the outer sheet surface above the weld, and/or to the opposite sheet surface, using recently developed metal-to-metal adhesives applied under heat and pressure. A typical adhesive (furnished by B-B Chemical Company, Cambridge, Mass.) applied in these tests consistently developed more than 2500 psi shear strength and 2000 psi tensile strength in bonds between alclad sheets. It is applied with a brush and allowed to dry in air for an hour. Then heat

and pressure are applied 5 to 10 minutes to cure the bond. (See fig. 37A.) Suitable loading tools then lift the bonded plates from the sheet, loading the individual spot in tension. (See fig. 37B.) Weak welds fail under the chosen proof load. Acceptable welds are not damaged and the sheet is not distorted by this test.

Precautions to be observed in applying these tests include: (1) The sheet surface must be properly cleaned and the adhesive bond must be made carefully; (2) The load must be applied normal to the sheet surface so as to avoid progressive failure of the adhesive bond; (3) The applied load should not exceed the chosen proof load.

Limitations in the application of the method are: (1) It is not applicable to welds between two rigid sections, as the load would be distributed to several welds; (2) It may be applied to thin sheets welded to stiffeners, by loading from only one side, or to sheet-to-sheet welds with loading from above and below the weld.

Advantages of the method are: (1) The sheet is not distorted, and good welds are not damaged by the test; (2) Direct, reliable measurements are obtained.

Disadvantages of the method are: (1) Tests on individual welds involve excessive time delay, although large numbers of welds may be tested relatively quickly; (2) Heating and pressure equipment must be used to make the bond, and heat is needed to weaken the adhesive bond after testing, to remove the test plate.

Figure 37C shows a suitable loading tool.

3. Proof testing at welder.— It has been proposed that proof-testing be carried out at the welder directly after each weld is made, so that defective welds can be detected immediately and replaced. Such testing might be made an integral part of the welding operation, automatically applied as the head of the welder rises so as to entail negligible loss of time. Special clamp tools, possibly operated by the welder air supply, would be necessary to hold the sheet and load the weld. On long continuous joints, these clamps might also serve to move and position the sheet for welding. The device would load the weld only to a fixed proof load, and release the sheet when this load was attained, to avoid excessive sheet distortion. Hold-down devices might be needed

to avoid loading adjacent welds. Care would be exercised to avoid excessive sheet separation because of the clamps inserted at the faying plane. Cold rolling subsequent to welding might be necessary to reduce sheet separation to a minimum.

Precautions include: (1) Care to avoid damage to the weld through excessive proof loading.

Advantages are: (1) Proof testing can be carried out on all welds; (2) Defective welds can be detected and rewelded with negligible lost time; (3) The test would be reliable and conclusive.

Disadvantages are: (1) Proof loads might damage the welds; (2) Sheet separation and distortion might result; (3) The time required for welding might be increased; (4) The flexibility of the welder might be reduced; (5) New fixtures might be required for special shapes of structure to be welded.

No development of this type of equipment has been included in this research.

#### J. Further Development and Application of the Most Effective Test Methods

Investigations of the test methods just described revealed that three test methods - the two-side direct-current test, the ring-penetrator test, and spot-weld radiography - were effective tests of spot-weld quality. Intensive developments of the two-side direct-current test and the ring-penetrator test resulted in the design and construction of Spot-Weld Testing Machine No. 1, which is described in appendix I. A simultaneous investigation of spot-weld radiography (not included in the sponsored research) revealed that radiography offered especial advantages and reliability as a spot-weld test.

#### CONCLUSIONS

The most promising nondestructive method of testing spot welds is radiography. With this method, it is not necessary to locate the weld nugget accurately in order to measure its diameter, or to detect the presence of cracks, porosity, and spitting.

The most reliable nonradiographic test is the ring-penetrator or profile-penetrator test, which can measure weld-nugget diameter reliably under normal conditions of production welding. It does not measure the nature or extent of cracking, porosity, and spitting, except insofar as these defects change the penetration of the loaded test penetrator.

The ring electrode two-side direct-current test measures the bonded area at the faying plane of the spot weld, but does not discriminate between nugget and alclad corona bonding. In conjunction with the ring-penetrator test, it provides a good measure of the strength of production spot welds.

Neither the electrical nor the penetrator test is capable of determining the extent of the alclad inclusion into the weld nugget at the faying plane, or the decrease in weld strength resulting from this cause.

For the measurement of extent of cracking and porosity without the use of X-rays the eddy-current test offers the advantages of a direct and reliable measurement subject to some error due to indentations of the sheet surface.

Welding Research,  
 California Institute of Technology,  
 Pasadena, Calif., November 1943.

#### REFERENCES

1. Anon.: Alcoa Aluminum and Its Alloys. Aluminum Co. of Am., 1942.
2. Keller, F., and Bossert, R. A.: Revealing the Microstructure of 24S Alloy. Metal Progress, vol. 41, no. 1, Jan. 1942.
3. Mikhalapov, G. S., and Falls, T. F.: Structural and Metallurgical Properties of Condenser Discharge Spot Welds. The Welding Journal, vol. 21, no. 4, April 1942.
4. Woods, Robert C., Barrett, John C., and Dietz, T. W.: Radiography of Spot Welds. Metals and Alloys, Sept. 1942, pp. 442-447; and Dec. 1942, pp. 1080-1083.
5. Aircraft Welding Standards Committee: Standards and Recommended Practices and Procedures for Spot Welding of Aluminum Alloys. I - Standards of Weld Quality (5) Weld Penetration. Am. Welding Soc., Feb. 1, 1942, (rev.) April 15, 1942.

6. Smith, D. W., and Keller, F.: Correlation of Metallographic and Radiographic Examinations of Spot Welds in Aluminum Alloys. *Welding Jour.*, Dec. 1942.
7. Heising, J. R., and Burkhart, E. H.: Metallurgical Aspects of Spot Welds in Aluminum Alloys. *Metals and Progress*, Dec. 1942.
8. Hass, W. F., Wyant, R. A., and Averbach, B. L.: Examination of Spot Welds in Alclad 24S-T. *Welding Jour.*, July 1942.
9. Woods, Robert C., and Cetrone, V. C.: Radiography of Light Alloys. *Iron Age*, March 25, 1943.
10. Anon.: Microradiography. *Iron Age*, vol. 152, no. 4, July 22, 1943.
11. Vigness, Irwin, and Dinger, J. E.: Third Partial Report on Eddy-Current Type Flaw Detectors - Tests of Spot Welds in Aluminum Alloys. NRL Rep. no. O-1792, Navy Dept., Naval Res. Lab.
12. Gunn, Ross: An Eddy-Current Method of Flaw Detection in Nonmagnetic Metals. *Jour. Appl. Mechanics*, March 1941.
13. Forster, F., and Koster, W.: Modulus of Elasticity and Damping in Relation to the State of the Material. *Jour. of the Inst. of Elec. Eng.*, London, B. I., vol. 84, Jan.-June, 1939, pp. 558-564.
14. Godalsky, Natalie: New Methods of Spot Weld Inspection by X-Ray. (Paper furnished by Sciaky Bros., 4915 W. 67th St., Chicago, Ill.)
15. Russell, H. W., Jackson, L. R., Grover, H. J., and Beaver, W. W.: Fatigue Characteristics of Spot Welded 24S-T Aluminum Alloy. NACA ARR No. 3F16, 1943.



SOURCES OF PROPOSED TEST METHODS

(a) Two-Side Direct-Current Test.-- A form of test similar to the two-side direct-current test was developed by Andrew and Perillo for the Glenn Martin Aircraft Company of Baltimore, Md. (Refer to Mr. Paul Merriman for details.)

(b) One-Side Direct-Current Test.-- A preliminary form of this test was developed in the Electrical Research Section of the Lockheed Aircraft Corporation, Burbank, Calif. (Refer to Mr. Fred Bowden for details.)

(c) Lap-Joint Induction Test.-- A test which may be similar to the lap-joint induction test was developed by Mr. Norman Bonn, of Philadelphia, Pa.

(d) Pick-Up Coil Eddy-Current Test.-- Developed in the Naval Research Laboratory and reported by Ross Gunn in "An Eddy-Current Method of Flaw Detection in Non-Magnetic Materials" in the Journal of Applied Mechanics, March 1941.

(e) Spot-Weld Eddy Testing Unit.-- Developed in the Naval Research Laboratory and reported in a progress report, July 1942.

(f) Lockheed Eddy-Current Test Unit.-- Developed in the Electrical Research Section of the Lockheed Aircraft Corporation by Dr. Philip Carlson.

(g) Heat-Reservoir Thermal Test.-- Developed by the General Electric Company, Schenectady, New York, and tested in the Lockheed Aircraft Corporation Research Laboratory, Burbank, Calif.

(h) Vibration Damping Test.-- Method is discussed in Modulus of Elasticity and Damping in Relation to the State of the Material, by F. Forster and W. Koster, in Journal of the Institution of Electrical Engineers, London, B.I.E., Vol. 84, Jan.-June 1939, pp. 558-564.

(i) Wave-Reflection Test.-- Proposed by Professor F. A. Firestone of the University of Michigan, in connection with the Supersonic Reflectoscope.

(j) Weld-Outline Test.-- Mlle. Natalie Godalsky in a paper furnished by Sciaky Brothers, Chicago, Ill.

NOTE: Proposed test methods identified by the sign  $\phi$  were independently proposed and developed by the Welding Research Group of the California Institute of Technology.

APPENDIX A

DESIGN AND CONSTRUCTION OF SPOT-WELD TESTING MACHINE No. 1

A. Description of Machine

Spot-Weld Testing Machine No. 1 is a laboratory device designed to test the principles of the penetrator and electrical nondestructive tests. It has not been designed to take extensive structures, but will handle standard shear test panels with spot-welded lap joints. Compact construction was used to avoid excessive deflections of the frame of the machine under loading. The machine combines two test operations in one sequence: namely, two-side ring-penetrator tests of the nugget diameter, and two-side electrical tests of the total area of bonding. Figure 38 shows the entire machine.

For the ring-penetrator test, a hydraulic jack (A) applies loads measured by weighing block (B) and indicated on dial gage (C) to the moving pressure cylinder (D) which slides in an accurately machined cylindrical guide (E) supported by the frame of the machine (F). The ball penetrators (G) are carried on removable anvil inserts (H) held by a set screw in a socket in the anvil (I), and are carefully aligned on the axis of the moving cylinder. Similar penetrators (J) are carried on the anvil insert (K) in the upper anvil (L). This anvil is set into the top plate (M) which is securely fastened to, but electrically insulated from, the frame (F). These upper penetrators are carefully aligned with the lower penetrator balls on the moving cylinder. Probes (N) slide freely in the anvils, and have replaceable contact tips (O) which pass through small holes in the anvil inserts (K). The heads of these probes are in contact with sensitive dial gages (P) and (Q) fastened firmly by posts to the top plate (M) and the piston cap (R), respectively. These gages measure the penetration of the penetrator balls under loading. In operation, the spot-welded panel is inserted between the head and the moving cylinder and the spot weld is carefully centered under the penetrator assembly. Loads are applied as desired.

For the two-side electrical test, either the anvil inserts carrying the ball penetrators, or similar inserts with circular ring penetrators (S) may be used as electrodes. Electric current from an external direct-current generator is introduced into the top plate (M) (which is insulated from

the frame) at contact (T). This current flows from the upper penetrator or electrode (J) through the weld to the lower electrode (G), and leaves the machine through the terminal (U) on the moving cylinder. The current then returns to the generator through an external ammeter and control resistance. The potential drop across the probes (N) is measured by a low-resistance microammeter. These probes are carefully insulated from the anvil inserts. Microswitch (V) on the weighing block (B) is interlocked with the current switch to prevent the switching on of current with inadequate electrode pressure.

The ring-penetrator assemblies used on Testing Machine No. 1 are shown in figure 39. For laboratory tests, 1/16-inch-diameter-hardened steel balls (commercially available for Rockwell Hardness Testing Machines) were used as penetrators. Calibrated sharpened steel points (commercially available for use in the Barcol Impressor) can be used to obtain equivalent penetrator tests with much lighter applied loads. The penetrators are mounted on circles of diameter chosen to correspond to acceptable spot-weld-nugget diameters in various gages of aluminum-alloy sheet, and are supported on hard steel anvil inserts. These inserts may be quickly exchanged when it is desired to test spot welds in different gages of alloy sheet.

The ring electrode assemblies used on Testing Machine No. 1 are shown in figure 40. The electrodes are circular contact areas of diameter slightly larger than the total bonded areas of acceptable spot welds in each sheet thickness. These electrode units are of the same dimensions as the penetrator anvil inserts, and may be used interchangeably in Testing Machine No. 1.

#### B. Principle of Operation of Machine

The ring-penetrator tests of Spot-Weld Testing Machine No. 1 are based upon results of the penetrator-profile tests shown in figure 34. From these tests it was found that the typical penetration profile had the characteristic shape shown in figure 41. The ring-penetrator units of Spot-Weld Testing Machine No. 1 are designed with the diameter so that the penetrators fall on the points A-A of the penetrator profile curve for normal good welds in each gage of aluminum-alloy sheet. If the weld nuggets are smaller than the normal acceptable weld nugget, the penetrators fall outside the weld nugget over the tempered parent metal, at points on the penetrator profile curve identified by B-B. If, however, the

nugget is larger than the normal size, the penetrators fall over the center of the nugget and the indications correspond to the points C-C of the penetrator profile. Sections through typical weld nuggets of various sizes in 0.040-inch 24S-T alclad sheet are shown in figure 42 with the indentation of the ring-penetrator test visible on the macrographs. The penetrator test indication is shown for each of the welds. It may be seen that the penetration of the ring penetrator measures weld diameter sensitively and reliably, and that small weld nuggets are differentiated from large weld nuggets by significant changes in indication.

The ring-electrode two-side direct-current tests of Spot-Weld Testing Machine No. 1 are based upon preliminary tests of the two-side direct-current method of determining the total bonded area at the faying plane. (See figs. 9, 10, and 11.) Macrographs of the faying plane of typical spot welds of various sizes in 0.040-inch 24S-T alclad sheet are shown in figure 43, with the indication of the two-side electrical test shown for each weld. It may be seen that the electrical test indications correlate with the total bonded area of the spot weld.

### C. Procedure in Operation of Machine

To conduct nondestructive tests of spot welds the machine is first calibrated for penetrator tests by using a block of homogeneous material of known hardness (Rockwell Hardness Testing Machine calibration blocks) and applying a fixed load by means of a hydraulic jack. The penetration is measured on top and bottom dial gages and compared with previous results on the same test block. Any change of shape in the penetrators can be observed and the penetrator balls (1/16-in.-diam. steel balls, identical with those used in Rockwell Hardness Testing machines) may be replaced, if necessary.

Before conducting electrical tests, the electrical system is checked by applying a fixed current to a similar calibration block of known thickness and resistivity and comparing the potential indication with that obtained previously. Corrections are made if indications are abnormal. The checks should be made before beginning a new set of tests and after every two hundred welds tested.

After calibration of the machine, spot-welded panel is inserted in the gap between the electrodes and the first spot weld is carefully centered under the potential probe of the head of the tester. A pre-load of fixed amount (200 lb with

4-ball impressors) is applied by means of the hydraulic jack, the load being indicated by the dial gage on the weighing block. The indication of each penetrator dial gage is recorded. The load is then increased to the full load setting (1000 lb on the 4-ball assembly), and the indication of each dial gage is again recorded. If electrical tests are being conducted with the same set of electrodes the direct current is applied and the potential indication recorded. The current is then interrupted and the load released so that the welded panel may be moved and the next weld tested. The sum of the changes in indication of the upper and lower dial gages between pre-load and full load is then taken as the indication of penetration. The ratio of the total testing current to the potential indication is taken as the indication of bonded area at the faying plane. For greater sensitivity, current electrodes of diameter larger than that of the penetrator ring may be used to indicate the total bonded area, in a separate direct-current test following the penetrator test.

Even on the laboratory testing machine a weld may be tested in less than a minute, reading all dials and meters by eye. For production measurements a machine capable of taking any shape of structure which can be spot-welded could be used for the same measurements. The pre-load and full load could be applied automatically by connecting the loading pistons to sources of low and high hydraulic or air pressures, and by recording the deflection of the weighing block and of the penetrator indicators by means of magnetic or electric strain gages. All this might be controlled automatically by simply pressing a button to initiate the sequence of operation and observing resultant indications on a recording instrument or indicator device. The only portion of the test which is inherently slow is the centering of the spot weld under the testing assembly. By far the greatest portion of the time required in the testing operation would be required for this item alone. With such a machine it should be possible to test 10 to 30 spots a minute without difficulty.

#### D. Results of Tests

Testing Machine No. 1 has been used under several conditions in the testing of spot welds in aluminum-alloy sheets. Various penetrator arrangements have been employed and several gages of sheet tested. The first arrangement consisted of three spherical hardened steel balls placed equidistant on the periphery of a circle. (See fig. 39.) Tests showed this device to be capable of discriminating weld strength reliably



on welds of normal shape (figs. 5 and 44) but on welds having elementary nugget formations (fig. 3), erroneous indications resulted because of the irregular shape of the area of bonding. Improved assemblies with four and six balls placed on the circumference of the critical circle showed improved performance. (See fig. 39.) Likewise, the use of circular electrodes of diameter larger than the penetrator circle as electrodes for the electrical test resulted in an improvement in the measurement of the area of bonding. (See fig. 40.)

The diameter of the weld nuggets is measured to  $\pm 12$  to 15 percent by the penetrator test alone as shown in figure 45, summarizing results on several hundred spot welds made in different West Coast aircraft factories under normal industrial conditions of welding. These tests prove the machine to be capable of measuring weld-nugget diameter reliably. It is because of the reliability of this measurement that the machine is capable of measuring the strength of the weld.

The static shear strength of the spot welds is measured to  $\pm 10$  percent by the penetrator test alone in the range for which penetrator is adjusted as shown in figure 46 on the same sets of industrially made spot welds. This measurement compares favorably with the correlation between the strength and spot-weld-nugget diameter shown in figure 41 for the same sets of spot welds. It is seen that the penetration test measures weld strength with an error equal to only twice the median error in the correlation between weld-nugget diameter and strength. This quality of measurement in itself is adequate for the nondestructive testing of spot welds in industry.

The total area of bonding at the faying plane is measured to  $\pm 10$  percent by the electrical test. (See fig. 47.) Because of the variation in the nature of the corona bonding and the difficulty of visually measuring the corona area on the pulled welds this correlation is appreciably less accurate than that between penetrator tests and nugget size. The direct correlation between electrical test indications and spot-weld static shear strength is poor because the test does not discriminate the type of bonding at the faying surface. (See fig. 48.)

The static shear strength of the spot welds is measured to  $\pm 10$  percent by the combined penetrator and electrical test indications. (See fig. 49.)



#### E. Conclusions Based on Results of Tests of Testing Machine No. 1

1. The ring-penetrator test alone can be a reliable measure of weld-nugget diameter. It measures the component of weld shear strength due to the nugget with nearly as much accuracy as does the diameter of the nugget observed by destructive sectioning. It does not measure the component of weld strength supplied by alclad bonding (an unreliable contribution) and so, properly calibrated, gives conservative predictions of weld strength.

2. The electrical test measures the bonded area to a moderate degree of sensitivity. By itself it is not a reliable measurement of weld shear strength, for shear strength is not measured reliably by the total area of bonding. It does detect a weld the faying surface of which has bonded poorly or the bond of which has been broken after welding, with absolute reliability. It makes possible an estimate of the contribution of corona bonding to the weld shear strength, and so is a valuable supplement to the ring penetrator test.

3. The chief limitation on the accuracy of all forms of mechanical and electrical tests sensitive to weld size results from the difficulty of locating the center of the weld by observation of the outer surface of the welded sheet. The weld may not be centered under the welder electrode indentation. Thus the major portion of the testing time is required to locate the tester above the weld, while the test itself may be nearly instantaneous. Automatic profiling to locate the weld accurately requires elaborate apparatus and increased testing time.

4. Other limitations result from the fact that penetrator indications depend upon alloy, heat treatment, and sheet thickness. Calibration must be made on that alloy and heat treatment being inspected, with a penetrator ring of diameter suited to spot welds in the given gage of sheet.

#### F. Proposals for Practical Forms of Spot-Weld Tester

Experience with Spot-Weld Testing Machine No. 1 has indicated principles and practical design forms for nondestructive spot-weld testers.

1. Proposed Hand Tester A is a small portable penetrator tester, similar to devices now on the market for hand hardness testing of homogeneous materials (The Barcol Impressor,

available from Barber Colman Company, Rockford, Ill.) A ring of sharpened calibrated penetrators is spring-loaded by hand pressure to make a one-side ring-penetrator test equivalent to that of Testing Machine No. 1. (See fig. 50.) (By using small-diameter, sharpened probes, a great reduction in load is obtained for penetrations sensitive to weld-nugget presence.) This is a direct measurement of nugget diameter. The device must be calibrated on the alloy and temper of sheet to be tested. A change to ring penetrators of different diameter is required when spot-welded sheet of greatly different thickness is to be tested. Properly located above each weld, the hand tester should be nearly as reliable as the penetrator test of Testing Machine No. 1.

2. Proposed Production Tester B is intended for production line use - possibly directly after the spot-welding operation - with welded parts being brought to the tester. It is equipped with a throat and press or rocker arm of dimensions equivalent to the welders it serves, so that any weld made on the welders can be tested on it. Two-side ring-penetrator and electrical tests are automatically carried out and recorded each time the operator presses the foot switch. Air loading and strain-gage recording make possible tests as rapid as the spot-welding operation itself. Strain-gage load measurements, with pre-load and full load applied by air pressure, and strain-gage penetration measurements, could be recorded automatically on indicator devices.

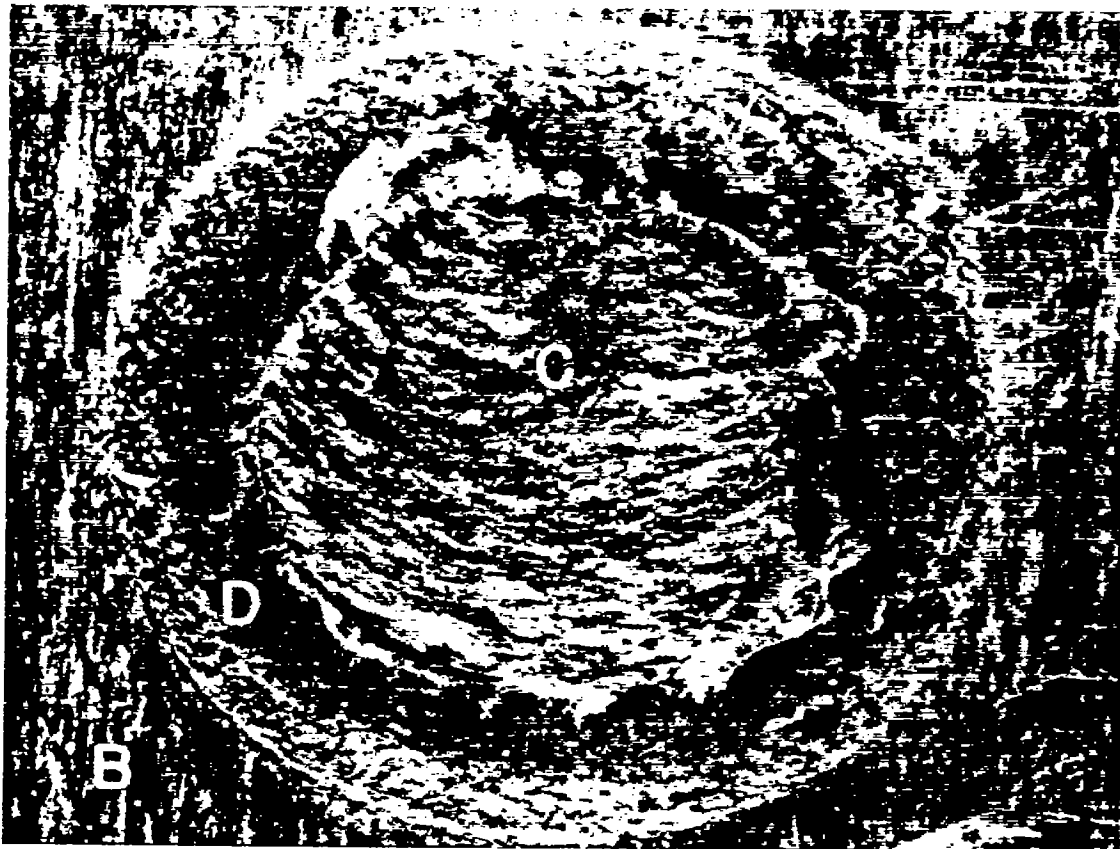
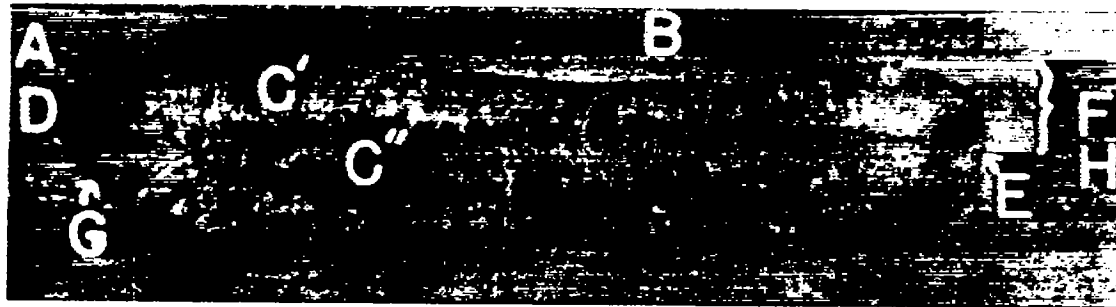
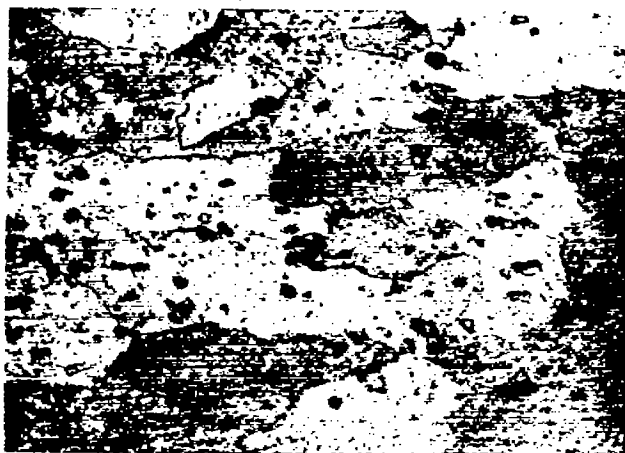
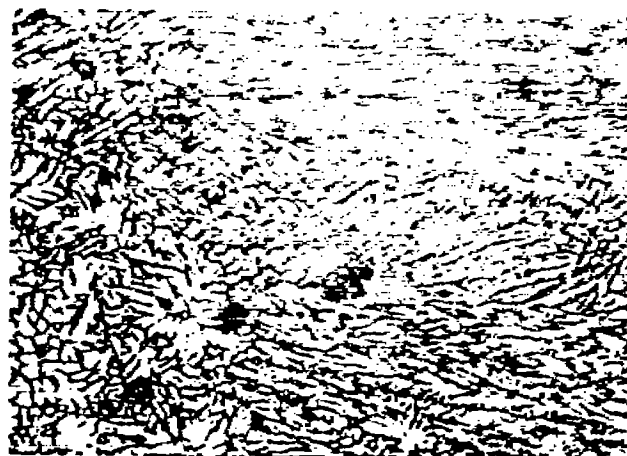

FIG. 1a.

CROSS SECTION AND FAYING PLANE OF A TYPICAL SPOTWELD IN 24 ST ALUMINUM ALLOY, SHOWING SIGNIFICANT REGIONS OF WELD; (A) PARENT MATERIAL, (B) ALCLAD LAYER, (C) CAST ALLOY NUGGET, INCLUDING (C<sup>I</sup>) DENDRITIC ZONE AND (C<sup>II</sup>) EQUIAXED ZONE, (D) CORONA, (E) ALCLAD INCLUSION, (F) PENETRATION, (G) HEAT AFFECTED ZONE AND (H) FAYING PLANE. 20X.



(A). PARENT MATERIAL, 24ST ALUMINUM ALLOY. 500X.



(c<sup>I</sup>). DENDRITIC ZONE OF NUGGET. 500X.



(c<sup>II</sup>). EQUIAXED ZONE OF NUGGET. 500X.

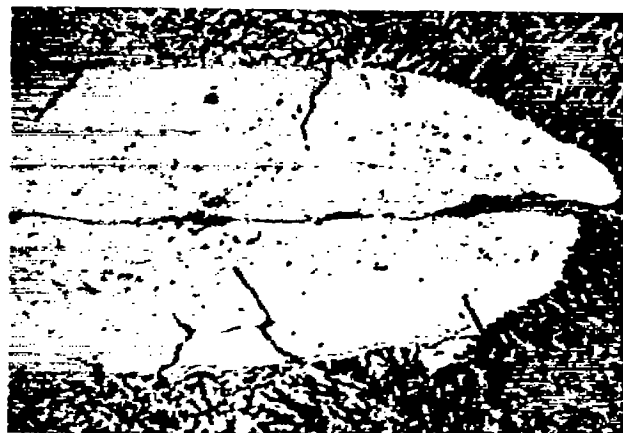

(E). ALCLAD INCLUSION INTO NUGGET. 500X.

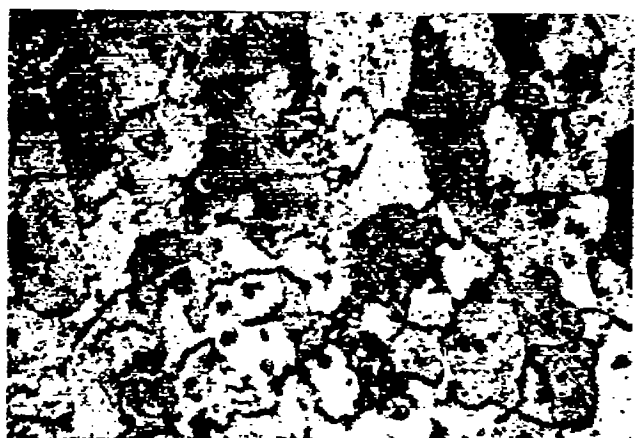

(G). HEAT AFFECTED ZONE SHOWING INCIPIENT MELTING AT THE GRAIN BOUNDARIES. 500X.



(G<sup>I</sup>). HEAT AFFECTED ZONE SHOWING EUTECTIC "STRINGER" OR "INTRUSION INTO THE GRAIN BOUNDARIES". 500X.

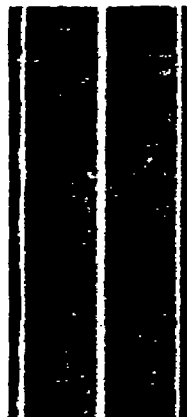
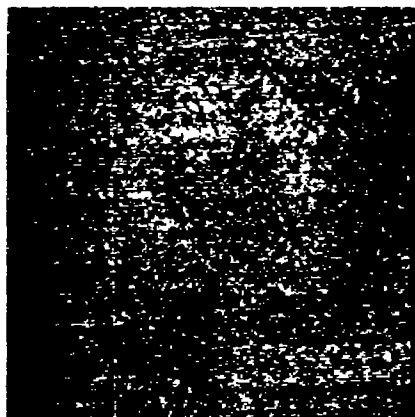

A - 1

STRENGTH BELOW  
50 POUNDS

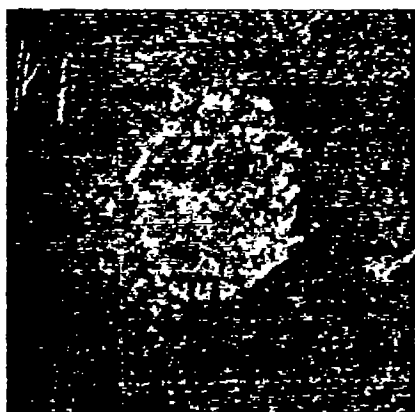

A - 2

STRENGTH 100  
POUNDS

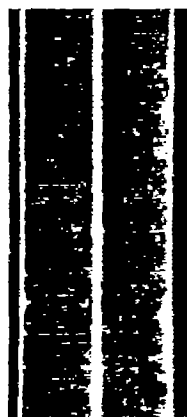

A - 3

STRENGTH 215  
POUNDS

FIG. 2.-

TYPE A WELDS - - ALCLAD  
BONDING WITHOUT NUGGET FORMATION, 10X.



NACA TN No. 945

Fig. 3a

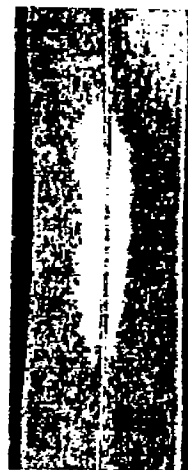
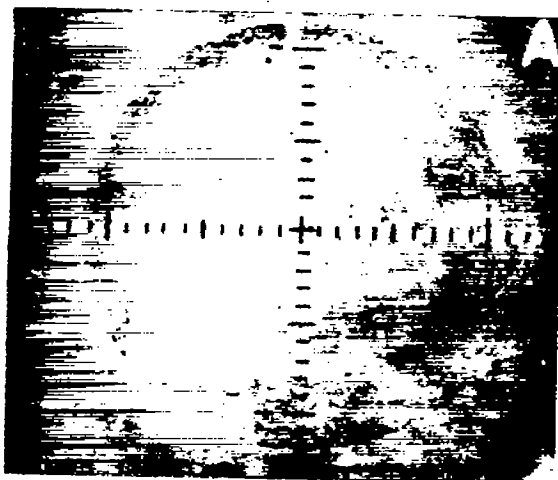

B - 1

STRENGTH BELOW  
50  
POUNDS

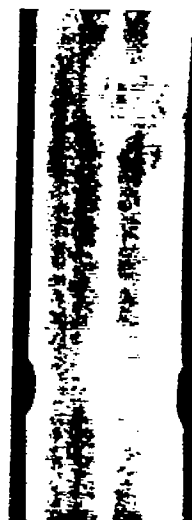

B - 2

STRENGTH 360  
POUNDS



B - 3

STRENGTH 580  
POUNDS

FIG. 3(a,b).-TYPE B WELDS -- ELEMENTARY NUGGET FORMATION.  
WITH OR WITHOUT ALCLAD BONDING, 10X.



NACA TN No. 945

Fig. 3b

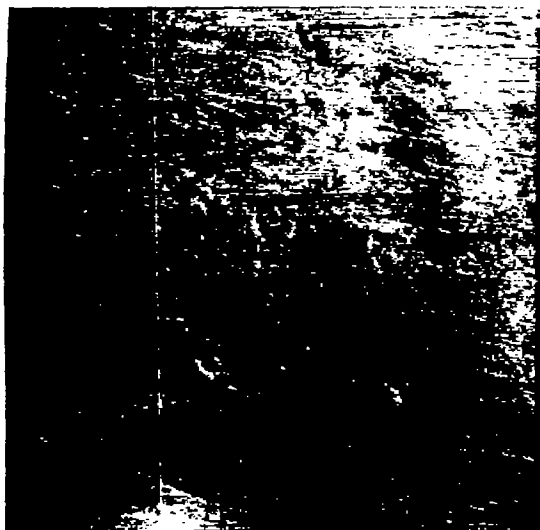

B - 4

STRENGTH 480  
POUNDS



B - 5

STRENGTH 340  
POUNDS

FIG. 3b.

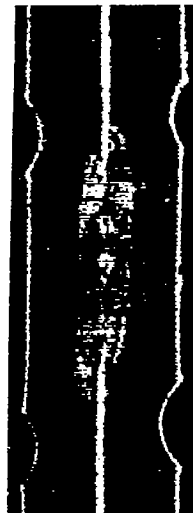
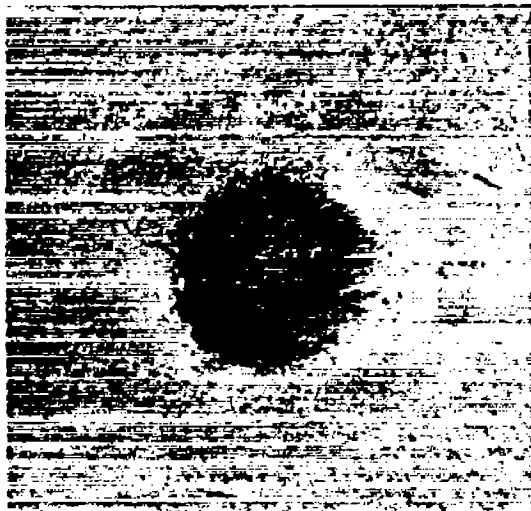

C - 1

STRENGTH 200  
POUNDS

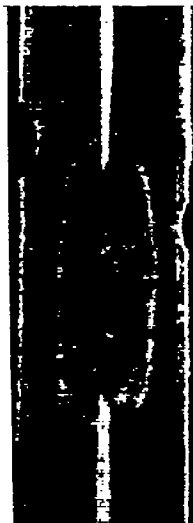
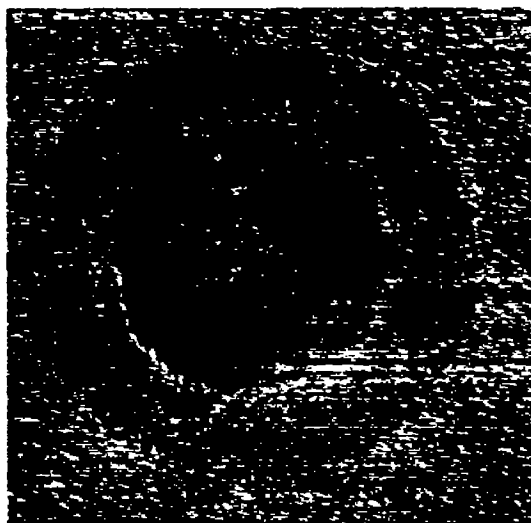

C - 2

STRENGTH 380  
POUNDS

FIG. 4.-

TYPE C WELDS - - SMALL DIAMETER  
NUGGETS WITH NORMAL ALCLAD  
INCLUSIONS AND LOW PENETRATION, 10X.



D - 1

STRENGTH 725  
POUNDS



D - 2

STRENGTH 580  
POUNDS

FIG. 5.-

TYPE D WELDS -- NORMAL DIAMETER  
NUGGETS WITH NORMAL PENETRATION, 10X.



E - 1

STRENGTH 700  
POUNDS

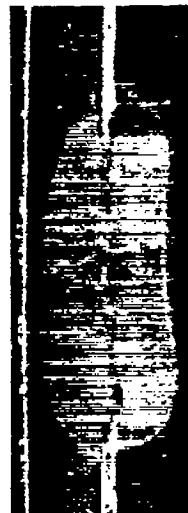

E - 2

STRENGTH 590  
POUNDS

FIG. 6(a to c).-

TYPE E WELDS - - OVERSIZE NUGGETS  
WITH EXCESSIVE PENETRATION, CRACKS,  
POROSITY OR SPITTING, 10X.

NACA TN No. 945

Fig. 6b



E - 3

STRENGTH 680  
POUNDS

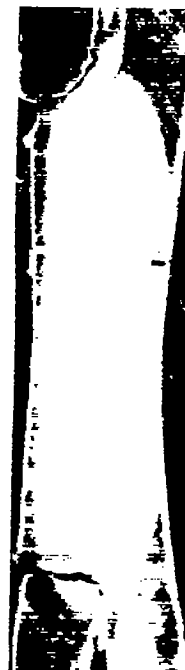
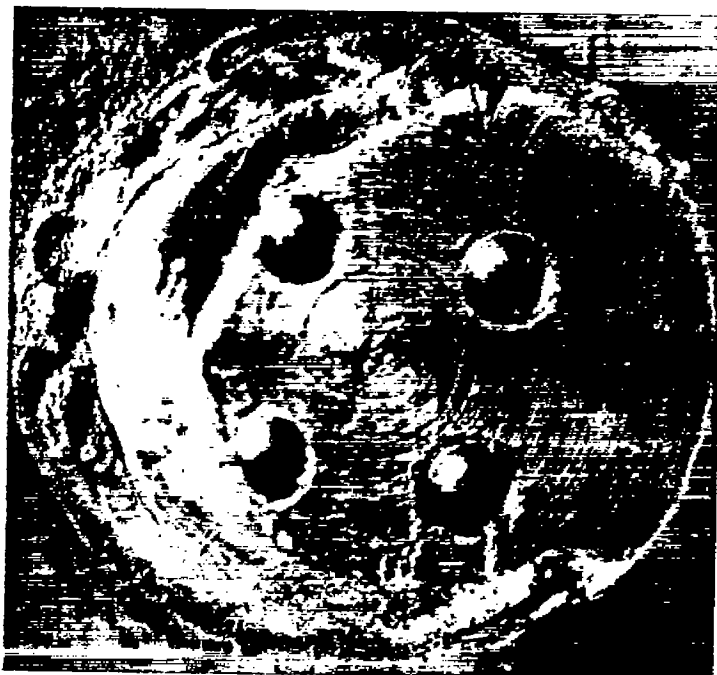

E - 4 STRENGTH 1385 POUNDS

FIG. 6b.

NACA TN No. 945

Fig. 6c

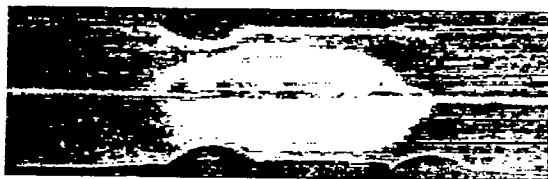
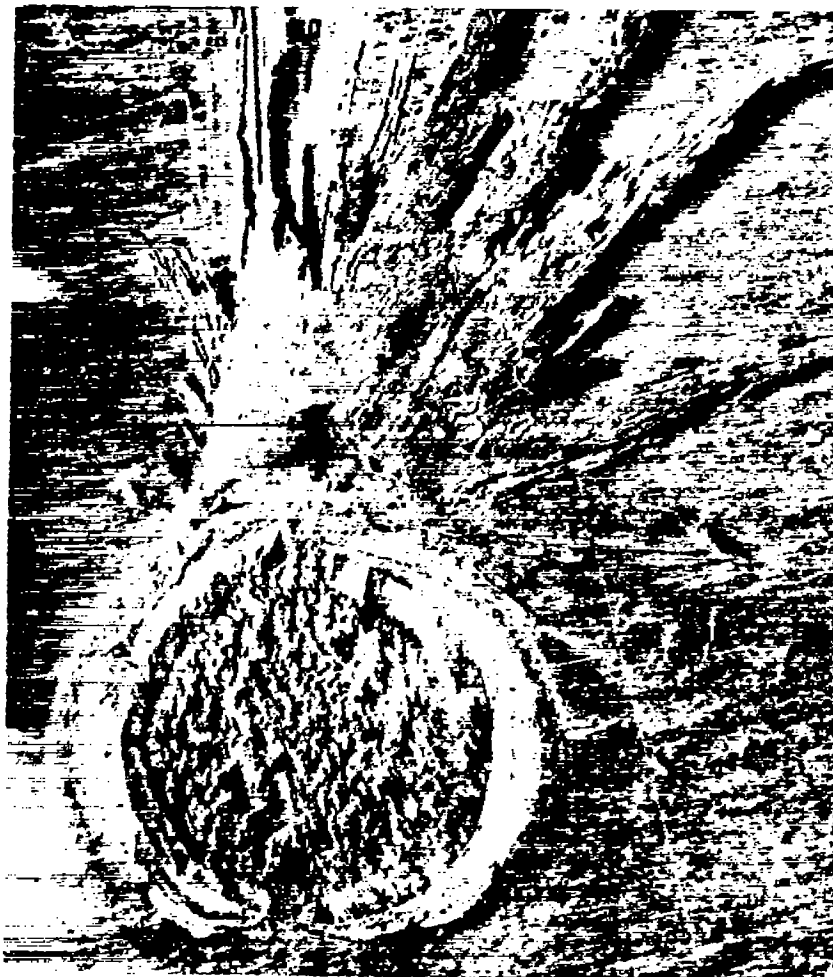

E - 5      STRENGTH 640 POUNDS

FIG. 6c.



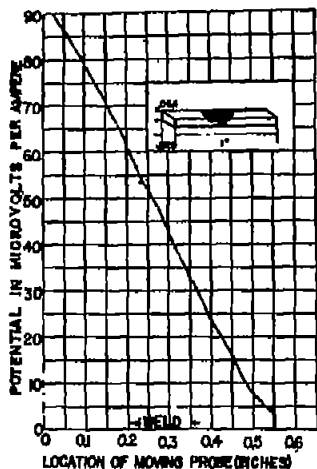

FIG. 7.—POTENTIAL DISTRIBUTION ALONG THE SURFACE OF A PRISM CUT OUT OF AN ALCLAD SHEET CONTAINING A SPOTWELD NUGGET WITH DIRECT CURRENT FLOWING ALONG STRIP.

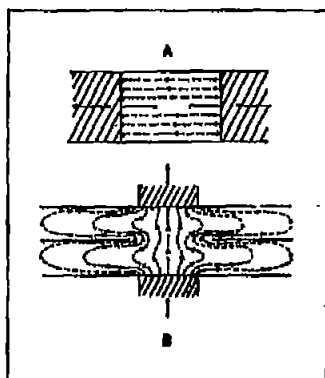

FIG. 8.—MEASUREMENT OF BONDED AREA OF A SPOTWELD BY THE FLOW OF ELECTRIC CURRENT  
 A. CURRENT FLOW PARALLEL TO THE FAYING PLANE DOES NOT MEASURE THE AREA OF BONDING  
 B. CURRENT FLOW NORMAL TO THE FAYING PLANE DOES MEASURE THE AREA OF BONDING

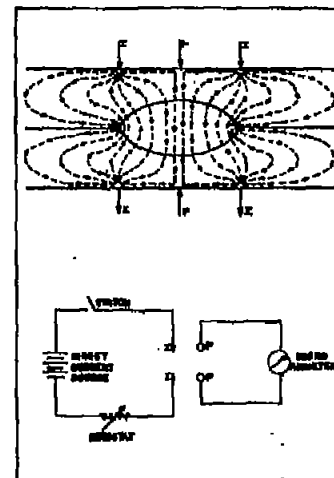

FIG. 9.—THE TWO-SIDE DIRECT CURRENT TEST OF THE BONDED AREA AT THE FAYING PLANE OF THE SPOTWELD. CURRENT FLOWS BETWEEN CYLINDRICAL ELECTRODES IN CONTACT WITH TOP AND BOTTOM SHEET SURFACES AT 1. POTENTIAL IS MEASURED BETWEEN PROBES (P).

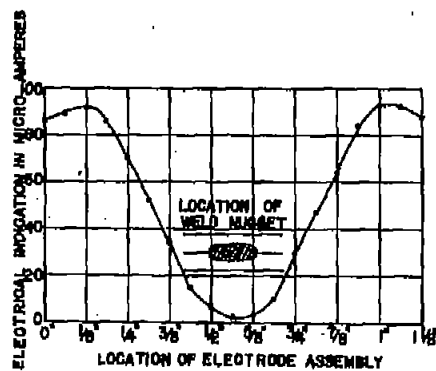

FIG. 10.—RESULTS OF A TWO-SIDE DIRECT CURRENT PROFILE TEST OF A SMALL SPOTWELD IN .064" 24ST ALCLAD

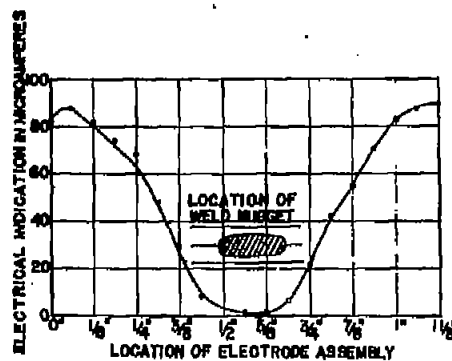

FIG. 11.—RESULTS OF A TWO-SIDE DIRECT CURRENT PROFILE TEST OF A LARGE SPOTWELD IN .064" 24ST ALCLAD

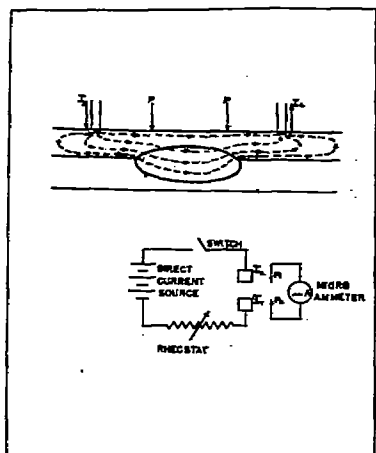

FIG. 12.— THE ONE-SIDE DIRECT CURRENT TEST OF THE BONDED AREA AT THE FAYING PLANE OF THE SPOTWELD. DIRECT CURRENT FLOWS BETWEEN  $I_1$  AND  $I_2$ . SHEET POTENTIAL IS MEASURED BETWEEN  $P_1$  AND  $P_2$ .

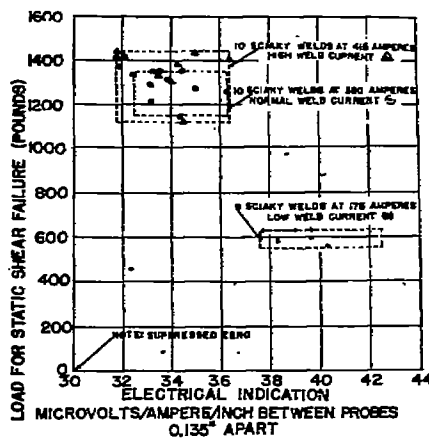

FIG. 13.— RESULTS OF ONE-SIDE DIRECT CURRENT TESTS ON SINGLE SPOTWELD SPECIMENS IN ONE-INCH SHEAR TEST STRIPS. NO DIFFERENCES IN INDICATION ARE OBTAINED BETWEEN LARGE AND SMALL WELDS IN EXTENDED SHEETS BY THIS TEST.

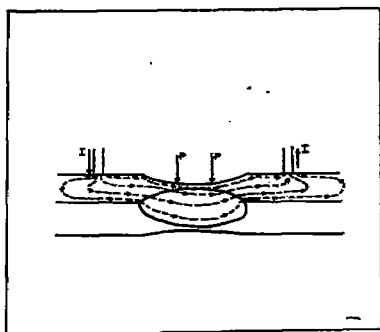

FIG. 14.— EFFECT OF SHEET INDENTATION IN MASKING INDICATIONS OF BONDED AREA AT THE FAYING PLANE BY THE ONE-SIDE DIRECT CURRENT TEST.

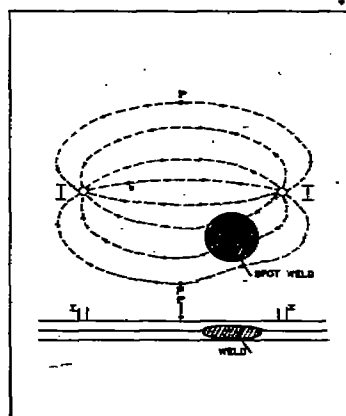

FIG. 15.— WHEATSTONE BRIDGE FORM OF THE ONE-SIDE DIRECT CURRENT TEST OF THE BONDED AREA AT THE FAYING PLANE OF THE SPOTWELD. CURRENT FLOWS BETWEEN CONTACT POINTS (I). POTENTIAL IS MEASURED ACROSS EQUIDISTANT POTENTIAL PROBES (P). THE ELECTRODES FORM A WHEATSTONE BRIDGE CIRCUIT, WHICH IS UNBALANCED BY THE PRESENCE OF A WELD.

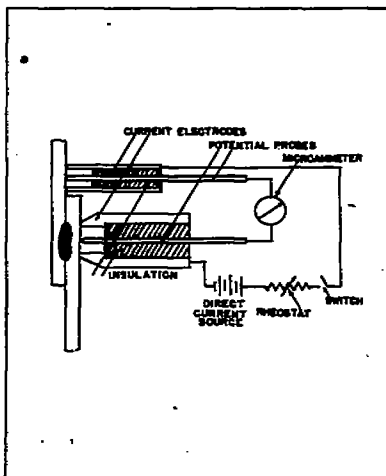

FIG. 16.— THE LAP JOINT DIRECT CURRENT TEST OF THE BONDED AREA AT THE FAYING PLANE OF THE SPOTWELD.

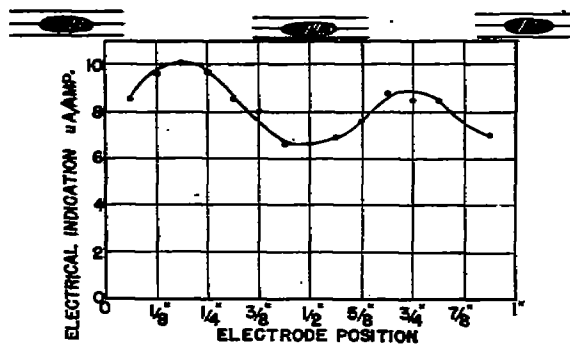

FIG. 17.— SENSITIVITY OF THE LAP JOINT DIRECT CURRENT TEST TO THE PRESENCE OF SPOTWELDS, AS SHOWN BY PROFILE TESTS.

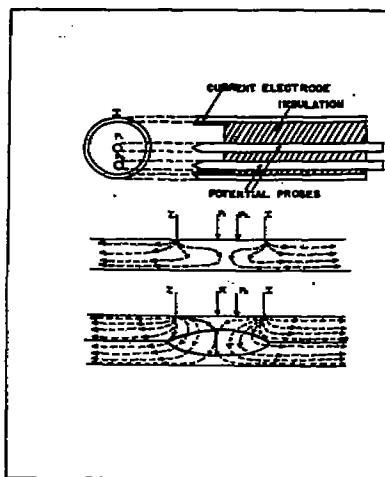

FIG. 18.— ONE ELECTRODE DIRECT CURRENT TEST OF THE BONDED AREA AT THE FAYING PLANE OF THE SPOTWELD.

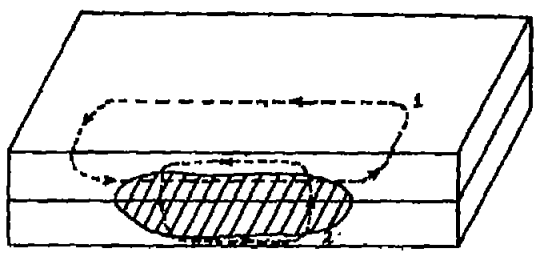

FIG. 19.—EFFECT OF PLANE OF FLOW OF EDDY CURRENT UPON MEASUREMENT OF BONDED AREA AT THE FAYING PLANE OF THE SPOTWELD.  
 A. EDDY CURRENTS FLOWING IN PATH 1 PARALLEL TO THE FAYING SURFACE DO NOT MEASURE AREA OF BONDING.  
 B. EDDY CURRENTS FLOWING IN PATH 2 NORMAL TO THE FAYING SURFACE DO MEASURE AREA OF BONDING.

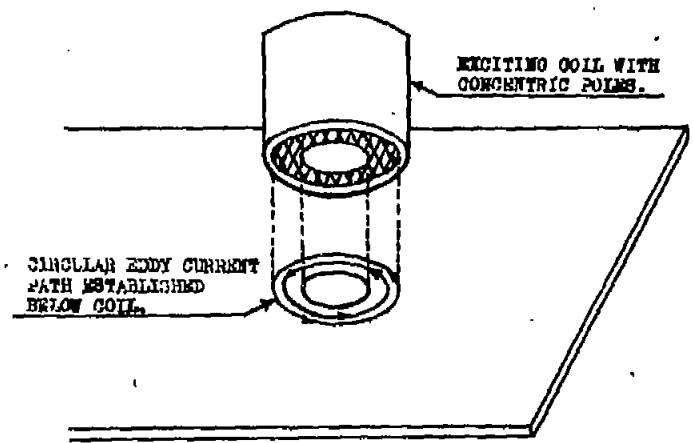

FIG. 20 A.—EXCITING COIL AND CIRCULAR EDDY CURRENT PATH ESTABLISHED.

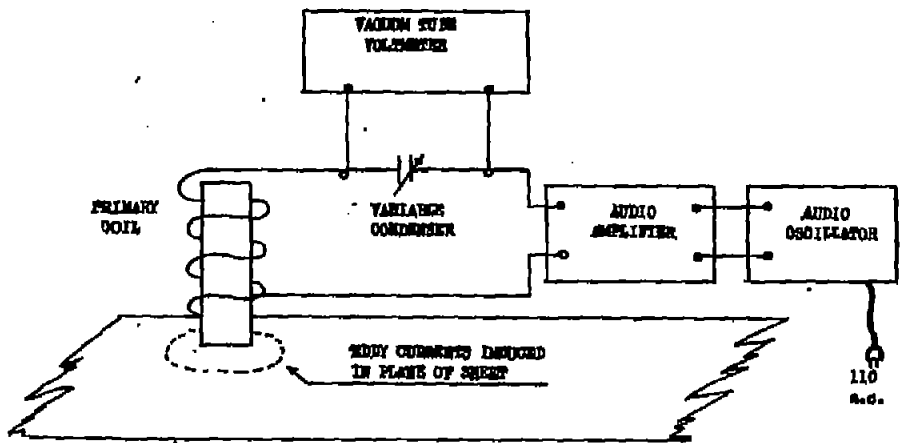

FIG. 20 B.—SERIES RESONANT CIRCUIT USED WITH TRANSFORMER INDUCTION TEST.

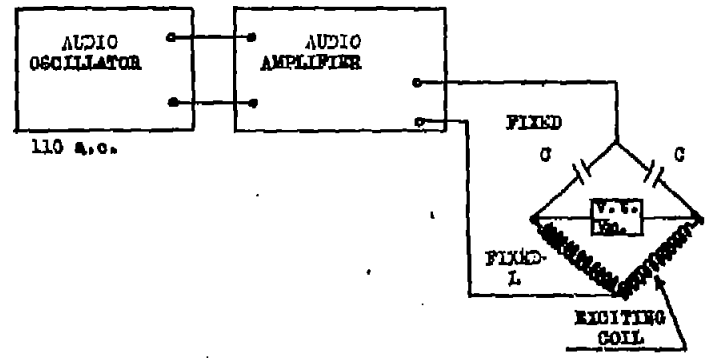

FIG. 20 C.—RESONANT BRIDGE CIRCUIT USED WITH TRANSFORMER INDUCTION TEST.

FIG. 20—TRANSFORMER LOADING EDDY CURRENT INDUCTION TEST OF SHEET THICKNESS, WELD CRACKS, POROSITY, AND SHEET INDENTATION.

NACA TN No. 945

Figs. 19, 20

NACA TN No. 945

Figs. 21, 22, 23

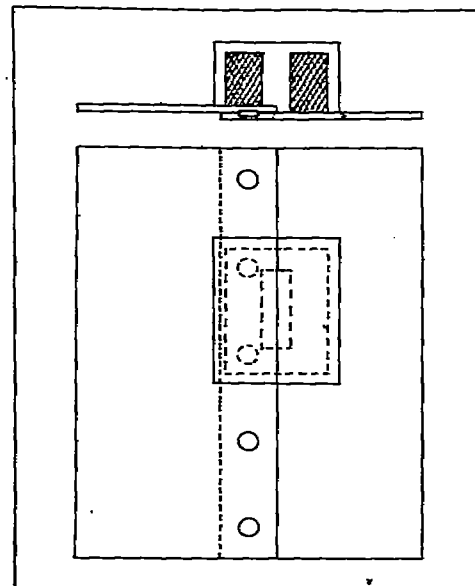
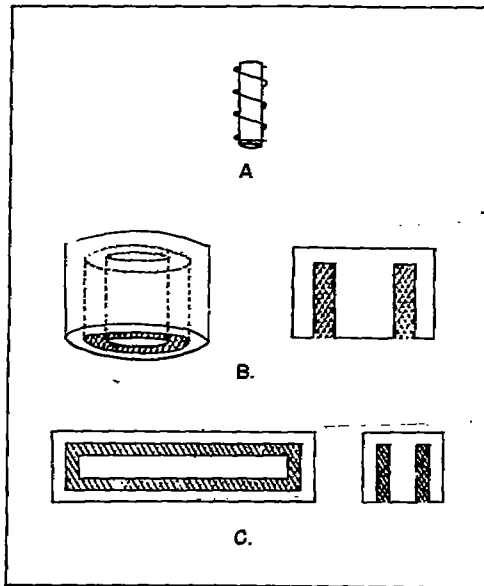

FIG. 21.—USEFUL CONFIGURATIONS OF EDDY CURRENT INDUCTION POLE ASSEMBLIES.

- A. SINGLE CORE ASSEMBLY USED TO MEASURE SHEET THICKNESS.
- B. CONCENTRIC CIRCULAR POLE ASSEMBLY USED TO RESTRICT EDDY CURRENTS TO A CIRCULAR PATH.
- C. RECTANGULAR POLE ASSEMBLY USED TO RESTRICT EDDY CURRENTS TO A RECTANGULAR PATH.

FIG. 23.—THE LAP JOINT TRANSFORMER INDUCTION TEST OF THE BONDED AREA AT THE FAYING PLANE OF THE SPOTWELD.

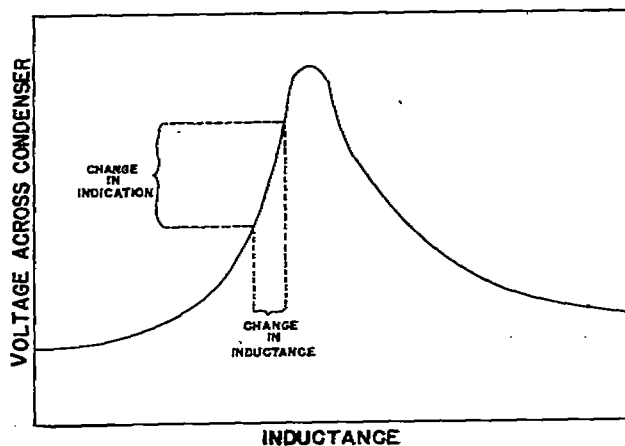

FIG. 22.—RESONANT CIRCUIT RESPONSE OF TRANSFORMER EDDY CURRENT INDUCTION UNIT. SMALL CHANGES IN INDUCTANCE PRODUCE LARGE CHANGES IN INDICATION.

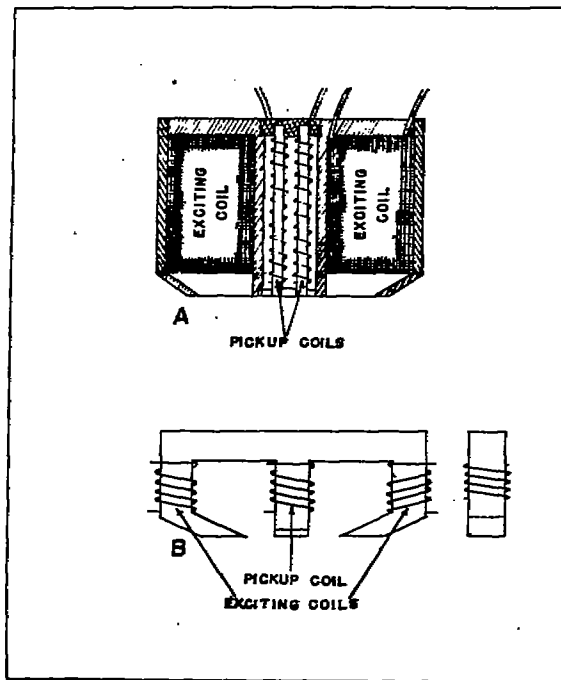

FIG. 24.— TYPICAL PICK-UP COIL EDDY CURRENT TEST UNITS.

A. UNIT FOR FLAW DETECTION IN HOMOGENEOUS PLATES DEVELOPED BY ROSS GUNN, N. R. L. (REF. # 12.)  
B. UNIT FOR DETECTION OF CRACKS AND POROSITY IN SPOTWELDS DEVELOPED BY N. R. L. (REF. # 11.)

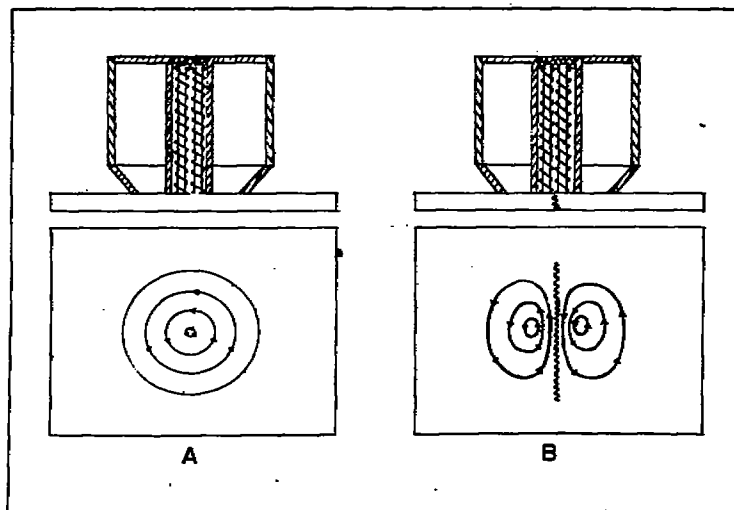

FIG. 25.— EDDY CURRENT FIELD INDUCED BY PICKUP UNIT A.  
A. FIELD IN HOMOGENEOUS PLATE.  
B. FIELD IN PLATE WITH FLAW.



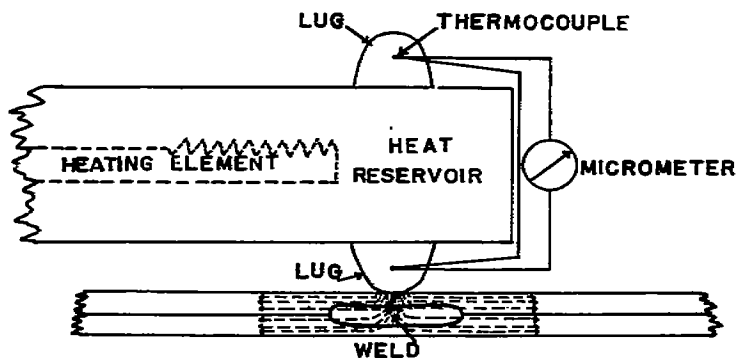

FIG. 26.- HEAT RESERVOIR THERMAL TEST OF THE BONDED AREA AT THE FAYING PLANE OF THE SPOTWELD.

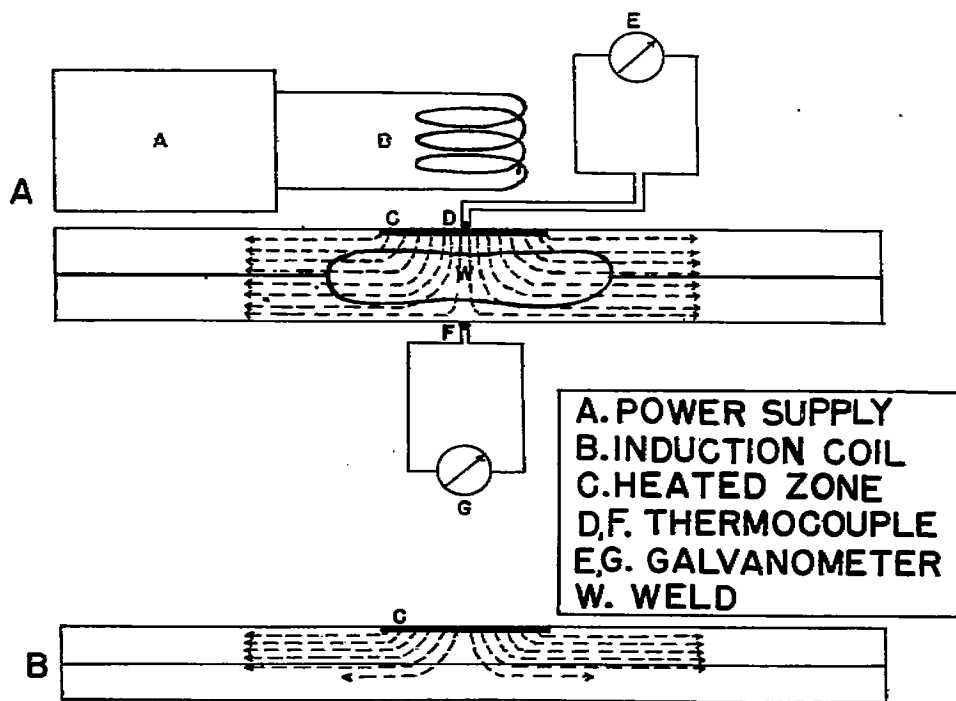

FIG. 27.- INDUCTION HEATING THERMAL TEST OF THE BONDED AREA AT THE FAYING PLANE OF THE SPOTWELD.

- A. HEAT FLOWS ACROSS FAYING PLANE AT WELD.
- B. LITTLE HEAT FLOWS ACROSS FAYING PLANE WHERE NO BOND EXISTS.

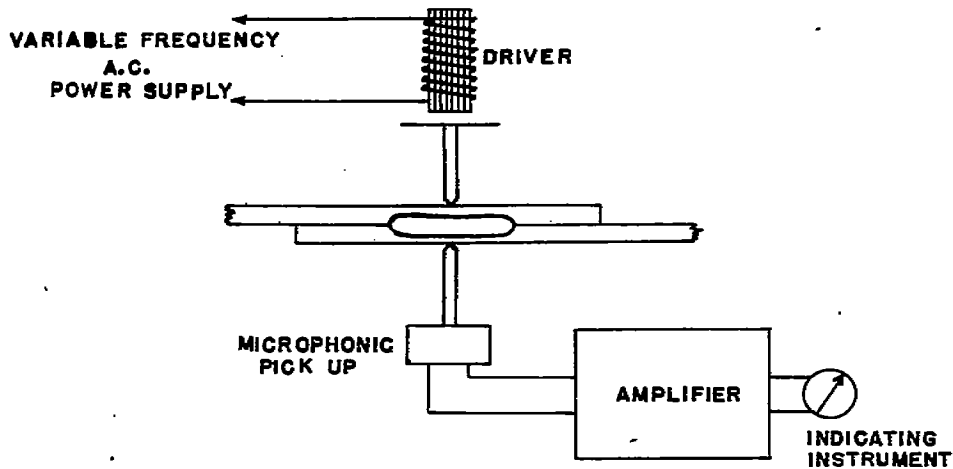

FIG. 28. - VIBRATION DAMPING TEST ARRANGEMENT.

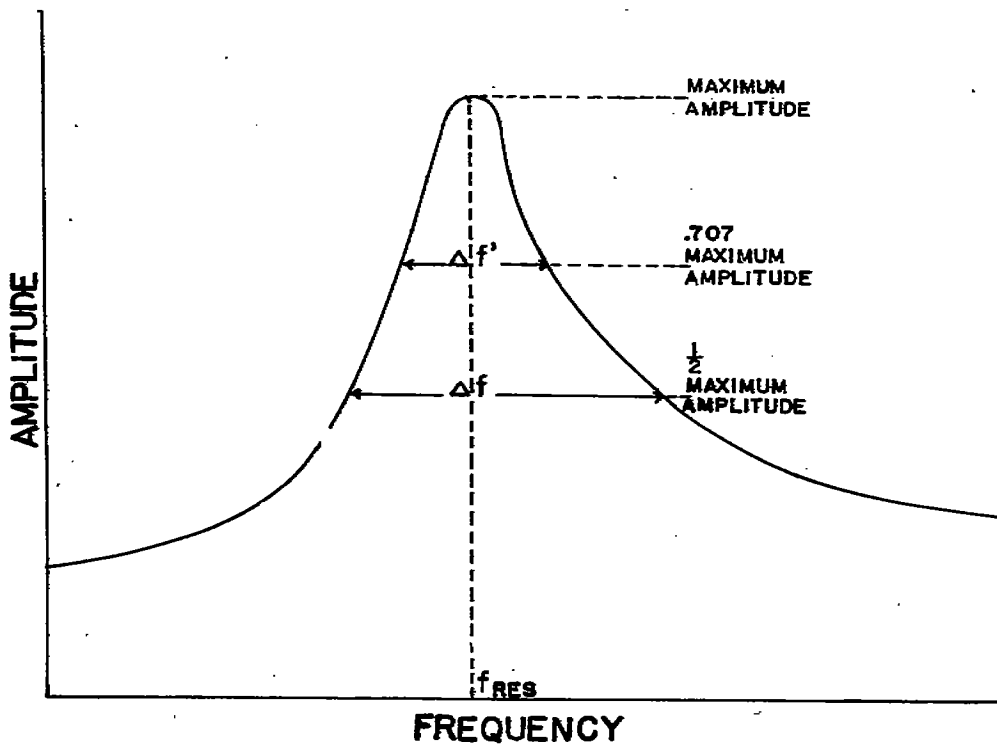

FIG. 29. - VIBRATION RESONANCE AND DAMPING CURVES. THE DECREMENT FACTOR  $\delta$  IS GIVEN BY

$$\delta = 1.814 \frac{\Delta f}{f_{RES}} = \pi \frac{\Delta f'}{f_{RES}}$$

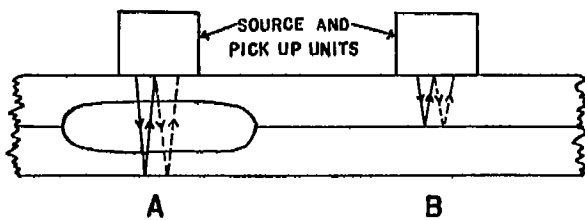

FIG. 30. - WAVE REFLECTION TEST OF BOUNDED AREA OF SPOTWELDS.  
 (A) WAVES PASS THROUGH WELDS AT FAYING PLANE.  
 (B) WAVES REFLECT FROM FAYING PLANE WHERE NO BOND EXISTS.

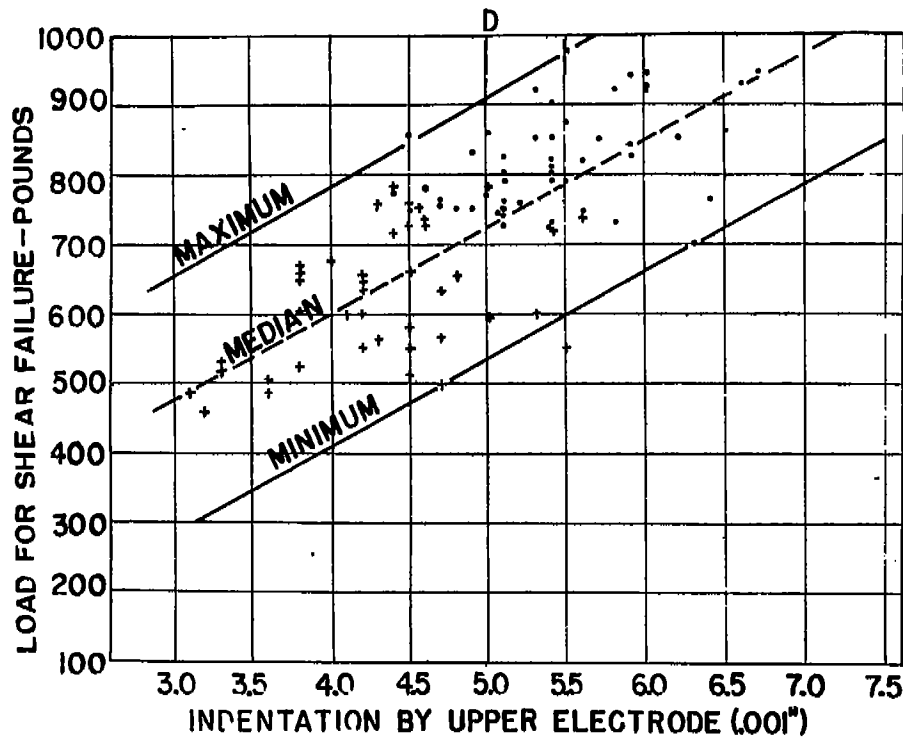
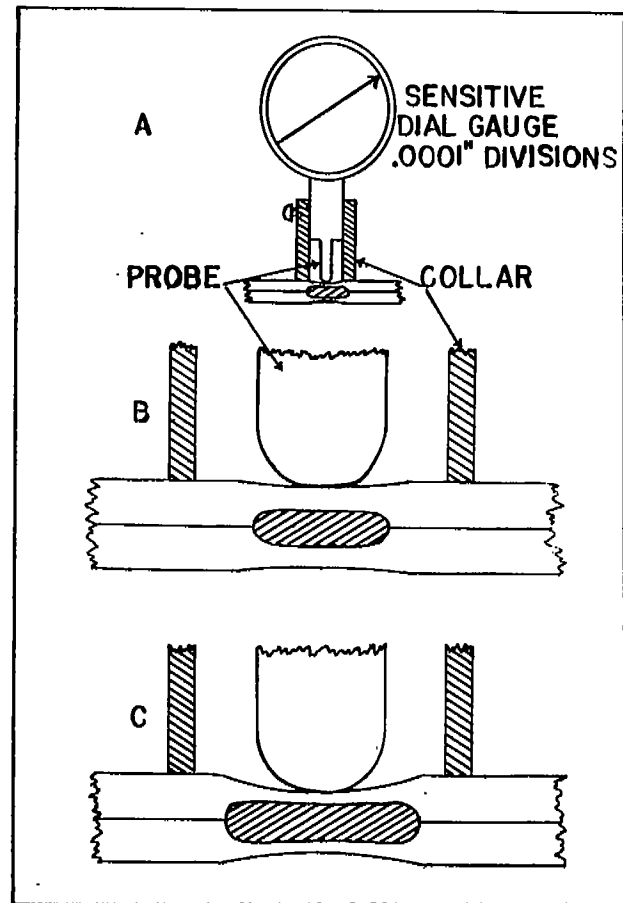

FIG. 31. - ELECTRODE INDENTATION OF WELDED SHEET TEST OF SPOTWELD SIZE, AND STRENGTH.



A. DIAL GAUGE WITH COLLAR  
 B. SMALL INDENTATION OVER SMALL WELD  
 C. LARGE INDENTATION OVER LARGE WELD  
 D. RESULTS OF INDENTATION TESTS ON 141 SCIAYKY WELDS IN .040" 24ST ALCLAD.

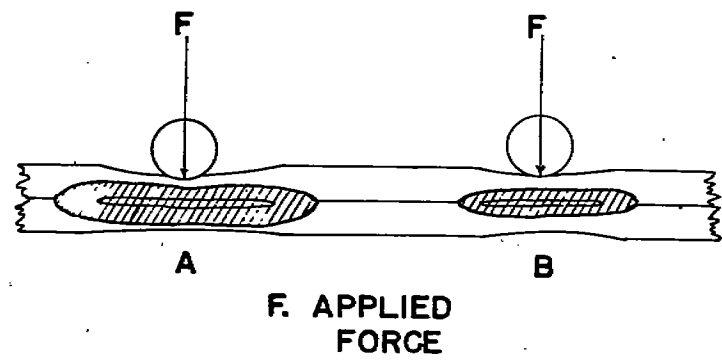

FIG. 32.— ONE POINT ONE SIDE PENETRATOR TEST OF SPOT WELD NUGGET PENETRATION. GREATER INDENTATIONS RESULT OVER LARGE NUGGETS (A) THEN OVER SMALL NUGGETS (B).

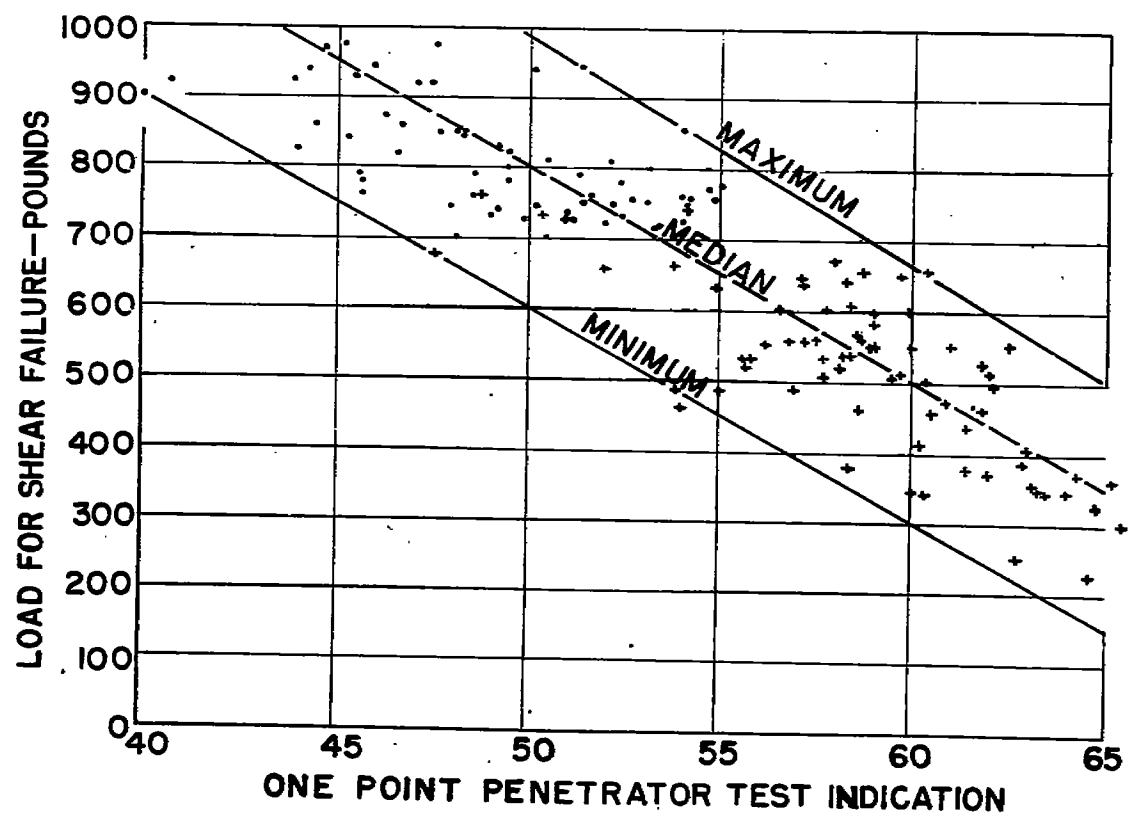

FIG. 33.— RESULTS OF ONE POINT ONE SIDE PENETRATOR TEST OF 141 SCIAYK WELDS IN .040" 24ST ALCLAD.

NACA TN No. 945

Fig. 34

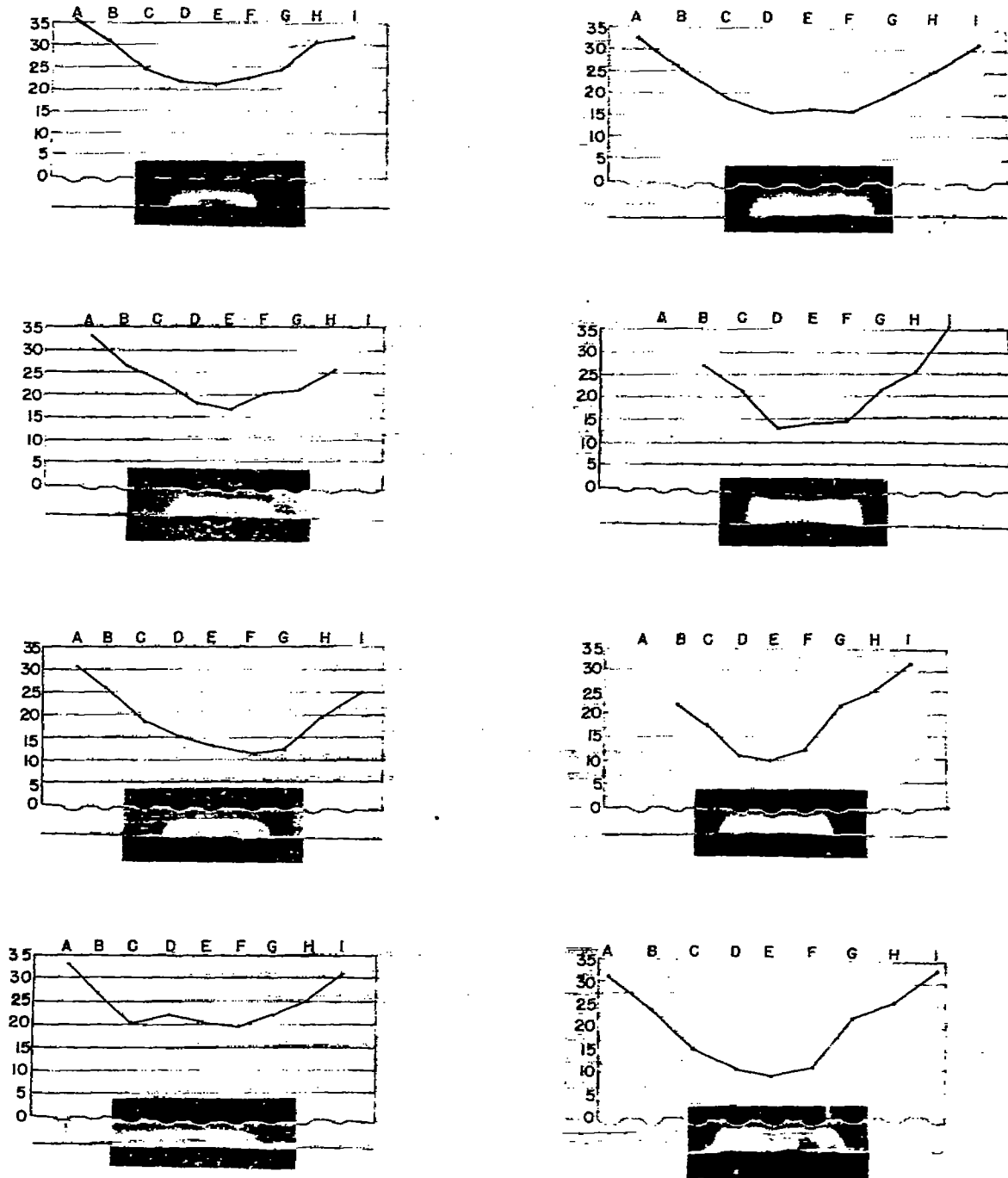

FIG. 34.-CHARACTERISTIC PENETRATOR PROFILES  
OF SPOTWELDS

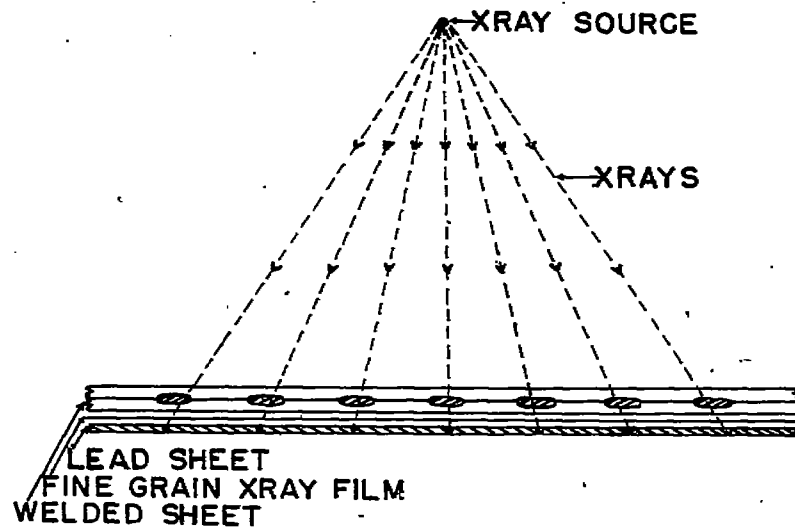

FIG. 35. RADIOGRAPHY OF SPOT WELDS.

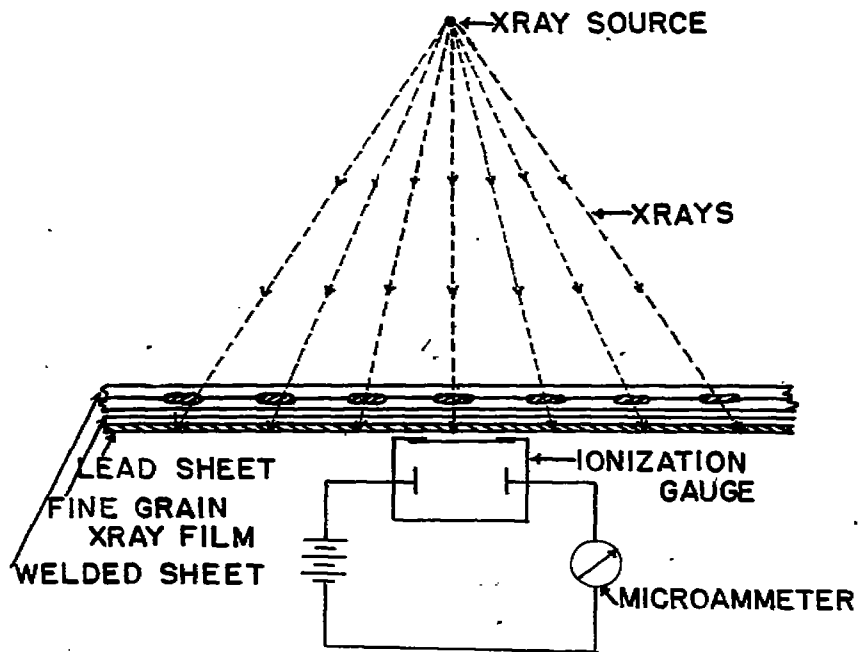
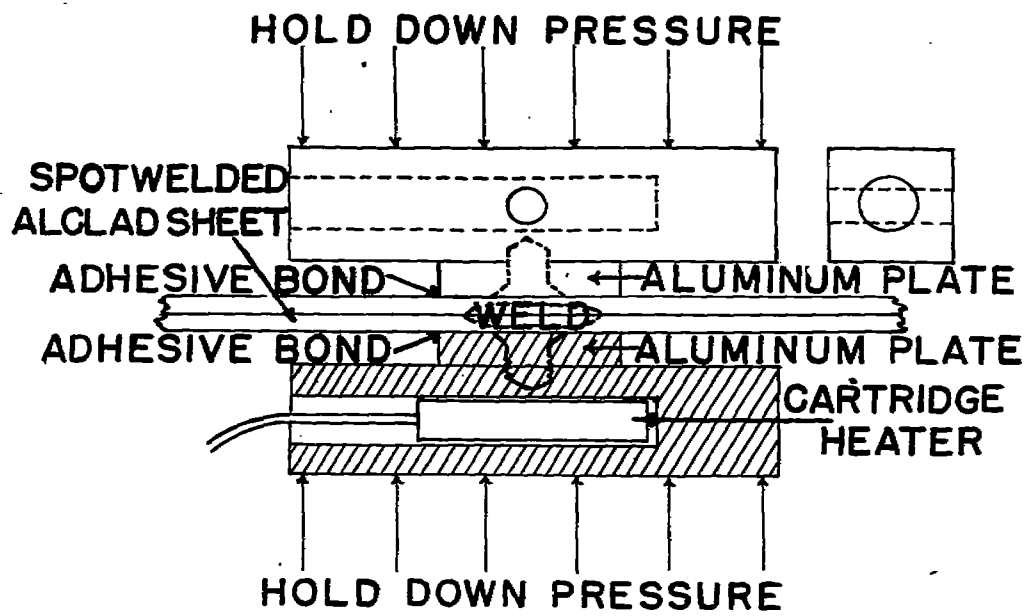
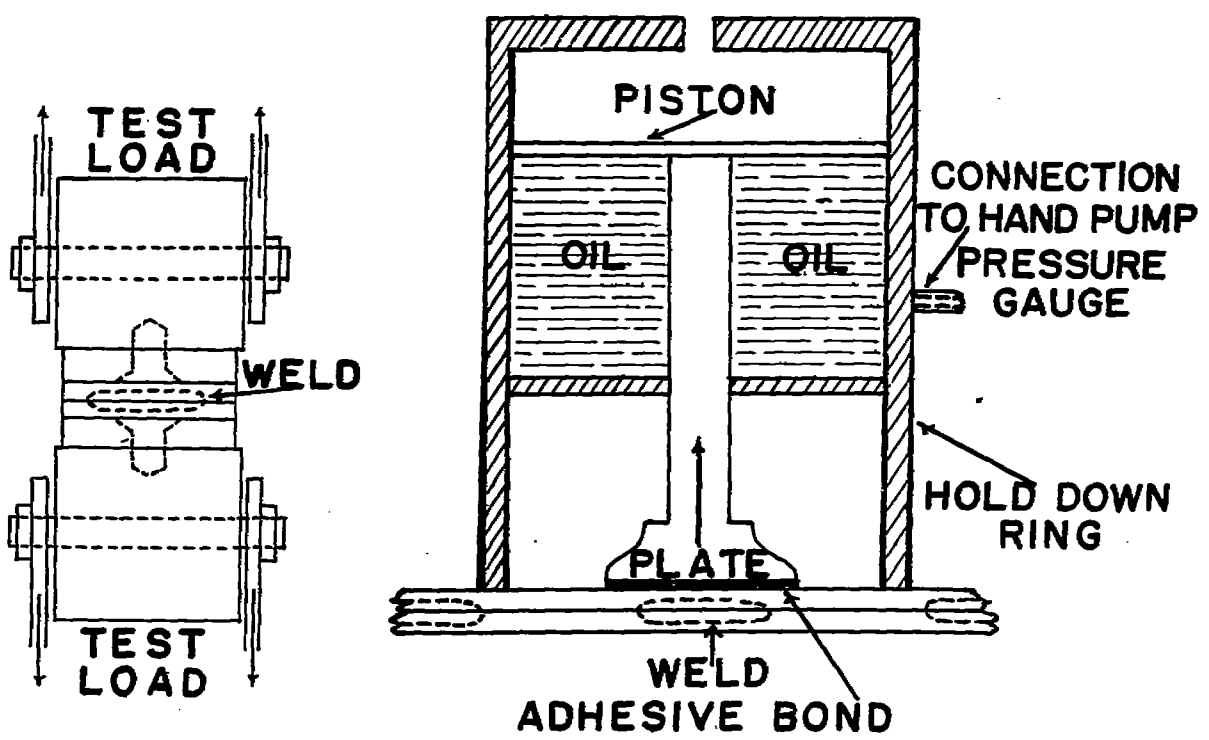

FIG. 36.-ARRANGEMENT OF EQUIPMENT FOR IONIZATION GAUGE TESTS OF SPOTWELDS.





A. BONDING LOADING DISC TO SHEET



B. TENSION TESTING OF WELD

C. HYDRAULIC LOADING DEVICE

FIG. 37.- ADHESIVE BOND PROOF TEST OF SPOT WELD

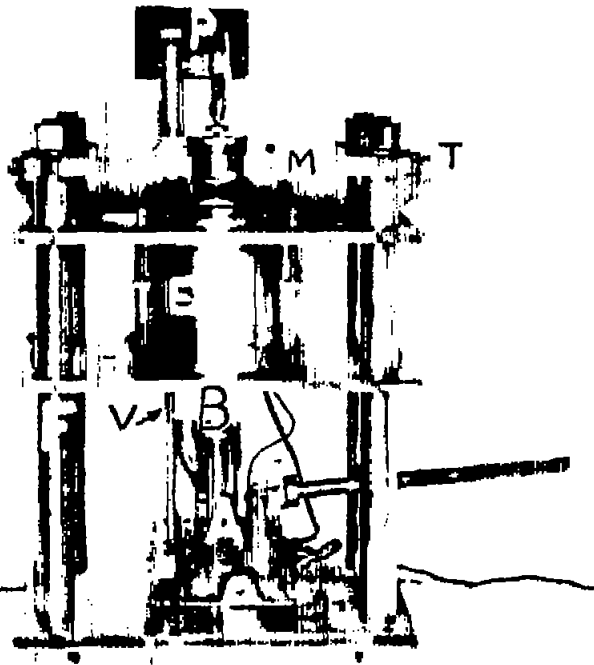

FIG. 38a. - SIDE VIEW OF ASSEMBLED MACHINE.

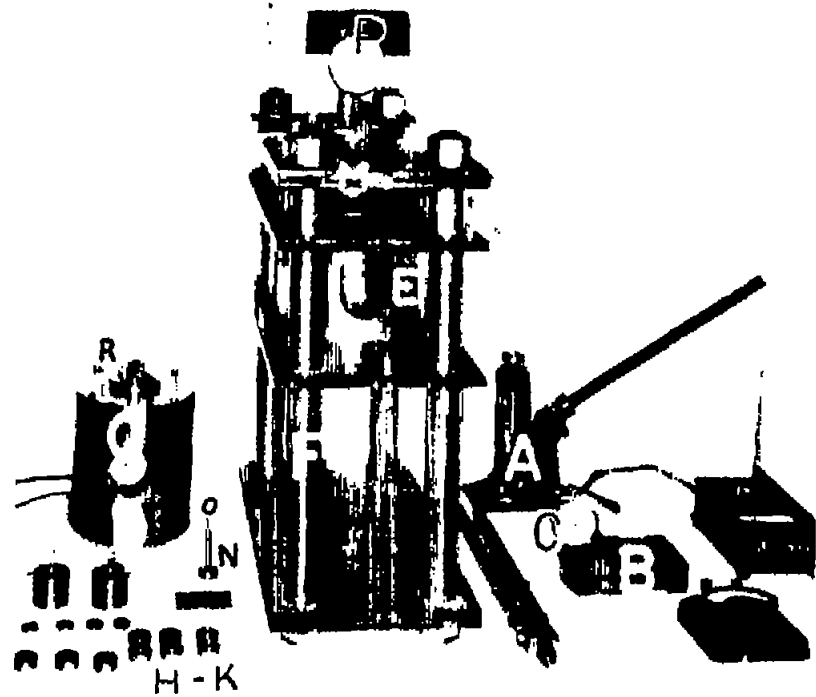

FIG. 38b. - DETAIL OF MACHINE, DISASSEMBLED.

- |                           |                            |                    |
|---------------------------|----------------------------|--------------------|
| A. HYDRAULIC JACK.        | H. ANVIL INSERT.           | O. CONTACT TIPS.   |
| B. WEIGHING BLOCK.        | I. ANVIL-LOWER.            | P. Q. DIAL GUAGES. |
| C. LOAD DIAL GUAGE.       | J. BALL PENETRATORS-UPPER. | R. PISTON CAP.     |
| D. MOVING CYLINDER.       | K. ANVIL INSERT.           | T,U. TERMINALS.    |
| E. CYLINDRICAL GUIDE.     | L. ANVIL-UPPER.            | V. MICROSWITCH.    |
| F. FRAME.                 | M. TOP PLATE.              |                    |
| G. BALLPENETRATORS-LOWER. | N. PROBES.                 |                    |

FIG. 38(a to d). - SPOTWELD NON-DESTRUCTIVE TESTING MACHINE NO. 1.

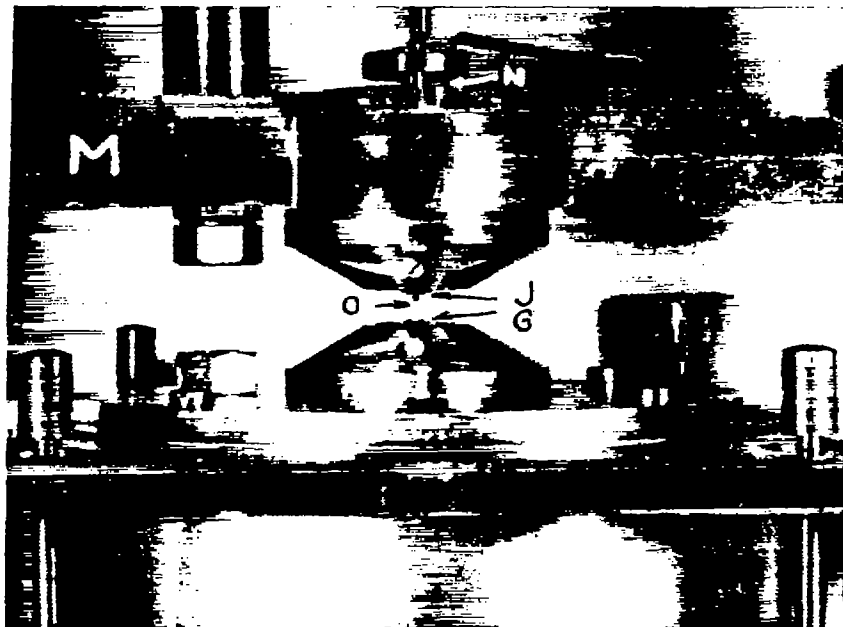

FIG. 38c.- DETAIL OF ANVIL AND PENETRATOR  
ASSEMBLY



FIG. 38d.- DETAIL OF WEIGHING BLOCK.

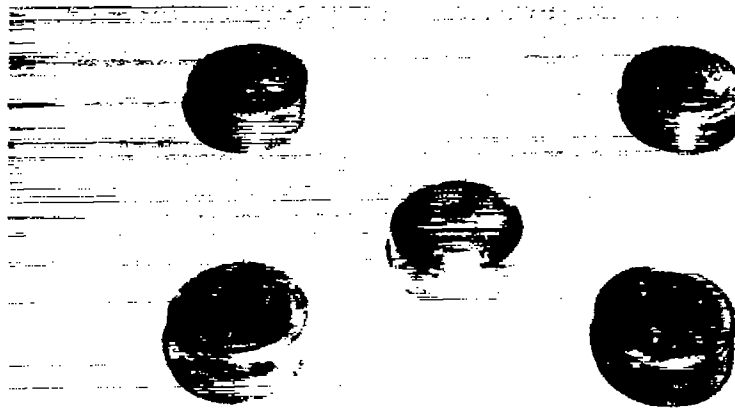

FIG. 39. - RING PENETRATOR ASSEMBLIES USED ON TESTING MACHINE NO. 1.

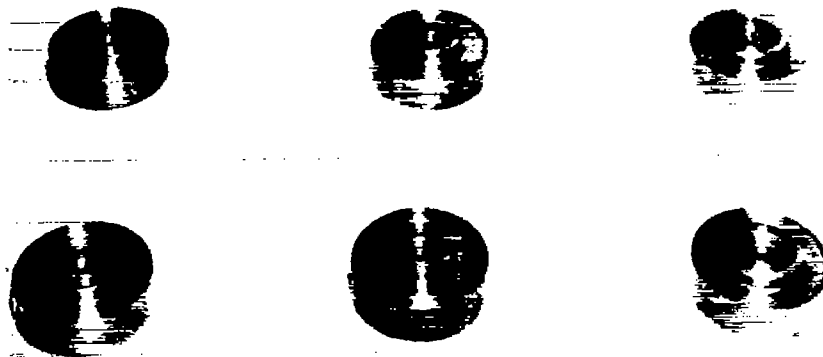

FIG. 40. - RING ELECTRODE ASSEMBLIES USED ON TESTING MACHINE NO. 1.

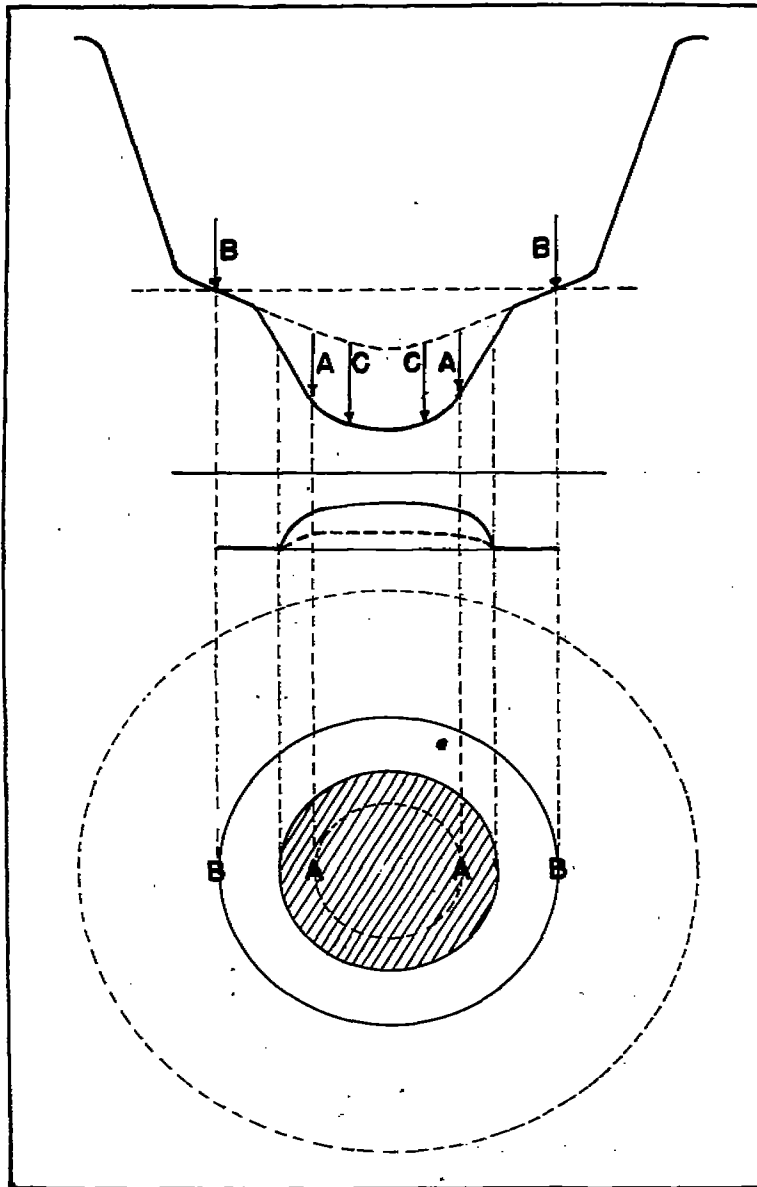
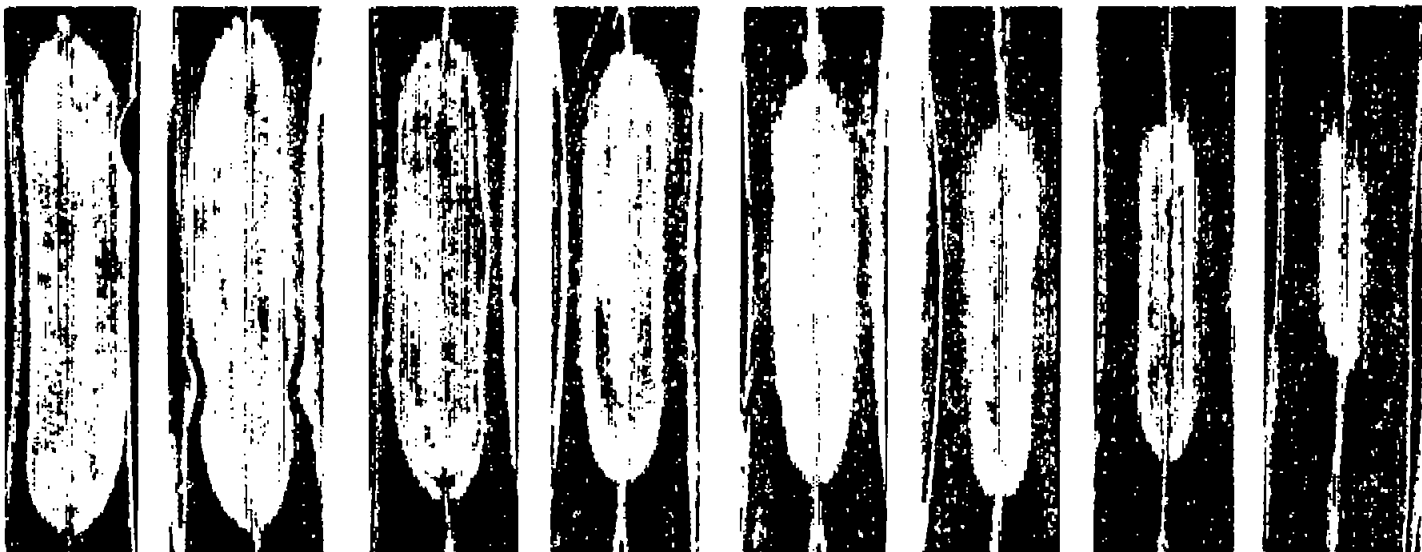

FIG. 41. - CHARACTERISTIC SHAPE OF PENETRATOR PROFILE.  
TOP. PENETRATOR INDICATION PROFILE.  
CENTER. SECTION THROUGH NUGGET.  
BOTTOM. FAYING SURFACE OF WELD.  
DOTTED CURVE CORRESPONDS TO THIN NUGGET.



WELD SECTION

TAYLOR WINFIELD WELDS  
 IN .040" 24ST ALCLAD.

2275      2050      1900      1800      1650      Volts      1600      1500      1400

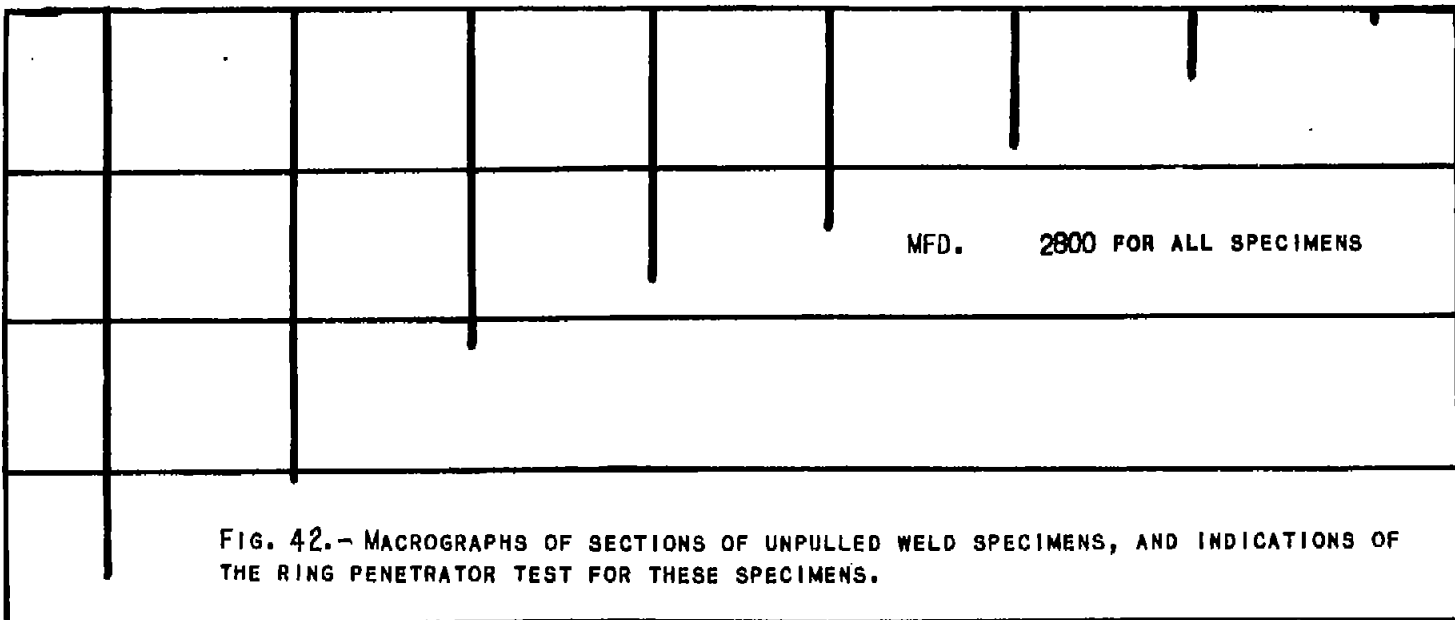

140 150 160 170 180

RING PENETRATOR  
 INDICATION

FIG. 42.- MACROGRAPHS OF SECTIONS OF UNPULLED WELD SPECIMENS, AND INDICATIONS OF THE RING PENETRATOR TEST FOR THESE SPECIMENS.



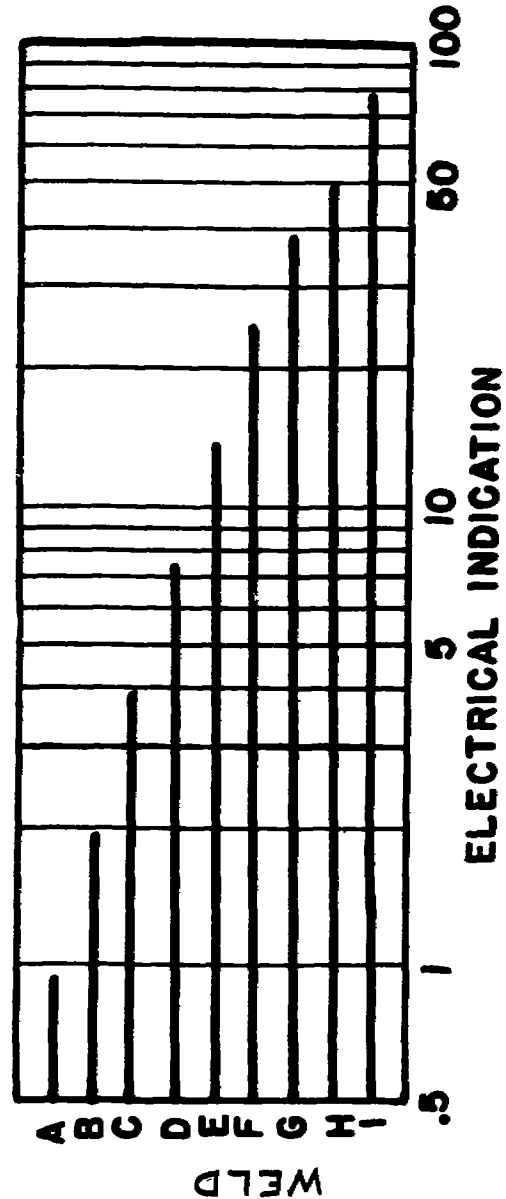
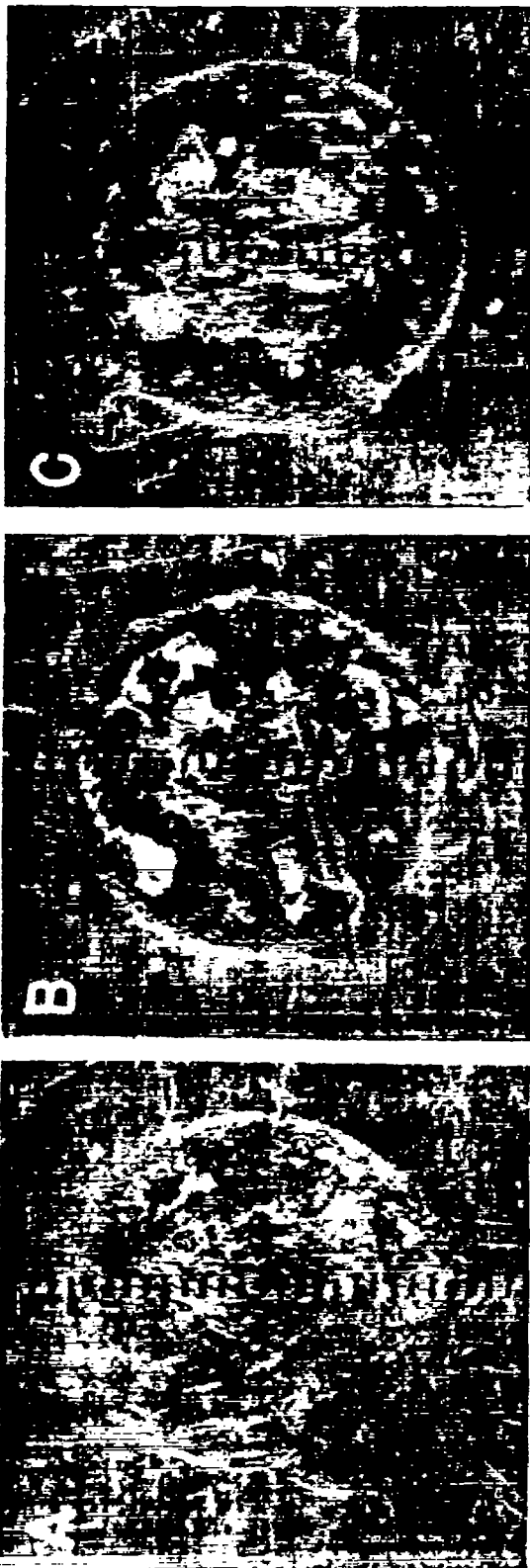

FIG. 43a,b.-INDICATIONS OF THE RING ELECTRODE TWO SIDE DIRECT CURRENT TEST FOR TYPICAL SPOT WELDS (FAYING SURFACES SHOWN AFTER SHEAR PULL TEST.)

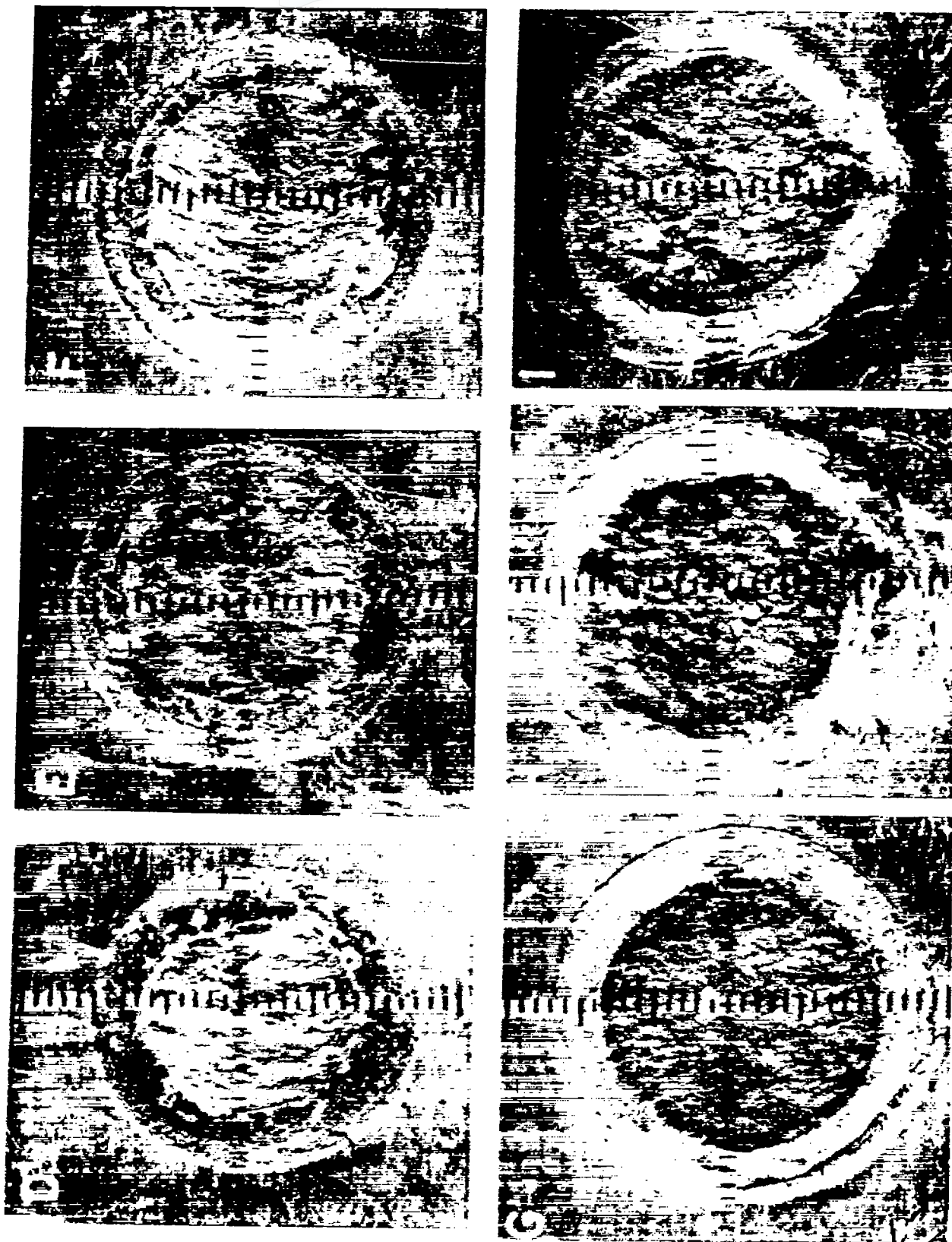
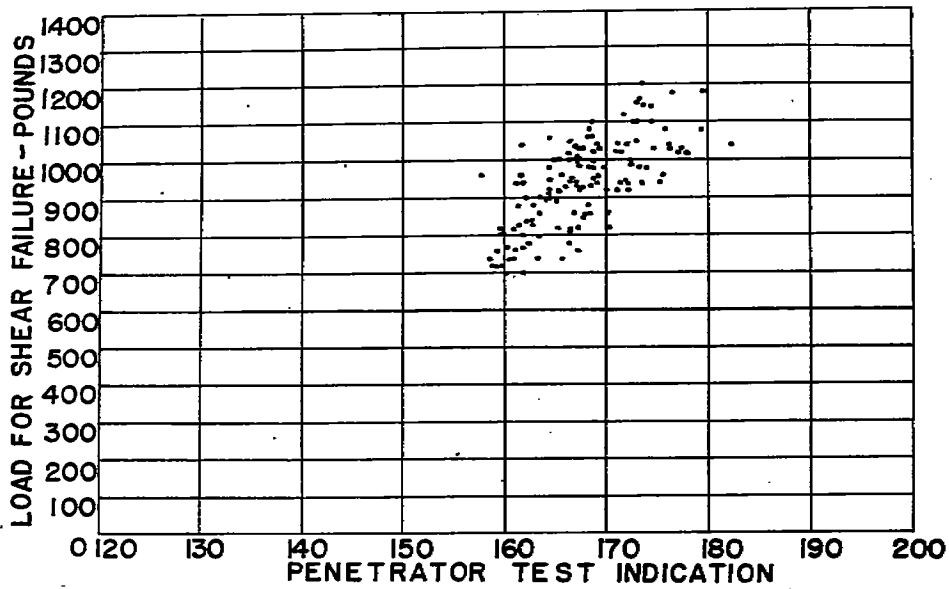
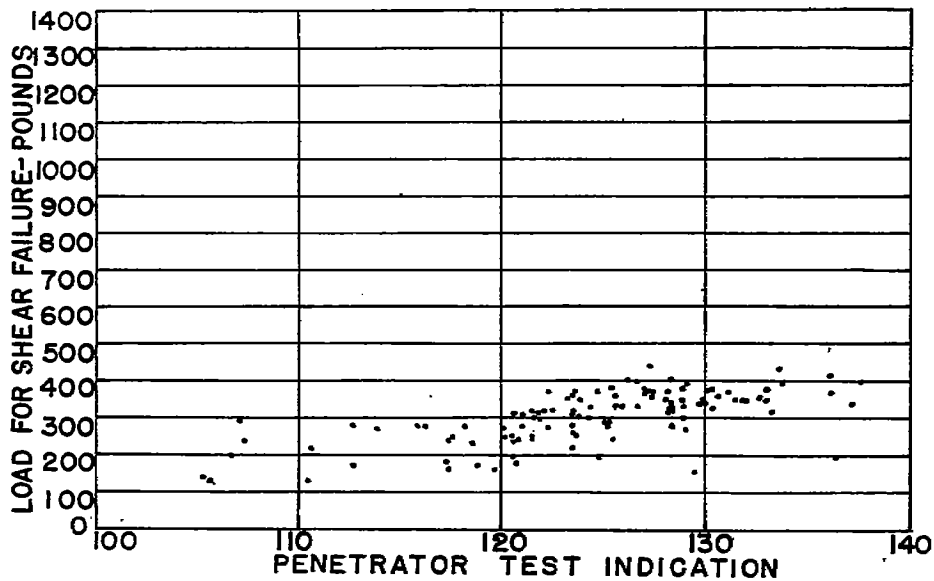

FIG. 43b.



A



B

FIG. 44.- RESULTS OF PENETRATOR TESTS USING 3 BALL PENETRATOR ADJUSTED FOR .040" 24ST SHEET ON:

- A. 175 TAYLOR - WINFIELD SPOTWELDS IN .064" 24ST SHEET.
- B. 138 SCIAKY SPOTWELDS IN .020" 24ST SHEET (SEE FIG. 41A).

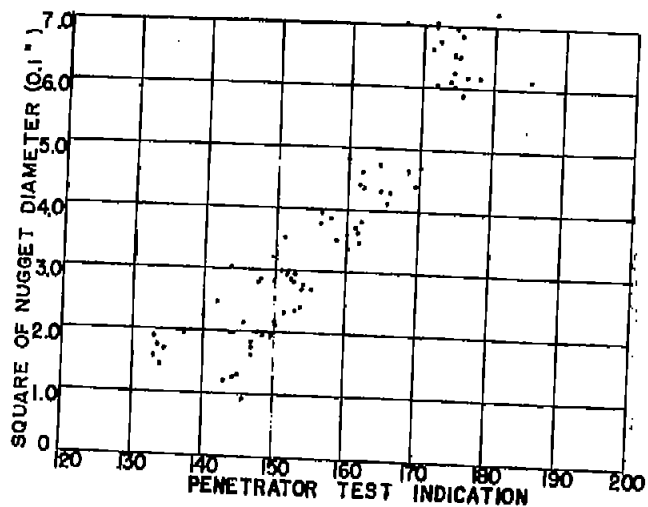

A. 138 TAYLOR WINFIELD SPOTWELDS MADE BY CONSOLIDATED VULTEE AIRCRAFT CORPORATION (SAN DIEGO) IN .040" 24ST ALCLAD.

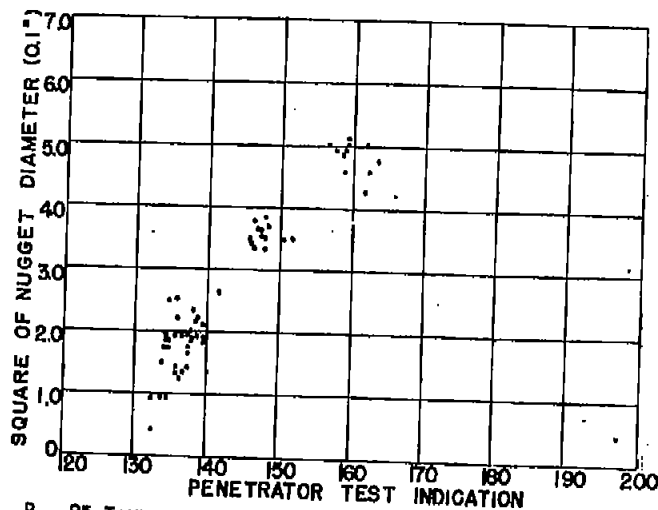

B. 85 TAYLOR WINFIELD SPOTWELDS MADE ON THE LABORATORY WELDER AT THE UNIVERSITY OF SOUTHERN CALIFORNIA IN .040" 24ST ALCLAD.

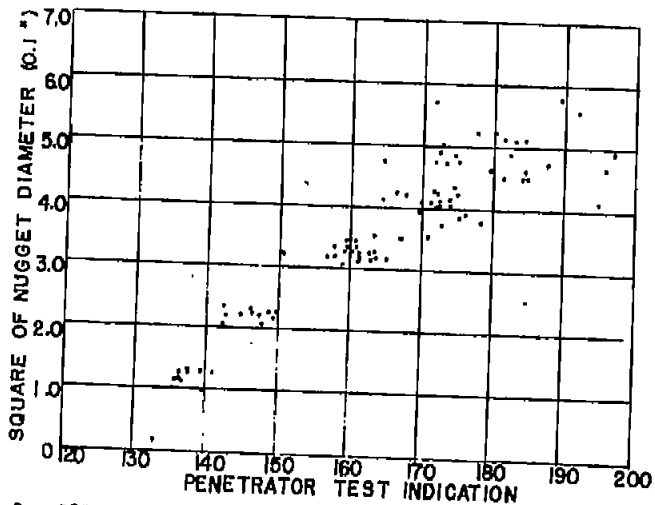

C. 105 TAYLOR WINFIELD SPOTWELDS MADE ON THE LABORATORY WELDER AT THE UNIVERSITY OF SOUTHERN CALIFORNIA IN .040" 24ST ALCLAD.

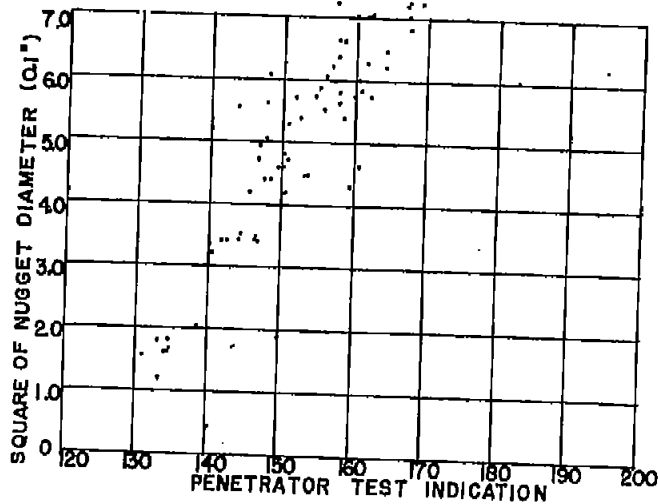

D. 105 TAYLOR WINFIELD SPOTWELDS MADE ON THE LABORATORY WELDER AT THE UNIVERSITY OF SOUTHERN CALIFORNIA IN .040" 24ST ALCLAD.

NOTE: THESE GROUPS OF SPOTWELDS WERE PURPOSELY MADE UNDER WIDELY DIFFERENT CONDITIONS FOR USE IN DEVELOPING NON-DESTRUCTIVE TESTS.

FIG. 45.- MEASUREMENT OF SPOTWELD NUGGET DIAMETER BY PENETRATOR TEST USING 4 BALL PENETRATOR ASSEMBLY.

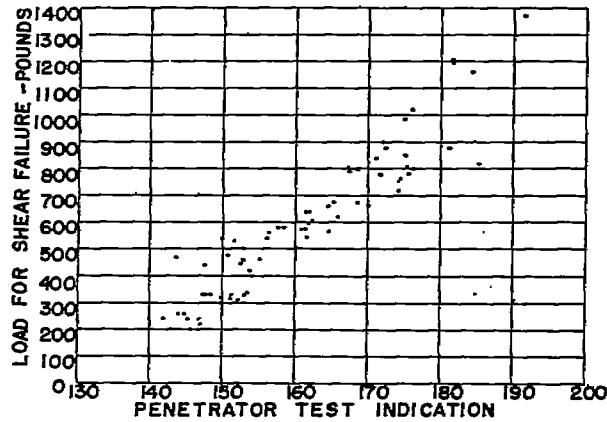

A. 138 TAYLOR WINFIELD SPOTWELDS MADE BY CONSOLIDATED VULTEE AIRCRAFT CORPORATION (SAN DIEGO) IN .040" 24ST ALCLAD. [COMPARE WITH FIG. 41 B]

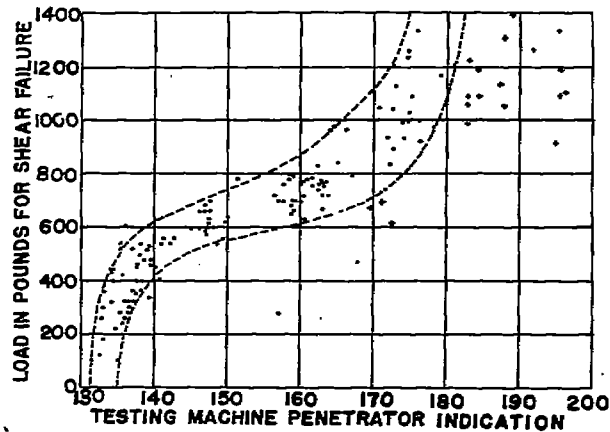

B. 135 TAYLOR WINFIELD SPOTWELDS MADE ON LABORATORY WELDER AT UNIVERSITY OF SOUTHERN CALIFORNIA IN .040" 24ST ALCLAD. [COMPARE WITH FIG. 41 H.]

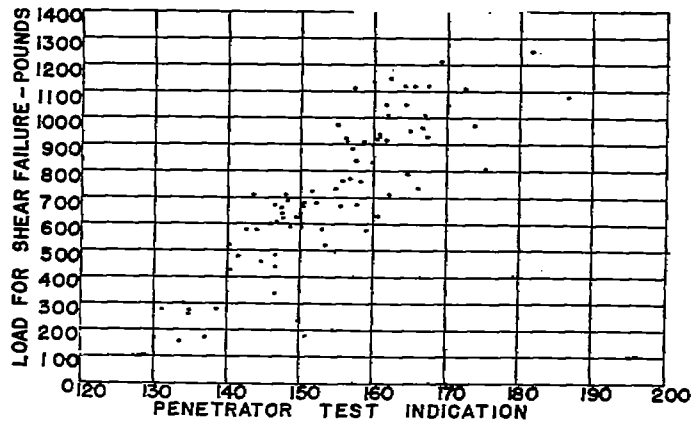

C. 105 TAYLOR WINFIELD SPOTWELDS MADE ON LABORATORY WELDER AT UNIVERSITY OF SOUTHERN CALIFORNIA IN .040" 24ST ALCLAD. [COMPARE WITH FIG. 41 H.]

FIG. 46.- MEASUREMENT OF STATIC SHEAR STRENGTH OF SPOTWELDS BY PENETRATOR TEST, USING 4 BALL PENETRATOR ASSEMBLY.

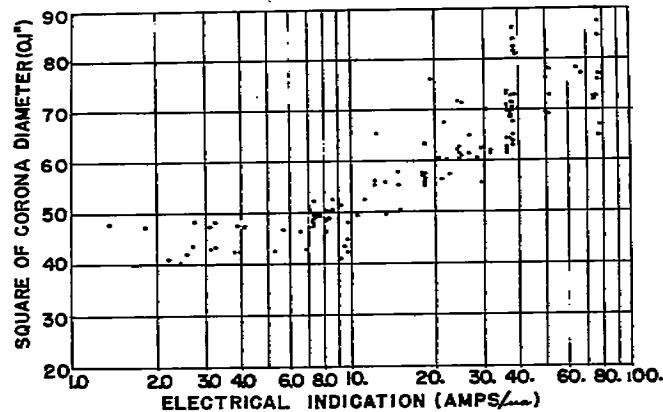

A. 181 WELDS IN .040" 24ST ALCLAD MADE ON FEDERAL WELDER AT RYAN AERONAUTICAL CORPORATION, SAN DIEGO, CALIFORNIA.

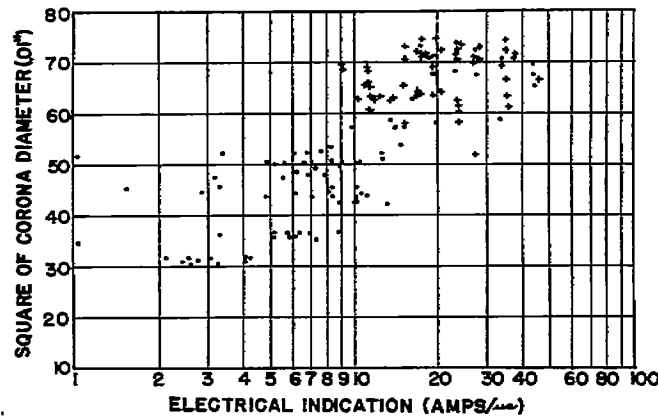

B. 141 WELDS IN .040" 24ST ALCLAD MADE ON SCIACKY WELDER AT LOCKHEED AIRCRAFT CORPORATION.

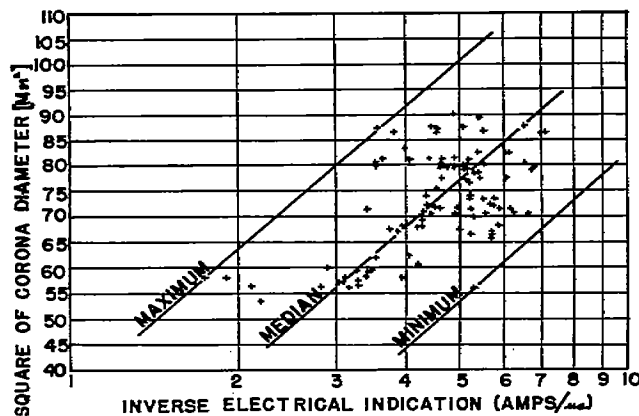

C. 108 WELDS IN .064" 24ST ALCLAD MADE ON SCIACKY WELDER AT LOCKHEED AIRCRAFT CORPORATION.

FIG. 47.- CORRELATION BETWEEN ELECTRICAL TEST INDICATIONS AND THE TOTAL AREA OF BONDING AT THE FAYING PLANE OF THE SPOTWELD. TESTS MADE WITH RING ELECTRODES ON INDUSTRIALLY-MADE SPOTWELDS.



FAA/TN No. 945

FIG. 48

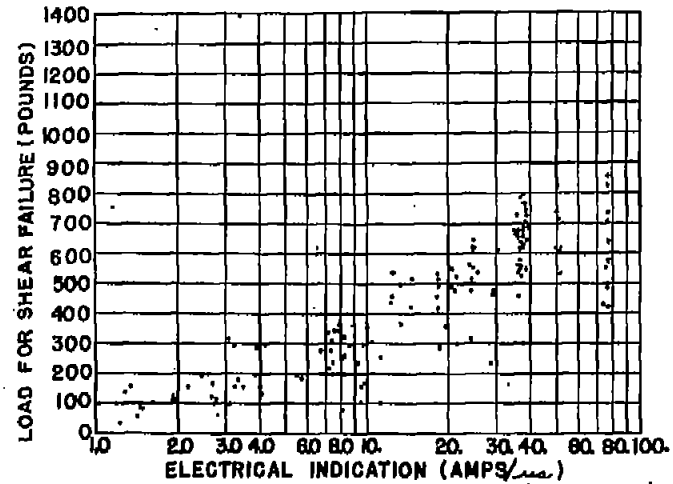

A. 181 WELDS IN .040" 24ST ALCLAD MADE ON FEDERAL WELDER AT RYAN AERONAUTICAL CORPORATION, SAN DIEGO, CALIFORNIA.

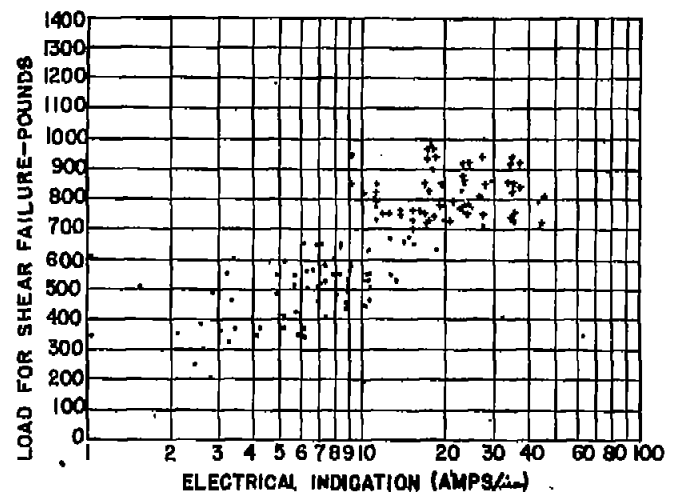

B. 141 WELDS IN .040" 24ST ALCLAD MADE ON SCIACKY WELDER AT LOCKHEED AIRCRAFT CORPORATION.

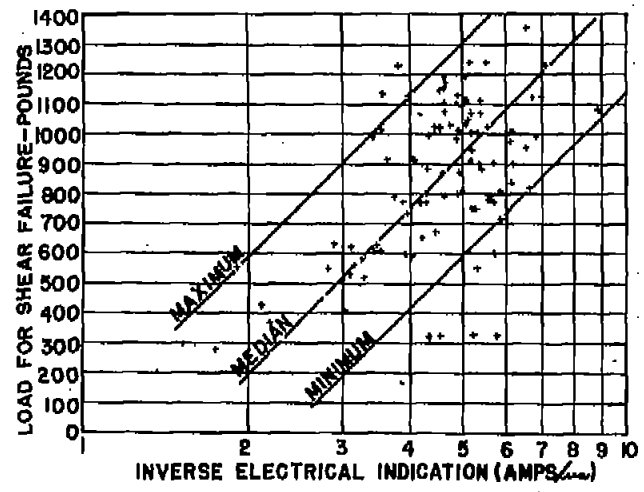

C. 138 WELDS IN .064" 24ST ALCLAD MADE ON SCIACKY WELDER AT LOCKHEED AIRCRAFT CORPORATION.

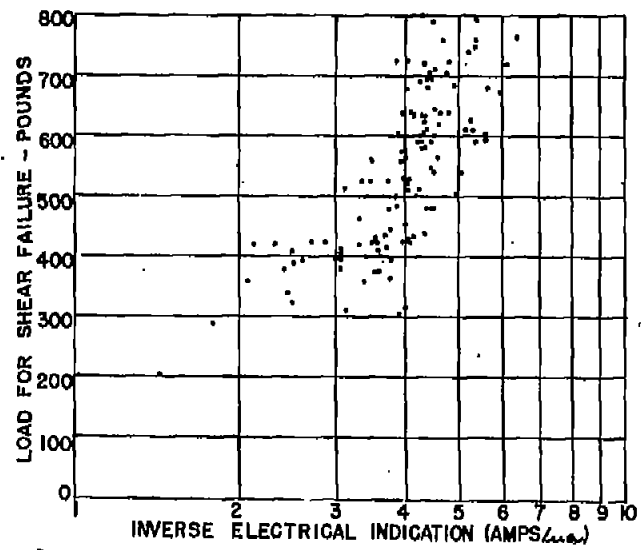

D. 140 WELDS IN .040" 24ST ALCLAD MADE ON SCIACKY WELDER AT LOCKHEED AIRCRAFT CORPORATION.

FIG. 48.-- CORRELATION BETWEEN ELECTRICAL TEST INDICATIONS AND SPOTWELD STATIC SHEAR STRENGTH ON INDUSTRIALLY-MADE SPOTWELDS. (SINCE THE ELECTRICAL TEST DOES NOT DISCRIMINATE THE TYPE OF BONDING AT THE FAYING SURFACE, IT CANNOT BE USED ALONE FOR RELIABLE PREDICTION OF WELD STRENGTH.)

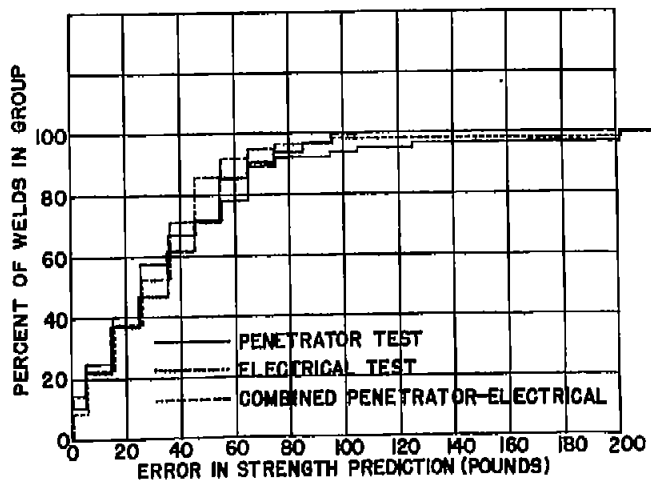
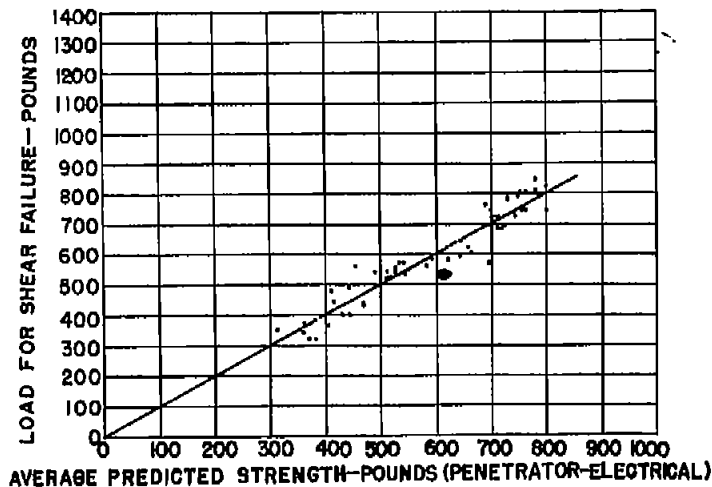
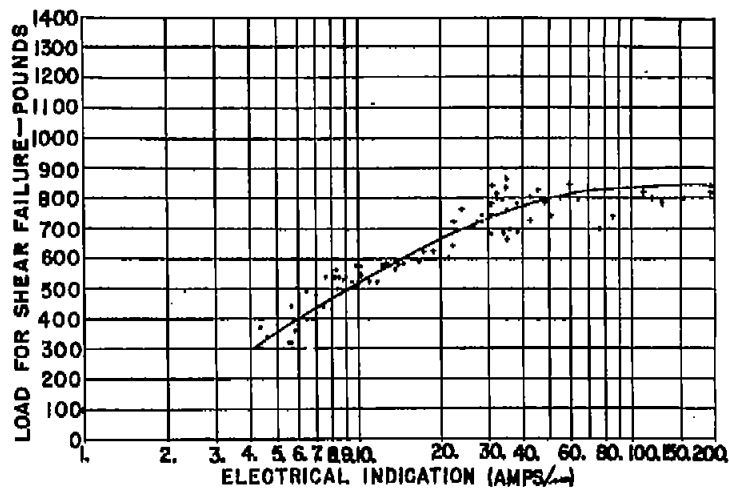
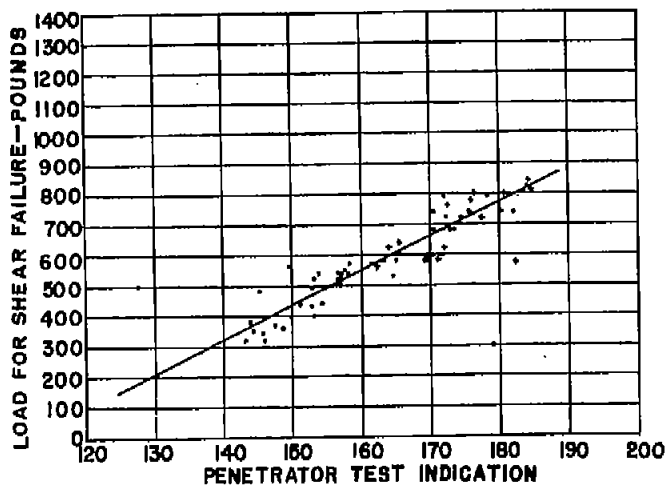

FIG. 49.- MEASUREMENT OF SPOTWELD STATIC SHEAR STRENGTH BY COMBINED PENETRATOR AND ELECTRICAL INDICATIONS. 100 WELDS IN .040" 24ST ALCLAD MADE ON TAYLOR-WINFIELD WELDER AT NORTHRUP AIR-CRAFT CORPORATION.

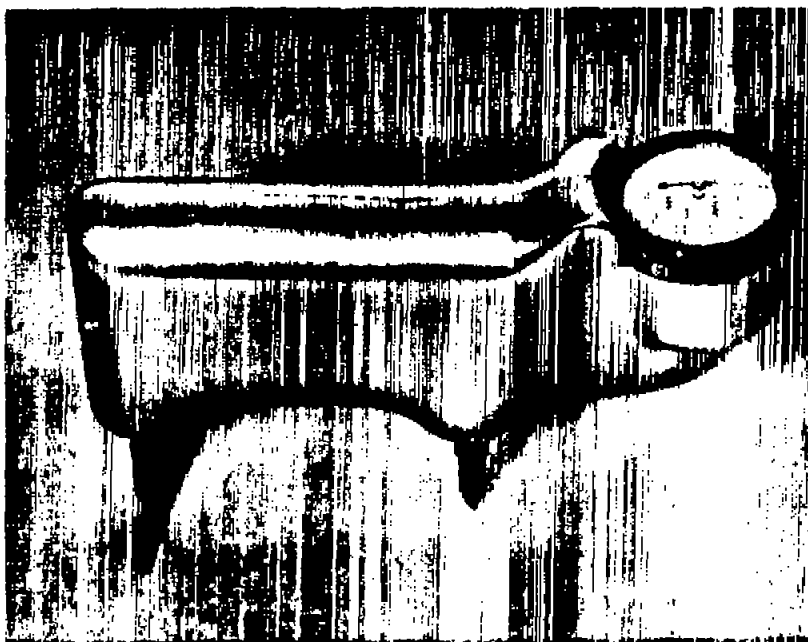

FIG. 50.- HAND HARDNESS TESTER SUITABLE FOR PENETRATOR TESTS OF SPOTWELDS IN THIN ALUMINUM ALLOY SHEETS. (BARCOL IMPRESSOR -- BARBER COLMAN CO.)