

JAN 28 1947

ARR July 1942



NATIONAL ADVISORY COMMITTEE FOR AERONAUTICS

WARTIME REPORT

ORIGINALLY ISSUED
July 1942 as
Advance Restricted Report

WIND-TUNNEL INVESTIGATION OF CONTROL-SURFACE

CHARACTERISTICS

VIII - A LARGE AERODYNAMIC BALANCE OF TWO NOSE SHAPES

USED WITH A 30-PERCENT-CHORD FLAP ON

AN NACA 0015 AIRFOIL

By Richard I. Sears and Clarence L. Gillis

Langley Memorial Aeronautical Laboratory
Langley Field, Va.

LANGLEY MEMORIAL AERONAUTICAL
LABORATORY
LANGLEY FIELD, VA.



WASHINGTON

NOT TO BE TAKEN FROM THIS ROOM

NACA WARTIME REPORTS are reprints of papers originally issued to provide rapid distribution of advance research results to an authorized group requiring them for the war effort. They were previously held under a security status but are now unclassified. Some of these reports were not technically edited. All have been reproduced without change in order to expedite general distribution.

NATIONAL ADVISORY COMMITTEE FOR AERONAUTICS

ADVANCE RESTRICTED REPORT

WIND-TUNNEL INVESTIGATION OF CONTROL-SURFACE
CHARACTERISTICS. VIII - A LARGE AERODYNAMIC BALANCE
OF TWO NOSE SHAPES USED WITH A 30-PERCENT-CHORD FLAP ON
AN NACA 0015 AIRFOIL

By Richard I. Sears and Clarence L. Gillis

SUMMARY

Force tests in two-dimensional flow have been made in the NACA 4- by 6-foot vertical tunnel of the characteristics of an NACA 0015 airfoil with a balanced flap having a chord 30 percent of the airfoil chord, a flap-nose overhang 50 percent of the flap chord, and a tab having a chord 20 percent of the flap chord. The results are presented in the form of aerodynamic section characteristics for a sealed and an unsealed gap at the flap nose.

The slope of the lift curve and the lift effectiveness of the balanced flap were slightly less than those for the NACA 0009 airfoil with the same flap. The aerodynamic balance of 50 percent of the flap chord caused overbalance through some range of deflections for both nose shapes tested with gaps sealed and unsealed. The blunt nose shape was more effective in reducing hinge moments than the medium nose shape. Unsealing the gap at the nose of the flap caused a decrease in the slope of the lift curve and an increase in the effectiveness of the balance for both nose shapes.

INTRODUCTION

The NACA has instituted an extensive investigation of the aerodynamic section characteristics of control surfaces in two-dimensional flow in an effort to determine the types of flap arrangement best suited for use as control surfaces and to provide experimental data for design purposes. The first phase of the investigation consisted of the experimental determination of the pressure distribution of the

L-57C

NACA 0009 airfoil with many sizes of plain flaps and tabs. The results of these tests have been presented in reference 1 in the form of parameters for determining the characteristics of a thin symmetrical airfoil with a plain flap of any chord.

The second phase of the investigation consisted of force-test measurements in two-dimensional flow of the characteristics of an NACA 0009 airfoil with a 30-percent-airfoil-chord ($0.30c$) flap having various amounts of aerodynamic balance, various flap-nose shapes, various sizes of gap at the flap nose, and various beveled trailing edges on a flap of thickened profile. The results of these tests are reported in references 2 to 6.

A series of tests has been undertaken to provide data for the NACA 0015 airfoil with a $0.30c$ flap and a 20-percent-flap-chord ($0.20c_f$) plain tab, with various flap-balance arrangements as previously tested on the NACA 0009 airfoil. The results of the tests are presented in reference 7 for the plain flap, in reference 8 for the flap with a $0.35c_f$ aerodynamic balance, and in the present paper for the flap with a $0.50c_f$ aerodynamic balance.

APPARATUS AND MODEL

The tests were made in the NACA 4- by 6-foot vertical tunnel (reference 9). The test section of this tunnel has been converted from the original open, circular, 5-foot-diameter jet to a closed, rectangular, 4- by 6-foot throat for force tests of models in two-dimensional flow. A three-component balance system is used to measure lift, drag, and pitching moment. The hinge moments of the flap and tab were measured with torque-rod balance built into the model.

The 2-foot-chord by 4-foot-span model (fig. 1) was made of laminated mahogany to the NACA 0015 profile (table I). For the present tests, it was equipped with a $0.30c$ flap and a $0.20c_f$ tab. The flap had an aerodynamic balance that extended forward of the flap-hinge axis 50 percent of the flap chord. The balance had two nose shapes, blunt and medium (fig. 1), which were made in the form of interchangeable nose blocks. Table II gives stations and ordinates for the medium-nose flap balance. The blunt-nose flap balance was defined by the normal airfoil contour

L-373

with a nose radius of approximately one-half the airfoil thickness (fig. 1). The gap at the nose of the flap was 0.005c and, for the sealed-gap tests, was filled with light grease. The tab was made of brass, with a nose radius approximately one-half the airfoil thickness at the tab-hinge axis. The gap at the nose of the tab was 0.001c and, when sealed-gap tests were made, was filled with light grease.

The model, when mounted in the tunnel, completely spanned the test section. With this type of installation two-dimensional flow is approximated; and the section characteristics of the airfoil, flap, and tab may be determined. The model was attached to the balance frame by torque tubes that extended through the sides of the tunnel. The angle of attack was set from outside the tunnel by rotating the torque tubes with an electric drive. Flap and tab deflections were set inside the tunnel by templets and were held by friction clamps on the torque rods that were used in measuring the hinge moments.

TESTS

The tests were made at a dynamic pressure of 15 pounds per square foot, which corresponds to an air velocity of about 76 miles per hour at standard sea-level conditions. The effective Reynolds number of the tests was approximately 2,760,000. (Effective Reynolds number = test Reynolds number \times turbulence factor. The turbulence factor for the 4- by 6-foot vertical tunnel is 1.93.)

The flap was set at deflections from 0° to 25° in 5° increments. The tab was set at deflections from 0° to 20° in 5° increments for both flap-nose shapes. The tab tests were made with the flap neutral and with both flap and tab gaps unsealed because in previous tests the balanced flap was found more effective with the gap unsealed. The blunt and medium nose shapes were tested throughout the flap-deflection range with the flap and tab gaps either both sealed or both unsealed. The lift, the drag, and the pitching moments of the airfoil and the hinge moments of the flap and the tab were measured. For each flap and tab setting, force tests were made throughout the angle-of-attack range at 2° increments from negative stall to positive stall. When either stall position was approached, the increment was reduced to 1° angle of attack.

RESULTS

Symbols

The coefficients and the symbols used in this paper are defined as follows:

- c_l airfoil section lift coefficient (l/qc)
- c_{d_0} airfoil section profile-drag coefficient (d_0/qc)
- c_m airfoil section pitching-moment coefficient (m/qc^2)
- c_{h_f} flap section hinge-moment coefficient (h_f/qc_f^2)
- c_{h_t} tab section hinge-moment coefficient (h_t/qc_t^2)

where

- l airfoil section lift
 - d_0 airfoil section profile drag
 - m airfoil section pitching moment about quarter-chord point of airfoil
 - h_f flap section hinge moment
 - h_t tab section hinge moment
 - c chord of basic airfoil with flap and tab neutral
 - c_f flap chord
 - c_t tab chord
 - q dynamic pressure
- and
- α_0 angle of attack for airfoil of infinite aspect ratio
 - δ_f flap deflection with respect to airfoil
 - δ_t tab deflection with respect to flap

L-373

also

$$c_{l\alpha} = \left(\frac{\partial c_l}{\partial \alpha_0} \right)_{\delta_f, \delta_t}$$

$$c_{l\alpha(\text{free})} = \left(\frac{\partial c_l}{\partial \alpha_0} \right)_{c_{h_f}=0}$$

$$c_{h_f\alpha} = \left(\frac{\partial c_{h_f}}{\partial \alpha_0} \right)_{\delta_f, \delta_t}$$

$$c_{h_f\delta_f} = \left(\frac{\partial c_{h_f}}{\partial \delta_f} \right)_{\alpha_0, \delta_t}$$

$$c_{h_f\delta_t} = \left(\frac{\partial c_{h_f}}{\partial \delta_t} \right)_{\alpha_0, \delta_f}$$

$$c_{h_t\alpha} = \left(\frac{\partial c_{h_t}}{\partial \alpha_0} \right)_{\delta_f, \delta_t}$$

$$c_{h_t\delta_t} = \left(\frac{\partial c_{h_t}}{\partial \delta_t} \right)_{\alpha_0, \delta_f}$$

The subscripts outside the parentheses represent the factors held constant during the measurement of the parameters.

Precision

The accuracy of the data is indicated by the deviation from zero of lift and moment coefficients at an angle of attack of 0°. The maximum error in effective angle of attack at zero lift appears to be about ±0.2°. Flap deflections were set within ±0.2°. Tunnel corrections, experimentally determined in the 4- by 6-foot vertical tunnel, were applied only to lift. The hinge moments are probably slightly higher than would be obtained in free air and, consequently, the values presented are considered conservative. The increments of profile-drag coefficient are believed to be accurate within ±0.0005 and should be reasonably independent of tunnel effect, although the absolute

value is subject to an unknown correction. Inaccuracies in the section data presented are thought to be negligible relative to inaccuracies that will be incurred in the application of the data to finite airfoils.

Presentation of Data

The lift, pitching-moment, and hinge-moment characteristics of NACA 0015 airfoil with a 0.30c flap are presented in figures 2 and 3 for the blunt and medium flap-nose shapes, respectively, with the gaps sealed and unsealed. Some parameters from the curves of figures 2 and 3 are given in table III. The tabulated slopes were measured at small flap deflections and small angles of attack where the curves are linear.

The increments of profile-drag coefficient caused by flap deflection are given in figure 4 and were obtained by deducting the profile-drag coefficient of the airfoil with flap and tab neutral from the profile-drag coefficients with the flap deflected, all other factors being constant.

The effects of deflecting a 0.20c_f tab on the aerodynamic characteristics with flap neutral at various angles of attack are shown in figures 5 and 6 for the blunt and medium nose shapes, respectively. The increments of lift and of flap hinge-moment coefficient caused by tab deflection were obtained by deducting the coefficient with the tab neutral from the coefficients with the tab deflected, all other factors being constant.

DISCUSSION OF AERODYNAMIC SECTION CHARACTERISTICS

Lift

Figures 2 and 3 show that the lift curves of the NACA 0015 airfoil for the various flap deflections are of the same general shape as the corresponding curves for the NACA 0009 airfoil (reference 3). At a given flap deflection, however, the angle of attack at which the airfoil stalls is about 5° greater for the thicker airfoil than for the thinner airfoil; consequently, the maximum lift coefficient of the thicker airfoil was greater by about 0.4. This effect may be attributed to the greater nose radius of the thicker airfoil.

The slope of the lift curve $c_{l\alpha}$ (table III) was un-

L-578

affected by the flap-nose shapes tested but was affected considerably by gap, decreasing when the gap was unsealed. This result is in agreement with that for the NACA 0009 airfoil (reference 3). The reduction in $c_{l\alpha}$ due to un-

sealing the gap for the NACA 0009 airfoil, however, is not directly comparable with that in the present tests inasmuch as the gap used on the thinner airfoil was only 0.0015c as compared with a gap of 0.005c for the present tests. The slope $c_{l\alpha}$ with the gap sealed was somewhat smaller for the thicker airfoil than for the thinner airfoil.

The effectiveness of the flap in producing lift is indicated by the parameter $\left(\frac{c_{l\alpha}}{\delta b c_f}\right)_{c_l}$ in table III. A com-

parison of these values with the data of reference 7 indicates that the flap with a 0.50c_f overhang has approximately the same lift effectiveness as the plain flap except for the flap with a blunt nose and a 0.005c gap, for which the lift effectiveness is slightly higher than for the plain flap. The lift effectiveness of the flap with large balance on the NACA 0015 airfoil is smaller than for the similar flap on the NACA 0009 airfoil except for the blunt-nose flap with a 0.005c gap, which gives approximately the same effectiveness on both airfoils.

The lift effectiveness of the blunt-nose flap is greater than that of the medium-nose flap. Because of separation of flow over the flap, the blunt-nose flap lost all its lift effectiveness when deflected more than 15° in conjunction with the angle of attack; under the same conditions the medium-nose flap maintained its effectiveness to a deflection of 25°. At flap deflections in opposition to the angle of attack, a condition that is the normal operating range for a horizontal tail surface, the flap with either nose shape was effective in producing increments of lift to a deflection of 25°, the largest deflection tested. Because of separation phenomena, however, the effectiveness at large flap deflections was not so great as that at small deflections.

Hinge Moment of Flap

The nature of the distribution of pressure over the flap on the NACA 0015 airfoil is known to be different

from that over the flap on the NACA 0009 airfoil. This condition is indicated by the fact that the slope $c_{hf\alpha}$ is more positive and the hinge-moment coefficient curves are linear over a smaller range of angles of attack for the thicker airfoil than for the thinner airfoil. The air flow over the trailing-edge portion of the thick airfoil is probably somewhat similar to that discussed in reference 6 for flaps of thickened profile and beveled trailing edges.

It is important to remember that the parameters in table III represent the slopes of the curves at zero flap deflection and at an angle of attack of 0. They are valid, therefore, only for the small range in which the curves are linear and should be used only as an indication of the relative merits of different flap-nose shapes. In the calculation of the characteristics of a control surface, therefore, the hinge-moment coefficient curves (figs. 2 and 3) should be used rather than the tabulated parameters.

All the data in this report are for infinite aspect ratio. The effect of finite aspect ratio on the hinge-moment characteristics is discussed in reference 1. It should be noted here that $c_{hf\alpha}$ and $c_{hf\delta_f}$ will change in magnitude, and possibly in sign, with a change in aspect ratio. These facts are important for the subject investigation because the parameters are small and their signs are critical.

On the NACA 0015 airfoil all the flap-nose shapes and gaps tested on the flap with a 0.50c_f overhang gave more positive values of $c_{hf\alpha}$ than did similar flap arrangements on the NACA 0009 airfoil (reference 3). The variation of hinge-moment coefficient with flap deflection $c_{hf\delta_f}$ was smaller for the balanced flap on the thicker than on the thinner airfoil for all flap arrangements tested. These effects were similar to those for a plain flap on the NACA 0015 airfoil (reference 7).

It is apparent from figures 2 and 3 that, with gaps sealed and unsealed, the balanced flap of the present investigation produced overbalance through some range of flap deflections for both flap-nose shapes. The amount of

L-578

the overbalance and the range through which it extended was greater for the blunt-nose flap. Unsealing the gap at the nose of the flap caused an increase positively of both $c_{h_{f\alpha}}$ and $c_{h_{f\delta_f}}$, a result that is in agreement with the results for the thin airfoil (reference 3).

Because the flap with $0.50c_f$ overhang was overbalanced throughout some range of deflection, it cannot be used without modifications. A trailing-edge tab deflected in the same direction as the flap may be used in conjunction with this flap arrangement to overcome the overbalance of the flap (reference 3). Such an unbalancing tab will increase the lift effectiveness of the flap, with the result that the deflection required to obtain a given increment of lift will not be so great as that for a conventional flap of the same chord. Because $c_{h_{f\alpha}}$ is positive, the flap will float against the relative wind, a fact that should cause the static stability of the airplane with controls free to exceed that with controls fixed.

Rudders with a large positive value of $c_{h_{\alpha}}$ and considerable frictional damping have been reported to cause undesirable flying qualities on a number of airplanes having small directional stability. These airplanes showed a tendency to oscillate in yaw but the undesirable characteristic has been corrected by making $c_{h_{\alpha}}$ and $c_{h_{\delta_f}}$ more negative. Flight tests of one airplane at Langley Memorial Aeronautical Laboratory in which the rudder had a positive value of $c_{h_{\alpha}}$ and the airplane had a large amount of directional stability indicated that the behavior of the airplane was satisfactory. A theoretical analysis currently being made at the Laboratory shows that a positive value of $c_{h_{\alpha}}$ is desirable provided that other factors are properly controlled.

Pitching Moments

The values of the parameters $\left(\frac{\partial c_m}{\partial c_l}\right)_{\alpha_0}$ and $\left(\frac{\partial c_m}{\partial c_l}\right)_{\delta_f}$ listed in table III indicate the position of the aerodynamic center of the airfoil. When the lift is varied by changing the angle of attack, at a flap deflection of 0°

the aerodynamic center of the airfoil is at the 0.235c point for both flap-nose shapes with the gap sealed and at the 0.235c point for both flap-nose shapes with the 0.005c gap. When the lift is varied by changing flap deflection, at an angle of attack of 0° , the aerodynamic center is at the 0.41c point for both nose shapes with gap sealed and at the 0.42c point for both nose shapes with the 0.005c gap. The positions of the aerodynamic center for the present tests are in good agreement with those for the airfoil with plain flap (reference 7). The position of the aerodynamic center for the flap deflected is a function of aspect ratio (reference 1) and will move toward the trailing edge as the aspect ratio is decreased.

Drag

The measured values of drag cannot be considered absolute because of a relatively large unknown tunnel correction. The increments of profile-drag coefficient caused by flap deflection (fig. 4), however, should be independent of tunnel effect. The medium-nose flap gave an increase in minimum profile-drag coefficient of about 0.0022 over that of the plain flap on the same airfoil (reference 7). With the blunt-nose flap the increase was within the experimental accuracy of the tests.

Tab Characteristics

In general, the tab characteristics for the balanced flap are similar to those for a tab on the plain flap (reference 7). At a flap deflection of 0° , the effectiveness of the tab in changing the flap hinge-moment coefficients was greatest when the tab was deflected in conjunction with the angle of attack. This result is opposite to that for a tab of the same size on an NACA 0009 airfoil, for which the effectiveness of the tab was greatest when the tab deflection and the angle of attack were in opposition. As previously discussed, the overbalance of the flap that occurred when the large overhang was used on the flap may be overcome by the use of a differentially operated unbalancing tab deflected in the same direction as the flap.

Balancing Effectiveness of Various Overhangs

The values of the hinge-moment parameters for blunt-

L-376

nose flaps on the NACA 0009 and NACA 0015 airfoils are presented as a function of aerodynamic balance in figure 7. The data are summarized from the investigations reported in references 2 to 8, with the exclusion of reference 6, which does not deal with overhanging balances. The unsealed gap was 0.005c in all cases except that it was 0.0015c for the largest overhang on the NACA 0009 airfoil. The plain unbalanced flap, because it is hinged at the center of its nose radius, has an overhang. This overhang, however, can contribute no balancing effect because all forces normal to the surface of the overhang act through the hinge axis.

Figure 7 shows that, for both airfoils, the hinge moments of a balanced flap were reduced by unsealing the gap. The rate of change of hinge-moment parameters with increasing aerodynamic balance was greater for the thinner airfoil than for the thicker airfoil. On both airfoils, the flap with 0.35c_f overhang did not produce overbalance, but with 0.50c_f overhang the flap was overbalanced. The parameter $c_{f\alpha}$ became positive with a 0.35c_f overhang on the thicker airfoil but, on the thinner airfoil, a 0.50c_f overhang was required to produce a similar effect.

CONCLUSIONS

The results of the tests of the NACA 0015 airfoil with a balanced flap having a chord 30 percent of the airfoil chord and a flap-nose overhang 50 percent of the flap chord compared with the results of previous tests of a similar flap on the NACA 0009 airfoil indicate the following conclusions:

1. The slope of the lift curve for the NACA 0015 airfoil was slightly less than that for the NACA 0009 airfoil and decreased when the gap at the flap nose was unsealed.
2. The lift effectiveness of the flap with large balance on the NACA 0015 airfoil was practically the same as that of the plain flap on the same airfoil and as that of the similar flap on the NACA 0009 airfoil.
3. The blunt-nose balance was more effective in reducing flap hinge moments and caused greater overbalance than the medium-nose balance, but the effectiveness of the

blunt-nose balance was not maintained to so high a flap deflection when the flap was deflected in conjunction with the angle of attack as that of the medium-nose balance.

4. The medium-nose flap caused an increase in minimum profile-drag coefficient of 0.0022 over that of the airfoil with plain flap, whereas the blunt-nose flap gave no measurable increase.

5. The tab, when deflected in conjunction with the angle of attack, gave greater increments of lift and flap hinge-moment coefficients per unit tab deflection than when deflected in opposition to the angle of attack.

Langley Memorial Aeronautical Laboratory,
National Advisory Committee for Aeronautics,
Langley Field, Va.

REFERENCES

1. Anes, Milton B., Jr., and Sears, Richard I.: Determination of Control-Surface Characteristics from NACA Plain-Flap and Tab Data. Rep. No. 721, NACA, 1941.
2. Sears, Richard I.: Wind-Tunnel Investigation of Control-Surface Characteristics. I - Effect of Gap on the Aerodynamic Characteristics of an NACA 0009 Airfoil with a 30-Percent-Chord Plain Flap. NACA A.R.R., June 1941.
3. Sears, Richard I., and Hoggard, H. Page, Jr.: Wind-Tunnel Investigation of Control-Surface Characteristics. II - A Large Aerodynamic Balance of Various Nose Shapes with a 30-Percent-Chord Flap on an NACA 0009 Airfoil. NACA A.R.R., Aug. 1941.
4. Anes, Milton B., Jr.: Wind-Tunnel Investigation of Control-Surface Characteristics. III - A Small Aerodynamic Balance of Various Nose Shapes Used with a 30-Percent-Chord Flap on an NACA 0009 Airfoil. NACA A.R.R., Aug. 1941.

L-378

5. Ames, Milton B., Jr., and Eastman, Donald R., Jr.:
Wind-Tunnel Investigation of Control-Surface Characteristics. IV - A Medium Aerodynamic Balance of Various Nose Shapes Used with a 30-Percent-Chord Flap on an NACA 0009 Airfoil. NACA A.R.R., Sept. 1941.
6. Jones, Robert T., and Ames, Milton B., Jr.: Wind-Tunnel Investigation of Control-Surface Characteristics. V - The Use of a Beveled Trailing Edge to Reduce the Hinge Moment of a Control Surface. NACA A.R.R., March 1942.
7. Sears, Richard I., and Liddell, Robert B.: Wind-Tunnel Investigation of Control-Surface Characteristics. VI - A 30-Percent-Chord Plain Flap on the NACA 0015 Airfoil. NACA A.R.R., June 1942.
8. Sears, Richard I., and Hoggard, H. Page, Jr.: Wind-Tunnel Investigation of Control-Surface Characteristics. VII - A Medium Aerodynamic Balance of Two Nose Shapes Used with a 30-Percent-Chord Flap on an NACA 0015 Airfoil. NACA A.R.R., July 1942.
9. Wenzinger, Carl J., and Harris, Thomas A.: The Vertical Wind Tunnel of the National Advisory Committee for Aeronautics. Rep. No. 387, NACA, 1931.

L-378

NACA

14

Table I.- Ordinates for NACA 0015 airfoil. [Stations and ordinates in percent of airfoil chord]

Station	Upper surface	Lower surface
0	0	0
1.25	2.37	-2.37
2.5	3.27	-3.27
5	4.44	-4.44
7.5	5.25	-5.25
10	5.85	-5.85
15	6.68	-6.68
20	7.17	-7.17
25	7.43	-7.43
30	7.50	-7.50
40	7.25	-7.25
50	6.62	-6.62
60	5.70	-5.70
70	4.58	-4.58
80	3.28	-3.28
90	1.81	-1.81
95	1.01	-1.01
100	(.16)	(-.16)
100	0	0
L. E. radius:		2.48

Table II.- Stations and ordinates for medium-nose 0.50c_f overhang.

Station (percent c)	Ordinate (percent c)
0	0
.35	1.41
.86	2.10
1.87	2.80
2.88	3.26
3.89	3.58
4.90	3.83
5.91	4.03
6.92	4.20
7.93	4.33
8.94	4.42
9.95	4.49
10.96	4.52
11.97	4.54
12.98	4.53
13.99	4.51
15.00	4.46
16.51	4.34
17.52	4.24
19.17	4.04
Fair to NACA 0015 profile to trailing edge	
Nose radius = 2.96 percent c	

Table III.- Parameter values for a 0.30c flap with a 0.50c_f overhang on an NACA 0015 airfoil.

Parameters	Blunt nose shape		Medium nose shape	
	Gap sealed	Gap 0.005c	Gap sealed	Gap 0.005c
$\left(\frac{\partial c_l}{\partial \alpha_o}\right)_{\delta_f, \delta_t}$	0.095	0.085	0.095	0.085
$\left(\frac{\partial c_l}{\partial \delta_f}\right)_{\alpha_o, \delta_t}$	-.58	-.65	-.54	-.48
$\left(\frac{\partial c_{mf}}{\partial \alpha_o}\right)_{\delta_f, \delta_t}$	0	.0045	.0005	.0021
$\left(\frac{\partial c_{mf}}{\partial \delta_f}\right)_{\alpha_o, \delta_t}$	0	.0033	-.0032	-.0030
$\left(\frac{\partial c_m}{\partial c_l}\right)_{\delta_f, \delta_t}$.015	.027	.014	.024
$\left(\frac{\partial c_m}{\partial c_l}\right)_{\alpha_o, \delta_t}$	-.160	-.165	-.157	-.177

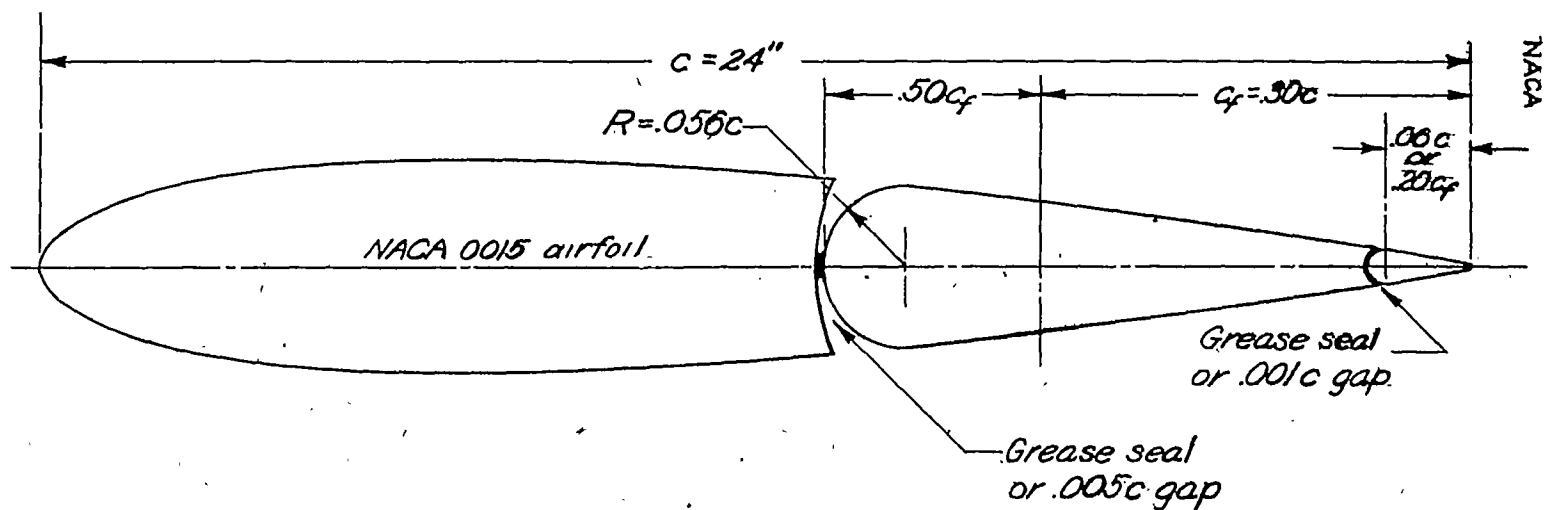

Blunt nose

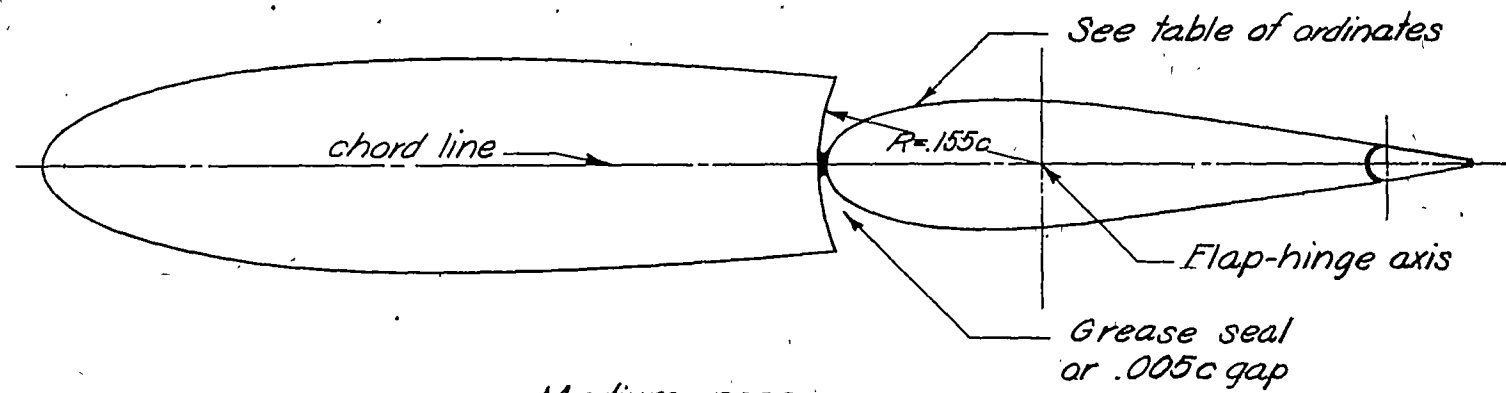

Medium nose

NATIONAL ADVISORY
COMMITTEE FOR AERONAUTICS

Figure 1. - Nose shapes for a $0.30c$ flap with $0.50c_f$ overhang on an NACA 0015 airfoil.

L-378

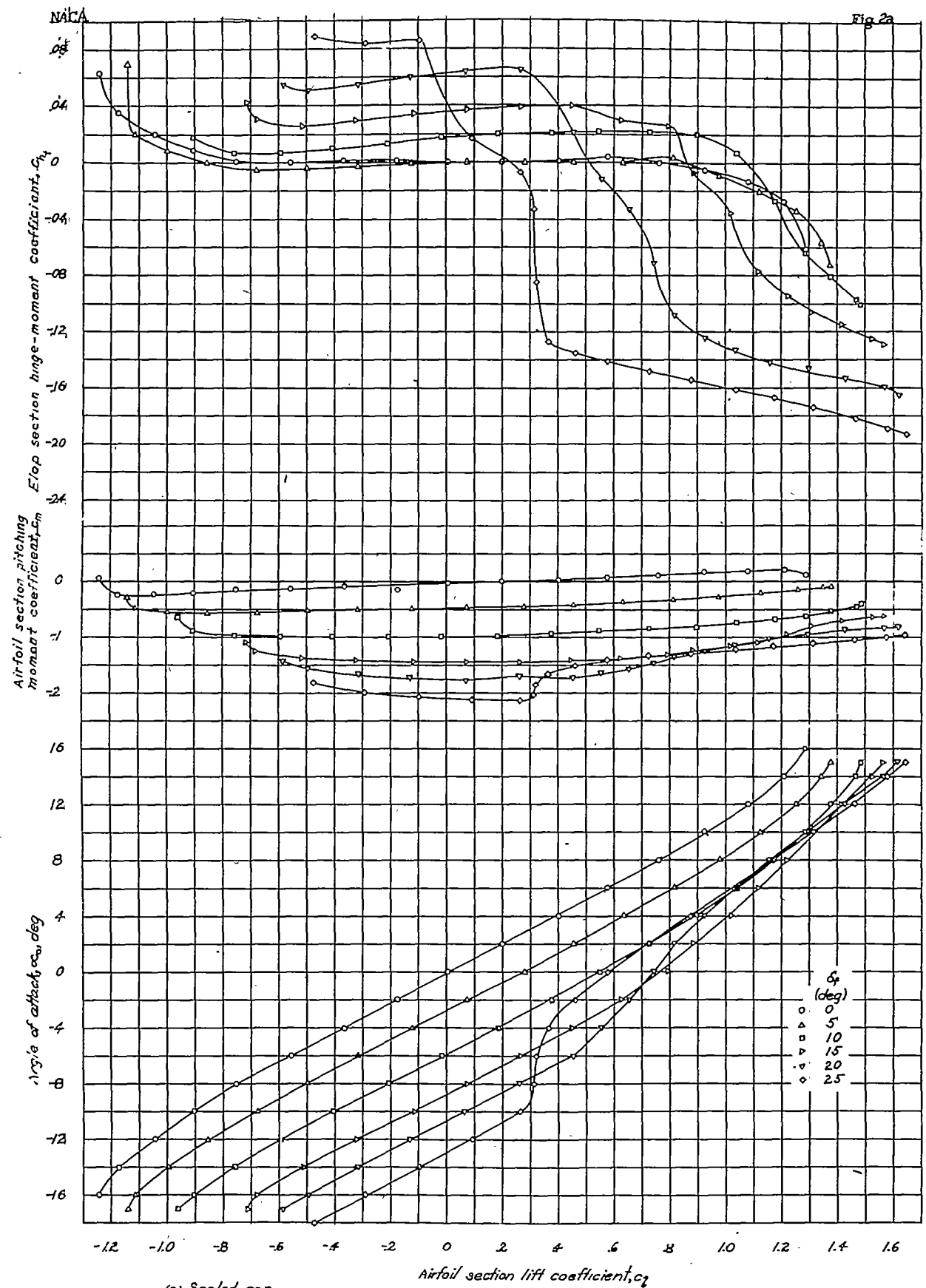

(a) Sealed gap
 Figure 2.- Section aerodynamic characteristics of an NACA 0015 airfoil with a 0.30c flap having a 0.50c overhang with blunt nose.

L-378

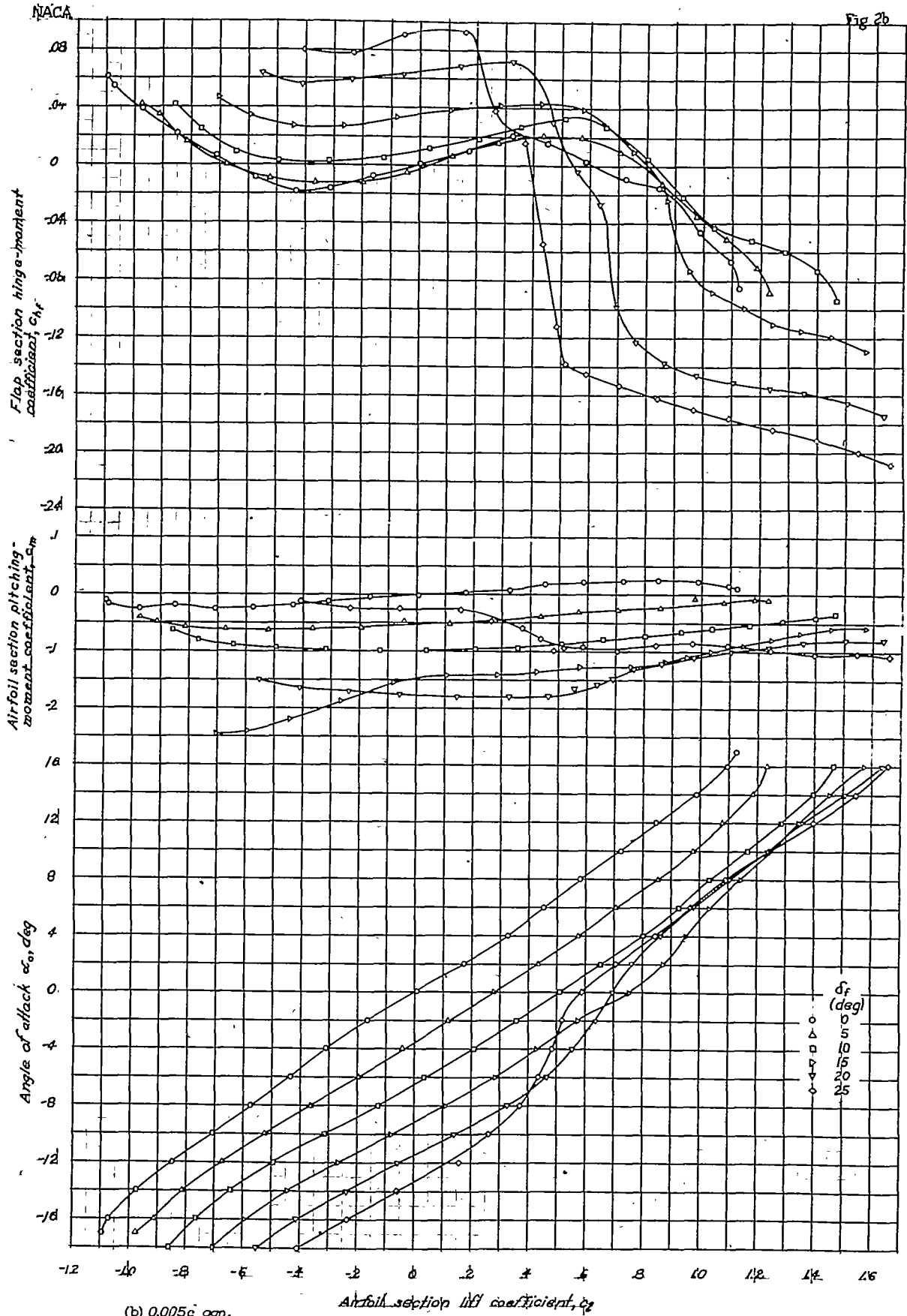

(b) 0.005c gap.
 Figure 2.-Concluded.

L-378

Fig. 3a

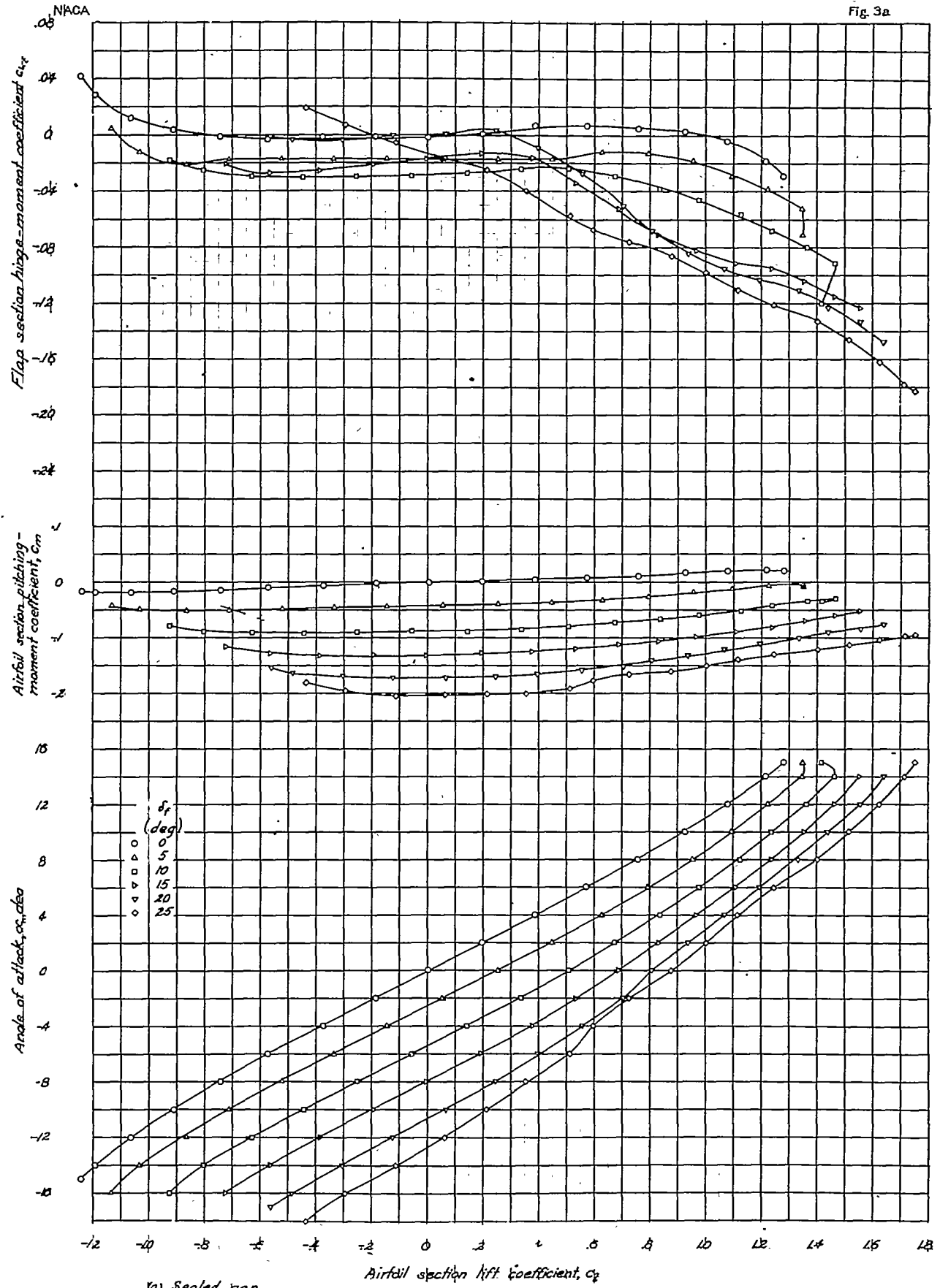

(a) Sealed gap.
 Figure 3.- Section aerodynamic characteristics of a NACA 0015 airfoil with a 0.30c flap having a 0.50 c_f overhang with medium nose.

L-378

Fig. 3b

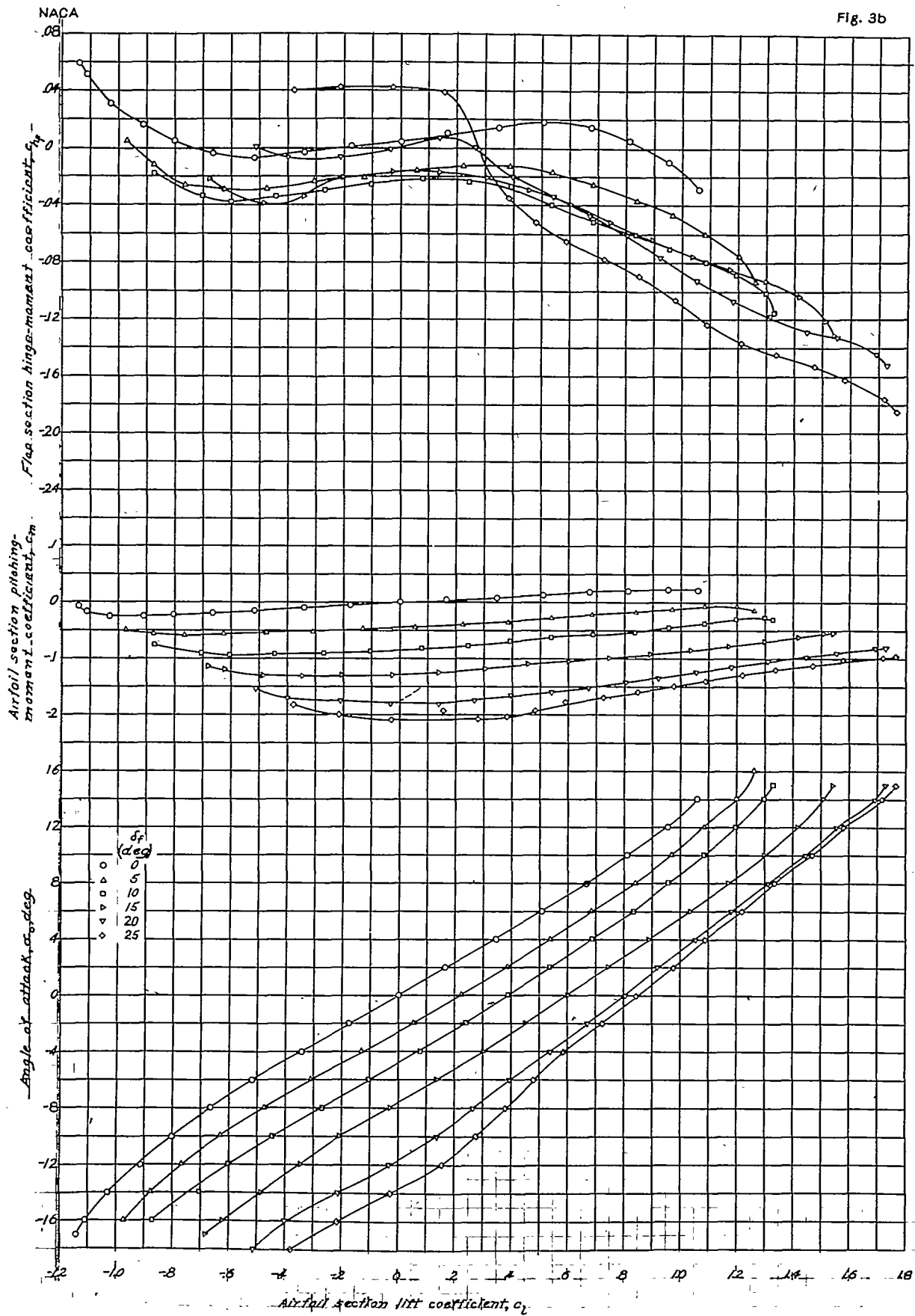

(b) 0.005° gap
 Figure 3. - Concluded.

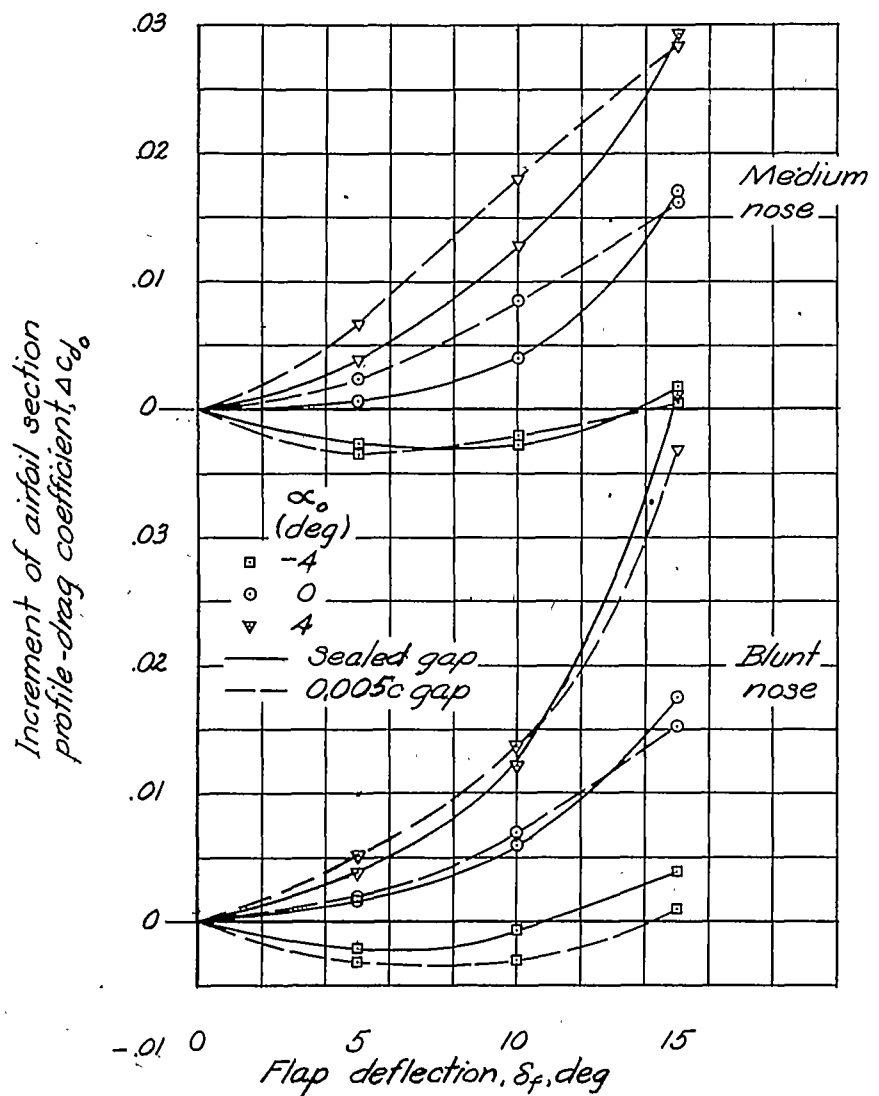

Figure 4.-Increment of airfoil section profile-drag coefficient caused by deflection of a 0.30c flap with 0.50c overhang with blunt and medium nose and with sealed and 0.005c gap.

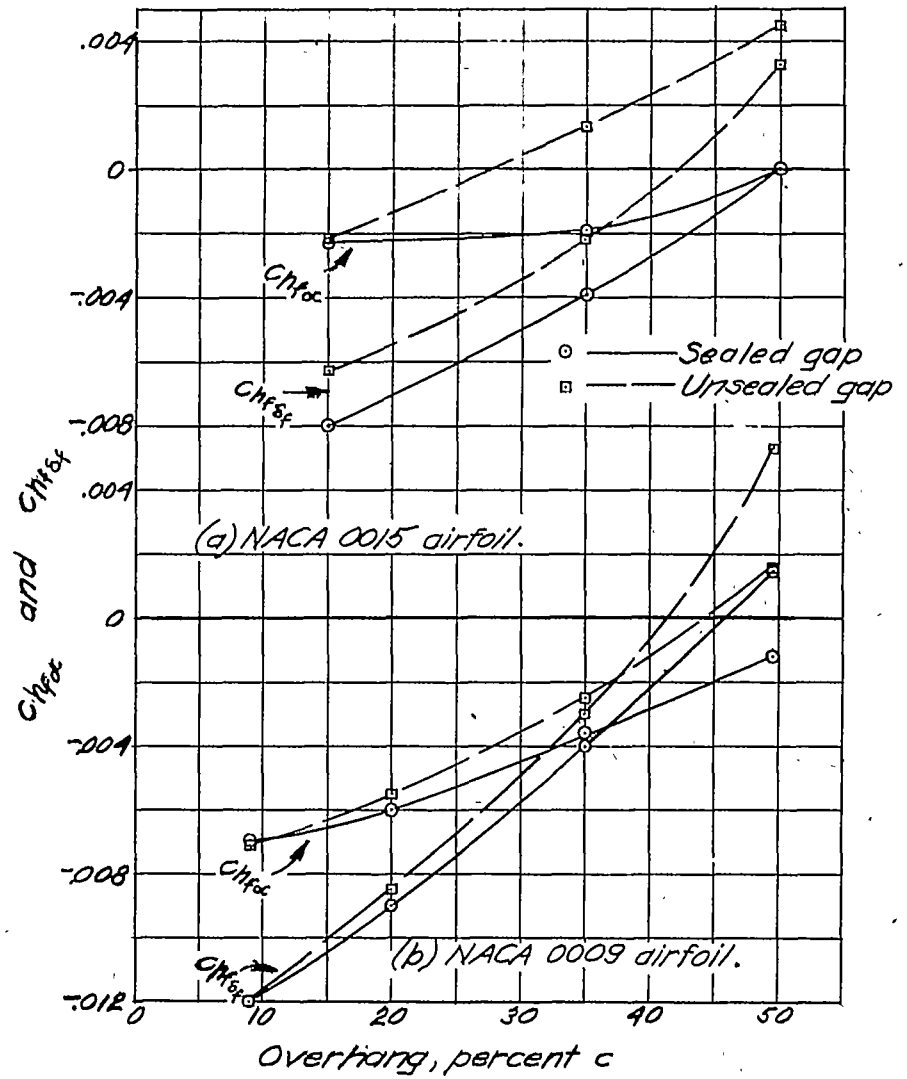

Figure 7.-Variation of hinge-moment parameters with aerodynamic balance as measured on two airfoils in two-dimensional flow. Blunt nose balance on 0.30c flap.

NACA

Figs. 4,7

L-378

NACA

Fig. 5

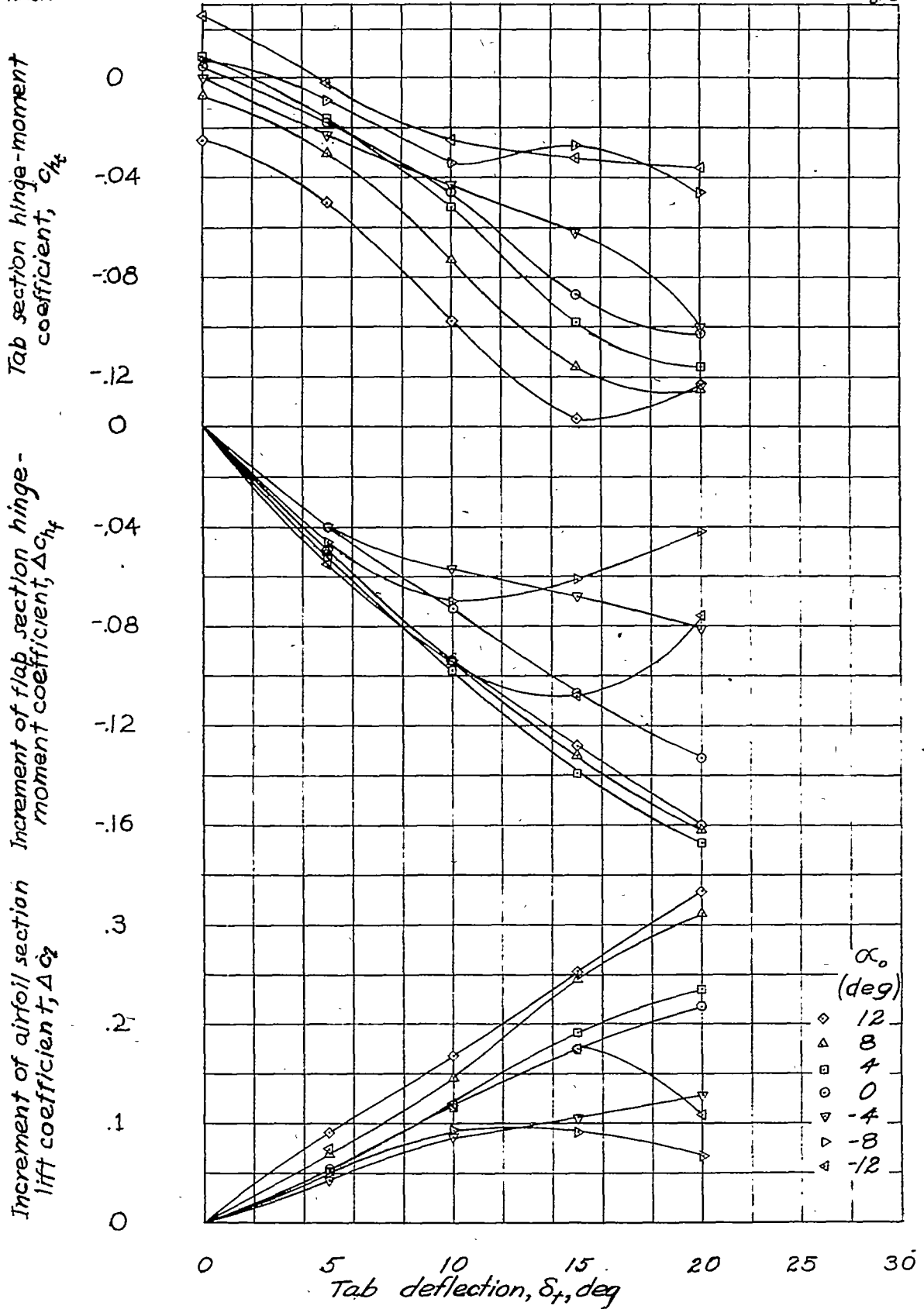

Figure 5.- Tab section hinge-moment coefficient and increments of airfoil section lift coefficient and flap section hinge-moment coefficient caused by deflection of a $0.230c_f$ plain tab. Blunt nose $0.50c_f$ overhang with $0.005c$ flap gap and $0.001c$ tab gap. $\delta_f = 0^\circ$.

L-378

NACA

Fig. 6

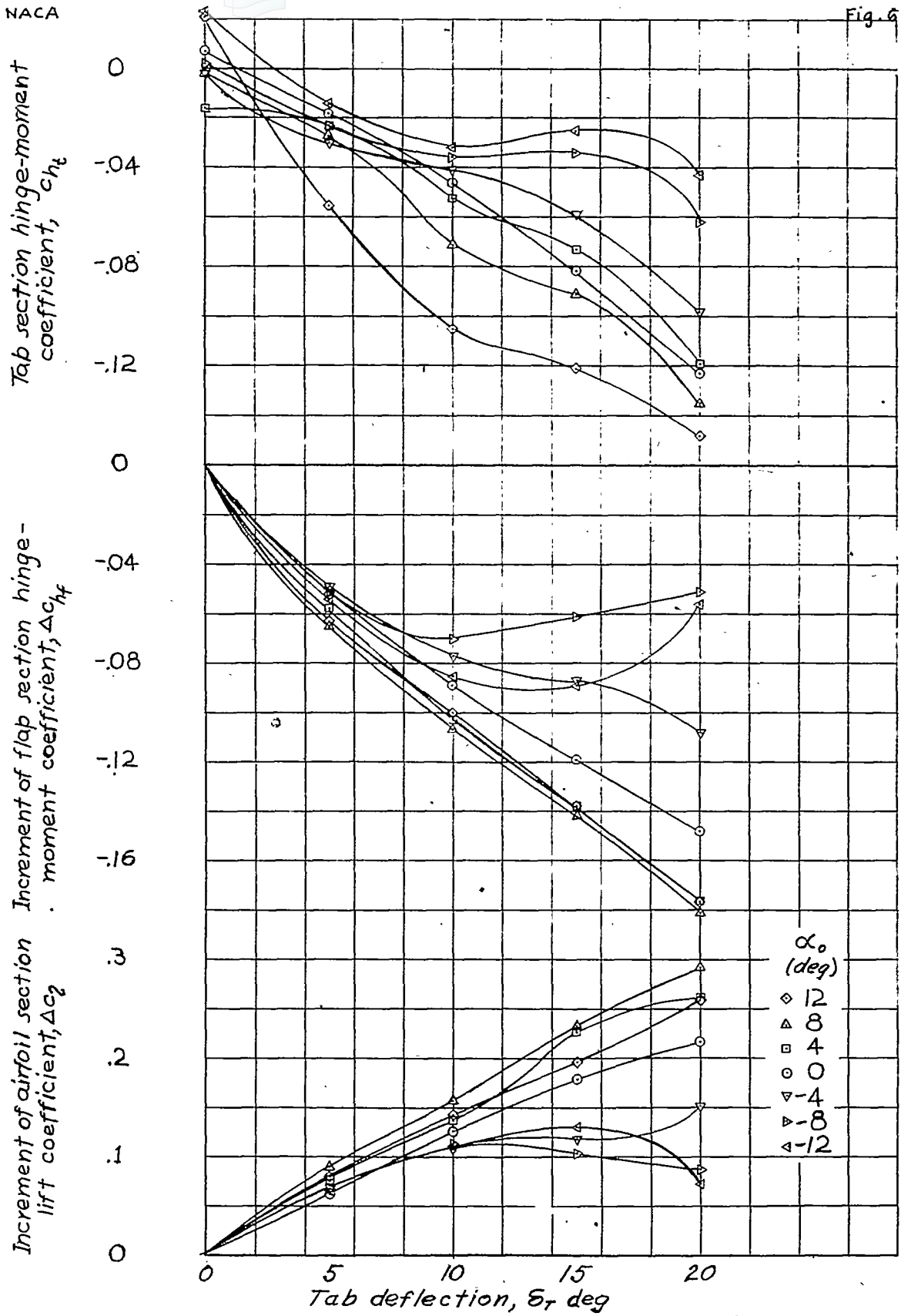

Figure 6.- Tab section hinge-moment coefficient and increments of airfoil section lift coefficient and flap section hinge-moment coefficient caused by deflection of a $0.20c_f$ plain tab. Medium nose $0.50c_f$ overhang with $0.005c$ flap gap and $0.001c$ tab gap. $\delta_f = 0^\circ$.