

(NASA-CR-112236) ADHESIVE-BONDED
SINGLE-LAP JOINTS (Douglas Aircraft Co.,
Inc.) 123 p HC SR 25 CSCL 13D N74-13196
G3/15 Unclas
23756

NASA CR 112236

ADHESIVE-BONDED SINGLE-LAP JOINTS

TECHNICAL REPORT

by

L. J. HART-SMITH

Prepared under Contract NAS1-11234
Douglas Aircraft Company
McDonnell Douglas Corporation
3855 Lakewood Blvd
Long Beach, California 90846

JANUARY 1973

for

Langley Research Center
Hampton, Virginia 23366

NATIONAL AERONAUTICS AND SPACE ADMINISTRATION

ABSTRACT

Explicit analytical solutions are derived for the static load-carrying capacity of single-lap adhesive-bonded joints. A purely-elastic analysis represents a considerable improvement over the classical solution by Goland and Reissner. Also, the quantitative influence of adhesive plasticity in shear is established. This beneficial influence is shown to be capable of explaining the premature failure predictions by elastic analyses. Yielding of metal adherends at the ends of the joint as the result of the eccentric load path is shown usually to be the factor initiating failure for all but very short overlaps. In the case of filamentary composite adherends, fracture of those 0° filaments closest to the bond usually initiates an interlaminar shear failure within the laminates. For thicker adherends, the dominant failure mode is shown to be that of peel stresses in the adhesive and the associated interlaminar tension stresses in filamentary composite adherends. The quantitative effects of adherend stiffness imbalance are accounted for in this investigation.

KEYWORD DESCRIPTORS

Bonded Joints	Single-Lap Joints
Adhesive Stresses and Strains	Static Strength
Adherend Thermal Mismatch	Elastic-Plastic Formulation
Adherend Stiffness Imbalance	Adhesive Shear Stresses
Adhesive Peel Stresses	Advanced Composite Joints
Eccentric Load Path	Low Structural Efficiency

PRECEDING PAGE BLANK NOT FILMED

FOREWORD

This report was prepared by the Douglas Aircraft Company, McDonnell Douglas Corporation, Long Beach, California under the terms of Contract NAS1-11234. One summary report (NASA CR 2218) and four technical reports (NASA CR 112235, -6, -7, and -8) cover the work, which was performed between November 1971 and January 1973. The program was sponsored by the National Aeronautics and Space Administration's Langley Research Center, Hampton, Virginia. Dr. M. F. Card and Mr. H. G. Bush were the Contracting Agency's Technical Monitors.

The basic concept of bonded joint shear analysis by classical mechanics of continuous structures in terms of the elastic-plastic adhesive model was developed initially under Douglas Irad funding between 1968 and 1970. This contract has permitted the work to be expanded greatly in both scope and detail. All of the peel-stress studies were performed under this contract.

REMOVING PAGE BLANK NOT RECOMMENDED

CONTENTS

Section	Page
Symbols	xi
Summary	1
1. Introduction	3
2. Balanced Single-Lap Joints (Elastic Analysis)	7
Discussion of Goland and Reissner Analysis	15
3. Adherend Stress Distribution due to Eccentricity in Load Path	19
4. Adhesive Shear Stress Distributions for Balanced Adherends (Elastic-Plastic Analysis)	21
5. Adhesive Peel Stress Distributions for Balanced Adherends	29
6. Joint Efficiencies for Balanced Single-Lap Joints	35
7. Effect of Adherend Stiffness Imbalance on Adherend Failures just Outside the Joint	37
8. Effect of Adherend Stiffness Imbalance on Peel (Interlaminar Tension) Failures at End of Joint	47
9. Effect of Thermal Mismatch Between Adherends	53
10. Parametric Effects	55
11. Joint Efficiency Charts for Single-Lap Joints	59
12. The Standard Half-Inch Single-Lap Joint Test	61
13. Conclusions	65
References	67
Table	69
Illustrations	71
Appendix (Computer Program A4EA for Strengths of Single-Lap Adhesive- Bonded Joints)	105

ILLUSTRATIONS

Figure	Page
1. Failure of Single-Lap Bonded Joints with Brittle and with Yielding Adherends	71
2. Co-ordinate System and Deformations in Balanced Single-Lap Bonded Joints	72
3. Comparison Between Present Solution for Adherend Stresses and that of Goland and Reissner	73
4. Explanation of Fallacy in Goland and Reissner Analysis	74
5. Adherend Limit Loads for Balanced Single-Lap Joints	75
6. Influence of Ply Stacking Sequence in Composite Laminates on Adherend Bending Strength of Balanced Single-Lap Joints	76
7. Geometry, Nomenclature and Mathematical Model for Analysis of Unbalanced Single-Lap Joints	77
8. Influence of Adherend Properties on Shear Strength of Single-Lap Bonded Joints	78
9. Influence of Adhesive Properties on Shear Strength of Single-Lap Bonded Joints	79
10. Non-Dimensionalized Adhesive Bond Shear Strengths of Single-Lap Bonded Joints (Eccentricity Parameter = 0.00001)	80
11. Non-Dimensionalized Adhesive Bond Shear Strengths of Single-Lap Bonded Joints (Eccentricity Parameter = 0.0001)	81
12. Non-Dimensionalized Adhesive Bond Shear Strengths of Single-Lap Bonded Joints (Eccentricity Parameter = 0.001)	82
13. Non-Dimensionalized Adhesive Bond Shear Strengths of Single-Lap Bonded Joints (Eccentricity Parameter = 0.01)	83
14. Non-Dimensionalized Adhesive Bond Shear Strengths of Single-Lap Bonded Joints (Eccentricity Parameter = 0.1)	84
15. Non-Dimensionalized Adhesive Bond Shear Strengths of Single-Lap Bonded Joints (Eccentricity Parameter = 1.0)	85

16. Peel Stresses in Balanced Single-Lap Joints	86
17. Joint Efficiency Chart for Single-Lap Metal Joints	87
18. Joint Efficiency Chart for Single-Lap Metal Joints	88
19. Joint Efficiency Chart for Single-Lap Composite Joints	89
20. Joint Efficiency Chart for Single-Lap Composite Joints	90
21. Joint Efficiency Chart for Single-Lap Composite Joints	91
22. Joint Efficiency Chart for Single-Lap Composite Joints	92
23. Joint Efficiency Chart for Single-Lap Composite Joints	93
24. Joint Efficiency Chart for Single-Lap Composite Joints	94
25. Reduction in Inefficiency of Unsupported Single-Lap Joints	95
26. Co-ordinate System for Unbalanced Single-Lap Joints	96
27. Effect of Adherend Stiffness Imbalance on Adherend Bending Strength of Single-Lap Bonded Joints	97
28. Effect of Fiber Stacking Sequence on Adherend Bending Strength of Unbalanced Composite Single-Lap Joints	98
29. Effect of Adherend Stiffness Imbalance on Peel Stresses in Single-Lap Bonded Joints	99
30. Effect of Adherend Thermal Mismatch on Single-Lap Bonded Joints	100
31. Comparison of Adhesive and Adherend Strengths for Single-Lap Bonded Joints	101
32. Formation of Plastic Hinges due to Eccentric Load Path for Single-Lap Bonded Joints	102
33. Influence of Adherend Material on Single-Lap Bonded Joints	103
34. Joint Strength of Composite Single-Lap Adhesive-Bonded Joints, Showing Interaction of Three Failure Modes	104

SYMBOLS

- A,B,C,F = Integration constants
- c = Half length of overlap (in.)
- D = Flexural rigidity of adherends (lb in.²)
- d = Length of elastic zone in adhesive bond (in.)
- E = Young's modulus (longitudinal) for adherend (psi)
- E_c, E_c' = Adhesive peel (transverse tension) moduli (psi)
- e = Eccentricity (in.)
- G = Adhesive shear modulus (psi)
- K = Coefficient [see Equation (71)]
- k = Eccentricity factor [see Equation (39)]
- k_b = $D / [Et^3 / 12(1 - \nu^2)]$ = bending stiffness parameter for filamentary composite adherends
- l = Overlap (length of bond) (in.)
- l_1, l_4 = Length of adherends outside the joint (in.)
- M = Bending moment in adherend (lb in. / in.)
- M_0 = Bending moment in adherend at end of overlap (lb in. / in.)
- P = Applied load on joint (lb)
- s = Co-ordinate aligned along load path (different origin from x)
- T = Direct stress resultants in adherend(s) (lb / in.)
- t = Thickness of adherend (in.)
- u = Axial displacement in adherend adjacent to bond (in.)
- V = Transverse shear force on adherend (lb / in.)
- w = Transverse displacement of adherend under eccentric load (in.)
- x = Axial (longitudinal) co-ordinate aligned along load path

- γ = Adhesive shear strain
- γ_e = Elastic adhesive shear strain
- γ_p = Plastic adhesive shear strain
- z = Axial co-ordinate (different origin from x)
- η = Thickness of adhesive layer (in.)
- λ, λ' = Exponents of elastic shear stress distribution (in.⁻¹)
- ν = Poisson's ratio for adherends
- ξ = Exponent of bending stress distribution in adherend (in.⁻¹)
- σ_{av} = (P/t) = Average adherend stress (psi)
- σ_{max} = Maximum adherend stress (resultant of direct and bending loads) (psi)
- σ_p, σ_c = Peel stresses in adhesive (psi)
- σ_y = Yield stress of adherend (psi)
- τ, τ_a = Adhesive shear stress (psi)
- τ_{av} = Average adhesive shear stress (psi)
- τ_p = Plastic adhesive shear stress (psi)
- χ = Peel stress distribution exponent (in.⁻¹)

SUBSCRIPTS

- a, c = Adhesive (cement)
- n = Property normal to plane of adherends (e.g. E_n = transverse modulus of adherend)
- $\left. \begin{array}{l} 1, 2, 3 \\ 4, 5 \end{array} \right\}$ = Different regions of the adherends in single-lap joint

SUMMARY

This report presents analyses of the influence of a variety of factors on the strength of adhesive-bonded single-lap joints. The classical approach of Goland and Reissner is improved and extended. A deficiency in their determination of the critical bending moment in the adherends at the ends of the overlap is overcome. Additional factors included in the analyses are adhesive plasticity (in terms of the Douglas elastic-plastic approach), stiffness imbalance between the adherends, and the influence of laminated filamentary composite adherends (as distinct from isotropic metal adherends).

Three distinct and characteristic failure modes are predicted. The first is that of failure of the adherend just outside the joint due to the in-plane stresses resulting from the combination of direct load stresses and bending stresses resulting from the eccentricity in the load path. While necessarily less than 100 percent efficient, this first mode is the strongest of the three. The second mode is the failure of the adhesive layer in shear. While prior elastic studies have concentrated on this failure mode and much of the single-lap joint design practice is so oriented, the inclusion of adhesive plasticity in the analysis has demonstrated that this potential failure mode is extremely rare in structural practice. The third failure mode may be manifest in either of two forms and is associated with the adhesive peel stresses. With metal adherends which are too thick to yield in bending under the eccentric load path, the observed failure in the third mode is that of the adhesive peel stress. With filamentary composite adherends, on the other hand, the interlaminar tension strength is so much less than the peel strength of good structural adhesives that the failure occurs within the continuous laminate at the end(s) of the joint.

Adherend thermal mismatch is discussed only qualitatively but the effects of adherend stiffness imbalance on the joint strength are characterized quantitatively. Any adherend imbalance is shown to effect significant strength reductions down to a weaker joint than could be formed with two adherends each identical with the weaker adherend of the unbalanced joint.

Several digital computer programs have been prepared for the iterative solution of the mathematical equations derived. The need for iteration arises because account is taken of the significant bending moment relief associated with structural (elastic) deformations under load.

The standard half-inch lap shear test is discussed. The failure observed is only infrequently associated with failure of the adhesive in shear. Therefore a case is presented for restricting this test to quality control work, for which it is ideally suited, and for not using the values so generated for design purposes.

Because of the eccentricity in the load path, the structural efficiency must inevitably be less than unity. The analyses show the desirability of employing far larger l/t ratios than are needed for load transfer alone in order to improve the efficiency of the entire structure while suffering only a small weight penalty locally at the joints.

1. INTRODUCTION

Numerous theoretical analyses of the mechanics of single-lap adhesive-bonded joints have been made since the original paper by Goland and Reissner (Reference 1) in 1944 accounting for the eccentricity in the load path. Hahn (References 2, 3 and 4) has extended their analysis to dissimilar adherends. Kuenzi and Stevens (Reference 5) used the analysis of Goland and Reissner to illustrate the different behavior of "stiff" and "soft" adhesives in joints while Kutscha and Hofer (Reference 6) have programmed the Goland and Reissner analysis for a digital computer and depicted extensive parametric studies on purely elastic joints. A comprehensive survey and review has been prepared by Kutscha (Reference 7) in 1964.

Some qualitative understanding of the problem has been achieved in the works reported above but an unappreciated deficiency in the determination by Goland and Reissner of the bending moment in the adherend at the end of the joint has been perpetuated ever since. The quantitative significance of these analyses is therefore in doubt, particularly since no allowance has been made for adhesive plasticity either.

Two recent major research investigations into adhesive-bonded joints have included the single-lap joint amongst the geometries analyzed. Both the work of Grimes, Wah, et al (Reference 8) and Dickson, Hsu, and McKinney (Reference 9) have concentrated on filamentary composite adherends. Each team included variation of stresses through the thickness of the adherends in their formulations and, thereby, accounted for effects not considered here. On the other hand, the inclusion of so many other factors prevented such a simple comprehensive accounting of the effects of adhesive plasticity as is derived herein. Furthermore, each omitted to account for the significant stress concentration relief afforded by transverse deflections under load (geometric non-linearities). Both attempted to utilize a continuous Ramberg-Osgood representation of the adhesive properties (which would be more precise than that used here) and neither attained that goal. A piecewise linear solution was obtained in Reference 8, by iteration, through breaking up the length of the joint into a number of segments. In reference 9, the empirical "plastic-zone" approach

attributed to Goodwin (Reference 10) was used to extend the closed-form elastic analysis procedure to include joints with inelastic adhesive stress-strain behavior in shear. Both investigations confirmed the importance of including adhesive plasticity in the analysis. Reference 9 established, on the basis of specific cases analyzed, that interlaminar shear deformation in filamentary composites does not have a major effect on the predicted joint strength but that the interlaminar tension does affect the adhesive shear stress distribution. The authors of Reference 9 expressed surprise at the important role of variation of transverse tension through the thickness of the joint but this is a necessary consequence of allowing the adhesive shear stress to decrease to zero at the ends of the joint, as can be appreciated by examination of the normal and shear stresses on a differential element of the adhesive layer.

In comparing investigations such as References 8 and 9 with the present report it is important to recognize that the basic objectives were different. The objective of the present investigation is a simple rational design technique including only the major joint parameters in the analysis. Here, all effects known (or believed) to be minor have been excluded in order to restrict the amount of data necessary to define a joint. This has led to the generation herein of joint efficiency charts in terms of adherend thickness for a range of overlap-to-thickness ratios for given material combinations. The three major failure modes of bending of the adherend just outside the joint, shearing of the adhesive, and peeling of the adhesive (or laminate by interlaminar tension) have all been accounted for. Perhaps some of the simplifying assumptions here may prove to be excessive and empirical correction factors may need to be developed. Even in this event, however, a sound reference framework has been established for the first time, by identifying the dominant mode of failure for a given material/geometry combination. Certainly, reference to the average shear stress is shown to be unsatisfactory as a basis for design. References 8 and 9 were more specific and detailed in their analyses and significant effort was devoted to reconciling finite-element and analytical solutions. In addition, more emphasis was placed upon precise theory-experiment correlation in those works whereas, here, the approaches of simple upper and lower bounds as well as asymptotic solutions have been employed in the correlation. The different approaches should be regarded as complementary since that adopted here relies on more precise analysis to justify the exclusion of minor effects.

Conversely, the far more extensive parametric studies performed in this investigation serve as a reference to guide more detailed analyses of some particular aspect of bonded joint behavior.

The design of single-lap joints has proceeded essentially independently of the theoretical analyses because of inadequate correlation between theory and experiment and because the analyses have been considered too complicated hitherto. The analytically simpler case of the structurally-superior double-lap joint has been analyzed by the author elsewhere (References 11 and 12), yielding explicit asymptotic solutions simple enough to use for design purposes and it is the intent here to provide comparable information about single-lap joints. It was found in Reference 11 that the single factor most responsible for the adequate agreement achieved between theory and experiment was the consideration of adhesive plasticity. Also, the locked-in pre-strains arising from thermal incompatibility of dissimilar materials in the adherends were found to have a significant effect. Likewise, adherend stiffness imbalance accentuates the adhesive stress and strain concentrations at one end of the joint, leading to reduced efficiencies in comparison with balanced adherends. In the case of single-lap joints, analyzed here, the eccentricity in the load path and the consequent transverse deflections under load dominate the behavior of such joints. The adhesive shear properties prove to have very little to do with the strength of single-lap joints, the failure of which is governed largely by adherend properties and peel stresses. In contrast with the minimal effect of lap length on the strength of practical double-lap joints, lap length is a powerful influence on the adherend strength of single-lap joints. Unfortunately, the lap lengths needed to develop peak efficiency are so great as to impose a significant weight penalty for single-lap joints.

Whereas, in a scarf joint between identical adherends, the adhesive shear stress is very nearly uniform along the length of the joint, in a single-lap joint there is a pronounced trough in the shear stress distribution. Most of the load is transferred through the effective end zones, of limited extent, while the bond in the middle is relatively lightly loaded. The elastic-plastic analysis reported herein predicts that the elastic trough is significantly more effective for long-overlap single-lap joints than is the case for double-lap bonded joints (analyzed in Reference 12). The tearing (transverse tension)

stresses also peak at the ends of the joint and usually prove to be more severe than the shear stresses. There are three distinct failure modes possible, each with an associated criterion. For thin adherends, failure is usually caused by exceeding the maximum "fiber" stress, adjacent to the bond at the end of the overlap, under combined direct and bending stresses. The latter arise from the eccentricity in the load path. For short overlaps, it is possible to initiate failure as the result of exceeding the ultimate shear strain in the adhesive at the end of the joint. For relatively thick adherends, failure results from excessive peel stresses induced by the eccentricity in the load path. In such cases, metal adherends are associated with peel failure of the adhesive at the end of the joint while composite adherends usually fail in interlaminar tension because they are weaker than the adjacent adhesive. These phenomena are illustrated in Figure 1.

Single-lap joints are inherently so inefficient that they should not be used without a support to react the eccentricity in the load path. When so supported, their strength is improved dramatically and approaches one half of that of a double-lap joint of twice the thickness in the central adherend. (The factor one half is the direct result of bonding on both sides of the central adherend in a double-lap joint, which gives twice the bond area of the corresponding single-lap joint.)

2. BALANCED SINGLE-LAP JOINTS (ELASTIC ANALYSIS)

The analysis of double-lap joints (Reference 12) involves only extensional deformations of the adherends. Single-lap joints, on the other hand, are subject to transverse deflections of sufficient magnitude to necessitate consideration because of the eccentric load path. The present analysis (and the author's earlier analysis in Reference 13 likewise) is therefore performed in a series of stages, with the final solution obtained by combination.

Figure 2 depicts the geometry and nomenclature for the analysis of a precisely anti-symmetric single-lap joint of identical adherends. In order to include filamentary composite materials in the analysis, the extensional stiffnesses E_t are uncoupled from the bending stiffnesses D through the use of the coefficient

$$k_b = D / [Et^3 / 12(1 - \nu^2)] \quad . \quad (1)$$

For purposes of analysis, the joint is divided into the four sections shown.

Throughout the adherend 1, the longitudinal stress resultant (force per unit lateral width) is uniform, at the value P of the load applied. The stress couple M_1 (inch pound per unit width) is then given by the equilibrium equation

$$M_1 = P \left[\left(\frac{t + \eta}{\ell + c} \right) \frac{x}{2} - w_1 \right] \quad \text{for } 0 \leq x \leq \ell \quad . \quad (2)$$

According to the classical theory for the infinitesimal bending of thin cylindrically deformed plates,

$$\frac{d^2 w_1}{dx^2} = - \frac{M_1}{D} = - \frac{P}{D} \left[\left(\frac{t + \eta}{\ell + c} \right) \frac{x}{2} - w_1 \right] \quad , \quad (3)$$

the solution of which is

$$w_1 = A_1 \cosh(\xi x) + B_1 \sinh(\xi x) + \left(\frac{t + \eta}{\ell + c} \right) \frac{x}{2} \quad , \quad (4)$$

where

$$\xi^2 = P / D \quad (5)$$

and in which the condition $M_1 = 0$ at $x = 0$ requires that

$$A_1 = 0 \quad (6)$$

Turning attention now to regions 2 and 3 (see Figure 2), moment equilibrium requires that

$$\left. \begin{aligned} \frac{dM_2}{ds} - V_2 + \tau \left(\frac{t + \eta}{2} \right) &= 0 \\ \frac{dM_3}{ds} - V_3 + \tau \left(\frac{t + \eta}{2} \right) &= 0 \end{aligned} \right\} \quad (7)$$

while longitudinal force equilibrium requires that

$$\left. \begin{aligned} \frac{dT_2}{ds} + \tau &= 0 \\ \frac{dT_3}{ds} - \tau &= 0 \end{aligned} \right\} \quad (8)$$

and transverse force equilibrium requires that

$$\left. \begin{aligned} \frac{dV_2}{ds} + \sigma_c &= 0 \\ \frac{dV_3}{ds} - \sigma_c &= 0 \end{aligned} \right\} \quad (9)$$

From plate theory, with the sign convention depicted in Figure 2,

$$\left. \begin{aligned} \frac{d^2 w_2}{ds^2} &= - \frac{M_2}{D} \\ \frac{d^2 w_3}{ds^2} &= - \frac{M_3}{D} \end{aligned} \right\} \quad (10)$$

where

$$D = k_b \frac{Et^3}{12(1 - \nu^2)} \quad (11)$$

defines the flexural rigidity of each adherend.

Defining by u_2 and u_3 the longitudinal displacements of the adherends immediately adjacent to the adhesive, the stress-strain relations for plane strain of elastic adherends give

$$\left. \begin{aligned} \frac{du_2}{ds} &= \frac{1}{Et} \left[T_2 + \frac{6(1-\nu^2)M_2}{k_b t} \right] \\ \frac{du_3}{ds} &= \frac{1}{Et} \left[T_3 - \frac{6(1-\nu^2)M_3}{k_b t} \right] \end{aligned} \right\} \quad (12)$$

To obtain the relations for a plane stress condition, the Poisson's ratios are dropped from the above equations and those derived from them hereafter.

The adhesive properties are defined to be linearly elastic in transverse tension and perfectly elastic-plastic in shear between the adherends. Therefore

$$\frac{\sigma_c}{E_c} = \frac{(w_3 - w_2)}{\eta} \quad * \quad (13)$$

and

$$\left. \begin{aligned} \gamma &= \frac{\tau}{G} = \frac{(u_3 - u_2)}{\eta} && \text{for } \gamma \leq \gamma_e \\ \tau &= \tau_p && \text{for } \gamma \geq \gamma_e \end{aligned} \right\} \quad (14)$$

Prior to determining the adhesive shear stress distribution it is shown by the analysis of Goland and Reissner (Reference 1) to be necessary to evaluate M_1 at $x = l$, which must equal M_2 at $s = -c$. Therefore, a differential equation governing w_2 is required. Now,

$$w_2 = [(w_2 + w_3) + (w_2 - w_3)] / 2 \quad , \quad (15)$$

and

* Strictly, the transverse stiffness E_c of the adhesive should be replaced by the effective modulus E_c' reflecting the softening due to the limited transverse stiffness of advanced composite adherends and the thinness of the adhesive layer. This procedure is fully explained in Reference 12 and discussed further in Section 11 here.

$$\frac{d^2 w_2}{ds^2} + \frac{d^2 w_3}{ds^2} = -\frac{1}{D}(M_2 + M_3) \quad , \quad (16)$$

$$\frac{d^3(w_2 + w_3)}{ds^3} = -\frac{1}{D}[V_2 + V_3 - \tau(t + \eta)] \quad , \quad (17)$$

$$\frac{d^4(w_2 + w_3)}{ds^4} = \frac{(t + \eta)}{D} \left(\frac{d\tau}{ds} \right) \quad , \quad (18)$$

while

$$\frac{d^4(w_2 - w_3)}{ds^4} = \frac{\sigma_c}{D} = -\frac{2E_c}{\eta D}(w_2 - w_3) \quad . \quad (19)$$

From equation (14) $(w_3 - w_2)$ is equal to the extremely small differential transverse displacement across the very thin adhesive layer and, therefore, $(w_2 - w_3)$ can justifiably be neglected in comparison with $(w_2 + w_3)$ throughout the joint. There is some uncertainty about the first derivative $d(w_2 - w_3)/ds$ but none about the higher derivatives because, at the ends of the joint ($s = \pm c$),

$$\frac{d^2 w_3}{ds^2} = \frac{d^3 w_3}{ds^3} = 0 \quad \text{at } s = -c \quad \text{and} \quad \frac{d^2 w_2}{ds^2} = \frac{d^3 w_2}{ds^3} = 0 \quad \text{at } s = +c \quad (20)$$

and, therefore, for these higher derivatives it is necessary to set

$$w_2 = [(w_2 + w_3) + (w_2 - w_3)] / 2 \quad (21)$$

while, for w_2 and the first derivative, the approximations

$$w_2 \approx (w_2 + w_3) / 2 \quad , \quad \frac{dw_2}{ds} \approx \frac{1}{2} \frac{d(w_2 + w_3)}{ds} \quad (22)$$

are adopted.

The continued solution of this problem requires the specification of the adhesive elasto-mechanical properties and, for simplicity, a purely elastic adhesive is considered first. (In the next section, it is shown that the assumption of a perfectly plastic adhesive leads to precisely the same result. The validity of the result is then inferred for all intermediate adhesive characteristics.) Starting from equations (12) and (14),

$$\frac{d\tau}{ds} = \frac{G}{\eta} \left[\frac{du_3}{ds} - \frac{du_2}{ds} \right] = \frac{G}{Et\eta} \left[T_3 - T_2 - \frac{6(1-\nu^2)(M_3 + M_2)}{k_b t} \right], \quad (23)$$

$$\frac{d^2\tau}{ds^2} = \frac{G}{Et\eta} \left[2\tau + \frac{6(1-\nu^2)}{k_b} \tau - \frac{6(1-\nu^2)}{k_b} (V_2 + V_3) \right], \quad (24)$$

whence

$$\frac{d^3\tau}{ds^3} = \left(2 + \frac{6(1-\nu^2)}{k_b} \right) \left(\frac{G}{Et\eta} \right) \frac{d\tau}{ds} = \left(1 + \frac{3(1-\nu^2)}{k_b} \right) \lambda^2 \frac{d\tau}{ds}, \quad (25)$$

in which

$$\lambda^2 = 2G / Et\eta. \quad (26)$$

The notation

$$(\lambda')^2 = \left[\frac{1 + 3(1-\nu^2)/k_b}{4} \right] \lambda^2 \quad (27)$$

is conveniently introduced to account for the uncoupling of the extensional and bending stiffnesses of filamentary composite adherends. The parameter λ plays a powerful role in characterizing the adhesive shear stress distributions for double-lap joints and its retention for the single-lap joint analysis provides a meaningful basis for comparison.

The solution of equation (25) is

$$\tau = A_2 \cosh(2\lambda's) + B_2 \sinh(2\lambda's) + C_2 \quad (28)$$

in which the constant B_2 can evidently be set equal to zero because of the precise anti-symmetry of the joint. Gross horizontal equilibrium of the joint requires that

$$P = \int_{-c}^{+c} \tau ds = 2\tau_{av}c = 2 \frac{A_2}{2\lambda'} \sinh(2\lambda'c) + 2C_2c. \quad (29)$$

Now, combining equations (18) and (28),

$$\frac{d^4(w_2 + w_3)}{ds^4} = \frac{(t + \eta)}{D} A_2 (2\lambda') \sinh(2\lambda's), \quad (30)$$

whence

$$\frac{1}{2}(w_2 + w_3) = \frac{(t + \eta)}{2D} \left| \frac{A_2}{8(\lambda')^3} \right| \sinh(2\lambda' s) + A_3 s^3 + B_3 s^2 + C_3 s + F_3 . \quad (31)$$

Again, precise anti-symmetry requires that $B_3 = F_3 \equiv 0$. At the location $x = \ell$, $s = -c$, it is necessary that w_2 and its first two derivatives (with respect to the longitudinal co-ordinate) be continuous. Therefore,

$$\begin{aligned} w_1 &= B_1 \sinh(\xi \ell) + \left(\frac{t + \eta}{\ell + c} \right) \frac{\ell}{2} = w_2 \approx \frac{1}{2}(w_2 + w_3) \\ &= - \frac{(t + \eta)}{2D} \left| \frac{A_2}{8(\lambda')^3} \right| \sinh(2\lambda' c) - A_3 c^3 - C_3 c , \end{aligned} \quad (32)$$

$$\begin{aligned} \frac{dw_1}{dx} &= B_1 \xi \cosh(\xi \ell) + \left(\frac{t + \eta}{\ell + c} \right) \frac{1}{2} = \frac{dw_2}{ds} \approx \frac{1}{2} \left[\frac{d(w_2 + w_3)}{ds} \right] \\ &= \frac{(t + \eta)}{2D} \left| \frac{A_2}{4(\lambda')^2} \right| \cosh(2\lambda' c) + 3A_3 c^2 + C_3 , \end{aligned} \quad (33)$$

$$\begin{aligned} \frac{d^2 w_1}{dx^2} &= B_1 \xi^2 \sinh(\xi \ell) = \frac{d^2 w_2}{ds^2} = \frac{1}{2} \left[\frac{d^2(w_2 + w_3)}{ds^2} + \frac{d^2(w_2 - w_3)}{ds^2} \right] \\ &= - \frac{(t + \eta)}{2D} \left| \frac{A_2}{2\lambda'} \right| \sinh(2\lambda' c) - 6A_3 c - \frac{M_0}{2D} = - \frac{M_0}{D} . \end{aligned} \quad (34)$$

For adherends of typical length,

$$\sinh(\xi \ell) \approx \cosh(\xi \ell) \approx \frac{1}{2} e^{\xi \ell} \quad (35)$$

whence

$$B_1 \xi^2 \frac{1}{2} e^{\xi \ell} = - M_0 / D , \quad (36)$$

where M_0 is the bending moment per unit width in the continuous adherend at the end of the joint.

The continuity of the third derivatives of w need not be assured and the fourth condition necessary to determine the integration constants derives from equation (23) in the form

$$A_2 2\lambda' \sinh(2\lambda'c) = \frac{G}{Et\eta} \left[P + \frac{6(1-\nu^2)M_o}{k_b t} \right]. \quad (37)$$

The result required from the equations above is that

$$M_o = P \left(\frac{t + \eta}{2} \right) \frac{\left[1 + \frac{\xi^2 \lambda^2}{32(\lambda')^4} \left(1 + \frac{(2\lambda'c)}{3} - \frac{2\lambda'c}{\tanh(2\lambda'c)} \right) \right]}{\left\{ 1 + \xi c + \frac{\xi^2 c^2}{6} - \frac{(t+\eta)}{2t} \left[\frac{3\lambda^2 \xi^2}{32k_b(\lambda')^4} \right] \left[1 + \frac{(2\lambda'c)^2}{3} - \frac{2\lambda'c}{\tanh(2\lambda'c)} \right] \right\}} \quad (38)$$

and, on assessing the quantitative contribution of the respective terms, it is found that

$$M_o \approx P \left(\frac{t + \eta}{2} \right) \frac{1}{1 + \xi c + \frac{\xi^2 c^2}{6}} = kP \frac{t}{2} \left(1 + \frac{\eta}{t} \right). \quad (39)$$

(This differs fundamentally from the result obtained by Goland and Reissner, which is discussed later.)

Returning now to equations (23), (28), and (29) it is found that

$$\frac{\tau_{av}}{\tau_{max}} = \frac{1}{1 + \left[1 + \frac{3k(1-\nu^2)}{k_b} \left(1 + \frac{\eta}{t} \right) \left[\frac{\lambda^2}{4(\lambda')^2} \right] \left[\frac{2\lambda'c}{\tanh(2\lambda'c)} - 1 \right] \right]} \quad (40)$$

which, for isotropic adherends, reduces to the result predicted by Goland and Reissner in the concluding portion of their paper. For a sufficiently long overlap, this elastic analysis of single-lap bonded joints predicts that

$$\frac{\tau_{av}}{\tau_{max}} \rightarrow \frac{2}{\lambda'c}. \quad (41)$$

In view of the analysis of double-lap joints (Reference 12) it appears, at first sight, that, for elastic adhesives, single-lap joints are far more efficient than double-lap joints, for which $(\tau_{av}/\tau_{max}) \rightarrow 1/\lambda'_c$. The reason for this apparent anomaly is the constant term c_2 in equation (28), which is zero for double-lap joints. Here, for long single overlaps,

$$c_2 \rightarrow \frac{3}{4} \tau_{av} \quad (42)$$

for the case of isotropic adherends, thereby reducing the influence of the stress concentrations. (For non-isotropic adherends,

$$C_2 \rightarrow \left\{ 1 - \frac{1}{[1 + 3(1 - \nu^2)/k_b]} \right\} \tau_{av} \quad .) \quad (43)$$

On the other hand, a quantitative assessment of equation (40) reveals that the average adhesive stresses developed in single-lap joints do not exceed those developed in the corresponding double-lap joints for either realistic material properties or overlaps not so excessively long as to add undue weight to the structure. In addition to this, the apparent superiority above of single-lap joints refers exclusively to the adhesive shear stress distribution. Unsupported single-lap joints (as analyzed here) are inevitably subjected to a severe bending stress concentration in the adherends at the ends of the joint. Consequent yielding in a metal adherend can cause relative displacements across the adhesive layer which are beyond the capability of the adhesive, causing an otherwise premature adhesive failure. In the case of filamentary composite adherends, failure under inter-laminar tension due to the peel stresses induced at the ends of the overlap prevents the attainment of the potential high shear strength indicated above.

The prime objective of Section 2 is the derivation of the bending moment M_0 at the end of the joint. This quantity defines the peak shear and peel stresses in the adhesive (which is why it is important to correct the deficiency, in this regard, of the analysis by Goland and Reissner). The influence of this bending stress on the strength of the adherends is elucidated in Section 3. The analysis of the adhesive shear stress distribution is presented in Section 4 using the more realistic elastic-plastic adhesive formulation. The problem of peel stresses is discussed in Section 5.

Discussion of Goland and Reissner Analysis

The elastic analysis by Goland and Reissner (Reference 1) in 1944 has formed the foundation of most later investigations of single-lap bonded joints. As mentioned above, their determination of the stress couple M_0 at the end of the joint is subject to severe restrictions on its applicability, being strictly valid only for light loads and short overlaps. Since their paper is so widely recognized as a leader in the field, it is appropriate to explain fully the limitations implicit in their solution. The sign convention and terminology which they employed differ somewhat from those used here, but there is no difficulty in comparing the two analyses. To complement the equations (2) through (5) here they considered that there was negligible adhesive deformation in the overlap region of the joint and analyzed that portion (2 and 3 in Figure 2) as part of a single cylindrically-bent plate of twice the thickness of each individual adherend. They derived for this region 5 the governing differential equation

$$\frac{d^4 w_5}{ds^4} = -\frac{M_5}{D_5} = -\frac{P}{8D} \left[\left(\frac{t + \eta}{l + c} \right) (l + s) - w_5 - \frac{(t + \eta)}{2} \right], \quad (44)$$

of which the solution is

$$w_5 = A_5 \cosh \left(\frac{\xi s}{2\sqrt{2}} \right) + B_5 \sinh \left(\frac{\xi s}{2\sqrt{2}} \right) + \left(\frac{t + \eta}{l + c} \right) (l + s) - \frac{(t + \eta)}{2}. \quad (45)$$

Using the boundary conditions

$$\left. \begin{aligned} w_1 &= 0 & \text{at } x &= 0, \\ w_1 &= w_5 & \text{at } x &= l, \quad s = -c, \\ dw_1/dx &= dw_5/ds & \text{at } x &= l, \quad s = -c, \\ w_5 &= 0 & \text{at } s &= 0, \end{aligned} \right\} \quad (46)$$

they eventually deduced that, for isotropic adherends,

$$M_0 = k \frac{Pt}{2} \left(1 + \frac{\eta}{t} \right) \quad (47)$$

where their equation (16) is precisely equivalent to

$$k = \frac{1}{\left| 1 + 2\sqrt{2} \tanh\left(\frac{\xi c}{2\sqrt{2}}\right) \right|} \quad (48)$$

Their solution (44) approaches the asymptote

$$k \rightarrow \frac{1}{1 + 2\sqrt{2}} = 0.261 \quad (49)$$

for indefinitely large values of overlap (characterized by ξc), whereas the present solution (40) has, for its asymptote,

$$k = 0 \quad (50)$$

Figure 3 presents a comparison between the respective solutions. Intuitively one expects that $M_o \rightarrow 0$, rather than some definite non-zero value, for joints with very long overlaps. The effect of this discrepancy is that, instead of the result (42) that

$$\frac{\tau_{av}}{\tau_{max}} \rightarrow \frac{2}{\lambda c} \quad (51)$$

they predicted that

$$\frac{\tau_{av}}{\tau_{max}} \rightarrow \frac{1.12}{\lambda c} \quad (52)$$

for sufficiently long overlaps. Their simplification consequently leads to overly conservative solutions out by a factor of nearly two except for short overlaps or light loads. The fallacy in their reasoning is explained in Figure 4 — they used the equation

$$\frac{M}{D} = - \frac{d^2 w_s}{ds^2} \quad (53)$$

which implies linear bending stress distributions, to represent a stress distribution which, at the region of interest, was in reality precisely zero over one half of the cross section and anything but anti-symmetric about the middle of the adhesive layer. (They used the correct boundary conditions in the third phase of their analysis, for the adhesive stress distributions, so their equation (49) for the shear stress distribution is sound except for the erroneous evaluation of the bending parameter k .) This is not to suggest that Goland and Reissner believed that the stress distribution shown in Figure 4

approximated the actual situation. Rather, they chose to accept the analytical simplifications ensuing from the assumption that the influence of this approximation was minor. It is now apparent that the assumption that the overlap portion of the joint may be treated as a plate of twice the adherend thickness is both mathematically unnecessary and physically unrealistic. Both the adhesive and adherend maximum stress concentrations are critically dependent on the value calculated for the bending moment M_0 at the end of the overlap. The most serious discrepancy associated with their analysis is not that identified by equations (51) and (52). Rather it is that they have under-estimated the limit (yield) strength of the adherends outside the joint by the same factor 1.12 : 2 which follows from the limit for the maximum tension plus bending stress:

$$\frac{\sigma_{\max}}{\sigma_{av}} = 1 + 3k \left(1 + \frac{\eta}{t} \right) \approx (1 + 3k) \quad (54)$$

The quantitative effect of this deficiency is illustrated in Figure 3. Because Goland and Reissner effectively over-estimated k in equation (54), an assessment of the efficiency $\eta = \sigma_{av} / \sigma_{\max}$ of the adherends just outside the joint would predict even lower efficiencies than those predicted in Section 3 by the present analysis. It clearly affects the adherend efficiency under the eccentric load path and serves as boundary condition for the adhesive shear and peel stresses analyzed below. Consequently, any unnecessary simplifying assumptions in the derivation of M_0 must have an adverse effect on the entire joint analysis. Figure 3 shows how the transverse deflections of the joint under load relieve this critical bending moment for long overlaps ($k \rightarrow 1$), thereby increasing the joint efficiency ($\eta = \sigma_{av} / \sigma_{\max}$) dramatically. This potential benefit appears to have been overlooked in References 8 and 9. In Report No. 1, Figure 21, p. 90 of Reference 8, the influence of this non-linearity (geometric change under load) in the analysis should have appeared as a factor in the range zero to unity on the transverse shear forces $p(t + t_1)/a$. In Reference 9, only coarse approximation was made in accounting for this effect. With reference to Figure 2 here, a constant radius of curvature was adopted for zone in their analysis, as stated on p. 42 of Volume 1 immediately prior to their equation (85).

3. ADHEREND STRESS DISTRIBUTION DUE TO ECCENTRICITY IN LOAD PATH

As explained above, the eccentricity in the load path of an unsupported single-lap joint induces high bending moments in the adherend(s) at the ends of the overlap. The bending moment is related to the applied load by equation (39) so that the maximum "fiber" stress, adjacent to the bond line at the end of the overlap is given by

$$\sigma_{\max} = \frac{P}{t} + \frac{Mc}{I} = \sigma_{av} \left[1 + 3k \left(1 + \frac{n}{t} \right) \right] \quad (55)$$

where

$$k = \frac{1}{1 + \xi c + \frac{\xi^2 c^2}{6}} \quad \text{and} \quad k_b = \frac{D}{Et^3/[12(1 - \nu^2)]} \quad (56)$$

Here

$$\xi^2 = \frac{P}{D} = \frac{\sigma_{av} \left[\frac{12(1 - \nu^2)\sigma_{\max}}{k_b Et^2} \right]}{\sigma_{\max}} \quad (57)$$

so that, for a given allowable stress σ_{\max} , the associated average stress must be determined through iteration. Digital computer programs are used to obtain these solutions. For isotropic adherends, the results are shown in Figure 5. It is immediately evident that very long overlaps are necessary to obtain reasonable structural efficiencies and that large weight penalties in the joint must consequently be accepted in order to avoid low structural efficiencies throughout the entire panels outside a joint. For example, for 7075-T6 aluminum alloy, with an l/t of 10, the average adherend stress is only 25 ksi while plastic hinges develop at a local stress of 70 ksi. The l/t ratio has to exceed 100 for aluminum if the average stress is to attain 95 percent of its yield capacity.

The effects of uncoupling the bending and extensional stiffnesses (by changing the layup sequence for filamentary composite adherends) are revealed in Figure 6. It is apparent that concentrating the 0° filaments near the middle of each laminated adherend (low values of k_b) effectively increases the eccentricity in the overlap, thereby aggravating the inefficiency of such joints. The reason

why high values of k_b are associated with lesser inefficiencies is that, by concentrating the stiff filaments in the outside of the laminate(s), the bending curvatures induced are less than for a uniform interspersion of the cross-plyed layers throughout the thickness. The family of curves in Figure 5 represent, in dimensionalized form, the single non-dimensionalized curve in Figure 6 for isotropic (metal) adherends ($k_b = 1$).

The most important conclusion to be drawn from Figures 5 and 6 is that unsupported single-lap joints are inevitably inefficient because of the eccentricity in the load path. In order to approach an acceptable efficiency for the adherend(s) outside the joint, it is necessary to accept the weight penalty of far greater overlaps than are current design practice. To not do so is tantamount to imposing a weight penalty of a factor typically of from two to three on the entire adherends outside the joint in order to save a very much smaller weight in the joint itself.

Before proceeding to the analysis of the adhesive shear stresses, it is appropriate to emphasize that the initiation of joint failure for metal adherends is usually the formation of the plastic hinge(s) at the end(s) of the overlap. This is particularly evident in the standard single-lap half-inch overlap shear test, as illustrated in Figure 1. The failure of the adhesive is usually secondary and in no way represents the shear capacity of the adhesive for double-lap, stepped-lap or scarf joints, or even of single-lap joints having different dimensions.

4. ADHESIVE SHEAR STRESS DISTRIBUTIONS FOR BALANCED ADHERENDS (ELASTIC-PLASTIC ANALYSIS)

Consideration of adhesive plasticity is shown, in Reference 11, to be of paramount importance in reconciling theory and experiment for bonded double-lap joints. The principal need for the elastic analysis of single-lap joints in Section 2 is to simplify the determination of the bending moment M_0 at the ends of the joint. It is shown in equation (38) that this moment is essentially independent of the elastic adhesive shear stress distribution within the joint. In the case of an assumed perfectly plastic adhesive ($\tau = \tau_p = \text{const.}$), the approximate result (39) follows precisely from equations (32) through (35) on setting $A_2 = 0$. (Equation (37) does not apply in the case of a perfectly plastic adhesive since it was derived from the first of equations (14) and, instead of the stress derivative $d\tau/dx$, the plastic analysis employs the strain derivative $d\gamma/dx$. Since the result (39) is valid for the extremes of perfectly elastic and perfectly plastic adhesive behavior, it proves convenient (and adequately realistic) henceforth to separate the determination of the elastic-plastic shear stress distribution from that of the governing boundary condition M_0 . It is assumed, therefore, that

$$M_0 = P \left(\frac{t + \eta}{2} \right) \left(\frac{1}{1 + \xi c + \frac{1}{6} \xi^2 c^2} \right) = kP \frac{t}{2} \left(1 + \frac{\eta}{t} \right) \quad (58)$$

for lap joints between adherends of equal stiffness. (The case of adherends of different stiffnesses, in which the bending moments are not the same at each end of the joint, is analyzed in Section 7.)

Figure 7 depicts the geometry and nomenclature for the analysis of a balanced single-lap joint. Both isotropic and filamentary composite adherends are included in the analysis. The equations governing deformations under load are presented in Section 2. Thus, within the elastic region, [from equations (25) to (27)]

$$\frac{d^3 \tau}{ds^3} = 4(\lambda')^2 \frac{d\tau}{ds}, \quad \left[(\lambda')^2 = \frac{[1 + 3(1 - \nu^2) / k_b] \left(\frac{2G}{Et\eta} \right)}{4} \right] \quad (59)$$

(in which the term k_b accounts for the difference between isotropic and filamentary composite materials). In the plastic regions of the joint, [from equations (7) through (14)],

$$\frac{d\gamma}{ds} = \frac{1}{\eta} \left(\frac{du_3}{ds} - \frac{du_2}{ds} \right) = \frac{1}{E\eta} \left[T_3 - T_2 - \frac{6(1-\nu^2)}{k_b} (M_2 + M_3) \right], \quad (60)$$

and

$$\frac{d^3\gamma}{ds^3} = \left[1 + \frac{3(1-\nu^2)}{k_b} \right] \left[\frac{2}{E\eta} \right] \frac{d\tau}{ds} = 0. \quad (61)$$

Equation (56) has the solution

$$\tau = A_2 \cosh(2\lambda's) + B_2 \sinh(2\lambda's) + C_2 \quad (62)$$

in which the constant B_2 can evidently be set equal to zero because of the precise anti-symmetry of the joint. Equation (61) has the solution

$$\gamma = A_3\zeta^2 + B_3\zeta + C_3 \quad (63)$$

in which $ds = d\zeta$, the origin for ζ being at $s = +d/2$.

The constants A_2, C_2, A_3, B_3, C_3 and the unknown ratio d/ℓ are found by satisfying the boundary conditions

$$\gamma = \gamma_e \quad \text{at } s = d/2, \zeta = 0, \quad (64)$$

$$\gamma = \gamma_e + \gamma_p \quad \text{at } \zeta = (\ell - d)/2, \quad (65)$$

$$d\gamma/ds = d\gamma/d\zeta \quad \text{at } s = d/2, \zeta = 0, \quad (66)$$

$$d^2\gamma/ds^2 = d^2\gamma/d\zeta^2 \quad \text{at } s = d/2, \zeta = 0, \quad (67)$$

$$\frac{d\gamma}{d\zeta} = \frac{P}{Etr} \left[1 + \frac{3k(1-\nu^2)}{k_b} \left(1 + \frac{\eta}{t} \right) \right] \quad \text{at } \zeta = \frac{\ell - d}{2}, \quad (68)$$

and

$$\int_0^{d/2} \tau dx + \tau_p \left(\frac{\ell - d}{2} \right) = \tau_{av} \left(\frac{\ell}{2} \right) = \frac{P}{2} \quad (69)$$

Equation (69) is derived by consideration of gross horizontal equilibrium of the joint. Equation (64) permits of the rewriting of equation (62) in the form

$$\tau = G\gamma = A_2 \cosh(2\lambda's) + \tau_p - A_2 \cosh(\lambda'd) \quad (70)$$

It proves to be convenient to introduce the notation

$$A_2 \cosh(\lambda'd) = K\tau_p \quad (71)$$

so that

$$\tau = G\gamma = A_2 \cosh(2\lambda's) + \tau_p(1 - K) \quad (72)$$

Equations (64) and (65) enable the constants B_3 and C_3 in equation (63) to be evaluated. Hence

$$\gamma = A_3\zeta^2 - A_3\left(\frac{\ell - d}{2}\right)\zeta + \frac{\gamma_p\zeta}{\left(\frac{\ell - d}{2}\right)} + \gamma_e \quad (73)$$

Equations (66) and (67) provide for the re-expression of equation (73) in terms of A_2 , and thence K , since

$$-A_3\left(\frac{\ell - d}{2}\right) + \frac{\gamma_p}{\left(\frac{\ell - d}{2}\right)} = \frac{A_2}{G}(2\lambda')\sinh(\lambda'd) = \frac{2\lambda'}{G}K\tau_p \tanh(\lambda'd) \quad (74)$$

and

$$2A_3 = \frac{A_2}{G}4(\lambda')^2 \cosh(\lambda'd) = \frac{4(\lambda')^2}{G}K\tau_p \quad (75)$$

Therefore

$$\gamma = \gamma_e \left\{ 1 + 2K[(\lambda'\zeta)^2 + \lambda'\zeta \tanh(\lambda'd)] \right\} \quad (76)$$

so that, when $\zeta = (\ell - d)/2$ where $\gamma = \gamma_e + \gamma_p$,

$$2\left(\frac{\gamma_p}{\gamma_e}\right) = K \left\{ \left[2\lambda'\left(\frac{\ell - d}{2}\right) + \tanh(\lambda'd) \right]^2 - \tanh^2(\lambda'd) \right\} \quad (77)$$

Equation (68) leads to the expression

$$\frac{\left[1 + [3k(1 - \nu^2)/k_b] \left(1 + \frac{\eta}{t} \right) \right] 2G}{E t \eta} \tau_{av} \ell = \frac{\gamma_p}{\left(\frac{\ell - d}{2}\right)} \frac{1}{\gamma_e} \frac{\tau_p}{G} + 2(\lambda')^2 \left(\frac{\ell - d}{2}\right) K \frac{\tau_p}{G} \quad (78)$$

$$\left[1 + \frac{3k(1 - \nu^2)}{k_b} \left(1 + \frac{\eta}{t} \right) \right] \frac{\tau_{av}(\lambda\ell)\lambda\left(\frac{\ell - d}{2}\right)}{\tau_p} = 2\left(\frac{\gamma_p}{\gamma_e}\right) + K \left[2\lambda'\left(\frac{\ell - d}{2}\right) \right]^2 \quad (79)$$

$$= 4\left(\frac{\gamma_p}{\gamma_e}\right) - 4K(\lambda')\left(\frac{\ell - d}{2}\right) \tanh(\lambda'd) \quad (80)$$

Equation (69) yields the solution

$$\frac{\tau_{av}(\lambda'\ell)}{\tau_p} = 2\lambda'\left(\frac{\ell - d}{2}\right) + (1 - K)(\lambda'd) + K \tanh(\lambda'd) \quad (81)$$

$$= 2\lambda'\left(\frac{\ell - d}{2}\right) + \tanh(\lambda'd) + (1 - K)[\lambda'd - \tanh(\lambda'd)] \quad (82)$$

The precise solution of equations (77) to (82) to eliminate K and d requires numerical solution, and a digital computer program to accomplish this for isotropic adherends has been developed.

Two salient features of the solution, however, do prove amenable to analytic investigation. These are the important criteria of the maximum load a joint could potentially carry as the overlap is increased indefinitely, and the maximum extent of overlap throughout which fully-plastic adhesive deformation can be maintained. For very long overlaps, equation (58) indicates that $k \rightarrow 0$. From equations (77) and (79), then, with $\tanh(\lambda'd) \rightarrow 1$,

$$\frac{\tau_{av}(\lambda\ell)\lambda\left(\frac{\ell - d}{2}\right)}{\tau_p} = 8K\left[\lambda'\left(\frac{\ell - d}{2}\right)\right]^2 + 4K\lambda'\left(\frac{\ell - d}{2}\right) \quad (83)$$

Therefore, eliminating τ_{av}/τ_p by means of equation (79),

$$\left|4K - \left(\frac{\lambda}{\lambda'}\right)^2\right| \left|2\lambda'\left(\frac{\ell - d}{2}\right) + 1\right| = (1 - K)\left(\frac{\lambda}{\lambda'}\right)^2 (\lambda'd - 1) \quad (84)$$

From physical reasoning and equation (71) it is evident that $K \rightarrow 1$ as $\lambda'\ell \rightarrow \infty$ since, otherwise, the uniform shear stress component C_2 in the elastic region would cause the joint strength to increase indefinitely with increasing overlap. The left-hand side of equation (83) is therefore finite, since the adhesive strain capability limits $\lambda'(\ell - d)/2$, so that the otherwise indeterminate right-hand side can be evaluated. Returning now to equation (82),

$$\frac{\tau_{av}(\lambda'\ell)}{\tau_p} \rightarrow \left|5 - \left(\frac{\lambda}{\lambda'}\right)^2\right| \left|2\lambda'\left(\frac{\ell - d}{2}\right) + 1\right| \rightarrow 4\sqrt{1 + 2\left(\frac{\gamma_p}{\gamma_e}\right)}, \text{ as } \lambda'\ell \rightarrow \infty \quad (85)$$

This is twice as strong as for the corresponding double-lap joint between isotropic adherends (Reference 12), the reason being that 3/4 of the load is carried in the elastic region for the very long single-lap joint while practically none is carried in the elastic trough for long double-lap joints. The extent of plastic deformation in the adhesive at each end of the balanced single-lap joint follows from equation (77),

$$2\lambda' \left(\frac{\ell - d}{2} \right) \rightarrow \sqrt{1 + 2 \frac{\gamma_p}{\gamma_e}} - 1 \quad (86)$$

This is only half as long as for the equivalent double-lap joint for isotropic adherends which is why, in practice, single-lap bonded joints do not develop higher average shear stresses than do double-lap joints.

For the fully-plastic joint, $d \equiv 0$ and, from equations (63), (64), (65) and (68), with $\tau_{av} = \tau_p$,

$$\lambda \ell \leq \sqrt{\frac{4 \left(2 \frac{\gamma_e}{\gamma_p} \right)}{1 + \frac{3k(1 - \nu^2)}{k_b} \left(1 + \frac{\eta}{t} \right)}} \quad (87)$$

Again, for short overlaps for which $k \approx 1$, the maximum possible extent of plastic adhesive deformation (for isotropic adherends) is only one half as great as in the double-lap joint (Reference 12). This comparison and those preceding it are made with respect to isotropic adherends ($k_b = 1$ and $\lambda' = \lambda$) in order to compare the behavior of the two joint classes without adding complexities peculiar to a particular non-isotropic material.

In solving simultaneously equations (58), (77), (79) and (82), significant algebraic manipulation proves to be necessary. Since shear-stress governed failures are unusual even for metal adherends and rare for filamentary composite adherends, the remainder of this section on adhesive shear stresses is confined to isotropic adherends in order to simplify the procedures and remove one variable from the solution. The failure of single-lap joints between composite adherends is usually governed by peel stress considerations for thick adherends, so the extensional and bending stiffnesses of the adherends are uncoupled for

that problem, in Section 7. Adhesive shear failures of single-lap bonded joints are confined to thinner sections. For isotropic adherends ($k_b = 1$ and $\lambda' = \lambda$) it can be shown that, precisely,

$$\frac{\tau_{av}(\lambda \ell)}{\tau_p} = \frac{4K}{\left| 1 + 3k(1 - \nu^2) \left(1 + \frac{\eta}{t} \right) \right|} \left[\tanh^2(\lambda d) + \frac{2\gamma_p}{K\gamma_e} \right]^{\frac{1}{2}} \quad (88)$$

$$= \frac{4K}{\left| 1 + 3k(1 - \nu^2) \left(1 + \frac{\eta}{t} \right) \right|} \left[2\lambda \left(\frac{\ell - d}{2} \right) + \tanh(\lambda d) \right] \quad (89)$$

and that

$$\tanh^2(\lambda d) + \frac{2\gamma_p}{K\gamma_e} = \left\{ \frac{1 - K}{4K} \right\}^2 \left[\lambda d - \tanh(\lambda d) \right]^2, \quad (90)$$

while

$$\lambda \ell = \lambda d + 2\lambda \left(\frac{\ell - d}{2} \right) = \left[\tanh^2(\lambda d) + \frac{2\gamma_p}{K\gamma_e} \right]^{\frac{1}{2}} + \lambda d - \tanh(\lambda d) \quad (91)$$

$$= \left\{ \frac{\frac{4K}{1 + 3k(1 - \nu^2) \left(1 + \frac{\eta}{t} \right)} - K}{4K} \right\} [\lambda d - \tanh(\lambda d)] \quad (92)$$

Given the correct value of k , one can assume a value of λd , compute K by means of equation (90), $\lambda \ell$ from equation (92), and $(\tau_{av}/\tau_p)\lambda \ell$ from equation (88). An iterative process must be used because of the indeterminacy of k :

$$k = 1 / \left[1 + \frac{\xi \ell}{2} + \frac{1}{6} \left(\frac{\xi \ell}{2} \right)^2 \right] \quad \text{in which} \quad \xi^2 = \tau_{av} \ell / D \quad (93)$$

Since a useful design chart is of the form load versus lap length with all other parameters held constant, it is desirable to non-dimensionalize the terms involved. Accordingly,

$$\left(\frac{\xi \ell}{2} \right)^2 = \left(\frac{\tau_{av}}{D} \right) \frac{\ell^2}{4} = \frac{\tau_{av}(\lambda \ell)(\lambda \ell)^2 \tau_p}{\tau_p 4D\lambda^3}, \quad (94)$$

where $D = Et^3/[12(1-\nu^2)]$ is the bending stiffness of the adherend. The eccentricity parameter $\tau_p/4D\lambda^3$ * is found to range from 10^{-4} to 10^{-1} in the regime of practical concern. To reduce the number of variables involved, the approximation $[1 + (c/t)] \approx 1$ is utilized.

The adhesive shear stresses derived from the analysis above are developed on the assumption that the adherend still behaves elastically at the failure of the adhesive and that the adhesive fails in shear rather than in peel. The experimental evidence, on the other hand, indicates that significant adherend yielding frequently occurs prior to adhesive failure with metal adherends and that, for filamentary composite adherends, the failure is usually confined to the laminate(s) because it originated as the result of either transverse tension or the stretching and bending due to the eccentric load path. Such observations lead one to question the wisdom of interpreting test data on single-lap joints in terms of adhesive shear stresses. The same question may be raised about design except when using test data pertaining to the precise configuration involved. Nevertheless, since it is not possible to prove the universal impossibility of an adhesive shear failure in a single-lap joint, it is appropriate to illustrate the potential shear strengths of adhesive bonds. The computations were restricted to isotropic adherends because of the coupling between extensional and bending stiffnesses of the adherend(s). The solution is non-dimensionalized to minimize the number of graphs required. Figures 8 through 15 depict the potential adhesive shear strength of single-lap bonded joints. Figure 8 portrays, for a typical ductile adhesive, the effect of variation in adherend properties. It is apparent that higher adherend bending stiffnesses impose greater strain concentrations on the adhesive than do low bending stiffnesses. It is evident also that extremely great overlaps are required to approach the maximum (asymptotic) strength which is four times as great as that for joints of very short overlap. This phenomenon is quite diff-

* The eccentricity parameter $\tau_p/4D\lambda^3$ characterizes the decay rate of the influence of the eccentricity. The physical eccentricity is associated more with the inverse of this parameter. Consideration was given to using the inverse parameter, so that an increasing eccentricity would be associated with increasing values of the characterizing coefficient, but the fact that the eccentricity cannot range from zero to infinity led to the approach adopted here.

erent from that for double-lap joints in which only the adherend extensional stiffness (and not the bending stiffness) affects the potential bond shear strength, which does not increase steadily with increasingly long overlaps. Figure 9 illustrates the influence of the adhesive characteristics on the potential bond shear strength, which is seen to increase steadily with increasing adhesive plasticity. Just as for double-lap joints, the bond strength is related to the strain energy of the adhesive in shear. Figure 9 includes, for each adhesive plastic-to-elastic strain capability, the range of influence of the adherend properties. An assessment of the values of the physical quantities involved indicates that the full range of the eccentricity parameter (T_1/AD^3) is encountered in practice and that there is essentially no difference in effect between unity and infinity for this parameter for the non-dimensionalized overlaps greater than those for which the adhesive behaves fully plastically throughout. Figures 10 to 15 present the adhesive bond potential shear strengths in non-dimensionalized form, for an adequate range of values of the parameters involved to encompass design practice.

For practical design purposes it is not necessary to construct the entire adhesive shear strength characteristic. It usually suffices to check that, for the given adherends, the potential bond shear strength at the transition from fully-plastic behavior exceeds the adherend strength for that particular overlap. The excess strength will be greater still for longer overlaps.

The adhesive shear stress analysis above pertains to tensile and to compressive lap shear. It accounts for the bending moments at the ends of the overlap which are responsible for much lower efficiencies than are developed on one side of a double-lap bonded joint. The in-plane shear loading of single-lap joints does not develop such eccentricities in the load path and is therefore covered by the double-lap joint analysis. Full details are to be found in Reference 12. Briefly, the normal adherend properties E are replaced by the shear properties G with the same form of differential equation governing the solution.

5. ADHESIVE PEEL STRESS DISTRIBUTIONS FOR BALANCED ADHERENDS

The analysis of peel stresses for double-lap adhesive-bonded joints in Reference 12 indicated that interlaminar tension was the dominant failure mode for thick composite adherends. Even higher peel stresses are induced for single-lap bonded joints, so it is appropriate to analyze these also. The tension stress in the adhesive is assumed to remain elastic for two reasons. First, for composite adherends, the adherend is much weaker in transverse tension than is the adhesive in peel. Consequently the adherend will fail as soon as the adhesive develops its peak peel stress in any one location (at the end(s) of the overlap) rather than holding on until the peak peel stress spreads over a greater area through yielding of the adhesive. Second, the adhesives are long-chain polymers and essentially incompressible. Therefore, the stiff in-plane constraints imposed on the adhesive film by the adjacent adherends effectively suppress any plastic deformation in the adhesive except at the periphery of the bond. Such phenomena are particularly difficult to account for analytically (and probably more difficult to quantify precisely by experiment), so it is sensible to start by seeking empirical correction factors to purely elastic analyses of the peel stress problem. If such correlation factors prove to be close to unity there is no need for a more elaborate analysis including plastic peel effects. Further support for the purely-elastic peel-stress approach derives from the fact that the behavior for composite adherends is governed not by the adhesive peel modulus alone but by an effective value including the effect of the finite stiffness of the proportionally much thicker adherends.

The analysis of peel stresses commences with the straightforward case of identical adherends, for which the differential equation governing the peel stress distribution along the joint is uncoupled from that pertaining to the shear stress distribution. The case of dissimilar adherends is covered in Section 8. The nomenclature and sign convention necessary for the present analysis are to be found in Figures 2 and 7. The basic equations are established in Section 2 above. From equations (13), (10), (11), (7) and (9) it can be shown that the peel stress equation is deduced by the following sequence.

$$\left(\frac{\eta}{E_c}\right) \frac{d^2 \sigma_c}{ds^2} = \frac{d^2 w_3}{ds^2} - \frac{d^2 w_2}{ds^2} = -\frac{1}{D} (M_3 - M_2) = \frac{12(1 - \nu^2)}{r_b E t^3} (M_3 - M_2) \quad (95)$$

and

$$\left(\frac{k_b E t^3 \eta}{12(1 - \nu^2) E_c}\right) \frac{d^3 \sigma_c}{ds^3} = - (V_3 - V_2) \quad , \quad (96)$$

whence

$$\frac{d^4 \sigma_c}{ds^4} + 4\chi^4 \sigma_c = 0 \quad (97)$$

where

$$\chi^4 = \frac{E_c}{2\eta D} = \frac{6E_c(1 - \nu^2)}{Et^3 \eta k_b} \quad (98)$$

This parameter is essentially the same as that for double-lap joints [equations (69) and (70) of Reference 12], just as was found for the parameter λ governing the shear stress distributions [see equations (25) and (26) here and equations (28) and (29) of Reference 12].

Symmetry of the peel stress distribution about the middle of the overlap for the identical adherends considered here reduces the solution of equation (97) to the form

$$\sigma_c = A \cos(\chi s) \cosh(\chi s) + B \sin(\chi s) \sinh(\chi s) \quad (99)$$

when the origin of the s co-ordinate is now taken at the middle of the overlap. The boundary conditions determining the integration constants A and B are that there be zero resultant transverse force across the bond line, that is

$$\int_{-c}^{+c} \sigma_c ds = 0 \quad , \quad (100)$$

and that the bending moment M_0 is known, from Section 1, at the end of the joint. From equation (100), then,

$$\begin{aligned} A[\sin(\chi c) \cosh(\chi c) + \cos(\chi c) \sinh(\chi c)] + B[\sin(\chi c) \cosh(\chi c) - \cos(\chi c) \sinh(\chi c)] \\ = 0, \end{aligned} \quad (101)$$

so that, for all but very short overlaps,

$$A[\sin(\chi c) + \cos(\chi c)] \approx -B[\sin(\chi c) - \cos(\chi c)] \quad (102)$$

The simplification (102) follows from the approximation

$$\sinh(\chi c) \approx \cosh(\chi c) \rightarrow \frac{1}{2} e^{(\chi c)} \quad (103)$$

for moderately long, or longer, overlaps. The incorporation of the bending moment condition can be understood from Figure 2. At $s = +c$,

$$M_2 \equiv 0 \quad \text{and} \quad M = M_0, \quad (104)$$

with M_0 being evaluated in equation (39). Now, from equations (13) and (10),

$$\frac{E_c M_0}{\eta D} = \left. \frac{d^2 \sigma_c}{ds^2} \right|_{+c} = -2A\chi^2 \sin(\chi c) \sinh(\chi c) + 2B\chi^2 \cos(\chi c) \cosh(\chi c) \quad (105)$$

$$\approx -\chi^2 e^{(\chi c)} [A \sin(\chi c) - B \cos(\chi c)] \quad (106)$$

Now, from equations (102) and (106),

$$A \sin(\chi c) - B \cos(\chi c) \approx \frac{A}{[\sin(\chi c) - \cos(\chi c)]} \times [\sin^2(\chi c) - \sin(\chi c)\cos(\chi c) + \sin(\chi c)\cos(\chi c) + \cos^2(\chi c)] \quad (107)$$

$$= A / [\sin(\chi c) - \cos(\chi c)] \quad (108)$$

$$= -E_c M_0 / [\eta D \chi^2 e^{(\chi c)}] \quad (109)$$

Also,

$$\sigma_{c_{\max}} \approx \frac{1}{2} e^{(\chi c)} [A \cos(\chi c) + B \sin(\chi c)] \quad (110)$$

according to equation (99) and, from equation (102),

$$A \cos(\chi c) + B \sin(\chi c) \approx \frac{A}{[\sin(\chi c) - \cos(\chi c)]} \times [\sin(\chi c)\cos(\chi c) - \cos^2(\chi c) - \sin^2(\chi c) - \sin(\chi c)\cos(\chi c)] \quad (111)$$

$$= -A / [\sin(\chi c) - \cos(\chi c)] \quad (112)$$

Therefore, from equation (39),

$$\sigma_{c_{\max}} = \frac{E_c M_0}{2\eta D \chi^2} = \frac{E_c k}{2\eta D \chi^2} P \frac{t}{2} \left(1 + \frac{\eta}{t}\right) \quad (113)$$

or, in non-dimensionalized form,

$$\frac{\sigma_{c \max}}{\sigma_{av}} = k \left(1 + \frac{\eta}{t} \right) \left| \frac{3E_c(1-\nu^2)t}{2k_b E \eta} \right|^{\frac{1}{2}} \quad (114)$$

The corresponding result for double-lap joints [equation (83) of Reference 12] shows both marked similarities and dissimilarities. For peel-stress governed failures of double-lap joints,

$$\frac{\sigma_{c \max}}{\tau_p} = \left| \frac{3E_c(1-\nu^2)t_o}{E \eta} \right|^{\frac{1}{4}} \quad (115)$$

Essentially the same parameter ($E_c t / E \eta$) governs the peel behavior of both joint classes, but single-lap joints are more sensitive to this effect because of the exponent 1/2 instead of 1/4. More importantly, the unsupported single-lap joint peel stresses are an order of magnitude higher than for double-lap joints between similar adherends. That this is so is evident from a comparison of the left-hand sides of equations (115) and (114). The double-lap peel stresses are non-dimensionalized with respect to the peak (plastic) adhesive shear stress while those for single-lap joints are expressed with respect to the very much higher average adherend stresses outside the joint. Furthermore, it is shown in Section 7 how any adherend stiffness imbalance increases the single-lap peel stresses still further.

Figure 16 depicts the solution of equations (114) and (39) computed for isotropic (metal) adherends. Two dominant influences are acting. The first is that very long overlaps can be employed successfully to minimize peel stresses regardless of all other factors. This is quite different from the double-lap joint behavior in which the overlap has essentially no influence on the peel stresses. The overlap length effect for single-lap joints is manifest through the parameter k in equation (114). The second major phenomenon is associated with both single- and double-lap joints and is that thicker adherends and/or stiffer (more brittle) adhesives aggravate the peel stress problem. A quantitative assessment of the data presented in Figure 16 shows that for aluminum alloys, for example, l/t ratios in excess of 30 may be required to reduce the peel stress problem to a tolerable level, with even greater l/t ratios required for thick adherends.

The influence of uncoupling the adherend bending and extensional stiffnesses of

advanced composite adherends is effected through the bending parameter k_b in equations (114) and (39). Laminates having those fibers aligned along the load direction near the outside of the adherend ($k_b > 1$) are less severely affected by peel stress problems than are the more flexible adherends with the same fibers grouped near the neutral axis of the laminate ($k_b < 1$). This distinction is pronounced only for thin laminates (of four plies or so) because the low interlaminar strength of composite resins precludes the bunching together of large numbers of plies having a common orientation with only a single matrix interface between such groups. In other words, a laminate such as $(0^\circ_n / \pm 45^\circ_n / 0^\circ_n)$ is prone to split apart at the changes in fiber orientation whereas the re-arrangement into the form $(0^\circ / \pm 45^\circ / 0^\circ)_n$ forms a structurally sound laminate. Because of this factor, major deviations from $k_b \approx 1$ are not practical for even moderately thick sections. The physical sources of these limitations are two-fold. In the first place, the widely dissimilar thermal coefficients of expansion can induce considerable residual stresses into a poorly designed laminate not having thoroughly interspersed cross-ply while the laminate is cooling down after curing at the normal elevated temperature. Secondly, resin matrices have relatively little strength in themselves and the application of mechanical loads to the same poorly conceived laminates tends to overload the few active interfaces for in-plane shear transfer.

The most important observations about peel stresses in single-lap adhesive-bonded joints are that they can be severe and are far more important than are the associated shear stresses. Also, very large l/t ratios are needed to alleviate the problem.

6. JOINT EFFICIENCIES FOR BALANCED SINGLE-LAP JOINTS

The preceding analyses have established that, for unsupported single-lap adhesive-bonded joints, the joint (or the adherend immediately outside the overlap) cannot possibly be as strong as the potential strength far removed from the joint area. In other words, the joint efficiency of uniform-thickness single-lap structures is necessarily significantly less than unity. The other highlights of the analyses are the powerful influence of the l/t ratio, the usually negligible impact of the adhesive shear stresses, and the change in mode of failure from failure of thin adherends just outside the joint because of combined direct and bending loads to failure of thick adherends due to peel or transverse tension stresses at the end(s) of the overlap. These various phenomena are illustrated in Figures 17 and 18 for aluminum adherends with representative 350 °F curing ductile and brittle adhesives. Figures 19 to 24 show the corresponding efficiencies for representative HTS graphite-epoxy laminates. The various material properties employed in preparing these graphs are recorded in Table I, and the digital computer program employed in their preparation is listed in the Appendix. (Strictly, the composite characteristics cannot be continuous for small numbers of plies of standard thickness in balanced laminates, and account should be taken of non-unity values of k_b for accurate design purposes. Inclusion of these considerations would tend to complicate and confuse the presentations of Figures 19 to 24, so they were omitted. Therefore, these figures should not be used for design purposes for very thin laminates.) These joint efficiency charts demonstrate how large overlaps and ductile adhesives minimize the structural efficiency loss caused by unsupported single-lap joints.

In addition to illustrating the extent of the single-lap joint problem, these same Figures 17 to 24 suggest a straightforward design technique to overcome (or at least minimize) the problems. The simple concept is illustrated in Figure 25 and would still be a considerable improvement even if the eccentricity were not minimized as shown by effecting a smooth joggle in the adherends. The application of this design technique to achieve adequate joint efficiencies is as follows. The first step starts either with a known load to be transmitted or specified adherends to be bonded. In either event, the joint load and

minimum adherend thickness far outside the joint can be established by neglecting the eccentricity in the load path. Then the charts are examined to find thicker adherends and an appropriate λ/t ratio which could carry the load so specified (with uniform thicker adherends inefficiently loaded outside the joint). To match the efficiencies of this thick joint and the thin adherends, it is simply necessary to effect a smooth transition as shown in Figure 25. That such a design technique is inevitably conservative with respect to the overlap area is readily confirmed by realizing that the more flexible adherends outside the joint will reduce the critical bending moment M_0 below that associated with uniform thick adherends. On the other hand, equations (2) and (4) indicate that, no matter how long the transition between thicknesses is made, there will remain at least slight bending moments in the thin adherends outside the joint area. It would be a mistake not to allow for less than perfect efficiency outside the joint. However, arbitrarily accepting a maximum efficiency of say 70 to 80 per cent represents a very great improvement over the potential of 20 to 30 per cent without such stress concentration relief.

Figures 17 to 24 afford an interesting comparison with their counterparts [Figures 20 and 21 of Reference 12] for double-lap joints. There is simply no similarity other than that thick adherends cannot possibly be bonded together efficiently by uniform lap joints and that ductile adhesives are more efficient than brittle ones, both as regards shear stresses and peel stresses. Thin double-lap joints have a potential bond strength far in excess of the adherend strength. Also, the overlap length has no influence on double-lap joint strength once a relatively small minimum value necessary to develop the full strength has been exceeded. This indicates that the best way to deal with the problem of eccentricity in the load path of unsupported single-lap joints is to support them against rotation, thereby increasing the joint efficiency to approach that for half (one side) of a double-lap joint.

7. EFFECT OF ADHEREND STIFFNESS IMBALANCE ON ADHEREND FAILURES JUST OUTSIDE THE JOINT

As a result of any stiffness imbalance between the adherends it is obvious that the "thinner" adherend (of lower bending stiffness) will undergo greater transverse deflections than will the "thicker" adherend. The bending moments at each end of the joint will not be identical and a more general analysis than that used for identical adherends will be required. While an explicit analytical analysis proves to be quantitatively intractable, an iterative digital computer solution of the implicit equations can be achieved quite simply. The analyses above, together with the experimental evidence, have indicated the prime importance of the adherend bending stresses in determining the maximum joint load capacities, so these will be examined first.

The geometry and nomenclature pertaining to this analysis remain substantially as illustrated in Figure 2. It should be noted that, in general, the line of action of the applied loads intercepts the bond line eccentrically with respect to the center of the joint. While this problem could be analyzed with respect to any arbitrary reference axes, a careful choice of axes permits of a great simplification of the analysis. The location of the origin for the s co-ordinate is taken to be at that point O at which the bending moments in the adherends are zero: in other words, the line of action of the load passes through the "centroid" of the gross cross section. Whether O lies to the right or left of C , in Figure 26, is immaterial to the analysis. Fortunately it is established early in the analysis that, regardless of the joint geometry and material properties, O must lie within the lap region, between B and D . There proves to be no justification in considering a hypothetical situation in which $|e| \geq |c|$. The stiffness "centroid" lies between the centers of adherends 1 and 4 and it is relatively easily established that the transverse distance from the middle of adherend 1 is

$$EC_1 = \frac{\frac{1}{2}(t_1 + t_4 + 2t_1)}{\left(1 + \frac{E_1 t_1}{E_4 t_4}\right)}, \quad (116)$$

while the transverse distance from the middle of adherend 4 is

$$EC_4 = \frac{\frac{1}{2}(t_1 + t_4 + 2\eta)}{\left(1 + \frac{E_4 t_4}{E_1 t_1}\right)} \quad (117)$$

The axial location of 0 with respect to the middle of the joint is arbitrarily identified by the (as yet unspecified) length e .

Throughout the adherend 1, the longitudinal stress resultant (force per unit lateral width) is uniform, at the value P . The stress couple M_1 , per unit width, is then defined by the equilibrium equation

$$M_1 = P \left[\frac{(t_1 + t_4 + 2\eta)}{(\ell_1 + c + e) \left(1 + \frac{E_1 t_1}{E_4 t_4}\right)} \left(\frac{x_1}{2}\right) - w_1 \right] \quad \text{for } 0 \leq x_1 \leq \ell_1. \quad (118)$$

The classical theory for the infinitesimal bending of thin, cylindrically deformed plates then yields

$$\frac{d^2 w_1}{dx_1^2} = -\frac{M_1}{D_1} = -\frac{P}{D_1} \left[\frac{(t_1 + t_4 + 2\eta)}{(\ell_1 + c + e) \left(1 + \frac{E_1 t_1}{E_4 t_4}\right)} \left(\frac{x_1}{2}\right) - w_1 \right], \quad (119)$$

whence

$$w_1 = A_1 \cosh(\xi_1 x_1) + B_1 \sinh(\xi_1 x_1) + \frac{(t_1 + t_4 + 2\eta)}{(\ell_1 + c + e) \left(1 + \frac{E_1 t_1}{E_4 t_4}\right)} \left(\frac{x_1}{2}\right), \quad (120)$$

where

$$(\xi_1)^2 = \frac{P}{D_1} = \frac{12P(1 - \nu_1^2)}{(k_b)_1 E_1 t_1^3}. \quad (121)$$

The assumption of negligible moment restraint at $x = 0$ (or, equivalently, that ℓ_1 is so large in comparison with c that the precise nature of the end conditions is immaterial) prescribes that

$$A_1 = 0. \quad (122)$$

Similarly, for the other adherend, outside the joint,

$$M_4 = P \left[\frac{(t_1 + t_4 + 2\eta) \left(\frac{x_4}{2}\right)}{\left(\ell_4 + c - e\right) \left(1 + \frac{E_4 t_4}{E_1 t_1}\right)} - w_4 \right] \quad \text{for } -\ell_4 \leq x_4 \leq 0 \quad (123)$$

and

$$\frac{d^2 w_4}{dx_4^2} = -\frac{M_4}{D_4} = -\frac{P}{D_4} \left[\frac{(t_1 + t_4 + 2\eta) \left(\frac{x_4}{2}\right)}{\left(\ell_4 + c - e\right) \left(1 + \frac{E_4 t_4}{E_1 t_1}\right)} - w_4 \right], \quad (124)$$

whence

$$w_4 = B_4 \sinh(\xi_4 x_4) + \frac{(t_1 + t_4 + 2\eta) \left(\frac{x_4}{2}\right)}{\left(\ell_4 + c - e\right) \left(1 + \frac{E_4 t_4}{E_1 t_1}\right)} \quad (125)$$

where

$$(\xi_4)^2 = \frac{P}{D_4} = \frac{12P(1 - \nu_4^2)}{(k_b)_4 E_4 t_4^3} \quad (126)$$

It is now possible to establish that $|e| < |c|$. The location 0 was defined as that point between A and E for which the bending moment is zero. Examination of equation (119) indicates that $d^2 w_1/dx_1^2$ cannot be zero in the range $0 < x_1 \leq \ell_1$. Hence the location of 0 must lie to the right of B. Likewise, $d^2 w_4/dx_4^2$ cannot be zero in the range $-\ell_4 \leq x_4 < 0$ so that 0 must lie to the left of D. Consequently, 0 must be located within the extent of the overlap.

The behavior of regions 2 and 3 (Figure 26) is governed by much the same equations as for balanced joints between identical adherends, equations (7) to (14). Due allowance must be given to the different thicknesses, however, so that

$$\left. \begin{aligned} \frac{dM_2}{ds} - V_2 + \tau \left(\frac{t_1 + \eta}{2}\right) &= 0 \\ \frac{dM_3}{ds} - V_3 + \tau \left(\frac{t_4 + \eta}{2}\right) &= 0 \end{aligned} \right\}, \quad (127)$$

$$\left. \begin{aligned} \frac{dT_2}{ds} + \tau &= 0 \\ \frac{dT_3}{ds} - \tau &= 0 \end{aligned} \right\} , \quad (128)$$

$$\left. \begin{aligned} \frac{dV_2}{ds} + \sigma_c &= 0 \\ \frac{dV_3}{ds} - \sigma_c &= 0 \end{aligned} \right\} , \quad (129)$$

$$\left. \begin{aligned} \frac{d^2w_2}{ds^2} &= -\frac{M_2}{D_1} = -\frac{12M_2(1-\nu_1^2)}{(k_b)_1 E_1 t_1^3} \\ \frac{d^2w_3}{ds^2} &= -\frac{M_3}{D_4} = -\frac{12M_3(1-\nu_4^2)}{(k_b)_4 E_4 t_4^3} \end{aligned} \right\} . \quad (130)$$

As in Section 2, it is necessary to use the evaluation techniques

$$\left. \begin{aligned} w_2 &= \frac{1}{2}(w_2 + w_3) + \frac{1}{2}(w_2 - w_3) \\ w_3 &= \frac{1}{2}(w_2 + w_3) - \frac{1}{2}(w_2 - w_3) \end{aligned} \right\} . \quad (131)$$

From the equations above,

$$\frac{d^2(w_2 + w_3)}{ds^2} = -\frac{M_2}{D_1} - \frac{M_3}{D_4} , \quad (132)$$

$$\frac{d^3(w_2 + w_3)}{ds^3} = -\frac{V_2}{D_1} + \frac{\tau}{D_1} \left[\frac{t_1 + \eta}{2} \right] - \frac{V_3}{D_4} + \frac{\tau}{D_4} \left[\frac{t_4 + \eta}{2} \right] , \quad (133)$$

$$\frac{d^4(w_2 + w_3)}{ds^4} = \frac{\sigma_c}{D_1} - \frac{\sigma_c}{D_4} + \left[\frac{t_1 + \eta}{2D_1} + \frac{t_4 + \eta}{2D_4} \right] \frac{d\tau}{ds} , \quad (134)$$

$$\frac{d^2(w_2 - w_3)}{ds^2} = -\frac{M_2}{D_1} + \frac{M_3}{D_4} , \quad (135)$$

and, since for an adhesive obeying a linear elastic law in tension (peeling)

$$\frac{\sigma_c}{E_c} = \frac{w_3 - w_2}{\eta} , \quad (136)$$

$$\frac{d^4(w_2 - w_3)}{ds^4} = - \left[\frac{1}{D_1} + \frac{1}{D_4} \right] \frac{E}{\eta} (w_2 - w_3) + \left[\frac{t_1 + \eta}{2D_1} - \frac{t_4 + \eta}{2D_4} \right] \frac{d\tau}{ds} \quad (137)$$

A comparison of equations (134) and (137) with the corresponding equations (18) and (19) for balanced-stiffness adherends reveals that the imbalance couples the adhesive shear and peeling stresses, greatly complicating the analysis. In order to proceed explicitly, rather than implicitly (by numerical analyses), it proves convenient not to attempt to satisfy the differential equation (134) for all values of s but to adopt, instead, an assumed solution with sufficient integration constants to satisfy the dominant boundary conditions at the ends of the joint. Such a procedure is analogous to the assumption of deflection modes in beam and plate theory when using the Ritz or Stodola methods. The simplest such solution is the polynomial

$$\frac{1}{2}(w_2 + w_3) \approx A_{23}s^3 + B_{23}s^2 + C_{23}s + F_{23} \quad (138)$$

The conditions $M_2 = M_3 = 0$ at $s = 0$ permit the setting of

$$E_{23} = F_{23} = 0 \quad (139)$$

As in Section 2, it is assumed that

$$\frac{dw_2}{ds} \approx \frac{dw_3}{ds} \quad \text{at } s = -(c + e) \text{ and } s = (c - e) \quad (140)$$

but that the distinction between the second derivatives is vital since

$$\frac{d^2w_2}{ds^2} = - \frac{M_{01}}{D_1}, \quad \frac{d^2w_3}{ds^2} = 0 \quad \text{at } s = -(c + e) \quad (141)$$

and

$$\frac{d^2w_3}{ds^2} = + \frac{M_{04}}{D_4}, \quad \frac{d^2w_2}{ds^2} = 0 \quad \text{at } s = (c - e) \quad (142)$$

(Note the sign convention for positive values of M_{04}). The pertinent boundary conditions prove to be, at $x_1 = \ell_1$, $s = -(c + e)$,

$$\begin{aligned} w_1 &= B_1 \sinh(\xi_1 \ell_1) + \left(\frac{t_1 + t_4 + 2\eta}{\ell_1 + c + e} \right) \frac{1}{\left(1 + \frac{E_1 t_1}{E_4 t_4} \right)} \left(\frac{\ell_1}{2} \right) \\ &\approx \frac{1}{2}(w_2 + w_3) = -A_{23}(c + e)^3 - C_{23}(c + e), \end{aligned} \quad (143)$$

$$\begin{aligned} \frac{dw_1}{dx_1} &= B_1 \xi_1 \cosh(\xi_1 l_1) + \left(\frac{t_1 + t_4 + 2\eta}{l_1 + c + e} \right) \frac{1}{\left(1 + \frac{E_1 t_1}{E_4 t_4} \right)} \left(\frac{1}{2} \right) \\ &= \frac{1}{2} \frac{d(w_2 + w_3)}{ds} = 3A_{23}(c + e)^2 + C_{23} \quad , \end{aligned} \quad (144)$$

$$\begin{aligned} \frac{d^2 w_1}{dx_1^2} &= - \frac{M_{O1}}{D_1} = B_1 \xi_1^2 \sinh(\xi_1 l_1) \\ &= \frac{1}{2} \frac{d^2(w_2 + w_3)}{ds} + \frac{1}{2} \frac{d^2(w_2 - w_3)}{ds} = -6A_{23}(c + e) - \frac{M_{O1}}{2D} \end{aligned} \quad (145)$$

and, for sufficiently large $(\xi_1 l_1)$,

$$\sinh(\xi_1 l_1) \approx \cosh(\xi_1 l_1) \approx \frac{1}{2} e^{(\xi_1 l_1)} \quad , \quad (146)$$

while, at $x_4 = -l_4$, $s = (c - e)$,

$$\begin{aligned} w_4 &= -B_4 \sinh(\xi_4 l_4) - \left(\frac{t_1 + t_4 + 2\eta}{l_4 + c - e} \right) \frac{1}{\left(1 + \frac{E_4 t_4}{E_1 t_1} \right)} \left(\frac{l_4}{2} \right) \\ &= \frac{1}{2}(w_2 + w_3) = A_{23}(c - e)^3 + C_{23}(c - e) \quad , \end{aligned} \quad (147)$$

$$\begin{aligned} \frac{dw_4}{dx_4} &= +B_4 \xi_4 \cosh(\xi_4 l_4) + \left(\frac{t_1 + t_4 + 2\eta}{l_4 + c - e} \right) \frac{1}{\left(1 + \frac{E_4 t_4}{E_1 t_1} \right)} \left(\frac{1}{2} \right) \\ &\approx \frac{1}{2} \frac{d(w_2 + w_3)}{ds} = 3A_{23}(c - e)^2 + C_{23} \quad , \end{aligned} \quad (148)$$

$$\begin{aligned} \frac{d^2 w_4}{dx_4^2} &= + \frac{M_{O4}}{D_4} = -B_4 \xi_4^2 \sinh(\xi_4 l_4) \\ &= \frac{1}{2} \frac{d^2(w_2 + w_3)}{ds^2} - \frac{1}{2} \frac{d^2(w_2 - w_3)}{ds^2} = 6A_{23}(c - e) + \frac{M_{O4}}{2D_4} \end{aligned} \quad (149)$$

and, again, for sufficiently large $(\xi_4 l_4)$,

$$\sinh(\xi_4 l_4) \approx \cosh(\xi_4 l_4) \approx \frac{1}{2} e^{(\xi_4 l_4)} \quad . \quad (150)$$

According to the boundary conditions pertaining,

$$M_{O1} \left[1 + \xi_1(c + e) + \frac{1}{6}\xi_1^2(c + e)^2 \right] = \frac{P}{2} \left[\frac{t_1 + t_4 + 2\eta}{1 + \frac{E_1 t_1}{E_4 t_4}} \right], \quad (151)$$

$$M_{O4} \left[1 + \xi_4(c - e) + \frac{1}{6}\xi_4^2(c - e)^2 \right] = \frac{P}{2} \left[\frac{t_1 + t_4 + 2\eta}{1 + \frac{E_4 t_4}{E_1 t_1}} \right], \quad (152)$$

$$1 + \frac{e}{c} = \frac{2}{1 + \frac{M_{O4} D_1}{D_4 M_{O1}}}, \quad 1 - \frac{e}{c} = \frac{2}{1 + \frac{M_{O1} D_4}{D_1 M_{O4}}}. \quad (153)$$

Dividing equation (151) by (152), it is found that

$$\frac{M_{O1}}{M_{O4}} = \left(\frac{E_4 t_4}{E_1 t_1} \right) \frac{\left\{ 1 + \xi_4 c \left[\frac{2}{1 + \frac{M_{O1} D_4}{D_1 M_{O4}}} \right] + \frac{1}{6}\xi_4^2 c^2 \left[\frac{2}{1 + \frac{M_{O1} D_4}{D_1 M_{O4}}} \right]^2 \right\}}{\left\{ 1 + \xi_1 c \left[\frac{2}{1 + \frac{M_{O4} D_1}{D_4 M_{O1}}} \right] + \frac{1}{6}\xi_1^2 c^2 \left[\frac{2}{1 + \frac{M_{O4} D_1}{D_4 M_{O1}}} \right]^2 \right\}}. \quad (154)$$

Equation (154) can be solved by iteration to determine M_{O1}/M_{O4} which then permits of the evaluation of e/c by means of equations (153), in turn leading to independent expressions for M_{O1} and M_{O4} from equations (151) and (152). Unfortunately, an explicit analytical resolution of M_{O1} and M_{O4} is not possible.

The programming of equations (151) to (154) is straightforward, even to extent of accounting for laminated composite adherends by including non-unity values of κ_b . Once the bending moments M_{O1} and M_{O4} have been evaluated, the maximum adherend stress follows simply from equations (55) to (57) evaluated for the more critical adherend. For metal (isotropic) adherends, the thinner adherend is always more severely loaded than the thicker one. That this is so is apparent from equation (154). For low load intensities,

$$\frac{M_{O1}}{M_{O4}} \rightarrow \frac{E_4 t_4}{E_1 t_1} \quad \text{for } P \rightarrow 0, \quad (155)$$

so that the bending moments in the adherends at the ends of the joint are inversely proportional to the adherend extensional stiffnesses. Since the "thinner" adherend intrinsically has a lower bending stiffness than does the "thicker" adherend, this adherend imbalance imposes a severe stress concentration on the "thin" adherend, with respect to those bending stresses developed in a balanced joint. For filamentary composite adherends having markedly dissimilar values of the bending parameter k_b , it may be necessary to check each end of the joint separately to identify the more critical end, particularly if $k_b > 1$ for the thinner adherend and $k_b \ll 1$ for the thicker adherend.

Figure 27 depicts, in non-dimensionalized form, the strength degradation due to adherend stiffness imbalance for isotropic (metal) adherends. The failure mode considered is that of breaking the outermost "fiber" adjacent to the bond line at the end of the joint from which the thinner adherend extends. As is expected from the discussion above, any adherend stiffness imbalance is seen to significantly reduce further the joint efficiency. Just as in Figures 5 and 6, larger e/t ratios minimize the strength loss by effectively reducing the eccentricity in the load path. For short overlaps, the joint strength is approximately proportional to the adherend stiffness ratio. That is, for a given short overlap, a joint with a stiffness imbalance ratio of 2:1 is about half as strong as one made out of two of the thinner adherends of the unbalanced joint. The reason why two thin adherends are stronger than one thin and one thicker adherend is that, in the former case, each adherend deflects the same amount under load to relieve the eccentricity while, for the latter, practically all of the distortion is concentrated at that end of the joint from which the thinner adherend extends.

For filamentary composite adherends, the value of the bending stiffness parameter $k_b = D / [Et^3/12(1-\nu^2)]$ must be accounted for also. Figure 28, for $k_b = 2.0$ and $k_b = 0.5$ shows how, just as for balanced joints, concentrating the bending material near the neutral axis is detrimental to joint strength. This figure may be compared with Figure 6 for $k_b = 1$.

An important conclusion from the analysis of unbalanced single-lap joints is that they are so much more inefficient than balanced single-lap joints that their use should be avoided. In any case, the thicker (and presumably stronger) adherend cannot accept any more load than is carried in the thinner adherend.

8. EFFECT OF ADHEREND STIFFNESS IMBALANCE ON PEEL (INTERLAMINAR TENSION) FAILURES AT END OF JOINT

The preceding section quantifies the loss of joint strength for potential failures in the adherend just outside the joint. For thicker adherends, peel failures of the adhesive or interlaminar tension failures of the adherend(s) are more likely. Any adherend stiffness imbalance also affects the adhesive shear stress distribution, as outlined below. However, this latter failure mode is improbable for real-life materials in joints of practical geometric dimensions, so the subject is not pursued in detail.

Proceeding from equations (127) through (130) and with equations (13) and (14), two coupled differential equations can be deduced for the adhesive shear and peel stress distributions, as follows. From the shear strain definition

$$\gamma = \frac{1}{\eta}(u_3 - u_2) \quad (156)$$

$$\frac{d\gamma}{ds} = \frac{1}{E_3 t_3 \eta} \left[T_3 - \frac{6(1-\nu_3^2)M_3}{(k_b)_3 t_3} \right] - \frac{1}{E_2 t_2 \eta} \left[T_2 + \frac{6(1-\nu_2^2)M_2}{(k_b)_2 t_2} \right], \quad (157)$$

$$\begin{aligned} \frac{d^2\gamma}{ds^2} = & \frac{1}{E_3 t_3 \eta} \left\{ \tau - \frac{6(1-\nu_3^2)}{(k_b)_3 t_3} \left[v_3 - \tau \left(\frac{t_3 + \eta}{2} \right) \right] \right\} \\ & - \frac{1}{E_2 t_2 \eta} \left\{ -\tau + \frac{6(1-\nu_2^2)}{(k_b)_2 t_2} \left[v_2 - \tau \left(\frac{t_2 + \eta}{2} \right) \right] \right\}, \quad (158) \end{aligned}$$

$$\begin{aligned} \frac{d^3\gamma}{ds^3} = & \left\{ \frac{1}{E_3 t_3 \eta} \left[1 + \frac{3(1-\nu_3^2)}{(k_b)_3} \left(1 + \frac{\eta}{t_3} \right) \right] + \frac{1}{E_2 t_2 \eta} \left[1 + \frac{3(1-\nu_2^2)}{(k_b)_2} \left(1 + \frac{\eta}{t_2} \right) \right] \right\} \frac{d\tau}{ds} \\ & - \left\{ \left(\frac{1}{E_3 t_3 \eta} \right) \left[\frac{6(1-\nu_3^2)}{(k_b)_3 t_3} \right] - \left(\frac{1}{E_2 t_2 \eta} \right) \left[\frac{6(1-\nu_2^2)}{(k_b)_2 t_2} \right] \right\} \sigma_c \quad (159) \end{aligned}$$

and, for elastic adhesives,

$$\frac{d^3\gamma}{ds^3} = \frac{1}{G} \frac{d^3\tau}{ds^3} \quad (160)$$

Similarly, from the peel stress definition

$$\sigma_c = \frac{E_c}{\eta} (w_3 - w_2) \quad , \quad (161)$$

$$\left(\frac{\eta}{E_c}\right) \frac{d^2 \sigma_c}{ds^2} = -\frac{M_3}{D_3} + \frac{M_2}{D_2} \quad , \quad (162)$$

$$\left(\frac{\eta}{E_c}\right) \frac{d^3 \sigma_c}{ds^3} = -\frac{1}{D_3} \left[V_3 - \tau \left(\frac{t_3 + \eta}{2} \right) \right] + \frac{1}{D_2} \left[V_2 - \tau \left(\frac{t_2 + \eta}{2} \right) \right] \quad , \quad (163)$$

and

$$\begin{aligned} \left(\frac{\eta}{E_c}\right) \frac{d^4 \sigma_c}{ds^4} + 12 \left[\frac{(1 - \nu_3^2)}{(k_b)_3 E_3 t_3^3} + \frac{(1 - \nu_2^2)}{(k_b)_2 E_2 t_2^3} \right] \sigma_c \\ = 6 \left[\frac{(1 - \nu_3^2)(1 + \eta/t_3)}{(k_b)_3 E_3 t_3} - \frac{(1 - \nu_2^2)(1 + \eta/t_2)}{(k_b)_2 E_2 t_2} \right] \frac{d\tau}{ds} \quad . \quad (164) \end{aligned}$$

Equations (159) and (164) are the coupled differential equations governing the adhesive stresses for arbitrary unsupported single-lap joints. Whenever the adherends are identical, the coupling terms drop out.

For the purely elastic material case, equation (164) can be employed to eliminate the derivatives of τ from equations (159) and (160), leading to a sixth-order differential equation in σ_c . Similarly, equations (159) and (160) permit the σ_c derivatives to be eliminated from equation (164), leading to a seventh-order differential equation in τ . For the plastic zones at the end(s) of the overlap, $d\tau/ds = 0$ and equation (164) then provides a solution for σ_c which can be substituted into equation (159) for the shear strain γ . Because of the coupling between the adhesive stresses, the general solution involves matching a large number of boundary conditions to determine the 13 integration constants. This must be done not only at the ends of the overlap but also at any transition from elastic to plastic behavior within the adhesive.

An approximate simpler solution is available for the peel stresses (but not for the shear stresses) in an unbalanced single-lap joint by recognizing that, for practically all good structural adhesives, the shear stress is in the plastic state for one or both end zones and that it is there that the only severe peel stresses are developed. With reference to equation (164), then, an approximate solution for the adhesive peel stresses follows from

$$\frac{d^4 \sigma_c}{ds^4} + 12 \frac{E_c}{\eta} \left[\frac{(1 - \nu_3^2)}{(k_b)_3 E_3 t_3^3} + \frac{(1 - \nu_2^2)}{(k_b)_2 E_2 t_2^3} \right] \sigma_c = 0 \quad (165)$$

as

$$\begin{aligned} \sigma_c = & A \cos(\chi s) \cosh(\chi s) + B \sin(\chi s) \sinh(\chi s) \\ & + C \cos(\chi s) \sinh(\chi s) + D \sin(\chi s) \cosh(\chi s) \end{aligned} \quad (166)$$

where, here,

$$\chi^4 = \frac{E_c}{4\eta} \left[\frac{1}{D_1} + \frac{1}{D_4} \right] = \frac{3E_c}{\eta} \left[\frac{(1 - \nu_4^2)}{(k_b)_4 E_4 t_4^3} + \frac{(1 - \nu_1^2)}{(k_b)_1 E_1 t_1^3} \right] \quad (167)$$

The boundary conditions determining the integration constants in equation (166) include

$$\int_{-c}^{+c} \sigma_c ds = 0, \quad (168)$$

whence

$$\begin{aligned} & A[\sin(\chi c) \cosh(\chi c) + \cos(\chi c) \sinh(\chi c)] + \\ & B[\sin(\chi c) \cosh(\chi c) - \cos(\chi c) \sinh(\chi c)] = 0 \end{aligned} \quad (169)$$

Just as in the analysis of peel stresses in balanced joints, the approximations

$$\sinh(\chi c) \approx \cosh(\chi c) + \frac{1}{2} e^{(\chi c)} \quad (170)$$

are employed for joints of practical geometry. Consequently

$$A[\sin(\chi c) + \cos(\chi c)] + B[\sin(\chi c) - \cos(\chi c)] = 0 \quad (171)$$

In order to derive an explicit solution for the critical peel stress, it is necessary to derive an equation in the other two integration constants, C and D in equation (166), which is equivalent to equation (171). The procedure is as follows. Reference to Figure 26 reveals that, for an unbalanced joint, the bending moments in the adherends are zero at a distance $e \leq c$ off the middle of the overlap. The eccentricity e is evaluated in equations (153) as

$$\frac{e}{c} = \frac{\left(\frac{M_{o1}}{D_1} \frac{D_4}{M_{o4}} - \frac{M_{o4}}{D_4} \frac{D_1}{M_{o1}} \right)}{\left(2 + \frac{M_{o4}}{D_4} \frac{D_1}{M_{o1}} + \frac{M_{o1}}{D_1} \frac{D_4}{M_{o4}} \right)} = \frac{\left(\frac{M_{o1}}{D_1} - \frac{M_{o4}}{D_4} \right)}{\left(\frac{M_{o1}}{D_1} + \frac{M_{o4}}{D_4} \right)} \quad (172)$$

Since there is no transverse shear stress across the adherends at $s = e$, it is necessary that

$$\int_e^c \sigma_c ds = 0 \quad \text{and} \quad \int_{-c}^e \sigma_c ds = 0 \quad (173)$$

In terms of equation (166), then,

$$\begin{aligned} & A[\sin(\chi e)\cosh(\chi e) + \cos(\chi e)\sinh(\chi e) - \sin(\chi e)\cosh(\chi e) - \cos(\chi e)\sinh(\chi e)] \\ & + B[\sin(\chi e)\cosh(\chi e) - \cos(\chi e)\sinh(\chi e) - \sin(\chi e)\cosh(\chi e) + \cos(\chi e)\sinh(\chi e)] \\ & + C[\sin(\chi e)\sinh(\chi e) + \cos(\chi e)\cosh(\chi e) - \sin(\chi e)\sinh(\chi e) - \cos(\chi e)\cosh(\chi e)] \\ & + D[\sin(\chi e)\sinh(\chi e) - \cos(\chi e)\cosh(\chi e) - \sin(\chi e)\sinh(\chi e) + \cos(\chi e)\cosh(\chi e)] \\ & = 0 \end{aligned} \quad (174)$$

and

$$\begin{aligned} & A[\sin(\chi e)\cosh(\chi e) + \cos(\chi e)\sinh(\chi e) + \sin(\chi e)\cosh(\chi e) + \cos(\chi e)\sinh(\chi e)] \\ & + B[\sin(\chi e)\cosh(\chi e) - \cos(\chi e)\sinh(\chi e) + \sin(\chi e)\cosh(\chi e) - \cos(\chi e)\sinh(\chi e)] \\ & + C[\sin(\chi e)\sinh(\chi e) + \cos(\chi e)\cosh(\chi e) - \sin(\chi e)\sinh(\chi e) - \cos(\chi e)\cosh(\chi e)] \\ & + D[\sin(\chi e)\sinh(\chi e) - \cos(\chi e)\cosh(\chi e) - \sin(\chi e)\sinh(\chi e) + \cos(\chi e)\cosh(\chi e)] \\ & = 0 \end{aligned} \quad (175)$$

Equation (169) results from the addition of equations (174) and (175). Their subtraction leads to

$$\begin{aligned} & C[\sin(\chi e)\sinh(\chi e) + \cos(\chi e)\cosh(\chi e)] + D[\sin(\chi e)\sinh(\chi e) - \cos(\chi e)\cosh(\chi e)] \\ & - A[\sin(\chi e)\cosh(\chi e) + \cos(\chi e)\sinh(\chi e)] - B[\sin(\chi e)\cosh(\chi e) - \cos(\chi e)\sinh(\chi e)] \\ & - C[\sin(\chi e)\sinh(\chi e) + \cos(\chi e)\cosh(\chi e)] - D[\sin(\chi e)\sinh(\chi e) - \cos(\chi e)\cosh(\chi e)] \\ & = 0 \end{aligned} \quad (176)$$

Strictly speaking, no further simplification of equation (176) is possible. However, subject to the usual practical constraints of small adherend stiffness imbalance ($e \approx 0$) and large overlap to minimize the structural joint inefficiency, one may set

$$C[\sin(\chi e) + \cos(\chi e)] + D[\sin(\chi e) - \cos(\chi e)] = 0 \quad (177)$$

to provide consistency with equation (171). Subject to the exclusion of short overlaps and severe stiffness imbalances between the adherends, the analysis

proceeds, as follows, from equation (162). With reference to Figure 26, at the left-hand side of the joint

$$\frac{E_c}{\eta} \frac{M_{O1}}{D_1} \frac{1}{\frac{1}{2}\chi^2 e^{(\chi c)}} \approx -2(A - C)\sin(\chi c) + 2(B - D)\cos(\chi c) \quad (178)$$

while, at the right-hand end,

$$\frac{E_c}{\eta} \frac{M_{O4}}{D_4} \frac{1}{\frac{1}{2}\chi^2 e^{(\chi c)}} \approx -2(A + C)\sin(\chi c) + 2(B + D)\cos(\chi c) \quad (179)$$

Similarly, from equations (166) and (170), at the left-hand end of the joint

$$\sigma_c = \frac{1}{2} e^{(\chi c)} [(A - C)\cos(\chi c) + (B - D)\sin(\chi c)] \quad (180)$$

while, at the right-hand end,

$$\sigma_c = \frac{1}{2} e^{(\chi c)} [(A + C)\cos(\chi c) + (B + D)\sin(\chi c)] \quad (181)$$

Equations (171) and (177) enable the direct expression of the σ 's in terms of the M_O 's by elimination of the integration constants A to D. Adding together and subtracting, in turn, equations (178) and (179) provides

$$\frac{2E_c}{\eta\chi^2} \frac{1}{e^{(\chi c)}} \left[\frac{M_{O1}}{D_1} + \frac{M_{O4}}{D_4} \right] = -4A \sin(\chi c) + 4B \cos(\chi c) \quad (182)$$

and

$$\frac{2E_c}{\eta\chi^2} \frac{1}{e^{(\chi c)}} \left[\frac{M_{O1}}{D_1} - \frac{M_{O4}}{D_4} \right] = 4C \sin(\chi c) - 4D \cos(\chi c) \quad (183)$$

Equations (171) and (177) may be re-arranged in the form

$$A \cos(\chi c) + B \sin(\chi c) = -A \sin(\chi c) + B \cos(\chi c) \quad (184)$$

and

$$C \cos(\chi c) + D \sin(\chi c) = -C \sin(\chi c) + D \cos(\chi c) \quad (185)$$

It then follows from equations (178) to (183) that, at the left-hand end of the joint,

$$\sigma_c = \frac{E_c}{2\eta} \frac{M_{O1}}{D_1 \chi^2} \quad (186)$$

while, at the right-hand end,

$$\sigma_c = \frac{E_c M_{O4}}{2\eta D_4 X^2} \quad (187)$$

The critical end of the joint in peel (interlaminar tension) is the same end as that which is critical for bending. Any adherend stiffness imbalance is seen to aggravate the peel stress problem.

The bending moments M_{O1} and M_{O4} are derived as explained in the preceding section. Equations (186) and (187) may be re-expressed in non-dimensionalized form. In the event that the adherend 1 end of the joint is more critical, at the end $s = -c$,

$$\frac{\sigma_{\text{peel}}}{(\sigma_{\text{avg}})_1} = k_1 \left\{ \frac{3(1-\nu_1^2)E_c t_1 \left(1 + \frac{\eta}{t_1}\right)^2}{E_1 \eta \left[1 + \frac{(k_b)_1 E_1 t_1^3 (1-\nu_4^2)}{(k_b)_4 E_4 t_4^3 (1-\nu_1^2)} \right]} \right\}^{\frac{1}{2}}, \quad (188)$$

in which

$$k_1 = \frac{2M_{O1}}{F t_1 \left(1 + \frac{\eta}{t_1}\right)} = \frac{1}{1 + \xi_1 c + \frac{1}{6}(\xi_1 c)^2} \quad (189)$$

In the event that the adherend 4 end of the joint ($s = +c$) is the more critical, the subscripts 1 and 4 are to be interchanged. Equation (188) includes the influence of filamentary composite adherends as well as of adherend stiffness imbalance. As explained above, its use should be restricted to small adherend mismatches and those other curves deduced from it and shown in Figure 29 are indicative of the trend in behavior, rather than of precise values for large mismatches. Because of the severe peel stresses predicted for short overlaps and widely dissimilar adherends, the associated joint strengths will be intolerably small, even when computed more accurately.

9. EFFECT OF THERMAL MISMATCH BETWEEN ADHERENDS

When a single-lap bonded joint in which the adherends have different coefficients of thermal expansion is operated at a temperature different from that at which the adhesive is cured, there are initial curvatures due to locked-in strains. These influence the already eccentric load path and thereby change the bending moments at the ends of the joint which, in turn, affect the adhesive shear and peel stress distributions. The joint load capacity is usually decreased since one end of the joint is rendered more critical than the other. The analytical formulation of this problem is straightforward, following the approach adopted in Reference 12. However, since it is not possible to obtain explicit expressions (which would be valid for all geometries outside the joint) for the bending moments M_{01} and M_{04} at the ends of the joint, each individual case must be solved by iteration (preferably on a digital computer). Therefore the practical utility of such an analysis as a design technique is severely limited, so the analysis is not developed here. Instead, a qualitative description of the various factors interacting is provided in Figure 30. The eccentricity in the load path is influenced by the length of adherends outside the joint. This is evident from the upper part of Figure 30, and is the reason for the comment above that no explicit expressions could be obtained for M_{01} and M_{04} independently of the geometry outside the joint. It is evident from the lower illustration in Figure 30 that, in the absence of any stiffness imbalance between the adherends, the thermal mismatch has increased the bending moment in the adherend of lower coefficient of thermal expansion (which is usually the composite end of a composite-to-metal joint) whenever the operating temperature is less than the adhesive curing temperature, which is usually the situation prevailing. The influence of this initial curvature and increased bending moment is to alleviate the load carried at the other end of the joint, thereby decreasing the joint efficiency with respect to a balanced joint. This reduction applies to all three possible modes of failure.

10. PARAMETRIC EFFECTS

The analyses of Sections 2, 3 and 4 have established that the plastic behavior of most good structural adhesives in shear is so significant that, usually, joint failure is initiated in the adherend(s) just outside the joint. Three separate analysis techniques have been prepared for: (1) the bond shear strength, on the assumption that the adherends behave linearly elastically and that the peel strength is greater than the shear strength, (2) the bending failure of the adherend under the eccentric load path, assuming adequate bond shear and peel strengths, and (3) the peel failure of adhesive (for metal adherends) or the transverse tension failure of the laminates (for filamentary composite adherends) under the assumption of adequate adherend strength and adhesive shear strength. In the case of adhesive failure with metal adherends, there is probably an interaction between peel and shear failures over a small range of thicknesses. The theories do not account for this interaction and represent the asymptotic behavior when one case or other dominates. Likewise, for highly ductile adhesives, the yielding of metal adherends just outside the joint does not constitute immediate failure the way it does for brittle adhesives. Some increase in load capacity remains, even though the structure has been permanently deformed. The analyses established also that longer overlaps enhanced the joint efficiency significantly, that tough ductile adhesives produced much stronger joints than the stronger more brittle variety, and that the combination of unbalanced adherends degraded the joint strength to below that which would be obtained using two adherends each the same as the thinner (weaker) of the unbalanced combination.

Figure 31 provides a comparison of the relative strengths of ductile and brittle adhesives with the strength of 0.060 inch thick aluminum adherends. The adherend yield line is derived on the assumption that the adhesive bond has adequate strength while the potential adhesive shear strengths are based on the assumption that the adherends had the same modulus E but a much greater ultimate strength than they actually possess in order to eliminate from the analysis the effects of adherend yielding. Naturally there can be no failures observed above the ultimate strength cut-off at 42 kips per inch. Even though the brittle adhesive has a much higher peak shear stress (10,000 psi) than does the ductile

adhesive (4,500 psi), the former is seen to produce a much weaker joint owing to its lack of ductility. While the perfectly brittle adhesive ($\gamma_p/\gamma_e = 0$) shown is of comparable strength with the yield strength of the adherend, this is only because of the artificial exclusion of the small ductility that even brittle adhesives possess. While small, this ductility is sufficient to ensure that, for 0.060 inch thick aluminum adherends at least, that real structural adhesives are never responsible for initiating failure, provided that the overlap exceeds a certain minimum (0.33 inch in the case shown in Figure 31). Once the adherend bending moment has been relieved by yielding, the adherend capability is increased to its ultimate strength, so it is the bond which is observed to fail. Depending on the amount of adhesive ductility present, failure of the adhesive will occur somewhere between the formation of the plastic hinge (yielding on only the adhesive side of the adherend) and the gross yielding of the entire thickness. The yielding at the end of the joint exceeds the adhesive shear or peel strain capacity locally and the adhesive fractures progressively as the effective overlap decreases. Consequently, with reference to Figure 31, all test results will be bounded within the triangle formed by the adherend yield strength (or ultimate load) on top, the adherend proportional limit load (formation of plastic hinge) below, and the adhesive shear or peel characteristic to the left for short overlaps. The most ductile adhesives will develop strengths approaching the ultimate adherend strengths while the very brittle adhesives will barely exceed the adherend plastic hinge formation. The only exceptions to this rule fall in the class of the non-structural sealants specifically formulated to break apart easily for inspection or repair and which serve only as a sealant. Even the better room-temperature curing two-part epoxy survives until after the adherend yields unless an excessively thick glue line (or inadequate overlap) is responsible for a greater moment M_0 than would be associated with a 0.005 inch thick standard bond line.

Figure 31 is prepared specifically for a single adherend thickness. Figure 32 presents the joint loads at the formation of the plastic hinges for a range of aluminum adherend thicknesses. The adherend limit loads shown are, strictly speaking, proportional limits and may well exceed two thirds of the ultimate capacity. It should be remembered also that, just because failure is induced by the adherend, it does not follow that the joint efficiency is at its maximum. Just as shown in Figure 32, strength increases are to be obtained by

increasing the overlap until the asymptotic limit (shown for thin adherends) is attained.

A further variable to be considered is that of the adherend material and modulus. Figure 33 reveals how those adherends with high strength and modulus (such as steel) exhibit both higher potential bond shear strengths and adherend plastic hinge formation loads. This explains a well-known phenomenon according to which a given adhesive will develop higher single-lap shear values with steel or titanium adherends than with aluminum. This is not due to better adhesion at all, as is well recognized for titanium (which is very difficult to bond to well), but simply to the different elasto-mechanical properties. Likewise, a thicker adherend of the same material also appears to enhance the bond strength, as shown in Figure 32.

11. JOINT EFFICIENCY CHARTS FOR SINGLE-LAP JOINTS

The analyses performed above can be employed in the generation of joint efficiency diagrams. A computer program has been prepared in the Appendix for unsupported single-lap joints between identical adherends. Sample outputs have been illustrated for commonly used aerospace materials. The computer program has been prepared for arbitrary materials but the joint efficiency charts (Figures 17 to 24) have been restricted to room-temperature performance of a single example of the best of the 350 °F curing ductile and brittle adhesives. The joint strengths follow from the joint efficiencies (or, more sensibly, inefficiencies since they must inevitably be less than unity for practical joint proportions) by multiplying the basic adherend strength $F_{tu}t$ by the efficiency. An example of this is provided in Figure 34. The material properties used in preparing these charts are recorded in Table 1. The adhesives have not been identified because the effective peel properties of constrained adhesive films have not yet been measured sufficiently precisely. Also, the very thin composite adherends do not reflect the discrete limitations on balanced laminate thicknesses derivable from a particular ply thickness. Similarly, the effect of stacking sequence ($k_b \neq 1$) has been omitted to clarify the presentation. Certain trends are evident from these charts. In the first place, the very powerful role of the l/t ratio in minimizing the inherent inefficiency of the joint is quite apparent. Next, the severe limitations imposed on filamentary composites by the low interlaminar shear strengths are exemplified. This problem is seen to become progressively more acute as the adherend thickness is increased. Indeed, for any given l/t ratio, the peel (interlaminar tension) problem imposes a rapid degradation in joint strength beyond some defined overlap. Adhesive shear failures are seen to have surprisingly little effect on the predicted joint strengths. Adhesive shear failures are shown, in Figures 17 to 24 and 34 to be limited to two characteristic zones. The first is for short overlaps and high strength adherend materials while the second is for thick adherends with sufficiently long overlaps to alleviate the peel stress problem. Other than these situations, adherend bending governs the thinner adherends and peel stresses the thicker adherends.

Caution should be exercised in attempting to extrapolate these diagrams to thin

adherends and short overlaps because of two simplifications incorporated in the computer program. The adhesive peel stresses induce transverse strains in the adjacent adherends which, in turn, influence the bending moments set up in the adherends. To account for this effect precisely one would have to relax the simplifying assumption that the adhesive stresses do not vary through the thickness. To do so would result in considerable analytical complexities including an increase in the degree of the governing differential equations. Instead, the following simple technique has been adopted to account for this factor in an approximate manner. A constant thickness of the adherend three times as thick as the adhesive layer has been considered affected by the peel stresses on each side of the adhesive layer. Therefore, the effective peel modulus of the joint is given by

$$\frac{1}{E_c'} = \frac{1}{E_c} + \frac{6}{E_n} \quad (190)$$

Obviously this approximation becomes questionable as the adherend thickness approaches the adhesive thickness. The number 6 above was selected after trial runs with 2 because it gives predictions in better accord with the standard lap-shear data. Drastic changes in this constant (as from 2 to 6) effect only a few per cent change in joint efficiency, so a precise determination may be unnecessary. The second limitation on the computer program restricts it from applying to such geometries as the half-inch thick single-lap specimen now used to derive experimental stress-strain curves. This limitation derives from equation (35) and prevents the solution from applying to short overlaps with essentially uniform shear stress. Such a restriction is not considered excessive, however, because structural joints, as distinct from purely experimental joints always employ much greater l/t ratios.

These joint efficiency charts elucidate the inherently low efficiency of unsupported single-lap joints and the motivation for providing a moment-resistant support to improve efficiency.

12. THE STANDARD HALF-INCH SINGLE-LAP JOINT TEST

Over the years a tremendous number of the standard tensile lap shear tests (ASTM # D-1002) have been performed by many organizations in the mistaken belief that the failure load was in some way related to the shear strength of the adhesive being tested. The purpose of this section is to debunk that myth once and for all. This is not to imply that the test should be discarded, because there is no other test which, in a single measurement, obtains so inexpensively a simultaneous assessment of all sorts of adhesive properties. A decrease in any one property reduces the failure load of the joint, even if the property responsible cannot be identified. It is a fine screening and quality control specimen, but the hypothetical shear stress deduced by dividing the failure load by the bond area has no merit in any rational design process. Indeed, the peel stress influences this failure more than does the shear stress. The failure in the standard lap-shear test is almost invariably initiated by yielding of the aluminum adherends just outside the joint. The strength obtained is shown in Figure 5 to have a markedly non-linear dependence on the l/t ratio as well as separately on the adherend thickness. The failure loads simply do not scale up proportionally with the bond area, even if one ignores the problem of the adhesive layer thickness not scaling up in proportion to the other dimensions.

As a quantitative verification of this criticism of using single-lap shear data for design purposes, consider the case of FM-47. This vinyl-phenolic highly-ductile adhesive as known to develop a peak shear stress of 10,000 to 12,000 psi at 75 °F when characterized by a torsion-ring experiment. Yet lap-shear tests on 0.5 inch overlaps of 0.064 inch thick 2024-T3 aluminum alloy exhibit only 4,800 psi "shear" stress at failure. This value is observed to be raised to 8,000 psi for 0.064 inch 301 half-hard stainless steel adherends with half-inch overlap single-lap tests. It is evident, therefore, that the standard half-inch single-lap tensile shear tests do not characterize adhesive shear stress in a quantitative manner. They serve merely to separate brittle from ductile adhesives.

With reference to the lower left corner of Figure 33, and proceeding upwards along the half-inch overlap line, it is clear that 3000 psi average shear stress marks the transition at the formation of the plastic hinge. That is to say that any adhesive developing significantly more than 3000 psi on this test for 7075-T6 aluminum (or somewhat less for 2024-T3 which yields at a much lower stress) inevitably has significant "plasticity" so that the maximum overlap at which the adhesive remains fully-plastic throughout is in excess of 0.5 inch. Those adhesives developing significantly less than 3000 psi with this test must inevitably be so brittle as not to permit even the low joint efficiency of the adherend (34 per cent) to be developed in unsupported single-lap joints. Subject to the exclusion of those cases requiring high-temperature operating environments, which exclude the use of ductile adhesives, all of the best structural adhesives employed in the commercial aircraft industry (operating requirements from -67 °F to +160 °F) exceed 4000 psi on the standard single-lap tensile shear test, yet most of these have a maximum shear stress of less than 7000 psi when measured with a torsion-ring or thick-adherend specimen.

Figure 32 should suffice to prove the unreliability of designing in terms of an "allowable" average shear stress and a bond area. The fully-plastic adhesive failure line shown corresponds to the true material maximum shear stress of 4500 psi. Suppose an arbitrary lower design stress of 2000 psi were to be specified. This would appear as a radial line from the origin through the point ($\ell = 5$ inch, $P = 10,000$ kips per inch). Any design on the 2000 psi line which was below the true adhesive strength line (governed by adherend bending in the cases shown) would represent a realizable situation but, anywhere to the right of the intersection of those lines, an overestimate of the joint strength would result. For example, for $\ell = 5$ inch, the average shear stress actually developable on a 0.080 inch thick adherend is just less than 1000 psi. Figure 33 illustrates these radial constant average stress lines. Figure 33 also demonstrates how an "allowable" adhesive shear stress value mysteriously changes with the material from which the adherends are made. There is just no rational basis for design in terms of load equal to bond area multiplied by standard single-lap shear stress (or any other uniform allowable shear stress for that matter), and this widespread practice should be discontinued. Probably the only things that have saved major problems with such an approach are the arbitrarily low (1000 to 1500 psi) "allowables" which have been established for bonding and that most

aerospace bonding with single- or double-lap joints is confined to thin sheets well within the true capabilities of the adhesive when its plastic behavior is considered.

In any case, the present approach of designing in terms of elastic-plastic stress-strain adhesive characteristics in adhesive shear and of including distinct peel-stress phenomena does permit bonded joint design to be placed on a rational basis.

13. CONCLUSIONS

Iterative closed-form analytical solutions for single-lap adhesive-bonded joints have been derived which account explicitly for adhesive plasticity, and adherend stiffness imbalance. Three distinct failure modes are covered: adherend failure induced by bending due to the eccentric load path, peel (or transverse tension) failure, and shear failure of the adhesive. Somewhat surprisingly, in view of the basic shear nature of the applied load, the latter failure mode is rare for real materials in joints of practical proportions. Joint inefficiency charts have been prepared for representative material combinations. These emphasize how a drastic efficiency reduction is imposed by the eccentricity in the load path and that, beyond a certain thickness (for each l/t ratio), peel failures of the adhesive or interlaminar tension failures of the laminated adherend result in even less efficient utilization of the adherend material.

A technique is described for alleviating the eccentricity problems which is particularly suited to filamentary composite adherends. This involves the judicious build-up of the laminate in the overlap area.

Because the transverse deflections of unsupported single-lap joints induce significant bending stresses in the adherend, thereby limiting the average stress capability, it is recommended that good design practice should provide moment restraint to minimize the transverse deflections. In such a case, the simpler analysis for one side of a double-lap joint applies.

While the single-lap joint can be a useful and inexpensive quality control test, it represents a very poor approach to generating design data. The reasons why it is poor are that joint strengths do not scale up linearly with the bond area and that predominantly adhesive shear failures are just as rare with single-lap structural joints as they are with test specimens.

REPRODUCTION OF THIS DOCUMENT IS PROHIBITED

REFERENCES

1. Goland, M. and Reissner, E., "The Stresses in Cemented Joints," J. Appl. Mech. 11, A17-A27 (1944).
2. Hahn, K., "Photostress Investigation of Bonded Lap Joints," Part I - Theoretical Analysis, Douglas Aircraft Co., Research Report SM-40001, (1960).
3. Hahn, K., "Stress Distribution in Adherends of Bonded Lap Joints," Part I - Theoretical Analysis and Part II - Analysis of Experimental Data (with Computer Program in Appendix), Douglas Aircraft Co., Research Report SM-40010, (1961).
4. Hahn, K. F. and Fouser, D. F., "Methods for Determining Stress Distribution in Adherends and Adhesives," Symposium on Adhesives for Structural Applications, (Ed. Bodnar, M. J.), pp. 25-29, Picatinny Arsenal 1961, Interscience, (1962).
5. Kuenzi, E. W. and Stevens, G. H., "Determination of Mechanical Properties of Adhesives for Use in the Design of Bonded Joints," U.S. Forest Service Research Note FPL-011, September 1963.
6. Kutscha, D. and Hofer, K. E. Jr., "Feasibility of Joining Advanced Composite Flight Vehicle Structures," IIT Research Institute, Technical Report AFML-TR-68-391, January 1969.
7. Kutscha, D., "Mechanics of Adhesive Bonded Lap-Type Joints: Survey and Review," Technical Report AFML-TDR-64-298, Forest Products Laboratory, December 1964.
8. Grimes, G. C., Calcote, L. R., Wah, T. et al., "The Development of Non-Linear Analysis Methods for Bonded Joints and Advanced Filamentary Composite Structures," Southwest Research Institute, R&D Interim Technical Report No. 1, August 1969.

9. Dickson, J. N., Hsu, T. M., and McKinney, J. M., "Development of an Understanding of the Fatigue Phenomena of Bonded and Bolted Joints in Advanced Filamentary Composite Materials," Lockheed-Georgia Co., Technical Report AFFDL-TR-72-64, Volume 1, June 1972.
10. Goodwin, J. F., "Research on Thermomechanical Analysis of Brazed or Bonded Structural Joints," FAA, USAF, NASA Contract Technical Report ASD-TDR-63-447, Douglas Aircraft Co., September 1963.
11. Hart-Smith, L. J., "The Strength of Adhesive-Bonded Double-Lap Joints," Douglas Aircraft Co., IRAD Technical Report MDC-J0367, November 1969.
12. Hart-Smith, L. J., "Adhesive-Bonded Double-Lap Joints," Douglas Aircraft Co., NASA Langley Contract Report CR-112235, January 1973.
13. Hart-Smith, L. J., "The Strength of Adhesive-Bonded Single-Lap Joints," Douglas Aircraft Co., IRAD Technical Report MDC-J0742, April 1970.

TABLE I. MATERIAL PROPERTIES FOR FIGURES 17 TO 24 AND 34

7075-T6 ALUMINUM ALLOY:

$$E = 10.3 \times 10^6 \text{ psi}, F_{ty} = 70 \text{ ksi}, F_{tu} = 80 \text{ ksi}.$$

HIGH-STRENGTH GRAPHITE-EPOXY:

$(0^\circ/+45^\circ/90^\circ/-45^\circ)_s$ pattern:

$$E_L^t = 8.0 \times 10^6 \text{ psi}, E_N^t = 1.7 \times 10^6 \text{ psi},$$

$$F_L^{tu} = 69 \text{ ksi}, F_N^{tu} = 8 \text{ ksi},$$

$(0^\circ/+45^\circ/0^\circ/-45^\circ)_s$ pattern:

$$E_L^t = 11.9 \times 10^6 \text{ psi}, E_N^t = 1.7 \times 10^6 \text{ psi},$$

$$F_L^{tu} = 103 \text{ ksi}, F_N^{tu} = 8 \text{ ksi},$$

(0°) unidirectional laminate:

$$E_L^t = 21.0 \times 10^6 \text{ psi}, E_N^t = 1.7 \times 10^6 \text{ psi},$$

$$F_L^{tu} = 180 \text{ ksi}, F_N^{tu} = 8 \text{ ksi},$$

(in which the subscript N refers to properties in the thickness direction).

DUCTILE ADHESIVE:

$$\tau_p = 6 \text{ ksi}, \eta = 0.005 \text{ in.}, \gamma_p/\gamma_e = 20, \eta(\frac{1}{2}\gamma_e + \gamma_p) = 0.0102 \text{ in.},$$

$$E_c \approx 500 \text{ ksi}, \sigma_{c_{\max}} \approx 10 \text{ ksi}.$$

BRITTLE ADHESIVE:

$$\tau_p = 9 \text{ ksi}, \eta = 0.005 \text{ in.}, \gamma_p/\gamma_e = 1.5, \eta(\frac{1}{2}\gamma_e + \gamma_p) = 0.00042 \text{ in.},$$

$$E_c \approx 1500 \text{ ksi}, \sigma_{c_{\max}} \approx 17 \text{ ksi}.$$

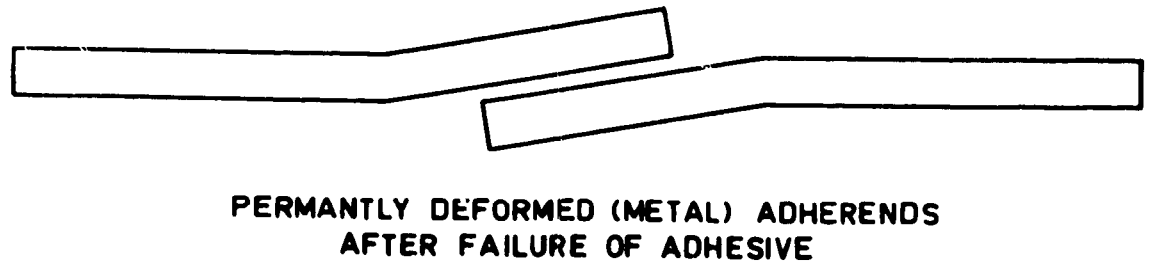
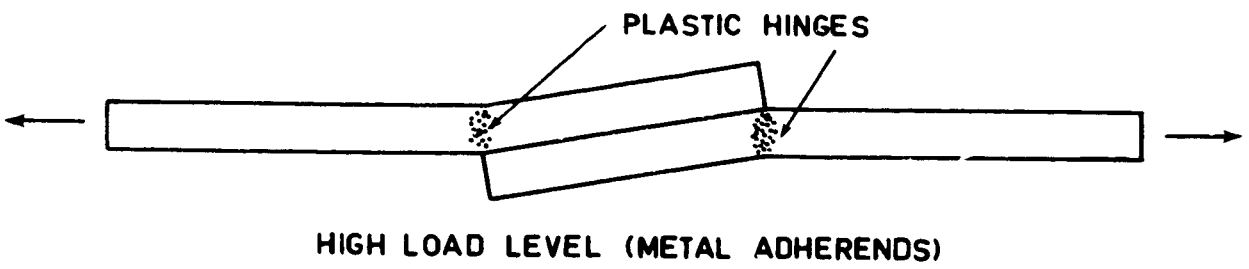
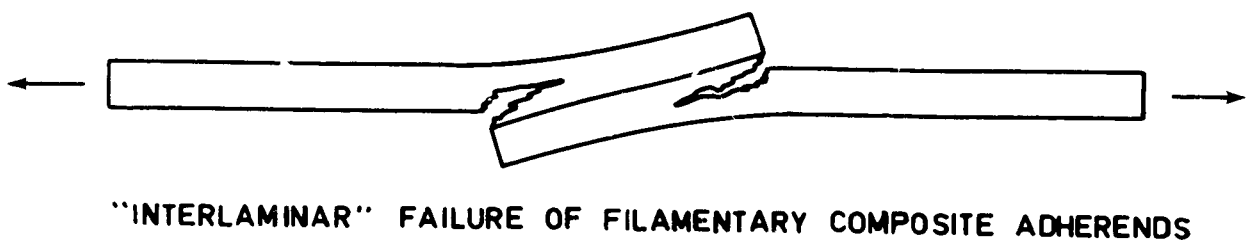
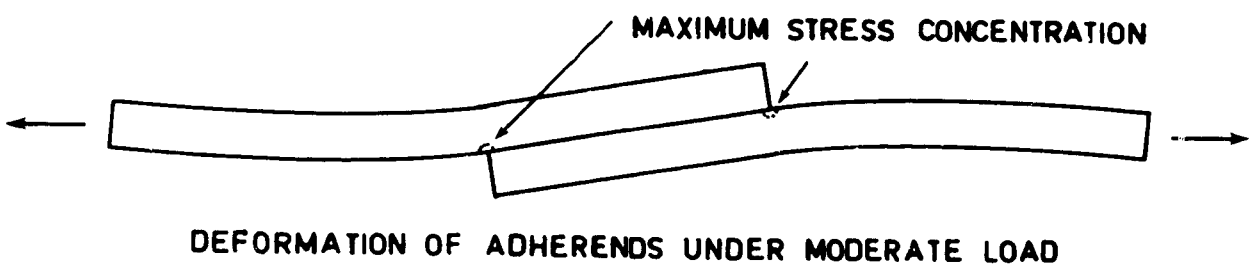
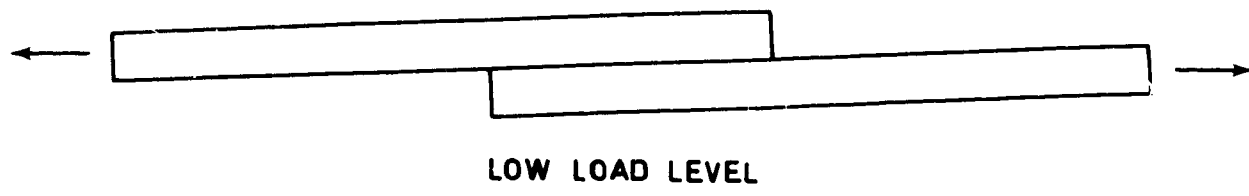

FIGURE 1. FAILURE OF SINGLE-LAP BONDED JOINTS WITH BRITTLE AND WITH YIELDING ADHERENDS

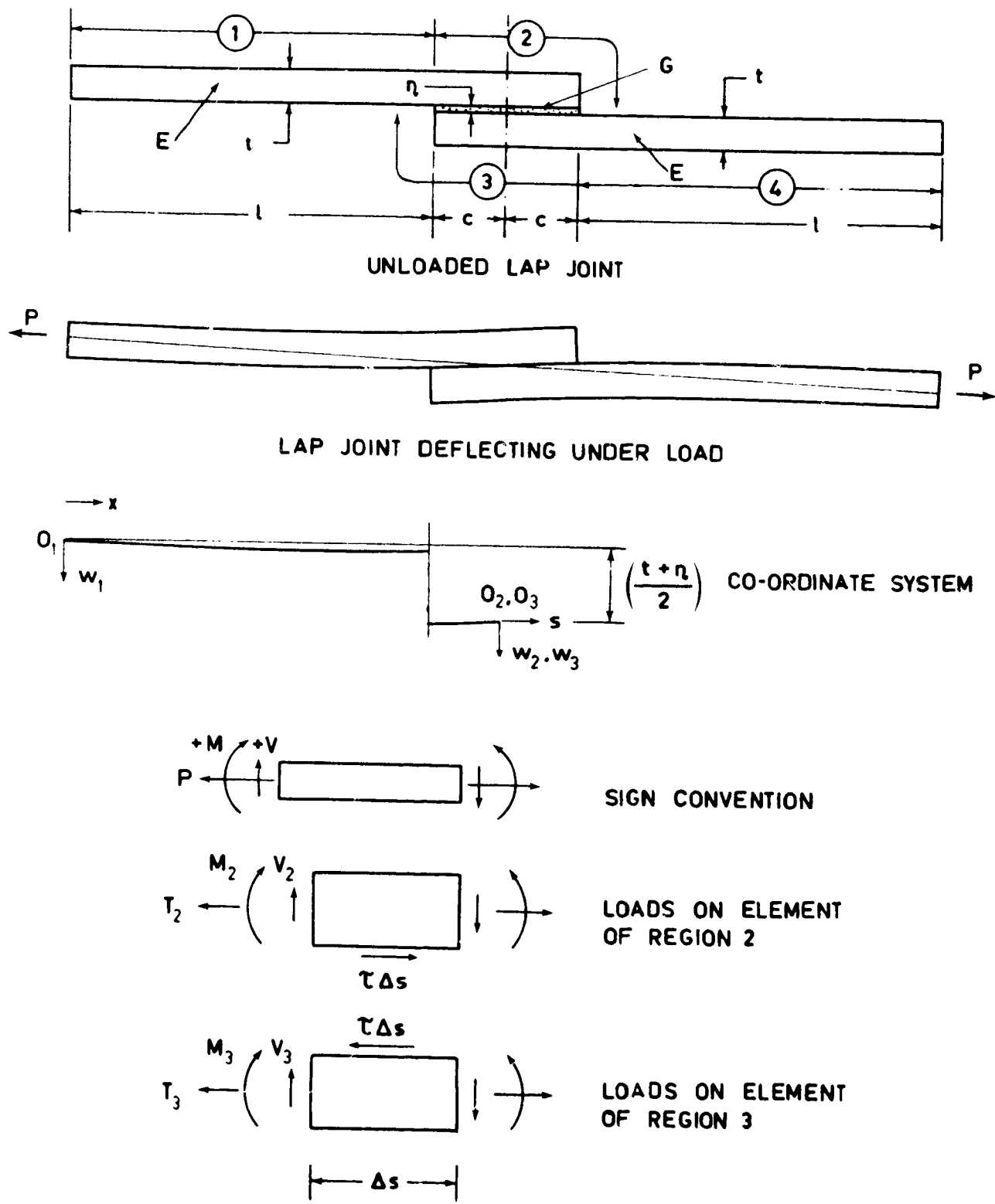

FIGURE 2. CO-ORDINATE SYSTEM AND DEFORMATIONS IN BALANCED SINGLE-LAP BONDED JOINTS

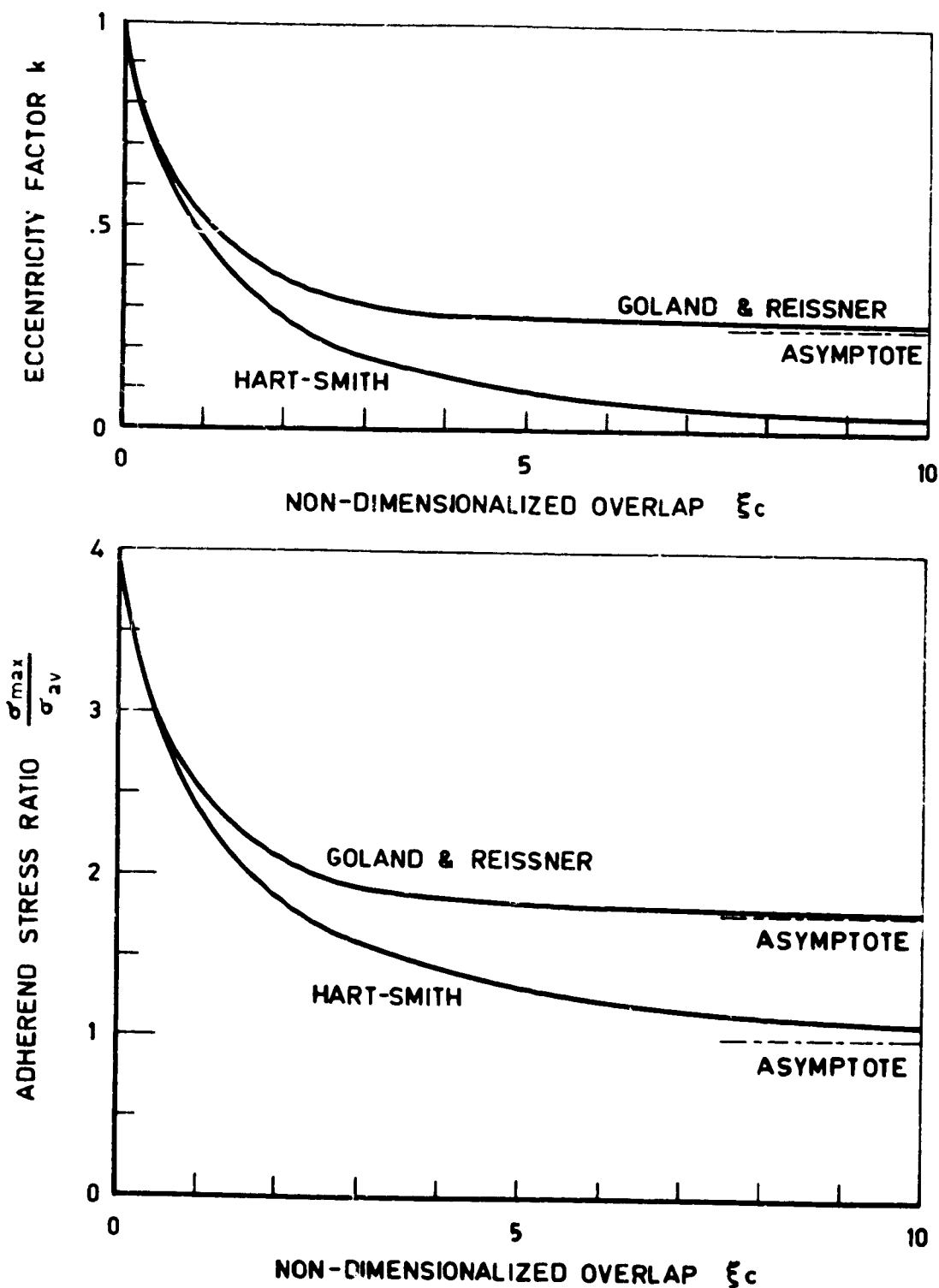
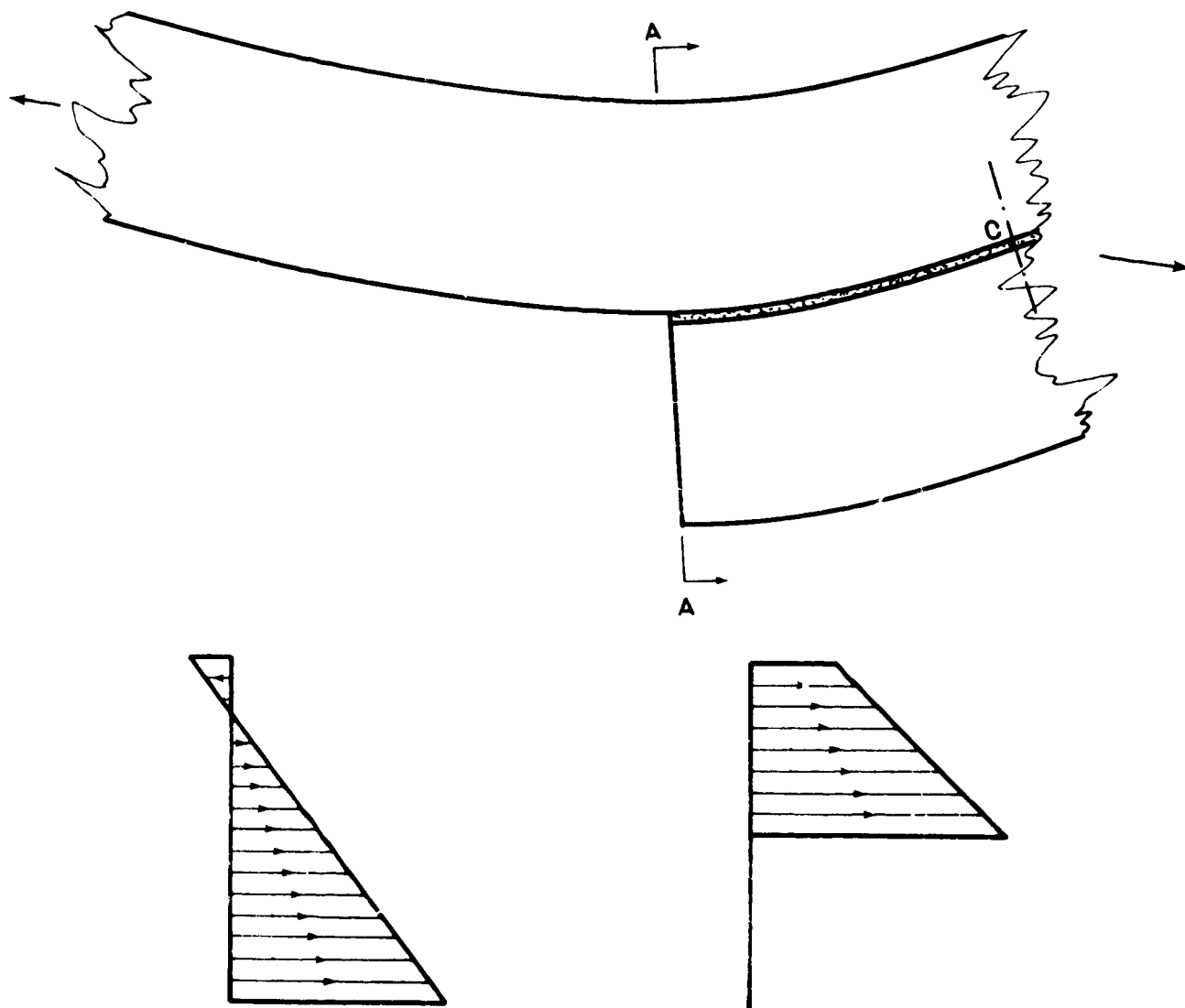

FIGURE 3. COMPARISON BETWEEN PRESENT SOLUTION FOR ADHEREND STRESSES AND THAT OF GOLAND AND REISSNER



STRESS DISTRIBUTION
ON SECTION A-A
ADOPTED BY
GOLAND AND REISSNER

STRESS DISTRIBUTION
ON SECTION A-A
ASSUMED IN
PRESENT ANALYSIS

FIGURE 4. EXPLANATION OF FALLACY IN GOLAND AND REISSNER ANALYSIS

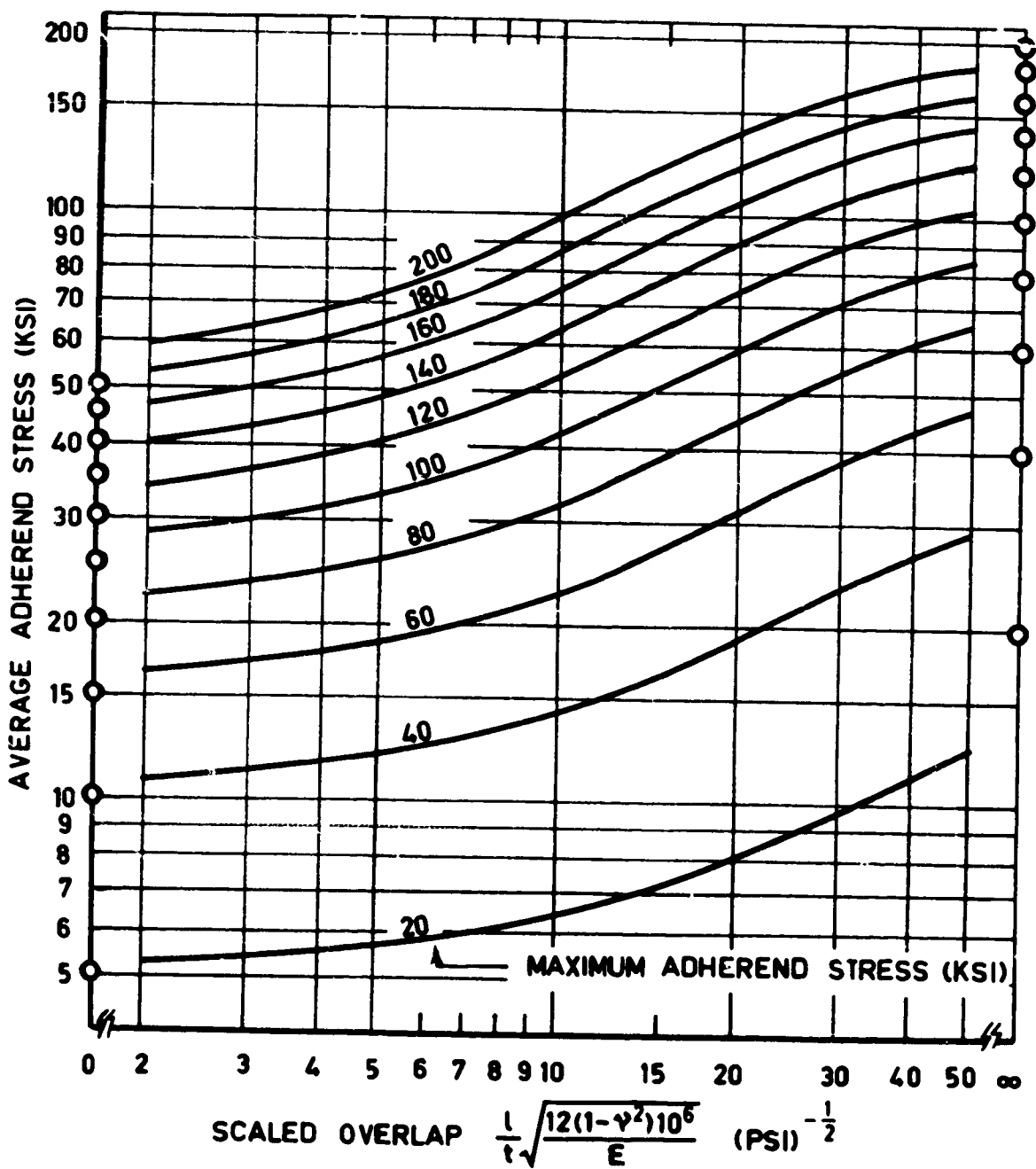

FIGURE 5. ADHEREND LIMIT LOADS FOR BALANCED SINGLE-LAP JOINTS

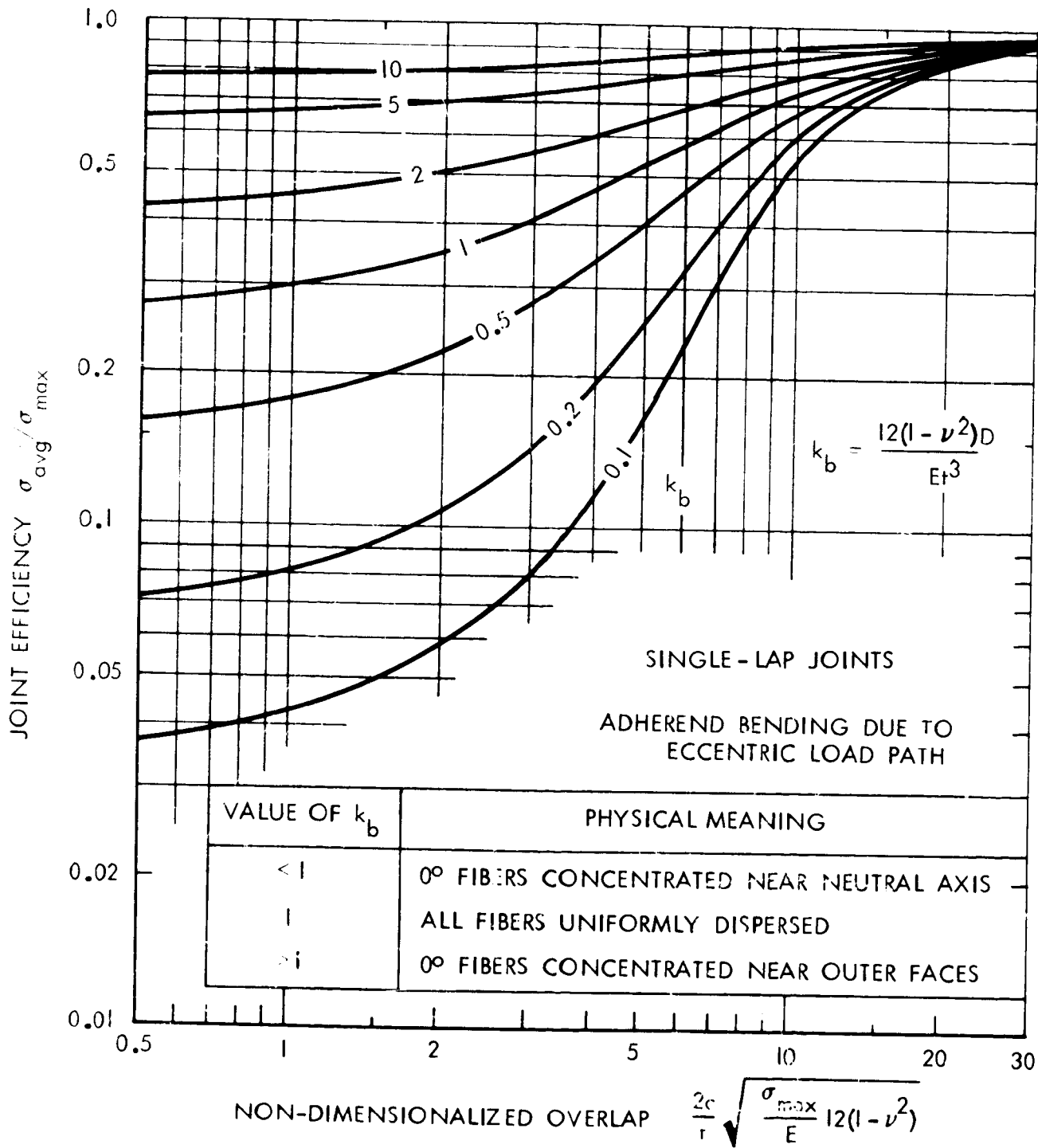

FIGURE 6. INFLUENCE OF PLY STACKING SEQUENCE IN COMPOSITE LAMINATES ON ADHEREND BENDING STRENGTH OF BALANCED SINGLE-LAP JOINTS

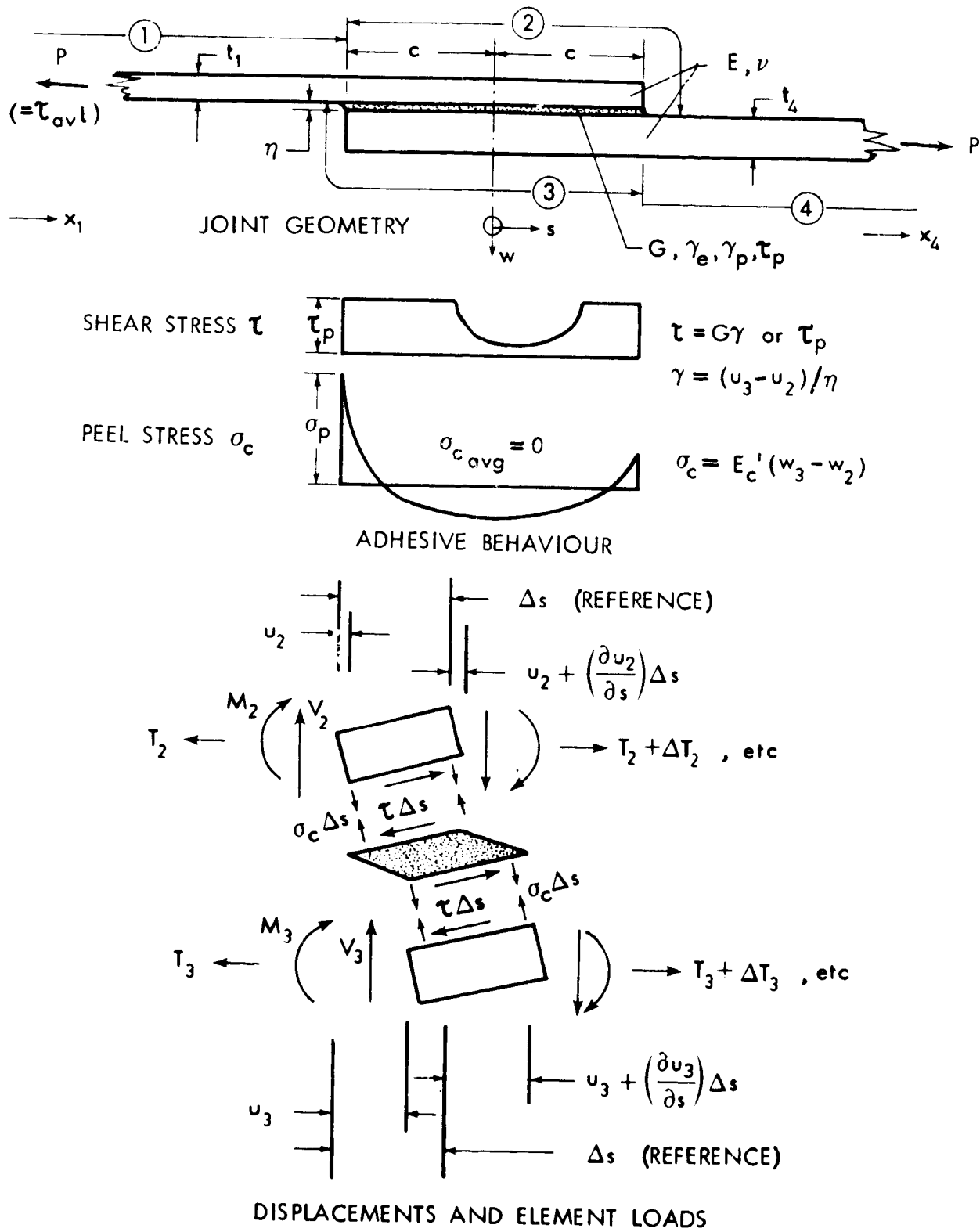

FIGURE 7. GEOMETRY, NOMENCLATURE AND MATHEMATICAL MODEL FOR ANALYSIS OF UNBALANCED SINGLE-LAP JOINTS

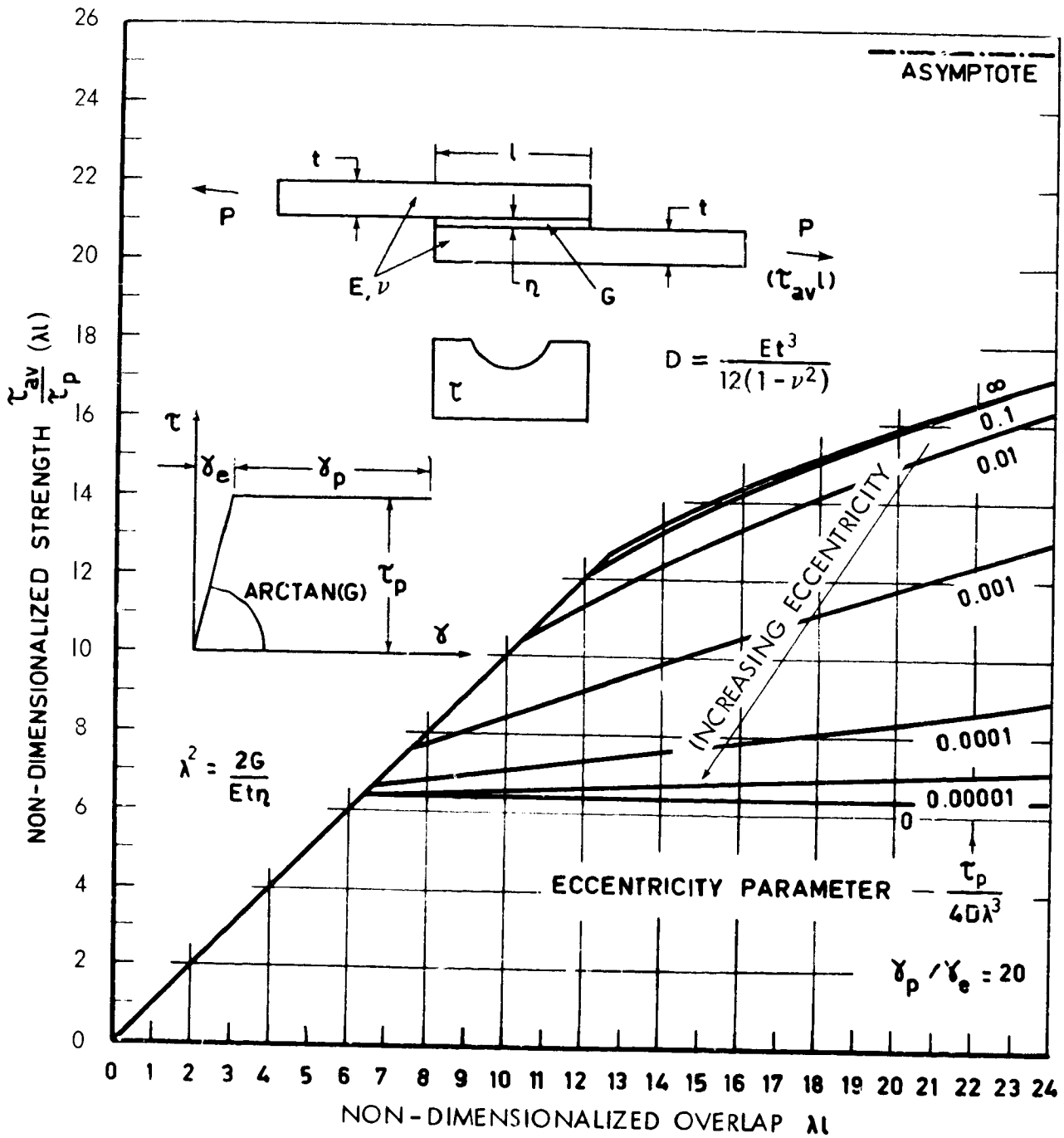

FIGURE 8. INFLUENCE OF ADHEREND PROPERTIES ON SHEAR STRENGTH OF SINGLE-LAP BONDED JOINTS

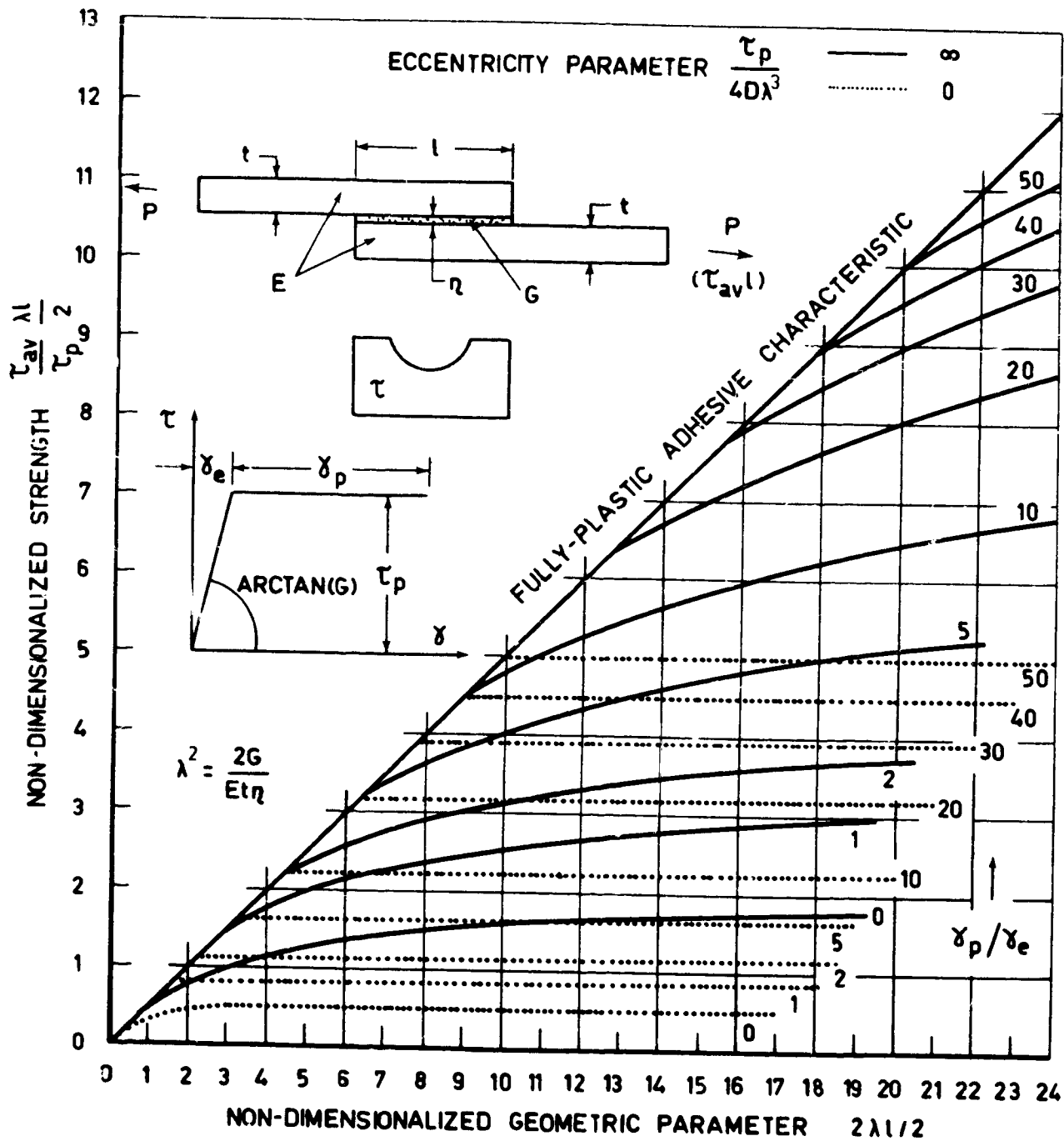

FIGURE 9. INFLUENCE OF ADHESIVE PROPERTIES ON SHEAR STRENGTH OF SINGLE-LAP BONDED JOINTS

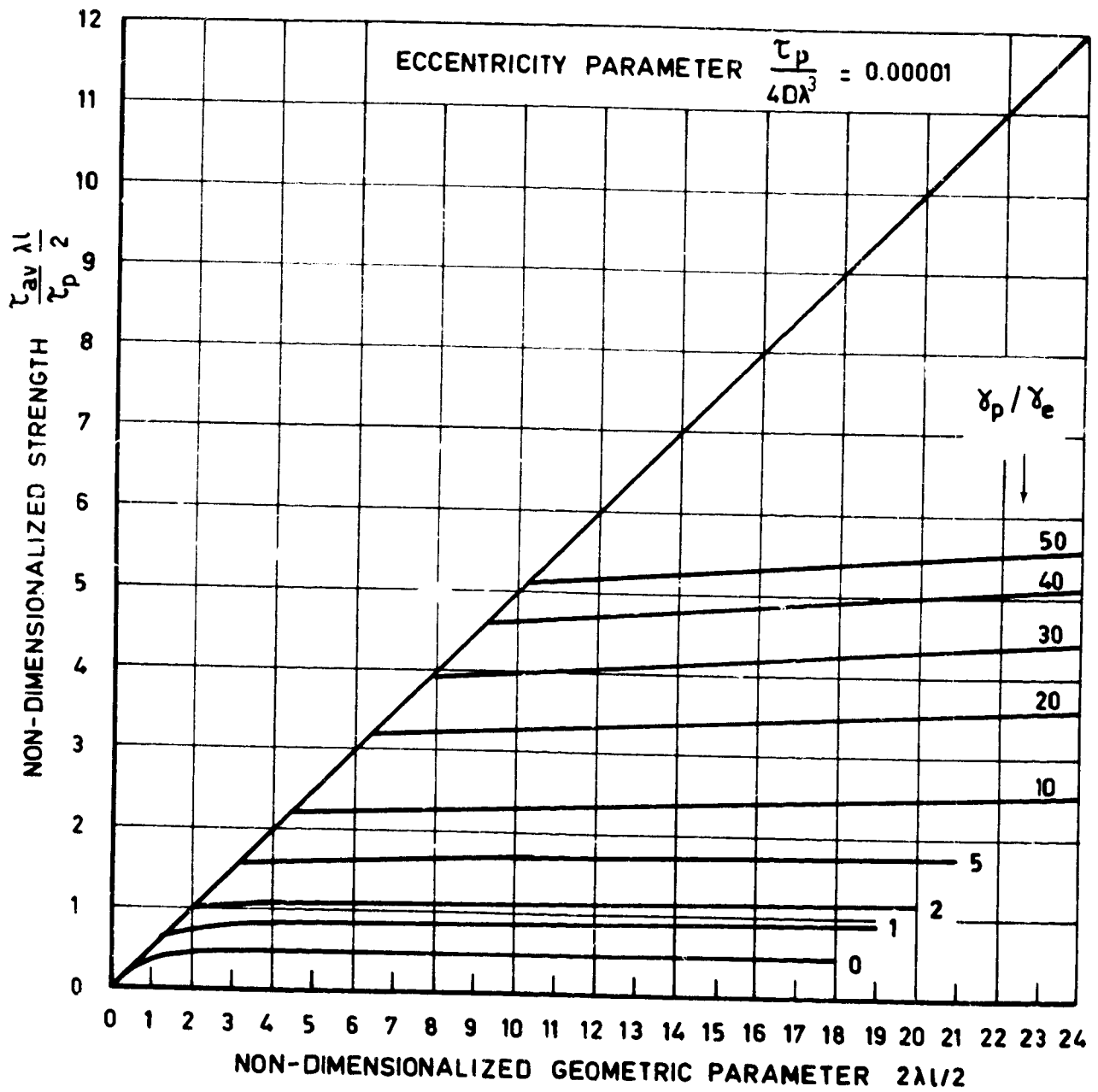

FIGURE 10. NON-DIMENSIONALIZED ADHESIVE BOND SHEAR STRENGTHS FOR SINGLE-LAP BONDED JOINTS

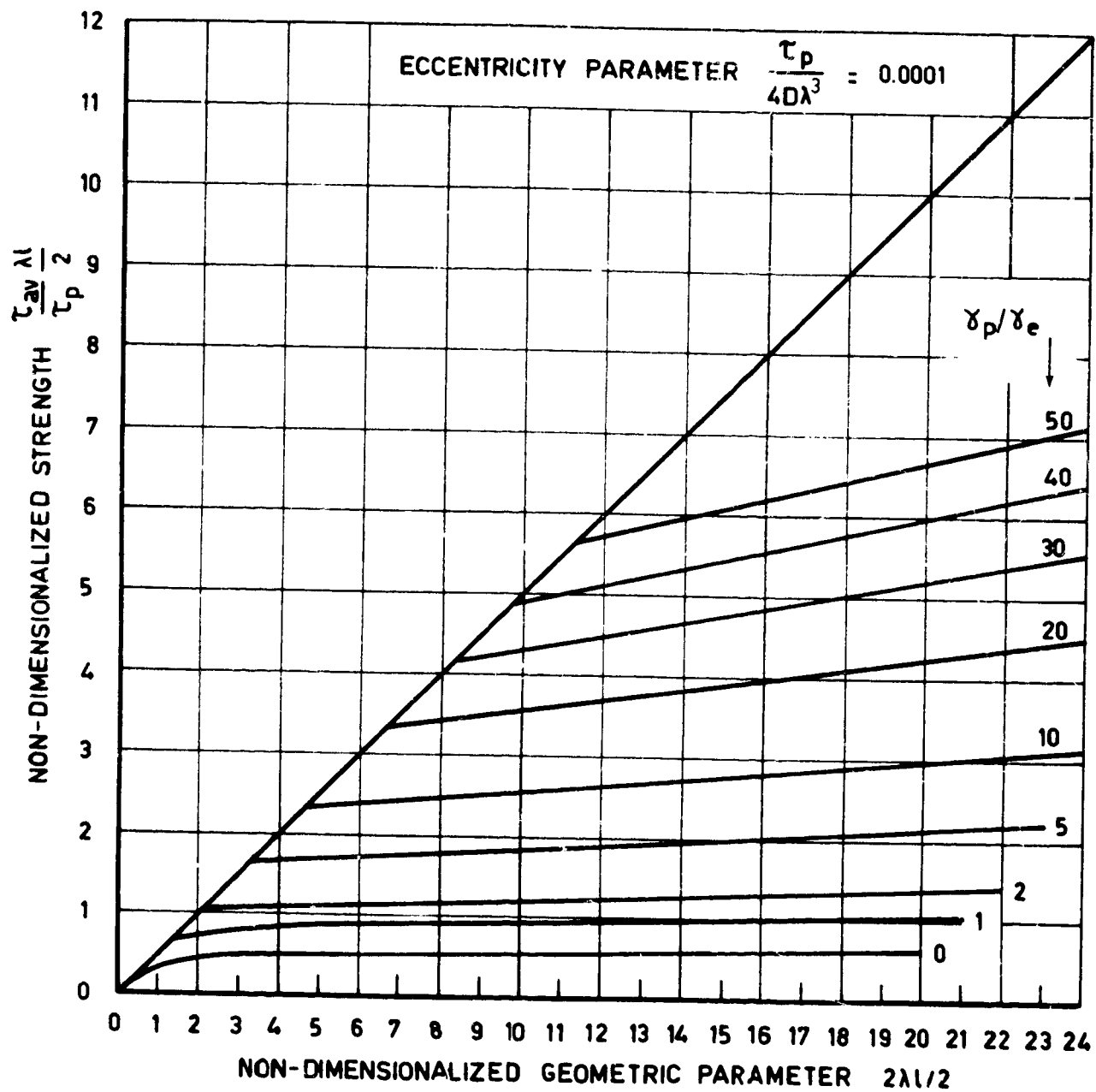

FIGURE II. NON-DIMENSIONALIZED ADHESIVE BOND SHEAR STRENGTHS FOR SINGLE-LAP BONDED JOINTS

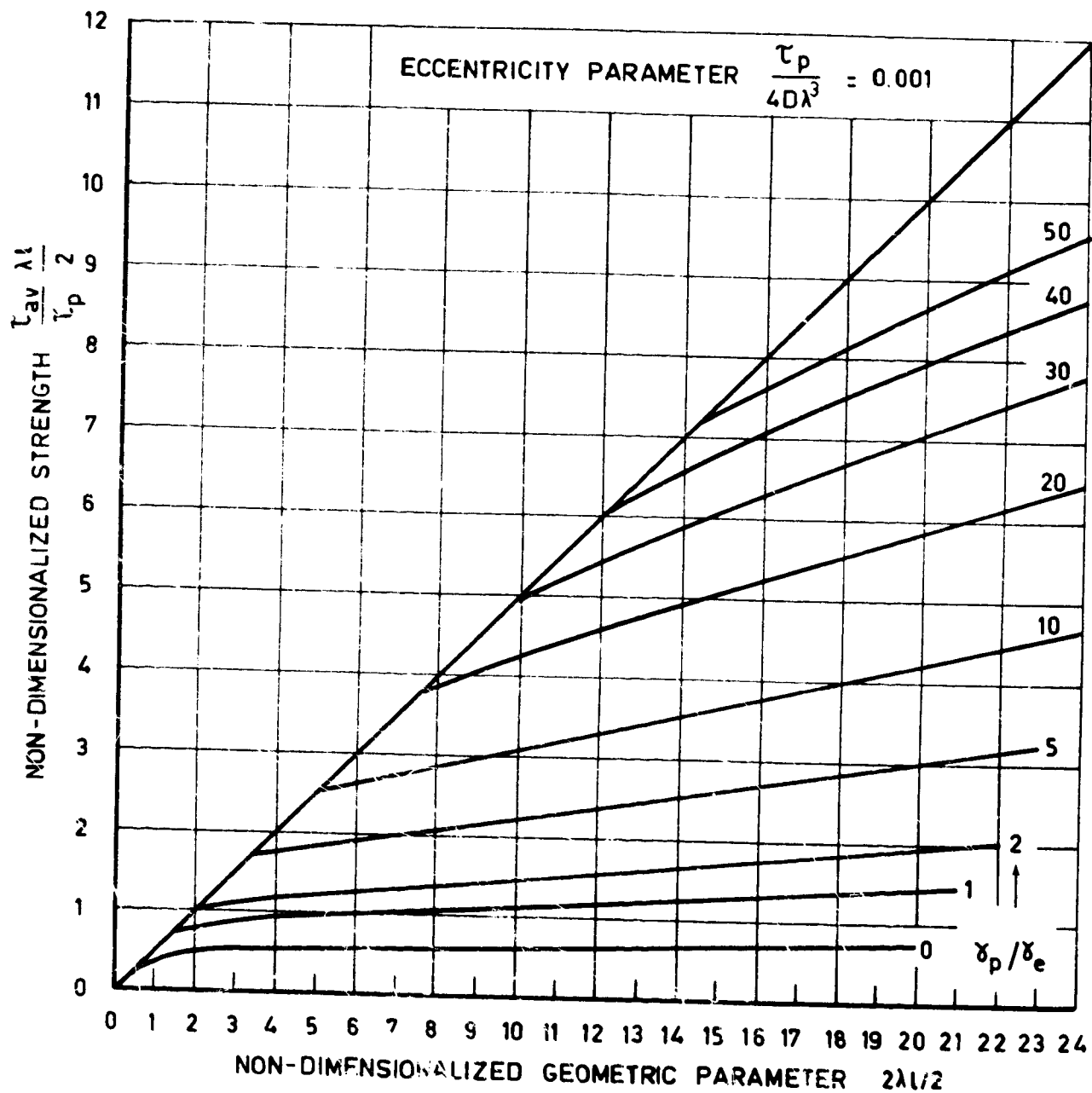

FIGURE 12. NON-DIMENSIONALIZED ADHESIVE BOND SHEAR STRENGTHS FOR SINGLE-LAP BONDED JOINTS

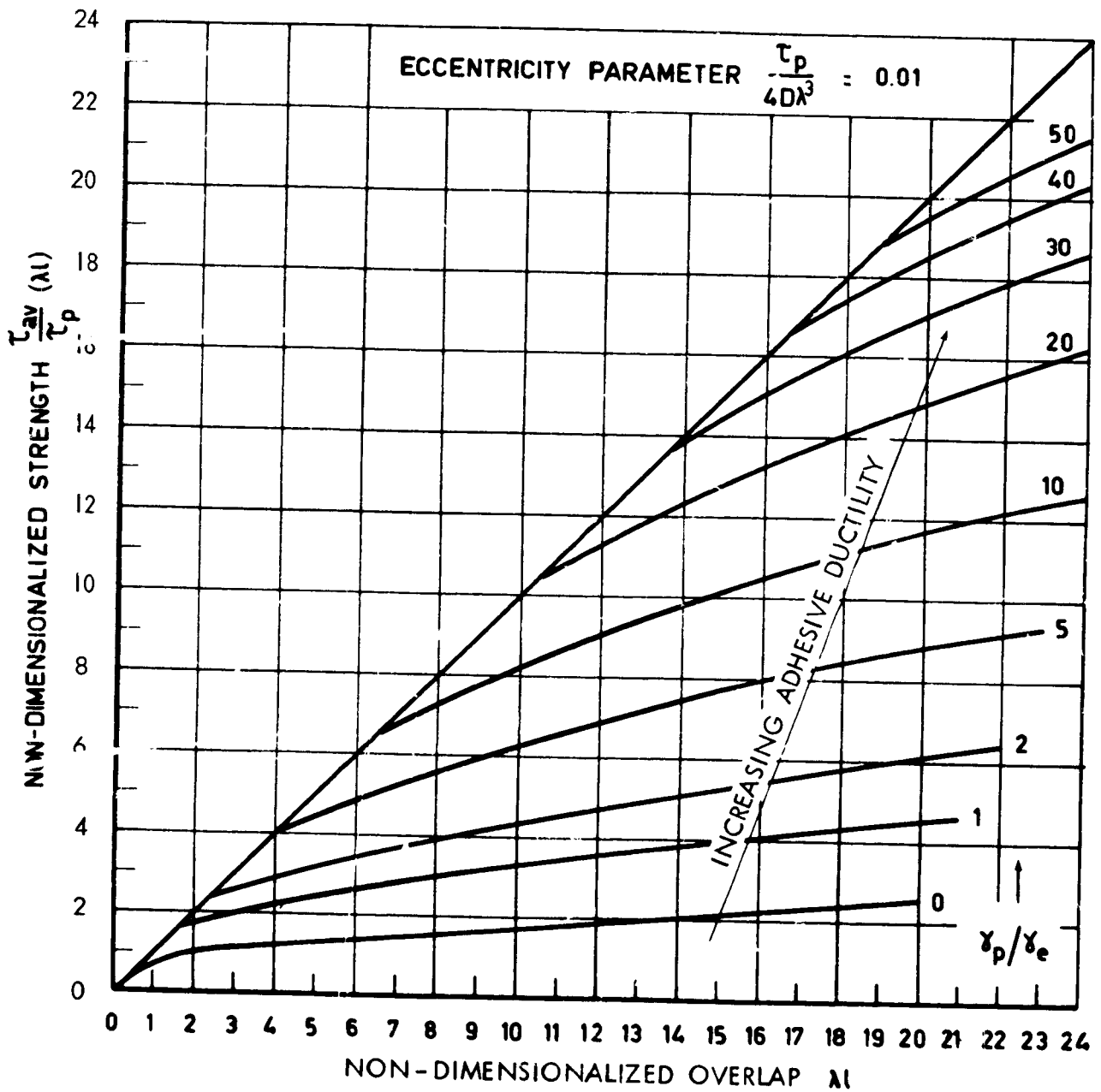

FIGURE 13. NON-DIMENSIONALIZED ADHESIVE BOND SHEAR STRENGTHS FOR SINGLE-LAP BONDED JOINTS

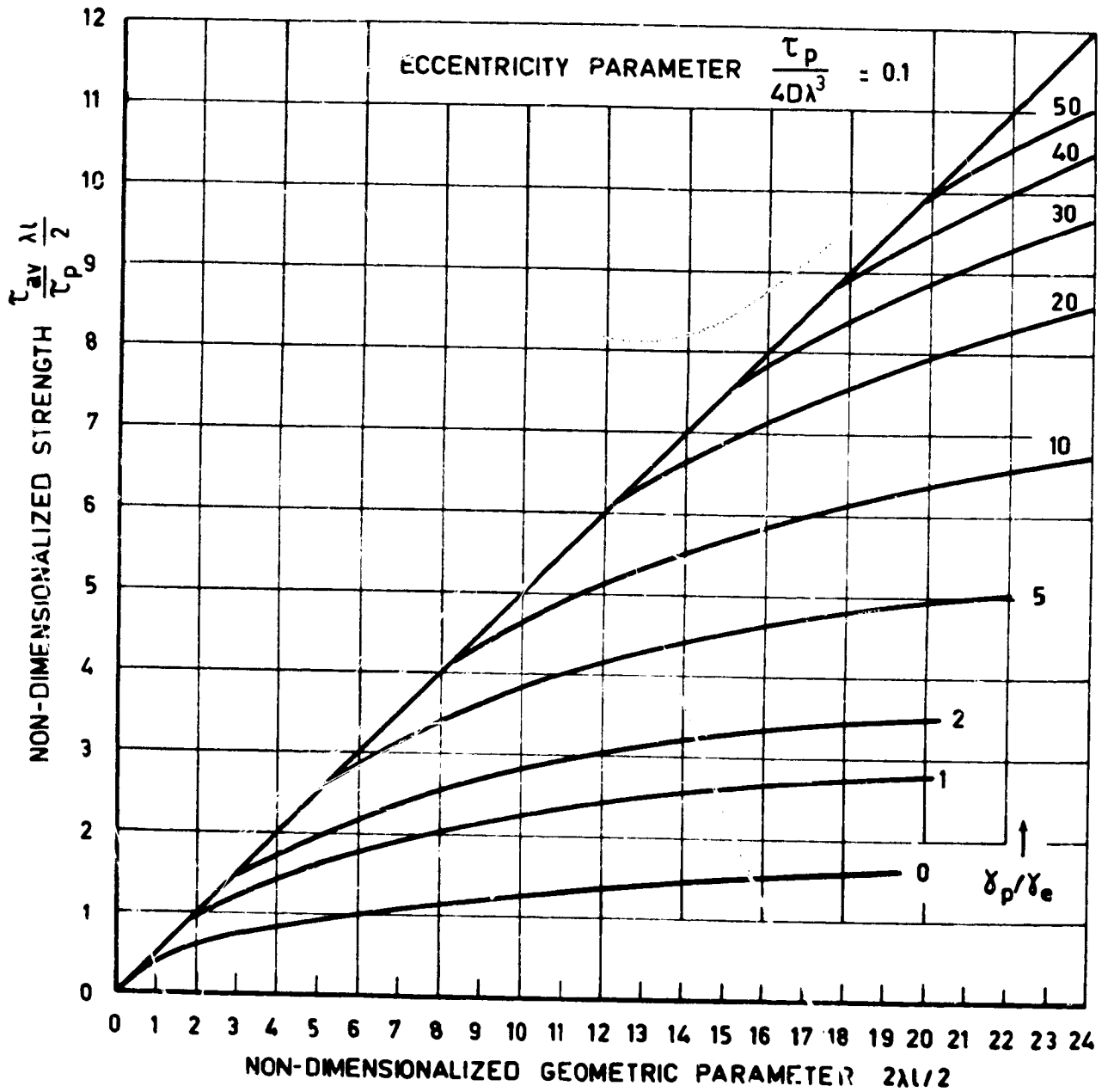

FIGURE 14. NON-DIMENSIONALIZED ADHESIVE BOND SHEAR STRENGTHS FOR SINGLE-LAP BONDED JOINTS

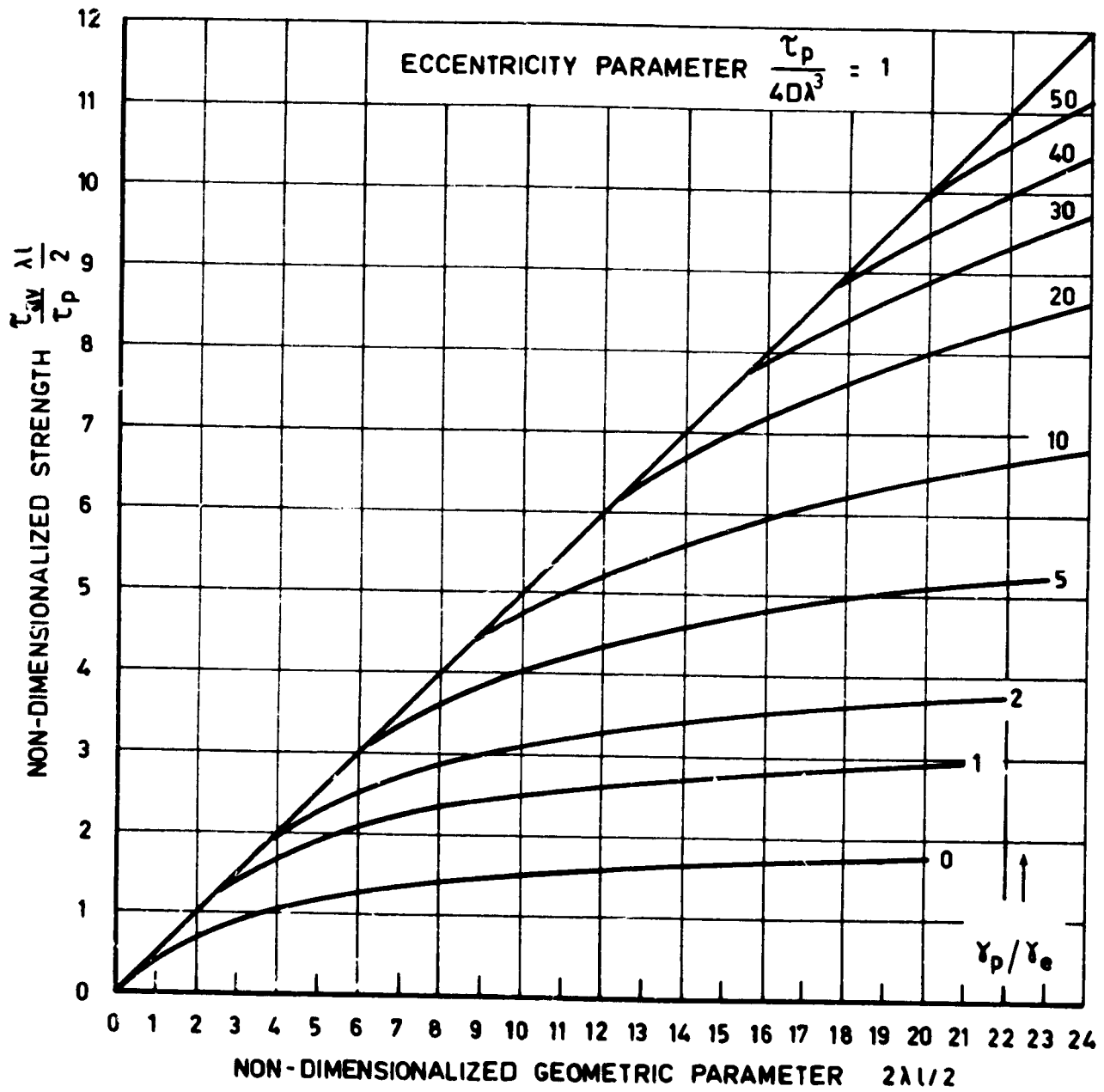

FIGURE 15. NON-DIMENSIONALIZED ADHESIVE BOND SHEAR STRENGTHS FOR SINGLE-LAP BONDED JOINTS

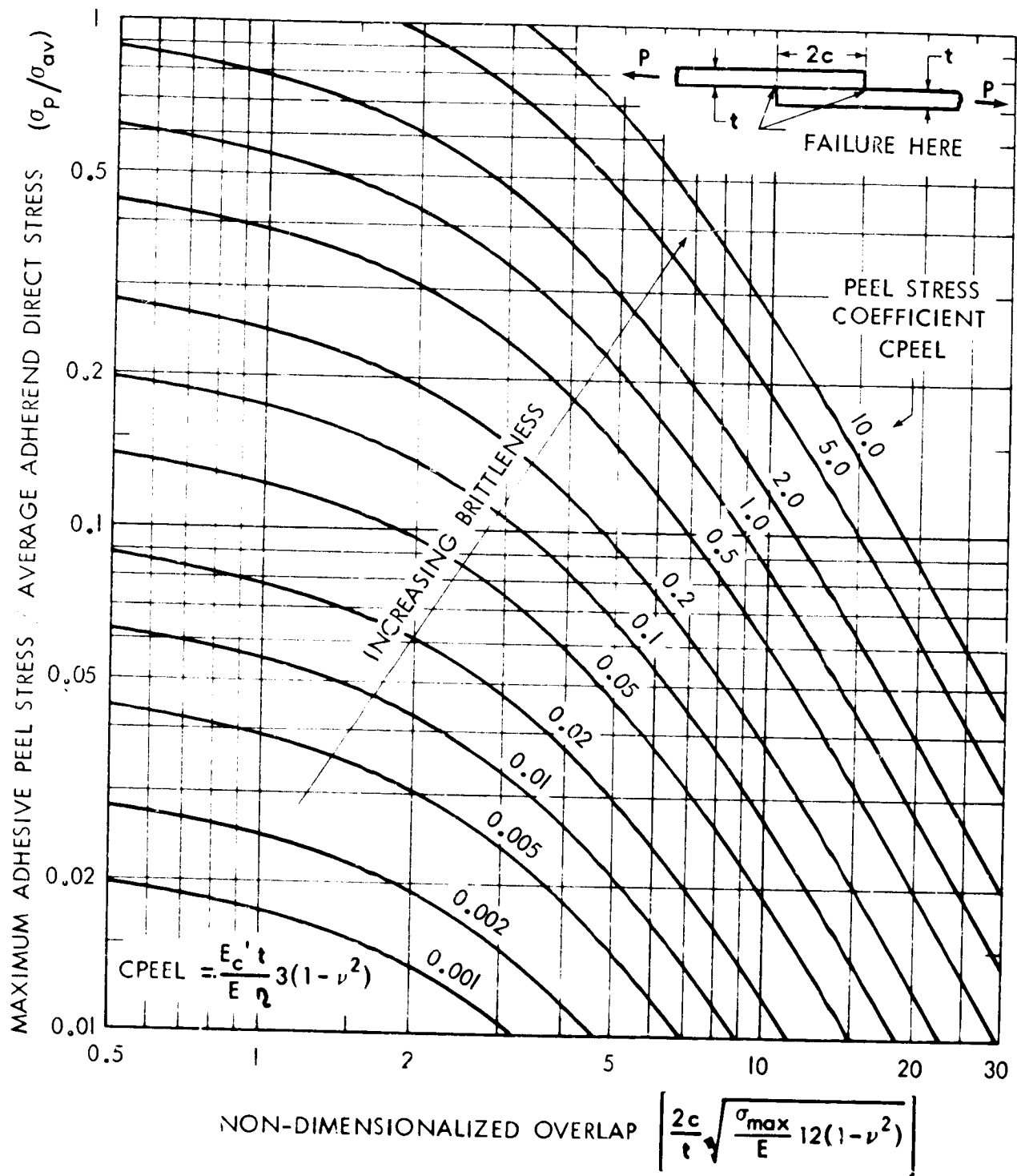

FIGURE 16. PEEL STRESSES IN BALANCED SINGLE-LAP JOINTS

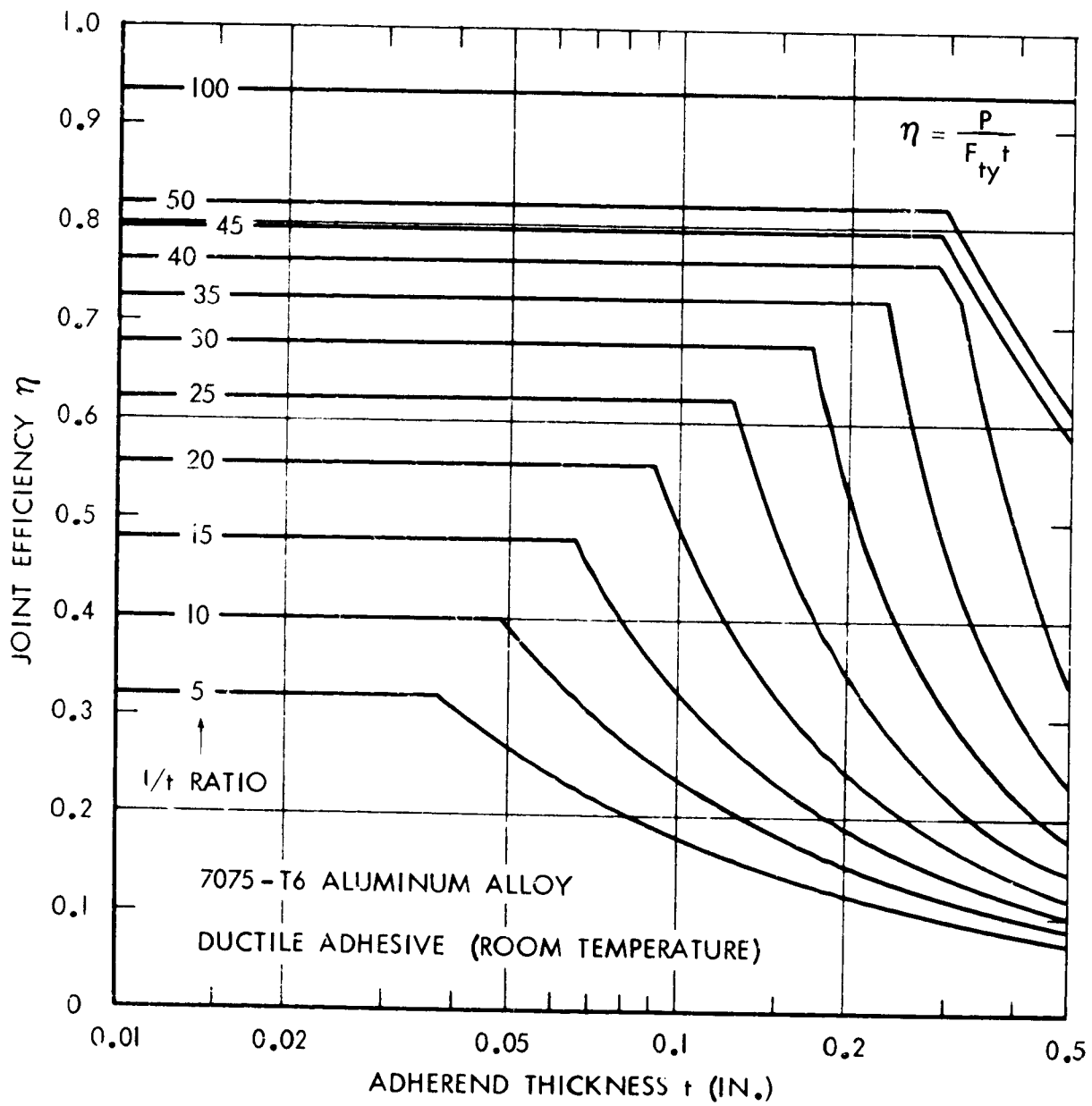

FIGURE 17. JOINT EFFICIENCY CHART FOR SINGLE-LAP METAL JOINTS

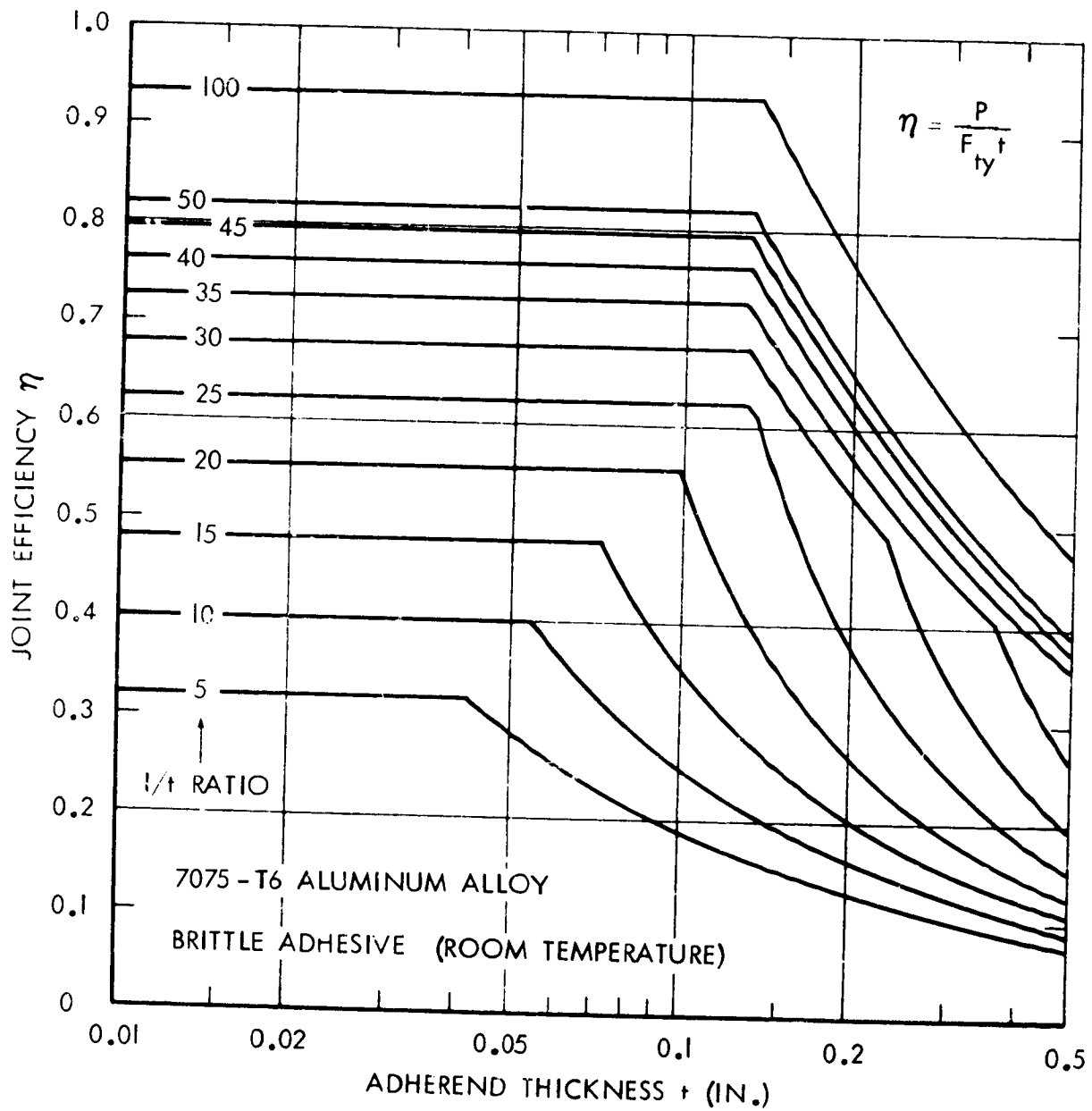

FIGURE 18. JOINT EFFICIENCY CHART FOR SINGLE-LAP METAL JOINTS

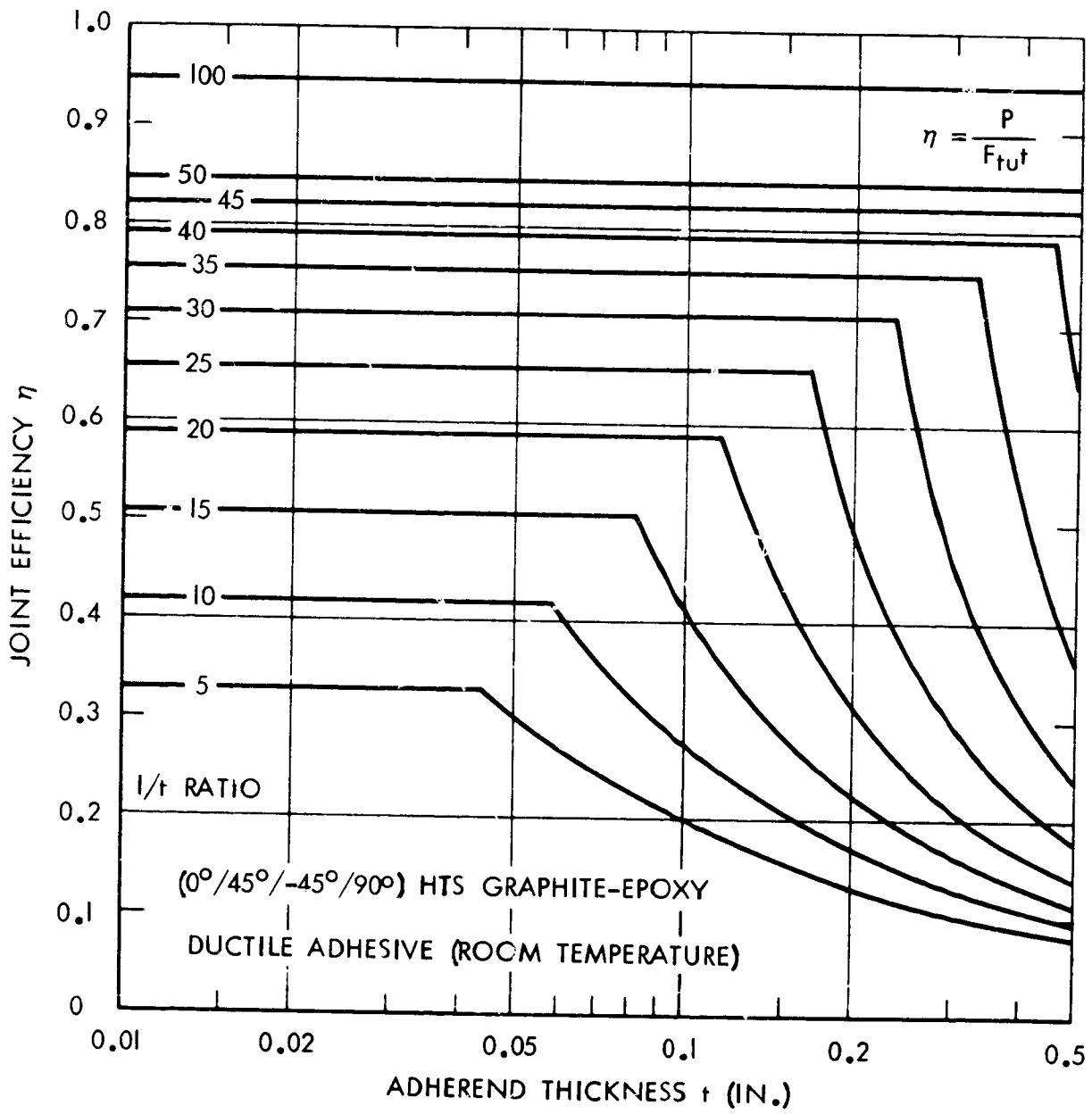

FIGURE 19. JOINT EFFICIENCY CHART FOR SINGLE-LAP COMPOSITE JOINTS

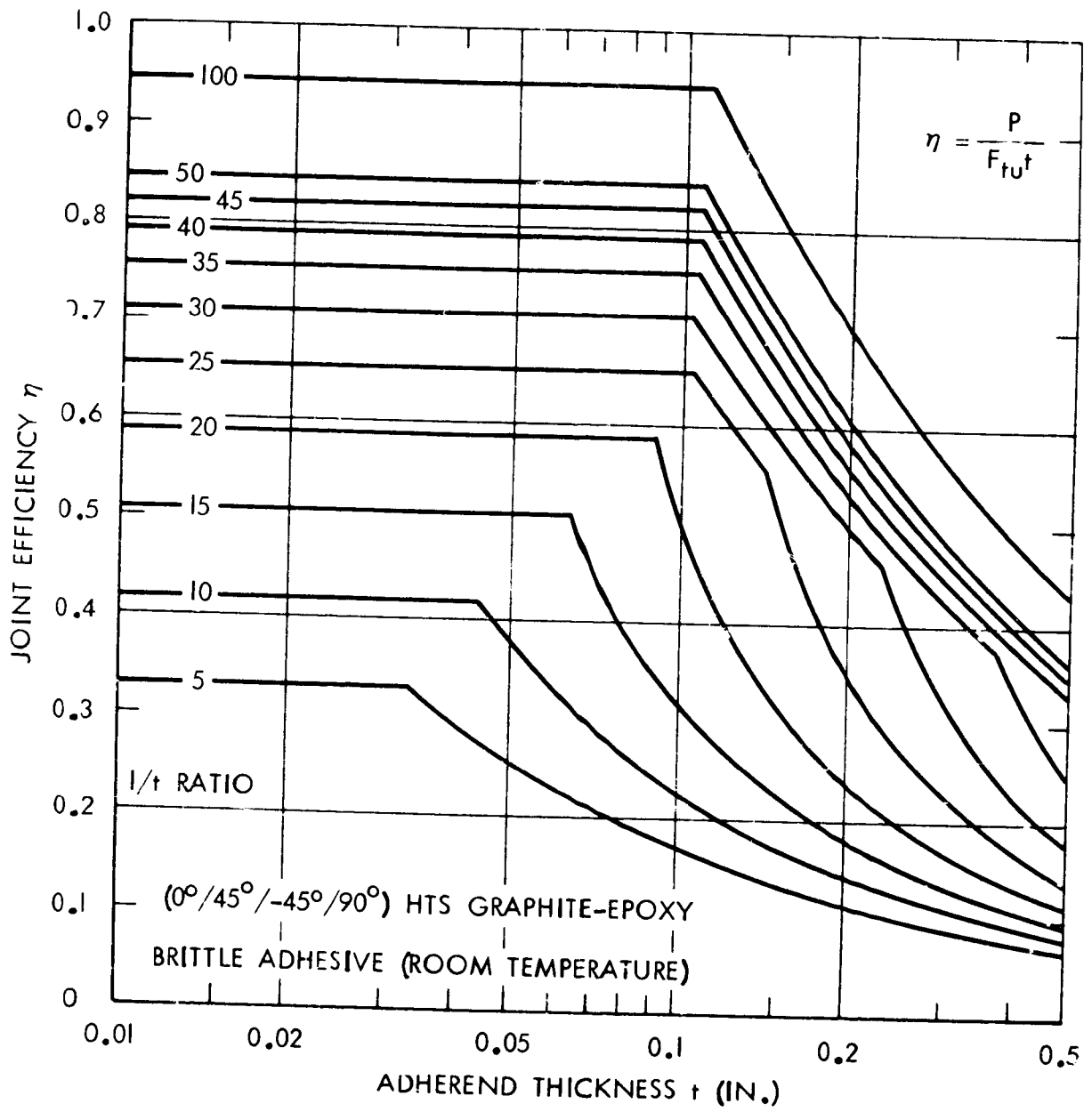

FIGURE 20. JOINT EFFICIENCY CHART FOR SINGLE-LAP COMPOSITE JOINTS

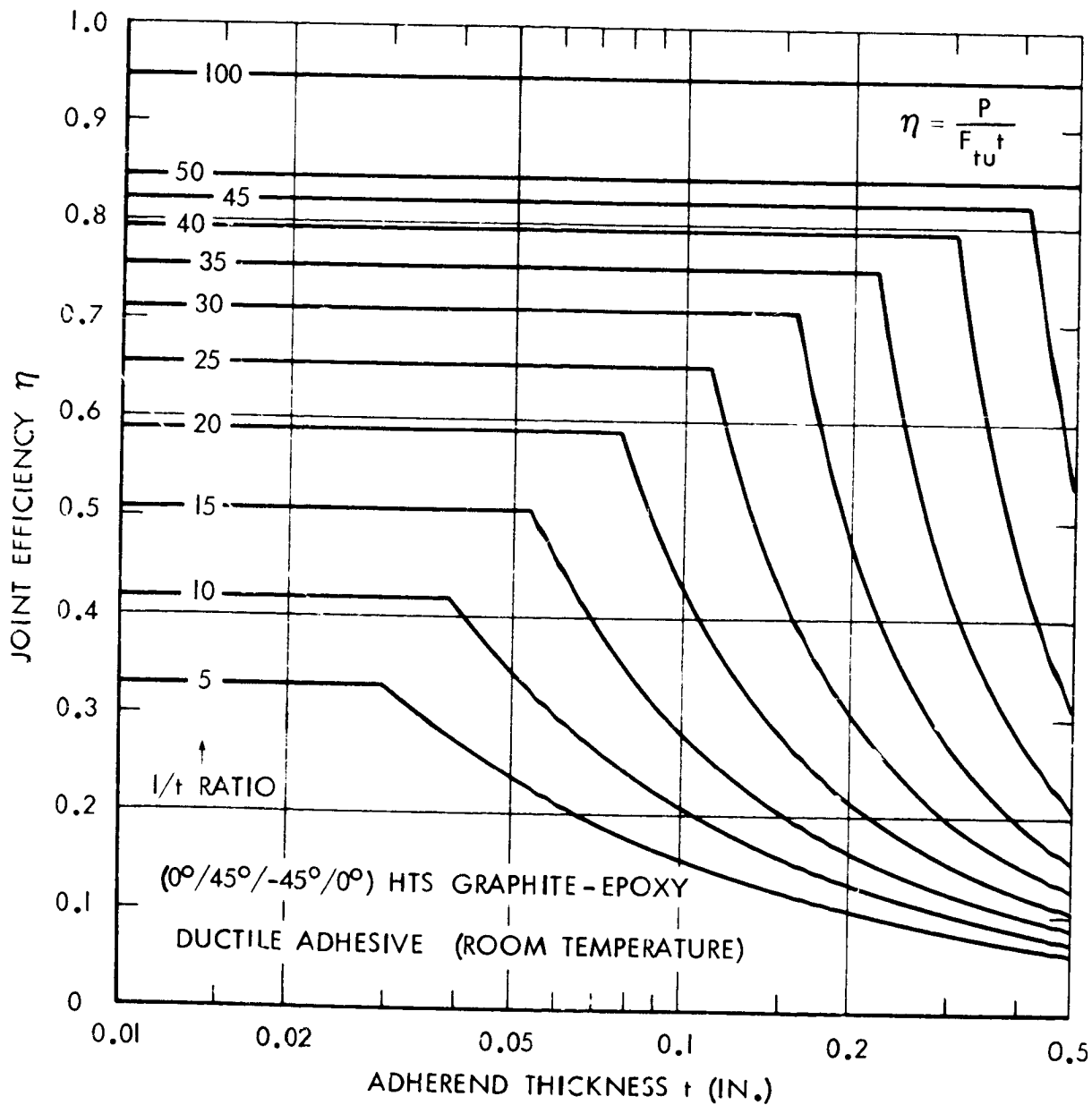

FIGURE 21. JOINT EFFICIENCY CHART FOR SINGLE-LAP COMPOSITE JOINTS

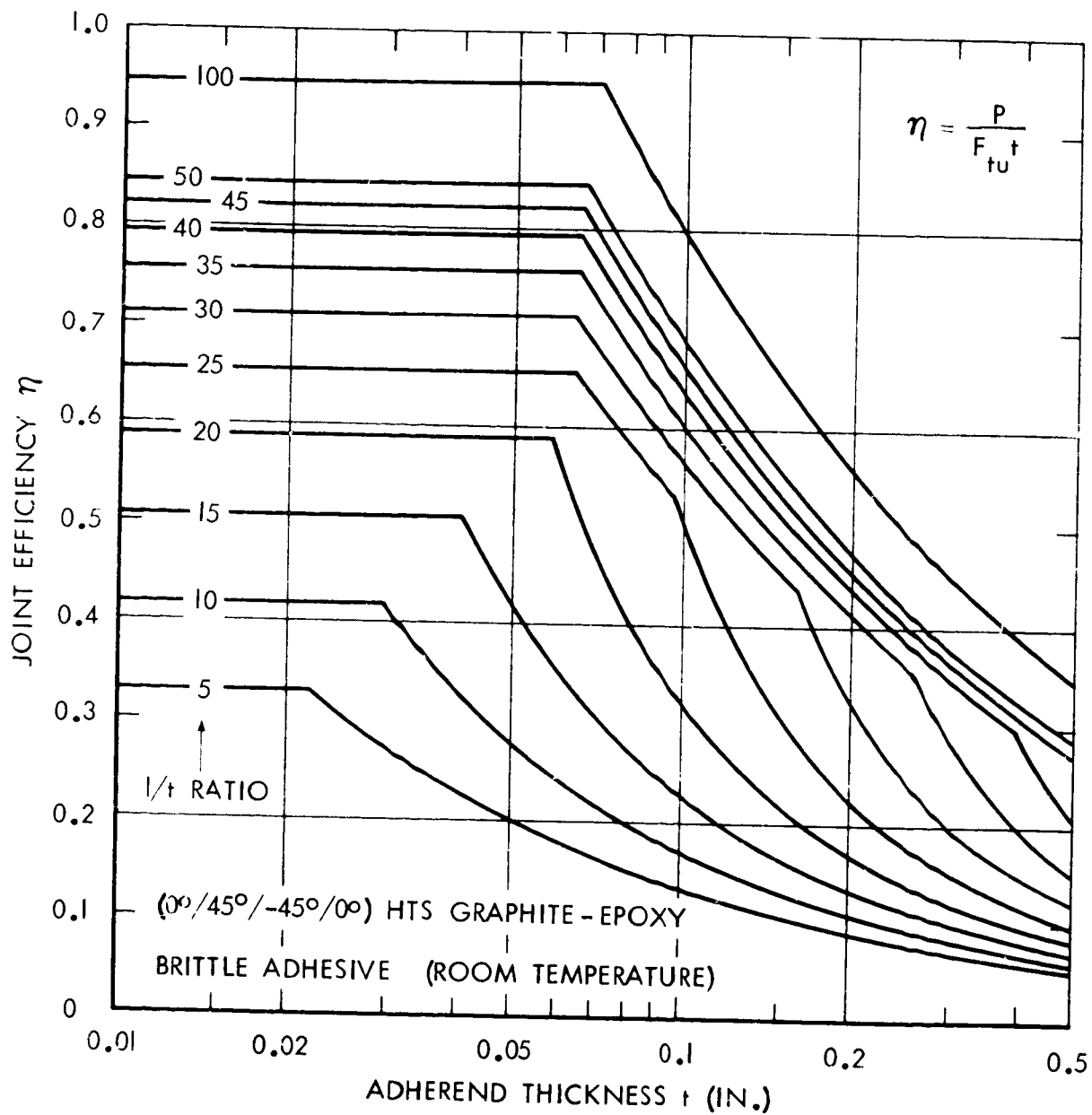

FIGURE 22. JOINT EFFICIENCY CHART FOR SINGLE-LAP COMPOSITE JOINTS

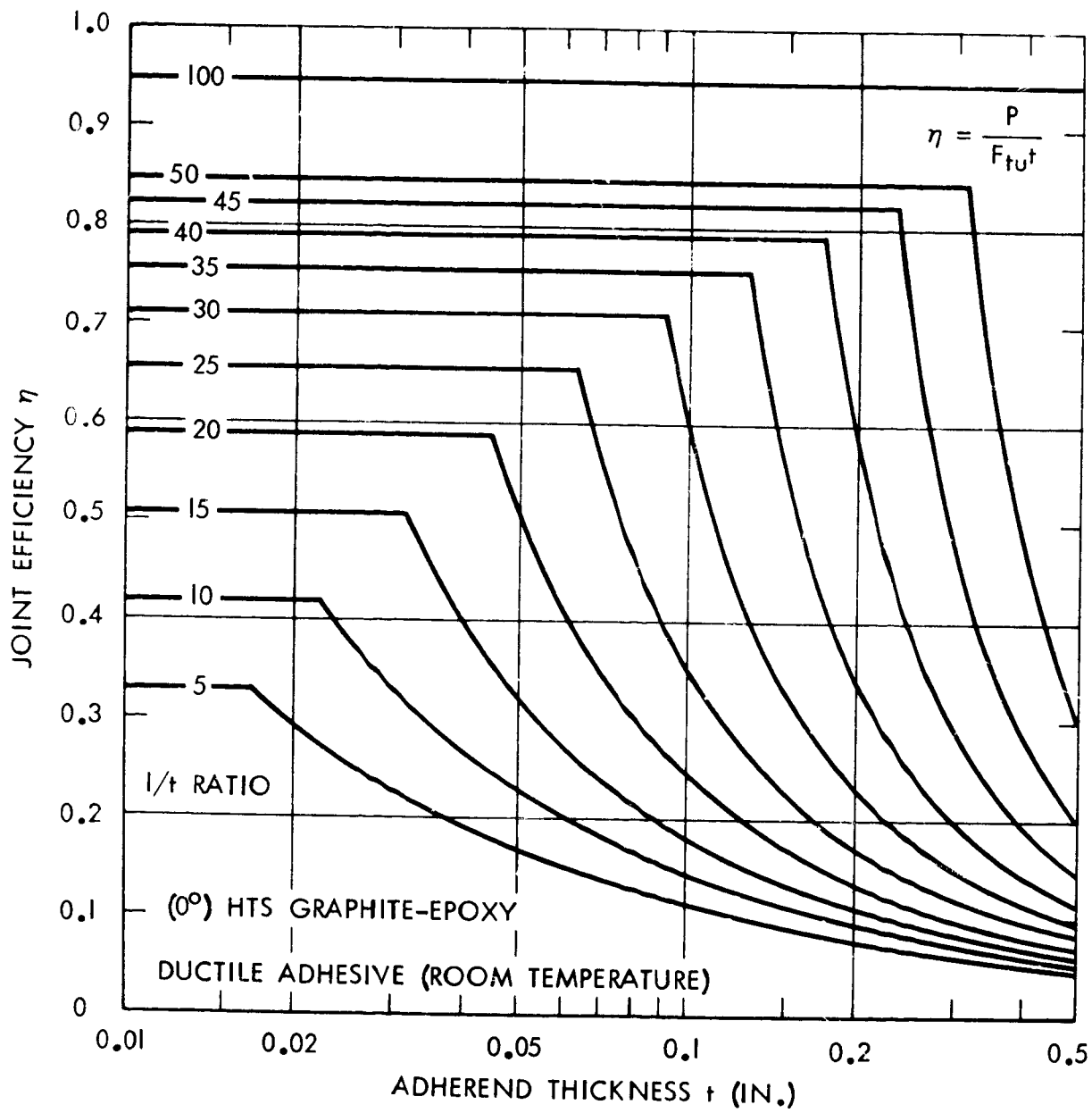

FIGURE 23. JOINT EFFICIENCY CHART FOR SINGLE-LAP COMPOSITE JOINTS

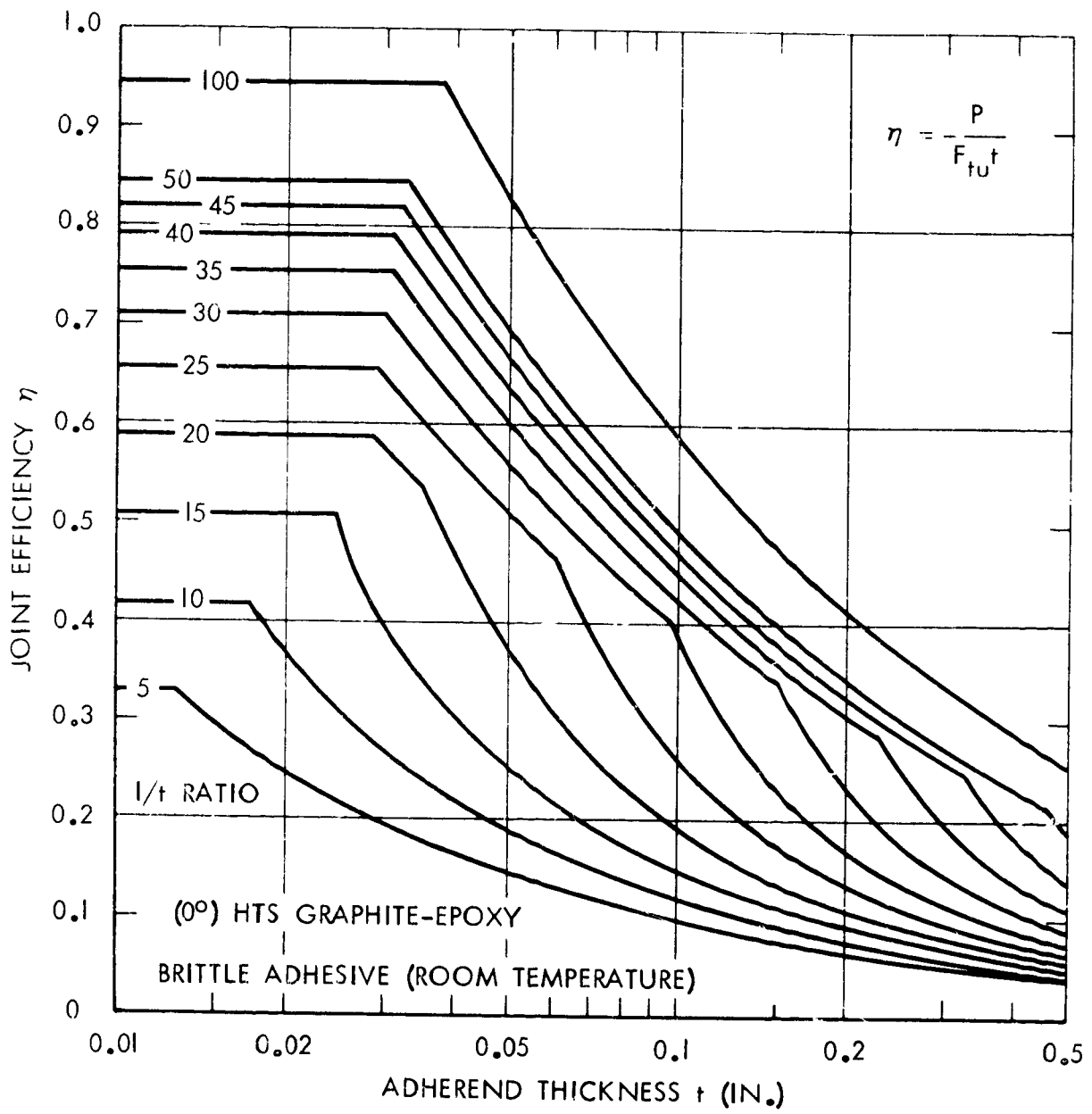

FIGURE 24. JOINT EFFICIENCY CHART FOR SINGLE-LAP COMPOSITE JOINTS

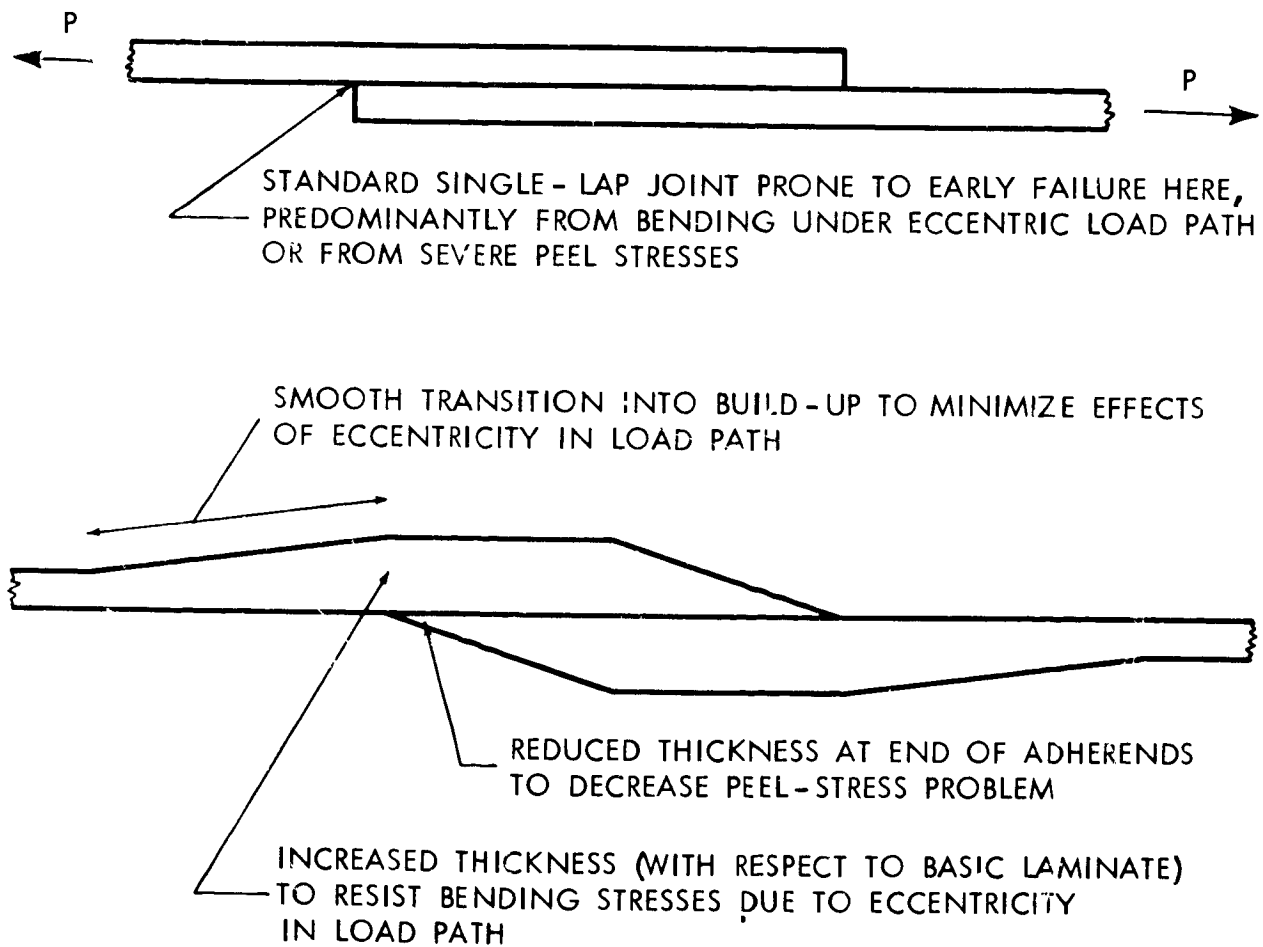

FIGURE 25. REDUCTION IN INEFFICIENCY OF UNSUPPORTED SINGLE-LAP JOINTS

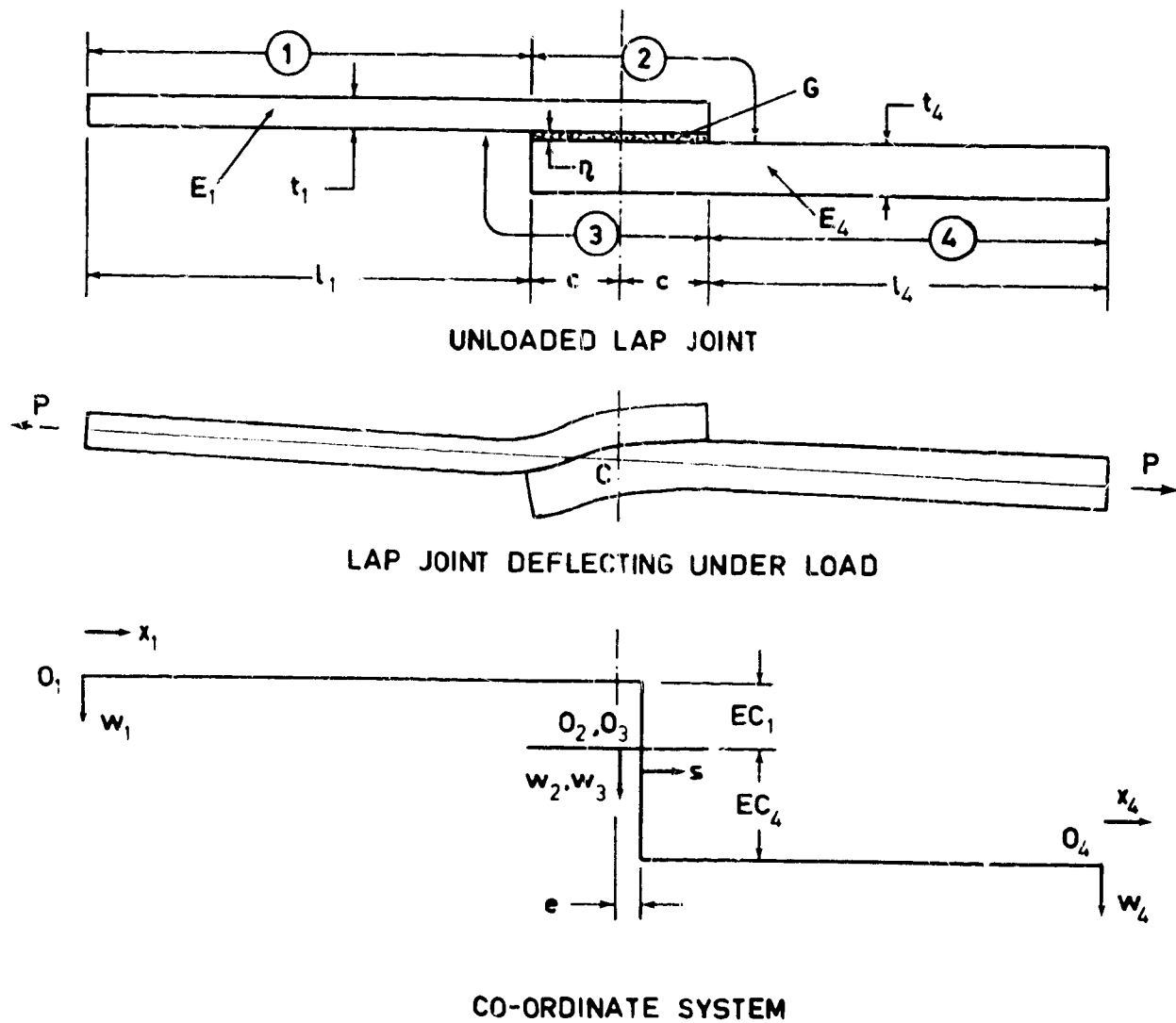

FIGURE 26. CO-ORDINATE SYSTEM FOR UNBALANCED SINGLE-LAP JOINTS

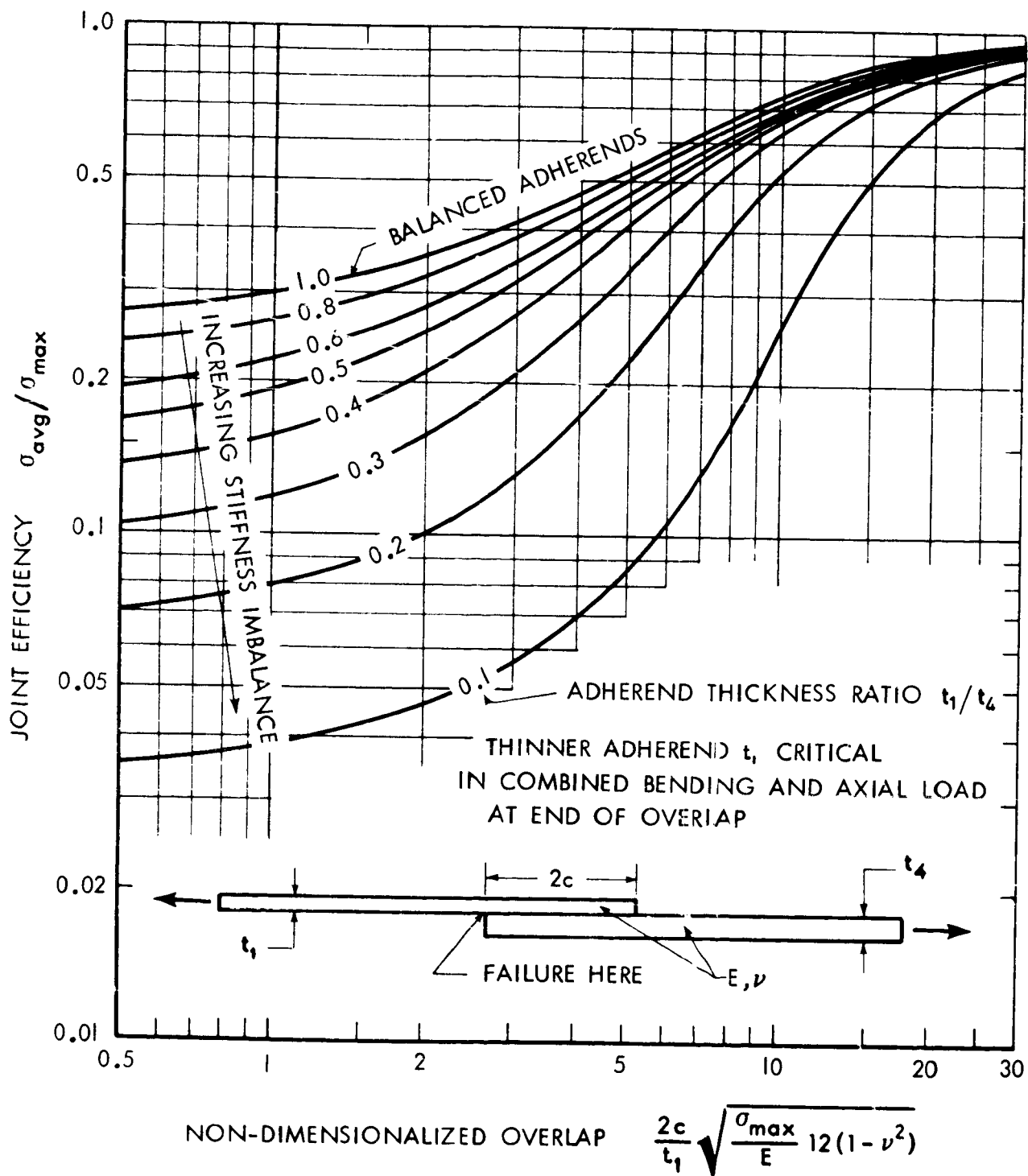

FIGURE 27. EFFECT OF ADHEREND STIFFNESS IMBALANCE ON ADHEREND BENDING STRENGTH OF SINGLE-LAP BONDED JOINTS

CS

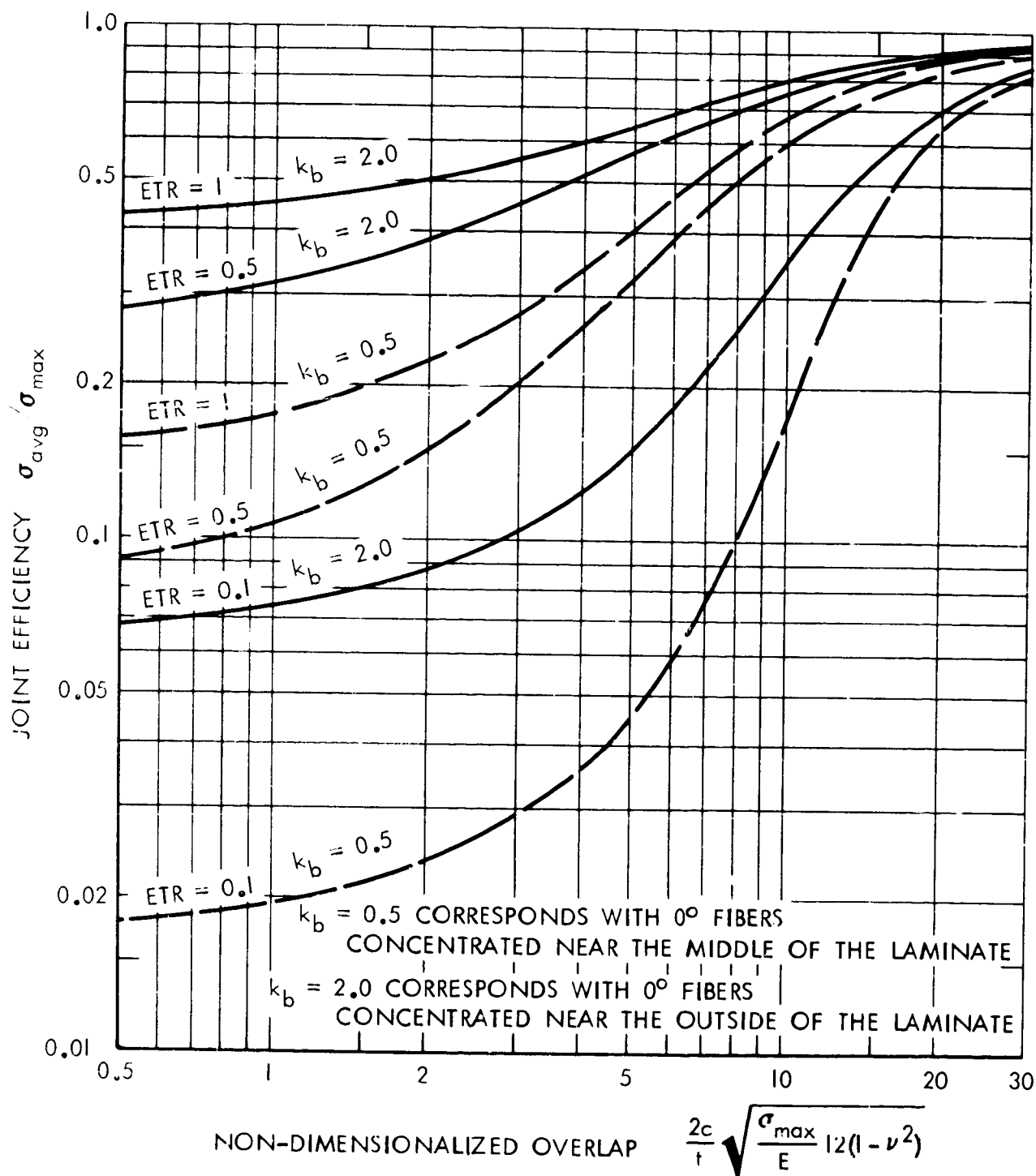

FIGURE 28. EFFECT OF FIBER STACKING SEQUENCE ON ADHEREND BENDING STRENGTH OF UNBALANCED COMPOSITE SINGLE-LAP JOINTS

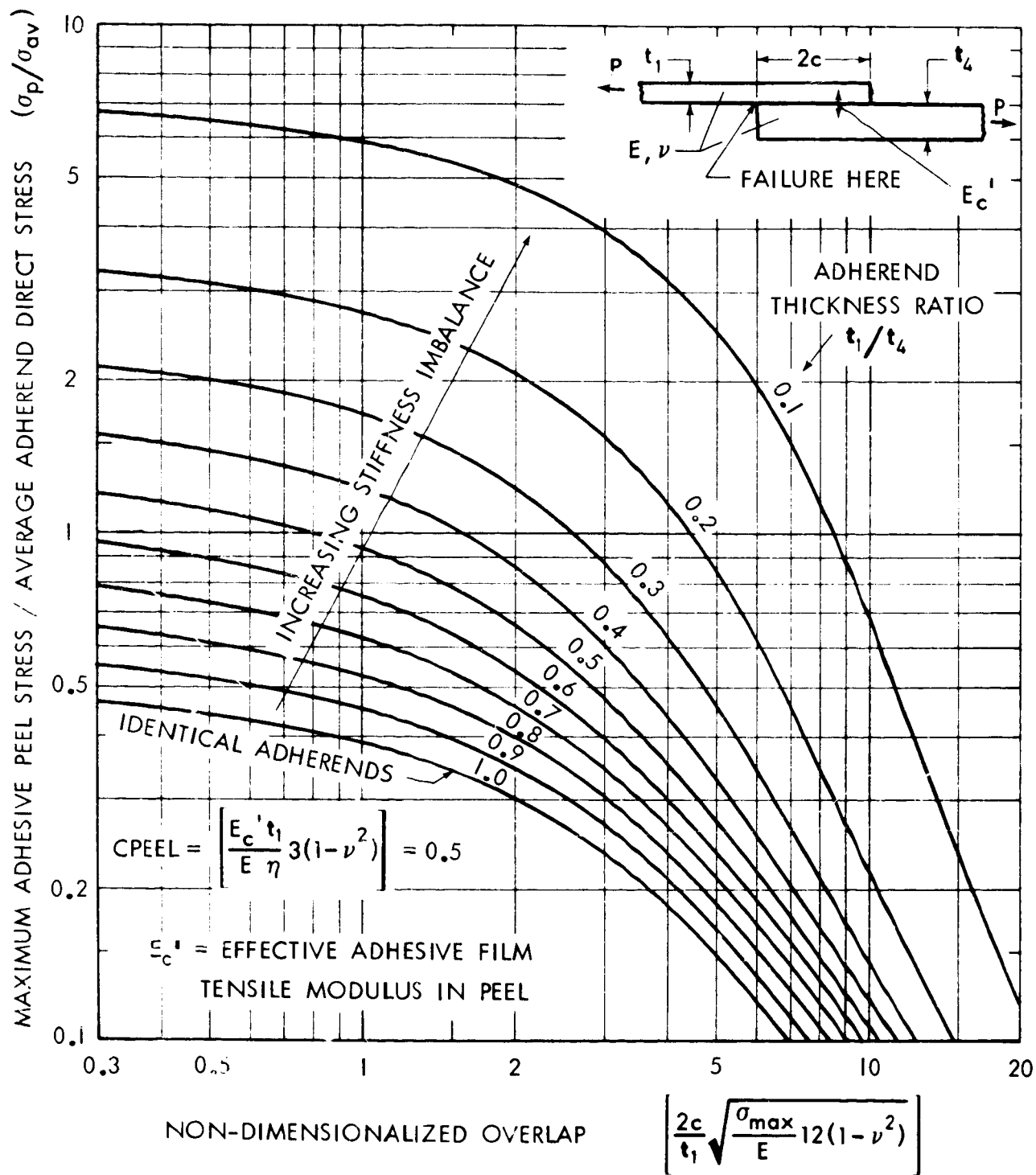
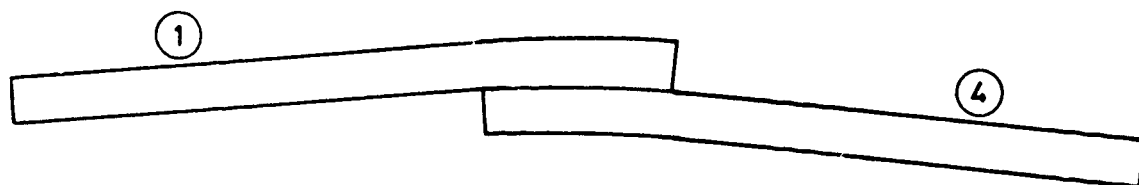
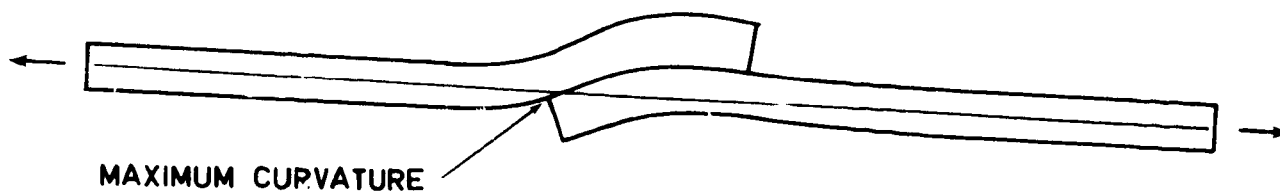

FIGURE 29. EFFECT OF ADHEREND STIFFNESS IMBALANCE ON PEEL STRESSES IN SINGLE-LAP BONDED JOINTS

$$\alpha_1 < \alpha_2$$



UNLOADED LAP JOINT
WITH ADHERENDS OF DISSIMILAR COEFFICIENTS OF THERMAL EXPANSION



LAP JOINT DEFLECTING UNDER LOAD

FIGURE 30. EFFECT OF ADHEREND THERMAL MISMATCH ON SINGLE-LAP BONDED JOINTS

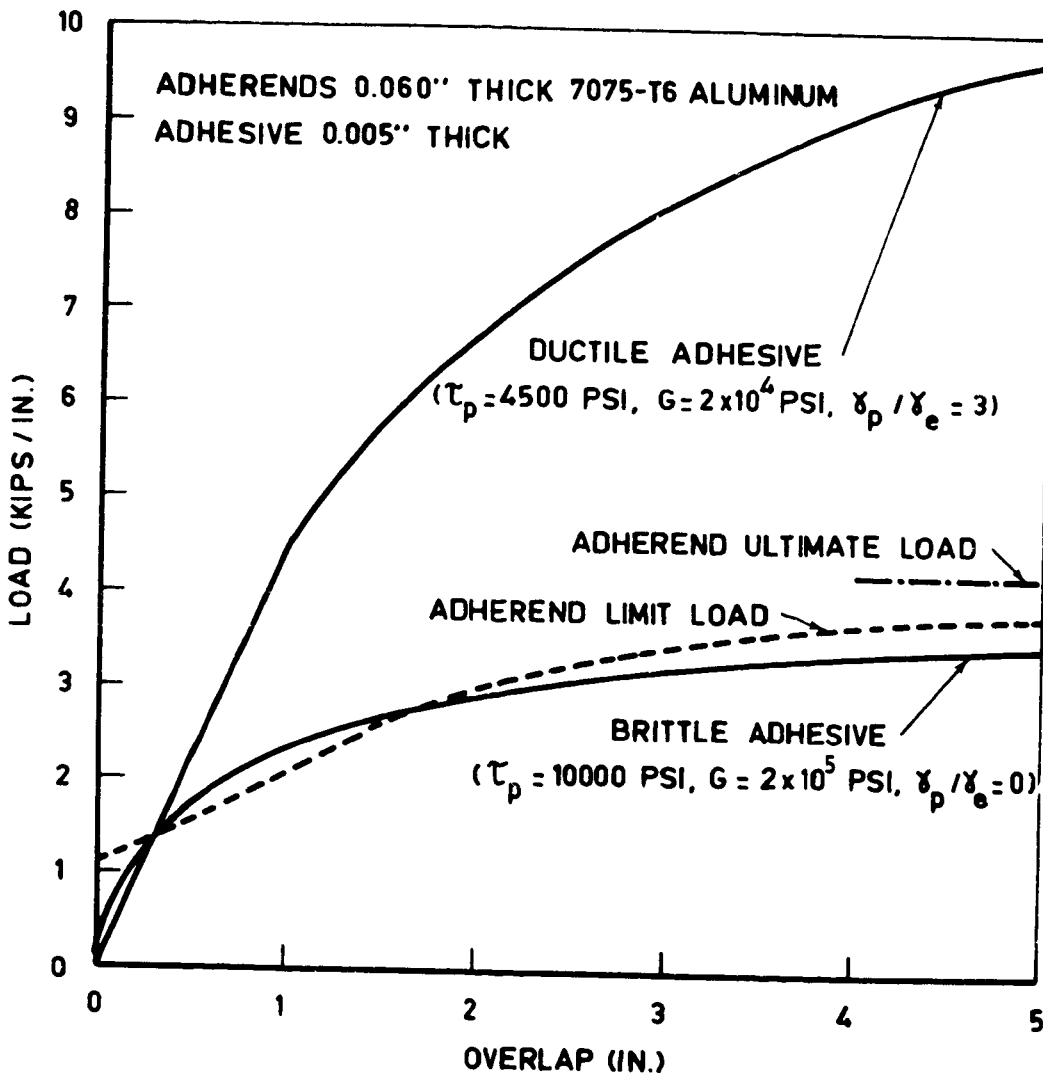

FIGURE 31. COMPARISON OF ADHESIVE AND ADHEREND STRENGTHS FOR SINGLE-LAP BONDED JOINTS

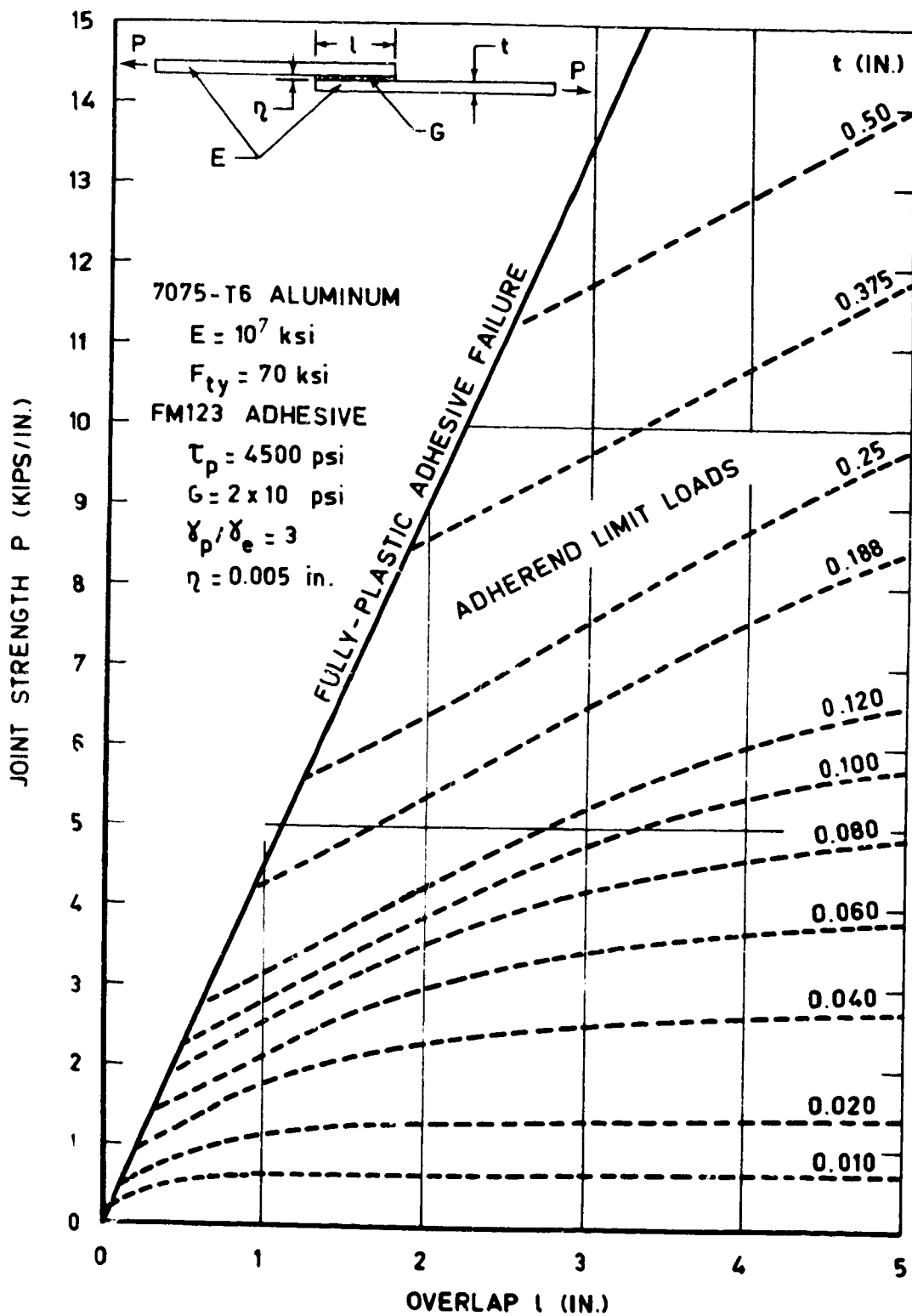

FIGURE 32. FORMATION OF PLASTIC HINGES DUE TO ECCENTRIC LOAD PATH FOR SINGLE-LAP BONDED JOINTS

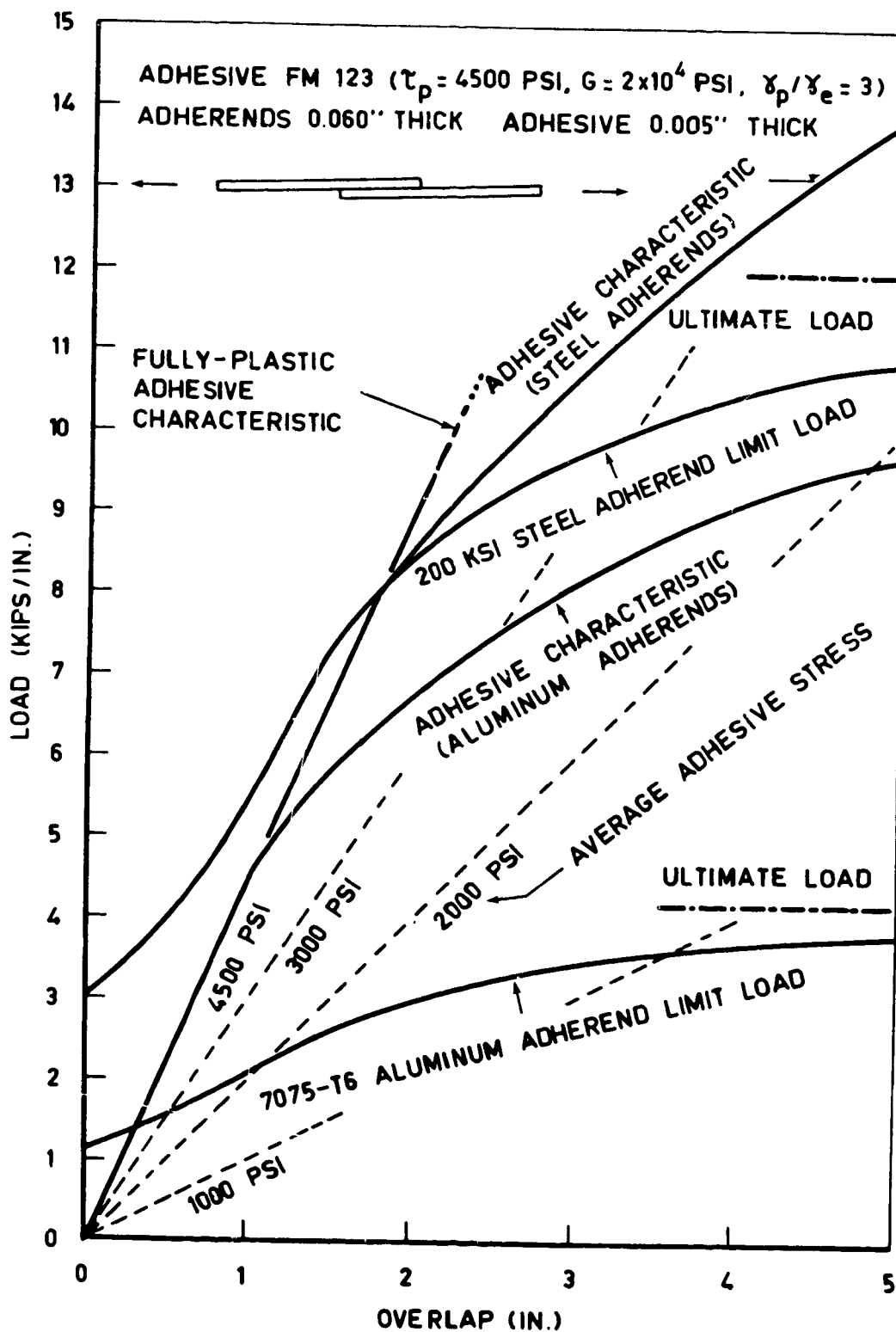

FIGURE 33. INFLUENCE OF ADHEREND MATERIAL ON SINGLE-LAP BONDED JOINTS

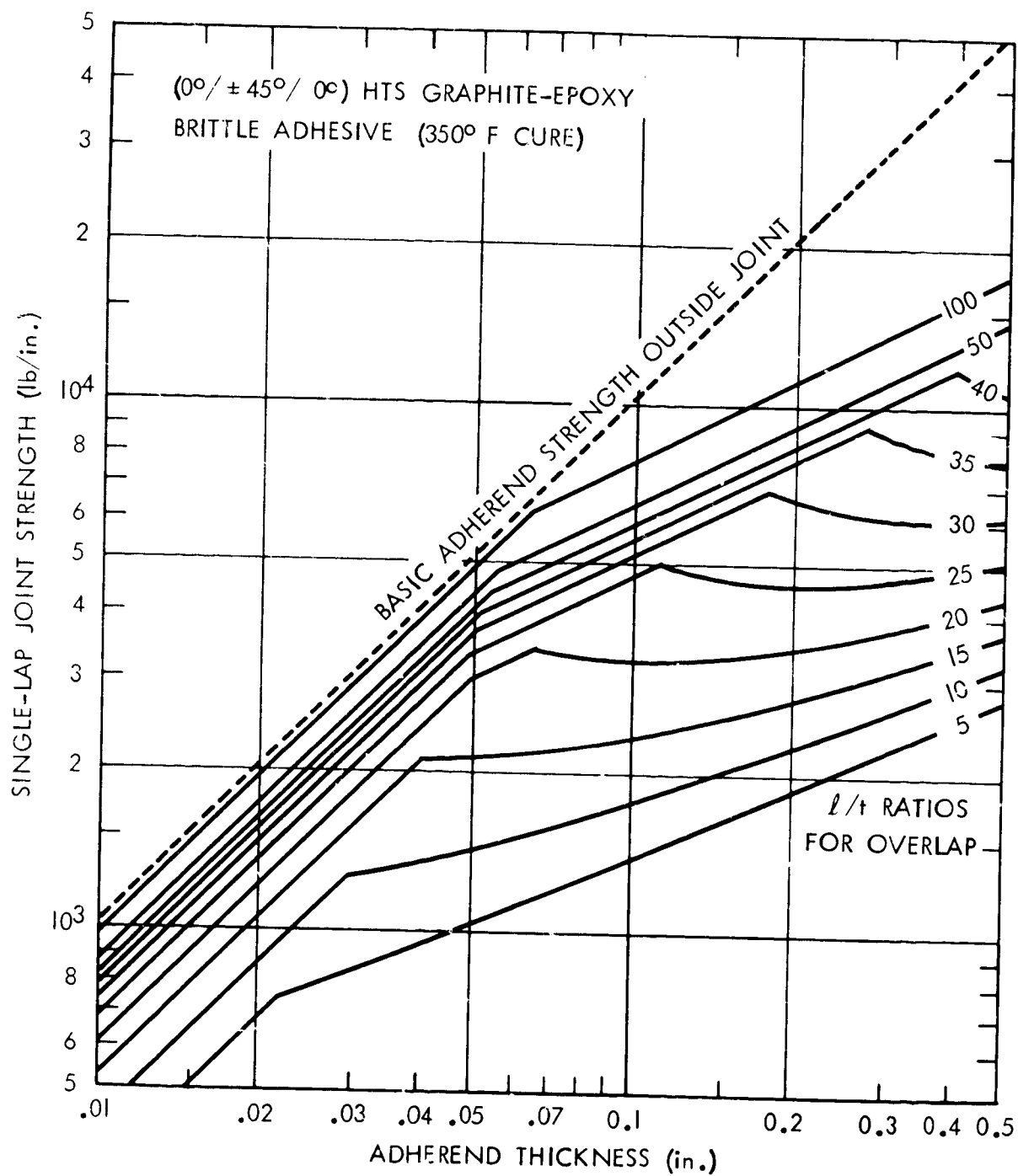

FIGURE 34. JOINT STRENGTH OF COMPOSITE SINGLE-LAP ADHESIVE-BONDED JOINTS, SHOWING INTERACTION OF THREE FAILURE MODES

APPENDIX

Computer Program A4EA for Strengths of Single-Lap Adhesive-Bonded Joints

A Fortran IV digital computer program has been prepared and checked out for solving those equations in the body of the report pertaining to joints between identical adherends. Each of the three potential failure modes is analyzed and printed out separately. This permits the strength margins of the stronger modes to be evaluated with respect to the governing (weakest) failure mode. The complete listing follows, along with sample output pages. The format of the input data is discussed below.

While other computer programs were prepared for unbalanced single-lap joints also, these are not reported here because of the intolerably low efficiencies of unsupported single-lap joints in structural applications. For unbalanced joints the efficiencies are lower still. Sample solutions prepared from the unreported computer programs are included in the report and serve to illustrate the effect of adherend dissimilarity on the joint strength.

The input data necessary to operate the A4EA computer program is as follows:

CARD 1:

FORMAT (I2)

NICNT = Number of material combinations to be read in.

CARD 2:

FORMAT (5F10.1)

AKB = Bending stiffness parameter $D / \{Et^3/[12(1-\nu^2)]\}$.

This factor serves to uncouple the bending and extensional stiffnesses for filamentary composites and has the value unity for metals.

EYOUNG = Young's modulus for the adherend, in the in-plane direction of the applied load.

IGMAX = Ultimate (or allowable) maximum stress in adherend.

The values F_{tu} or F_{cu} are used, depending on the direction of application of the load.

POISSN = In-plane Poisson's ratio associated with Young's modulus above.

ETRNSV = Transverse tension modulus of adherends.

For filamentary composites, this differs significantly from the in-plane values (which are largely fiber-controlled) because of the proportionally greater influence of the matrix.

CARD 3:

FORMAT (6F12.4)

G = Shear modulus for adhesive film.

Use actual value for elastic solution and equivalent elastic value based on matching strain energy for elastic-plastic solutions.

GAMMAR = γ_p/γ_e = Ratio of plastic to equivalent elastic adhesive shear strains. Value of zero is set for elastic case because plastic strain is defined to exclude the initial elastic increment.

ETA = Adhesive layer thickness.

TAUMAX = Maximum (plastic) adhesive shear stress.

PEELSG = Limiting peel strength, being the weaker of the adhesive peel stress (under the constraint of the adjacent adherends) and the interlaminar tension strength of a laminated adherend.

EPEEL = Modulus of adhesive layer in peel (under the constraint of the adjacent adherends).

CARDS 4, 4A, 4B, etc.:

FORMAT (12F6.3)

THICKN = Thickness of adherend.

Program is presently set up to read 17 thicknesses and there are dependent do-loops set to the same number. Alterations are straightforward but the number appears in a variety of places other than just input, output, and dimension statements.

CARDS 5, 5A, 5B, etc.:

FORMAT (11F6.1)

OLOVTH = l/t ratio for joint.

Program is presently set to operate with 11 l/t ratios. Simple changes to program will be necessary to operate with a different number, just as for THICKN. Note, however, that an increase in the number of OLOVTH is limited by the page width, while THICKN is listed

vertically and not subjected to such a severe limit.

The output of program A4EA is presented in sets of six pages, the first three in terms of joint strength per unit width and the last three in terms of the corresponding joint efficiencies by dividing throughout by the basic adherend strength. The entries in the output tables are self explanatory and each failure mode is identified in the caption.

In the event that the joint strength is not limited by the adherend bending strength but rather by the adhesive shear or peel strength, an iterative technique is used to adjust the load downwards in order to compute the actual bending moment at the end of the overlap instead of the maximum of which the adherends are capable. This refinement increases the predicted failure load which is, in all cases, critically dependent upon the estimate of the bending moment M_0 .

The iteration sequences established in this program have been demonstrated to be convergent. Other possible re-arrangements of the equations do not lead to convergent sequences, so re-arrangement of the computational equations is not recommended. The input and output format and/or the units employed may be modified readily by the user to suit his specific requirements.

```

C DECK A4FA
C SINGLE-LAP ADHESIVE-BONDED JOINTS
C JOINT EFFICIENCY COMPUTATIONS
C DIMENSIONAL SOLUTION FOR BALANCED ADHERENDS
C PLASTIC HINGE FORMATION (OR FRACTURE) OF ADHERENDS INCLUDED
C POTENTIAL BOND SHEAR STRENGTH ACCOUNTED FOR FOR SHORT OVERLAPS
C SHEAR STRENGTH USUALLY EXCEEDS PEEL STRENGTH FOR LONG OVERLAPS
C PEEL STRESS (OR INTERLAMINAR TENSION) FAILURES INCLUDED
C DIMENSION THICKN(17), OLVTH(11), STRGTH(17,11), STRBND(17,11),
  1 STORPL(17,11), EFFNCY(11), EFFRND(17,11), EFFPL(17,11),
  2 STORF(11), LOVTH(11), BNDSTR(17,11), BNDFFF(17,11), EKBNDG(11)
C DOUBLE PRECISION XIL2, V2R
C READ IN DATA
C READ IN ADHEREND AND ADHESIVE PROPERTIES
  READ (5,10) N1CNT
  10 FORMAT (I2)
C N1CNT .EQ. NUMBER OF INPUT DATA SETS TO BE READ IN
  DO 660 N2CNT = 1, N1CNT
  20 READ (5,20) AKR, EYOUNG, SIGMAX, POISSN, ETRNSV
  30 FORMAT (5F10.1)
  40 READ (5,30) G, GAMMAR, ETA, TAUMAX, PEELSG, EPFEL
  50 FORMAT (6F12.4)
  IF (N2CNT .GT. 1) GO TO 70
C READ IN ADHEREND THICKNESS ARRAY
  60 READ (5,40) (THICKN(I), I = 1, 17)
  70 FORMAT (12F6.3)
C READ IN OVERLAP TO THICKNESS RATIO ARRAY
  80 READ (5,50) (OLVTH(J), J = 1, 11)
  90 FORMAT (11F6.1)
C PRESET BOND SHEAR STRENGTH AND EFFICIENCY ARRAYS
  DO 60 I = 1, 17
  DO 60 J = 1, 11
  BNDSTR(I,J) = 1000000.
  BNDFFF(I,J) = 100.
  60 CONTINUE
C
C START COMPUTATIONS OF JOINT STRENGTHS
C SET CONSTANTS
  70 V2 = 1. - POISSN**2
  NFLAG = 0
  N3CNT = 0
  V23 = 2. * GAMMAR
  PRCPNL = 3. * SIGMAX * V2 / (EYOUNG * AKR)
C ADHEREND BENDING EFFICIENCY DEPENDS UPON L/T ONLY AND NOT T SEPARATELY
C SET INITIAL ESTIMATE (LOWER BOUND) ON JOINT EFFICIENCY
  V3 = 0.25
  DO 100 J = 1, 11
  OLVTH(J) = OLVTH(J)
  OLVTH2 = OLVTH(J)**2
  DO 80 N = 1, 500
  XIL2 = V3 * OLVTH2 * PRCPNL
  C EVALUATE ECCENTRICITY PARAMETER
  EK = 1. / (1. + DSQRT(XIL2) + XIL2/6.)
  V4 = 1. / (1. + 3. * EK)
  R = V3 / V4
  IF ( (1.0001 .GT. R) .AND. (0.9999 .LT. R) ) GO TO 90
  80 CONTINUE
  90 STOP IF NLOOP FAILS TO CONVERGE
  GO TO 690
C STORE JOINT EFFICIENCY IN BENDING PLUS TENSION OF ADHEREND
  90 EFFNCY(J) = V3
  EKBNDG(J) = EK
  100 CONTINUE
C SELECT JOINT GEOMETRY BY NESTED DO LOOPS
  DO 320 I = 1, 17
  T = THICKN(I)
  STR = SIGMAX * T
  C ESTABLISH OVERLAP NON-DIMENSIONALIZING PARAMETER FOR ADHESIVE SHEAR
  ALAMDA = SQRT (2. * G / (EYOUNG * T * ETA) )
  C COMPUTE EFFECTIVE TRANSVERSE TENSION MODULUS OF ADHESIVE IN JOINT
  C THE CONSTANT 6 IN THE FOLLOWING INSTRUCTION CORRESPONDS WITH THE PEEL
  C 1 STRESSES AFFECTING THE ADHERENDS TO A DEPTH OF THREE TIMES
  C 2 THE BONDLINE THICKNESS. OR ONE TIME, USE 2, ETC.
  ECPRM = 1. / ( (1. / EPFEL) + (6. / ETRNSV) )
  V1 = SQRT (3. * ECPRM * V2 * T / (2. * AKR * EYOUNG * ETA) )
  DO 320 J = 1, 11
  OLVTH2 = OLVTH(J)**2
  OLAP = T * OLVTH(J)
  C COMPUTE ADHEREND TENSION PLUS BENDING STRENGTH
  V5 = EFFNCY(J) * STR
  STRGTH(I,J) = V5
  EK = EKBNDG(J)
  C COMPUTE ADHESIVE SHEAR STRESS CUT-OFF FOR SHORT OVERLAPS
  OLAPND = SQRT (8. * GAMMAR / (1. + 3. * EK * V2 / AKR) )
  OLREF = OLAPND / ALAMDA
  V11 = OLREF
  IF (OLREF .GE. OLAP) OLREF = OLAP
    
```

A4EA0010
 A4EA0020
 A4EA0030
 A4EA0040
 A4EA0050
 A4EA0060
 A4EA0070
 A4EA0080
 A4EA0090
 A4EA0100
 A4EA0110
 A4EA0120
 A4EA0130
 A4EA0140
 A4EA0150
 A4EA0160
 A4EA0170
 A4EA0180
 A4EA0190
 A4EA0200
 A4EA0210
 A4EA0220
 A4EA0230
 A4EA0240
 A4EA0250
 A4EA0260
 A4EA0270
 A4EA0280
 A4EA0290
 A4EA0300
 A4EA0310
 A4EA0320
 A4EA0330
 A4EA0340
 A4EA0350
 A4EA0360
 A4EA0370
 A4EA0380
 A4EA0390
 A4EA0400
 A4EA0410
 A4EA0420
 A4EA0430
 A4EA0440
 A4EA0450
 A4EA0460
 A4EA0470
 A4EA0480
 A4EA0490
 A4EA0500
 A4EA0510
 A4EA0520
 A4EA0530
 A4EA0540
 A4EA0550
 A4EA0560
 A4EA0570
 A4EA0580
 A4EA0590
 A4EA0600
 A4EA0610
 A4EA0620
 A4EA0630
 A4EA0640
 A4EA0650
 A4EA0660
 A4EA0670
 A4EA0680
 A4EA0690
 A4EA0700
 A4EA0710
 A4EA0720
 A4EA0730
 A4EA0740
 A4EA0750
 A4EA0760
 A4EA0770
 A4EA0780
 A4EA0790
 A4EA0800
 A4EA0810
 A4EA0820
 A4EA0830
 A4EA0840
 A4EA0850
 A4EA0860
 A4EA0870
 A4EA0880

```

        STRBND(I,J) = TAUMAX * DLDEF
        EFFBND(I,J) = STRBND(I,J) / STP
    C COMPUTE PEEL STRESS CUT-OFF
        V7 = T * PEELSG / V1
        VR = V7 / EK
        IF (V5 .GT. V5) GO TO 120
    C REDUCE LOAD DUE TO LIMITING PEEL STRENGTH
        V9 = PROPNL / V5
        V3 = VR / STR
        DO 110 N = 1, 500
        V10 = VR * V9
        XIL2 = V3 * DLQVT2 * V10
        FK = 1. / (1. + DSQRT(XIL2) + XIL2/6.)
        V4 = 1. / (1. + 3.*FK)
        R = V3 / V4
        IF ( (1.0001 .GT. R) .AND. (0.9999 .LT. R) ) GO TO 120
        V3 = V4
        VR = V7 / FK
    110 CONTINUE
    C STOP IF NLOOP FAILS TO CONVERGE
        GO TO 600
    C STORE COMPUTED PEEL STRENGTH AND EFFICIENCY LIMITED BY PEEL
    120 STRGPL(I,J) = VR
        EFFPL(I,J) = VR / STR
        C1 = STRBND(I,J)
        C2 = 1.5 * STRGTH(I,J)
        C3 = 1.5 * STRGPL(I,J)
        IF (C1 .GT. C2) GO TO 320
        IF (C1 .GT. C3) GO TO 320
    C IF NOT, BOND STRENGTH MAY LIMIT LOAD CAPACITY
        STI = STRBND(I,J)
        IF (V11 .GE. DLAP) GO TO 320
    C IF SO, BOND STRENGTH LIMITED BY SHORT OVERLAP
    C CONVERGENCE PROBLEMS IN ITERATION LOOPS BELOW
    1 IF V11 ONLY JUST .LT. DLAP
        C4 = 0.09 * DLAP
        IF (V11 .GE. C4) GO TO 320
        IF (GAMMAR)710,130,170
    C IDENTIFY THAT PRECISE COMPUTATIONS OF SHEAR STRENGTH ARE TO BE DONE
    130 NFLAG = 1
    C SPECIAL PROCEDURE FOR PURELY ELASTIC ADHESIVE
    C SET INITIAL ESTIMATE ON ECCENTRICITY FACTOR
    C EK MAY HAVE TO BE INCREASED AS LOAD IS REDUCED
        V12 = EK
    C NON-DIMENSIONALIZE JOINT PARAMETERS
        DLSC = ALAMDA * DLAP
        V21 = (DLSC / TANH(DLSC) - 1.) / (1. + 3.*V2/AKB)
        ECCNTY = TAUMAX / ((AKR*EYOUNG*(T**3)/(12.*V2))*4.*(ALAMDA**3))
        V22 = DLSC * DLSC * ECCNTY
    C START ITERATING, USING N AS COUNTER
        DO 150 N = 1, 500
    C COMPUTE NON-DIMENSIONALIZED STRENGTH
        STF = DLSC / (1. + (1. + 3.*V12/AKB)*V21)
    C BYPASS CONVERGENCE CHECK FOR FIRST TEN ITERATIONS
        IF (N .LT. 10) GO TO 140
    C CHECK FOR CONVERGENCE
        R = STF / STI
        IF ( (1.0001 .GT. R) .AND. (0.9999 .LT. R) ) GO TO 160
    140 XIL2 = STF * V22
        V12 = 1. / (1. + DSQRT(XIL2) + XIL2/6.)
        STI = STF
    150 CONTINUE
    C STOP IF NLOOP FAILS TO CONVERGE
        GO TO 600
    C RE-DIMENSIONALIZE COMPUTATIONS
    160 V14 = STF * TAUMAX / ALAMDA
        RNDSTR(I,J) = V14
        BNDEFF(I,J) = V14 / STR
    C END OF COMPUTATIONS FOR THIS VARIABLE SET
        GO TO 320
    C IDENTIFY THAT PRECISE COMPUTATIONS OF SHEAR STRENGTH ARE TO BE DONE
    170 NFLAG = 1
    C GENERAL PROCEDURE FOR ELASTIC-PLASTIC ADHESIVE
    C NOTE THAT AKR IS SET EQUAL TO UNITY HERE, SINCE PROBLEM IS CONFINED
    C 1 TO THICKER LAMINATES OF MANY PLYS UNIFORMLY INTERSPERSED
    C SET INITIAL ESTIMATE ON ECCENTRICITY FACTOR
    C EK MAY HAVE TO BE INCREASED AS LOAD IS REDUCED
        V12 = EK
    C NON-DIMENSIONALIZE JOINT PARAMETERS
        DLSC = ALAMDA * DLAP
        ECCNTY = TAUMAX / ( (EYOUNG*(T**3)/(3.*V2))*(ALAMDA**3) )
        V22 = DLSC * DLSC * ECCNTY
        DO 300 N1 = 1, 500
        N3CNT = 1
        V26 = (1. + 3. * V2 * V12)
        VKL = V26 / 4.
        VKU = 1.
    C SET INITIAL ESTIMATES ON EXTENT OF ELASTIC TROUGH

```

A4FA0890
 A4FA0900
 A4FA0910
 A4FA0920
 A4FA0930
 A4FA0940
 A4FA0950
 A4FA0960
 A4FA0970
 A4FA0980
 A4FA0990
 A4FA1000
 A4FA1010
 A4FA1020
 A4FA1030
 A4FA1040
 A4FA1050
 A4FA1060
 A4FA1070
 A4FA1080
 A4FA1090
 A4FA1100
 A4FA1110
 A4FA1120
 A4FA1130
 A4FA1140
 A4FA1150
 A4FA1160
 A4FA1170
 A4FA1180
 A4FA1190
 A4FA1200
 A4FA1210
 A4FA1220
 A4FA1230
 A4FA1240
 A4FA1250
 A4FA1260
 A4FA1270
 A4FA1280
 A4FA1290
 A4FA1300
 A4FA1310
 A4FA1320
 A4FA1330
 A4FA1340
 A4FA1350
 A4FA1360
 A4FA1370
 A4FA1380
 A4FA1390
 A4FA1400
 A4FA1410
 A4FA1420
 A4FA1430
 A4FA1440
 A4FA1450
 A4FA1460
 A4FA1470
 A4FA1480
 A4FA1490
 A4FA1500
 A4FA1510
 A4FA1520
 A4FA1530
 A4FA1540
 A4FA1550
 A4FA1560
 A4FA1570
 A4FA1580
 A4FA1590
 A4FA1600
 A4FA1610
 A4FA1620
 A4FA1630
 A4FA1640
 A4FA1650
 A4FA1660
 A4FA1670
 A4FA1680
 A4FA1690
 A4FA1700
 A4FA1710
 A4FA1720
 A4FA1730
 A4FA1740
 A4FA1750
 A4FA1760

```

        DDSC = DLSC + 1 - SQRT(1. + V23)
        N3CNT = 2
        DO 190 N2 = 1, 500
        V24 = TANH(DDSC)
        V2R = V24 * V24 + V23
        V25 = DLSC + V24 - DSQRT(V2R)
    C BYPASS CONVERGENCE CHECK FOR FIRST TEN ITERATIONS
        IF (N2 .LT. 10) GO TO 180
    C CHECK ON CONVERGENCE
        R = V25 / DDSC
        IF ( (1.0001 .GT. R) .AND. (0.9999 .LT. R) ) GO TO 200
    190 DDSC = V25
        CONTINUE
    C STOP IF N2LOOP FAILS TO CONVERGE
        GO TO 690
    C EVALUATE DDSC AND VK THROUGH ITERATION OF TWO SIMULTANEOUS EQUATIONS
    200 N3CNT = 3
    C UPPER LIMIT ESTABLISHED FOR EXTENT OF ELASTIC TROUGH
        DDSCU = DDSC
        DDSC = DLSC + 1 - SQRT(1. + V23 / VKL)
        DO 220 N3 = 1, 500
        V24 = TANH(DDSC)
        V2R = V24 * V24 + V23 / VKL
        V25 = DLSC + V24 - DSQRT(V2R)
    C BYPASS CONVERGENCE CHECK FOR FIRST TEN ITERATIONS
        IF (N3 .LT. 10) GO TO 210
    C CHECK ON CONVERGENCE
        R = V25 / DDSC
        IF ( (1.0001 .GT. R) .AND. (0.9999 .LT. R) ) GO TO 230
    210 DDSC = V25
        CONTINUE
    C STOP IF N3LOOP FAILS TO CONVERGE
        GO TO 690
    230 N3CNT = 4
    C LOWER LIMIT ESTABLISHED FOR EXTENT OF ELASTIC TROUGH
        DDSCU = DDSC
        DDSC = DLSC + 1 - SQRT(1. + V23 / VKL)
        DO 270 N4 = 1, 5000
    C NOTE THAT 5000 ITERATIONS MAY BE NECESSARY IN THIS LOOP TO OBTAIN
    C 1 FOUR-FIGURE ACCURACY
        DDSCI = DDSCU - (DDSCU - DDSCU) / 10.
        V24 = TANH(DDSCI)
        VK = V23 / ( (DLSC - DDSCI + V24)**2 - (V24 * V24) )
        DDSCF = V24 + SQRT(V24 * V24 + V23 / VK) *
        1 ( (4. * VK / V26) - 1. ) / (1. - VK)
    C BYPASS CONVERGENCE CHECK FOR FIRST TEN ITERATIONS
        IF (N4 .LT. 10) GO TO 240
    C CHECK ON CONVERGENCE
        R = DDSCF / DDSCI
        IF ( (1.001 .GT. R) .AND. (0.999 .LT. R) ) GO TO 280
    C NOTE THAT WITH NESTED ITERATION LOOPS, FIVE-FIGURE ACCURACY IS NOT
    C 1 OBTAINABLE WITHIN A REALISTIC NUMBER OF ITERATIONS
    C RE-ESTIMATE DDSCU AND DDSCU
    240 V27 = DDSCF - DDSCI
        IF (V27) 250, 290, 260
    250 DDSCU = DDSCI
        GO TO 270
    260 DDSCU = DDSCI
        CONTINUE
    C STOP IF N4LOOP FAILS TO CONVERGE
        GO TO 690
    C CONVERGENCE ESTABLISHED FOR DDSC AND VK
    C COMPUTE ASSOCIATED JOINT STRENGTH
    290 V28 = V24 * V24 + V23 / VK
        STF = (4. * VK / V26) * DSQRT(V28)
    C BYPASS CONVERGENCE CHECK FOR FIRST TEN ITERATIONS
        IF (N1 .LT. 10) GO TO 290
    C CHECK FOR CONVERGENCE OF JOINT STRENGTHS
        R = STF / STI
        IF ( (1.001 .GT. R) .AND. (0.999 .LT. R) ) GO TO 310
    C IF NOT, RECOMPUTE FK AND ITERATE
    290 XIL2 = STF * V22
        V12 = 1. / (1. + DSQRT(XIL2) + XIL2/6.)
        STI = (STI + STF) / 2.
    300 CONTINUE
    C STOP IF N1LOOP FAILS TO CONVERGE
        GO TO 690
    C STORE COMPUTED STRENGTH AND EFFICIENCY AFTER CONVERGENCE ESTABLISHED
    310 V33 = STF * YAU MAX / ALAMDA
        RNDSTR(I, J) = V33
        RNDEFF(I, J) = V33 / STF
    320 CONTINUE
    C PRINT OUT TABULATIONS OF COMPUTATIONS IN SETS OF SIX OR EIGHT PAGES
        WRITE (6, 330) (LOVTH(J), J = 1, 11)
    330 FORMAT (1H1, 10(I), 3X, 3H SINGLE-LAP ADHESIVE-BONDED JOINTS//
        1 46X, 1H BALANCED ADHERENDS//
        2 32X, 4H ADHEREND STRENGTH IN BENDING AT EDGE OF OVERLAP///
        3 41X, 3H JOINT STRENGTH (POUNDS PER INCH WIDTH)//
    
```

A4FA1770
 A4EA1780
 A4FA1790
 A4EA1800
 A4FA1810
 A4EA1820
 A4FA1830
 A4EA1840
 A4FA1850
 A4EA1860
 A4FA1870
 A4EA1880
 A4FA1890
 A4EA1900
 A4FA1910
 A4EA1920
 A4FA1930
 A4EA1940
 A4FA1950
 A4EA1960
 A4FA1970
 A4EA1980
 A4FA1990
 A4EA2000
 A4FA2010
 A4EA2020
 A4FA2030
 A4EA2040
 A4FA2050
 A4EA2060
 A4FA2070
 A4EA2080
 A4FA2090
 A4EA2100
 A4FA2110
 A4EA2120
 A4FA2130
 A4EA2140
 A4FA2150
 A4EA2160
 A4FA2170
 A4EA2180
 A4FA2190
 A4EA2200
 A4FA2210
 A4EA2220
 A4FA2230
 A4EA2240
 A4FA2250
 A4EA2260
 A4FA2270
 A4EA2280
 A4FA2290
 A4EA2300
 A4FA2310
 A4EA2320
 A4FA2330
 A4EA2340
 A4FA2350
 A4EA2360
 A4FA2370
 A4EA2380
 A4FA2390
 A4EA2400
 A4FA2410
 A4EA2420
 A4FA2430
 A4EA2440
 A4FA2450
 A4EA2460
 A4FA2470
 A4EA2480
 A4FA2490
 A4EA2500
 A4FA2510
 A4EA2520
 A4FA2530
 A4EA2540
 A4FA2550
 A4EA2560
 A4FA2570
 A4EA2580
 A4FA2590
 A4EA2600
 A4FA2610
 A4EA2620
 A4FA2630
 A4EA2640

```

4 1X, 9HTHICKNESS/, 1X, 9H(INCHES),
5 37X, 26HOVERLAP TO THICKNESS RATIO//, 9X, 11(I7, 2X)//
DO 360 I = 1, 17
DO 340 J = 1, 11
340 STORE(J) = STRGTH(I,J)
WRITE (6,350) THICKN(I), (STORE(J), J = 1, 11)
350 FORMAT (1H, F5.3, 4X, 11(F8.1, 1X) )
360 CONTINUE
WRITE (6,370) (LOVTH(J), J = 1, 11)
370 FORMAT (1H1, 10(/), 39X, 33HSINGLE-LAP ADHESIVE-BONDED JOINTS//
1 46X, 18HBALANCED ADHERENDS//
2 39X, 33HPOTENTIAL ADHESIVE SHEAR STRENGTH///
3 41X, 38HJOINT STRENGTH (POUNDS PER INCH WIDTH)//
4 1X, 9HTHICKNESS/, 1X, 8H(INCHES),
5 37X, 26HOVERLAP TO THICKNESS RATIO//, 9X, 11(I7, 2X)//
DO 400 I = 1, 17
DO 380 J = 1, 11
380 STORE(J) = STRBND(I,J)
WRITE (6,390) THICKN(I), (STORE(J), J = 1, 11)
390 FORMAT (1H, F5.3, 4X, 11(F8.1, 1X) )
400 CONTINUE
IF (NFLAG.EQ. 0) GO TO 450
WRITE (6,410) (LOVTH(J), J = 1, 11)
410 FORMAT (1H1, 10(/), 39X, 33HSINGLE-LAP ADHESIVE-BONDED JOINTS//
1 46X, 18HBALANCED ADHERENDS//
2 39X, 33HPOTENTIAL ADHESIVE SHEAR STRENGTH///
3 41X, 38HJOINT STRENGTH (POUNDS PER INCH WIDTH)//
4 1X, 9HTHICKNESS/, 1X, 8H(INCHES),
5 37X, 26HOVERLAP TO THICKNESS RATIO//, 9X, 11(I7, 2X)//
DO 440 I = 1, 17
DO 420 J = 1, 11
420 STORE(J) = BNDSTR(I,J)
WRITE (6,430) THICKN(I), (STORE(J), J = 1, 11)
430 FORMAT (1H, F5.3, 4X, 11(F8.1, 1X) )
440 CONTINUE
WRITE (6,460) (LOVTH(J), J = 1, 11)
460 FORMAT (1H1, 10(/), 39X, 33HSINGLE-LAP ADHESIVE-BONDED JOINTS//
1 46X, 18HBALANCED ADHERENDS//
2 44X, 22HLIMITING PFEL STRENGTH///
3 41X, 38HJOINT STRENGTH (POUNDS PER INCH WIDTH)//
4 1X, 9HTHICKNESS/, 1X, 8H(INCHES),
5 37X, 26HOVERLAP TO THICKNESS RATIO//, 9X, 11(I7, 2X)//
DO 490 I = 1, 17
DO 470 J = 1, 11
470 STORE(J) = STRGPL(I,J)
WRITE (6,480) THICKN(I), (STORE(J), J = 1, 11)
480 FORMAT (1H, F5.3, 4X, 11(F8.1, 1X) )
490 CONTINUE
WRITE (6,500) (LOVTH(J), J = 1, 11)
500 FORMAT (1H1, 10(/), 39X, 33HSINGLE-LAP ADHESIVE-BONDED JOINTS//
1 46X, 18HBALANCED ADHERENDS//
2 32X, 47HADHEREND STRENGTH IN BENDING AT EDGE OF OVERLAP///
3 52X, 16HJOINT EFFICIENCY//
4 1X, 9HTHICKNESS/, 1X, 8H(INCHES),
5 37X, 26HOVERLAP TO THICKNESS RATIO//, 9X, 11(I7, 2X)//
DO 520 I = 1, 17
WRITE (6,510) THICKN(I), (EFFNCY(J), J = 1, 11)
510 FORMAT (1H, F5.3, 4X, 11(F8.5, 1X) )
520 CONTINUE
WRITE (6,530) (LOVTH(J), J = 1, 11)
530 FORMAT (1H1, 10(/), 39X, 33HSINGLE-LAP ADHESIVE-BONDED JOINTS//
1 46X, 18HBALANCED ADHERENDS//
2 39X, 33HPOTENTIAL ADHESIVE SHEAR STRENGTH///
3 52X, 16HJOINT EFFICIENCY//
4 1X, 9HTHICKNESS/, 1X, 8H(INCHES),
5 37X, 26HOVERLAP TO THICKNESS RATIO//, 9X, 11(I7, 2X)//
DO 560 I = 1, 17
DO 540 J = 1, 11
540 STORE(J) = EFFBND(I,J)
WRITE (6,550) THICKN(I), (STORE(J), J = 1, 11)
550 FORMAT (1H, F5.3, 4X, 11(F8.5, 1X) )
560 CONTINUE
IF (NFLAG.EQ. 0) GO TO 610
WRITE (6,570) (LOVTH(J), J = 1, 11)
570 FORMAT (1H1, 10(/), 39X, 33HSINGLE-LAP ADHESIVE-BONDED JOINTS//
1 46X, 18HBALANCED ADHERENDS//
2 39X, 33HPOTENTIAL ADHESIVE SHEAR STRENGTH///
3 52X, 16HJOINT EFFICIENCY//
4 1X, 9HTHICKNESS/, 1X, 8H(INCHES),
5 37X, 26HOVERLAP TO THICKNESS RATIO//, 9X, 11(I7, 2X)//
DO 600 I = 1, 17
DO 580 J = 1, 11
580 STORE(J) = BNDEFF(I,J)
WRITE (6,590) THICKN(I), (STORE(J), J = 1, 11)
590 FORMAT (1H, F5.3, 4X, 11(F8.5, 1X) )
600 CONTINUE
610 WRITE (6,620) (LOVTH(J), J = 1, 11)
620 FORMAT (1H1, 10(/), 39X, 33HSINGLE-LAP ADHESIVE-BONDED JOINTS//

```

A4EA2650
A4EA2660
A4EA2670
A4EA2680
A4EA2690
A4EA2700
A4EA2710
A4EA2720
A4EA2730
A4EA2740
A4EA2750
A4EA2760
A4EA2770
A4EA2780
A4EA2790
A4EA2800
A4EA2810
A4EA2820
A4EA2830
A4EA2840
A4EA2850
A4EA2860
A4EA2870
A4EA2880
A4EA2890
A4EA2900
A4EA2910
A4EA2920
A4EA2930
A4EA2940
A4EA2950
A4EA2960
A4EA2970
A4EA2980
A4EA2990
A4EA3000
A4EA3010
A4EA3020
A4EA3030
A4EA3040
A4EA3050
A4EA3060
A4EA3070
A4EA3080
A4EA3090
A4EA3100
A4EA3110
A4EA3120
A4EA3130
A4EA3140
A4EA3150
A4EA3160
A4EA3170
A4EA3180
A4EA3190
A4EA3200
A4EA3210
A4EA3220
A4EA3230
A4EA3240
A4EA3250
A4EA3260
A4EA3270
A4EA3280
A4EA3290
A4EA3300
A4EA3310
A4EA3320
A4EA3330
A4EA3340
A4EA3350
A4EA3360
A4EA3370
A4EA3380
A4EA3390
A4EA3400
A4EA3410
A4EA3420
A4EA3430
A4EA3440
A4EA3450
A4EA3460
A4EA3470
A4EA3480
A4EA3490
A4EA3500
A4EA3510
A4EA3520

1	46X, 18H BALANCED ADHERENDS//	A4EA3530
2	44X, 22H LIMITING PEEL STRENGTH//	A4EA3540
3	52X, 18H JOINT EFFICIENCY/	A4EA3550
4	1X, 9H THICKNESS/, 1X, 8H (INCHES),	A4EA3560
5	37X, 26H OVERLAP TO THICKNESS RATIO//, 9X, 11 (17, 2X)//	A4EA3570
	00 650 I = 1, 17	A4EA3580
	00 630 J = 1, 11	A4EA3590
630	STORE(J) = FFFPL(I,J)	A4EA3600
	WRITE (6,640) THICKN(I), (STORE(J), J = 1, 11)	A4EA3610
640	FORMAT (1H, F5.3, 4X, 11(FR.5, 1X))	A4EA3620
650	CONTINUE	A4EA3630
C	READ IN NEW MATERIAL ALLOWABLES AND REPEAT COMPUTATIONS	A4EA3640
660	CONTINUE	A4EA3650
670	WRITE (6,690)	A4EA3660
680	FORMAT (1H1, 17H PROGRAM COMPLETED//)	A4EA3670
	STOP	A4EA3680
C	PRINT OUT DIAGNOSTICS	A4EA3690
690	WRITE (6,700) N3CNT, I, J	A4EA3700
700	FORMAT (1H1, 19H DIVERGENT ITERATION, 3110//)	A4EA3710
	STOP	A4EA3720
710	WRITE (6,720)	A4EA3730
720	FORMAT (1H1, 59H NEGATIVE GAMMA VALUE IN INPUT DATA - PHYSICALLY IMPOSSIBLE//)	A4EA3740
	STOP	A4EA3750
	END	A4EA3760
		A4EA3770
		A4EA3780

SINGLE-LAP ADHESIVE-BONDED JOINTS
 BALANCED ADHERENDS
 ADHEREND STRENGTH IN BENDING AT EDGE OF OVERLAP

THICKNESS (INCHES)	JOINT STRENGTH (POUNDS PER INCH WIDTH)										
	OVERLAP TO THICKNESS RATIO										
	5	10	15	20	25	30	35	40	45	50	100
0.010	137.7	165.6	195.0	223.9	251.0	275.3	296.6	315.0	330.8	344.2	409.3
0.015	206.5	248.5	292.5	335.9	376.4	413.0	444.9	472.5	496.7	516.3	614.0
0.020	275.3	331.3	390.0	447.8	501.9	550.6	593.2	630.0	658.4	688.4	818.6
0.030	413.0	496.9	585.0	671.7	752.9	825.9	889.8	945.1	992.3	1032.6	1227.9
0.040	550.6	662.6	783.0	905.6	1003.9	1101.2	1186.5	1260.1	1323.1	1376.9	1637.2
0.060	825.9	993.9	1169.9	1343.4	1505.8	1651.9	1779.7	1890.1	1984.6	2065.3	2455.8
0.080	1101.2	1325.2	1559.9	1791.2	2007.7	2202.5	2372.9	2520.2	2646.2	2753.7	3274.6
0.100	1376.9	1656.5	1949.9	2239.1	2509.6	2753.1	2966.2	3150.2	3307.7	3442.1	4093.0
0.150	1789.5	2153.4	2534.9	2913.8	3262.5	3579.0	3856.0	4095.3	4300.0	4474.8	5321.0
0.200	2202.5	2650.3	3119.8	3582.4	4015.4	4404.9	4745.9	5040.4	5292.4	5507.4	6548.9
0.250	2753.1	3312.9	3899.7	4478.0	5019.2	5506.2	5932.3	6300.4	6615.5	6884.3	8186.1
0.300	3441.4	4141.1	4874.7	5597.4	6273.9	6882.6	7415.4	7875.6	8269.3	8605.3	10232.6
0.400	4129.7	4969.3	5849.6	6716.9	7528.6	8259.0	8899.1	9450.7	9923.2	10326.4	12279.1
0.500	4817.9	5794.1	6824.5	7836.3	8783.3	9659.6	10392.2	11025.8	11577.0	12047.5	14325.7
0.600	5506.2	6626.4	7799.4	8955.7	10037.9	11011.8	11882.2	12600.3	13230.9	13768.9	16372.2
0.800	6194.5	7454.7	8774.3	10075.2	11292.6	12388.1	13348.3	14176.5	14884.8	15489.6	18418.2
1.000	6882.8	8293.0	9749.2	11194.6	12547.3	13764.5	14831.3	15751.6	16538.2	17210.7	20465.2

SINGLE-LAP ADHESIVE-BONDED JOINTS
 BALANCED ADHERENDS
 POTENTIAL ADHESIVE SHEAR STRENGTH

THICKNESS (INCHES)	JOINT STRENGTH (POUNDS PER INCH WIDTH)										
	OVERLAP TO THICKNESS RATIO										
	5	10	15	20	25	30	35	40	45	50	100
0.010	*****	*****	*****	1297.4	1459.7	1592.0	1702.8	1794.8	1871.9	1937.0	2265.9
0.015	*****	*****	*****	1663.9	1863.5	2032.6	2167.2	2278.6	2370.7	2443.6	2829.8
0.020	*****	*****	*****	1974.4	2208.3	2398.4	2554.1	2681.3	2787.4	2875.7	3303.4
0.030	*****	*****	*****	2475.5	2762.2	2996.5	3188.2	3345.0	3474.4	3561.5	4093.7
0.040	*****	*****	*****	2942.7	3213.7	3486.1	3739.1	3890.7	4040.8	4166.6	4755.4
0.060	*****	*****	*****	3533.9	3939.2	4275.7	4553.1	4730.1	4967.8	5124.4	5855.5
0.080	*****	*****	*****	4057.1	4524.2	4914.8	5238.5	5505.3	5725.9	5910.1	6773.5
0.100	*****	*****	*****	4500.7	5027.2	5454.8	5823.8	6125.5	6377.3	6588.0	7574.9
0.150	*****	*****	*****	5360.4	5950.1	6359.4	6756.4	7027.5	7220.7	7466.6	8628.8
0.200	*****	*****	*****	6123.9	6834.1	7201.1	7578.8	7819.3	7950.5	8229.8	9557.6
0.250	4110.4	4795.2	5340.3	5847.4	6290.0	6684.1	7031.6	7259.1	7420.8	7612.0	8857.9
0.300	4495.4	5279.9	5871.1	6371.1	6820.2	7166.6	7460.9	7619.3	7750.5	7912.0	9274.2
0.400	4947.1	5820.3	6427.8	6933.8	7350.7	7653.7	7861.1	8000.4	8075.5	8172.0	9611.5
0.500	5172.3	6141.4	6764.3	7299.3	7765.7	8044.0	8231.9	8350.2	8400.4	8475.5	9951.7
0.600	5476.4	6517.4	7159.6	7719.8	8159.9	8444.5	8631.9	8731.9	8756.2	8799.7	10315.9
0.800	5762.4	6932.8	7627.0	8203.0	8614.1	8845.4	9000.7	9066.4	9050.4	9043.2	10657.9
1.000											

SINGLE-LAP ADHESIVE-BONDED JOINTS
 BALANCED ADHERENDS
 LIMITING PEEL STRENGTH

THICKNESS (INCHES)	JOINT STRENGTH (POUNDS PER INCH WIDTH)										
	OVERLAP TO THICKNESS RATIO										
	5	10	15	20	25	30	35	40	45	50	100
0.010	427.2	524.7	741.2	943.0	1222.3	1527.7	1874.9	2262.6	2689.5	3154.2	9755.8
0.015	523.2	631.7	907.8	1175.7	1497.7	1871.0	2296.3	2771.2	3293.9	3863.1	11948.4
0.020	634.1	739.7	1043.2	1357.6	1728.6	2165.5	2651.5	3199.8	3803.5	4460.8	13796.8
0.030	739.9	773.1	1083.4	1392.0	1717.1	2046.1	2447.4	2919.0	3458.3	4063.3	16897.5
0.040	854.4	1129.5	1483.4	1827.0	2244.6	2644.7	3054.4	3479.4	4025.3	4574.9	19511.6
0.060	1046.4	1333.3	1815.5	2151.8	2644.6	3054.4	3479.4	4025.3	4574.9	5374.9	23896.7
0.080	1204.3	1507.3	2096.5	2515.3	3057.7	3479.4	4025.3	4574.9	5374.9	6309.3	27593.6
0.100	1346.7	1785.8	2343.9	3035.8	3665.7	4321.0	5033.0	5899.0	6393.7	7607.0	30930.5
0.150	1504.7	1994.0	2672.5	3461.3	4407.1	4901.2	5670.1	6158.1	7155.1	8504.8	35173.0
0.200	1644.7	2133.6	3069.6	3851.0	4499.2	6110.8	7499.6	9050.5	9697.0	11377.0	39123.0
0.250	1811.8	2322.5	3003.0	4121.9	5366.3	6933.1	8394.8	10118.4	10227.7	14106.2	43653.2
0.300	1997.7	2492.5	3167.2	4172.1	5901.6	7634.5	9174.5	11313.2	11447.3	15171.2	48774.0
0.400	2165.4	2869.8	3324.0	4268.5	5776.3	7367.6	10269.3	12333.0	12730.8	17276.5	53434.7
0.500	2319.2	3023.6	3472.1	4370.9	5741.0	7111.7	11092.1	13385.9	15911.1	14560.7	57716.0
0.600	2461.9	3071.1	3612.7	4473.3	5751.4	7053.6	11450.4	14310.2	17009.7	19949.2	61701.0
0.800	2595.7	3103.7	3746.4	4507.7	5733.3	7095.7	11336.5	15178.2	18041.5	21159.3	65443.8
1.000	2722.0	3240.8	3874.1	4695.7	5842.3	7603.9	10647.7	15999.3	19017.4	22303.9	68983.9

SINGLE-LAP ADHESIVE-BONDED JOINTS
 BALANCED ADHERENDS
 ADHEREND STRENGTH IN BENDING AT EDGE OF OVERLAP

THICKNESS (INCHES)	JOINT EFFICIENCY										
	OVERLAP TO THICKNESS RATIO										
	5	10	15	20	25	30	35	40	45	50	100
0.010	0.30590	0.36811	0.43331	0.49757	0.55770	0.61180	0.65915	0.70005	0.73505	0.76492	0.90957
0.015	0.30590	0.36811	0.43331	0.49757	0.55770	0.61180	0.65915	0.70005	0.73505	0.76492	0.90957
0.020	0.30590	0.36811	0.43331	0.49757	0.55770	0.61180	0.65915	0.70005	0.73505	0.76492	0.90957
0.030	0.30590	0.36811	0.43331	0.49757	0.55770	0.61180	0.65915	0.70005	0.73505	0.76492	0.90957
0.040	0.30590	0.36811	0.43331	0.49757	0.55770	0.61180	0.65915	0.70005	0.73505	0.76492	0.90957
0.060	0.30590	0.36811	0.43331	0.49757	0.55770	0.61180	0.65915	0.70005	0.73505	0.76492	0.90957
0.080	0.30590	0.36811	0.43331	0.49757	0.55770	0.61180	0.65915	0.70005	0.73505	0.76492	0.90957
0.100	0.30590	0.36811	0.43331	0.49757	0.55770	0.61180	0.65915	0.70005	0.73505	0.76492	0.90957
0.130	0.30590	0.36811	0.43331	0.49757	0.55770	0.61180	0.65915	0.70005	0.73505	0.76492	0.90957
0.160	0.30590	0.36811	0.43331	0.49757	0.55770	0.61180	0.65915	0.70005	0.73505	0.76492	0.90957
0.200	0.30590	0.36811	0.43331	0.49757	0.55770	0.61180	0.65915	0.70005	0.73505	0.76492	0.90957
0.250	0.30590	0.36811	0.43331	0.49757	0.55770	0.61180	0.65915	0.70005	0.73505	0.76492	0.90957
0.300	0.30590	0.36811	0.43331	0.49757	0.55770	0.61180	0.65915	0.70005	0.73505	0.76492	0.90957
0.350	0.30590	0.36811	0.43331	0.49757	0.55770	0.61180	0.65915	0.70005	0.73505	0.76492	0.90957
0.400	0.30590	0.36811	0.43331	0.49757	0.55770	0.61180	0.65915	0.70005	0.73505	0.76492	0.90957
0.450	0.30590	0.36811	0.43331	0.49757	0.55770	0.61180	0.65915	0.70005	0.73505	0.76492	0.90957
0.500	0.30590	0.36811	0.43331	0.49757	0.55770	0.61180	0.65915	0.70005	0.73505	0.76492	0.90957

SINGLE-LAP ADHESIVE-BONDED JOINTS
 BALANCED ADHERENDS
 POTENTIAL ADHESIVE SHEAR STRENGTH

THICKNESS (INCHES)	JOINT EFFICIENCY										
	OVERLAP TO THICKNESS RATIO										
	5	10	15	20	25	30	35	40	45	50	100
0.010	*****	*****	*****	2.84338	3.24153	3.53779	3.78390	3.98853	4.15977	4.30455	5.03533
0.015	*****	*****	*****	2.47239	2.75414	3.01121	3.21064	3.37570	3.51216	3.62758	4.19231
0.020	*****	*****	*****	2.19594	2.45364	2.66495	2.83793	2.97920	3.09708	3.19523	3.67050
0.030	*****	*****	*****	1.83441	2.04579	2.21952	2.36165	2.47773	2.57364	2.65295	3.03240
0.040	*****	*****	*****	1.60151	1.79541	1.93673	2.06059	2.16152	2.24438	2.31478	2.64188
0.060	*****	*****	*****	1.33484	1.45377	1.54359	1.68633	1.77042	1.83992	1.90791	2.16959
0.080	*****	*****	*****	1.12699	1.25573	1.36521	1.45513	1.52926	1.59054	1.64169	1.88152
0.100	*****	*****	*****	1.02115	1.15660	1.21307	1.29418	1.36123	1.41718	1.46401	1.68331
0.130	*****	*****	*****	0.86656	0.96636	1.05238	1.12415	1.18419	1.23431	1.27635	1.47501
0.160	*****	*****	*****	0.77209	0.85136	0.91332	0.98653	1.05384	1.11424	1.16809	1.34421
0.200	*****	*****	*****	0.64066	0.70534	0.75790	0.80623	0.85824	0.90424	0.94303	1.10745
0.250	0.36537	0.44611	0.50336	0.54911	0.58420	0.62910	0.67166	0.71810	0.75809	0.79175	0.93549
0.300	0.33279	0.40207	0.47193	0.51927	0.56123	0.60537	0.64338	0.68556	0.72107	0.75812	0.89511
0.350	0.31775	0.38694	0.45224	0.49306	0.52944	0.56900	0.60447	0.64283	0.67152	0.70120	0.83532
0.400	0.28735	0.35341	0.40046	0.45627	0.50400	0.54944	0.59632	0.63241	0.66355	0.69051	0.82585
0.450	0.27044	0.33135	0.37430	0.42567	0.47392	0.51775	0.55664	0.59072	0.62029	0.64541	0.77609
0.500	0.25411	0.30368	0.35231	0.40013	0.44525	0.48646	0.52325	0.55559	0.58379	0.60329	0.73398

SINGLE-LAP ADHESIVE-BONDED JOINTS
 BALANCED ADHERENDS
 LIMITING PEEL STRENGTH

THICKNESS (INCHES)	JOINT EFFICIENCY										
	OVERLAP TO THICKNESS RATIO										
	5	10	15	20	25	30	35	40	45	50	100
0.010	0.94933	1.29477	1.64713	2.13332	2.71522	3.39470	4.16645	5.02808	5.97659	7.00943	21.67953
0.015	0.77512	1.02467	1.28447	1.74185	2.21774	2.77192	3.40189	4.10541	4.87986	5.72317	17.70126
0.020	0.68077	0.89737	1.15666	1.52844	1.92066	2.40055	2.94612	3.55539	4.22609	4.95641	15.32574
0.030	0.54866	0.72495	0.95397	1.23167	1.56021	1.94024	2.40550	2.90236	3.45059	4.04649	12.51640
0.040	0.47466	0.62744	0.82356	1.06566	1.35911	1.69745	2.08323	2.51634	2.98829	3.50471	10.33977
0.060	0.38564	0.51377	0.67235	0.87544	1.11543	1.39546	1.70075	2.05275	2.43993	2.86158	8.85053
0.080	0.33564	0.44377	0.58235	0.75444	0.95543	1.20075	1.47306	1.77763	2.11304	2.47521	7.66448
0.100	0.29927	0.39045	0.50297	0.64622	0.82533	1.04158	1.31757	1.59002	1.89454	2.21658	6.85568
0.130	0.25722	0.33645	0.43244	0.54159	0.68114	0.87158	1.11557	1.39454	1.67615	1.95437	6.01243
0.160	0.22844	0.29644	0.39355	0.49333	0.60726	0.74472	0.94141	1.15722	1.36441	1.55716	5.41589
0.200	0.20131	0.25584	0.33367	0.42797	0.53717	0.65415	0.81165	0.99165	1.19174	1.27374	3.95412
0.250	0.17759	0.22158	0.28151	0.34147	0.42711	0.52194	0.63329	0.76067	0.90567	1.00177	4.33571
0.300	0.16044	0.19734	0.24622	0.30119	0.36721	0.44194	0.53329	0.64067	0.76190	0.80177	4.84770
0.350	0.14775	0.17727	0.22265	0.27752	0.33654	0.40554	0.48626	0.58490	0.69023	0.71841	3.66451
0.400	0.13677	0.16527	0.20071	0.24374	0.29152	0.34311	0.40641	0.48930	0.58499	0.60829	3.42734
0.450	0.12819	0.15157	0.18501	0.22655	0.27454	0.32304	0.38304	0.44954	0.52904	0.54490	3.23179
0.500	0.12099	0.14053	0.17218	0.20870	0.25066	0.29379	0.34732	0.40654	0.47104	0.48522	3.06595

END

DATE

FILMED

FEB 7 1974